

UC-NRLF

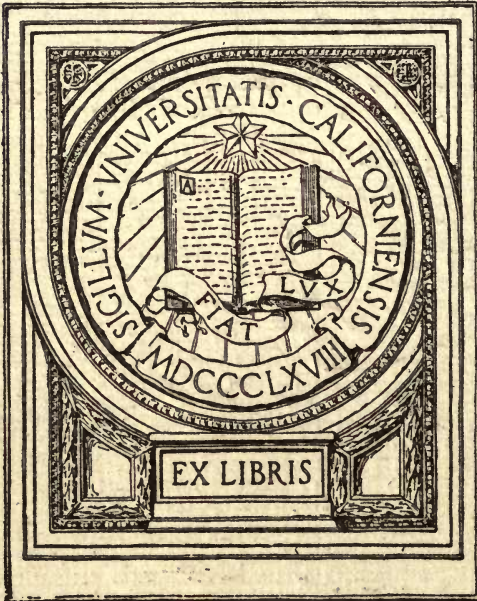

\$B 271 957



EX LIBRIS

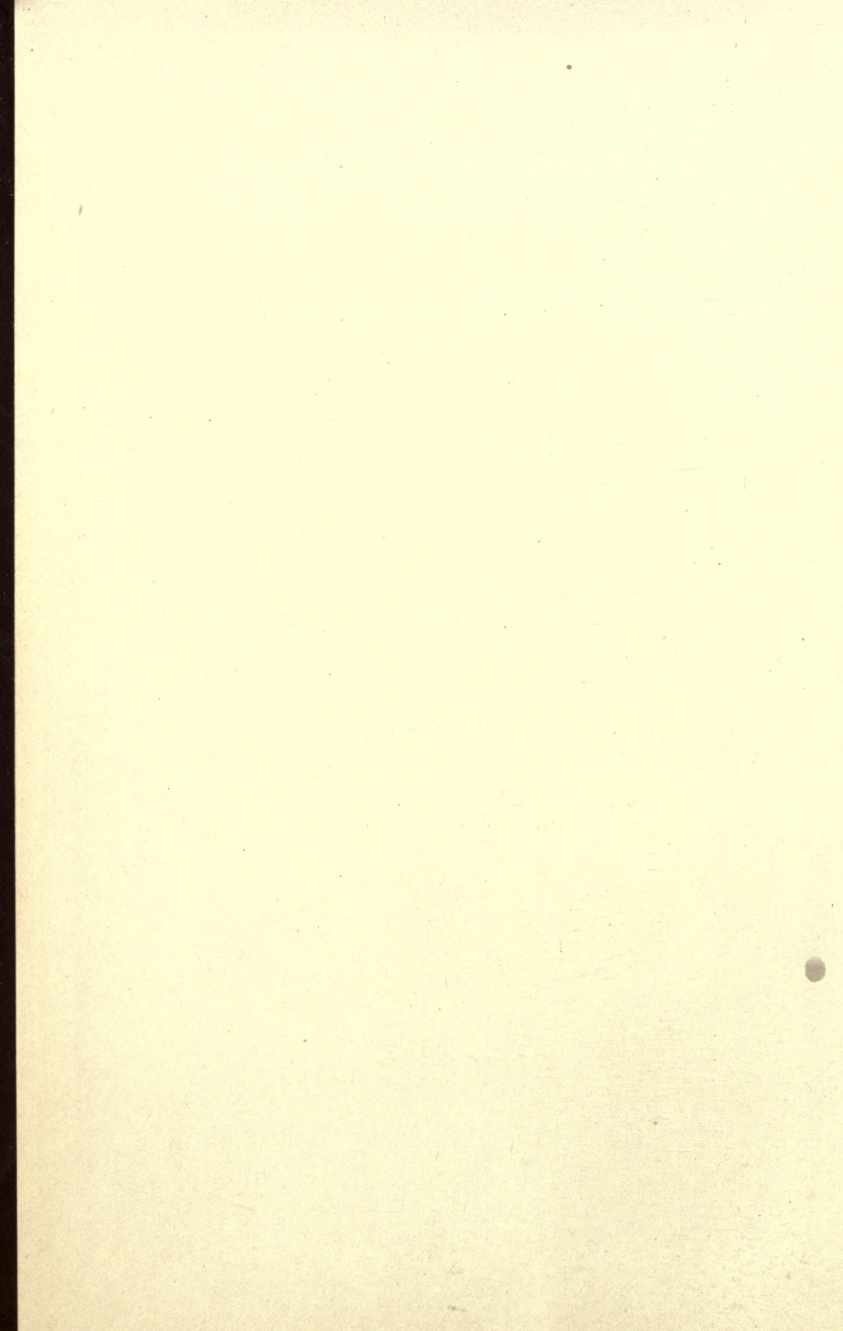



WORKS OF
PROFESSOR CECIL H. PEABODY

PUBLISHED BY

JOHN WILEY & SONS, Inc.

Thermodynamics of the Steam-engine and other Heat-engines.

This work is intended for the use of students in technical schools, and gives the theoretical training required by engineers. Sixth Edition, Revised. vii + 543 pages, 119 figures. 8vo, cloth, \$4.50, net.

Tables of the Properties of Steam and other Vapors, and Temperature-Entropy Table.

These tables were prepared for the use of students in technical schools and colleges and of engineers in general. Eighth Edition, Rewritten. 8vo, vi + 133 pages, cloth, \$1.00, net.

Valve-gears for Steam-engines.

This book is intended to give engineering students instruction in the theory and practice of designing valve-gears for steam-engines. Second Edition, Revised and Enlarged. 8vo, v + 142 pages, 33 folding-plates, cloth, \$2.25, net.

Manual of the Steam-engine Indicator.

154 pages, 98 figures. 12mo, cloth, \$1.50, net.

Naval Architecture.

Third Edition, Revised and Enlarged. vii + 641 pages, 217 figures. 8vo, cloth, \$7.50, net.

Thermodynamics of the Steam Turbine.

vi + 282 pages, 103 figures. 8vo, cloth, \$3.00, net.

Propellers.

iii + 132 pages, 29 figures. 8vo, cloth, \$1.25, net.

Computation for Marine Engines.

8vo, iv + 209 pages, 52 figures. Cloth, \$2.50, net.

BY PROFESSORS PEABODY AND MILLER
Steam-boilers.

By Prof. Cecil H. Peabody and Prof. Edward F. Miller. Third Edition, Revised and Enlarged. vi + 543 pages, 236 figures, 5 folding-plates. 8vo, cloth, \$3.75, net.

MANUAL
OF THE
STEAM-ENGINE INDICATOR.

BY

CECIL H. PEABODY,

*Professor of Naval Architecture and Marine Engineering,
Massachusetts Institute of Technology.*

FIRST EDITION.

SECOND THOUSAND.

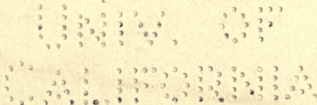

NEW YORK
JOHN WILEY & SONS, INC.
LONDON: CHAPMAN & HALL, LIMITED

1914

TJ478
PA

Copyright, 1900,
BY
CECIL H. PEABODY.

TO THE
LIBRARY OF THE
SCIENTIFIC PRESS

THE SCIENTIFIC PRESS
ROBERT DRUMMOND AND COMPANY
BROOKLYN, N. Y.

THE STEAM-ENGINE INDICATOR.

THE steam-engine indicator is an instrument invented by Watt to measure and record the pressure of the steam in the cylinder of an engine. The diagrams drawn by an indicator enable us to calculate the power of the engine, to examine and adjust the actions of the engine valves, and to make certain inferences concerning the transformation of heat into work and the influence of the metal of the cylinder on that operation. Too much emphasis cannot be given to the fact that the sole office of the indicator is to measure and record pressure; actions which are commonly said to be revealed by the indicator are really inferences based on the pressure or on changes of pressure.

The Watt Indicator.—While the exact form of the original indicator is not known, it is interesting to consider the form ascribed to it by tradition, more especially as that form presents the elements of the instrument clearly. In Fig. 1 *P* is a piston that moves freely in the cylinder *C*, which is open at the top, and

can be put in communication with the interior of the engine cylinder by the cock *T* and a short system of

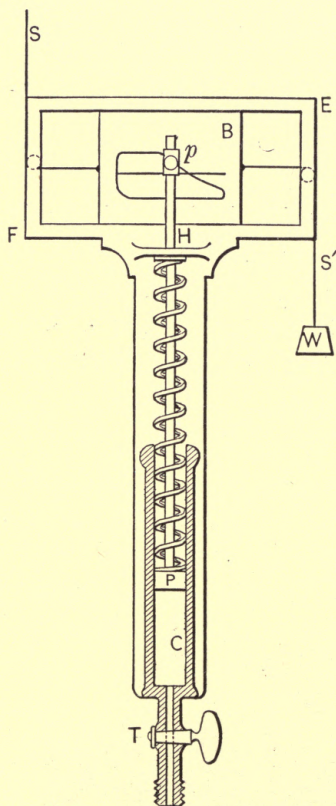

FIG. 1.

pipng. The piston-rod *HP* passes up through a hole in the block *H*, and carries a pencil *p* at the upper end. A helical spring between the piston *P* and the guide-

block H measures the pressure at the under side of the piston P . At the top of the indicator there is a light board B which slides freely in the frame EF . This board has a motion like that of the piston of the engine, on a reduced scale, which is obtained from a proper reducing motion attached to the crosshead, and is communicated by the cord S . The weight W on the end of the string S' pulls the board B toward

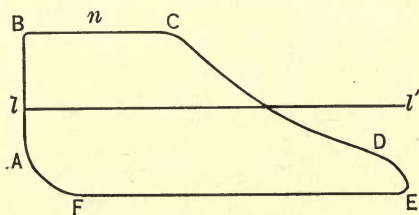

FIG. 2.

the right and keeps the strings taut. A piece of paper is attached to the board B , against which the pencil p can be pressed when a diagram is desired. Fig. 2 represents the diagram on a larger scale. To take a diagram, the string S is connected to the reducing motion so that the board B moves back and forth, keeping time with the piston of the engine. The cock T is now turned to open communication with the engine cylinder, and the pencil p rises when steam is admitted and falls when steam is exhausted. If the engine runs slowly the pencil can be pressed against the paper at any position of the piston of the engine; for example, at the beginning of the stroke. Admis-

sion of steam at the beginning of the stroke gives a sudden rise of pressure represented by the line AB ; then the piston of the engine moves forward under nearly constant pressure of steam coming from the boiler, until the admission of steam is interrupted by the closing of the admission-valve; during the remainder of the stroke of the piston the steam in the cylinder expands in volume and loses pressure as indicated by the curve CD ; at D the exhaust-valve opens and the pressure rapidly falls to the exhaust; during the greater part of the return-stroke of the piston, steam is exhausted to the condenser at constant pressure, as represented by the line EF ; finally the steam caught in the cylinder by the closure of the exhaust-valve is compressed as shown by the curve FA . After the diagram is completed the cock T is turned so as to shut off communication with the engine cylinder and open communication from the lower end of the cylinder C , Fig. 1, and the atmosphere. The pencil then comes to its neutral position with atmospheric pressure both above and below the piston P , and with no tension (or compression) on the spring. A reference-line l' is now drawn by pressing the pencil once again on the paper; this is called the atmospheric line. Every point of the diagram corresponds to a definite position of the engine piston; thus, n corresponds to one-fourth stroke of the piston, and further the distance of n from the line l' measures the pressure of the steam in the cylinder at

quarter-stroke, reckoned above the pressure of the atmosphere. During exhaust, when the steam is flowing into the condenser, the vacuum in the cylinder is measured by the distance of the pencil below the atmospheric line; the spring is of course stretched in tension while this occurs.

Recent indicators differ from the original prototype in two principal ways: in the first place, the sliding-board *B* is replaced by a drum or cylinder turning on a vertical axis, and in the second place the pencil is carried by a parallel motion which multiplies the motion of the piston. The drum gives a smoother and truer motion to the paper, and the multiplication of the motion of the piston by the parallel motion permits of the use of a short and stiff spring. A few well-known indicators are chosen for description; it will be seen that they differ in detail only.

The Crosby Indicator.—Figs. 3 and 4 represent the Crosby indicator, made by the Crosby Steam-gage and Valve Company. Here 8 is the piston of the indicator, above which is the spring which measures the steam-pressure. The motion of the piston is multiplied by the pencil-motion 13, 14, 15, 16, and communicated to the pencil 23, which draws a diagram on a slip of paper that may be wound around the paper-drum 24.

The body or barrel of this indicator is made in three pieces, 1, 4, and 5. The part 1 carries the paper-drum at the end of an arm or bracket; the part 5 has at its

lower end a device for securing the indicator to the cock leading to the engine cylinder; the part 4 is bored out to receive the piston 8. The part 4 is more conveniently made separate, and may readily

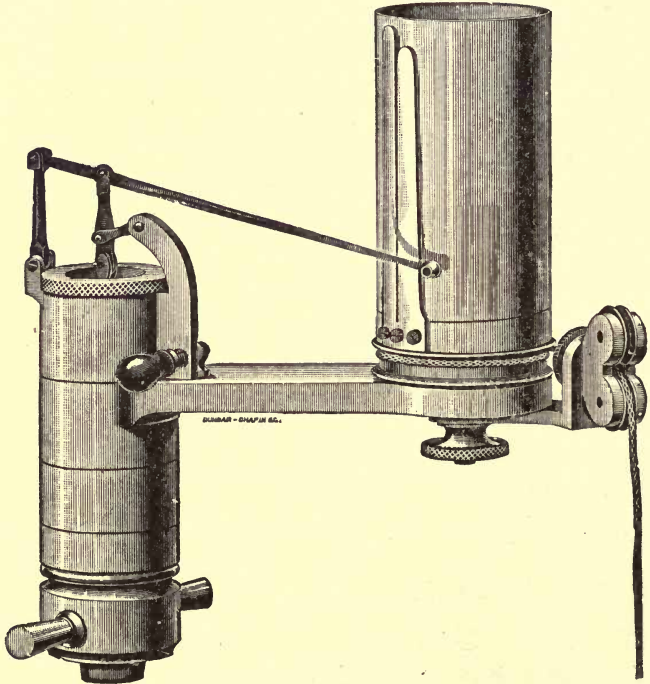

FIG. 3.

be replaced if its inner surface should become cut or scored; it is also surrounded by a steam-jacket, which insures a uniform temperature.

The spring, which is shown separately by Fig. 5, is a double helix wound from one piece of round wire,

and screwed through the four flanges of a brass head. The length and stiffness of the spring are adjusted by screwing it into or out of the head, and then the wire

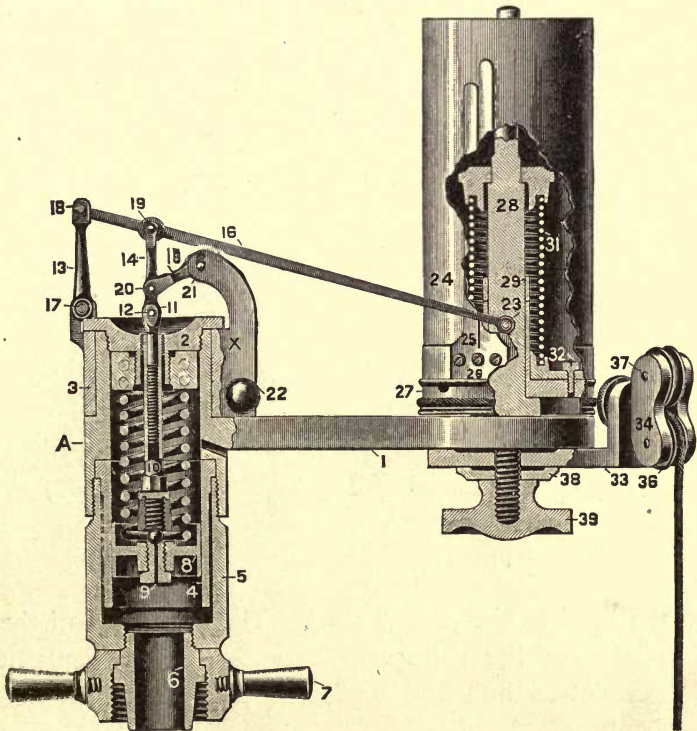

FIG. 4.

is secured by soldering it to the head. The head is screwed to the cap 2, Fig. 4, which in turn is screwed into the top of the piece 1. A steel bead at the lower end of the spring affords the means of connecting the spring to the piston, as shown by Fig. 4 and

Fig. 6. The hub of the piston is bored through and threaded. A hollow piston-rod is screwed down on top of the head, and a screw is screwed up from below, and adjusted to take up all looseness or backlash without giving too much pressure and friction. The hub is slotted transversely above the piston to allow the cross-wire of the spring to enter and bring

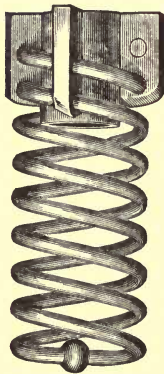

FIG. 5.

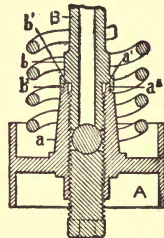

FIG. 6.

the head to the proper place. The lower end of the piston-rod has a lip which comes over the ends of the slotted hub and binds the piston-rod and hub firmly together.

The piston-rod slides through the cap 2 and carries the head 11, which may be screwed up or down to adjust the position of the pencil on the paper-drum. The pencil-motion consists of the pencil-bar 16, which is guided by the link 13, and receives motion from the piston-rod head 11, through the transmission-piece

14, which itself is guided by the link 15. This forms a kind of transformed grasshopper parallel-motion, so that the pencil 23 moves on a vertical line which is very nearly straight within the range of motion allowed, and gives a close copy of the motion of the piston, but on an enlarged scale. The pencil-motion is carried by a sleeve 3, which can turn on the body of the indicator, and thus throw the pencil onto the paper-drum, or withdraw it after a diagram is taken. A handle with a wooden knob and a steel shank is screwed through the wing x of the sleeve, and bears against a stop in the arm 1, when the pencil comes in contact with the drum. The pressure of the pencil against the paper-drum is adjusted by screwing this handle in or out.

To assemble the piston and spring, etc., slack back the screw 9 in the piston 8; place the spring in the transverse slot through the top of the hub of the piston; screw down the piston-rod 10 firmly onto the top of the piston-hub, using a socket-wrench provided for this purpose; adjust the screw 9 so that the piston may turn slightly on the bead without friction and without backlash. Take the sleeve 3 with pencil-motion attached in one hand and the piston and spring in the other; catch the hollow piston-rod into the head 11, and then screw the head of the spring firmly onto the cap 2. Slip the piston into the cylinder 4, and the sleeve onto the body of the indicator, and screw down the cap into place. Should the pen-

cil be too low down on the paper-drum, dismount the sleeve with the spring and piston, and turn the cap 2 toward the left, thus running the head 11 further out of the piston-rod; then replace the sleeve and screw down the cap. Should the pencil be too high, it may be lowered in a similar way, but the cap is then turned to the right to run the head 11 into the piston-rod.

The paper-drum consists of the thin shell 24 and the hub or body 27. The shell can be removed to expose the drum-spring and other internal parts. The hub turns on the spindle 28, which is screwed firmly into the arm 1; it can turn through about five-sixths of a rotation and is checked by stops. A spring 31 is clamped to the hub by a plate 32, and is attached to the spindle by a cap with a square hole, resting on a square bearing on the spindle. The paper-drum may be turned in one direction by drawing out the cord which is wrapped around the hub, and it is returned by the drum-spring. The cord may be led in any direction through the fitting 34. In the first place, this fitting can be revolved about a vertical axis and clamped in place by the milled head 38; then the fitting can be rotated around a horizontal axis and clamped by a milled head 37; two rollers in the fitting 34 afford means of changing the direction of the cord at the fitting.

The Thompson Indicator.—Fig. 7 shows the external appearance and Fig. 8 gives a vertical section

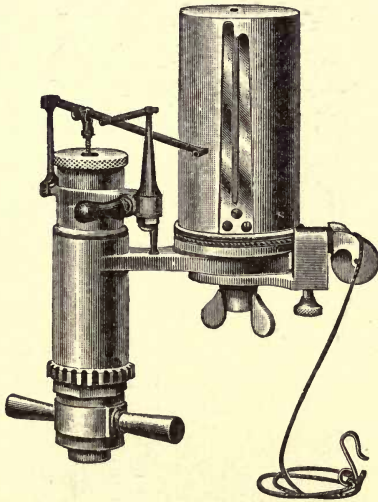

FIG. 7.

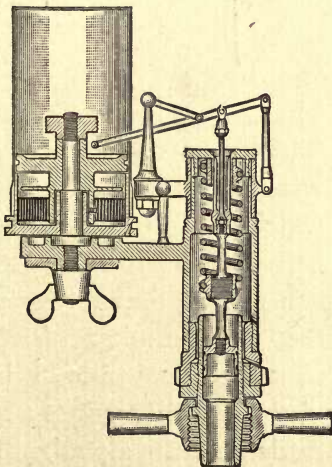

FIG. 8.

of the Thompson indicator. It uses a single helical spring as shown by Fig. 9, which is screwed onto the piston at the lower end and onto a cap for the indicator-piston at the upper end. The pencil-motion is a modified grasshopper parallel motion with the piston-

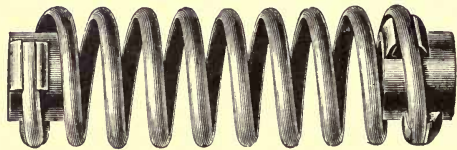

FIG. 9.

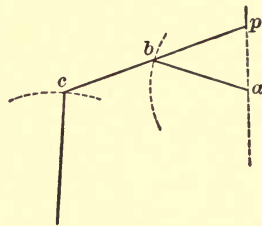

FIG. 10.

rod attached directly to the pencil-bar. For comparison we have a diagram of an exact parallel motion in Fig. 10, in which it is to be noted that the guiding-link ab is half the length of the bar cp , and that the point p moves on straight lines through a . The guiding-link of the pencil-motion of the Thompson indicator is shortened and moved in toward the piston-rod, and the pencil describes a slightly curved line; but the deviation from a straight line is scarcely perceptible within the range of motion of the pencil.

The paper-drum spring is a flat spiral like a watch-spring. The fitting through which the cord is led has one wheel instead of two, as shown by Fig. 3 for the Crosby indicator; this, by the way, is the original form of the fitting, and other forms are derived from

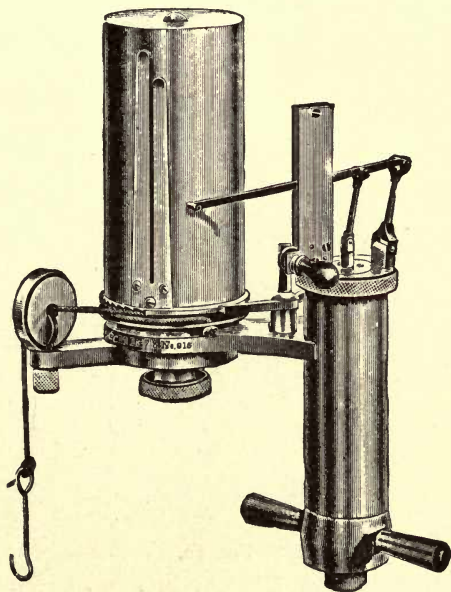

FIG. 11.

it. The Thompson indicator is intended to be simple and substantial so that it may not get out of adjustment if used with ordinary care.

The Tabor Indicator.—This indicator is represented by Figs. 11 and 12. The most notable peculiarity is its pencil-motion, which is guided by a roller moving

in a curved slot, as shown by Fig. 12. The slot is cut to such a form that the pencil is guided correctly on a straight line, and there is the incidental advantage that the weight of the guiding-link of the pencil-motion of the Thompson indicator is dispensed with. But since the roller must

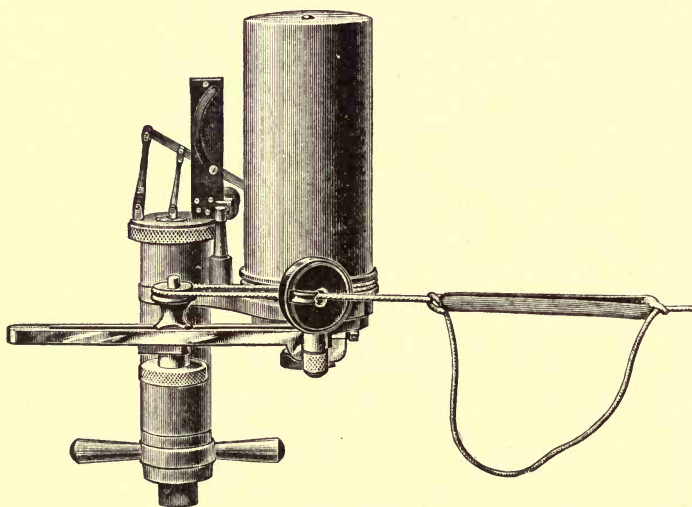

FIG. 12.

be slightly smaller than the slot in order that it may touch one side only, the actual motion of the pencil may deviate from a straight line, and it is a question whether this pencil-motion is appreciably better than those which make use of approximate parallel motions. A double helical spring made of two wires is used in this indicator, as shown by Fig. 13. The cord from the paper-drum is led through a disk

with a roller, giving the same effect as the corresponding fixtures of the Thompson and the Crosby indicators. Fig. 11 has a detent and Fig. 12 a drum-stop attachment; these details will be considered later.

The Bachelder Indicator, shown by Figs. 14 and 15, has a flat spring instead of the helical springs used in other indicators. This spring, which is shown



FIG. 13.

in full size by Fig. 16, is securely pinned at the farther end and is connected to the piston-rod by a pin-joint as shown in Fig. 15. The effective length of the spring is the distance from the piston-rod to the clamp *a*, Fig. 15, and this length may be changed by loosening the screw at *a* and sliding the clamp along. Consequently the scale of the spring can be varied through a wide range, and a very few springs will suffice for all uses of the indicator.

Indicator for Gas-engines. — Recent gas-engines commonly have a pressure of 250 or 300 pounds per

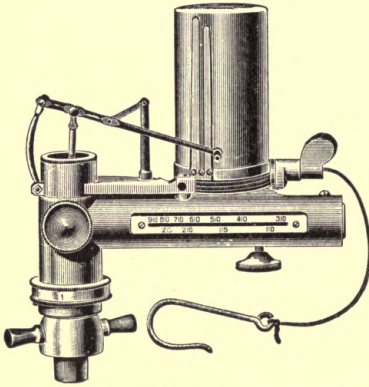

FIG. 14.

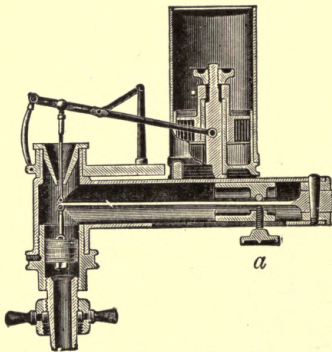

FIG. 15.

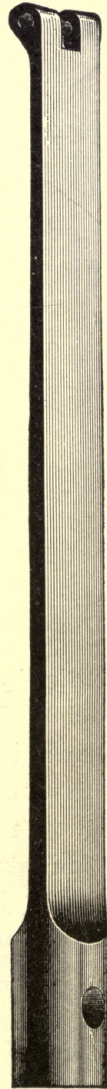

FIG. 16.

square inch in the cylinder, generated by a very rapid combustion or explosion of the gas and air which form the working substance. Ordinary steam-engine indicators, when used on such engines, are liable

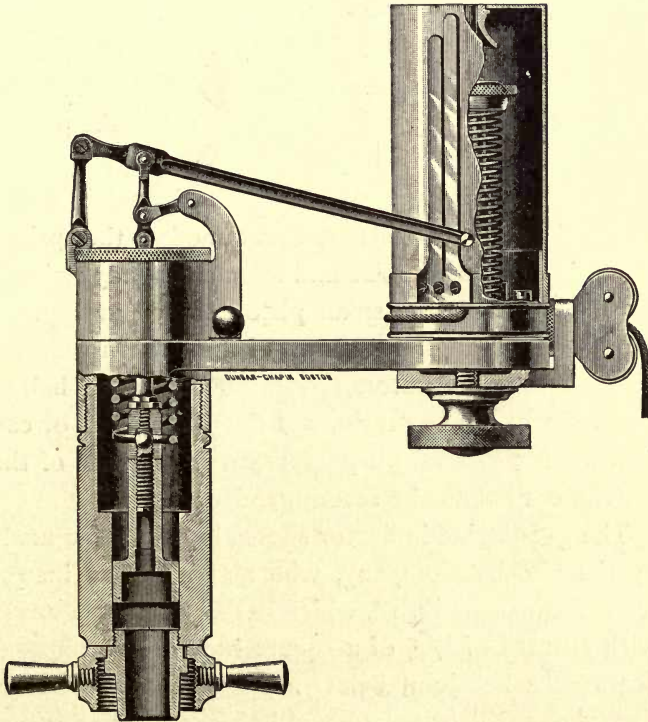

FIG. 17.

to get out of order; consequently it has been found desirable to use a special indicator for such work, like that shown by Fig. 17. The piston has an area of one-fourth of a square inch, that is, half the area

of the piston of a steam-engine indicator. Springs supplied for steam-engine indicators can be used in this instrument if rated at twice the scale marked on them; for example, a 100-pound spring is rated at 200 pounds, and can be used for a pressure of 300 pounds to the square inch, or more. The pencil-bar is made rigid to withstand the shock of the explosion in the gas-engine cylinder; extra weight in the pencil-motion is of less consequence as a stiff spring is always used. The upper part of the barrel is bored out to the usual diameter to accommodate the spring, which is of the usual size and form as already pointed out. If desired, the small piston shown in Fig. 17 can be taken out and a piston of the pattern used for steam-engine indicators, having an area of half a square inch, can be put in, and thus this indicator can be used for general purposes; but such a use of the instrument cannot be recommended.

The gas-engine indicator shown by Fig. 17 is made by the Crosby Company, who also make an instrument shown by Fig. 18, which has a piston or plunger with an area of $\frac{1}{40}$ of a square inch. This plunger bears on a ball-joint below a piston of the ordinary size, above which is the usual helical spring. Springs furnished for steam-engine indicators must be rated at 20 times the scale marked on them when used with this instrument. A side passage controlled by a plug-valve may be opened to give direct communication with the large cylinder when moderate pressures are

to be measured; but though this may occasionally be a convenience it is not to be recommended, as the side passage is small and the pencil-motion is extra heavy to give rigidity. The post near the paper-drum

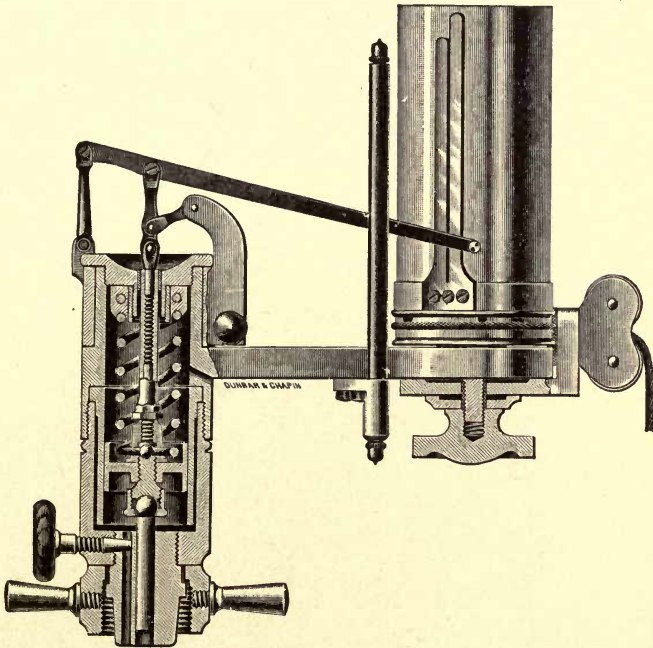

FIG. 18.

is intended to steady the pencil-bar when desired. This instrument is intended to be used with hydraulic pumps and hydraulic apparatus, and on pneumatic gun-carriages for heavy ordnance.

Ammonia Indicators.—Special indicators made entirely of steel are supplied for indicating the compres-

sors of ammonia refrigerating-machines; for ammonia would attack and soon destroy those parts of a steam-engine indicator that are made of brass.

Indicator Cock.—The indicator is put in communi-

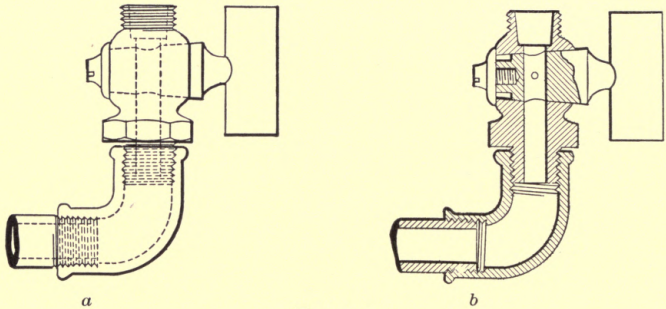

FIG. 19.

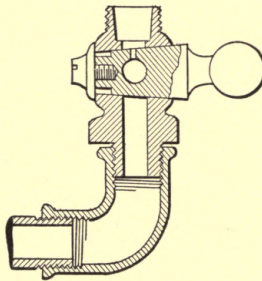

FIG. 20.

cation with the engine cylinder through a cock and a short system of piping as shown by Fig. 19. When the handle is vertical, as shown by Fig. 19, there is a straight passage from the cylinder of the engine to the indicator; but when the handle is turned down the passage from the engine is closed, as shown

by Fig. 20, and communication is opened to the atmosphere through a side passage. The cock is set in this last position when the atmospheric line is drawn.

Fig. 21 shows the elevation and Fig. 22 the section of a three-way cock that may be used for taking diagrams from both ends of a cylinder with one indica-

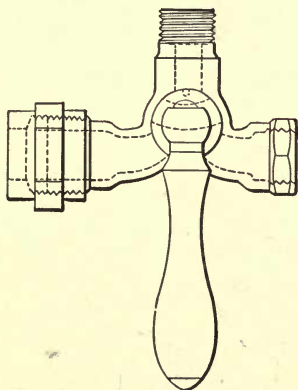

FIG. 21.

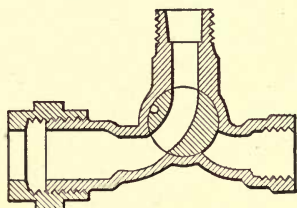

FIG. 22.

tor. A pipe from one end of the cock leads to the head end of the engine cylinder, and a pipe from the other end leads to the crank end of the cylinder; a side passage leads to the atmosphere. Fig. 22 shows communication open from one end of the engine cylinder to the indicator; if the handle is thrown to the other side the other end of the cylinder will be in communication with the indicator; the indicator will be open to the atmosphere when the handle is in mid-position. When convenient it is better to use two in-

dicators and avoid the considerable lengths of piping required for a three-way cock.

Inspection of the Instrument.—The truth of a diagram taken by an indicator depends on the construction of the instrument, the condition in which it is maintained, and the skill with which it is used. Indicators from reliable makers are carefully and thoroughly made and are in good condition when sent out. An instrument which is out of condition from use or accident should be at once returned to the makers for repair.

The sleeve which carries the pencil-motion should turn smoothly on the body of the indicator and be free from looseness or backlash. Friction at this place may be inconvenient, but will not affect the truth of the diagram; looseness will affect the truth of the diagram and should not be tolerated. The makers only can remedy defect in this part. The universal joint in the piston-rod should have just enough freedom to avoid cramping the indicator piston in the cylinder. This joint for the Crosby indicator is made on the bead at the bottom of the spring and must be adjusted when the spring is put in. The universal joint of the Thompson indicator is at the middle of the piston-rod and should be adjusted by the makers; a careful mechanic may be able to take up backlash due to wear by grinding the end of the hollow guiding-rod which runs through the cap, and screws onto the lower half

of the piston-rod. The several joints of the pencil-motion should be free and without appreciable backlash; there is no way of detecting looseness in these joints individually, but when the instrument is set up with a stiff spring in place, looseness in any part of the sleeve, universal joint, or pencil-motion will appear if the pencil is carefully moved up and down with the fingers. If the sleeve and universal joint are known to be right such looseness must be attributed to the pencil-motion, and will show that the indicator must be returned to the makers. Skill in detecting and locating looseness can be acquired only by practice. The pencil-motion and sleeve should be oiled when necessary with watch-oil.

The piston should be a good, but not a tight, fit in the cylinder of the indicator; excessive piston-friction will destroy the truth of the diagram; a moderate leakage past the indicator does not appear to have much influence. The condition of the piston and cylinder may be tested by putting the indicator together without a spring; in this condition the piston should fall freely from any position when the pencil is raised and let fall; failure to fall freely indicates friction somewhere. Excessive friction may occasionally be detected in the pencil-motion or in the universal joint of the piston-rod, but usually such friction will be found at the piston. When there is evidence of friction the piston and pencil-motion should be removed and both the piston and the cylinder wiped clean; this

may be done with a piece of clean cloth or with the fingers, which should of course be free from grit; and the piston should be examined to detect roughness or scoring if that has occurred. A slight roughness of the piston or the cylinder can often be reduced by grinding the piston up and down in the cylinder, turning it round and round at the same time. For this purpose the piston should simply be screwed onto the piston-rod, which can be held in the fingers by the upper end. Both piston and cylinder must be wiped dry and clean before beginning this process; emery powder or other grinding material should not be used, the idea being merely to rub down small roughnesses. After the piston and cylinder are smooth and clean the test for freedom with the spring removed should be made, together with an inspection for friction at the joints of the pencil-motion or the universal joint. If the piston and cylinder are so much scored that this process is ineffective it will in general be better to return the indicator to the maker; if this cannot be done the work may be intrusted to a skilful mechanic, who may grind the piston smooth in a lathe, using fine emery or crocus paper, and afterwards grind the piston in the cylinder, using emery or crocus powder, bearing in mind that the object is to remove the roughness due to scoring, and that the sizes of the piston and cylinder must not be changed.

Friction at the piston is frequently betrayed by the diagram, as will be explained later, and in such case

it is usually sufficient to clean both piston and cylinder and immediately put the instrument together without disturbing the spring. When diagrams are taken at intervals of five minutes or more the indicator can be cleaned and adjusted between times, but when diagrams are taken frequently and for some considerable time it may be advisable to have a reserve indicator set up and adjusted which may immediately replace the one in use when it shows signs of clogging and consequent friction.

The indicator-piston may be occasionally oiled with a little clean cylinder-oil; some engineers prefer to use no oil, merely keeping the piston and cylinder wiped clean.

Preparation for taking Diagrams.—When the indicator is ready for use the indicator cock should be opened and blown through several times to blow out dirt and grit that may be present. The cock is then closed and the indicator secured to the cock and adjusted so that the cord may lead fairly to the reducing mechanism. It is very important that the indicator shall be properly secured before the steam is let on to take a diagram; failure to do so may lead to serious damage to the instrument, and to delays and annoyances that may be as bad. The indicator commonly stands erect, but if necessary it may be set with the paper-drum horizontal or at an angle.

The cord leading from the paper-drum is now to be adjusted to the proper length to hook on to the re-

ducing mechanism or to a loop in a cord tied to that mechanism. It is convenient to tie the hook at the end of the drum cord by a bowline knot, as shown by Fig. 23, since that knot is not likely to slip and may



FIG. 23.

be readily loosened. Fig. 24 shows the same knot partly tied. Some indicator-makers furnish a slip of

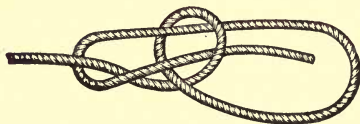

FIG. 24.

metal like that represented by Fig. 25, to facilitate the adjustment of the length of the cord. The hook is strung on the loop at *a*. This device gives added



FIG. 25.

weight at the hook and will not be found so convenient as a bowline knot.

The cord should always be tested for length before hooking onto the reducing motion, and must never be too short, as in that case the cord will be broken or the indicator will be injured. When the cord is hooked on the paper-drum should run freely without striking against its stops at either end of its swing.

On high-speed engines striking will be revealed by a clicking noise; with a slow-speed engine striking may be detected by holding the cord lightly in the fingers and following its motion without interfering with the tension of the drum spring. Striking can sometimes be detected from its influence on the diagram, as will appear later.

There are two ways in vogue of putting the paper on the paper-drum. Thus, the paper may be taken by its two lower corners and looped over the drum, and then the end can be drawn in succession under the longer and then the shorter of the paper-clips. The paper is now drawn taut and true and slipped down to its place. Some prefer to fold and crease one end of the paper before beginning this operation. Again the paper may simply be wrapped around the drum, slipping one end under both the clips, and the other over it and under the shorter clip. The first way is more likely to draw the paper snugly onto the drum, and the second avoids the projecting edges of the first method.

Paper and Pencil.—Two kinds of paper are used for indicator diagrams, plain unprepared paper and a paper which has a special lead glaze which will take a mark from a brass point, called metallic paper. The plain paper should have a smooth surface with little if any glaze, without ruling or water-marks. For such plain paper a graphite pencil is used; it should be of the best quality and of medium hardness, so that it

will give a fine clear line with a light pressure on the paper; its point must be kept fine and true, for a one-sided point will spoil the geometric design of the pencil motion. A short piece of graphite from a cedar pencil, or a piece of the graphite made for a pencil-case, may be used.

The metallic paper will usually be obtained from the indicator-maker cut to the proper size for indicator cards, but in some cases it may be convenient to get sheets of such paper from dealers and cut it to size. One side of the paper has a thick smooth glaze, which takes a fine clear mark from a brass point. This glaze is poisonous, and may even give trouble at any abrasion of the skin if handled freely. When metallic paper is used the pencil will be replaced by a brass point furnished with the indicator. Its point should be true and fine, but not sharp enough to cut the paper.

Indicator Cord.—A special braided cord is supplied for indicators, which is of uniform size, strong and comparatively inelastic; but all fibrous cord is elastic and gradually stretches under tension, consequently the use of long pieces of cord is to be avoided.

Drum Detent.—As it is sometimes troublesome to hook the indicator-drum cord onto the reducing motion, various devices have been invented for stopping the paper-drum without unhooking. At the left hand of the paper-drum in Fig. 11 the rim of the base above the cord is cut into ratchet-teeth, and there is

a click on the post that serves as a stop for the pencil-motion, which may engage these teeth when the drum cord is drawn out. The click may be thrown forward to engage the ratchet, or may be thrown back to release the drum, and is held in either position by a spring. To stop the drum, throw the click forward and draw the cord out by hand till it remains slack. The paper for a diagram may then be put on. To release the drum, draw the cord taut by hand, throw out the click and release the drum carefully so that the slack in the string shall not be taken up with a jerk by the drum spring. The drum will now move with the engine crosshead and a diagram can be taken.

Another way of stopping the paper-drum is shown by Fig. 12. Here there is a long slotted bar which is secured just under the fitting which carries the guide-roller for the cord. In the slot is a sliding piece which can be clamped anywhere in the slot. The upper end of the slide carries a second guide-roller over which the cord passes on the way from the drum to the adjustable guide-fitting. The cord is given such a length that it will rotate the paper-drum properly when the slide is clamped at the outer end of the slot. To stop the drum the slide is slid toward the inner end of the slot, which slackens the cord so that the drum stops. An india-rubberband is tied on the cord in such a way that it takes care of the slack of the cord while the

drum is at rest; when the cord is drawn taut the band is pulled out and lies along the cord.

It will frequently be found convenient to provide for slack in a cord, or to hang up the free end of a cord by a rubber band. For this purpose a long band is required, strong enough to take care of the cord, but not so stiff as to give much additional tension when the drum is in motion. If a long rubber band cannot be had, two or three may be united to give the proper length.

Electrical Attachment.—When simultaneous diagrams are desired from the several cylinders of a compound, triple-expansion, or other multiple-cylinder engine, the electrical attachment shown by Fig. 26 will be found convenient. It consists of an electromagnet *M* with its armature *A* attached to the pencil-motion in such a way that the pencil is applied to the paper on the drum when an electric current is passed through the magnet and the armature is drawn up. The magnet is carried by a fixture *S* which is clamped to the body of the indicator by the screw *E*. *CC* are binding-posts for the wire from a galvanic battery, and *D* is a spring which holds the armature in the field of the magnet when the circuit is open, and throws back the armature and removes the pencil from the paper when the current is broken. All the indicators to be operated are provided with such electromagnets which are in the same circuit, and all can be operated by closing the circuit by a push-

button or otherwise. Sometimes one indicator is worked by hand and is provided with a push-button, which is pushed up when the pencil-motion is forced against its stop. The same principle is used by other makers with various arrangements of details.

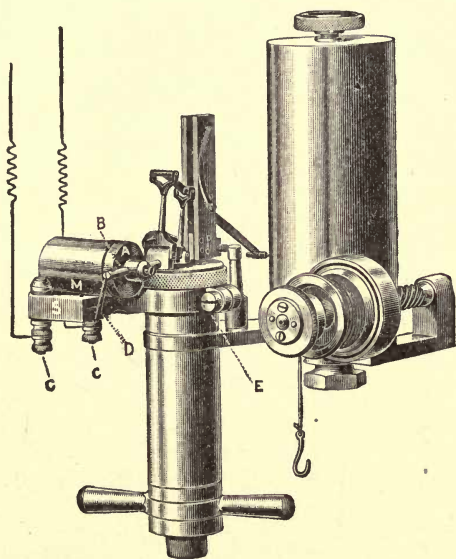

FIG. 26.

If an engine runs regularly a single operator can take diagrams from the several cylinders in succession by hand, just as well as by aid of the electrical device. Again, if diagrams are taken frequently it will require a number of observers to keep the indicators working properly. It is seldom, if ever, that the electrical device is more than a convenience.

Reducing Motions.—Some form of reducing motion is required to give a reduced copy of the motion of the crosshead of the engine, and impart it to the paper-drum. A few common forms will be described; the engineer will have to apply them to special cases or will have to devise new ones as occasion may require. The design for a reducing motion should be geometrically correct, or else the error should be determined and be kept within limit. In general, the moving parts should be light and rigid and the joints free from backlash.

Brumbo Pulley.—A simple form of reducing motion, known as a Brumbo pulley, is shown by Fig. 27. PN is a vibrating arm pivoted at P . The lower

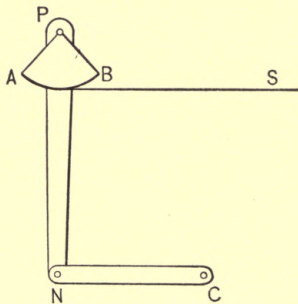

FIG. 27.

end N is connected by a link NC with the crosshead of the engine. The cord S from the indicator runs on the arc AB . Usually the arc AB is a circular arc centred at the pivot P , and the reducing motion

gives only an approximate copy of the motion of the crosshead. This device can be made to give an exact copy by giving a correct form to the arc AB ; which form must be constructed much as a cam is laid out. As arranged it will commonly be found sufficient to retain a circular arc, but to centre it at a point a little below P . If more convenient the arc AB may be inverted and placed above P . The cord may be led from the arc AB in any convenient direction, but if it is led at an angle with the horizon the arc AB should be turned to the same angle from the vertical.

This device may be made of wood if for temporary use, or of metal if permanent. If it is made of wood, it will be proper to bush the bearing surfaces at the pins with brass; but if made of hard wood, with the pins a tight fit in the holes, it will run for some time without backlash. The bearing surfaces at N and C should be ample and the link NC should be light, especially when used for a high-speed engine. The arm PN should be rigid and the pivot free from backlash. It is also important that the support for the pivot shall be rigid.

A simple method of stopping the paper-drum without unhooking can be used with this reducing motion. The cord after passing over the arc AB may be led through an eye at the pivot P . Adjust the cord S to the proper length and tie a knot in it just before it passes through the eye at P . If the free end of the cord beyond the eye at P is slackened the indi-

cator drum will stop, and it can be set in motion by drawing the free end taut so that the knot shall come up to the eye. The cord may be drawn up by hand while the diagram is taken, or it may be drawn up and hitched at some convenient point.

Pantagraph.—A correct reducing motion may be designed in the form of a pantagraph, which is well

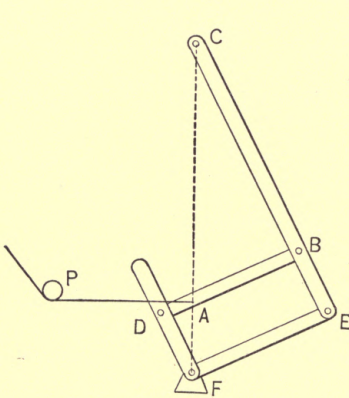

FIG. 28.

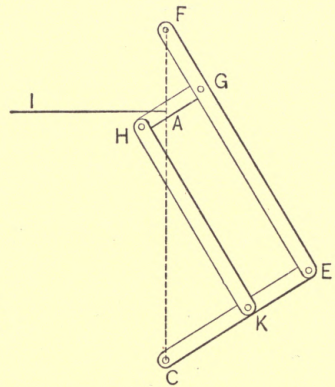

FIG. 29.

adapted to slow-moving engines; high-speed engines will quickly shake a pantagraph to pieces. Fig. 28 shows a pantagraph fixed to the engine-room floor, and Fig. 29 shows one fixed to the frame of the engine. The first has adjustable parts and can be used for various engines as may be found convenient; the second is designed for, and used on, one particular engine. The pantagraph has for its essential part a four-bar cell, such as *BEFD*, Fig. 28,

which maintains the moving parts in their proper relation. A point of the pantagraph, in this case the joint F , is pivoted to a fixed support; a point, as C , on the prolongation of EB is pivoted to the cross-head of the engine; and a point, as A , carries the indicator cord. The point A must be on the line CF through the moving point C and the fixed point F , and must divide it so that AF is to CF as the length of the diagram is to the stroke of the engine. The cord AP must be led off parallel to the motion of the crosshead; if necessary the cord may be led round a guide-wheel, as at P , on the way to the indicator. To make this pantagraph adjustable a series of holes is provided for the pivot C , and the bar BD can be set at various distances from FE ; the point A is sometimes carried by an adjustable sliding piece that can be clamped to the bar BD , but more commonly the adjustment is made by providing a series of holes for a pin that can be screwed into the bar BD . In this latter case the point A will not always be exactly on the line CF , but a slight deviation will have little effect. This pantagraph can be made of metal, or of wood bushed with brass, or of wood with metallic pins only if the latter are a tight fit for the holes.

In laying out a pantagraph for a particular engine as represented by Fig. 29, we may proceed as follows. In the first place AI is to be drawn at the proper height to lead correctly from the indicators;

it may be a piece of indicator cord or it may be a rod sliding in guides at the end *I*. The line *FC* is to be made of a proper length to avoid awkward positions of the pantagraph when the crosshead is at the ends of the stroke; it will be well to limit the total angular motion of the line *FC* (from side to side) to 60° . The line *FC* will now be divided at *A* so as to give the proper length to the indicator diagram. Ordinarily the points *F* and *C* will have to be located, one on a post on the engine frame and the other on an arm projecting downward from the crosshead. The bars *FE*, *EC*, *HK*, and *HG* must be drawn in by trial to give a convenient arrangement of joints and other details. This pantagraph will be preferably made of metal throughout. If the joints wear loose the holes may be rebored and fitted with larger pins. When applied to a vertical engine the mechanism will be turned through a right angle so that *IA* will be vertical.

A modification of the pantagraph, known as the lazy-tongs, is shown by Fig. 30. The joint *B* is pivoted to a convenient fixture near the engine, and the pin *A* is slipped into a hole in the crosshead or in a piece which is fastened to it. The indicator cord is led from the pin *E* parallel to the motion of the crosshead. The bar *DC* is set so as to give the proper length of diagram, and the pin *E* is set on a line from *A* to *B*. The lazy-tongs is commonly made of wood and has considerable flexibility, which, with the large

number of joints to get loose, makes it rather a crude device.

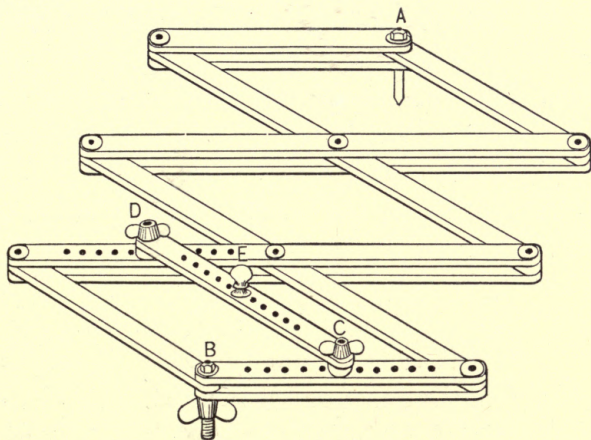

FIG. 30.

Swinging-lever and Slider.—A simple and serviceable reducing motion is shown by Fig. 31. It con-

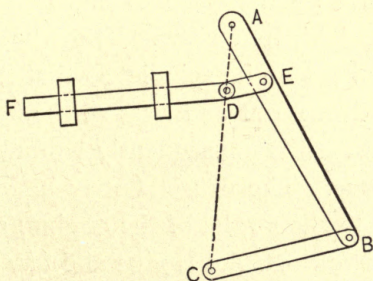

FIG. 31.

sists of a swinging-lever AB which is connected to the crosshead by a link BC ; a parallel link ED

moves a sliding-rod DF , which moves in guides parallel to the motion of the crosshead. The point D is on the line AC , and divides it so that AD is to AC as the length of the diagram is to the stroke of the engine. The rod DF is made long enough to reach to the indicator, which can be hooked directly onto a pin set in the rod for that purpose. The links may be made double or may have forked ends at D , E , and B .

Reducing-wheel.—A portable reducing motion is shown attached to an indicator in Fig. 32. The indicator cord is wound round a drum A which can turn on a vertical post or spindle, and which is kept wound up by a clock-spring in its base. The wheel B is geared to the drum by spur gears (not shown in the figure) so that it makes three turns for one turn of the drum A . A long cord is wound in a helical groove on the wheel B and is led directly to the crosshead of the engine. The wheel turns on a screw-thread cut on its spindle, so that it descends as the cord is drawn out and rises as the cord is wound up, and the cord is consequently wound truly in the helical groove. The drum A may be varied in size to conform to the stroke of the engine; a small drum is used for a long-stroke engine and *vice versa*. Since the wheel B turns rapidly and must start and stop with the crosshead, it is made of aluminium for sake of lightness.

Fig. 33 shows a form of reducing motion which

has a cord from the engine crosshead wound on the wheel *O*, and which drives the paper-drum by a worm gear *R*. Several sizes of wheels are supplied

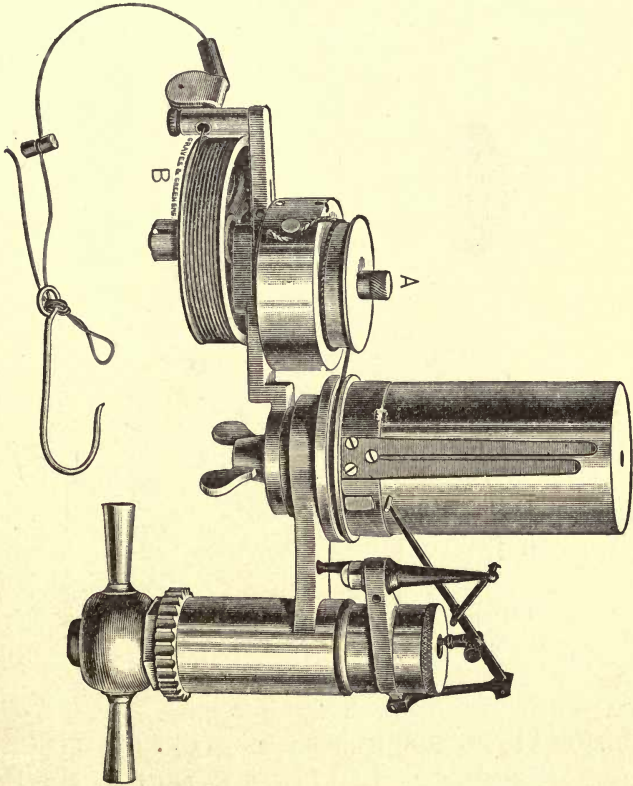

FIG. 32.

to conform to the stroke of the engine. A spring for winding up the cord is contained in the case *d*. At *u* is a milled head which controls a clutch on the wheel-shaft. When this clutch is released the

wheel turns freely on its shaft and the paper-drum remains at rest against one of its stops. When the clutch is thrown into gear the wheel is clamped to its shaft, which now drives the paper-drum by aid of the worm gear. To start the paper-drum, turn it

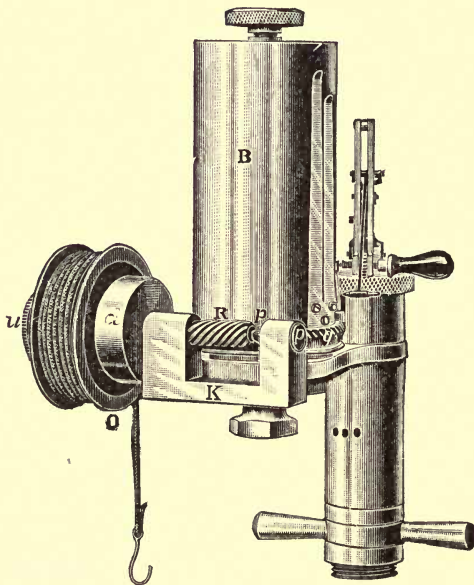

FIG. 33.

forward by the milled head above it, so that it stands at least a quarter of an inch free from its stop, and throw in the clutch at *u*. It may be released by throwing out the clutch.

Wire instead of Cord.—On large engines the indicators are at a considerable distance from the cross-

head and the reducing motion. It is sometimes recommended to use wire to transfer the motion to the indicator, and this may be of service with slow engines, especially if the wire can be kept taut by a weight or spring. On high-speed engines the wire is likely to sway from side to side and give more trouble than cord. Properly the motion should be transferred by a sliding rod used in connection with a correct and rigid reducing motion.

Taking Diagrams.—When the indicator is ready and a diagram is desired, start the paper-drum by hooking on the cord or by aid of the starting device when one is provided, and turn on the steam; let the indicator move idly until it is hot and clear of water; press the pencil-motion against its stop until a complete diagram is drawn; shut off the steam from the indicator and again press the pencil-motion against the stop to draw the atmospheric line; stop the paper-drum and remove the diagram and number or otherwise identify it. If other diagrams are to be taken it is well to place another paper on the drum.

The atmospheric line must be taken after the indicator is hot; it will be wrongly located if drawn when the instrument is cold. The instruction to draw the atmospheric line after the diagram is taken is for this purpose. If the engine runs slowly the pencil may be applied during exhaust, because this is a long line which is little liable to change, and thus

a single complete diagram can be drawn. If the engine runs rapidly such refinement is impossible, and it will be sufficient to hold the pencil-motion against the stop for a revolution of the engine as nearly as may be. In indicating high-speed engines it will be found that two or more diagrams are superimposed even though the pencil is applied to the paper for an instant only; but as the diagrams usually change little if at all no inconvenience will result. Some engineers prefer to get several superimposed diagrams and thus get a rough average. For important work it is essential that the engine shall run regularly, and then the diagrams will remain constant or change slowly.

Care of the Instrument.—After all the diagrams desired are taken, the indicator is to be removed from the engine, cleaned and dried, oiled and put in its case. In taking the indicator from the engine the hands should be protected to avoid burning them, and consequent danger of dropping the instrument or some part of it. If the indicator is taken apart while hot and the several pieces cleared from water as well as may be, and allowed to lie exposed to the air, they will dry off so that they may be readily cleaned and wiped dry. The spring and other parts that are made of steel should be oiled to guard against rust.

Scale of Spring.—The spring used should be chosen with reference to the highest expected pres-

sure; the height of the diagram should not exceed $1\frac{3}{4}$ to 2 inches. If the diagram lies entirely above (or below) the atmospheric line this height is to be measured from that line; if partly above and partly below the height is that of the diagram itself. In general, the use of a spring weaker than 20 pounds to the inch should be avoided, and for high-speed engines it is well to use a 40-pound spring or even a stiffer one. A small clear diagram is to be preferred to a large irregular one.

Indicator Diagram.—Fig. 34 may be taken to represent a typical diagram from a non-condensing en-

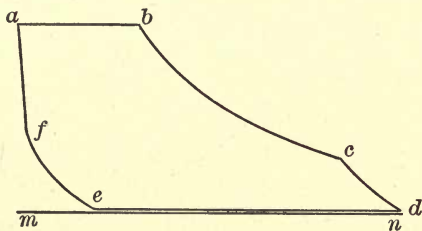

FIG. 34.

gine. Steam is admitted to the cylinder when the piston has nearly reached the end of its stroke, due to the lead of the steam-valve, as represented by the line *fa*, which inclines toward the left in the figure. From *a* to *b* is the steam-line which is drawn by the indicator while steam is admitted to the cylinder, and *d* represents the cut-off or closure of the steam-valve. After cut-off the steam expands with increase of vol-

ume and fall of pressure, as represented by the expansion-line bc , until the exhaust-valve opens at c . From release at c to the end of the stroke there is a rapid fall of pressure, represented by cd . During the return-stroke steam is forced out of the cylinder against the pressure of the atmosphere, as represented by de (which is called the back-pressure line) until the exhaust-valve closes at e . From e to f steam is compressed ahead of the piston with diminution of volume and rise of pressure. The atmospheric line is represented by mn .

A diagram like Fig. 34 with straight lines and sharp corners is never obtained in practice, for valves do not open and close instantly and the indicator has

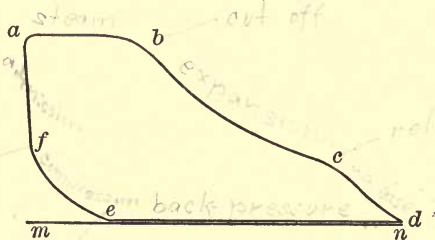

FIG. 35.

a tendency to run one line into another. The actual diagram is more like Fig. 35, which shows some loss of pressure during the admission of steam from a to b and a rounded corner at cut-off. The release cd is shown with a convex curve outward, as is usually found with quick-running engines. Finally efa appears as a continuous curve without corners and

without a well-defined separation of compression (ef) from admission (fa).

Summing up we have

ab , steam-line.	a , initial pressure.
bc , expansion-line.	b , cut-off.
cd , release.	c , release.
de , back-pressure line.	e , compression.
ef , compression.	f , admission.
fa , admission.	

Fig. 35 is drawn with a scale of 60 pounds to the inch, and the point a is one inch from the atmospheric line and represents a pressure of 60 pounds to the square inch initial pressure above the atmosphere. Or more conveniently, if the distance of a from mn is measured by a scale divided into 60ths of an inch, it will be found at the 60th division of the scale. In the same way the pressure of release is found by a scale of 60ths (called a 60 scale) to be 18 pounds above the atmosphere, while the back-pressure is found to be about one pound above the atmosphere.

The location of the point of cut-off and the point of release is always somewhat uncertain on account of the rounding of the corners already spoken of. It is customary to consider that the cut-off is at the point b , Fig. 36, when the convex rounding of the corner due to the closing of the steam-valve changes into the concave expansion-curve bc . Release is assumed to take place at c where the expansion-curve runs into

the release line cd . Compression is located at e where the pressure begins to rise above the back-pressure line. To determine the per cent of the stroke at which cut-off, release, and compression occur draw lines ma and nd perpendicular to the atmospheric line mn and just touching the diagram at its ends;

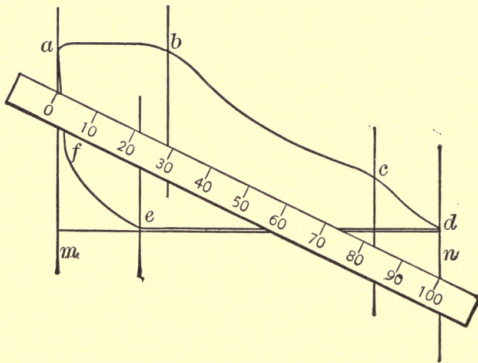

FIG. 36.

also draw vertical lines at b , c , and e , the points of cut-off, release, and compression; select a scale such that 100 divisions on it shall be a little longer than the diagram, and lay it diagonally across the diagram so that the zero shall be on the line ma and the division 100 on the line nd ; the per cents may now be read directly from the scale—for example, cut-off is at 29 per cent, release is at 83 per cent, and compression is at 22 per cent of the stroke.

Errors of the Indicator.—The steam-engine indicator is the engineer's main reliance in investigations

of the performance of steam-engines, and its indications are commonly accepted implicitly by the engineer who seldom has the time or the means of properly standardizing his indicators. Unfortunately the indicator is subject to errors which are neither small nor well known, even though indicator-makers have given much thought and skill to the perfecting of their instruments, and though much time has been given by engineers to experimental investigations of the errors of indicators.

There are two ways of considering the errors of indicators: firstly, the errors may be analyzed to the end that imperfections may be located and the proper remedies may be sought; and secondly, the actual error of the instrument in service may be investigated in order that the proper estimate may be attributed to its indications.

In the first place the errors of the pencil-motion piston and attached parts may be considered separately from those of the paper-drum. The latter will be considered first as they are comparatively simple and may be almost entirely eliminated by using proper reducing motions.

Errors of Paper-drum.—It is apparent that if the paper or card could have a positive motion given to it by a correct indicator-motion, it would give an exact reproduction of the motion of the engine cross-head and there would be no paper-drum errors. If necessary the card could be carried by a proper flat

board on the slide *FD* of Fig. 31, page 37; or a positive connection from such a slide to the paper-drum could be devised. The entire error of the paper-drum is to be attributed to the cord and spring by which the drum is drawn out and returned.

There are three sources of error of the paper-drum that can be identified, namely, the paper-drum spring, the inertia of the drum, and the friction of the drum.

Paper-drum Spring.—A long flat spiral spring like a clock spring is used by some makers for returning the paper-drum; others use a helical spring, as shown by Fig. 4, page 7. The first form is intended to give a uniform tension on the cord, and the second form is intended to give an increasing tension as the cord is drawn out. Both give increasing tension, though the increase due to a flat spiral spring may be the smaller. The increase of tension lengthens the cord, and the diagram is shortened to just that extent. As the cord is uniform in strength and elasticity the reduction in the length of the diagram is evenly distributed and the truth of the diagram is but little affected. This effect is found in indicating an engine at slow speed when a long cord is used. On high-speed engines this effect is obscured by the influence of the inertia of the paper-drum.

Inertia of the Paper-drum.—At the beginning of the stroke of the engine, the paper-drum is started from rest and it reaches its highest speed near the

middle of the stroke; it comes to rest at the end of the stroke. On a high-speed engine an appreciable force is required to start the drum; this force decreases regularly and becomes zero when the drum attains its highest speed; a regularly increasing force in the contrary direction is required to stop the drum. If we consider the drum at the beginning of a stroke with the cord wound on the base of the drum, it is evident that the cord must exert a pull equal to the sum of the tension of the spring and the force required to start the drum; and the stretch of the cord will be proportioned to the total pull it exerts, so that the cord is longer at the beginning of the stroke. As the drum moves toward the middle of the stroke the extra force decreases and becomes zero, so that the cord attains its normal length under the tension of the spring when the drum attains its highest speed. As the drum slows down during the latter part of its stroke the force required to bring it to rest is subtracted from the tension of the spring, and the pull on the cord is decreased and its length diminishes. The effect of this action is to lengthen the diagram at both ends. During the return-stroke the sequence of events is repeated in reversed order. At the beginning of the stroke the drum is started by the spring, and the pull on the cord is reduced; at the middle of the stroke the cord attains its normal length; at the end of the stroke the drum is brought to rest by an additional pull on the cord.

The action just described is well illustrated by diagrams taken at regular intervals from an engine as it starts from rest and comes up to a high speed, provided, of course, that a long cord is used. At first the diagrams are notably short on account of the varying tension of the drum spring, as stated in the preceding section. As the speed of the engine increases the inertia of the paper-drum lengthens the diagram till it attains its normal length, and at high speed it may show a notable excess of length.

If the engine had a slotted crosshead instead of a connecting-rod, the force required to give velocity to the drum would vary uniformly from the middle to the end of the stroke, and the cord would stretch and contract uniformly so that the only effect of the inertia of the drum would be to change the length of the diagram, but not to change its form. A diagram from an engine with a connecting-rod will suffer distortion from the effect of the inertia of the paper-drum, which distortion will be larger as the speed increases, and will increase with the length of the cord. The conclusion is that a long cord is to be avoided especially for a high-speed engine. The effect of inertia may be reduced by using a smaller and a lighter drum, as is sometimes done for high-speed engines.

Some indicator-makers purposely use a short drum spring with the idea that its increasing tension will compensate for the effect of inertia. But

the compensation cannot be exact, and to be of use would require adjustment for varying speeds, which would be troublesome, if not practically impossible.

Friction of the Paper-drum.—The most serious error of the paper drum when a long cord is used is

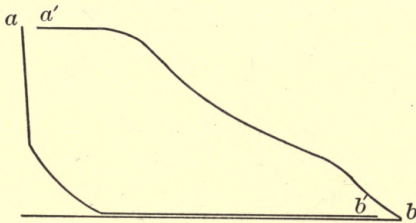

FIG. 37.

due to friction, which depends on the condition of the bearing surfaces. Consequently if a long cord is unavoidable the bearing surfaces should be carefully cleaned and oiled to avoid friction.

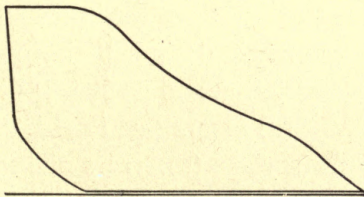

FIG. 38.

If there is appreciable friction of the drum, then, with a long cord, the drum will pause at the beginning of a stroke till the tension of the cord is in-

creased enough to overcome the friction and start the drum. On the return-stroke there will be a similar pause till the pull of the cord is reduced enough to allow the tension of the spring to start the drum. The effect is to shorten the diagram at both ends and to distort the diagram. If Fig. 37 represents the true indicator diagram the effect of friction and a long cord is equivalent to leaving gaps at aa' and bb' and closing up the two partial diagrams to give an apparently complete diagram as shown by Fig. 38. Like other errors of the paper-drum, this may be eliminated by using a short cord.

In conclusion attention should again be called to the fact that elasticity (i.e., lack of rigidity) of the reducing motion or of its support will have the same effect as elasticity of cord, and that wire can be substituted for cord only when it can be kept taut so that it will not sway back and forth.

Errors affecting the Pencil-motion.—The errors that affect the record of pressures may be distinguished as (1) errors of geometric design of the pencil-motion; (2) errors due to friction and backlash; (3) errors due to pencil-friction; (4) errors due to size of piston; (5) errors due to the spring; (6) errors due to inertia.

A discussion of these several errors is of importance in so far as it may show how they can be reduced, but it is not possible as yet to determine the gross error of an indicator from the sum of the individual errors.

Design of Pencil-motion.—The geometric design of a pencil-motion can be tested by drawing a diagram on an enlarged scale, with extreme positions and a proper number of intermediate positions. The design will usually be found to be imperfect; the pencil does not draw an exactly straight line and the motion of the pencil is not an exact copy (on an enlarged scale) of the motion of the piston; but the imperfections are insignificant compared with other unavoidable errors.

Backlash and Friction.—The backlash and friction of an indicator may be tested as follows: first press the pencil up with the tip of the finger, release it and draw an atmospheric line, then draw another atmospheric line after the pencil has been pressed down. The distance between the atmospheric lines with a good indicator is liable to be from 0.01 to 0.02 of an inch. It is, however, probable that the influence of friction and backlash will be less than the amount thus determined when the indicator is in service, as jar and vibration are likely to diminish their effect.

Pencil-friction.—The pressure of the pencil on the paper should be only enough to give a clear line that can be seen in a good light. The influence of pencil-friction is to make the pencil lag behind its true position. The steam-line is likely to be too low and the back-pressure line too high; the expansion-line will not be as steep as it should be, and the compression-line will be too steep. If there are oscillations in the

diagram due to inertia they may change some of these effects; thus the steam-line may be too high if the pencil falls to it after an oscillation. In general the tendency of pencil-friction is to reduce the area of the diagram. With light pressure the reduction is not large; pressure enough to give a bold diagram may reduce the area from three to five per cent. A heavy pencil-pressure will entirely spoil the diagram.

Error due to Expansion of Piston.—The piston of an indicator is made with an area of one square inch when it is cold and has a slightly larger area on account of expansion when hot. The error from this source may amount to one-half of one per cent.

Error of the Spring.—The pressure of the steam in the cylinder of the engine is weighed by the indicator spring; all other parts of the indicator may be considered as conveniences for recording the indications of the spring. A spring, when used for weighing or measuring force, has certain inherent defects, and further, when used in an indicator, is subjected to unfavorable conditions; all of which require particular attention.

In the first place a spring is slow. For example, if a ten-pound weight is cautiously applied to a good spring balance, the balance is likely to show a trifle less than ten pounds. On the other hand, if there are two weights hung on the balance, a ten-pound weight and a five-pound weight, and if the five-

pound weight is cautiously removed, the balance is likely to show a trifle more than ten pounds. In either case the spring is said to be slow, that is, the true record is not shown immediately. The slowness may be almost entirely overcome by jarring the balance. The spring of an indicator is not likely to show much error from this source in service, as the piston is in almost continuous motion and there are likely to be vibrations transmitted to it from the engine; but careful tests of an indicator spring out of the indicator always show slowness, which must not be misinterpreted.

In the second place a spring gives only coarse indications. This is well illustrated by comparing a spring balance with a platform balance which has knife-edges in good condition. But a spring balance weighing up to 20 pounds will weigh to ounces, which corresponds to about one-third of one per cent. Careful investigations of indicator springs out of the indicator and at ordinary temperatures show that they may be expected to have an accuracy of one-fourth of one per cent. It may be considered that under favorable circumstances a spring is good enough for engineering tests.

Now it is customary to consider that the steam which leaks past the piston of an indicator falls at once to the pressure of the atmosphere and to 212° F., and further to assume that the indicator spring which works in that steam has the same tempera-

ture. To test this assumption a thermometer was placed inside the spring of an indicator and the temperature was observed while the indicator was in communication with the cylinder of a steam-engine. For this purpose the piston-rod and pencil-motion were removed and the thermometer was inserted through the hole for the piston-rod. The thermometer showed a higher temperature than 212° F., and the temperature further increased with the steam-pressure in the cylinder; a series of experiments showed that the temperature indicated by the thermometer corresponded nearly, though not exactly, to the average steam-pressure in the cylinder. Tests on another indicator with a loose piston which gave excessive leakage showed lower temperatures than were found for an indicator which had its piston in normal condition. From these tests it appeared clearly that the temperature of the spring is maintained at a high degree by heat transmitted through the piston and along the barrel of the indicator, and that the effect of steam leaking past the piston is to cool the spring, rather than to heat it.

The investigations of the temperatures to which an indicator spring is exposed are of the greatest importance, because it is well known that springs become weaker at high temperatures. Thus a certain indicator spring which was marked 80 pounds to the inch gave that scale at 100° F.; at 212° F. its real scale was 78 pounds to the inch, and at 300° F. its

scale was hardly 75 pounds to the inch. A certain 60-pound scale was found to be correct at 212° F., but at 300° F. its scale was 58 pounds to the inch. Both springs gave fairly uniform scales for a given temperature, whether hot or cold.

Indicator-makers have long been aware of the influence of heat on the scale of a spring, and have furnished springs for indicating steam-engines, and other springs for air or water pressure. They also test springs in the indicator with the intent that they shall have the proper scale when in use.

The proper conclusion from the experiments on the effect of temperature on the scale of a spring is that the spring should be outside of the barrel of the indicator and so exposed to the air that its temperature would not be much, if any, greater than that of the atmosphere. If springs were so placed they could be rated and tested cold, and the most troublesome source of error could be avoided.

Indicator-testers.—Some device for testing indicators under steam is employed by every reliable indicator-maker, and such devices have been used by steam-engine experts and others. Such an indicator-tester usually consists of a receptacle that can be filled with steam at varying pressures, to which indicators can be attached, as to a steam-engine; there is also provision for measuring the pressure of the steam by a mercury column or by a pressure-gauge. For convenience in testing several indicators at the

same time it is customary to provide an electrical device (much like that shown by Fig. 26 in general principle) for throwing all the pencils of indicators undergoing test onto their cards at the same instant; there is also a device for drawing out the paper-drums at the same time. Evidently the same end could be attained by a mechanical device such that one motion of the hand should apply the pencils to the cards and draw the drum cords; by having enough observers the work can be as well done by hand. There is no difficulty in making either electrical or mechanical devices, and they are convenient if not essential for commercial work; but they do not add to the accuracy or reliability of the fundamental method of testing.

In using such a tester it is customary to raise the steam-pressure in the receptacle by stated amounts, five or ten pounds at a time, and then set in motion the device for drawing the drum cards and applying the pencils. Thus there are drawn a series of straight lines on the cards, which are drawn to represent the several pressures chosen. An atmospheric line is drawn from which the pressures are afterwards measured with the proper scale. At the instant that the pencils are applied to the cards the pressure of steam is read from a mercury column or a pressure-gauge; or in some cases the mercury column is made to close the electrical circuit and work the device for applying the pencils and moving the

drums, when it reaches heights that give the desired pressures. Here again the added complication is to be considered as a convenience, and care must be taken that it does not introduce an additional error.

After a series of tests has been made with rising pressures it is customary to repeat it in inverse order with falling pressures, before removing the cards for measurement. Lines drawn at the same pressures but in inverse order of procedure seldom, if ever, coincide; the lines drawn with decreasing pressures are always the higher. Two atmospheric lines are drawn, one before the series with rising pressure and one after the series with falling pressure. Finally the cards are all removed and measured.

It has been considered that the discrepancy between tests with rising and with falling pressures can be attributed to friction and to the slowness of the spring to respond to a change of pressure; they certainly tend to produce such discrepancy. But the discrepancy is due in larger degree to the varying temperature of the spring. Tests on an experimental indicator which has its spring out of the steam confirm this view. The indicator and spring are heated rapidly by rising steam-pressure, but lose heat slowly by radiation when the pressure falls. Tests made with rising pressures are the more regular, and there is reason for relying on them alone.

All indicator-testers of the sort described have one radical defect, namely, the indicator should be in con-

tinual motion in order to simulate the conditions of service, while the pressure-gauge or the mercury column (more especially the latter) should be at rest when the pressure is read. These conditions are clearly incompatible; it is customary to change pressures rather slowly, since by that means only can the gauge or mercury column be made to work properly. It has been thought that this slow change of pressure and the consequent slow motion of the indicator piston gives rise to excessive friction at the piston, and the discrepancy of tests with rising and with falling pressures has been charged to this action. It is not possible at present to confirm or confute this idea.

An indicator-tester in the laboratory of the Massachusetts Institute of Technology is designed to overcome the difficulty attributed to testers already described. In the first place the indicators are attached to a cylinder to which steam is supplied and from which steam is exhausted by a plain slide-valve. There is no piston in the cylinder, and it is necessary to drive the slide-valve by power. Reservoirs are provided from which steam is supplied to the valve-chest and to which the exhaust may pass; the pressures in these reservoirs can be controlled so that the steam-pressures and exhaust-pressures in the cylinder may be made to vary as desired. It is customary to make the exhaust-pressure five or ten pounds less than the steam-pressure, and to vary both together

so as to maintain this difference. Diagrams are taken as in ordinary service at any desired speed of revolution, and it is seen that the indicator is not affected by excessive friction as charged against other testers. Two mercury columns are employed, one to measure the steam-pressure and the other to measure the back-pressure. Communication between the first mercury column and the cylinder is open only when the slide-valve is wide open, and the second mercury column is in communication with the same cylinder when the slide-valve is closed to the steam and is open for exhaust. There is consequently no difficulty about reading the mercury columns, which remain steady or nearly so. The paper-drum is given only a short motion, and the indicator draws a small rectangular diagram with horizontal lines drawn at known pressures. The error of one line (for example, the steam-line) is chargeable to friction and to error of scale; but the mean error of both lines should be free from error due to friction and should be chargeable to error of scale only. The instrument described lacks conveniences for rapid testing and could not be used commercially; even for laboratory work it has been found troublesome until observers have acquired facility after much practice. It is believed that its principles are correct and that the difficulties in using it can be overcome. The conclusion from tests that have been made shows that springs are liable to an

error of 5 per cent from their rated scales; if a true mean scale of a spring is determined the deviation from that scale is liable to be 2 per cent. Springs are liable to be weak, that is, they record too high pressures and give too large powers for engines indicated.

Effect of Piping.—It is advisable especially with high-speed engines, that the connection from the indicator to the cylinder shall be short and direct. In some cases the indicator cock may be screwed directly into the wall of the cylinder, or a short nipple and coupling may suffice. Commonly an elbow is required to bring the indicator erect; an indicator may, however, be used with the paper-drum horizontal when convenient.

Sometimes the indicator is connected to both ends of the cylinder of a steam-engine so that diagrams may be taken from either end as desired. This involves the use of a pipe leading to each end of the cylinder, with a three-way cock (see Fig. 20) at the middle; the steam on the way to the indicator must make two turns, one at the elbow near the end of the cylinder and one at the three-way cock, and it must traverse a length of pipe depending on the size of the engine. The resistance of the pipe and the turns causes the changes of pressure at the indicator to lag behind the changes in the cylinder. The steam-line will be too low and the back-pressure line too

high; on the other hand the cut-off will be delayed and the expansion-line will be too high.

In addition to the distortions of the diagram just noted, it is liable to be affected by rather unaccountable oscillations. The mean effective pressure of the distorted diagram may be either more or less than the true mean effective pressure. In the first place, lowering the steam-line and raising the back-pressure line tends to reduce the mean effective pressure, while delaying the cut-off and raising the expansion-line tends to increase it. The only direct conclusions from the somewhat discordant tests on the effect of piping on the mean effective pressure are that piping should be avoided, especially on high-speed engines, and that when such piping must be used it should not be less than three-quarter-inch pipe, and inch pipe is somewhat better. Very large engines may have pipe as large as one and a half inches in diameter. All such piping should be wrapped to avoid radiation, especially when exposed to wind, as on a locomotive. Marine engines are habitually indicated in this manner, so that the results, unless for very high-speed engines, are likely to be concordant.

Piping for indicators should be carefully done, using only a little red-lead in making joints, and applying it so that it may not get into the pipe and thence be blown into the indicator.

Mean Effective Pressure.—The diagram from an engine without cut-off or compression and with

ample ports and passages is a rectangle. The width of the diagram measured with the proper scale gives at once the effective pressure on the piston; meaning by the effective pressure, the difference between the steam-pressure during the working-stroke and the back-pressure during the exhaust-stroke. Now the pressure of the steam for a diagram like Fig. 36 varies from point to point, and the mean effective pressure may be determined from the mean width of the diagram.

To determine the mean effective pressure it is convenient to divide the length of the diagram into ten equal parts, as shown by light lines in Fig. 39. The width of these several parts can be measured with the proper scale on lines drawn at the middle of them, as shown by heavy lines in Fig. 39. In pre-

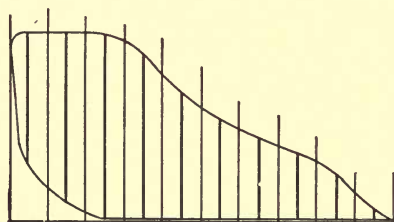

FIG. 39.

paring a diagram for measuring the mean effective pressure a scale of convenient length may be laid across it diagonally so that zero shall come on a vertical line at one end of the diagram, and 100 on the line at the other end, as shown by Fig. 39. Then

draw lines as shown at 5, 15, 25, etc., and on them measure the width of the diagram at ten points, using

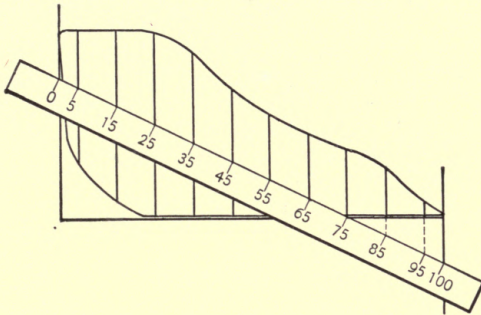

FIG. 40.

the proper scale. The mean effective pressure may be calculated by taking one-tenth of the sum of the ten several widths, as follows:

1st width.....	42
2d "	54
3d "	58
4th "	51
5th "	40
6th "	31
7th "	25
8th "	21
9th "	14
10th "	4
Sum.....	<u>340.5</u>
$\frac{1}{10}$ of sum, m. e. p.....	34 pounds

If desired more or less than ten widths can be taken; for example, twelve widths can be measured and then the mean effective pressure will be $\frac{1}{12}$ of the sum of the twelve several widths.

When a diagram is taken from an engine with a

short cut-off, the expansion-line may run below the back-pressure line, forming a loop, as shown by Fig. 41. On this diagram the steam-pressure is greater

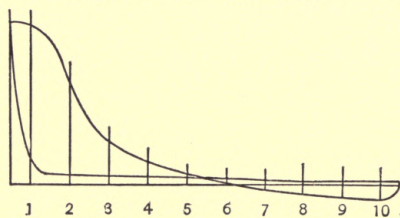

FIG. 41.

than the back-pressure on the first five lines drawn across it. On the lines numbered from 6 to 10 the back-pressure is the greater. Roughly, the steam does work on the piston for the first half of the diagram, while for the second half the piston does work to force the steam out against the pressure of the atmosphere. The mean effective pressure will be calculated by adding the first five widths and by subtracting the last five widths, and then dividing by ten as before; thus:

1st width.....	43.0	
2d "	30.0	
3d "	11.5	
4th "	4.8	
5th "	1.3	
	<hr/>	Sum..... 90.6
6th "	1.0	
7th "	2.8	
8th "	4.0	
9th "	5.0	
10th "	5.4	
	<hr/>	Sum..... 18.2
Difference.....		72.4
$\frac{1}{10}$ difference, m. e. p.....		7.24 pounds

The preceding explanation, while it leads properly to the correct method of calculating mean effective pressure for a diagram with a loop, is not strictly logical, for in reality work is done by the steam on the piston throughout the working-stroke, and the piston does work on the steam to force it out of the cylinder against the pressure of the atmosphere, throughout the exhaust-stroke. Fig. 41 may be

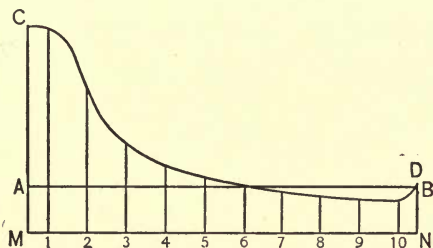

FIG. 42.

separated into two parts, as shown by Figs. 42 and 43.

In Fig. 42 the line *CD* represents the admission and expansion of steam during the working-stroke of the piston. The line *MN*, drawn at 14.7 pounds below the atmospheric line, is called the line of zero pressure, or the absolute vacuum line. Pressures measured from this line give the real pressure of steam; thus at the first line the pressure is 64 pounds, that is, 49.3 pounds above the atmosphere (measured from the atmospheric line), plus 14.7 pounds, equal to 64 pounds. Since the steam in the cylinder of the engine is shut off from the atmos-

phere, its total pressure does not depend on the atmosphere; it must, however, be calculated from the pressure of the atmosphere as shown by a barometer, for both indicators and steam-gauges show the pressure above the pressure of the atmosphere.

In much the same way Fig. 43 shows the exhaust and compression, referred both to the atmospheric line *AB* and the line *MN* of zero pressure.

The work done by the steam on the piston can be calculated from the mean effective pressure of Fig. 42, and the work done by the piston during exhaust may be calculated from Fig. 43, as represented below:

	Fig. 42.	Fig. 43.	Difference.	
1st line.....	64.0	21.0	43.0	
2d "	47.0	17.0	30.0	
3d "	28.3	16.8	11.5	
4th "	21.3	16.5	4.8	
5th "	17.7	16.4	1.3	
			—	90.6
6th "	15.2	16.2	— 1.0	
7th "	13.3	16.1	— 2.8	
8th "	12.0	16.0	— 4.0	
9th "	10.9	15.9	— 5.0	
10th "	10.3	15.7	— 5.4	
	—————	—————	—————	— 18.2
Sum.....	10)240.0	Sum..... 10)167.6	Difference... 10)72.4	
m. e. p....	24.0	m. e. p.... 16.76	m. e. p.... 7.24	
	Resultant m. e. p. 24.0 — 16.76 = 7.24 pounds.			

The column headed Fig. 42 gives the several widths for the corresponding diagram, and the column headed Fig. 43 does the same for its diagram. The resultant m. e. p. obtained by subtracting the

m. e. p. for the second column from the m. e. p. for the first column is the same as that already found from Fig. 41. Under the heading of *Differences* are given the results obtained by subtracting the numbers of the second column from those in the first column. These differences are clearly the widths of Fig. 41 at the corresponding lines; the differences

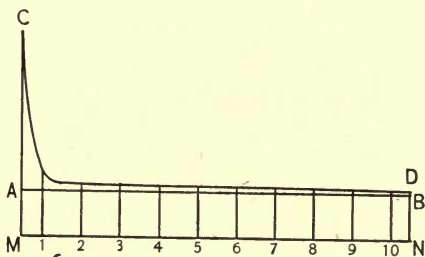

FIG. 43.

are negative for the 6th, 7th, 8th, 9th, and 10th lines corresponding to the widths of the loop for Fig. 41. The calculation at the right hand is evidently a transcript of the calculation for Fig. 41, and would give a correct result whether or not there is a loop, for without a loop there would be no negative differences. Finally it is evident that the subtraction of widths of the loop in the calculation for Fig. 41 is a purely arithmetical operation, due to the fact that the back-pressure happens to be higher than the end of the expansion-line.

It is evident that the mean width of an indicator diagram can be obtained, when the area in square

inches is known, by dividing its area by the length in inches. The area can be conveniently measured by aid of a planimeter, which will now be described.

Amsler Planimeter.—It is customary to determine the mean effective pressure of indicator diagrams from the area of the diagram measured by aid of a planimeter like that represented by Fig. 44. This instrument has two arms, the tracing-arm HF and the guiding-arm HP , hinged together at H . The

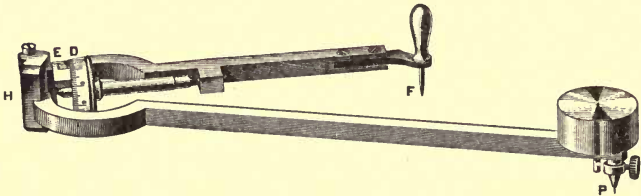

FIG. 44.

guiding-arm has a needle-point at P which serves as a pivot to locate the instrument, and at F is a tracing-point. At D on the tracing-arm is a measuring and recording wheel.

The planimeter is used on a drawing-board or table covered with paper or cardboard so as to give a flat, smooth, unglazed surface for the wheel to roll on. The indicator diagram is pinned down on the table and the planimeter is set as in Fig. 45, so that the tracing-point may be carried around the outline of the diagram without cramping the instrument and without drawing the measuring-wheel over the edge of the card or paper on which the diagram is drawn.

The measuring-wheel is divided into ten parts and subdivided into hundredths. A fixed vernier carries an index and a special scale for finer readings; the use of the vernier will be described later, it being

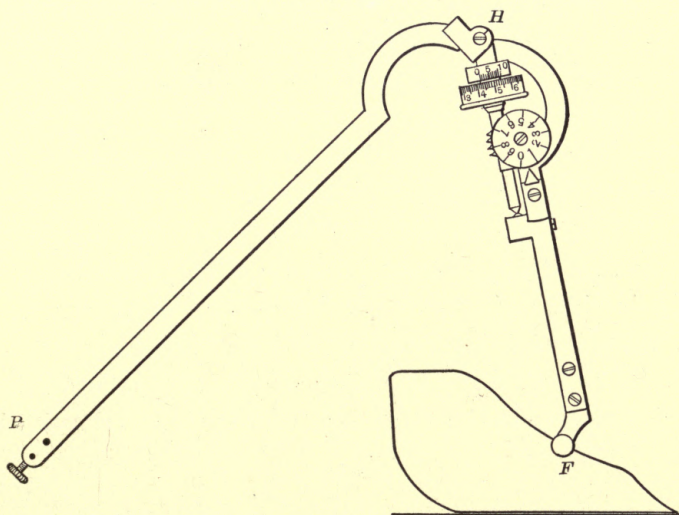

FIG. 45.

sufficient for the present to take account of the fixed index only.

To measure the area of a diagram, locate a convenient point, as F , by a light prick with the point of a needle. Place the tracing-point F of the planimeter at this point, and set the wheel by hand to read zero at the fixed index. Move the tracing-point over the outline of the diagram toward the right, and stop at the point which was located by the

needle-prick. Read the scale of the wheel at the fixed index; the main divisions represent square inches, and the subdivisions represent tenths.

It is very important that the planimeter shall start and stop at the same point; a slight deviation makes a large difference in the reading of the scale on the wheel. It is for this reason that the starting-point is located with a needle; sometimes it may be preferable to mark the starting-point by a pencil-line, in which case greater care is required in starting and stopping. It is also important that the diagram shall be traced exactly; some practice is required to gain skill and rapidity in the use of the planimeter, which is an exact and delicate instrument.

Fig. 46 represents a scale with divisions and subdivisions into tenths, that can be moved past a fixed

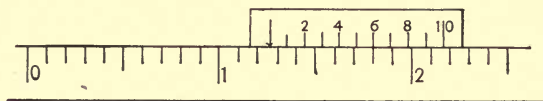

FIG. 46.

index, which in the figure is something beyond the division 1.2 of the scale. The scale of the vernier has ten divisions, but they are shorter than the subdivisions of the main scale; the ten divisions of the vernier occupy the same space as nine divisions of the main scale, and consequently each division of the vernier is one-tenth of a subdivision of the scale shorter than one of the subdivisions of the scale. It

will be noted that the 6th division of the vernier coincides with a subdivision of the scale; the 5th division is consequently $\frac{1}{10}$ of a subdivision of the scale from the adjacent division of the scale, that is to say, it is $\frac{1}{100}$ of a whole division of the scale from that mark; the 4th vernier division is $\frac{2}{100}$ ahead of the adjacent mark; the 3d division is $\frac{3}{100}$; the 2d division is $\frac{4}{100}$; the 1st division is $\frac{5}{100}$; and the index is $\frac{6}{100}$ ahead of the mark on the main scale. The index consequently reads 1.26 of the scale. Therefore we read forward on the scale to the mark before the index, and then forward on the vernier to that division of the vernier which coincides with a mark on the scale.

The planimeter represented by Fig. 44 measures areas in inches and decimals; the large divisions give the number of square inches, the subdivisions give tenths, and hundredths are read on the vernier. This planimeter has a tracing-arm which is four inches long measured from the hinge to the tracing-point, and the circumference of the wheel is two and a half inches; the diameter of the wheel is 0.7957 of an inch. Some planimeters have the same size wheel and have an arm eight inches long; if read as directed for Fig. 44, the readings are to be multiplied by 2 to give the area of a figure in square inches.

Fig. 47 shows a planimeter with an adjustable tracing-arm; when set at the proper length (4 inches)

this instrument gives areas in square inches; it can also be set to read in square feet and in square decimeters. When set to read in square feet one entire revolution of the wheel corresponds to one-tenth of a square foot, and the divisions, subdivisions, and the

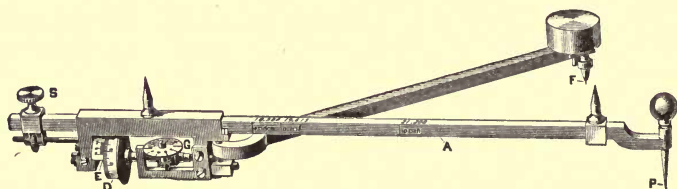
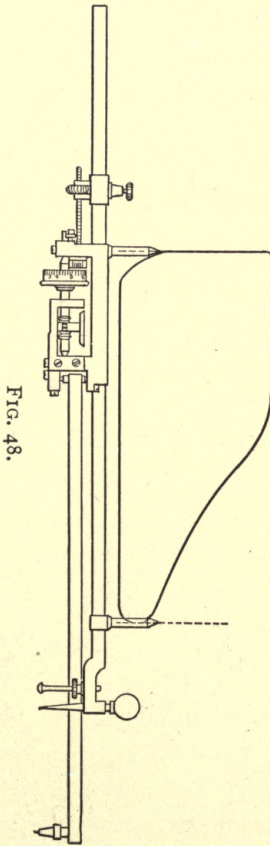

FIG. 47.

vernier give hundredths, thousandths, and ten-thousandths of a square foot; when set for square decimeters one revolution of the wheel corresponds to a square decimeter. If the tracing-arm is made eight inches long, one revolution of the wheel corresponds to 20 square inches.

The back of the tracing-arm carries two points, one on the arm near the tracing-point and one on the slide near the hinge. If the instrument is set as represented by Fig. 48 so that the distance between these points is equal to the length of the indicator diagram, the instrument will give the mean height of the diagram in fortieths of an inch; if the diagram is drawn with a 40 scale the instrument gives the mean effective pressure immediately. In this case one revolution of the wheel corresponds to one hundred, the main divisions of the scale give the tens,

and the subdivisions give the units, while tenths are read on the vernier. If the diagram is drawn with some other scale, then the reading of the instrument



is to be multiplied by the scale of the spring and divided by 40; or an equivalent operation is to be per-

formed. Thus for an 80 scale the readings are to be doubled; for a 50 scale the readings are to be increased by one-fourth; while for a 30 scale they are to be diminished by one-fourth.

To get a conception of the way in which a planimeter measures an area we may proceed as follows. In Fig. 49 let hp represent the tracing-arm of a

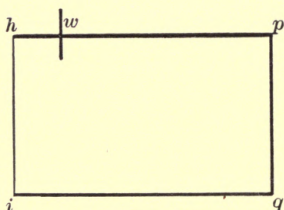

FIG. 49.

planimeter measuring 4 inches from the hinge at h to the tracing-point p . On this arm there is a wheel at w

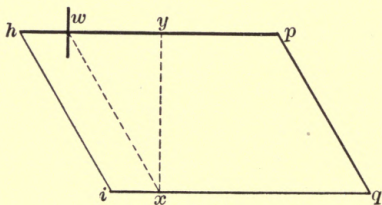

FIG. 50.

which has the circumference of $2\frac{1}{2}$ inches; its diameter is .7957 of an inch. If the arm hp is moved directly down, parallel to itself, the wheel will measure the distance hi that the arm is moved, and if hi is

made equal to $2\frac{1}{2}$ inches the wheel will make one complete revolution. The area of the figure $hpqi$ is $4 \times 2\frac{1}{2} = 10$ square inches, and consequently if the wheel w has its scale divided into ten main divisions each one will correspond to one square inch of area. If the arm hp is kept parallel to itself, as shown

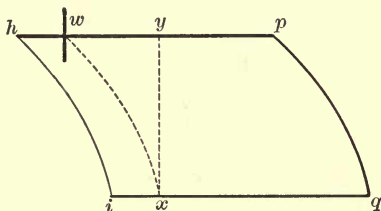

FIG. 51.

in Fig. 50, but moved so that h passes along the inclined line hi , the wheel will roll and slide as it passes from w to x ; it will roll the distance yx and will slide the distance wy . The sliding does not affect the reading of the wheel, but the distance rolled is as before the height of the figure $hpqi$, and its area is again $4 \times 2\frac{1}{2} = 10$ inches after the wheel has rolled one complete revolution. But the same result will be obtained if the point h moves on a curved line hi in Fig. 51, for the area is again $4 \times 2\frac{1}{2} = 10$ inches for one revolution of the wheel. It is evident that the wheel can be placed anywhere on the arm hp , or it may be on an extension of the arm, as in Fig. 52.

In the planimeters shown by Figs. 44 to 48 the hinge is guided by the guiding-arm along the arc of

a circle, but that is only a matter of convenience, and the hinge may be guided along a straight line, as

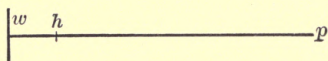

FIG. 52.

shown by Fig. 55, which represents a special form of planimeter.

In Fig. 53 let ab be an arc of a circle on which the hinge of a planimeter is guided by the guiding-arm

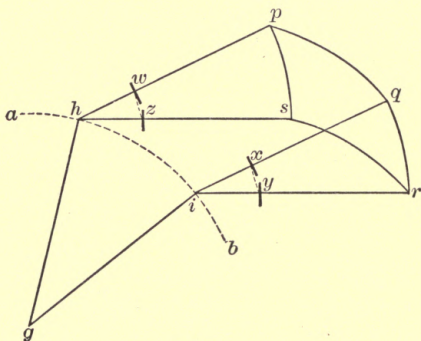

FIG. 53.

hg . If the wheel is set with its index at zero and the tracing-point is carried around the figure $pqrs$, the final reading of the wheel will give the area of the figure. To see that this is true, consider that qi is drawn parallel to hp and that the wheel will record the area of $hpqi$ while the tracing-point moves from p to q ; while the tracing-point moves from q to r

the wheel rolls over the path xy , but this action will be compensated by a reverse operation later; again hs is parallel to ri so that the wheel will record the area of the figure $rshi$ while the tracing-point moves from r to s ; the figure $pqrs$ is completed by moving the tracing-point from s to p , during which the wheel rolls the distance zw , which is equal to xy , and is rolled in the contrary direction so that it just compensates the first action. Now we can get the area of $pqrs$ by adding the areas of $hpqi$ and iqr and subtracting the areas of $rshi$ and hps ; but iqr and hps are equal, consequently the area of $pqrs$ is equal to $hpqi$ minus $hsri$; now the arm hp moves down in passing from p to q and up in passing from rs , so that the wheel adds the area of $hpqi$ and subtracts the area of $hsri$, and consequently the final reading of the wheel gives the area of the figure $pqrs$.

Coming now to an irregular figure, like an indicator diagram, a first approximation to the area can

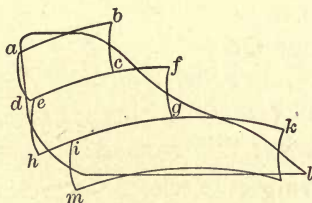

FIG. 54.

be had by replacing the actual diagram by one having the contour $abfklh$. The individual figures

abcd, *efgh*, and *iklm* can be measured and their areas summed up, or the tracing-point of the planimeter can be carried entirely round the figure, omitting the lines *dc* and *ig*, which are common to two individual figures, and which are traced in opposite directions when the figures are traced separately. The narrower and more numerous the individual figures the closer will be the approximation; consequently to get the true area of the indicator diagram it is sufficient to trace its outline as already explained in the description of the instrument.

The planimeter represented by Fig. 44 has an arm which is 4 inches long, and the circumference of its wheel is $2\frac{1}{2}$ inches; consequently one revolution of the wheel corresponds to an area of 10 square inches. The scale of the wheel is divided into ten main divisions, each of which corresponds to one square inch of area. The subdivisions of the wheel and the vernier allow us to read to hundredths of a square inch.

The planimeter shown by Fig. 47 can be set so that its arm is 4 inches long, and as its wheel has a circumference of $2\frac{1}{2}$ inches, the main divisions of its wheel correspond to square inches of area. Another way of considering this matter is to read the whole number of turns of the wheel from a counter which will be seen on the axis of the wheel, and three decimal figures on the scale and vernier, and then multiply by 10 to get the area in square inches. The mark to which the tracing-arm is to be set is lettered

10 sq. in. A planimeter with an arm 8 inches long and a wheel $2\frac{1}{2}$ inches in circumference must have the number of turns of the wheel (and decimals of a turn) multiplied by 20 to give square inches.

Area and Mean Effective Pressure.—To get the mean effective pressure for an indicator diagram, we may (1) measure the area in square inches with a planimeter, (2) divide the area by the length of the diagram in inches to get the mean height, and (3) multiply the mean height by the scale of the spring. It is customary and convenient to change the order of operations, so that the area is multiplied by the scale of the spring, and the product is divided by the length. Thus the diagram Fig. 39 has an area of 1.13 square inches; its length is 2 inches, and, with a scale of 60 pounds to the inch, its mean effective pressure is

$$\frac{\text{Area} \times \text{scale}}{\text{length}} = \frac{1.13 \times 60}{2} = 33.9 \text{ m. e. p.}$$

If a diagram has a loop, as shown by Fig. 41, page 66, the main portion of the diagram is traced by the planimeter moving toward the right, but the loop is traced moving toward the left. The planimeter adds the main portion and subtracts the loop, which is equivalent to subtracting widths of the loop as in the calculation on page 68.

The planimeter shown by Figs. 47 and 48 has two points on the back of the tracing-arm, and the dis-

tance between them is equal to the length of the arm from hinge to tracing-point. As shown by Fig. 48, these points may be adjusted to the length of the indicator diagram, and then the reading of the wheel gives the width of the diagram in fortieths of an inch, each subdivision of the scale of the wheel (hundredths of the circumference) being read as one-fortieth. If the scale of the diagrams is 40 pounds to the inch, the reading of the wheel gives the mean effective pressure directly. To understand the principle of this way of using the planimeter, let us bear in mind that the area corresponding to one turn of the wheel of a planimeter is equal to the length of the arm multiplied by the circumference of the wheel. To get the mean height of a diagram we divide the area by the length of the diagram. If then the length of the arm is made equal to the length of the diagram, the height of a diagram which gives one turn of the wheel will be just equal to the circumference of the wheel (2.5 inches). Since the wheel is divided to hundredths of a turn, each hundredth will correspond to $\frac{2.5}{100} = \frac{1}{40}$ of an inch. Thus we see why this instrument gives mean effective pressure directly for a 40 scale. For any other scale, multiply by the scale and divide by 40.

Coffin Averaging Instrument.—This is a planimeter which has one end of the tracing-arm guided in a straight groove, as shown by Fig. 55. It can be used to measure areas just as the instrument represented

by Fig. 44 is used. Its tracing-wheel is 2.5 inches in circumference, and its arm is six inches long, so that

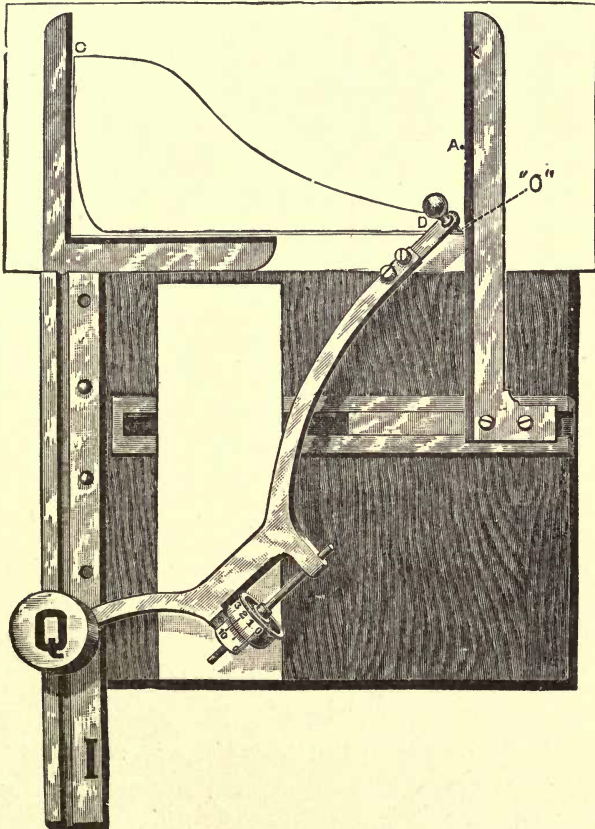

FIG. 55.

one turn of the wheel corresponds to 15 square inches. The scale of the wheel has 15 main divisions, each of which corresponds to one square inch of

area; each main division is subdivided into fifths, so that the subdivisions correspond to two-tenths of an inch; finally the vernier has ten divisions, and enables us to read to two one-hundredths of an inch. This division is not so convenient as that for planimeters described earlier, but the instrument is intended to be used in another way to be explained.

The usual way of determining mean effective pressure is as follows: The diagram to be measured is placed under the fixed clips at the left so that one end comes to the vertical edge, and the atmospheric line (or a convenient line parallel to it) comes to the horizontal edge as shown. The movable clip is brought to the other end of the diagram. The tracing-point D is placed at the end of the diagram near the movable clip, and the groove in which the "hinge," or guided point, moves, if prolonged, would coincide with the other end of the diagram. The wheel is set at zero, and the diagram is traced as usual, stopping at D ; the point D is now slid along the movable clip till the wheel turns back to zero; the distance that the tracing-point is moved in this last operation is equal to the mean height of the diagram, and can be measured with the proper scale. When the contour is traced the wheel records the area of the diagram, and this area, divided by the length of the diagram, gives the mean height Dd , Fig. 56. When the tracing-point is raised from D to d the area of the figure $cdDe$ is subtracted, and this area is equal to that of the figure

$abDb$; consequently the tracing-point will come to d when the reading of the wheel is reduced to zero.

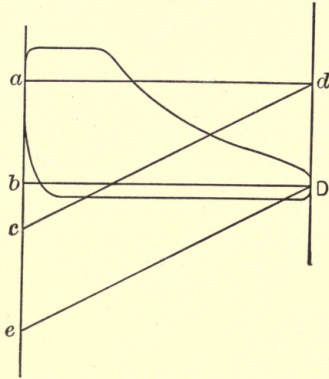

FIG. 56.

The height of the diagram measured with the proper scale gives the mean effective pressure.

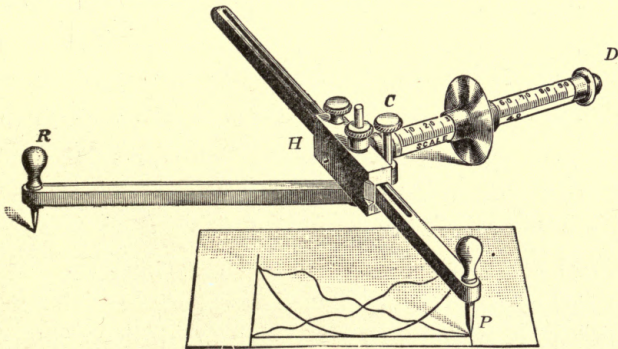

FIG. 57.

Lippincott and Willis Planimeters.—The Lippincott planimeter as shown by Fig. 57 has a tracing-arm

HP , and a guiding-arm RH , hinged at H , and so far resembles the Amsler planimeter; but it has a wheel W on an arm CD which is at right angles with the tracing-arm; the wheel W is free to slide on the arm

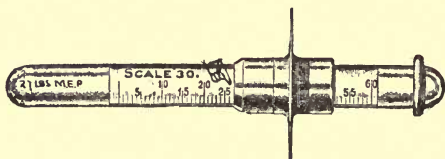

FIG. 58.

CD , but has a sharp edge so that it cannot slide on the paper; the arm CD is a glass tube closed at the ends, as shown more clearly by Fig. 58, and has a paper scale inside on which the area of the diagram or the mean effective pressure can be read.

Fig. 59 shows a modification of this type of planimeter, known as the Willis planimeter, in which the glass tube is replaced by a steel spindle that slides under the rollers R and S and carries the wheel W , which traverses over an enameled scale. The principle is of course just the same; the simpler arrangement will be chosen for discussion.

To understand the action of this instrument, we may, as for the Amsler planimeter, consider the effect of moving the tracing-arm parallel to itself from a position hp , Fig. 60, to a position iq ; clearly the only effect on the wheel is to make it slide on the arm cd a distance equal to hi , the height of the rectangle $hpqi$; perhaps in this case it may seem better to say

that the arm *cd* is drawn through the wheel, which remains a rest, neither rolling nor sliding on the paper. If the arm *hp* is 4 inches long, and the area

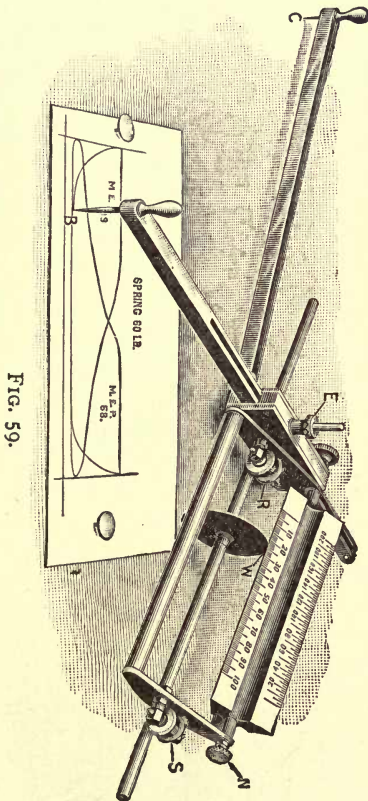

FIG. 59.

of the rectangle *hpqi* is 10 square inches, then the wheel slides $2\frac{1}{2}$ inches on the arm; in this case the scale on the arm *cd* is made $2\frac{1}{2}$ inches long, and is divided into ten parts each of which

corresponds to one square inch of area; the scale is subdivided for tenths of a square inch, and hun-

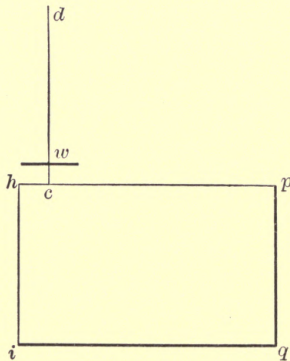

FIG. 60.

dredths, if read, must be estimated, as the instrument has no vernier. In Fig. 61 the wheel rolls from w to

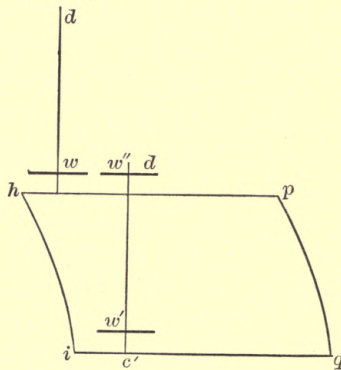

FIG. 61.

w'' , while the arm hp moves to iq , but this rolling does not affect the reading, which is equal to $w'w''$,

that is, the wheel slides on the arm cd a distance equal to the height of the figure $hpqi$, and with a proper scale can be made to measure that area in square inches.

If the arm hp is pivoted about a point as in Fig. 62, the arm cd at any instant will have two motions: (1) it will be drawn endwise through the wheel, and (2)

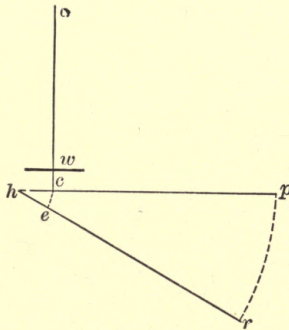

FIG. 62.

it will swing around just as fast as the arm hp does; the first action affects the reading on the scale, and the second, which makes the wheel roll, does not. A little consideration will make it appear that the arm cd is drawn endwise a distance equal to the circular arc ce , as the arm hp swings to hr ; and also that the distance the wheel w slides on the arm cd does not depend on its position on the arm; it is true that the wheel will roll further if it is more remote from c , but that does not affect the reading.

We are now ready to consider a diagram like

$pqrs$, Fig. 63, similar to Fig. 53, page 78. As before, there are four operations to consider: (1) the arm hp moves parallel to itself, and the wheel measures the area $hpqi$; (2) the arm hp swings through the angle qir , and the wheel records the distance fg ; (3) the arm moves parallel to itself, and the wheel measures the area $rihs$; and (4) the arm swings through

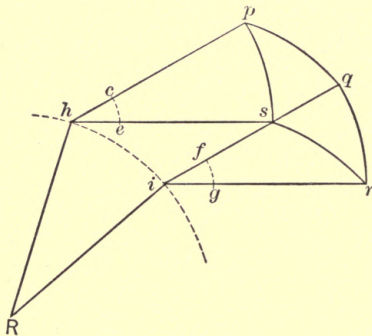

FIG. 63.

the angle shp , and the wheel records the distance ec . But ec is equal to fg and is recorded in the contrary sense, and therefore the pivoting about i and the pivoting about h have finally no influence on the reading. The instrument records the difference between the areas $hpqi$ and $hsri$, because the latter is measured in contrary direction, or is subtracted, which gives the area of the figure $pqsr$. The extension of the action of the instrument from a figure like $pqrs$ to an irregular figure is of course just like that set forth on page 79.

It will be noted now that the arm cd may be placed

anywhere along the arm hp , and that the wheel may have any diameter without affecting the action of the instrument. The wheel should be truly circular or the swinging of the tracing-arm back and forth will not have equal and contrary effects, as is necessary for the proper action of the instrument.

This instrument is commonly used in the manner given on page 74 for the Amsler planimeter, Fig. 47 and Fig. 48; that is, the length of the tracing-arm from the hinge to the tracing-point is made equal to the length of an indicator diagram, and consequently the reading of the planimeter is equal to the mean width of the diagram in inches, or in pounds per inch, depending on the graduation of the paper scale inside the glass tube (Fig. 59) which forms the arm CD of the instrument. Several tubes, with two scales each, are furnished with a planimeter. A scale of inches and tenths can be used for measuring the width of a diagram in inches, or it may be considered to be a scale of ten to the inch for reading mean effective pressures directly; other scales are conveniently arranged for various indicator springs.

Through the hinge of this planimeter there is a style that is retracted by a spring, but it can be thrust down even with the tracing-point by pressing on its head. With this point pressed down the length of the tracing-arm can be conveniently made equal to the length of the diagram when it is desired to determine the mean effective pressure of an indicator dia-

gram. If the area of a diagram is desired, the length of the tracing-arm can be set by direct comparison with a scale of inches; for example, the arm may be made four inches long and a scale of fortieths may be used for measuring areas in square inches, ten fortieths corresponding to one square inch; or the arm may be made five inches long with a scale of fiftieths in the glass tube.

Horse-power of an Engine.—Work is measured mechanically in foot-pounds, and can be calculated by multiplying the force which does the work by the distance through which that force is exerted. Thus, a force of five pounds moved through a distance of ten feet will generate $5 \times 10 = 50$ foot-pounds.

Power is the amount of work done in a unit of time. The unit of power for engineering purposes is 33,000 foot-pounds per minute. Thus, a force of 2500 pounds moving at the rate of 660 feet per minute will generate.

$$660 \times 2500 = 1,650,000 \text{ foot-pounds}$$

per minute, and will develop

$$1,650,000 \div 33,000 = 50 \text{ horse-power.}$$

To find the horse-power of a steam-engine:

- (1) Take indicator diagrams from both ends of the cylinder and determine the mean effective pressure of each separately.
- (2) Ascertain the diameter of the cylinder and of

the piston-rod, and determine the area of the piston and of the section of the piston-rod in square inches. Subtract the area of the piston-rod from the area of the piston to find the net area of the crank side of the piston.

(3) Multiply the area of the piston by the mean effective pressure from the head-end diagram; and multiply the net area of the crank side of the piston by the mean effective pressure from the crank-end diagram; add the two products.

(4) Ascertain the stroke of the piston in feet and multiply by the sum obtained under (3), and by the revolutions of the engine per minute; divide by 33,000, and the final result will be the horse-power of the engine.

To express this as an equation let

p_1 and p_2 be the head-end and crank-end mean effective pressures;

D be the diameter of the cylinder; its area is

$$\frac{3.1416D^2}{4};$$

d be the diameter of the piston-rod; its area is

$$\frac{3.1416d^2}{4};$$

S be the stroke in feet;

R be the revolutions per minute;

$$\left\{ p_1 \times \frac{3.1416D^2}{4} + p_2 \left(\frac{3.1416D^2}{4} - \frac{3.1416d^2}{4} \right) \right\} S \times R \div 33000 = IHP.$$

Here *IHP* stands for indicated horse-power.

Instead of calculating the areas of the piston and piston-rod, it is convenient to take them from Table I of the Appendix.

If the engine has a tail-rod, the area of its section must be subtracted from the area of the piston to get the net area of the head side of the piston.

As an example, we will make the calculation for the horse-power of an engine having the following dimensions:

Diameter of cylinder	16 inches
Diameter of piston-rod	2½ "
Stroke	2 feet
Revolutions per minute	130
Head-end mean effective pressure	59.8 pounds
Crank-end mean effective pressure	59.2 "

The areas of the piston are:

$$\text{Head end, } \frac{3.1416 \times 16^2}{4} = 201.06 \text{ square inches.}$$

$$\text{Crank end, } \frac{3.1416 \times 16^2}{4} - \frac{3.1416 \times 2.5^2}{4} = 196.15 \text{ sq. in.}$$

The horse-power is

$$\{ 59.8 \times 201.06 + 59.2 \times 196.15 \} \times 2 \times 130 \div 33,000 = 186.2.$$

Engine Constant.—For a rough-and-ready calculation the average area of the piston may be multiplied by the average mean effective pressure; this product may now be multiplied by *twice* the stroke in feet and by the revolutions per minute, and the result divided by 33,000. This method applied to the preceding example will give:

Average area of piston,

$$\frac{3.1416 \times 16^2}{4} - \frac{1}{2} \times \frac{3.1416 \times 2.5^2}{4} = 198.6 \text{ square inches;}$$

Average mean effective pressure,

$$\frac{1}{2}(59.8 + 59.2) = 59.5;$$

$$59.5 \times 198.6 \times 2 \times 2 \times 130 \div 33,000 = 186.2.$$

Had the mean effective pressures been more unlike the error would be important.

When this method is used it is customary to unite all the factors except the average mean effective pressure into a constant called the *engine constant*.

The engine constant for the case in hand is

$$198.6 \times 2 \times 2 \times 130 \div 33,000 = 3.13,$$

and the horse-power for the average mean effective pressure given above is

$$59.5 \times 3.131 = 186.2.$$

Piston-displacement.—The piston-displacement of an engine is obtained by multiplying the area of the

piston in square feet (allowing for the piston-rod at the crank end) by the stroke in feet.

For example, the piston-displacement of the engine mentioned above may be found as follows:

Area piston :

$$\text{head end} = 201.06 \div 144 = 1.3965 \text{ square feet ;}$$

$$\text{crank end} = 196.15 \div 144 = 1.3621 \text{ square feet.}$$

Piston-displacement :

$$\text{head end} = 1.3965 \times 2 = 2.7930 \text{ cubic feet ;}$$

$$\text{crank end} = 1.3621 \times 2 = 2.7242 \text{ cubic feet.}$$

The term piston-displacement means the space displaced by the piston; the meaning is most evident for a pump, which should displace or force out a volume of water equal to the piston-displacement for each stroke of the pump-piston, provided that there is no leakage and the valve action is perfect. The configuration of the piston, whether it is flat, conical, or with protruding boss or nuts, does not affect the piston-displacement. A compressed-air engine will take its piston-displacement of air per stroke, provided that its valve gives free passage of air and allows the air to enter till the stroke is completed; if the cut-off for such an engine is at half-stroke, then it will take half of its piston-displacement per stroke. This statement for an air-engine ignores the effect of waste space at the end of the cylinder and the effect of compression. A steam-engine cannot have its steam con-

sumption calculated in so simple a manner because much of the steam admitted is condensed on the walls of the cylinder; during the expansion, and especially during the exhaust, this condensed steam is re-evaporated. A complete understanding of cylinder condensation and its effect on the economy of a steam-engine can be obtained only by an extended study of the thermal theory of the steam-engine, and of tests on steam-engines; an introduction to this interesting subject can be obtained here by making calculations of the indicated steam consumption of a steam-engine.

Clearance.—The waste space in the steam-passage leading to the cylinder, and between the cylinder-head and the piston when the latter is at the end of its stroke, is called the clearance of the engine. This clearance is sometimes given in cubic inches or cubic feet, but is more commonly given as a percentage of the piston-displacement. The clearance here discussed must not be confused with the machinist's clearance, or distance in fraction of an inch, between the piston and the cylinder-head.

If the clearance of the engine discussed above is 0.279 of a cubic foot, it is said to have 10% clearance.

Absolute Pressure.—The indicator shows the pressure in the cylinder of an engine measured from the atmospheric line, or the pressure above the pressure of the atmosphere. A pressure less than that of the atmosphere is commonly called a vacuum; such a

vacuum is measured downwards from the atmosphere in pounds, on an indicator diagram. In much the same way boiler-pressures are measured by steam-gauges above the atmosphere. On the other hand, a vacuum in a condenser is measured by a vacuum gauge, or by a U tube filled with mercury, in inches of mercury.

To convert a pressure (or vacuum) in inches of mercury to pounds, multiply by 0.49. Thus a vacuum of 25 inches corresponds to a pressure of

$$25 \times .49 = 12\frac{1}{4}$$

pounds below the atmosphere.

The pressure of the atmosphere is to be obtained by aid of a barometer. For the greater part of engineering work the pressure of the atmosphere may be taken at 30 inches of mercury, or 14.7 pounds.

The real pressure measured from an absolute vacuum is obtained by adding the pressure by a gauge, or by the indicator, to the pressure of the atmosphere. A pressure measured on an indicator diagram below the atmospheric line is to be subtracted from the pressure of the atmosphere to get the corresponding absolute pressure. And in like manner a vacuum measured by a vacuum gauge is to be reduced to pounds and subtracted from the pressure of the atmosphere to get the absolute pressure.

Absolute pressures are used in all the theoretical

discussions and calculations of steam, vapors, and gases, and in tables of the properties of steam.

Temperature.—For engineering purposes it is customary to measure temperatures by the Fahrenheit scale, which has the freezing-point of water at 32° F. and the boiling-point at 212° F.

Absolute Temperatures.—In computations for air and other gases it is convenient to use absolute temperatures, which are obtained by adding $460^{\circ}.7$ to temperatures on the Fahrenheit scale. For example, the absolute temperature of freezing-point is $32^{\circ} + 460.7 = 492^{\circ}.7$.

Pressures.—It is customary to measure pressures in pounds on the square inch, but for certain calculations it is convenient to take pressures in pounds on the square foot; this gives what is called the specific pressure. The specific pressure is consequently 144 times the pressure in pounds on the square inch.

Density.—The weight of a cubic foot of any substance is called its density. For example, one cubic foot of water at 32° F. weighs 62.4 pounds.

The densities of several gases at 32° F. and at atmospheric pressure are:

Air	0.08070	pounds
Nitrogen	0.07839	“
Oxygen	0.08923	“
Hydrogen	0.005590	“
Carbonic acid	0.1234	“

Specific Volumes.—The volume occupied by one pound of a substance is called the specific volume. It is the reciprocal of the density; that is, it can be calculated by dividing 1 by the density. The specific volumes of ordinary gases are:

Air	12.39	cubic feet
Nitrogen	12.76	“
Oxygen	11.21	“
Hydrogen	178.9	“
Carbonic acid	8.103	“

Properties of Gases.—The following simple equation allows us to calculate the properties of gases:

$$\frac{pv}{T} = \frac{p_0v_0}{T_0},$$

where p , v , and T represent the pressure, volume, and temperature, while p_0 , v_0 , and T_0 are the standard conditions; that is,

p_0 = pressure of the atmosphere;

T_0 = absolute temperature of freezing-point =

492.7;

v_0 = specific volume at p_0 and T_0 .

The use of this equation can be best illustrated by an example. Suppose that air in a certain reservoir or cylinder has a pressure of 92 pounds above the atmosphere and a temperature of 70° F., so that

$$p = 92 + 14.7 = 106.7,$$

$$T = 70 + 460.7 = 530.7,$$

and

$$\frac{106.7 \times v}{530.7} = \frac{14.7 \times 12.39}{492.7}$$

$$\therefore v = \frac{14.7 \times 12.39 \times 530.7}{492.7 \times 106.7} = 1.838 \text{ cubic feet.}$$

The corresponding density or weight per cubic foot is 0.5439 pounds.

Calculated Air-consumption.—If we know the piston-displacement of a compressed-air engine, the air-pressure, and the speed, the amount of air can be calculated with a fair degree of approximation.

It can be shown that a compressed-air engine having a diameter of $13\frac{1}{2}$ inches and a stroke of 2 feet will develop about 100 horse-power, provided that it makes 150 revolutions per minute and is supplied with air at 92 pounds pressure by the gauge and at 70° F., the cut-off being at quarter-stroke.

If the diameter of the piston-rod is two inches, the average piston-displacement will be 1.974 cubic feet. If the clearance and compression are neglected the engine will use an average volume of

$$\frac{1}{4} \times 1.974 = .4935 \text{ cubic feet}$$

of air per stroke. The weight of air per stroke (using the result of the preceding problem) will be

$$.4935 \times .5439 = 0.268$$

pounds. The engine makes 150 revolutions per minute, or 2×150 strokes, and consequently will use

$$2 \times 150 \times 0.263 = 80.4$$

pounds per minute, or

$$60 \times 80.4 = 4820$$

pounds per hour; so that the air-consumption per horse-power per hour will be 48.2 pounds, the engine being assumed to develop 100 horse-power. Taking account of compression and clearance will give about one-tenth larger consumption. But since this calculation is put in for sake of illustration, the method of allowing for clearance and compression need not be given at length.

Properties of Steam.—The properties of saturated steam determined by experiments and calculations vary in so complex a manner that it is customary to take them from a table. The Appendix gives a brief table (Table II); more complete and extensive tables, together with tables of properties of other vapors, will be found in various works on thermodynamics or in the author's Tables of Properties of Saturated Steam, etc. The properties are:

- p , the absolute pressure in pounds per square inch;
- t , the temperature in degrees Fahrenheit;
- q , the heat of the liquid, that is, the heat required to raise the temperature of a pound of water from 32° to the temperature t° F.;

h , the total heat, or the heat required to raise a pound of water from 32° to the temperature t° F., and to vaporize it against the corresponding pressure p ;

r , the heat of vaporization, or the heat required to vaporize a pound of water against the pressure p after it has been raised to the temperature t° F.;

v , the volume of one pound of steam;

d , the weight of one cubic foot of steam.

Indicated Steam-consumption.—A calculation is sometimes made of the steam-consumption of an engine by a method like that briefly illustrated above for finding the air-consumption for a compressed-air engine. The actual steam-consumption is often half again as much as the calculated consumption because there is likely to be a considerable weight of water in the cylinder in addition to the steam. This interferes with the direct usefulness of making calculations of steam-consumption from indicator diagrams. Nevertheless such calculations are customary and have certain interesting features. The following example will illustrate the process.

A small Corliss engine in the laboratory of the Massachusetts Institute of Technology has the following dimensions:

Diameter of cylinder	8.12 inches
Diameter of piston-rod	1.5 “
Stroke	2 feet

Piston-displacement: crank end...	0.6791	cubic feet
head end...	0.7016	"
Clearance in per cent of displacement: crank end.	3.72	
head end.	5.42	

A test on this engine gave the following data and results:

Boiler-pressure above the atmosphere ..	71.9	pou n ls
Pressure of atmosphere	14.8	"
Pressure at cut-off: crank end	57.8	"
head end	57.3	"
Pressure at release: crank end	5.9	"
head end	14.2	"
Pressure at compression: crank end	4.1	"
head end	4.0	"
Cut-off: crank end	0.19	of stroke
head end	0.29	"
Release: crank end	0.950	"
head end	0.960	"
Compression: crank end02	"
head end	0.03	"
Mean effective pressure: crank end..	26.92	pounds
head end ..	37.27	"
Revolutions per minute	60.36	

When cut-off occurred at the crank end the piston was 0.19 of the stroke from the beginning, and the volume developed by the piston was

$$0.19 \times 0.6791 = 0.12903$$

of a cubic foot; but the clearance is 3.72 per cent of the piston-displacement, and added the volume

$$0.0372 \times 0.6791 = 0.02526$$

of a cubic foot, giving a total of 0.1526 of a cubic foot to be filled with steam at cut-off. Another way of finding this same quantity is to add the clearance directly to the cut-off, giving for the volume

$$(0.19 + 0.0372)0.6791 = 0.1543 \text{ cubic foot.}$$

The absolute pressure at cut-off is

$$57.8 + 14.8 = 72.6 \text{ pounds.}$$

From the table of properties of steam in the Appendix it appears that one cubic foot of steam at 72.6 pounds pressure weighs 0.1684 of a pound. Consequently the weight of steam in the cylinder at cut-off for the crank end was

$$0.1543 \times 0.1684 = 0.02598 \text{ of a pound.}$$

A similar calculation for the weight of steam at release of the crank end gives for the volume of steam in the cylinder

$$(0.95 + 0.0372) 0.6791 = 0.6705$$

of a cubic foot; at release the absolute pressure is

$$5.9 + 14.8 = 20.7$$

pounds, at which pressure a cubic foot of steam

weighs 0.05188 of a pound, so that the weight of steam at release appears to be

$$0.05188 \times 0.6705 = 0.0348$$

of a pound.

Again, we have for the volume in the cylinder at compression for the crank end

$$(0.02 + 0.0372) 0.6791 = 0.0388$$

of a cubic foot; the absolute pressure at compression is

$$4.1 + 14.8 = 18.9$$

pounds, at which one cubic foot of steam weighs 0.04762 of a pound, so that the steam caught and saved in the cylinder at compression weighs

$$0.0388 \times 0.04762 = 0.0018$$

of a pound.

The same sort of a calculation for the head end gives the following results:

Weight of steam

at cut-off, head end.	0.0405	of a pound
at release	0.0507	“
at compression	0.0028	“

The average for the two ends gives for the steam in the cylinder

at cut-off	0.0332	of a pound
at release	0.0422	“
at compression	0.0023	“

The steam used by this engine during the test was condensed, collected, and weighed; it amounted to 0.0621 of a pound per stroke. Now there is good reason to consider that there is no water in the cylinder at the end of the exhaust, as there is abundant opportunity for evaporation during the exhaust; consequently we may consider that there is nothing but steam in the cylinder at compression. Adding this amount to the steam exhausted from the engine gives

$$0.0621 + 0.0023 = 0.0644 \text{ pounds}$$

for the average weight of steam in the cylinder of the engine before release occurred.

If the steam calculated from the pressure at cut-off is compared with the sum just obtained, it appears that of the substance in the cylinder at cut-off

$$\frac{0.0332}{0.0644} \times 100 = 52 \text{ per cent}$$

is steam and 46 per cent is water. In like manner it appears that there is

$$\frac{0.0422}{0.0644} \times 100 = 66$$

per cent of steam and 34 per cent of water at release.

The proportion of water and steam in the cylinder of an engine either at cut-off or release depends on the size, style, and manner of running the engine. This same engine when developing 4 horse-power with the cut-off at 5 per cent of the stroke showed

only 33 per cent of steam at cut-off; again, when using steam at 58 pounds above the atmosphere and with cut-off at 69 per cent of the stroke, there was 72 per cent of steam at cut-off and 76 at release. Larger engines are likely to show a larger proportion of steam than do small engines; superheating also reduces the amount of water in the cylinder at both cut-off and release; steam-jackets have a similar effect, and, especially when applied to compound engines, may give dry steam at release from the low-pressure cylinder. The study of cylinder condensation and re-evaporation of steam-engines is one of the most interesting subjects for the steam-engineer, but it is much too extensive to be printed here.

Returning to our calculation, it appears that the indicator shows 0.0348 of a pound of steam in the crank end of the cylinder at release, and 0.0018 of a pound at compression. The calculated weight of steam exhausted may be considered to be

$$0.0348 - 0.0018 = 0.0330$$

of a pound. In like manner the head end has 0.0507 of a pound at release and 0.0028 of a pound at compression, so that the calculated exhaust from the head end of the cylinder will be

$$0.0507 - 0.0028 = 0.0479$$

of a pound. The sum of these quantities may be taken for the exhaust per revolution, giving

$$0.0330 + 0.0479 = 0.0810$$

of a pound. The engine made 60.36 revolutions per minute, consequently the steam exhausted per hour was

$$60 \times 60.36 \times 0.0810 = 293$$

pounds. The horse-power calculated from the dimensions of the cylinder and the mean effective pressures is 11.7; so that the calculated steam-consumption per horse-power per hour is

$$293 \div 11.7 = 25$$

pounds. On the other hand, the actual steam-consumption from the weight of steam condensed and weighed in an hour was 37 pounds. It is well to recall what was laid down in the first paragraph of this book, namely, that the indicator shows only the pressure of the steam in the cylinder. The so-called indicated steam-consumption of an engine is likely to be seriously in error because it does not and cannot take account of the water in the cylinder, which at release is liable to be as much as one-third of the working substance in the cylinder. When a test of an engine has been made and the actual steam-consumption has been determined, a calculation of the proportions of steam and water in the cylinder at cut-off and release is instructive, as it gives some idea of the influence of the cylinder walls on the action of the steam. When sufficient observations are taken during a test, it is possible to determine more exactly the influence of the cylinder walls by aid of an analysis proposed by Hirn; thus a test on the engine under consider-

ation when running under nearly the same conditions and developing 11.1 horse-power showed that of the heat supplied to the cylinder by the entering steam 37 per cent was absorbed by the cylinder walls during the admission up to cut-off, that 17 per cent was returned by the walls during expansion, and that 15 per cent was thrown out from the walls during exhaust; the last quantity, called exhaust waste, plays an important part in the discussion of the losses of the steam-engine.

Steam per Horse-power per Hour.—A common way of stating the performance of a steam-engine is to give the steam-consumption in pounds per horse-power per hour. The horse-power is habitually determined by aid of the indicator, which affords the means of calculating the power developed in the cylinder. The steam may be determined by condensing it in a surface condenser and collecting and weighing it; or if the engine is supplied from a boiler, or a battery of boilers, which is used for that purpose only, the feed-water supplied to the boilers can be weighed or measured. In either case the test gives the means of calculating the steam used by the engine per hour, which may be divided by the horse-power to find the steam per horse-power per hour.

This method of stating steam-engine performance is open to criticism because the amount of heat required to evaporate water depends on the temperature of the feed-water supplied to the boiler and on

the pressure under which the steam is evaporated. To exhibit this, consider first the effect of supplying the feed-water to a boiler at 102° F. and evaporating it at 61.3 pounds by the gauge (76 pounds absolute), as compared with supplying feed-water at 212° to the same boiler. Now the heat of the liquid at 102° F. is 70 thermal units, and at 76 pounds pressure the heat of the liquid is 277.8 thermal units, while the heat of vaporization at 76 pounds is 898.2; consequently the heat required to raise water from 100° F. and bring it up to boiling at 76 pounds pressure is

$$277.8 - 70 = 207.8$$

thermal units, and the heat required to heat it and vaporize it is

$$207.8 + 892.2 = 1100$$

thermal units; again, the heat required to raise the water from 212° F. to boiling temperature at 76 pounds is

$$277.8 - 180.8 + 898.2 = 995.2$$

thermal units, the heat of the liquid at 212° F. being 180.8. The difference in this case is about eleven per cent. Again, consider the effect of carrying 135.3 pounds by the gauge (150 absolute) instead of 61.3 pounds by the gauge. The heat of the liquid at 150 pounds absolute is 330, and the heat of vaporization is 861.2, so that the heat required to vaporize one pound of water from 100° F. is

$$330 - 70 + 861.2 = 1121.2,$$

consequently the effect of raising the pressure is about one and a half per cent.

When part of the steam is supplied to the cylinder of an engine and part is used in a steam-jacket from which the condensation is returned directly to the boiler, the inadequacy of reporting steam-consumption in pounds per horse-power per hour is even more marked.

Thermal Unit.—Heat may be measured in British thermal units (B. T. U.); the thermal unit being defined as the heat required to raise one pound of water from 62° F. to 63° F. The properties of saturated steam, such as heat of the liquid, heat of vaporization, and total heat, are given in thermal units.

Thermal Units per Horse-power per Minute.—To avoid the ambiguity of stating engine performance in pounds of steam per horse-power per hour engineers resort to the expedient of using thermal units per horse-power per minute. This method is best presented by an example.

Referring to the calculation of indicated steam-consumption we find that the engine when developing 11.7 horse-power used 37 pounds of steam per horse-power per hour, with a boiler-pressure of 71.9 pounds by the gauge, or, allowing 14.8 pounds for the atmosphere, of 86.7 pounds absolute. With an exhaust feed-water heater the feed-water for a boiler supplying steam to a non-condensing engine may be raised to 212° F. The heat of the liquid at 212° F. is 180.8

B. T. U., the heat of the liquid at 86.7 pounds absolute is 287.3 B. T. U., and the heat of vaporization is 891.2 B. T. U. The heat required to heat the water from 212° F. to a pressure of 86.7 pounds was

$$287.3 - 180.8 = 106.5 \text{ B. T. U.}$$

Now it appeared from a calorimeter test of the steam supplied to the engine that it contained two per cent of water; consequently the heat required to vaporize 0.98 of a pound of steam was

$$0.98 \times 891.2 = 873.4 \text{ B. T. U.}$$

The heat required to form a pound of steam from a pound of water was consequently

$$106.5 + 873.4 = 979.9 \text{ B. T. U.}$$

The engine used 37 pounds of steam per hour or $37 \div 60$ pounds per minute, and consequently it required

$$979.9 \times 37 \div 60 = 604 \text{ B. T. U.}$$

per horse-power per minute.

When an engine has a steam-jacket the steam supplied to the jacket must be determined separately, and the thermal units for the jacket are to be calculated separately and added to the thermal units for the cylinder.

Hyperbola.—It is sometimes interesting to compare the expansion line of an indicator diagram with some regular curve of the same general character. The curve commonly chosen for this purpose is called the rectangular hyperbola; this curve is easily drawn and it agrees fairly well with the expansion line of many large engines of good type. In the design of a new engine it is customary to use the hyperbola for the expansion line in laying out the probable indicator diagram.

The method of drawing the hyperbola is shown by Fig. 64, which represents a diagram taken from the

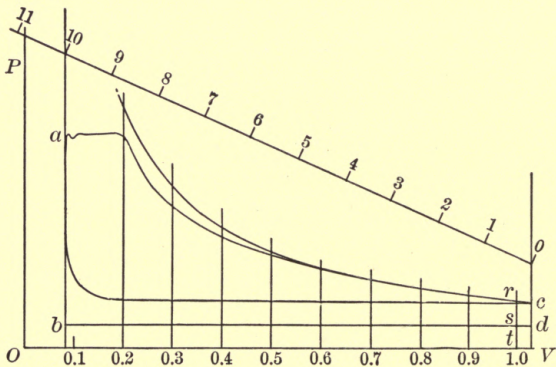

FIG. 64.

high-pressure cylinder of a triple-expansion engine at the Massachusetts Institute of Technology. In the first place the diagram is referred to the axes OP and OV of no volume and no pressure. For this purpose lines

are drawn at ab and cd which are perpendicular to the atmospheric line and which touch the diagram at its ends. Then st is laid off equal to the pressure of the atmosphere (14.7 pounds), and OV is drawn parallel to the atmospheric line. Pressures measured from OV are consequently absolute pressures. From b the distance Ob is laid off equal to the length of the diagram multiplied by the clearance in per cent of the piston-displacement, and OP is drawn perpendicular to OV ; distances measured from OP along the axis OV are proportional to the volumes in the cylinder, including clearance. This construction may be conveniently made by laying a scale across the diagram so that the zero shall come on the line dc produced, and the one hundredth division shall come on the line ba , and then the clearance (.09) can be read directly from the scale beyond the one-hundredth division. Draw a line rs through the point of release; if the release is not well marked a point near release may be chosen at random. Divide the distance Ot into a convenient number of equal parts, ten for example; draw lines at the points thus located and number them as shown. Measure the absolute pressure tr at release; on the diagram the pressure is 30 pounds. To find a point of the curve on a given line divide the pressure at r by the number of the line expressed as a decimal as indicated on the diagram. For example, the pressure on the ninth line is $30 \div 0.9 = 33.3$ pounds. The pressures on the several lines are:

$30 \div 0.9 =$	33.3 pounds
$30 \div 0.8 =$	37.5 "
$30 \div 0.7 =$	42.7 "
$30 \div 0.6 =$	50.0 "
$30 \div 0.5 =$	60.0 "
$30 \div 0.4 =$	75.0 "
$30 \div 0.3 =$	100.0 "
$30 \div 0.2 =$	150.0 "

Sometimes the hyperbola is drawn from a point at or near cut-off as shown by Fig. 65.

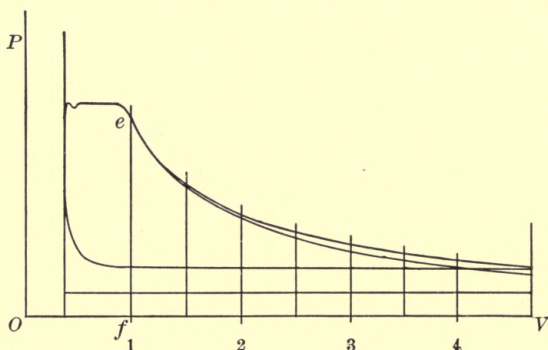

FIG. 65.

In such case after the axes OV and OP are drawn a line, as ef , can be drawn at or near cut-off, and spaces equal to Of can be laid off as shown with half or quarter spaces if necessary. The pressure on any line can be found by dividing the pressure at cut-off by the number of the line expressed as a whole number. For example, the pressure on the ordinate $2\frac{1}{2}$ is

$$\frac{125}{2.5} = 50 \text{ pounds.}$$

The hyperbola drawn on the diagram Fig. 64 from the point of release rises above the expansion-line; small steam-engines are likely to give diagrams on which the hyperbola will rise even higher above the expansion-line; large steam-engines with steam-jackets may give diagrams on which the hyperbola will cut into the expansion line as shown by Fig. 66,

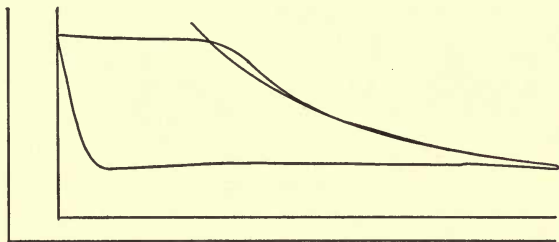

FIG. 66.

which is a diagram taken from a pumping-engine at the Chestnut Hill Station, Boston Water Works.

After the relation of the hyperbola to the expansion-line of the diagram from an engine has been well established some defects of the engine may be inferred from drawing the hyperbola on a diagram which has such a defect. For example, a leak through an admission-valve will tend to keep up the pressure and prevent the expansion-line from falling as rapidly as it should; in such case the hyperbola will rise rapidly away from the expansion-line when drawn from a point at release. If the exhaust-valve leaks a contrary effect will be produced and the expansion-line will fall too rapidly.

Oscillations in Diagrams.—Diagrams taken from an engine with high speed of rotation are likely to be deranged by oscillations of the piston and pencil-motion, as shown by Fig. 67, which was taken from a Porter-Allen engine making 350 revolutions per minute.

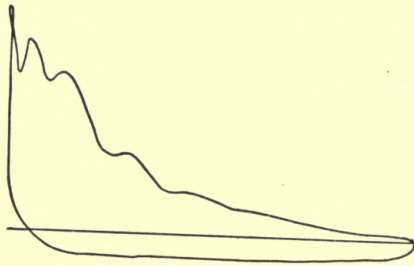

FIG. 67.

On this diagram it is difficult to determine the point of cut-off, and individual measurements of pressure are liable to large errors; the mean effective pressure and the horse-power calculated from it are not likely to be affected by much error on account of the oscillations; all diagrams from very high-speed engines, whether or not they are deranged by oscillations, are liable to have larger errors than diagrams from slow-speed engines.

Piston-friction.—Even if an indicator is in perfect condition when put onto an engine it is likely to become fouled by burnt oil or other material from the cylinder of the engine, which will cause excessive friction of the indicator piston. Fig. 68 shows a dia-

gram which is slightly affected by piston-friction. The steam-line is suspiciously straight, but that alone might not show excessive friction; the successive

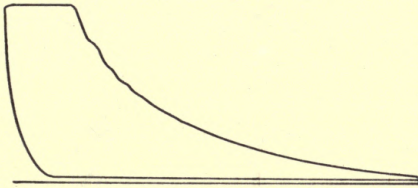

FIG. 68.

steps in the expansion-line are, however, conclusive evidence of friction of the piston. This diagram was taken from a slow-speed engine, so that oscillations are not to be expected.

Fig. 69, which was taken from a locomotive, shows

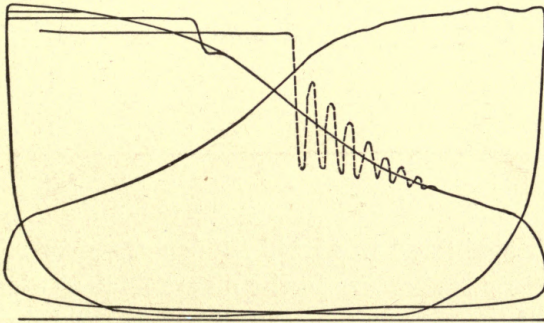

FIG. 69.

an excessive amount of piston-friction. The right-hand diagram is the normal diagram from one end of the cylinder, and the smooth diagram at the left is

the normal diagram from the other end. When the indicator was started the piston came up under the sudden application of pressure, but stuck fast before it had come to the top of the diagram; the pencil then drew a straight line with the piston stuck fast till the fall of pressure during expansion freed the piston suddenly so that it made a number of quick oscillations, during which action the pencil moved so rapidly that it drew a succession of dots instead of a continuous curve; for the next revolution the pencil rose during compression and admission until the piston

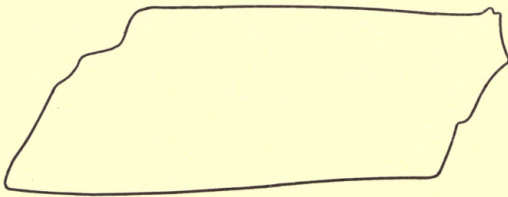

FIG. 70.

stuck again and was freed suddenly, making a characteristic square *step* in the diagram, after which the pencil followed the normal diagram; the succeeding revolution shows only a little sticking after admission, and the fourth revolution gives the normal diagram. Whenever an indicator gives a straight line and a square step it is well to look for friction; for example,

Fig. 70, from a yacht-engine shows piston-friction very plainly.

When diagrams are taken at intervals during a long test, the indicators must be cleaned occasionally to avoid friction. When diagrams are taken in rapid succession, as during speed tests of steamships, it is advisable to keep indicators in reserve ready for immediate use when there is evidence of friction in the indicators attached to the engine.

Valve Setting.—The valves of an engine should always be set mechanically by measurement; after the valves are set it is well to take diagrams to detect errors or defects, if there are any. The indicator diagram may also call attention to improper restrictions of steam pipes or passages, or to obstructions in them.

Figs. 71 and 72 were taken from a slide-valve en-

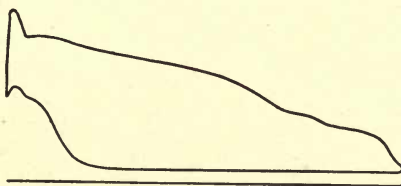

FIG. 71.

gine which was set to give equal cut-off; in such case the lead at the head end is likely to be too small and that at the crank end too large. Fig. 71 from the head end of the cylinder has an admission-line that leans slightly to the right, while the admission-line of Fig. 72 leans toward the left. Fig. 71 shows also a peculiarity of a slide-valve which gives a large com-

pression; the compression-line at first rises rapidly, then its rise is checked, and finally it falls so as to

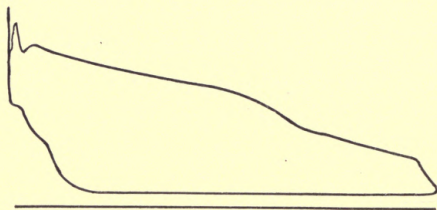

FIG. 72.

form a hook; this action is to be attributed to leakage under the valve to the exhaust-space or past the piston.

Fig. 73, taken from the same engine, shows the effect of slipping the eccentric; the cut-off is de-

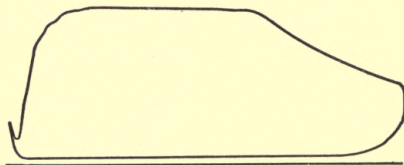

FIG. 73.

layed, the release is late, and the exhaust is defective, especially at the beginning of the return-stroke; the compression has almost disappeared, and admission does not occur till after the piston has started on the forward stroke. Fig. 74 was taken after the eccentric had been given an excessive angular advance, which gave the engine an excessive lead, a short cut-off, and an early release. A notable feature is the oscillation

at admission, which is here spread out instead of being confined as in Fig. 71.

Compound Engines.—With the use of high-pressure steam it has become the practice to use the steam in two or more cylinders successively, as by that means the ill effects of cylinder condensation can be ameliorated. A compound engine has two cylinders, a small cylinder which receives steam from the

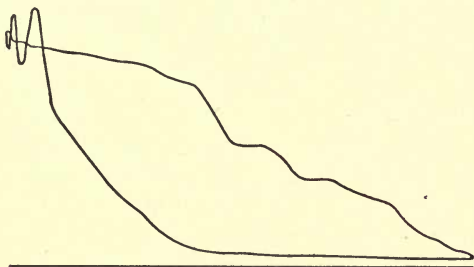

FIG. 74.

boiler, and a large cylinder which takes the steam from the small cylinder and delivers it to the condenser. A triple engine has three successive cylinders, and a quadruple engine has four successive cylinders. Sometimes the large or low-pressure cylinder is divided, or two cylinders are used together in place of the low-pressure cylinder. Many marine engines at the present time have four cylinders, a high-pressure cylinder, an intermediate cylinder, and two low-pressure cylinders.

If a compound or multiple-expansion engine has a large receiver between the successive cylinders, into

which the steam is exhausted by the smaller cylinder and from which steam is supplied to the larger cylinder, then the diagrams look much like those taken from simple engines; if there is but a small space the diagrams may appear to be much distorted.

Diagrams of the first type are given by Figs. 75

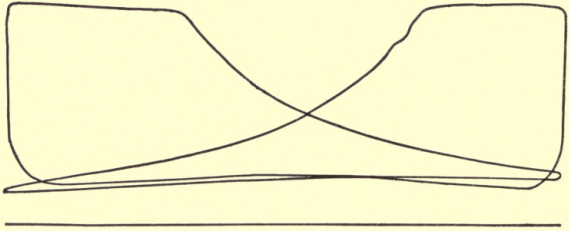

FIG. 75.

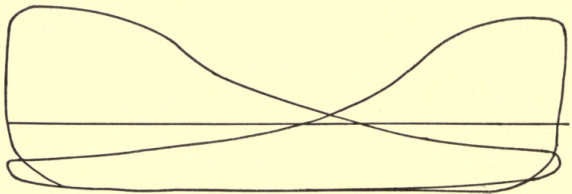

FIG. 76.

and 76, taken from a compound pumping-engine with cranks at right angles and with an intermediate receiver. The back-pressure line of the high-pressure diagram rises a little at the middle of the stroke, corresponding with the admission to the low-pressure cylinders. The low-pressure diagram shows a distinct falling-off in the admission-line at about one fifth stroke, due to the closing of the exhaust-port of the

high-pressure cylinder; from that point to the cut-off at about $\frac{3}{10}$ stroke the low-pressure cylinder draws steam from the receiver with falling pressure. With these exceptions the diagrams resemble those taken from simple engines.

Figs. 77 and 78 give diagrams from a compound pumping-engine at Louisville, Ky., which has the

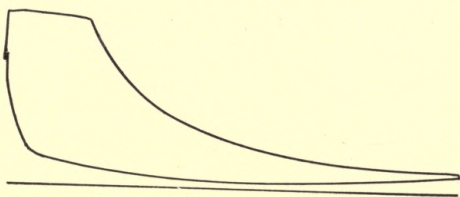

FIG. 77.

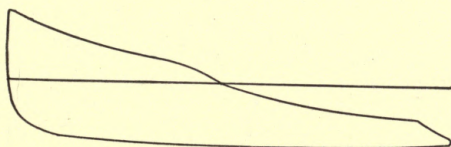

FIG. 78.

high-pressure and low-pressure pistons connected to opposite ends of a short beam, so that one rises while the other falls. Steam is transferred from the upper end of the high-pressure cylinder to the upper end of the low-pressure cylinder through a receiver, and in the same way from the lower end of the small cylinder to the same end of the large cylinder. Admission to the low-pressure cylinder from the beginning of the stroke up to cut-off consists of a direct transfer of steam to it from the high-pressure cylin-

der; the low-pressure piston has four times the area of the high-pressure piston, so that the volume of the steam increases during this transfer and the pressure falls. The back-pressure line of the high-pressure diagram is affected by this fall of pressure until cut-off occurs on the low-pressure cylinder; after that the back-pressure line of the high-pressure diagram

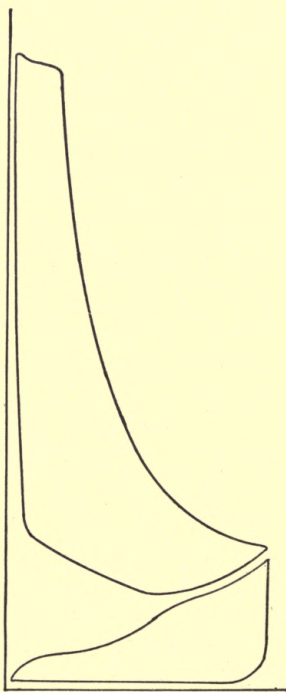

FIG. 79.

rises. The relation of the diagrams during the action just described is made clearer by redrawing the dia-

grams one above the other and with the same scale of pressure as in Fig. 79.

Diagrams from the triple-expansion engine at the Massachusetts Institute of Technology are shown by Figs 80, 81, and 82; this engine has three horizontal

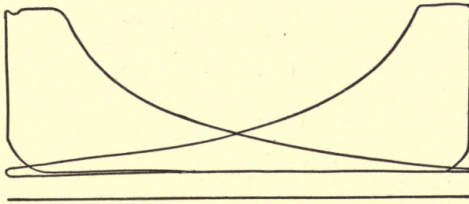

FIG. 80.

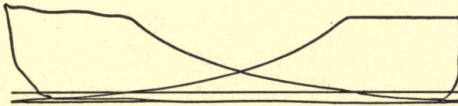

FIG. 81.

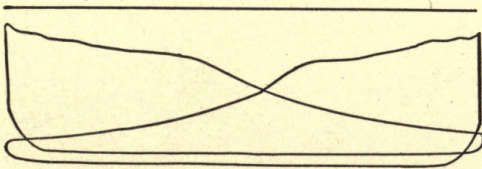

FIG. 82.

cylinders with diameters 9, 16, and 24 inches, and a stroke of 30 inches; all the cylinders are jacketed with steam on the heads and barrels. The back-pressure lines of the high-pressure and intermediate diagrams show some fluctuation of pressure due to the exhaust of steam to receivers, and to the supply of steam from

the receivers to the intermediate and low-pressure cylinders. The steam-lines of the intermediate and low-pressure cylinders are also affected to some extent.

Compound and triple-expansion marine engines commonly have no other receiver-spaces between successive cylinders than is provided by steam-chests and steam-pipes. There are consequently large fluctuations of pressure due to the irregular way in which

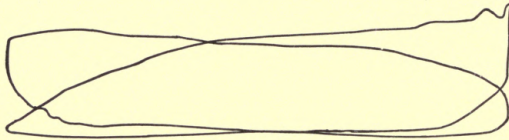

FIG. 83.

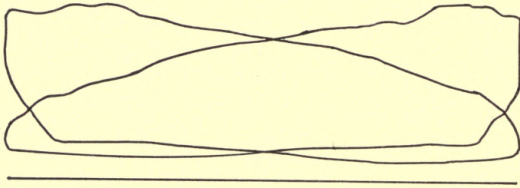

FIG. 84.

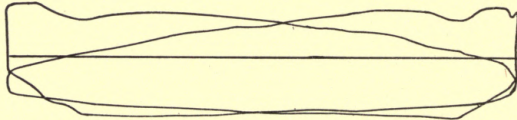

FIG. 85.

steam is exhausted into and drawn from these spaces. Figs. 83, 84 and 85 give diagrams from the U. S. S. *Manning*; the back-pressure lines of the high-pressure

and intermediate diagrams, and the steam-lines of the intermediate and low-pressure diagrams, show considerable irregularity due to the causes named.

Combined Diagrams.—Attempts are sometimes made to get a diagram which will show the combined action of the several cylinders of a compound or multiple-expansion engine. The simplest method of mak-

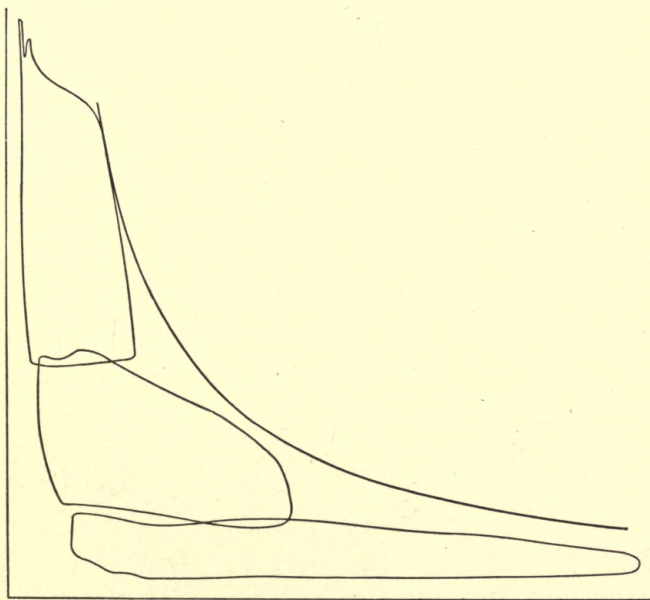

FIG. 86.

ing a combined diagram is shown by Fig. 86, where the diagrams from a triple engine (Figs. 83, 84, and 85) are redrawn, using the same vertical scale and making the horizontal scale proportional to the pis-

ton-displacements of the several cylinders. The diagrams are then referred to axes of zero volume and zero pressure as explained on page 114, Fig. 64; each diagram being drawn separately and with its own clearance. The diagram is completed by drawing a hyperbola through the cut-off of the high-pressure cylinder.

It does not appear that any combined diagram is satisfactory, or that any important lesson can be learned from such a diagram. This may be attributed to the clearances of the cylinders, and to the restriction of the capacity of the receiver-spaces between the cylinders. If one could have an engine without clearances, with very large receiver-spaces, and with cylinders made of non-conducting material, then a logical and useful combined diagram could be drawn; the discussion of such an engine and the drawing of the diagram is properly considered in a treatise on thermodynamics. It may be noted that the discussion includes that of an engine with concordant pistons, like the Louisville engine, and without receiver-spaces. In order that a logical combined diagram may be drawn with clearances it is essential that the clearances and the compressions shall be chosen so that the weight of steam caught at compression shall be the same for all cylinders; this is not done in practice, and there seems to be no good reason for doing so. Again, the transfers of steam from a cylinder to a receiver and from that receiver to the succeeding

cylinder, as, for example, that shown by Figs. 77 and 78 for the Louisville engine, have certain relations which are not shown at all in the combined diagram, or else they are misrepresented. Finally the hyperbola has a doubtful place on any steam-engine diagram, and can have no relation to more than one individual diagram of any combined diagram. Attempts have been made to meet the several objections that have been mentioned to the method here given for combining diagrams from compound engines which have on the whole added to the complexity of the diagram without making it more logical or more useful. Other curves than the hyperbolæ have sometimes been drawn on combined diagrams, such as the adiabatic line which would be drawn by an indicator for expansion in a non-conducting cylinder; such curves, again, increase the labor of drawing the diagram without adding to its usefulness.

Pump Diagrams.—Indicator diagrams are taken from the pump cylinders or pump chambers of pumping-engines to reveal the losses of pressure on the way to and from the pump, to determine the power expended in the pump, and to investigate the action of the pump valves. A discussion of the actions of pumps and their valves is too large a subject to take up here. It will suffice to give a few examples. Fig. 87 gives a diagram taken from the engine at Louisville, and Fig. 88 a diagram from the engine at Chestnut Hill; the former makes 18.5 revolutions per min-

ute, and the second makes 50.5 revolutions per minute. It is but proper to call attention to the fact that

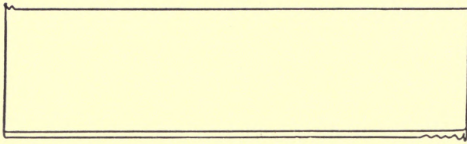

FIG. 87.

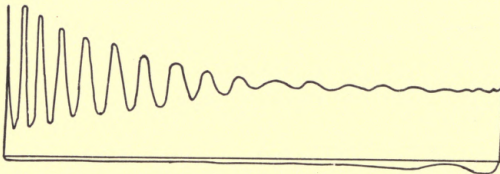

FIG. 88.

while the oscillations in a pump diagram are due to shocks and sudden changes of pressure, they belong

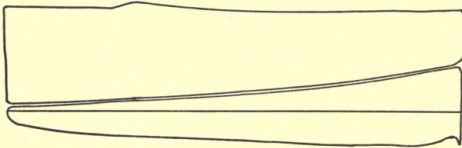

FIG. 89.

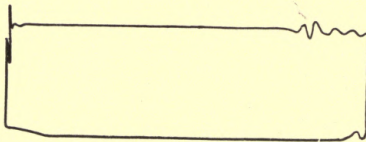

FIG. 90.

rather to the indicator than to the pump, as is also the case with oscillations in a steam-engine diagram.

Direct-acting Pumping-engine.—Figs. 89 and 90 give

diagrams from the steam-cylinders and the pump-cylinder of a compound duplex direct-acting pumping-engine. The diagrams from the high-pressure cylinder and the low-pressure cylinder are superimposed in their proper relation. Steam is supplied to the high-pressure cylinders through the whole forward stroke, and is transferred through a receiver to the low-pressure cylinder through the whole return-stroke. This engine has no fly-wheel and cannot have a cut-off for either cylinder; moreover, there must be a large receiver-space so that the fall of pressure during the transfer of steam from the high-pressure to the low-pressure cylinder shall be moderate. The high-pressure diagram shows a rise of pressure at about quarter-stroke due to the pause which the other engine makes at the end of a stroke before beginning another. Each low-pressure cylinder of the engine has separate steam and exhaust passages, the latter being inside. When the piston nears the end of its stroke it overruns and closes the exhaust-passage, and thus produces a compression to stop the engine at the end of the stroke. The exact compression required is attained by providing a by-pass valve through which the steam caught at compression can leak out; if this valve is closed the engine makes a short stroke; the valve can then be opened to such an extent that the piston shall nearly but not quite strike the cylinder head.

The pump diagram shows a ragged line at the left

end caused by the superposition of oscillations of the indicator-pencil, due to the sudden rise of pressure in the pump chamber when the pump is reversed; there are also oscillations near the right end which are transmitted from the other pump when that engine reverses.

Air-compressor.—A diagram from an air-compressor is represented by Fig. 91; at the beginning of the stroke the air in the clearance-space is expanded down to or a little below the pressure of the atmos-

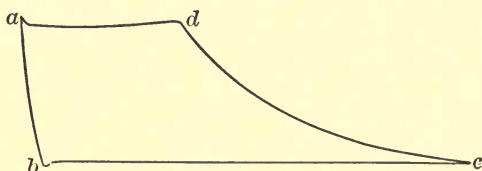

FIG. 91.

phere as represented by ab ; the pressure rises to that of the atmosphere as soon as the admission-valve opens and the cylinder is filled as represented by bc ; the compression is represented by cd ; and from d to a the air is forced into a reservoir, the variations of pressure being due to the action of the delivery-valves. This diagram was taken from the larger cylinder of a compound or two-stage compressor, which compresses air to about 37 pounds above the atmosphere and delivers it to a tubular intercooler. Cold water circulated through the pipes of the intercooler cools the air to the temperature of the atmosphere, with a notable reduction in volume. The cooled air is

drawn in by a smaller cylinder, where it is further compressed to about 95 pounds above the atmosphere. Fig. 92 shows a combined diagram of the diagrams from both the cylinders of this compound compressor, drawn with the same scales of pressure and volume as explained for steam-engines on page 129; the

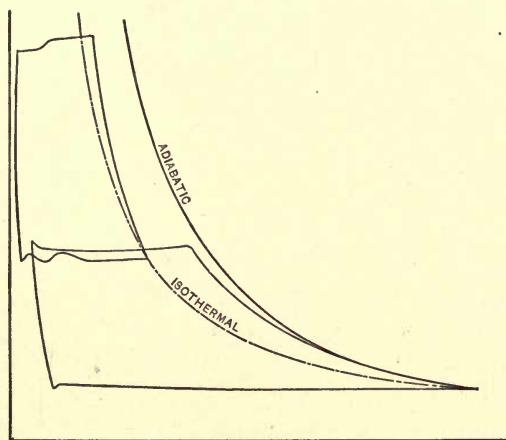

FIG. 92.

objections urged against combined diagrams at that place apply equally here.

On Fig. 92 are drawn two theoretical curves for air, the adiabatic curve, which represents compression in a perfectly non-conducting cylinder, and the isothermal line, which represents compression at a constant temperature; the isothermal line is a rectangular hyperbola for which the construction is given on page 114. The construction of adiabatic and isothermal

curves for air has a real significance because there is no question of the composition of the fluid in the cylinder; the case is quite different from the drawing of a hyperbola on a steam-engine diagram. It is customary to cool the cylinder of a compressor by injecting water into the cylinder or by circulating water through a water-jacket; the effect of the water is mainly to keep the cylinder cool, for the air is cooled but little at ordinary pressures. Three- or four-stage compressors, which deliver air at 1000 to 2000 pounds to the square inch, show an appreciable cooling of the air at high pressures in the small cylinders. Fig. 92 shows that there is but little cooling of the air in the large cylinder, for the compression-line falls only a little below the adiabatic line along which it would lie were there absolutely no cooling. The isothermal line

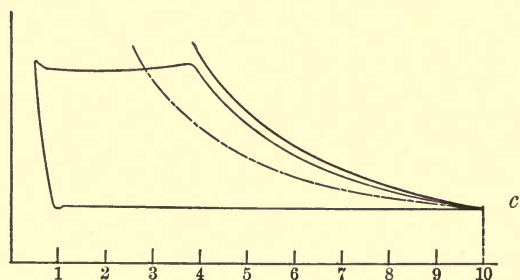

FIG. 93.

passes through the beginning of each diagram, which shows that the intercooler reduces the temperature of the air to that of the atmosphere. To avoid confusion, the adiabatic line for the small cylinder is omitted.

The overlapping of the diagrams exhibits the fact that some pressure is required to force the air through the intercooler into the small cylinder.

The isothermal line can be drawn as explained on page 114, Fig. 64, and shown by Fig. 93, by dividing the space from c to the axis (including the clearance) into a convenient number of equal parts, ten for example. The dividing points may be numbered 0.1, 0.2, 0.3, 0.4, 0.5, 0.6, 0.7, 0.8, and 0.9; on lines drawn through these points we may lay off pressures obtained by dividing the pressure at c by the decimals at the points of division; or the required pressures can be obtained by multiplying the pressure at c by the factors given in the second line of the following table:

TABLE FOR DRAWING ISOTHERMALS AND ADIABATICS OF AIR.

Points	0.2	0.3	0.4	0.5	0.6	0.7	0.8	0.9
Isothermal.	5	3.33	2.5	2.0	1.67	1.43	1.25	1.11
Adiabatic.	9.6	5.43	3.62	2.65	2.05	1.65	1.37	1.16

The points on the adiabatic line may be found by laying off from the points of division pressures found by multiplying the pressure at c by the factors given on the third line of the table; the method of calculating these factors can be deduced from the theoretical investigation of air in any treatise on thermodynamics.

Air-pump.—An air-pump has for its main duty the removal of air from the condenser; this air is brought in by the condensing water of a jet condenser, or else

it leaks in around the piston-rod of the engine or elsewhere; a surface condenser is subject to accumulation of air mainly, if not entirely, by such leakage. A comparison of Fig. 94, taken from an air-pump, with Fig. 91, from an air-compressor, will show the essential similarity between the two machines.

Air and vapor in the clearance of the air-pump are expanded from *a* to *b* till the pressure is somewhat less

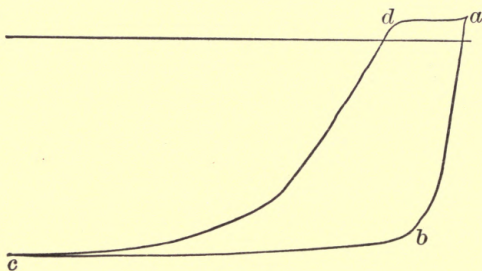

FIG. 94.

than the absolute pressure in the condenser; during this operation there may be some vaporization of water in the air-pump. The pump draws air and wa-

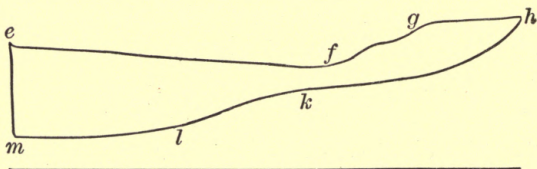

FIG. 95.

ter from the condenser from *b* to *c*; from *c* to *d* the air and any vapor in the pump are compressed up to the pressure of the atmosphere; from *d* to *a* air and water

are forced out through the delivery-valves of the air-pump.

Fig. 95 gives the diagram from the steam-cylinder which drives the air-pump from which Fig. 94 was taken. This air-pump is arranged like a direct-acting steam-pump with the steam-piston and pump piston on one rod and without a fly-wheel. Such an arrangement for a water-pump is good mechanically, because the constant resistance of the pressure of the water requires a constant pressure in the steam-cylinder for smooth running; but the air-pump diagram shows no resistance at the beginning of the stroke; indeed the air in the clearance urges the pump piston forward till the admission-valves open to supply air to the filling end of the pump cylinder. After the pump has made half to three-quarters of its stroke the pressure of the air on the delivering end of the air-pump is raised by compression so that it offers a large resistance; the effect of this action is that the pump and steam pistons jump quickly half or more of their stroke, then they are checked, and complete the stroke slowly. To avoid too great irregularity of action the steam-passages are restricted so that the steam is throttled from *e* to *f* while the pistons jump forward; the steam-pressure rises from *f* to *g*, and the stroke is completed under nearly full steam-pressure from *g* to *h*. During the return-stroke the back-pressure line is raised during the sudden motion of the piston for half or more of the stroke, but when the pistons slow up and com-

plete the stroke quietly the back-pressure line drops as shown by *klm*. In conclusion we see that the steam-cylinder is finally filled at full steam-pressure, and that it exhausts its steam completely, but the effective area is much reduced; from which we recognize that the direct-acting air-pump must use a large amount of steam per horse-power per hour.

Gas-engines.—The explosive or internal-combustion gas-engine is a single-acting engine which makes two revolutions, and four strokes of its piston, for each working impulse. Fig. 96 is a diagram from a

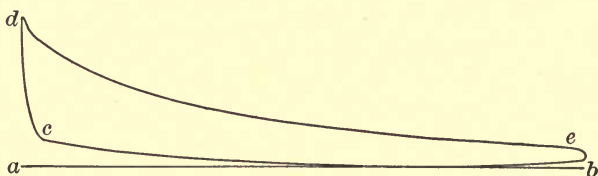

FIG. 96.

35-horse-power gas-engine at the Massachusetts Institute of Technology. The first or filling stroke draws in an explosive mixture of gas and air as represented by *ab*; the second stroke compresses the charge from *b* to *c*, giving a pressure of 60 pounds at *c*; at *c* the charge is ignited by an electric spark, and the pressure rises to 310 pounds at *d*; work is done during the expanding or working stroke, represented by *de*; at *e* release occurs, and the contents of the cylinder are exhausted during the fourth stroke, bringing the diagram to its close at *a*.

Gasoline-engines are explosion engines which are charged with a mixture of air and vapor of gasoline which is made as it is used. Oil-engines use a safe oil like kerosene; as kerosene will not vaporize completely like gasoline, special arrangements are required for spraying it or otherwise mixing it with air.

Deisel Motor.—This engine is an internal-combustion engine which makes four strokes for each impulse, as does the gas-engine. During the filling stroke only atmospheric air is drawn in, and this air is compressed during the second stroke to 500 pounds pressure and is heated to 1000° F. Oil of any character, including heavy petroleum refuse, may be injected into the cyl-

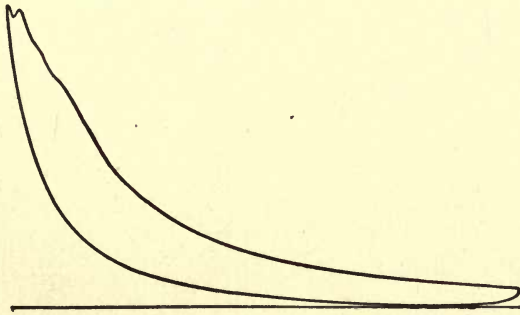

FIG. 97.

inder after the compression is completed, and will burn immediately in the strongly heated air; after the oil has been injected the engine makes its expansion or working stroke. Fig. 97 shows the similarity to the ordinary gas-engine.

Ammonia Refrigerating-machine.—An intense de-

gree of cold can be attained by vaporizing a volatile liquid like ammonia, which boils at -27° F., under the pressure of the atmosphere. In order to use the vapor again it must be compressed, and liquefied at or about the temperature of the atmosphere, by the aid of a stream of cooling water. Fig. 98 shows a diagram from the compression-cylinder of an ammonia refrigerating-machine. From *a* to *b* the pressure falls

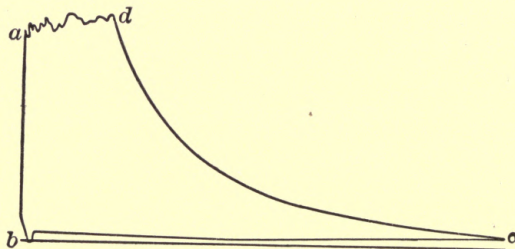

FIG. 98.

until the inlet-valves open, and then the compression-cylinder fills with vapor of ammonia, which comes from the vaporizing coils of pipes, where a low temperature is produced. At the end of the filling stroke *bc* the compression begins, and is carried at *d* to the pressure in the condenser; *da* represents the forcing of the vapor through the delivery-valves into the condenser; the irregularity of the line *da* is due to the fluttering of the valves. The condenser is made of coils of pipe cooled by water, which may flow over the pipes or may circulate among them, ac-

ording to the arrangement of the condenser. The vapor drawn into the compressor cylinder is usually dry, that is, it contains no liquid ammonia. If that is so, the compression-curve agrees nearly with the adiabatic line for superheated or gaseous ammonia. This adiabatic line may be constructed in the same way as the adiabatic line for a perfect gas, as shown by Fig. 93, page 136, except that the multipliers must be taken from the following table:

TABLE FOR ADIABATIC LINE FOR AMMONIA.

Points.....	0.2	0.3	0.4	0.5	0.6	0.7	0.8	0.9
Multipliers.	8.55	4.98	3.39	2.52	1.98	1.61	1.35	1.15

If the engineer in charge of an ammonia compressor has found, by drawing adiabatic lines on diagrams taken when the compressor is in good condition, the proper relation between the compression-line and the corresponding adiabatic line, then he may infer from the application of that line to a given diagram what the condition of the compressor is; he may be able thus to locate leaks in valves or past the piston.

APPENDIX.

TABLES:—AREAS OF CIRCLES—PROPERTIES OF
SATURATED STEAM—HEAT OF THE LIQUID
—LOGARITHMS.

TABLE I.
AREAS OF CIRCLES.

Diam.	Area.	Diam.	Area.	Diam.	Area.	Diam.	Area.	Diam.	Area.
1	.7854	13	132.7	28	615.8	46	1662	76	4537
1 1/8	.9940	13 1/2	137.9	28 1/2	626.8	46 1/2	1698	76 1/2	4596
1 1/4	1.227	14	143.1	29	637.9	47	1735	77	4657
1 1/2	1.485	14 1/2	148.5	29 1/2	649.2	47 1/2	1772	77 1/2	4717
1 3/4	1.767	15	153.9	30	660.5	48	1810	78	4778
2	2.074	15 1/2	159.5	30 1/2	672.0	48 1/2	1847	78 1/2	4840
2 1/4	2.405	16	165.1	31	683.5	49	1886	79	4902
2 1/2	2.761	16 1/2	170.9	31 1/2	695.1	49 1/2	1924	79 1/2	4963
3	3.142	17	176.7	32	706.9	50	1964	80	5027
3 1/4	3.976	17 1/2	182.6	32 1/2	718.7	50 1/2	2003	80 1/2	5090
3 1/2	4.909	18	188.7	33	730.6	51	2043	81	5153
4	5.940	18 1/2	194.8	33 1/2	742.6	51 1/2	2083	81 1/2	5217
4 1/4	7.069	19	201.1	34	754.8	52	2124	82	5281
4 1/2	8.296	19 1/2	207.4	34 1/2	767.0	52 1/2	2165	82 1/2	5346
5	9.621	20	213.8	35	779.3	53	2206	83	5411
5 1/4	11.04	20 1/2	220.4	35 1/2	791.7	53 1/2	2248	83 1/2	5476
5 1/2	12.57	21	227.0	36	804.2	54	2290	84	5542
6	14.19	21 1/2	233.7	36 1/2	816.0	54 1/2	2333	84 1/2	5608
6 1/4	15.90	22	240.5	37	829.6	55	2375	85	5675
6 1/2	17.72	22 1/2	247.5	37 1/2	842.4	55 1/2	2419	85 1/2	5742
7	19.64	23	254.5	38	855.3	56	2463	86	5809
7 1/4	21.65	23 1/2	261.6	38 1/2	868.3	56 1/2	2507	86 1/2	5877
7 1/2	23.75	24	268.8	39	881.4	57	2552	87	5945
8	25.97	24 1/2	276.1	39 1/2	894.6	57 1/2	2597	87 1/2	6013
8 1/4	28.27	25	283.5	40	907.9	58	2642	88	6082
8 1/2	30.68	25 1/2	291.0	40 1/2	921.3	58 1/2	2688	88 1/2	6151
9	33.18	26	298.6	41	934.8	59	2734	89	6221
9 1/4	35.78	26 1/2	306.4	41 1/2	948.4	59 1/2	2781	89 1/2	6291
9 1/2	38.48	27	314.2	42	962.1	60	2827	90	6362
10	41.28	27 1/2	322.1	42 1/2	975.9	60 1/2	2875	90 1/2	6432
10 1/4	44.18	28	330.1	43	989.8	61	2922	91	6504
10 1/2	47.17	28 1/2	338.2	43 1/2	1004	61 1/2	2971	91 1/2	6576
11	50.27	29	346.4	44	1018	62	3019	92	6648
11 1/4	53.46	29 1/2	354.7	44 1/2	1032	62 1/2	3068	92 1/2	6720
11 1/2	56.75	30	363.1	45	1046	63	3117	93	6793
12	60.1	30 1/2	371.5	45 1/2	1061	63 1/2	3167	93 1/2	6866
12 1/4	63.62	31	380.1	46	1075	64	3217	94	6940
12 1/2	67.20	31 1/2	388.8	46 1/2	1090	64 1/2	3268	94 1/2	7014
13	70.88	32	397.6	47	1105	65	3318	95	7088
13 1/4	74.66	32 1/2	406.5	47 1/2	1120	65 1/2	3370	95 1/2	7163
13 1/2	78.54	33	415.5	48	1134	66	3421	96	7238
14	82.52	33 1/2	424.6	48 1/2	1149	66 1/2	3474	96 1/2	7314
14 1/4	86.59	34	433.7	49	1164	67	3526	97	7390
14 1/2	90.76	34 1/2	443.0	49 1/2	1179	67 1/2	3578	97 1/2	7466
15	95.03	35	452.4	50	1195	68	3632	98	7543
15 1/4	99.50	35 1/2	461.9	50 1/2	1210	68 1/2	3685	98 1/2	7620
15 1/2	103.9	36	471.4	51	1225	69	3739	99	7697
16	108.4	36 1/2	481.1	51 1/2	1241	69 1/2	3794	99 1/2	7776
17	113.1	37	490.9	52	1257	70	3848	100	7854
17 1/4	117.9	37 1/2	500.7	52 1/2	1288	70 1/2	3904	101	8011
17 1/2	122.7	38	510.7	53	1320	71	3959	102	8171
18	127.7	38 1/2	520.8	53 1/2	1352	71 1/2	4015	103	8332
19		39	530.9	54	1385	72	4072	104	8495
20		39 1/2	541.2	54 1/2	1418	72 1/2	4128	105	8659
21		40	551.5	55	1452	73	4185	106	8825
22		40 1/2	562.0	55 1/2	1487	73 1/2	4243	107	8992
23		41	572.6	56	1521	74	4301	108	9161
24		41 1/2	583.2	56 1/2	1555	74 1/2	4359	109	9331
25		42	594.0	57	1590	75	4418	110	9503
26		42 1/2	604.8	57 1/2	1626	75 1/2	4477	111	9677

TABLE II.
PROPERTIES OF SATURATED STEAM.

Pressure Pounds per Square Inch.	Temperature Degrees Fahrenheit.	Heat of the Liquid.	Total Heat.	Heat of Vaporization.	Volume in Cubic Feet of One Pound.	Weight in Pounds of One Cubic Foot.	Pressure Pounds per Square Inch.
<i>p</i>	<i>t</i>	<i>q</i>	<i>h</i>	<i>r</i>	<i>v</i>	<i>d</i>	<i>p</i>
1	102	70.0	1113.1	1043.0	334.6	0.00299	1
2	126.3	94.4	1120.5	1026.1	173.6	0.00576	2
3	141.6	109.8	1125.1	1015.3	118.4	0.00844	3
4	153.1	121.4	1128.6	1007.2	90.31	0.01107	4
5	162.3	130.7	1131.5	1000.8	73.22	0.01366	5
6	170.1	138.6	1133.8	995.2	61.67	0.01622	6
7	176.9	145.4	1135.9	990.5	53.37	0.01874	7
8	182.9	151.5	1137.7	986.2	47.07	0.02125	8
9	188.3	156.9	1139.4	982.5	42.13	0.02374	9
10	193.3	161.9	1140.9	979.0	38.16	0.02621	10
11	197.78	166.5	1142.3	975.8	34.88	0.02866	11
12	202.0	170.7	1143.6	972.9	32.14	0.03111	12
13	205.9	174.6	1144.7	970.1	29.82	0.03355	13
14	209.6	178.3	1145.8	967.5	27.79	0.03600	14
14.7	212.0	180.3	1146.6	965.8	26.60	0.03760	14.7
16	216.3	185.1	1147.9	962.8	24.59	0.04067	16
18	222.4	191.3	1149.8	958.5	22.00	0.04547	18
20	228.0	196.9	1151.5	954.6	19.91	0.05023	20
22	233.1	202.0	1153.0	951.0	18.20	0.05495	22
24	237.8	206.8	1154.4	947.6	16.76	0.05966	24
26	240.2	211.2	1155.8	944.6	15.55	0.06432	26
28	246.4	215.4	1157.1	941.7	14.49	0.06899	28
30	250.3	219.4	1158.3	938.9	13.59	0.07360	30
32	254.0	223.1	1159.4	936.3	12.78	0.07820	32
34	257.5	226.7	1160.4	933.7	12.07	0.08280	34
36	260.9	230.0	1161.5	931.5	11.45	0.08736	36
38	264.1	233.3	1162.5	929.2	10.88	0.09191	38
40	267.1	236.4	1163.4	927.0	10.37	0.09644	40
42	270.1	239.3	1164.3	925.0	9.906	0.1009	42
44	272.9	242.2	1165.2	923.0	9.484	0.1054	44
46	275.7	245.0	1166.0	921.0	9.097	0.1099	46
48	278.3	247.6	1166.8	919.2	8.740	0.1144	48
50	280.9	250.2	1167.6	917.4	8.414	0.1188	50
52	283.3	252.7	1168.4	915.7	8.110	0.1233	52
54	285.7	255.1	1169.1	914.0	7.829	0.1277	54
56	288.1	257.5	1169.8	912.3	7.568	0.1321	56
58	290.3	259.7	1170.5	910.8	7.323	0.1366	58
60	292.5	261.9	1171.2	909.3	7.096	0.1409	60
62	294.7	264.1	1171.8	907.7	6.882	0.1453	62
64	296.7	266.2	1172.4	906.2	6.680	0.1497	64
66	298.8	268.3	1173.0	904.7	6.490	0.1541	66
68	300.8	270.3	1173.6	903.3	6.314	0.1584	68
70	302.7	272.2	1174.3	902.1	6.144	0.1628	70
72	304.6	274.1	1174.9	900.8	5.984	0.1671	72
74	306.5	276.0	1175.4	899.4	5.834	0.1714	74
76	308.3	277.8	1176.0	898.2	5.691	0.1757	76
78	310.1	279.6	1176.5	896.9	5.554	0.1801	78
80	311.8	281.4	1177.0	895.6	5.425	0.1843	80
82	313.51	283.2	1177.6	894.4	5.301	0.1886	82

TABLE II.—Continued.

PROPERTIES OF SATURATED STEAM.

Pressure Pounds per Square Inch.	Tempera- ture Degrees Fahren- heit.	Heat of the Liquid.	Total Heat.	Heat of Vaporiza- tion.	Volume in Cubic Feet of One Pound.	Weight in Pounds of One Cubic Foot.	Pressure Pounds per Square Inch.
<i>p</i>	<i>t</i>	<i>q</i>	<i>h</i>	<i>r</i>	<i>v</i>	<i>d</i>	<i>p</i>
85	316.0	285.8	1178.3	892.5	5.125	0.1951	85
90	320.0	290.0	1179.6	880.6	4.858	0.2058	90
95	323.9	294.0	1180.7	886.7	4.619	0.2165	95
100	327.6	297.9	1181.9	884.0	4.403	0.2271	100
105	331.1	301.6	1182.9	881.3	4.206	0.2378	105
110	334.6	305.2	1184.0	878.8	4.026	0.2484	110
115	337.9	308.7	1185.0	876.3	3.862	0.2589	115
120	341.1	312.0	1186.0	874.0	3.711	0.2695	120
125	344.1	315.2	1186.9	871.7	3.572	0.2800	125
130	347.1	318.4	1187.8	869.4	3.444	0.2904	130
135	350.0	321.4	1188.7	867.3	3.323	0.3009	135
140	352.9	324.4	1189.5	865.1	3.212	0.3113	140
145	355.6	327.2	1190.4	863.2	3.107	0.3218	145
150	358.3	330.0	1191.2	861.2	3.011	0.3321	150
155	360.9	332.7	1192.0	859.3	2.919	0.3426	155
160	363.4	335.4	1192.8	857.4	2.833	0.3530	160
165	365.9	338.0	1193.6	855.6	2.751	0.3635	165
170	368.3	340.5	1194.3	853.8	2.676	0.3737	170
175	370.7	343.0	1195.0	852.0	2.603	0.3841	175
180	373.0	345.4	1195.7	849.3	2.535	0.3945	180
185	375.2	347.8	1196.4	848.6	2.470	0.4049	185
190	377.4	350.1	1197.1	847.0	2.408	0.4153	190
195	379.6	352.4	1197.7	845.3	2.349	0.4257	195
200	381.7	354.6	1198.4	843.8	2.294	0.4359	200
205	383.8	356.8	1199.0	842.2	2.241	0.4461	205
210	385.9	358.9	1199.6	840.7	2.190	0.4565	210
215	387.9	361.0	1200.2	839.2	2.142	0.4669	215
220	389.8	363.0	1200.8	837.8	2.096	0.4772	220
225	391.8	365.1	1201.4	836.3	2.051	0.4876	225
230	393.7	367.1	1202.0	834.9	2.009	0.4979	230
235	395.6	369.0	1202.6	833.6	1.968	0.5082	235
240	397.4	371.0	1203.2	832.2	1.928	0.5186	240
245	399.2	372.8	1203.7	830.9	1.891	0.5289	245
250	401.0	374.7	1204.2	829.5	1.854	0.5393	250
255	402.7	376.5	1204.8	828.3	1.819	0.5496	255
260	404.5	378.4	1205.3	826.9	1.785	0.5601	260
265	406.2	380.2	1205.8	825.6	1.753	0.5705	265
270	407.9	381.9	1206.3	824.4	1.722	0.5809	270
275	409.5	383.6	1206.8	823.2	1.691	0.5913	275
280	411.1	385.3	1207.3	822.0	1.662	0.602	280
285	412.7	387.0	1207.8	820.8	1.634	0.612	285
290	414.3	388.6	1208.3	819.7	1.607	0.622	290
295	415.9	390.3	1208.8	818.5	1.583	0.633	295
300	417.4	391.9	1209.3	817.4	1.554	0.644	300
305	418.9	393.5	1209.7	816.2	1.529	0.654	305
310	420.4	395.0	1210.2	815.2	1.505	0.664	310
315	421.9	396.6	1210.6	814.0	1.481	0.675	315
320	423.4	398.1	1211.1	813.0	1.459	0.685	320
325	424.8	399.6	1211.5	811.9	1.437	0.696	325

TABLE III.
HEAT OF THE LIQUID.

Temp. Deg. F. <i>t</i>	Heat of Liquid. <i>q</i>	Temp. Deg. F. <i>t</i>	Heat of Liquid. <i>q</i>	Temp. Deg. F. <i>t</i>	Heat of Liquid. <i>q</i>	Temp. Deg. F. <i>t</i>	Heat of Liquid. <i>q</i>
32	0	78	46.10	124	92.1	170	138.5
33	1.01	79	47.09	125	93.1	171	139.5
34	2.01	80	48.09	126	94.1	172	140.5
35	3.02	81	49.08	127	95.1	173	141.5
36	4.03	82	50.08	128	96.1	174	142.5
37	5.04	83	51.07	129	97.1	175	143.5
38	6.04	84	52.07	130	98.1	176	144.5
39	7.05	85	53.06	131	99.1	177	145.5
40	8.06	86	54.06	132	100.2	178	146.5
41	9.06	87	55.05	133	101.2	179	147.5
42	10.07	88	56.05	134	102.2	180	148.5
43	11.07	89	57.04	135	103.2	181	149.5
44	12.08	90	58.04	136	104.2	182	150.6
45	13.08	91	59.03	137	105.2	183	151.6
46	14.09	92	60.03	138	106.2	184	152.6
47	15.09	93	61.03	139	107.2	185	153.6
48	16.10	94	62.02	140	108.2	186	154.6
49	17.10	95	63.02	141	109.2	187	155.6
50	18.10	96	64.01	142	110.2	188	156.6
51	19.11	97	65.01	143	111.2	189	157.6
52	20.11	98	66.01	144	112.2	190	158.6
53	21.11	99	67.01	145	113.3	191	159.6
54	22.11	100	68.01	146	114.3	192	160.6
55	23.11	101	69.01	147	115.3	193	161.6
56	24.11	102	70.00	148	116.3	194	162.6
57	25.12	103	71.00	149	117.3	195	163.7
58	26.12	104	72.0	150	118.3	196	164.7
59	27.12	105	73.0	151	119.3	197	165.7
60	28.12	106	74.0	152	120.3	198	166.7
61	29.12	107	75.0	153	121.3	199	167.7
62	30.12	108	76.0	154	122.3	200	168.7
63	31.12	109	77.0	155	123.3	201	169.7
64	32.12	110	78.0	156	124.3	202	170.7
65	33.12	111	79.0	157	125.4	203	171.7
66	34.12	112	80.0	158	126.4	204	172.7
67	35.12	113	81.0	159	127.4	205	173.7
68	36.12	114	82.0	160	128.4	206	174.7
69	37.12	115	83.0	161	129.4	207	175.8
70	38.11	116	84.0	162	130.4	208	176.8
71	39.11	117	85.0	163	131.4	209	177.8
72	40.11	118	86.0	164	132.4	210	178.8
73	41.11	119	87.0	165	133.4	211	179.8
74	42.11	120	88.1	166	134.4	212	180.8
75	43.11	121	89.1	167	135.4		
76	44.11	122	90.1	168	136.4		
77	45.10	123	91.1	169	137.4		

TABLE IV.
LOGARITHMS.

Nat. Nos.										Proportional Parts.									
	0	1	2	3	4	5	6	7	8	9	1 2 3			4 5 6			7 8 9		
	10	0000	0043	0086	0128	0170	0212	0253	0294	0334	0374	4	8	12	17	21	25	29	33
11	0414	0453	0492	0531	0569	0607	0645	0682	0719	0755	4	8	11	15	19	23	26	30	34
12	0792	0828	0864	0899	0934	0969	1004	1038	1072	1106	3	7	10	14	17	21	24	28	31
13	1130	1173	1206	1239	1271	1303	1335	1367	1399	1430	3	6	10	13	16	19	23	26	29
14	1461	1492	1523	1553	1584	1614	1644	1673	1703	1732	3	6	9	12	15	18	21	24	27
15	1761	1790	1818	1847	1875	1903	1931	1959	1987	2014	3	6	8	11	14	17	20	22	25
16	2041	2068	2095	2122	2148	2175	2201	2227	2253	2279	3	5	8	11	13	16	18	21	24
17	2304	2330	2355	2380	2405	2430	2455	2480	2504	2529	2	5	7	10	12	15	17	20	22
18	2553	2577	2601	2625	2648	2672	2695	2718	2742	2765	2	5	7	9	12	14	16	19	21
19	2788	2810	2833	2856	2878	2900	2922	2945	2967	2989	2	4	7	9	11	13	16	18	20
20	3010	3032	3054	3075	3096	3118	3139	3160	3181	3201	2	4	6	8	11	13	15	17	19
21	3222	3243	3263	3284	3304	3324	3345	3365	3385	3404	2	4	6	8	10	12	14	16	18
22	3424	3444	3464	3483	3502	3522	3541	3560	3579	3598	2	4	6	8	10	12	14	15	17
23	3617	3636	3655	3674	3692	3711	3729	3747	3766	3784	2	4	6	7	9	11	13	15	17
24	3802	3820	3838	3856	3874	3892	3909	3927	3945	3962	2	4	5	7	9	11	12	14	16
25	3979	3997	4014	4031	4048	4065	4082	4099	4116	4133	2	3	5	7	9	10	12	14	15
26	4150	4166	4183	4200	4216	4232	4249	4265	4281	4298	2	3	5	7	8	10	11	13	15
27	4314	4330	4346	4362	4378	4393	4409	4425	4440	4456	2	3	5	6	8	9	11	13	14
28	4472	4487	4502	4518	4533	4548	4564	4579	4594	4609	2	3	5	6	8	9	11	12	14
29	4624	4639	4654	4669	4683	4698	4713	4728	4742	4757	1	3	4	6	7	9	10	12	13
30	4771	4786	4800	4814	4829	4843	4857	4871	4886	4900	1	3	4	6	7	9	10	11	13
31	4914	4928	4942	4955	4969	4983	4997	5011	5024	5038	1	3	4	6	7	8	10	11	12
32	5051	5065	5079	5092	5105	5119	5132	5145	5159	5172	1	3	4	5	7	8	9	11	12
33	5185	5198	5211	5224	5237	5250	5263	5276	5289	5302	1	3	4	5	6	8	9	10	12
34	5315	5328	5340	5353	5366	5378	5391	5403	5416	5428	1	3	4	5	6	8	9	10	11
35	5441	5453	5465	5478	5490	5502	5514	5527	5539	5551	1	2	4	5	6	7	9	10	11
36	5563	5575	5587	5599	5611	5623	5635	5647	5658	5670	1	2	4	5	6	7	8	10	11
37	5682	5694	5705	5717	5729	5740	5752	5763	5775	5786	1	2	3	5	6	7	8	9	10
38	5798	5809	5821	5832	5843	5855	5866	5877	5888	5899	1	2	3	5	6	7	8	9	10
39	5911	5922	5933	5944	5955	5966	5977	5988	5999	6010	1	2	3	4	5	7	8	9	10
40	6021	6031	6042	6053	6064	6075	6085	6096	6107	6117	1	2	3	4	5	6	8	9	10
41	6128	6138	6149	6160	6170	6180	6191	6201	6212	6222	1	2	3	4	5	6	7	8	9
42	6232	6243	6253	6263	6274	6284	6294	6304	6314	6325	1	2	3	4	5	6	7	8	9
43	6335	6345	6355	6365	6375	6385	6395	6405	6415	6425	1	2	3	4	5	6	7	8	9
44	6435	6444	6454	6464	6474	6484	6493	6503	6513	6522	1	2	3	4	5	6	7	8	9
45	6532	6542	6551	6561	6571	6580	6590	6599	6609	6618	1	2	3	4	5	6	7	8	9
46	6628	6637	6646	6656	6665	6675	6684	6693	6702	6712	1	2	3	4	5	6	7	7	8
47	6721	6730	6739	6749	6758	6767	6776	6785	6794	6803	1	2	3	4	5	5	6	7	8
48	6812	6821	6830	6839	6848	6857	6866	6875	6884	6893	1	2	3	4	4	5	6	7	8
49	6902	6911	6920	6928	6937	6946	6955	6964	6972	6981	1	2	3	4	4	5	6	7	8
50	6990	6998	7007	7016	7024	7033	7042	7050	7059	7067	1	2	3	3	4	5	6	7	8
51	7076	7084	7093	7101	7110	7118	7126	7135	7143	7152	1	2	3	3	4	5	6	7	8
52	7160	7168	7177	7185	7193	7202	7210	7218	7226	7235	1	2	2	3	4	5	6	7	7
53	7243	7251	7259	7267	7275	7284	7292	7300	7308	7316	1	2	2	3	4	5	6	6	7
54	7324	7332	7340	7348	7356	7364	7372	7380	7388	7396	1	2	2	3	4	5	6	6	7

TABLE IV.—Continued.

LOGARITHMS.

Nat. Nos.										Proportional Parts,									
	0	1	2	3	4	5	6	7	8	9	1	2	3	4	5	6	7	8	9
55	7404	7412	7419	7427	7435	7443	7451	7459	7466	7474	1	2	2	3	4	5	5	6	7
56	7482	7490	7497	7505	7513	7520	7528	7536	7543	7551	1	2	2	3	4	5	5	6	7
57	7559	7566	7574	7582	7589	7597	7604	7612	7619	7627	1	2	2	3	4	5	5	6	7
58	7634	7642	7649	7657	7664	7672	7679	7686	7694	7701	1	1	2	3	4	4	5	6	7
59	7709	7716	7723	7731	7738	7745	7752	7760	7767	7774	1	1	2	3	4	4	5	6	7
60	7782	7789	7796	7803	7810	7818	7825	7832	7839	7846	1	1	2	3	4	4	5	6	6
61	7853	7860	7868	7875	7882	7889	7896	7903	7910	7917	1	1	2	3	4	4	5	6	6
62	7924	7931	7938	7945	7952	7959	7966	7973	7980	7987	1	1	2	3	3	4	5	6	6
63	7993	8000	8007	8014	8021	8028	8035	8041	8048	8055	1	1	2	3	3	4	5	5	6
64	8062	8069	8075	8082	8089	8096	8102	8109	8116	8122	1	1	2	3	3	4	5	5	6
65	8129	8136	8142	8149	8156	8162	8169	8176	8182	8189	1	1	2	3	3	4	5	5	6
66	8195	8202	8209	8215	8222	8228	8235	8241	8248	8254	1	1	2	3	3	4	5	5	6
67	8261	8267	8274	8280	8287	8293	8299	8306	8312	8319	1	1	2	3	3	4	5	5	6
68	8325	8331	8338	8344	8351	8357	8363	8370	8376	8382	1	1	2	3	3	4	4	5	6
69	8388	8395	8401	8407	8414	8420	8426	8432	8439	8445	1	1	2	2	3	4	4	5	6
70	8451	8457	8463	8470	8476	8482	8488	8494	8500	8506	1	1	2	2	3	4	4	5	6
71	8513	8519	8525	8531	8537	8543	8549	8555	8561	8567	1	1	2	2	3	4	4	5	5
72	8573	8579	8585	8591	8597	8603	8609	8615	8621	8627	1	1	2	2	3	4	4	5	5
73	8633	8639	8645	8651	8657	8663	8669	8675	8681	8686	1	1	2	2	3	4	4	5	5
74	8692	8698	8704	8710	8716	8722	8727	8733	8739	8745	1	1	2	2	3	4	4	5	5
75	8751	8756	8762	8768	8774	8779	8785	8791	8797	8802	1	1	2	2	3	3	4	4	5
76	8808	8814	8820	8825	8831	8837	8842	8848	8854	8859	1	1	2	2	3	3	4	4	5
77	8865	8871	8876	8882	8887	8893	8899	8904	8910	8915	1	1	2	2	3	3	4	4	5
78	8921	8927	8932	8938	8943	8949	8954	8960	8965	8971	1	1	2	2	3	3	4	4	5
79	8976	8982	8987	8993	8998	9004	9009	9015	9020	9025	1	1	2	2	3	3	4	4	5
80	9031	9036	9042	9047	9053	9058	9063	9069	9074	9079	1	1	2	2	3	3	4	4	5
81	9085	9090	9096	9101	9106	9112	9117	9122	9128	9133	1	1	2	2	3	3	4	4	5
82	9138	9143	9149	9154	9159	9165	9170	9175	9180	9186	1	1	2	2	3	3	4	4	5
83	9191	9196	9201	9206	9212	9217	9222	9227	9232	9238	1	1	2	2	3	3	4	4	5
84	9243	9248	9253	9258	9263	9269	9274	9279	9284	9289	1	1	2	2	3	3	4	4	5
85	9294	9299	9304	9309	9315	9320	9325	9330	9335	9340	1	1	2	2	3	3	4	4	5
86	9345	9350	9355	9360	9365	9370	9375	9380	9385	9390	1	1	2	2	3	3	4	4	5
87	9395	9400	9405	9410	9415	9420	9425	9430	9435	9440	0	1	1	2	2	3	3	4	4
88	9445	9450	9455	9460	9465	9470	9474	9479	9484	9489	0	1	1	2	2	3	3	4	4
89	9494	9499	9504	9509	9513	9518	9523	9528	9533	9538	0	1	1	2	2	3	3	4	4
90	9542	9547	9552	9557	9562	9566	9571	9576	9581	9586	0	1	1	2	2	3	3	4	4
91	9590	9595	9600	9605	9609	9614	9619	9624	9628	9633	0	1	1	2	2	3	3	4	4
92	9638	9643	9647	9652	9657	9661	9666	9671	9675	9680	0	1	1	2	2	3	3	4	4
93	9685	9689	9694	9699	9703	9708	9713	9717	9722	9727	0	1	1	2	2	3	3	4	4
94	9731	9736	9741	9745	9750	9754	9759	9763	9768	9773	0	1	1	2	2	3	3	4	4
95	9777	9782	9786	9791	9795	9800	9805	9809	9814	9818	0	1	1	2	2	3	3	4	4
96	9823	9827	9832	9836	9841	9845	9850	9854	9859	9863	0	1	1	2	2	3	3	4	4
97	9868	9872	9877	9881	9886	9890	9894	9899	9903	9908	0	1	1	2	2	3	3	4	4
98	9912	9917	9921	9926	9930	9934	9939	9943	9948	9952	0	1	1	2	2	3	3	4	4
99	9956	9961	9965	9969	9974	9978	9983	9987	9991	9996	0	1	1	2	2	3	3	4	4

INDEX.

- Air, properties of, 100
Air-compressor, 135
Air-pump, 137
Brumbo pulley, 32
Clearance, 97
Combined diagrams, 128
Compound engines, 123
Cord and knots, 26, 28, 40
Density, 99
Diagrams, oscillations in, 118
Diesel motor, 140
Drum-detent, 28
Electrical attachment, 30
Engine constant, 95
Errors of indicator, 46
Gas-engines, 140
Gases, properties of, 100
Horse-power, 92
Hyperbola, 114
Indicator, Bachelder, 15
 Crosby, 5
 Tabor, 13
 Thompson, 10
 Watt, 1
Indicator, care of, 42
Indicator cock, 20
Indicator diagram, 43
Indicator for gas-engines, 15
Indicator for ordnance, 18
Indicator-tester, 57
Inspection of indicator, 22
Mean effective pressure, 63, 81
Pantagraph, 54
Paper for indicator, 25
Piping, effect of, 62
Piston-friction, 120
Piston-displacement, 95
Planimeter, Amsler, 70
 Coffin, 83
 Lippincott, Willis, 85
Pressure, specific, 99
Pump diagrams, 131
Reducing motions, 32
Reducing wheel, 38
Refrigerating machine, 141
Scale of spring, 42, 54
Steam-consumption, 103
Steam per horse-power, 110
Steam, properties of, 102
Swinging lever, 37
Taking diagrams, 41
Temperature, 99
Thermal unit, 112
Thermal units per horse-power, 112
Three-way cock, 21
Valve-setting, 121
Volume, specific, 100

akt net
pes 4.



THIS BOOK IS DUE ON THE LAST DATE
STAMPED BELOW

AN INITIAL FINE OF 25 CENTS

WILL BE ASSESSED FOR FAILURE TO RETURN
THIS BOOK ON THE DATE DUE. THE PENALTY
WILL INCREASE TO 50 CENTS ON THE FOURTH
DAY AND TO \$1.00 ON THE SEVENTH DAY
OVERDUE.

OCT 26 1933

OCT 19 1936

JAN 3 1946

YB 10737

TJ478
P4.

359958

Peabody

UNIVERSITY OF CALIFORNIA LIBRARY

