



The Boilermakers' journal

International Brotherhood of Boiler Makers,
Iron Ship Builders, and Helpers of America

Soz 1251.2



Harvard College Library

FROM

Massachusetts
State Library

S 001251.2

KANSAS CITY, KAS., JANUARY, 1915.

THE BOILERMAKERS JOURNAL

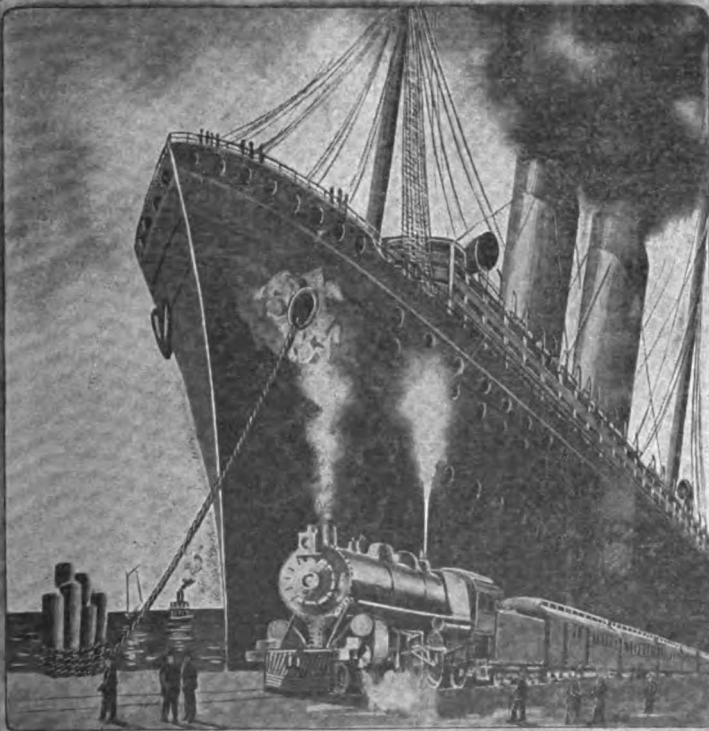

OFFICIAL ORGAN OF THE
INTERNATIONAL BROTHERHOOD
OF BOILERMAKERS, IRON SHIP BUILDERS
AND HELPERS OF AMERICA

2374
8-8

Harvard College Library
July 6, 1916
Gift of
Massachusetts State Library.



"A Smile of Satisfaction with Every Pair"

HEADLIGHT

UNION MADE

OVERALLS

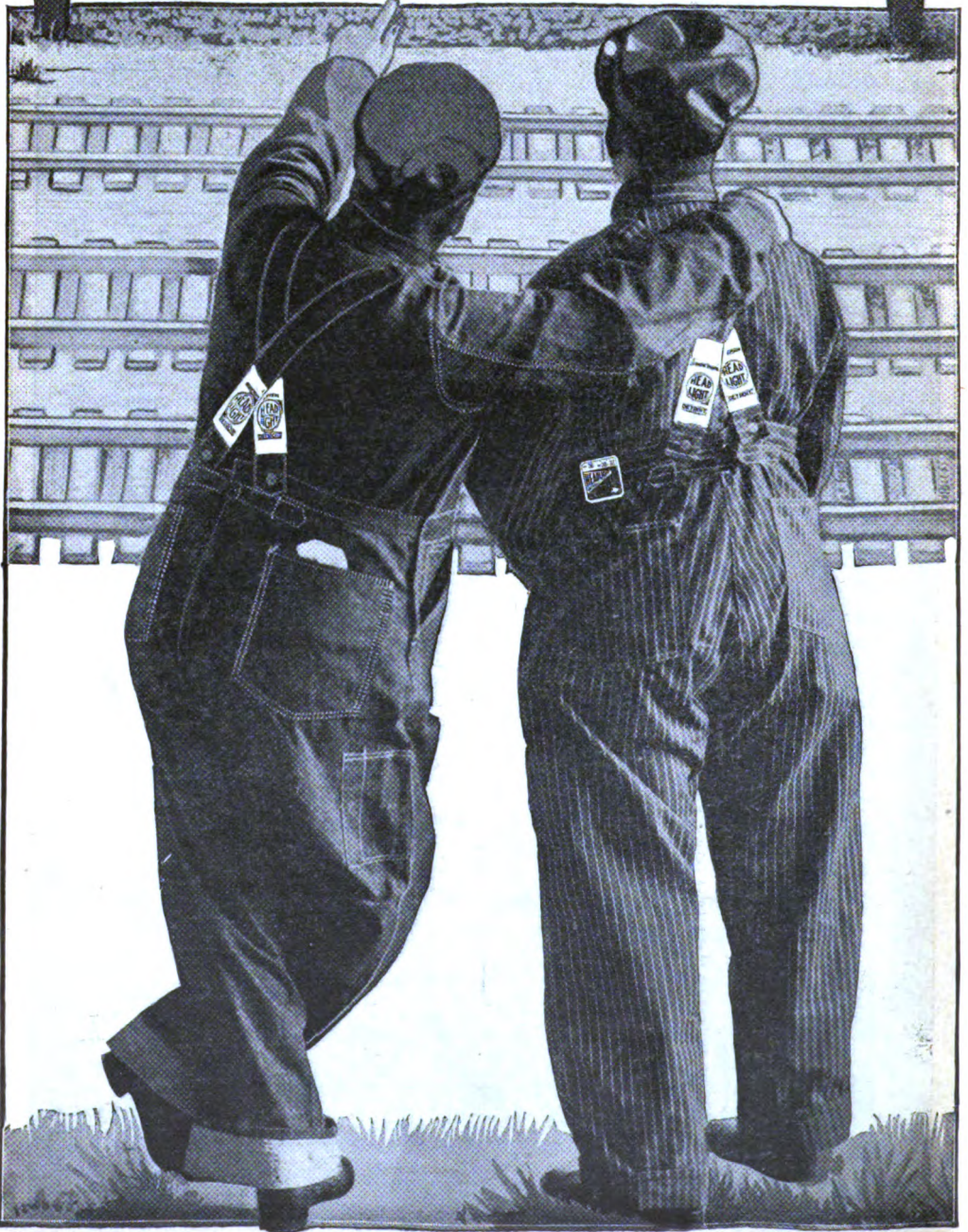
Larned, Carter & Co.
DETROIT, PITHON, ST. LOUIS, SARINA, ONT.



SECURITY SECTIONAL ARCH

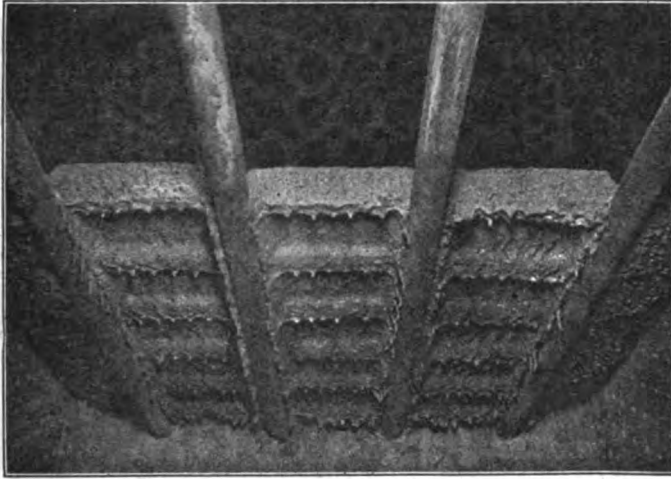

This arch is of light weight
It is built up of small sections
So made as to cool off quickly
It is easily removed for work
Made so to help the boilermaker

AMERICAN ARCH COMPANY

30 CHURCH STREET, NEW YORK

MCCORMICK BUILDING, CHICAGO

Made and worn by three generations.

It's the cloth in your overalls that gives the wear

STIFEL'S INDIGO CLOTH

Standard for over 75 Years



“Never too young to begin a good habit, son. Your father has worn overalls made of STIFEL INDIGO for 25 years. Your grandfather and great-grandfather have worn them from boyhood up. Strength in every fibre, they're true blue all through.

This is the sign of the cloth that wears the longest and is easy to wash and iron



Registered

Look for it on the back of the goods, on the inside of your overalls

CLOTH MANUFACTURED BY

J. L. STIFEL & SONS, Indigo Dyers and Printers

WHEELING, W. VA.

SALES OFFICES

NEW YORK - - - 260-262 Church Street
CHICAGO - - 223 West Jackson Boulevard

SAN FRANCISCO, Postal Telegraph Building
TORONTO - - - - 14 Manchester Building

The Boilermakers' Journal

Official Organ of the
**International Brotherhood of Boilermakers
Iron Ship Builders and Helpers of America**

Vol. XXVII.

KANSAS CITY, KAS., JANUARY, 1915.

No. 1

SPEECH OF HON. FRANK P. WALSH, CHAIRMAN OF U. S. INDUSTRIAL COMMISSION, BEFORE THE A. F. OF L. CONVENTION.

President Gompers introduced to the convention Hon. Frank P. Walsh, Chairman of the Industrial Relations Commission.

Mr. Walsh: Mr. President, Ladies and Gentlemen: Sensible as I am of the fact that the very great compliment implied by this invitation to appear before you today is due to the small part I happen to be paying in a work which I, at least, believe to be very significant to the masses of mankind, not only in this country but in the world; but as I look about this audience, seeing the familiar faces of so many that I have met in this work, and so many that I have had the great privilege of co-operating with in the past, I hope I may be forgiven for believing that there is at least an atom of the personal in the invitation, and thank you from the bottom of my heart therefor.

The institution known as modern industry has an earth-grip in strength unequalled by any other social organization known to the world. Its strength, primarily, consists in the fact that it, of all other bodies, has first-hand access to chemistry and physics, the moving forces of the world, because there is involved the personal fortune of every individual connected with it; not only affecting his board and clothes, but all of the aspirations of his heart, his hopes for freedom, his desire for the mental, moral and social expansion of himself and the children who are to succeed him. And if my work upon this commission has taught me but one thing in regard to the labor movement—aye, I might make it more personal and say, if my contact with your distinguished President and those members selected by your organizations as two of my colleagues upon this commission—it is to give no narrow meaning to that phrase, first declared, so far as my knowledge goes, by the Knights of Labor, and I notice very lately expressed to you by your distinguished chairman, that the injury of one is the concern of all, means, if it means anything, that an injury to the humblest and weakest of God's creatures is the concern of all mankind.

The work we are called upon to do, technically speaking, is to make a study of labor in the principal industries of the United

States; to study the growth and maintenance of organizations of wage earners and employes; to study the systems of collective bargaining now known to the world; to understand, if we possibly can, by investigation, the effect that labor and employers' organizations have upon the public welfare and the rights and powers of the public to deal therewith; and finally, to ascertain, if possible, the causes of industrial dissatisfaction and make recommendations to the Congress of the United States referring thereto.

I might say, my friends, that the first annual report of this commission is now in the hands of the clerk of the House of Representatives, to be released, I hope, upon the first day of the meeting of Congress. In that report you will get the first suggestion of the scope of the work of this commission. You will get, not definite findings, but a free statement of the issues of the contentions between capital and labor, and a tentative finding of some of the great underlying and fundamental ideas from which this great question must be approached, if not settled. In the very heart of that report you will find the question of collective bargaining. If I understand correctly the history of my time it is that idea that has gathered you here today. If I were asked to give an interpretation of collective bargaining I would paraphrase one given by a great student of economics and say that collective bargaining is that machine devised by studious and self-sacrificing men that might make it impossible for the well-fed to drive hard bargains with hungry men.

The significance of the work which we are doing, my friends, I hope will appear patent from that report. When we began the work I made but one pledge, so far as my heart, soul and brain could carry it out, and that was that in this investigation nothing should be held sacred but the truth; and in the recommendations that I hope God will give me the strength to have part in formulating nothing will be cared for except justice.

We have heard the complaint of the employers of this land, voiced by something like 300 men, of everything perhaps open to criticism in the genesis, maintenance and operation of the modern labor union. For the first time in this country we have per-

mitted, in a public way, to have voice given to every complaint and every protest made by labor against the formation of employers' organizations and the carrying on of modern industry. We have endeavored to hold the balance even, and while listening to the criticisms of labor unions we have also given voice to the disinherited of God's creatures, the exploited man; we have allowed to give utterance to the expressions of protest of the exploited woman, and we have endeavored to make articulate the sob of the exploited child in the maelstrom of modern industry.

Of the contribution which you and your fellows have made to this great work I would be less than frank if I did not give some voice to my appreciation of it this morning. If I were called upon today to say what suggestions have been made to give driving force to those questions in industry and economics that vex the nations I should have in frankness to draw away from the expressions of the members of your organization, away from those great fundamental suggestions made which came from the gentleman I see sitting upon this platform this morning, and for significance I would point to the utterance in a very few lines given forth by the President of the Illinois State Federation of Labor, who protested against what he dramatically, forcefully and I believe truthfully called the double standard of morality in modern industry.

The idea that the workman is to be considered a good and moral citizen if he accepts a fair day's wage for a fair day's work—interpreted to mean that he should work at least eight hours, or until he is tired out, for a wage that is sufficient to supply the necessities and none of the luxuries of life—for that he is called moral. In the same industry another human being with the same desires, the same aspiration and the same human nature, deriving everything of his from that same industry, who is called moral and upright, aye, and even great, if he has succeeded in getting all he could out of that industry without any work and without any application—that was one of the striking thoughts given to this commission by a member of your organization, and it was spread broadcast through this land.

If I were asked for another one I would like to picture to you, if I had the power of description, that great woman who appeared before the commission in Los Angeles, Mrs. Noel, who sat in the presence of the commission in a crowded hall and heard one of the great captains of industry of the United States testify that he contributed thousands of dollars to the support of an institution out there, organized frankly for the purpose of fighting organized labor; that he had never attended a meeting of his organization for three years; that he did not know off-hand its aims and purposes;

that he operated an industry employing 3,500 men, women and children, and had always treated his employes fairly. He admitted his organization was for the purpose of upholding the open shop. He did not know the number of labor organizations in Los Angeles.

Upon close examination by Mr. John B. Lennon and Mr. James O'Connell, of your organization, assisted by Mr. Austin B. Garretson, the other representative of labor, many of the contentions of Mrs. Noel were upheld. She said: "You gentlemen are going about seeking the causes of industrial unrest. Have you not seen it in the statement of the last witness? He has a machine that is operated by him that has to do with the life and health of 3,500 human beings. He said he treated his employes right, and yet he admitted he did not know the cost of keeping an unprotected woman in decency and comfort in Los Angeles. He contributes thousands of dollars to the upkeep of an organization and does not know its aims and purposes and has not attended a meeting for three years. He says it is formed to fight organized labor, of which he knows nothing. He has shown you he has no knowledge of his own industry, of the machinery which he is setting in motion to fight organizations of labor and no knowledge of the personnel or motives of the organizations of labor. In other words, he has shown he is absolutely ignorant of social economics; and so I say that a great cause of industrial unrest would be removed if the government could establish a board, such as states and local communities have formed to examine engineers and examine men before they go into those great industries, which means so much to human welfare and human life, without being properly equipped."

She made another suggestion that in this day of investigating committees, inquiring into the cost of room rent for young women, inquiring into the cost of luncheons, the cost of medical attendance, some investigating body ought to be organized to investigate the standard of living of those men at the head of these great industries, to find out whether or not their manner of living is not so violently in contrast to the manner of living of their employes that it is a distinct cause of industrial unrest.

Many of the questions we have to meet are fundamental questions. I say, however, there is no question which we will be called upon to pass upon in which you do not have a most important stake. Not only for the two million and more of your members, not only for perhaps the ten million more directly under your influence as members of your family, and the countless millions now and in time to come that are depending upon the effort you are making here today and in other parts of this country; but we will undertake while passing upon these merely technical things to bring out, if we

can, those fundamental questions of unequal distribution of wealth, or perhaps improper handling of national resources that has such a strong bearing upon those questions you are dealing with locally.

All over the Pacific coast we heard from the employers the cry that men were massing in the great cities; we heard the cry of "Get back to the land," and when the forces of labor were put on there was a counter cry—"Get back the land." A representative of your organization called attention to the fact that in one state upon our western border, with a population of less than one million, four groups owned 38,000,000 acres of the most fertile land God's sun ever shown upon, and were holding it away from the beneficial use of mankind. Another member of your organization in San Francisco pointed out the fact so vital to our nation—because it reaches down into the life of the family—that in one of the great counties of California there was a school district of 110 square miles that had in it forty-seven school children, and another of 102 square miles that had in it a school population of forty children; one of the most fertile valleys in the whole world, containing 89,000 acres of land, in which there were but nineteen children, or one to every 4,661 acres of land, and one school district of 189 square miles that did not have one child in it—all of this land held in great tracts away from the beneficial uses of mankind.

The insistent cry of labor is for its democratization, if I may so express it, that no man will be satisfied, no man of intelligence ever, until he is given the full product of his own toll. That sentiment, my friends, was expressed by your distinguished President at our first meeting in New York; it has been voiced by every intelligent leader of labor thought from the Atlantic seaboard and up and down the Pacific coast. One finding I can say this commission will make, after an investigation covering the wide territory I have mentioned, after hearing from almost 300 employers representing all of the great industries practically of the United States, in point of numbers representing an employing capacity greater than any body of men ever brought together before in the history of this country, we found but five men who would disagree with the underlying principle of collective bargaining, and we will so report.

And, my friends, what is democratization of industry? As I understand, it is simply this: That every man who toils shall have a compelling voice in the conditions under which he gives his work, a voice as to compensation, as to hours, and as to conditions; and when I say that every man must have the product of his own toll if justice is to be established I mean every man who labors with his hands, with the muscles of his body, with his brain, every man who plans, every man who constructs, every architect, every draftsman and artificer.

Now, my friends, let me make this one suggestion, that I may be excused for hoping will animate your minds, because I am not here to give you advice. I have always believed that all the government can do is to unshackle industry, that all law can do is to establish justice between man and man. Your destiny depends upon yourself and you must work it out.

SPEECH OF PRESIDENT GOMPERS, IN REPLY TO ADDRESSES OF FRATERNAL DELEGATES.

President Gompers: After the messages we have heard, I take it now it would be appropriate to just express briefly the appreciation of the delegates to this convention of the American Federation of Labor of all that has been said, even when upon any particular point there may be a division of opinion or dissent. Of course, we are pleased to have expressions of good will and hope for the advancement of our movement. But, after all, the movement itself is not the thing, it is not the goal. The organization, the movement of labor, is the instrument and the vehicle to attain the great objects of right, of justice and of humanity.

On behalf of the convention (I am sure I am but very feebly expressing our appreciation), when I say we are greatly gratified and thank you from the very bottom of our hearts that you should have come here and expressed to us your hope for our welfare, to have shown that which you have done and are trying to do.

We are assembled here in convention, and in holding our annual conventions we are not the dominating factor of the labor movement of America; we come here as the representatives of the organization on the continent of North America, representing the heart throb and the mental thought of the toiling masses of America. We hope to give expression in concrete form of the hopes and yearnings and aspirations of the toiling masses of America. We try to voice their sentiments and their grievances, and to insist and to make the demand upon modern society, and all the representatives of modern society, that the wrongs and the grievances from which the toiling masses of our country and our time have so long had imposed upon them be remedied, and to secure the rights to which they are entitled and which too long have been denied them.

We cannot always direct our movements as some would like to have the movement directed; we must deal with the elements within our ranks which constitute the great rank and file of the organized labor movement. We have not always the choice of material. The men and the women who labor, the men and the women who give service to society—and the service without which civilization itself could not exist—these make up the rank and file of the organized labor movement, and these we have the honor to represent.

For years and years, and particularly in these last two decades, there have been elements at work among the exploiters of the people of our country to go into the fields and in the poorest and the worst fields of the world, and by a system so deep it is with difficulty it can be observed or uprooted, and by the great agencies which money affords them to utilize bring from all parts of the world men of labor, with all the weaknesses and all the shortcomings and all the ignorance and prejudice upon their heads.

And we say this to you, gentlemen and ladies, as we say it to the world—at least I want to say it for myself, to be responsible for the utterance—that if these men are good enough to be brought to our country to work for your profit, they are good enough, with all their weaknesses and shortcomings, for us to organize them and try to make better men and better women of them. And our movement, I repeat, can only be, if it is truly a movement of labor, a representative gathering of the thoughts and the hopes and the prejudices, if you please, and the shortcomings, if you please, and the strength and the weakness of the men and women in the United States and Canada who have been brought here under such circumstances to mingle with us; and if we can in our way try to help them, and by our maturer experiences to rightly guide them, we have done something for the establishment of the American character, of American concepts; to help them and to help our country, and particularly to help the men and women of labor and the children of our times who are to be the men and women of the future, that they may have a better understanding of their rights and their opportunities, as well as to impregnate their minds with their duties and their obligations.

We aim to earn and deserve the good will of our fellows. We have seen the misery and poverty and degradation existing in industry, involving thousands and thousands of men and women, without a protest or a word of sympathy on the part of what is known as the public; and it has been only when, through the instrumentality of the much misunderstood labor movement, that we have stirred the hearts and the minds of the people oppressed with a sense of the wrongs committed against them, and when they have indulged in a protest which resulted in a strike, as typified, if you please, by the coal miners of America, as typified even up to the recent time, and now, in the textile industry, as it exists now among working people in the iron and steel industry. The thought of Sunday rest, insofar as that industry is concerned, was never given a second consideration by the great corporation and the vested interests, and many men whose duty it is, in speaking in the name of the Lord, who walked, like the Pharisee, on the other side.

The organized labor movement represents the toiling masses. I know as well as anyone can tell me that there are some working people who would dispute that utterance and say: "Mr. Gompers, you do not represent me." And insofar as any credential is concerned he speaks the truth; but there is a deeper and a more important credential which, in common with my fellow workers I carry, and that is the credential to give the very best there is in me, to see to it that the cause of wrong is exposed, to arouse public opinion, the public conscience and public resentment to remedy wrong and establish right.

I believe in quietness and order; I try to lead that life myself, and I will go as great a length as any man in the world to try to maintain order and peace and tranquility, but there comes a time in the history of labor when to remain in tranquility is to rivet the chains of slavery. I want, if I can, to express what I believe to be, or what I know to be the sentiment and the view of the American labor movement, without regard to any division of opinion as to which direction the movement should go. We try to avoid strikes, but we are preparing for any strike into which we may be forced; and we realize that the time has not yet come when the angel of peace has descended upon the world. We are going to try to get along as best we can in this labor movement of ours and give the best that is in us toward making it as represented and typified by the American Federation of Labor itself and its constituent bodies, the national and international unions.

On the opening day I took occasion to remark that the meetings of our conventions are open. I think it is but once in the history of the American Federation of Labor that an executive session was held. They are open to the criticism, favorable and otherwise, of our friends or foes. We are going on with our work as the light is given us to help the men and women of labor, even though they are not represented in this convention. We are going to try to influence the opinion of our time, that all the people may have a better concept of that for which we are striving, and to try to use the good influences and the services of the organized labor movement to maintain as much of peace in our own country and continent as we can, and to endeavor to extend that beneficent influence upon the minds and consciences and hearts of the people the world over.

Again, without any invidious comparison, addressing each of our fraternal delegates and the chairman of the Industrial Commission, I want to say that for all you have said, the good will you have expressed, the advice you have given us, we shall give it all the best possible consideration of which we are capable. Again, I thank you heartily for your coming here and for your expressions of good will for our welfare.

THE BOILER MAKERS' JOURNAL

Official Organ of the International Brotherhood of Boiler Makers, Iron Ship Builders and Helpers of America.

A Monthly Publication Issued the First of Each Month from Room 8, Law Building, Kansas City, Kansas.

JAMES B. CASEY, Editor and Manager.

Subscription Price.....\$1.00 Per Year in Advance

ADVERTISEMENTS.

Advertising Rates Will be Furnished Upon Application to the Editor-Manager. No Reading Space Will be Sold for Advertising Purposes Under Any Circumstances.

All New Members Must Have Their Name and Address Sent in Through the Secretary of Their Lodge. After That They May Have Changes Made in Their Address by Filling Out Blank Form in Back of Book and Forwarding to the Editor.

All Copy Must be Received by the Editor by the 15th of the Month to Insure Publication in the Following Issue.

All Contributions and Correspondence Relating to the Journal, Should be Addressed to J. B. Casey, Editor, Room 8, Law Building, Kansas City, Kansas.

Entered at Postoffice, Kansas City, Kansas, as Second Class Mail Matter.

NEW YEAR'S GREETING.

As this issue of the Journal comes from the press on the first day of the year, we embrace this opportunity to wish all of our members a very Happy New Year.

We hope the New Year just coming into existence will prove to be one of the most prosperous that our members have experienced in a long time. Present indications point this way, and we hope nothing will arise to change this promising condition.

With this wave of prosperity should come a stronger campaign for the extension of our organization among the eligible men now working at our trade and still outside its ranks. The necessity of organization among our people has been demonstrated very forcibly in recent years, if we would reap our share of prosperity when it arrives. Our members should show they are alive to their own interests and loyal to the organization of which they are a member, by joining in this work of organizing wherever possible. Get those around you interested, take their application to your lodge and if you know of others who may be organized, but not being in a position to do the work yourself, let the facts be known and an organizer will be furnished, and above all let us now, on the threshold of a New Year, solemnly resolve to banish from our ranks all spirit of discord and knocking that only too often shows itself; let us view the knocker in his true light—an enemy of our organization and its members, and banish them from our ranks. If we will do this we will have laid the ground work for a growth and development, not before reached by our organization.

VOTES TO CONTINUE HARRIMAN LINES AND I. C. STRIKES.

According to the result of the vote taken by the strikers on the Harriman Lines and Illinois Central, as announced by the Railroad Department, a majority of the men voting were in favor of continuing the fight against these roads and it will no doubt be pushed to the limit. This vote was ordered taken by the Executive Officers of the Railroad Department in order to get the true sentiment of the men involved, when they were forced through existing conditions, to withdraw financial support. Their action in doing so was violently assailed by some of the radicals and the honesty of their

motives questioned. Such inflammatory and unwise outbursts, in our humble opinion, does the course of labor a serious injury and the officers in charge of these matters rank injustice. How were they going to find out what the wish of the majority of men was unless they were given an opportunity to express that wish by a vote? As we understood the matter there was to be no great publicity given to the matter, but effective means were employed to reach all; they were to argue the merits of the matter in the lodge room and record their votes as they deemed it best. In consonance with this evident policy, we made no mention of the matter while the vote was being taken, as circular letters and ballots were sent to every lodge of each and every organization affected, and no matter where the men who came out might be working, they had an opportunity to vote. Furthermore, it seems to us this opposition to letting the men in the ranks have an opportunity to vote on the question is very inconsistent, as those who opposed it are advocates of the referendum and lay claim to such democratic ideas, and this referendum is one of the most democratic of principles. This vote, while not near so large as it should have been, has served to clarify the atmosphere; the Officers of the Department know what the men desire and can act accordingly; the only harm done was through the hasty and ill advised hue and cry against the Executive Board of the Department.

This incident should serve as a warning for the future, and prompt our members to be on their guard against similar unwise and hasty outbursts.

THE EUROPEAN WAR SHOWS THE NEED FOR GOVERNMENT OWNERSHIP OF WIRES.

The present European conflict shows the absolute necessity of the telegraph and telephone for the proper conduct of an armed conflict, and it has further shown that privately owned lines in case of serious conflict with a foreign foe would be an absolute menace to the safety of our country. Modern warfare with the immense armies that several nations of the world are capable of putting into the field, would be too vast for any general to efficiently handle unless he could use the telegraph and telephone; both are being used more and more, to conduct operations and provide the necessary co-operation among the different forces involved.

Strange to relate, while the greatest republic of the world, yet we are about the only great nation that does not own and control its telegraph and telephone lines, and there is a growing sentiment among the people of the United States, that we, too, should own and control all means for the transmission of news and business. Congressman Lewis of Maryland has already introduced a bill for this purpose.

THE COLORADO MINE WORKERS' STRIKE DECLARED OFF.

At a recent meeting of representatives of the miners on strike in Colorado, it was decided to call off the strike in that state, which has been on for so long and which involved most of the coal miners in Colorado. This action was recommended by the International Executive Board of the United Mine Workers of America.

The recent convention of the American Federation of Labor passed resolutions calling upon the President of the United States to have a Federal receiver appointed to take over these mines and run them in the name of the people. A committee from the miners, later on, called upon President Wilson and presented this request. The President informed the committee he had been advised that he could not legally do this, even though the operators persist in their refusal to accept the plan of settlement recommended by him. This prompt and self-sacrificing action of the mine workers in declaring the strike off will place them and their cause higher in the estimation of the public, and the operators will have to bear the odium of public disapproval for their tyrannical and unyielding attitude in refusing to treat with organized labor and the full responsibility for any disorders that may occur in the future. The Federal Industrial Commission recently held public hearings and investigated conditions in these strike regions, and it was fully shown that while the operators were refusing to treat with the men, they spent hundreds of thousands of dollars in sustaining thugs and strike breakers, and a great many other thousands in hiring writers to distort and pervert the true conditions as they existed, in a vain effort to influence public opinions in their behalf. It was proven that one writer was paid \$12,000 for writing an article which was widely circulated by the operators. This writer admitted to the commission that many of the statements made in this article were false, and that many others that he made he did not know whether they were true or not.

As the true facts become more widely known, public opinion will eventually force these operators to treat with their men, or out of business. The principle of collective bargaining is recognized the world over and these coal barons will find they cannot reject this just principle with impunity. President Wilson has named a commission, consisting of Seth Law of New York, C. W. Mills of Philadelphia and Patrick Gilday of Clearfield, Pa. This commission is named in accordance with the plans of settlement as proposed by President Wilson and accepted by the mine workers, but rejected by the operators. This commission will take up any further complaints that may arise. Whether it will be able to accomplish much good remains to be seen, but if the operators persist in their refusal to treat with their employes as an organized body, the commission will not be able to do much good; however, it is quite likely the lash of public opinion will force them to change their attitude.

STILL TRYING TO BOOST OUR MILITARY ESTABLISHMENT.

We pointed out in our November issue that the European War was being used as an excuse to arouse public sentiment in favor of a large increase in our army and navy. Since that time this jingo sentiment has crystalized into an organized effort for this purpose. The daily press a few days ago informed us that "two hundred and fifty representative citizens of New York" had formed "The National Security League," and an effort will be made to organize branches throughout the country, as a first step towards inaugurating a nation-wide campaign to boost the army and navy.

One of the worst features of this military expansion campaign is that indications point to the probability of one of our great political parties taking up this as a campaign issue for the real purpose of boosting itself into power again. If it does, this, of course, means several years of agitation upon this subject and should they at last become successful upon such a platform it would give a tremendous boost for a large standing army and a big navy. Congressman Gardner started a hue and a cry about our unpreparedness to defend ourselves against an enemy; however, upon investigation it was disclosed that his fears were not well founded; our coast defenses were found in good shape with a reasonable amount of ammunition and supplies on hand. Our army, while it will not, of course, compare favorably with the great standing armies of some of the European nations, it is sufficient to form a nucleus around which to center the state militia and the volunteers which has been our main reliance since the foundation of the republic. Furthermore, it is disclosed that our navy is the second largest and most powerful navy of the world; furthermore, the digging of the Panama Canal has doubled its efficiency in the matters of defending our shores; if either coast should be menaced, the fleet could be quickly transferred from one ocean to the other. While there may be some nervous people who have honestly entertained the fear that we were not prepared to defend ourselves should a foe arise, still we are convinced that much of this agitation is not being waged so much for our country's safety, as to gain a political advantage for the agitators. Another group we may safely bet will boost this matter is the army of contractors that furnish material and supplies to the army and navy.

Leaving aside all this jingoism and nervous hysteria, we believe we should pursue a policy of preparedness to meet any emergency that might arise. We can, however, effectively do this without creating a large standing army. Let the government increase its manufacture of arms, ammunition, equipment and standard supplies; then change the term of enlistment for the soldiers and sailors from four years, as it is now, to one or two years. At the termination of each enlistment a large portion of the trained soldiers and sailors will not re-enlist, but return to civil life, so others will have to be enlisted; thus a constant stream of men will pass through the army and navy, trained in the service, and while they will return to civil life, their retirement could be made conditional upon their agreeing to respond to a call to the colors in case of need, which might arise within five years after the termination of their enlistment. The reserved arms, equipment and supplies could be used to fit out these reserves and in this way a trained and efficient army could be gathered together in a very short while. However, our greatest source of security for the future must be as it has been in the past, based upon our peaceful and equitable policies in dealing with the other nations of the world. So long as we maintain this attitude towards our neighbors of the world and maintain our present military establishment in an efficient manner, we will have no reason to fear for our country's safety.

NAVY YARDS MAKE GOOD SHOWING.

The belief that work done in our navy yards cost an excessive amount has been long entertained by some of our people, and that it was economical to let work out to contractors and let the latter make enormous profits rather than have the work done in the navy yards. However, the true facts in the case are gradually becoming known and it is found that work done in navy yards is done as efficiently, expeditiously and economically as in private yards. Several ships have been built in the navy yards in recent years, and in each case they were built for less than they would have cost in private yards, and the work was done in a more thorough manner, as contractors will usually skimp if possible.

In the annual report of the chief of the Bureau of Engineering recently made public, it was shown that the engines for the dreadnaught New York was quickly constructed at the New York Navy Yards and for less than they could have been built in private yards, and even a better showing was made in the Mare Island Navy Yard, where the machinery for the gunboats Monocacy and Palos were constructed at a cost one-third less than if built in private yards. Other cases of like nature could be quoted, but this, we believe, is sufficient to show their efficiency.

While this good showing stands to the credit of the men, still it seems conditions are not harmonious or satisfactory, and wide-spread complaints and protests have come to our notice recently, and it seems to us it is due to the rasping, irritating and senseless policies of some of the little petty-fogging naval officers who are trying to wield the "big stick" of military discipline upon a body of mechanics, who even though they are government employes, are American citizens and feel that they should not be subject to the strict discipline practiced upon enlisted men. If some of those officers clothed with a little brief authority knew their parts better, they would try to win, by kindness, the confidence of the men, and thus encourage them to make still better efforts. If a sane and efficient management is used in directing the management of the navy yards and their thousands of employes, still greater achievement will be secured and greater savings will result.

THE A. F. OF L. TO OWN A HEADQUARTERS BUILDING.

After a number of years of preliminary agitation and talking up sentiment in favor of the American Federation of Labor owning a building in Washington for its headquarters, it now begins to look as if the matter was soon to come to a successful issue, as the last convention, which recently met in Philadelphia, authorized the executive council of the federation to either buy a piece of ground and erect a building or to purchase a building already erected, which would prove suitable for that purpose.

Now that the council has secured the necessary authority it will no doubt promptly act in the matter, and we may soon be able to herald the fact that a permanent home has been secured for the federation.

It will no doubt prove of financial benefit to the federation and a source of strength and permanency that nothing else will. Such a move would

be of an advantage to our own organization; if a commodious building in the residential section, but near to the business section, was purchased, it could be paid for in a few years by the rent we are now paying for our present headquarters and then our organization would have a permanent home, free from rent. The only cost would be for the taxes, insurance and upkeep; furthermore, as the years went by and the city grew in size, the value of the place would greatly increase in value. A number of international unions have secured buildings along this line.

A FEDERAL JUDGE ORDERS AGREEMENT RESTORED.

The receivers for the Wheeling and Lake Erie Railroad, under date of October 1, 1913, entered into a federal agreement with shop trades, which was to be in force for one year and until thirty days' notice was given by either side that a change was desired. On October 28, 1914, a notice was posted by the company declaring the agreement would be null and void after December 1, and in the meantime the shops of the company were closed down. Under date of November 24, the general manager authorized the superintendent of motive power to arrange to open the shops on December 1, under a set of rules drawn up by the latter. Under these rules many of the best features of the agreement were left out. A copy of these were given to the men for approval, but the men refused them and sought to have their old agreement renewed. The superintendent of motive power, however, refused to do so and an appeal was taken to the general manager, and international vice-presidents of the organizations affected went to work on the job. However, their efforts before the general manager did not prove successful, so they went to the receivers, and met with the same result, so as a last effort to bring about a peaceable adjustment they sought the aid of Judge Clark, United States district judge in charge of the receivers. Here we are glad to say they met with success and the following notice has been posted by officials of the company, which is self-explanatory:

"Notice to employes locomotive department, December 5, 1914:

"Notice posted October 20, 1914, is hereby rescinded. The general shop rules and regulations governing the employment and service of machinists, boiler makers, blacksmiths, pipemen and tanners, their respective helpers and apprentices in the locomotive department of the Wheeling and Lake Erie Railroad Company, which became effective October 1, 1913, will continue in effect until thirty days' notice is given by one party to the other desiring a change. All other employes in the locomotive department will continue in service under the same rules as were effective on October 1, 1914."

The vice-presidents and other officers of the union, as well as the men involved, deserve credit for their active, intelligent and persistent efforts in this matter, and the result shows the wisdom of exhausting every possible means to avoid trouble and reaching an amicable settlement. In this case a satisfactory settlement was secured without a contest.

International Vice-President Maher looked after the interests of the boiler makers. We desire to compliment Judge Clark on his good examples,

which we hope will be followed by other judges having charge of receivers in like cases. This wise and liberal action has done much more good to this road and the territory through which it runs than could any possible arbitrary action.

COMMISSION ON INDUSTRIAL RELATIONS SUBMITS PRELIMINARY REPORT.

The Commission on Industrial Relations has submitted its first report to Congress; the report is a preliminary one and contains an analysis of the evidence and opinions of the various groups of witnesses that appeared before it, in reference to the cause of unrest and dissatisfaction seemingly existing among the industrial portions of our people.

The commission makes no specific recommendations, but is evidently laying the ground work for a number of far-reaching ones to be submitted later. In the summary of evidence the report speaks as if the commission had been very much impressed with the importance and benefit of conciliation in labor disputes and lauds this plan as being superior to that of all other plans so far advanced towards settling industrial disputes, and it is quite likely that increased facilities for the use of this means of preventing and settling them will be provided as a result of the commission's investigations and recommendations.

The report shows that a vast amount of investigation and testimony has already been made and plans perfected for securing much more; the report throws out many valuable suggestions and is well worth reading by any one interested in the industrial problems that confront us.

RAILROADS GET INCREASE IN FREIGHT RATES.

The Interstate Commerce Commission recently granted 5 per cent increase in freight rates for the Eastern, Southeastern, Southwestern and Middle West territory on or east of the Missouri River. This increase, however, does not affect shipments of coal or iron. The reason given by the commission is that bituminous coal and coke rates were raised twice recently and anthracite coal and iron shipments are to be considered in other proceedings before the commission.

It is estimated that this will increase the revenue of the roads affected about \$50,000,000 per annum.

The commission, a short while prior to this freight rate increase, issued a ruling to the effect that roads could charge more than two cents for interstate passenger fares even though the states through which the road runs, have a two-cent rate; this ruling practically nullifies the two-cent rate on at least one-half of the passenger traffic. As a consequence a readjustment of rates is being put into effect. These two decisions should greatly increase the revenues of the roads and stop their complaint. It is to be hoped the result will be an increased activity in the repairs of motive power and equipment.

QUOTATIONS.

Speak gently! 'tis a little thing
 Dropped in the heart's deep well;
 The good, the joy that it may bring
 Eternity shall tell.

—G. W. Langford.

No unkindness of a brother can wholly rescind that relation or disoblige us from the duties annexed thereto.—Barrow.

Be not diverted from your duty by any idle reflections the silly world can make upon you, for their censurs are not in your power, and consequently should not be any part of your concern.—Epictetus.

Frugality may be termed the daughter of prudence, the sister of temperance and the parent of liberty. He that is extravagant will quickly become poor, and poverty will enforce dependence and invite corruption.—Dr. S. Johnson.

The greatest flood has the soonest ebb; the sorest temper the most sudden calm; the hottest love the coldest end, and from the deepest desire oftentimes ensues the deadliest hate. A wise man had rather be envied for providence than pitied for prodigality.

Revenge only barketh at the stars, and spite spurns at that she cannot reach. An envious man waxeth learn with the fatness of his neighbors. Envy is the daughter of pride, the author of murder and revenge, the beginner of secret sedition, and the perpetual tormenter of virtue. Envy is the filthy slime of the soul; a vermon, a passion or quicksilver which consumeth the flesh and drieth up the marrow of the bones.—Socrates.

The brave only know how to forgive; it is the most refined and generous pitch of virtue human nature can arrive at. Cowards have done good and kind actions. Cowards have even fought, nay sometimes conquered; but a coward never forgave—it is not his nature; the power of doing it flows only from a strength and greatness of soul conscious of its own force and security, and above all the little temptations of resenting every fruitless attempt to interrupt its happiness.—Stern.

Let us cultivate a true spirit of union and harmony. In pursuing the great objects our condition points out to us, let us act under a settled conviction and an abiding feeling that these twenty-four states are one country.

Let our conception be enlarged to the circle of our duties. Let us ex-

tend our ideas over the whole of the vast field in which we are called to act. Our object be, **Our Country, our whole Country and nothing but our Country**, and by the blessing of God, may that country itself become a vast and splendid monument, not of oppression and terror, but of wisdom, of peace and of liberty, upon which the world may gaze with admiration forever.—Daniel Webster.

Consider what you have in the smallest chosen library. A company of the wisest and wittiest men that could be picked out of all civil countries, in a thousand years, have set in best order the results of their learning and wisdom.

The men themselves were hid and inaccessible, solitary, impatient of interruption, fenced by etiquette; but the thought which they did not uncover to their bosom friend is here written out in transparent words to us, the strangers of another age.—Emerson on Books.

The meanest thing the knocker says
 About the other fellow
 Exposes to us just one thing—
 The knocker's streak o' yellow.
 —Detroit Free Press.

STRIKES NOW IN FORCE.

- Spokane, Wash., Union Iron Works. (Metal Trades strike on.)
- Farrer Traft Contract Shops, Buffalo, N. Y. (Strike on.)
- Illinois Central R. R. (Federated Trades strike on.)
- Harriman Lines. (Federated Trades strike on.)
- Pere Marquette R. R., Grand Rapids and Saginaw, Mich. (System Federation strike.)
- Contract shops, Mobile, Ala. (Metal Trades strike.)
- Boiler shops, Newport News Ship Building & D. D. Co., Newport News, Va. (Strike on.)
- Missouri, Oklahoma & Gulf R. R. (Federation strike.)
- Atlantic Basin Iron Works (Shields & Moran, New York.) (Strike on.)
- Hibbon & Co., contract shop, South Chicago, Ill. (Unfair.)
- Stockton, Calif. (Metal Trades strike.)

Mechanical Department.

TO DEVELOP THE PATTERNS FOR A TWO WAY REDUCTION ELBOW.

By L. L. Lane, Miles City, Mont.

The first step is to construct the proper elevations of two elbows as in Fig 1, and by projecting downwards draw the plan. Now on the center line 1' 2' of the plan draw a half circle with a diameter equal to that of the small pipe or elbow as shown; divide it into a number of equal parts, in this case eight, and project them to the plan Fig. 2, as 1-2-3 and so on to 7, and then divide the

tion, and then the hypotenuse of this triangle is the true length of the line 2' 1; in this way all the true lengths are found by constructing triangle in this way as shown at Fig. 3. Now to lay out the pattern for Section A, at Fig. 4, first draw the line 1 2', then with 1 as a center and a radius equal to the arc 1-2 of the plan, describe an arc at 2 and with 2' as a center and a radius equal to the true length of 2'-2 (taken from one of the triangles) already constructed at Fig. 3. Describes an arc at 2, then with 2' as a center and a radius

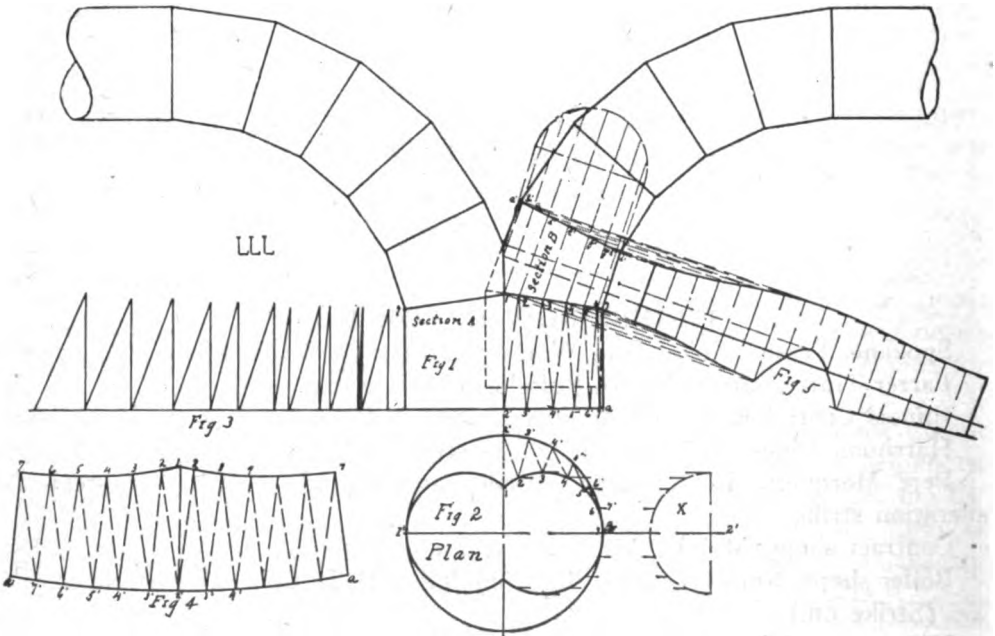

large circle from 2' to 7, into six equal parts as 2' 3' 4', etc.; now project these to the elevation and then draw lines forming triangles as shown by dashed line in the elevation from 2' to 2, 3 to 3, etc., and this is done the same way in the plan as shown. Now to construct the triangles at Fig. 3, to find the true length of the lines for the pattern, take one of the lines in the plan, say we will start with 2' 1, making this distance equal to the base of the triangle and its height equal to the perpendicular height of the corresponding in the eleva-

tion, and then the hypotenuse of this triangle is the true length of the line 2' 1; in this way all the true lengths are found by constructing triangle in this way as shown at Fig. 3. Now to lay out the pattern for Section A, at Fig. 4, first draw the line 1 2', then with 1 as a center and a radius equal to the arc 1-2 of the plan, describe an arc at 2 and with 2' as a center and a radius equal to the true length of 2'-2 (taken from one of the triangles) already constructed at Fig. 3. Describes an arc at 2, then with 2' as a center and a radius

TO CONNECT A SMALLER PIPE TO A LARGE ELBOW, PARALLEL WITH ITS BASE.

Fig. 1 shows the side elevation of elbow and pipe. To layout template for pipe connection, mark off elbow the desired size and with the number of sections, in this case four.

tend them up through the four sections as shown, next strike the semi-circle at the end of pipe at top, using B as center and the same radius as in Fig. 3.

Divide the half circle into six equal parts from 1 to 7 and from these points of division strike lines parallel with the center line A B. Extend these lines as follows: Com-

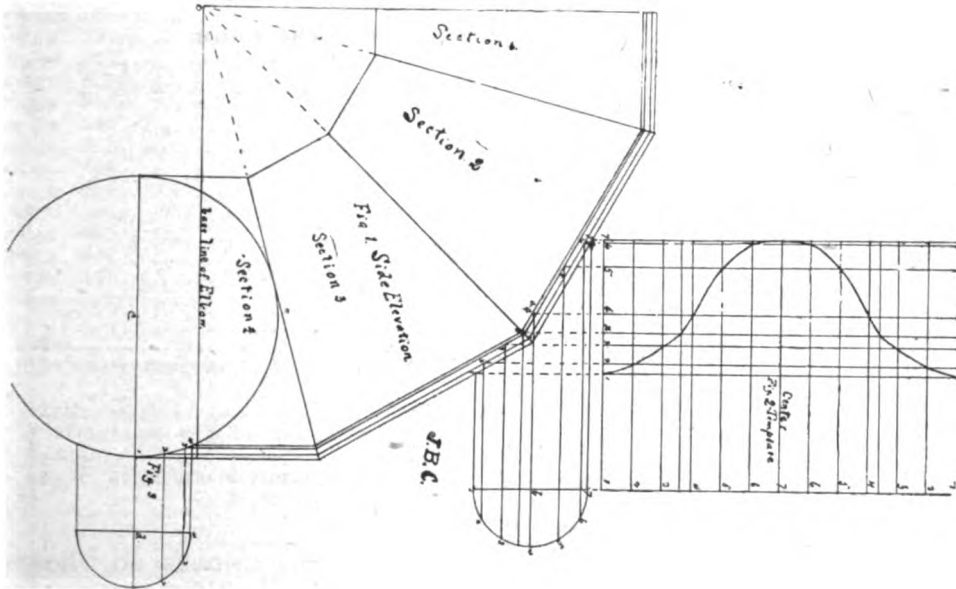

Then locate the pipe connection, by first striking A-B, parallel with the base line of elbow, then take one-half of the mean diameter and mark off on each side of this line and strike lines through these points until they strike elbow. Next strike a parallel line sufficiently far enough below the base line to allow a semi-circle of the elbow to be struck on bottom (4) section as shown. Next extend this parallel line out far enough to reproduce Figure 3; take one-half of mean diameter of pipe as before, and mark on each side of this line and through these points strike lines until they connect with circle. Take dividers and with one point at D and the other at 4, strike the semi-circle at the end of small pipe as shown. Divide one-half of this from 1 to 4 into three equal parts and from the points 2 and 3 strike lines parallel with the center line and connect with circle of elbow. From where these lines strike circle of elbow, strike lines up and parallel with side lines of elbow, ex-

mencing with line 2, extend it to the second line of elbow, then extend the third line until it strikes line 3 in the elbow, line 4, which is the center line, should be extended to line 4 of elbow. Then line 5 will be extended until it reaches the third line of the elbow and line 6 will stop at line 2 of the elbow. From where these lines cut the lines in elbow, strike right-angle lines as shown, numbering them from 1 to 7, also strike line parallel with these lines at the end of pipe. Next ascertain the circumference of pipe, using the mean diameter from which to circulate and mark it off on this line; divide this into 12 equal parts, which is twice the number of parts in the semi-circle; from these points strike right-angle lines and number them from 1 to 7 and from 7 to 1.

Next take a pencil and trace a line through points where these two sets of lines cross as shown; this will represent the cutting line for templates for pipe connection.

International Officers' Reports.

Kansas City, Kas.

The following tabulated list of lodges and votes is the result of the ballot recently distributed among all lodges of our Brotherhood, in reference to the strikes on the Illinois Central, Harriman Lines and the Pere Marquette Railways. The tabulation shows the lodge members belonged to when called upon strike, total number of votes to continue strike, total number to discontinue strike, number of votes and number of lodge sending same in, and total votes cast. The total vote is credited to the lodge of which members belonged when strike was called, the vote is shown in the last column to the right and the number of the lodge in the first column to the left.

NUMBER OF VOTES AND LODGES VOTES CAME FROM.

Lodge	To Continue	To Discontinue	Lodge	Vote	Lodge	Vote	Lodge	Vote	Lodge	Vote	Lodge	Vote	Lodge	Vote	Lodge	Vote	Lodge	Vote	Total				
4	1	5	4	6														6					
10		1	504	1														1					
32		1	32	1														1					
40		1	40	2														2					
46		9	46	7	221	1	427	1	473	1	483	1	605	1			12						
48		3	48	3														3					
52		6	309	1	528	1	605	1	80	5							8						
56		3	68	1	311	1	590	4									6						
72	12	6	72	12	138	1	123	2	247	1	568	2					18						
74	2	22	74	19	132	1	265	1	293	1	464	2					24						
88		1	4	1	22	1	244	1										3					
92	8	1	92	9														9					
94	12	9	94	16	11	1	113	1	520	1	528	1	603	1			21						
95	2	1	95	3														3					
106		2	70	1	137	1												2					
133	13	10	133	14	116	1	144	2	161	4	244	1	520	1			23						
137	7	13	95	1	22	2	137	6	113	1	227	1	293	3	334	1	403	3	468	1	575	1	20
150	1		150	1															1				
179		1	113	1															1				
180	3	12	180	9	4	1	113	1	70	1	430	2	599	1				15					
198	3	10	103	6	136	1	169	1	198	3	244	1	605	1				13					
206	3	7	206	8	106	1	528	1										10					
216		1	216	1															1				
220	28	32	220	15	22	1	39	9	150	2	377	1	322	1	227	4	434	14	454	4	428	1	60
224		4	575	2	360	1	334	1											4				
233	6	1	233	6	568	1													7				
284	9	1	284	6	155	1	149	1	227	1	116	1						10					
242		1	242	1															1				
300	1	7	293	1	300	1	315	1	344	2	422	1	425	2				8					
309	1	6	309	5	103	1	136	1										7					
315	8	2	315	6	4	1	70	1	22	1	442	1						10					
339	4	1	25	1	339	3	528	1										5					
345	1	4	206	1	345	4												5					
363	9	3	363	7	322	3	150	1	575	1								12					
399	3	8	22	1	81	1	116	1	149	1	247	1	322	1	415	1	447	4					11
404	1	2	454	2	447	1													3				
408		5	423	1	486	1	501	2	567	1								5					
426	7	2	22	2	68	1	426	2	524	1	575	2	586	1				5					
474	4	2	242	1	103	1	473	1	528	1	595	2						9					
475	7		475	7														6					
538	1	2	25	1	94	1	502	1										7					
553	3	5	242	1	247	2	403	1	529	2	553	2	568	1	595	2		3					
555	6	1	103	1	92	1	528	1	568	1								11					
84	18	7	84	22	8	1	116	1	227	1								4					
124	13	4	124	13	7	2	116	1	150	1								25					
																			17				

Total, 211 222 230 44 50 35 24 14 8 21 5 2 433

The following is the list of votes received after November 23, 1914.

32	5	32	5																5
179	1	5	179	6															6
180	1		180	1															1
220		4	22	1	227	1	356	2										4	
309	1		309	1															1
426		3	10	3															3
25	1	1	339	1	359	1													2
Total,																			

Total, 215 240 248 46 52 35 24 14 8 21 5 2 455

The above is a correct count of all votes received which were counted December 5, 1914, by the undersigned.

A. HINZMAN, First I. V.-P.
F. P. REINEMEYER, I. S.-T.

COMMUNICATION FROM THE INTERNATIONAL SECRETARY-TREASURER.

Kansas City, Kas., Dec. 17, 1914.

To the Officers and Members of Subordinate Lodges, Greeting:

I wish to submit to you the late receipts received from lodges since November 20, in reference to the raffle for the benefit of Brother Wagner's family.

Late raffle receipts:

Lodge 3.....	\$ 10.00
Lodge 7.....	1.75
Lodge 57.....	1.25
Lodge 105.....	6.00
Lodge 154.....	10.00
Lodge 227.....	.75
Lodge 229.....	4.75
Lodge 244.....	1.50
Lodge 249.....	14.00
Lodge 311.....	5.00
Lodge 364.....	1.00
Lodge 419.....	2.50
Lodge 495.....	1.50
Lodge 496.....	4.50
Lodge 546.....	5.25
Lodge 547.....	.25
Lodge 590.....	6.25

Total \$ 76.25
 Previously reported. 972.75

Total \$1,049.00

Trusting this will be satisfactory, I beg to remain,

Yours fraternally,
 F. P. REINEMEYER,
 I. S.-T.

REPORT OF SECOND VICE-PRESIDENT NOLAN.

At the conclusion of my last report was at Washington, D. C., there for the purpose of preventing the passage of an amendment to the boiler inspection law, if possible to do so, also matters in the interest of Lodge 450 at the national capital.

I desire to inform the officers and members of the Brotherhood, although successful in preventing the passage of the amendment to the boiler inspection law this session, it was a pretty difficult job, as every possible effort was put forward by the representatives of the locomotive engineers, locomotive firemen and their friends to put the amendment through the various committees of the House of Representatives.

In looking squarely at this proposed legislation from a humane, as well as from a business standpoint, it seems that the very purpose of the boiler inspection law, as intended by Congress has been entirely lost sight of, by those whom the legislation was enacted to protect, in a scramble for positions in the Bureau of Boiler Inspection, as well as under its jurisdiction as district inspectors.

I have stated on many occasions in the columns of the Journal and do so again, that the boiler inspection law has not been enforced, and say without fear of practical

contradiction either from a legal or mechanical standpoint that no inspector can qualify according to the law as enacted, either bureau or district inspectors, unless they have practical knowledge of the construction and repairing of boilers, yet we find many have been appointed to such positions through a civil service examination who absolutely know nothing of the practical construction and repairing of boilers, such is the case, and cannot be denied, as all railroad shop mechanics know it.

Congress adjourned October 26th, but the amendment is still in the Rules Committee of the House of Representatives, although I had been told on several occasions in the presence of Bro. J. D. Evans of Lodge 450, that the amendment would pass regardless of our opposition, but it didn't, and can further assure the promoters it's doomed to defeat as it will never pass the Congress of the United States in its present form.

But nevertheless I have no doubt, another effort will be made to pass the amendment when Congress convenes in December and as usual the Brotherhood of Boiler Makers, Iron Shipbuilders and Helpers of America will be on the job, in the interest of law, and the enforcement of it. Nothing more or nothing less. Therefore let every member of the Brotherhood do his part when called on later on by the International President by individual appeals to your senators and congressman of your district, giving them your reasons why you are opposed to any amendment to the boiler inspection law passed by Congress, February 17, 1911. In this way your representative at Washington, D. C., will be in a position to bring about a more crushing defeat of the proposed legislation.

October 4th, by instructions of President Franklin, left Washington, D. C., for Norfolk, Va., to meet the management of the Norfolk Southern Railway for the purpose of adjusting a Federated grievance on the question of overtime at the New Bern, N. C., shops. On reaching Norfolk, met Brother King, who was then representing the machinists on the above system.

October 5th, in company with Bro. King and a committee from the Berkeley shops (Brothers Cousins and Joliff), met the officials of the company, and after several hours' conference trying to bring about a settlement, and without any success whatever, as the general superintendent, Mr. Sack, insisted that one or more members of the Federation must be disciplined in order to adjust matters. A suggestion was made, and accepted by the general superintendent that Brother King leave for Washington, D. C. and lay the situation before President Johnson of the Machinists and if necessary, have him come to Norfolk, as a member of his organization, was the victim for discipline.

President Johnson arrived at Norfolk Oc-

tober 7 when he again met the officials of the Norfolk Southern Railroad Company, and after many hours' conference the grievance at the New Bern shops was adjusted, all men returning to work the following day, October 8, with the possible exception of one member of the Federation, who will return to work later on. At least that was the understanding before conference adjourned.

October 8, visited Newport News, Va., to look after the strike situation there, and discuss conditions with the strike executive board, Brothers LeCompte, McArthur and McCaully, who made a report on the strike conditions, as well as the amount of work and number of scabbies in the boiler shop. The members of Lodge 55 came out on strike to win, were forced to, because their members were discharged for refusing to work piece work, also came out with an idea that the Metal Trades Council would support them through joint action. After voting to do so in case piece work was enforced, in the boiler shop, but nothing doing. Strike would not have occurred only for the action taken by the Metal Trades Council. As I fully realized it would be useless unless we had joint action of that body, the boiler makers came out with that understanding, but the Council's members still continued to work, the result was the boiler makers had to fight it alone, and did like trade unionists, with the possible exception of a few scabby rats, some of them even drawing strike benefits who returned to the pen to be branded as traitors by the members of Lodge 55, and the International Brotherhood. It is no wonder what has occurred since the boiler makers strike at Newport News, and the way they had been double crossed. Good union men have been discharged for the purpose of disrupting the local unions. Many had to leave town to find employment elsewhere, which has so seriously affected the movement, that it will require some hard work, time and money in order to restore some degree of confidence again among the metal trades organizations of Newport News.

In connection with the Metal Trades Council of Newport News and in justice to the following local unions who were affiliated, was ready at all times to support the boiler makers and through their officers urged joint action at several meetings of local council, local of carpenters and joiners, pipe men and electricians.

The foregoing statement is cold facts. The entire labor movement of Newport News knows it. All fair minded citizens know it also, and has told me so on many occasions, that the boiler makers had a grievance all right, and the officials of Newport News Dry Dock Company will respect them for the clear cut fight put up by them when Gibson and his scabbies will be gone and forgotten, for justice, though crushed to earth, will arise again.

October 9, returned to Washington, D. C., in connection with legislative matters; also to take up a grievance for Lodge 450, with the secretary of the navy. Met Secretary Daniels in company with Brother Evans, who assured us that grievance would receive his most careful consideration. One very important matter at issue in boiler shops was adjusted later on.

October 28, attended a regular meeting of Lodge 55 with President Healy in the chair. There was a good attendance, strikers still on the job. Brother Healy is a faithful advocate and a staunch friend of the Brotherhood for years in this neck of the woods as well as the general labor movement of Old Virginia, always ready to defend its principles, and help a deserving brother in need, but no union can pay the second visit to Brother Healy who brings trouble to himself through the cup that cheers, for almost every meeting, under the good and welfare of the order, he never fails to give that quiet lecture on sobriety among men who toll in mine, factory, contract or railroad shops. He is a temperance man at all times, but is opposed to prohibition as interfering with the privileges of the individual man.

Brother Healy is known at Newport News as a good citizen who can be depended on at all times to respond to duty's call, either in politics for the man with the union card who is qualified for the position, or in the interest of his fellow workers. He is not a radical by any means. On the contrary always consider carefully both sides of a controversy between employer and employes, and when a brother is right he is with him to the last ditch. When he is wrong he don't hesitate to tell him, even to an intimate friend. What he says he means. His word is as good as his bond. Such is the characteristics of the president of Lodge No. 55.

October 28, received orders from Brother Hinzman to leave for New Orleans and assist Lodge 37 in adjusting a grievance there. Before leaving for New Orleans and in compliance with previous orders from headquarters had a meeting with the general manager of the Roper Lumber Company, Norfolk, Va., relative to reduction in wages of all their employes last September and during conference on the wage question, his principal reason for a reduction in wages was the war in Europe, and would be compelled to close down indefinitely unless business picked up or war was ended soon, as the company depended mostly on import business, and would be pleased if their employes could get better jobs somewhere else, and was frank to admit that the men were entitled to more compensation for their labor owing to living conditions and what it cost.

I requested he meet a committee to discuss the question of late reduction, but refused, stating it would be useless to meet any committee on the wage question at

present, but had no objections whatever to a committee meeting the local management at New Bern, N. C., and knowing that nothing could be accomplished in meeting local officials of the company I notified one of our members employed by the company at New Bern, result of Norfolk conference, leaving for New Orleans on the night of October 29.

Arrived in New Orleans November 2, met the business agent (Brother Curry), Brother Daley, president of No. 37; Brother Costella, corresponding secretary, and Brothers Barker, Smith, Mason and others whose names I have forgotten.

A special meeting of Lodge No. 37 was called for November 4, to take up the pending grievance, as several of the members of No. 37 had quit their jobs at Rost Station, La., and had an idea they were out on strike. Meeting was called to order by President Daley, after which a lively discussion opened up, many members explaining how trouble started on the job at Rost Station, and cause of it; a motion was made and carried that a committee be appointed to wait on the Murphy Company and report to Lodge No. 37. Committee, Brother Curry, business agent of No. 37, Brother Mitcheal and the writer.

Met Mr. Murphy on November 5 in his office, and at once opened up the cause of trouble at Rost Station, the committee going over the entire situation with him, and ended with the following statement from the proprietor of the Murphy Iron Works, assured the committee he had several more tanks to erect and would put our men on them, but job where men struck on several occasions refused to reinstate all in a body, but had no objection if they could find boarding accommodations on the job.

From statements made by several brothers at special meeting November 4, both were responsible for trouble at Rost Station, La., the men on the job and the foreman, also.

First. The men agreed to work on job under certain conditions and scale of wages, which seemed to be satisfactory, \$4.25 for caulkers, \$4 for riveters and \$3.50 for helpers. That's where a fatal mistake was made, as the New Orleans scale was 25 cents higher; further, all men hired by the company at New Orleans got transportation to job and board while at work; yet many of the men knew the conditions and hired on job; afterward called a strike because some brothers who complied with instructions of Lodge No. 37 got theirs.

Second. Too much booze furnished through orders given by the foreman on job; this charge can be proven according to information given by many of the men who worked on job, if an investigation is made, also discrimination of the rankest kind against some of our men on job, and so notified the management November 10 which changed conditions somewhat.

Another special meeting of No. 37 was called November 7 to hear the report of committee appointed for November 4 to wait on the Murphy company, which made the following recommendation that pending grievance at Rost Station, La., be called off and an effort made to secure an agreement for Lodge No. 37 with the various boiler firms in the city of New Orleans. Before voting on the committee recommendation, I urged every member present to vote for the best interest of the International Brotherhood and Lodge No. 37, allow no brother to influence another in casting his vote. After an all-around discussion on the proposition by many members on the floor, a vote was taken, which was unanimous in favor of the committee's recommendation.

November 8, with same committee, had a meeting with the management of the Johnson Iron Works, going over the industrial situation in connection with the boiler makers and helpers of New Orleans and vicinity, explaining the many reasons why an agreement was necessary in order to prevent hasty action of labor disputes in the future. Many other matters were discussed during meeting, which are unnecessary to report at the present time, but may in the future if matters are not changed on a business basis in the interest of the boiler makers and helpers as a whole at New Orleans. Before leaving the office of the Johnson Iron Works, recommended that a joint conference be held between a committee from Lodge No. 37 and the boiler shop proprietors, in order to get down to business on shop conditions and wages. There was considerable opposition to a move of that kind, but finally agreed to do so, providing the other firms would do likewise; we next called on the management of the Murphy Iron Works, Dussal Iron Works, and the Stern Foundry, Boiler & Machine Works, all of whom agreed to meet a committee when conference was arranged.

November 13, in company with Brothers Shea and McCabe of Lodge No. 442, attended a regular meeting and smoker of Lodge No. 206, the majority of whose members are employed at the Texas Pacific shops, Algiers, La. Promptly at 8 o'clock, Brother Koenig, president of Lodge No. 206, called the meeting to order; during meeting many propositions came up in the interest of the Brotherhood, which were handled in a business-like manner and according to the constitution; several applications for membership were acted on; also, two new members were initiated. Under the good and welfare of the union, the visiting brothers were called on for short addresses on the International Brotherhood and New Orleans Lodges Nos. 206, 442 and 37.

Brother Shea was the first speaker; his remarks were given the closest attention by every brother present, as he touched upon many vital questions that affected the boiler makers and helpers at this time, owing to

depressed business conditions which have reduced shop forces to a considerable extent. He urged closer co-operation in the future, so as to place the trade of boiler making and iron ship building in a position from a mechanical viewpoint where the trade should have been years ago, and hoped that the membership would realize one important fact that legislation in this age of modern progress was an absolute necessity to protect our interests and elevate our craft, and closed his remarks in urging all present to never allow personal feeling to interfere when questions of importance were at stake, and all questions were important, when working conditions and wages were the issues.

Brother McCabe of No. 442 was the next speaker, and stated that when he received the invitation of No. 206 to attend their regular meeting and smoker he fully intended to make an address, at least one of appreciation, as it always was a pleasure to him as well as every member of Lodge No. 442 to attend a meeting of Lodge No. 206, had prepared a speech for the occasion, but after Brother Shea's address, he concluded to reserve his right for a future meeting, which was satisfactory to the chair. Brother Smith of Lodge No. 37 was next called on; responded all right in a humorist recital of conditions in the past, and what is necessary to be done in the future, and in closing his remarks told the members present that they all knew him, was right on the job and was there to say.

The next speaker was Brother Henry, who gave a pretty good account of himself, as well as the conditions in the port of New Orleans, and didn't hesitate to state plain facts, either; he has the correct line on the situation in the Crescent City, and is somewhat of a diplomat all right, as his explanations of complex conditions among the boiler makers and helpers on that occasion and how to change them, is the correct move to get better results in the future.

Next on the program was Brother Barry, Recording Secretary of Lodge 206, an old time member of the Brotherhood, was with the movement way back years ago, when Billie Gilthorp was a chairman of the boiler makers' committee and secured the 9-hour day in the port of New Orleans. Brother Barry explained many amusing incidents which occurred in the good old days long ago, when boiler makers stood up, like trade unionists in an honest effort to better their conditions, which made many of the younger members sit up and take notice.

There are many old members faithful and loyal to the Brotherhood in New Orleans, and among others is the old reliable Brother Coughlin. May his shadow never grow less, a good conservative member always on the job, either at the laying bench or lodge meeting. May he live to enjoy many years of health and prosperity, is the most sincere wish of the writer.

Brother Reynolds is the active Financial

Secretary of Lodge 206, always at his desk when meeting is called to order, to attend to the stamp end of his lodge in order to keep every member square with the International.

Brother Kenny and his committee on refreshments were on the job sure, as everything good for the inner man, which New Orleans is noted for, was served in a way that was appreciated by all present, with a sparkling beverage to cheer the boys, and union made cigars to while the time away, while songs were sung and yarns told of the boiler makers and helpers of New Orleans in the years gone past, when friction was unknown, after which that, faithful president of Lodge 206 (Brother Koenig), closed the meeting in due form, all departing for their homes pleased with the business transacted, as well as an evening of genuine pleasure to all present.

November 14, left New Orleans for Mobile, Ala., to straighten out a financial matter between Lodge 112 and the International Secretary-Treasurer's office; found industrial conditions there in pretty bad shape in both railroad and contract shops, but all are looking forward for improved conditions in the near future.

Owing to the conditions at Mobile it seemed impossible to get a meeting of Lodge 112, but had a meeting with the President and Secretary, who assured me that reports would be mailed regular in the future in order to comply with the Constitution, after which I returned to New Orleans to meet the managers of the Johnson Iron Works, Murphy Iron Works, Dussel Iron Works and the Stern Foundry, Boiler and Machine Works, as previously agreed to, and expect to attend a meeting of Lodge 112, Mobile, on my way home.

November 25, attended a regular meeting of Lodge 37, at which many questions came up for considerable action, and among others were two proposed agreements with the above firms in this city, one for the Boiler Makers and Helpers in New Orleans and vicinity, the other for all members of 37 employed in the construction of tanks; which was approved of after considerable discussion, after which a motion was carried that a committee be appointed to investigate conditions at Rost Station, La., as the Murphy, Threadwell and Ritter and Conley firms have several tanks under construction there, and report back to Lodge 37 at a special called meeting, if committee deemed necessary. The following members of 37 composed committee: Brother Curry, business agent; also Brothers Barker, Vallega and Oltman.

November 26, in company with the above committee, held a meeting with the representatives of the following named firms: Murphy Iron Works, Johnson Iron Works and Dussel Iron Works. Owing to pressing business matters the representative of the Stern Foundry, Boiler and Machine Works could not attend, but had a conference with him in his office, November 27th. The

above conference was a very important one for the Boiler Makers and Helpers of New Orleans, as the above firms agreed to recognize the International Brotherhood of Boiler Makers, Iron Ship Builders and Helpers of America, through an agreement, and it was agreed before we adjourned to present one to each of the above firms for their approval and signature, with the exception of the Johnson and Murphy Iron Works, who gave their reasons for objecting to sign any agreement, which seemed to be satisfactory to the members of Lodge 37, at least at present. It was understood that the other firms favorable to joint conference would sign an agreement with Lodge 37 without any hesitation whatever; in fact they told me so, but later on refused for some reason or other, best known to themselves. The members of Lodge 37 know it, and the reason will be settled at once for all in New Orleans in the very near future, as the Boiler Makers and Helpers of New Orleans realize that they are up against it, and see absolute necessity of getting closer together as they can't afford to be double-crossed any longer and allow the condition of affairs to exist, that don't exist in any other city or town in America.

New Orleans is a growing commercial city as well as a manufacturing center, with all the natural advantages for even greater prosperity in the very near future. As such, therefore, we should be active in our interests by building up, and perfecting a united lodge of the International Brotherhood on a business basis not for the protection of a chosen few, who bask in the sunshine of those who oppose any more of co-operation, knowing that the Boiler Makers and Helpers' interests are safe, when unity exists, and unity must exist if we intend to get results in keeping pace with the industrial development of the Crescent City. The past must not be considered. On the contrary we must look to the future very carefully as the welfare of the members and their families, both financially and otherwise, depend on the business methods of conducting the affairs of the Brotherhood, always electing lodge officers on their past records for good business, not on their popularity with the members, but on the contrary on their ability to hold such positions with credit to the lodge they represent as well as the International Brotherhood, hewing at all times to the constitution and enforcement of it, for such is the key to success, either from a local or national standpoint, as discipline inspires confidence, and where confidence exists the future power of the Brotherhood to do things and get there is assured.

As the tangle in New Orleans and vicinity is not settled by any means, at the conclusion of this report, will close in thanking the officers and members of the three lodges in New Orleans, 442, 206 and 37, for their active co-operation and kindness rendered while trying to adjust a com-

plicated grievance of long standing there. It will be settled later on, with at least some protection to the members, as a whole, and credit to the International Brotherhood. I remain,

Yours fraternally,
THOS. NOLAN.

REPORT OF FOURTH VICE-PRESIDENT WEYAND.

Cleveland, Ohio.

The following is my report for October and November:

On my arrival in Cleveland on October 1, 1914, I started an organizing campaign in the interest of Lodge No. 5. Owing to the long continuous strike on the New York Central lines, a large number of our members have gone elsewhere to look for employment and a number of our members became delinquent. Hence the organizing campaign, and with the co-operation of Brother G. H. Brady, B. A., of Lodge No. 5, I visited all boiler shops in the city to meet and talk to the delinquent boiler makers and helpers, relative to their reinstatement. Realizing that I would have to leave Cleveland in a short time to attend our annual meeting of the Council, I arranged to defer the open meetings until I returned from Kansas City. On October 9, 1914, I left Cleveland for Kansas City, where I was detained as a member of the Council in handling such grievances and other matters which came before the Council while in session up to October 26, when the Council adjourned, and as usual each councilman receives instructions from the International President as to what work he is to take up after leaving Kansas City. In accordance with my instructions, I left Kansas City on October 26, for Atlanta, Ga., where I arranged to handle two law suits brought against our organization and our Journal by I. A. Reeves, a former member of Lodge No. 2. I arrived in Atlanta on October 27, met with Brother John Fitcher, Secretary of Lodge No. 2, made arrangements to meet Brother Fitcher, the following day in order to consult and engage an attorney to protect the interests of our organization. On October 28, Brother Fitcher and myself had a conference with John Y. Smith, an attorney, in regards to both cases. Also visited Brother Jerome Jones, a representative of the A. F. of L., for advice relative to the qualifications and attitude of Attorney Smith in labor cases. On the recommendation of Brother Fitcher and Brother Jones, I engaged Attorney Smith to defend the International in two law suits for libel, brought by I. A. Reeves, for being published in our official Journal, for refusing to obey the strike order on the Nashville, Chattanooga and St. Louis Railroad, ordered by a vote of the men over a year ago. Brother Fitcher and myself arranged to put all evidence and records of the local trial committee into the hands of Attorney Smith and have him file his answer to said suits at once. I was informed by Attorney

Smith that it would take a few weeks before said cases would come up for trial, and in accordance with the International President's instruction for me to take up the St. Louis controversy, I left Atlanta on October 30, went to St. Louis. In making arrangements to handle the St. Louis controversy it was necessary for me to get all data in connection with the entire case. On November 3, I went to headquarters for all necessary information. I returned to St. Louis November 5, and arranged to meet a committee of Lodge No. 27, November 5, and arranged to meet a committee of Lodge No. 27 to go over the entire matter as man to man, and from a standpoint of good business. I may say in taking up this controversy I felt I should have some assistance in meeting the arguments of an entire committee, therefore, I requested Brother Hinzman to have Vice-President Maher come into St. Louis for a few days. On November 6, Vice-President Maher and myself met a committee of five members, representing Lodge No. 27. I informed this committee that the Council requested me to visit St. Louis and ascertain if the members of Lodge No. 27 had made up their mind to do business with the International. If that was not their intention, the officers be requested to turn in the charter, all money and property of the organization. We had several meetings and many matters were gone over, pertaining to the controversy. But there was only one question to be decided, was it the desire of the members and officers to again put Lodge No. 27 in good standing with the International. I may say, I found this sentiment prevailed amongst the committee of Lodge No. 27. We assured them we would be fair in trying to work out a settlement. The committee informed us they had only a limited amount of money at their command and were willing to help work out a settlement under such terms after considerable discussion as to the amount they ought to pay. The following proposition was submitted by the committee: We agree to pay in cash, \$1,075.00, this amount to include the payment of our old bill and the reinstatement of 139 members, including boiler makers, apprentices and helpers. I agreed to submit their proposition to the International President and the Executive Council and if they sanctioned the settlement on those terms, I would close up the St. Louis controversy. The proposition was submitted to Council in document, the vote of the Council being favorable. I closed up the St. Louis controversy on their terms. I then arranged a meeting with Lodge No. 27, also a meeting with Lodge No. 51, which were to be held as soon as possible. In the meantime I visited some of the shops in St. Louis, including the Terminal Railroad and Missouri Pacific shops. November 16, had special meeting with Lodge No. 27 for the purpose of talking to the members on the question of consolidation of Lodge No. 27-51. No-

ember 17, I attended a meeting of the newly organized local of Terminal Boiler Makers and Helpers. Installed their officers and talked to the members on the benefits of the new laws and the organization in general. November 18, I attended a special meeting of Lodge No. 51. Had a very nice meeting, talked on the question of consolidation of the two lodges in order that they may be able to employ a business agent to look after the interests of the members. At the meetings of Lodge No. 27-51 they appointed a committee of each lodge to decide upon some plans of co-operation and consolidation. November 21, I came to Cleveland to again take up the organizing campaign for Lodge No. 5; sent out a large number of letters and arranged for an open meeting for delinquent members. November 30, had a very large open meeting in the interest of Lodge No. 5, with a good corps of speakers to interest the delinquent members. The principal speaker was our Seventh International Vice-President, Brother M. Maher, who was in Cleveland in connection with officers of the Blacksmiths, Machinists and Carmen and a federated committee of the Wheeling & Lake Erie Railroad, for a conference with the officials. Vice-President, Brother Horn, of the blacksmiths, also attended this open meeting and appealed to the boiler makers and helpers to get together and strengthen Lodge No. 5 to bring about better conditions in the city of Cleveland. From present indications the organizing campaign is a success and we hope to build up Lodge No. 5 to its former standing. This concludes my report to December 1, 1914.

Trusting the same is satisfactory and wishing all our members a Merry Christmas and a Happy and Prosperous New Year, I am.

Yours fraternally.

LOUIS WEYAND,
Fourth Vice-President.

REPORT OF VICE-PRESIDENT MAHER.

At the conclusion of my last report, was in Pittsburg, Pa., reorganizing Lodge 318, and am pleased to report that the membership of 318 increased some 24 members, also have learned that since my visit to Chillicothe 15 helpers have joined our organization. I went from Pittsburg to Warren, Ohio, to try and reorganize Lodge 239, but did not meet with any success. Perhaps when conditions are better results can be attained in Warren. From Warren I went to Newark, Ohio, and succeeded in organizing the Tucker boiler shop and also several men in the B. & O. shops and look for better results there later.

From Newark I went to the council meeting in Kansas City; after council adjourned returned to Newark, Ohio, and arranged meeting which President Franklin attended and addressed on his way to Philadelphia, and believe good results will be attained from this meeting. While in

Newark I received a telegram from headquarters to go to St. Louis at once, which I did and met Brother Weyand, fifth vice-president, and we arranged a meeting with officers of Lodge 27, and after several meetings Brother Weyand and myself were able to submit a proposition to council which the council have since voted on favorably and in which Lodge 27 paid old debt to Grand Lodge and reinstated 139 members, the whole amount being a nice tidy sum, and I hope that in the near future Lodges 51 and 27 will get together, and that harmony will prevail as it should in the city of St. Louis, as there are sure some good live members in that city.

From St. Louis I went to Springfield, Ill., to attend meeting of System Federation, Wabash Railroad, and met a fine, bright lot of men. There was a jurisdictional dispute there between the boiler makers and machinists and System Federation decided in favor of boiler makers in view of the fact that they had been doing the work in dispute for 25 years. From Springfield I went to Chicago to assist Brother Coglan, business agent Lodge 39 in controversy with the Standard Oil Company, Whiting, Ind. Controversy settled satisfactorily to Brother Coglan and Lodge 39. From Chicago, I went to Conneaut, Ohio, where I found that a man named Pierce was trying to organize one big union under a set of Pennsylvania shop rules. I held a meeting of our local there and warned our men against Pierce's organization. Any one reading the constitution of said organization carefully would need no warning. While in Conneaut I received wire from headquarters to go to Massillon, Ohio, at once which I did and found that officials of Wheeling and Lake Erie Railroad had posted a notice on October 28th declaring agreement of System Federation effective October 1, 1913, null and void and submitting a set of shop rules to committee which deprived them of all rules and conditions which they had gained by years of organization. The committee at once submitted a counter proposition asking for their old rules and an increase of four cents per hour, more power to the committee. This committee is deserving of a whole lot of credit for the intelligent manner in which they handled controversy. I had the pleasure of meeting in Massillon Vice-President Roy Horn, Blacksmiths; General Organizer J. J. McEntee, Machinists, and Vice-President W. H. Ronemus, Carmen. We instructed the committee to submit company's proposition to all crafts at mass meeting and proposition was voted down unanimously by the men. We then instructed committee to take the matter up with the general manager in Cleveland which they did with no results. Then they met receivers, still no results. They then requested that management meet International officers which they agreed to do. We met management and after several hours

of argument and no results we decided to submit controversy to Judge Clark, Federal Judge, who after listening attentively to controversy, informed us he would take the matter up with receivers, and when we again met receivers we found that Judge Clark had made favorable recommendations and management agreed that if we would withdraw demand for increase, they would post a notice in all shops and roundhouses rescinding their notice of October 28th and stating that agreement effective October 1, 1913, would be continued until either party desired a change, such change to be subject to a thirty days' written notice and that all other employes in motive department would work under same conditions as they were prior to company posting notice October 28, 1914. This we agreed to submit to men in view of the fact that increase asked for was only a counter proposition. We then went to Massillon and committee submitting this proposition to men and same was accepted by all crafts at mass meeting. This was quite a victory for system federation on Wheeling & Lake Erie and their committee is deserving of all the credit and are good, live wires, all of them.

While in Cleveland I met Brother Weyand and Brother Brady, business agent Lodge 5. Brother Weyand is trying to build up Lodge 5. I attended two meetings while in Cleveland and both were very well attended, and I look for Brother Weyand to do some very good work in Cleveland. I also attended a meeting of the Carriage and Wagon Workers with Vice-President Horn, a very good meeting also. From Massillon I returned to Conneaut to attend mass meeting for the purpose of forming a System Federation. Brother Weyand, Vice-President Horn, Assistant President Knight of the Carmen and General Organizer Malloy of the Machinists, also attended meeting. We are to hold another in the near future and expect better results at the next meeting. From Conneaut I went to Newark, Ohio, where I am at this writing.

Wishing all a Happy and Prosperous New Year, I remain,

Efraternally,

M. A. MAHER,
Seventh I. V. P.

REPORT OF INTERNATIONAL DEPUTY ORGANIZER DICK

In sending my report to be published in the official Journal to give the rank and file a chance to learn what I have done since I was appointed as I. D. O., would say my work has been mostly confined to the organizing of the men in the oil fields of California and I must say it's a tough proposition in spots. I done fairly well with the men working for the Standard Oil Company, but I have been unable to do much with the men working for Lacey's or Lewellen from Los Angeles. I have visited a few of their jobs, found most of the men too busy to talk to me; I never saw such

a bunch of willing slaves in all my travels, most of this work is done on the desert, very hard to get to some of the jobs and harder to get away from them; if it had not been for some of the good fellows, and I find a good many in California, doing secret organizing on the different jobs it would be very hard for anyone to do much good, so any good that has been done I give credit to the men that has helped me in my work. A good many worked very hard to line up the unorganized, and I thank them very much.

I have gone to all places I knew there was work going on. I went to a job in Hamminton where they were building two dredges. I got there on Sunday, found the men working; I spoke to them after dinner; they told me to come back pay day, and it would be two weeks before they would get any money. I advised Brother Heller to line them up, which I understand he did. I also visited a job near Los Angeles, found the same conditions there. I had Brother Herman go out there and initiate them as I was called away.

I have been in Los Angeles a few times; never was there long enough at one time to do much good; it's a hard place at this time to do any organizing work in any craft. I believe the only way to get around it would be to have a man there for a long time, that way he may be able to do some good.

I made a trip to Arizona where I found the iron workers were doing all of our work including tanks, smokestacks and water towers. I met the iron workers' steward, and after a short talk he agreed with me it was our work, but said he was only one. I called a meeting of the boiler makers and helpers and was surprised to see so many in the hall. A few old timers who had gone delinquent but all willing to come back in the organization. I told them what was our work and to go take it, which they were willing to do. I wanted to know if they were ready to start a local and it was impossible to give out applications fast enough. I then proceeded to initiate them; after that part was over we had an election of officers, I thought every one in the hall wanted to hold office; the voting was close, but all seemed satisfied after our meeting was over. I had a committee appointed to go to the Iron Workers' meeting and show them the agreement that was made between the boiler makers and iron workers and as I had important business in Bakersfield it was impossible for me to attend the meeting. I wired the conditions to Brother Franklin; he attended to his part as I had several letters saying the boiler makers had got all the work that belonged to them and that all boiler makers and helpers were organized; also there was a good chance to organize most of the men working in the state of Arizona.

There are so many unfair firms in California, always paying under the scale and working one hour more, also many men

seeking work, it is very hard to get the conditions that belong to us. I could write a good deal more about the conditions in California, but at this time I think it best not to as I know the bosses read our Journal and would learn more than they ought to.

This concludes my report to November 1, 1914. Hoping same will be satisfactory, and with best wishes, I remain,

Yours fraternally,

JOHN DICK.

The following amounts were received and turned over by me:

Money Sent Into Local 317.		
	New Members.	Money Collected.
June.	17	\$103.50
July	17	86.50
August.	31	144.50
September.	5	17.50
October.	15	100.00
November	2	11.00
		\$ 463.00

Reinstated.		
		Money Collected.
June.	4	\$ 33.00
July.	4	53.90
August.	7	70.00
October.	5	34.10
November.	1	5.00
		\$ 196.05

Dues.		
		Money Collected.
June.		\$ 42.05
July.		119.00
August.		131.00
September.		140.00
October.		125.60
November.		51.35
		\$ 609.05

Grand total. 1,268.10

Money sent to Grand Lodge for charter, Miami, Ariz.	\$ 28.00
Money sent to Brother Herman for reinstatement.	10.00
Money sent to Brother Herman for reinstatement.	10.00
Dues collected for different locals.	30.00

Total. \$ 78.00

Total money collected. 1,346.10

JOHN DICK, I. D. O.

REPORT OF JOE REED, INTERNATIONAL DEPUTY ORGANIZER.

Editor Journal, Brothers' Greeting: In submitting my report of work performed by me since my appointment as International Deputy Organizer for the Pacific Northwest, I will endeavor to be as brief as possible.

Under instructions from President Franklin on July 1, I left Portland for Prince Rupert, B. C., to try and line up the work of building a large floating dry dock under construction for the Grand Trunk Pacific, and I am glad to say that I was successful in making arrangements for the work to be done by our members, and set the wage scale at 62½c an hour for boiler makers and 50c an hour for helpers, eight hours a day.

In response to a telegram from President Franklin I went to Vancouver, B. C., where there were several large tanks being built for the Imperial Oil Co. On arriving there I found the job had started and a large gang on the job, but not one of them had a card. I talked with several of them but only two of them consented to take out cards. I also talked with the foreman and he said he would rather have union men on the job but he was under instructions to run an open shop job, but he would give card men preference and he would work the union hours and pay the union scale, but in doing so he hoped our men would not interfere with the men already on the job. I assured him that our men would attend to their own business, then he asked me to send him three boiler makers out the next morning, which I did, and I am glad to say that these men assisted me in every way possible and in a very short time we had about thirty men on the job.

I am glad to report that I was successful in having an agreement signed up with the Wallace Ship Building Company of North Vancouver, who are at this writing very busy on a large ship repair job where most of the members of Lodge 194 are working and which has enabled me to increase our membership by twenty-three new members. Altogether I have taken about fifty new members into Lodge 194. But there are quite a bunch to be organized in Vancouver yet and the majority of them are old time members of the type well known all over the country that claim they got a dirty deal or they would never have dropped their cards. There are very good prospects for the brothers in Vancouver as there is at present under construction a large ship building yard and two dry docks, and I am going to do my best to organize every boiler maker and ship builder in Vancouver before this yard starts up.

I am sorry that there has not been much chance to do any organizing in Victoria as trade has been very dull, and on my two visits there I found most of our members out of work.

And the same can be said of Seattle where there has been next to nothing doing for this last nine months. I hope there are good times in store for both these places in the near future.

The contrary is the case in regards to Portland where all the members of Lodge 72 have been working steady for the past five months. There is at present under construction a large gas holder which I am glad to report is an absolutely fair job; also two small holders which are also fair. I was also successful in making arrangements with local contractors to send our members out of the city to several tank jobs in the following towns: Astoria, Flavel, Corvallis, Eugene, Camas and Garfield. There is at this time a large ship repair job at the Willamette Iron Works of Portland and although this firm have in the past been absolutely opposed to union labor

we have about thirty members on the job and I have succeeded in having an interview with the manager, the result of which was very encouraging, and I hope the brothers that are on the job at present will do their best and show this firm that we are the men for this class of work. And I am glad to say the manager told me they were getting splendid results and he hoped this job would be the means of bringing us closer together.

I am also glad to report steady increase in the membership of Local 72. I also visited Everett at Brother Franklin's request, and tried to re-organize Lodge 500, and am glad to state that I was successful in starting them out again with seven members. But I am afraid it will be a hard struggle to keep them together unless work picks up in this district very soon. Hoping this, my first report through the Journal, will meet with the approval of all, with best wishes to all for a Happy and Prosperous New Year, I remain,

Faternally yours,

JOE REED,
International Deputy Organizer.

REPORT OF INTERNATIONAL DEPUTY ORGANIZER SCOTT.

Albany, N. Y.

Dear Sir and Brothers:

Complying with instructions received some time ago from Vice President Hinzman, and in accordance with a decision reached by the executive council at their last meeting, requesting the organizers in the field to make a report of their work in the Journal, I wish to submit the following brief report covering the work I have done from the time I went on the road, or from September 1 to the present time.

When I received my appointment from President Franklin in the latter part of August I was instructed to proceed to Wilkes Barre, Pa., and get in touch with the men working in McCallum's shop. On arriving there I found that there was a good chance to organize these men, but that there wasn't enough men employed there at the time to start and successfully continue a lodge at Wilkes Barre. I found, on investigation, that Lodge 71 at Scranton, had lapsed, and as Carbondale was the nearest place to Wilkes Barre where a lodge existed, I decided to put those men into that lodge, at least for the time being. I want to say in connection with this that we also succeeded in getting an agreement covering this shop, a copy of which I am inclosing with this report.

From Wilkes Barre I went up to Scranton and spent considerable time trying to re-organize Lodge 71. These men are all employed in the D. L. & W. shops at Scranton. They are working under a piece work system, and like most men in shops of this kind, they are laboring under the delusion that they need no organization. Of course there are a few men working there that know better and who are willing and anx-

ious to see the lodge started again and kept going, but in spite of the assistance these few rendered, I am sorry to report that I failed on this mission, but I have no further excuses to offer, as I believe I did everything it was possible to do in order to get these men started.

From Scranton I went over to Elmira, N. Y., and re-organized the lodge in that city starting out with twelve members. This is not a very promising start, but I believe that with the assistance of these men we may be able to get started again at Sayer and that this lodge will soon grow to be many times as large as it is at present.

While in Elmira I received word to proceed to Lansford, Pa., and render what assistance I could to the members of Lodge 573 whose agreement with the Lehigh Coal and Navigation Company was about to expire. I got into Lansford as soon as I could, attended all of the meetings between the committee and the master mechanic and we finally succeeded in getting another agreement that was perfectly satisfactory to every member in the local. This is something very unusual, especially when there is no direct increase in wages, but the members of this lodge felt to a man that cutting ten hours of the week's work and the other concessions that were granted was about all they could get at this time considering the condition business was in throughout the country. I want to say for Lodge 573 that there are few lodges in the Brotherhood that has made greater progress for the last few years than they have and I believe if conditions are better when this agreement expires they will be able to replace it with one that will stand comparison with the best.

From Lansford I received orders to proceed to Mayfield, Pa., to try and organize the boiler makers and helpers working for the O. W. I was tied up for some time on this job because these men were opposed to going into Lodge 547 and wanted a charter of their own. I finally succeeded in overcoming the opposition to Lodge 547 and had those men initiated. I also succeeded while working in Carbondale in organizing the boiler makers employed in Hendricks shops. In spite of the fact that they were working short time, we succeeded in getting every boiler maker employed there into the organization; about this time I had reasons for suspecting that things were not just what they should be in Lodge 547, and on reporting same to President Franklin I received instructions to remain in Carbondale and go over the affairs of this lodge. I am not going to try and describe here the conditions I found this local's affairs in; things were certainly in an awful mess; there hadn't been an audit made in over three years, and very few records kept or minutes recorded. One or two men were conducting the affairs of the lodge and doing things to suit themselves. Members who had been paying their dues regularly and should have had stamps in their books

were carrying around receipts from the secretary instead, and the money that should have been used to purchase stamps from the I. S. T. was spent defraying the expense of a standing delegate to the System Federation and for other purposes. We succeeded in time in getting things cleaned up and an audit was made for three years to date. At the meeting the report was made, all offices were declared vacant and a new set elected. The secretary and treasurer was each placed under bond. The lodge is now in first class running condition, the membership has been increased from twenty-two in September, to over sixty in November. Every boiler maker today employed in or around the city of Carbondale is a member of Lodge 547 and I sincerely hope that it will remain that way.

The members of this lodge I believe have been learned their lesson and I look to see more interest taken in the local in the future than there was in the past.

I also wish to report having reinstated two ex-members of Lodge 71, one of them was reinstated through the Grand Lodge at his own request, the other through Lodge 547.

I want to say in conclusion that I am now making a trip over the D. & H. from Watervite to Plattsburg under instructions from Brother Hinzman, and I hope in my next report to be able to show good results.

Respectfully submitted,
CHAS. F. SCOTT, I. D. O.

REPORT OF DELEGATES TO THE A. F. OF L. CONVENTION.

To the Officers and Members of All Subordinate Lodges, Greeting:

Your delegates to the metal trades convention, also to the American Federation of Labor, desire to report briefly the actions taken upon some of the most important matters that came before the convention.

The Metal Trades Department of the American Federation of Labor convened November 5 at Walton Hotel, Philadelphia, Pa. Reports of the officers, president and secretary, were printed in pamphlet form and distributed among the delegates the first day of the convention. These reports covered the work accomplished and undertaken by the department during the past year. They also contain such recommendations as in their judgment, would advance the interests of affiliated organization. One of the principal subjects handled by the department was the recommendation of the Executive Council of the American Federation of Labor dealing with the laws of the American Federation of Labor for the government of the several departments which are chartered by the American Federation of Labor and which is given herewith in full:

Article XV.—General Rules Governing Departments of the American Federation of Labor.

Section 1. For the greater development

of the labor movement, departments subordinate to the American Federation of Labor are to be established from time to time as in the judgment of the American Federation of Labor, or of its Executive Council, may be deemed advisable. Each department is to manage and finance its own affairs.

Sec. 2. To be entitled to representation in any department, organizations eligible to join it must first be and remain in affiliation to the American Federation of Labor.

Sec. 3. To be entitled to representation in local councils, or railway system federations of departments, local unions are required to be part of affiliated national or international unions affiliated to departments, or of the American Federation of Labor. Said local unions shall first be and remain in affiliation to central labor unions chartered by the American Federation of Labor.

Sec. 4. The fundamental laws and procedure of each department are to conform to, and be administered in the same manner as the laws and procedure governing the American Federation of Labor. No department, local council, or railway system federation of same shall enact laws, rules, or regulations in conflict with the laws and procedure of the American Federation of Labor, and in the event of changes of laws and procedure of the latter, departments, local councils, and railway system federations are to change their laws and procedure to conform thereto.

Sec. 5. Each department to be considered the official method of the American Federation of Labor for transacting the portion of its business indicated by the name of the department, in consequence of which affiliated and eligible organizations should be part of their respective departments and should comply with their actions and decisions, subject to appeal therefrom to the executive council and the conventions of the American Federation of Labor. When an organization has interests in departments other than the one of its principal affiliation, it is to be represented in and pay per capita tax to the other departments upon the number of members whose occupations come under such other departments.

Sec. 6. Departments of the American Federation of Labor are to have their headquarters located in the city of Washington, D. C., and if possible in the same building with the headquarters of the American Federation of Labor.

Sec. 7. Departments of the American Federation of Labor shall hold their conventions immediately after the convention of the American Federation of Labor and in the same city where the convention of the American Federation of Labor is held, at which time and place their laws and procedure shall be made to conform to the laws

and procedure of the American Federation of Labor and to go into effect the first day of January immediately following, to conform to the date when the laws and procedure of the American Federation of Labor go into effect.

Sec. 8. The executive council of each department shall consist of not more than seven members, including the executive officer or officers thereof.

Sec. 9. The officers of each department shall report to the executive council of the American Federation of Labor that the department has conformed to the laws, procedure, and actions of the American Federation of Labor as they affect each department.

Sec. 10. In the building trades department (on the basis of its law of 1913), organizations having seven or more delegates, each such delegate shall on roll-call be entitled to two votes. A roll-call shall be held upon the demand of one-fourth of all delegates whose credentials have been accepted and who have been seated in the convention.

Sec. 11. The officers of the various departments shall submit a quarterly report to the executive council of the American Federation of Labor of the work done by their department, and its general conditions.

Sec. 12. At all regular meetings of the executive council of the American Federation of Labor, there shall be present during some period of the council meeting, the executive officer or officers of each department, to take up with the council matters that may be of mutual interest.

Sec. 13. A page of each issue of the American Federationist to be available to, and to be used by each department for official report or for publication of some subject identified with the department, each department to designate its officer to submit the report.

Realizing that the departments will find it necessary to change several of their laws, modes of procedure, and other matters affecting them by reason of the adoption of the laws and recommendations we have above submitted, and that it will require some considerable time to put them in practical operation, we submit the following so that time and opportunity may be afforded the departments to conform to the new law and regulations:

Resolved, That Article XV of this constitution as adopted by this convention shall go into full force and effect and be a part of the constitution of the A. F. of L., on and after March 1, 1915. And in the meantime, that is, up to said March 1, 1915, Article XV of the Constitution of the A. F. of L., as it now exists, shall be in full force and effect.

Inasmuch as this law, if adopted would necessitate the changing of the laws of the department to conform to the laws of the

American Federation of Labor, the department took a recess until the American Federation of Labor had concluded its work. The convention was reconvened Sunday, November 22 and completed its work by making such changes in the law as was made necessary by the adoption of the foregoing recommendations which were modified and amended in order to permit the railroad department to maintain headquarters and to hold its conventions at such time and place as best conform to the needs of the department.

I am also giving herewith Section 5 with the recommendations of the committee which were adopted, dealing with the per capita tax and the method of paying same to the departments.

Sec. 5. Each department to be considered the official method of the American Federation of Labor for transacting the portion of its business indicated by the name of the department, in consequence of which affiliated and eligible organizations should be part of their respective departments and should comply with their actions and decisions subject to appeal therefrom to the executive council and the conventions of the American Federation of Labor. When an organization has interests in departments other than the one of its principal affiliation, it is to be represented in and pay per capita tax to the other departments upon the number of members whose occupations come under such other departments.

We recommend that the words "in which it shall pay per capita tax upon its entire membership" be inserted immediately after the word "affiliation," in the seventh line of Section 5, and that the words "but this in no instance shall be less than 20 per cent of the membership upon which it pays per capita tax to the American Federation of Labor" be added immediately after the word "departments" in the last line.

A motion was made and seconded to adopt the recommendation of the committee.

Also Sections 7 and 8 as they were adopted by the convention:

The report of the committee was adopted, and the section as amended reads:

Sec. 7. Departments of the American Federation of Labor shall hold their conventions immediately after the convention of the American Federation of Labor and in the same city where the convention of the American Federation of Labor is held, at which time and place their laws and procedure shall be made to conform to the laws and procedure of the American Federation of Labor and to go into effect the first day of January immediately following to conform to the date when the laws and procedure of the American Federation of Labor go into effect. For reasons of transportation, expediency and the methods of representation the railroad, metal trades

and mining departments may hold conventions at other dates and places, and in that event said departments shall authorize their executive boards to have said departments' laws conform to the preceding portion of this section.

Sec. 8. The executive council of each department shall consist of not more than seven members, including the executive officer or officers thereof.

Your committee recommends that the words "this not to apply to or interfere with the procedure on this subject found to be essential in the railway department," be added.

The recommendation of the committee was adopted, and the section as amended by the committee, reads:

Sec. 8. The executive council of each department shall consist of not more than seven members, including the executive officer or officers thereof. This not to apply to or interfere with the procedure on this subject found to be essential in the railway department.

The foregoing sections contain the principal changes made by the committee and the convention in the recommendation contained in Article 15 and recommendation by the executive council. Your delegates were opposed to and voted against the adoption of this law for the reason that we believe the departments should have autonomy in regulating their own affairs and in the adoption of such laws for their government as would best suit their needs. We trust, however, that this law will work out satisfactorily, but in the event it proves unsatisfactory and acts as a detriment to the departments, it should be repealed or amended at the next convention.

The following officers were elected for the coming year: Jas. O'Connell, President; A. J. Burres, Secretary-Treasurer; Jas. W. Kline, 1st Vice-President; J. A. Franklin, 2nd Vice-President; T. M. Daly, 3rd Vice-President; John R. Alpine, 4th Vice-President; J. J. Hynes, 5th Vice-President; Jas. Valentine, 6th Vice-President.

THE AMERICAN FEDERATION OF LABOR CONVENTION.

The 34th annual convention of the American Federation of Labor convened in Horticultural Hall, Philadelphia, Pa., November 9, and continued in session until November 21. There were 358 delegates, representing 92 International and National Unions, 22 state federations, 70 central bodies, 18 local trades and Federal Labor Unions, and 7 fraternal delegates.

Statistics furnished by Secretary Morrison shows a net increase in membership of 1913 of 24,667. When the industrial conditions are taken into consideration, the showing made by our movement is very creditable.

The report of the Executive Council of the American Federation of Labor is a very interesting document. It is not only

voluminous, dealing with a vast number of subject matters, but is replete with interesting facts and information covering every phase of our industrial, social and economic conditions. This report is contained in the printed proceedings of the convention and can be had by writing to Secretary Morrison of the American Federation of Labor, Washington, D. C., and inclosing 25 cents to cover printing and postage.

Resolution 141, which was introduced jointly between our organization and the machinists with reference to the proposed amendment to the locomotive boiler inspection law now pending in Congress, pledges the American Federation of Labor to the support of a bill to be drafted and introduced and enacted into law, if possible, which will cover the inspection of locomotive boilers, engines, tenders and their appurtenances. Such inspections to be done by men who have had practical shop experience in their respective trades and the wording of the bill to be such that none can qualify except those who have had practical shop experience. I am giving you herewith the resolution as adopted by the convention.

Resolution No. 141—By Delegates J. H. Franklin, of the International Brotherhood of Boiler Makers, Iron Ship Builders and Helpers of America; W. H. Johnston, of the International Association of Machinists:

WHEREAS, We now have a law enacted by the Sixty-first Congress, known as the locomotive boiler inspection law, which provides for the inspection of locomotive boilers and their appurtenances, and,

WHEREAS, This law, in Section 3, provides that the chief inspector and his two assistants shall be selected with reference to their practical knowledge of the construction and repairing of boilers and to their fitness to systematize and carry into effect the provisions thereof relating to the inspection and maintenance of locomotive boilers; and,

WHEREAS, Section 4 of this act provides in part that there shall be appointed 50 district inspectors, and further provides that in order to obtain the most competent inspectors possible it shall be the duty of the chief inspector to prepare a list of questions to be propounded to applicants with respect to construction, repair, operation, testing and inspection of locomotive boilers and their practical experience in such work; and,

WHEREAS, The chief inspector promulgated rules as provided for under this act which admitted and made it possible for applicants to qualify as inspectors, likewise without practical experience in the construction, repairing and testing of boilers; the rules adopted also provide that the common carrier operating a railroad must inspect its locomotive boilers at stated intervals and report to the district

inspector under oath the result and finding of all such inspections, which results in the employes of the carrier, who must be men of years of practical experience, reporting to men who are lacking in practical experience, and consequently are incompetent to either pass upon, offer suggestions or issue instructions in furthering or putting into effect such measures as are essentially necessary to the fulfillment of the purposes of said act of February 17, 1911; and

WHEREAS, There was introduced in the Sixty-third Congress bills known as Senate Bill S. No. 6165 and House Bill H. R. 17894, amending the present locomotive boiler inspection law to cover the inspection and to bring under the supervision of the Boiler Inspection Bureau the engine and tender and their appurtenances, and providing that the present inspectors of the Locomotive Boiler Inspection Bureau shall have the same supervision and authority over the engine and tender and their appurtenances that they now have with respect to the boiler of a locomotive and the appurtenances thereof; and

WHEREAS, If the act of February 17, 1911, as amended in accordance with the provisions of Senate Bill No. 6165 and H. R. 17894, the result will be that inspectors who have no practical experience in the construction, repair and inspection of engines and tenders and the appurtenances thereof will be appointed, as is now the case, with respect to the locomotive boiler and its appurtenances; and,

WHEREAS, It is recognized and conceded by all practical mechanical men who have supervision over the construction, maintenance and inspection of locomotive boilers of the railway systems of this country, not over 20 per cent can qualify or come up to the desired standard required by the railways themselves. It must be self-evident that in appointing men to these important positions who are without practical experience, few, if any, can qualify or come up to the standard demanded by the act herein specified. And we contend that a competent boiler inspector will not make a competent inspector of engines and tenders and its appurtenances, for the reason that he has not had the necessary technical training, and that most essential qualification, practical experience; therefore, be it

RESOLVED, That this, the Thirty-fourth Annual Convention of the American Federation of Labor, go on record as favoring the appointment of inspectors with practical experience in addition to the other qualifications demanded by the Boiler Inspection Bureau; and be it further

RESOLVED, That the officers of the American Federation of Labor be instructed to co-operate with the organizations directly interested who are affiliated to the American Federation of Labor in drafting a suitable bill and in having it enacted into law to cover the inspection of locomotive boilers, engines and tenders and the ap-

purtenances thereto, said proposed bill to contain provisions for the appointment of inspectors having practical shop experience, clearly specifying and recognizing the indisputable fact that none but those who have had such practical experience in their respective callings can qualify for these positions.

The committee recommended the adoption of the resolution as amended.

A motion was made and seconded to adopt the recommendation of the committee.

Carried.

It is our intention to have this bill drafted and introduced immediately after the first of January and we shall do all within our power to secure the enactment of the legislation proposed and outlined by the above resolution in order that competent and efficient inspection of locomotive boilers, engines and their appurtenances may be had.

The same staff of officers were re-elected and Mr. Wm. Green, secretary of the United Mine Workers of America, was elected to fill the vacancy on the council which was caused by President White of the Mine Workers declining to accept the position of vice-president of the American Federation of Labor after his election at Seattle convention in 1913.

The convention finished its business and adjourned sine die at 11:45 p. m., November 21.

BUILDING TRADES DEPARTMENT.

The executive council in their October meeting authorized the president to again make application to the Building Trades Department and instructed that Brother Dohney of Lodge No. 1, of Chicago, Ill., accompany the International president in presenting our case to the delegates of the Building Trades Department, and we are more than pleased to report that our application was acted upon favorably by the convention on November 25 and we were admitted into affiliation with the Building Trades Department.

The next convention of the American Federation of Labor, also the Metal Trades and Building Trades Departments will be held in San Francisco in November, 1915.

There were many matters came before the different conventions in which our organization was interested and your delegates did everything in their power to see that our rights were fully protected. We desire to express to the membership our appreciation for the honors conferred upon us in being selected to represent the organization at the American Federation of Labor and Department conventions, and wishing you one and all the compliments of the season, and with best wishes, we are,

Yours fraternally,

J. A. FRANKLIN,
WAID B. GRAHAM,
M. J. McGUIRE.

Agreements

(Copy.)

This agreement made and entered into this 10th day of September, A. D. 1914, between the McCallum Machine Company of Wilkes Barre, Pa., of the first part, and the International Brotherhood of Boiler Makers, Iron Ship Builders and Helpers of America, of the second part, witnesseth:

Article 1.

This agreement shall become binding on the parties hereto and take effect on theday of....., 1914, and continue in force until superseded by another.

Article 2.

All boiler makers' work done by the party of the first part of the first part shall be done by members of the International Brotherhood of Boiler Makers, Iron Ship Builders and Helpers of America.

Article 3.

Nine (9) hours shall constitute a day's work, and all work performed over nine hours will be paid for at the rate of time and one-half and double time for Sundays and holidays.

Article 4.

The minimum rate to be paid by the party of the first part for boiler makers shall not be less than thirty-two (32) cents per hour.

Article 5.

In the event that either of the parties to this agreement desires to change the same or any part thereof, the said party so desiring the change shall give thirty days' notice in writing to the other party, specifying in the written notice the change or changes desired.

IN WITNESS THEREOF, the parties hereto have caused this agreement to be duly executed the day and year first above written.

THE McCALLUM MACHINE COMPANY,
By JOHN MacCULLUM.

Attest:

THE INTERNATIONAL BROTHERHOOD
OF BOILER MAKERS, IRON SHIP
BUILDERS AND HELPERS OF AMER.
ICA,

By CHAS. F. SCOTT, Organizer.

Correspondence.

A COMMUNICATION FROM PRESIDENT WHARTON OF THE RAILWAY DEPARTMENT.

St. Louis, Mo., Dec. 1, 1914.

The circular letter sent out by the Grand Lodge officers under date of October 31, in which notice was given of the discontinuance of strike benefits on the Harriman, Illinois Central and Pere Marquette roads, after December 1, 1914, has resulted in a number of resolutions being adopted, also letters from a few individual members, the trend of which has been a general denunciation of the Grand Lodge officers, the Railroad Department and everyone else who dared to express an opinion contrary to that held by those who are responsible for the issuance and publication of resolutions and letters that fall far short of stating facts, but rather tend to express the views of those who have not given the matter due consideration.

As a matter of fact, we must not lose sight of the rights of all our members, whether working for a railroad company or engaged in other industries, fully fifty per cent of the members belonging to organizations represented in the circular of October 31 are not employed in the railway industry, and another very large percentage was not employed on the Harriman, Illinois Central and Pere Marquette roads at the time the strike was inaugurated. We might in justice to the vast majority of the members, ask the Harriman, Illinois Central and Pere Marquette strikers how many of the rank and file of the respective organizations were consulted, or had any voice in the movement that resulted in these strikes? Yet, their membership and dues and assessments have made it possible to continue these strikes for over three years. Many of these members are working under most unsatisfactory conditions of employment, and have proven their loyalty by contributing their moral and financial support to their fellow members on strike, they have not only done this, but they have continued to work under these unsatisfactory conditions, foregoing the opportunity to help themselves in order that they might help the men on strike; at least some of the organizations have reached the limit of their finances and in such an extremity there is but one course to pursue—notify the men on strike of their inability to pay strike benefits. This has been done.

The next question that confronted your officers was, Would it be fair to discontinue the strike benefits without giving the men an opportunity to say whether or not they desired to continue a strike under these conditions? We have every reason to believe that had we adopted any other method we would have been justly open to severe criticism.

It has often been stated that approximately 35,000 men came out on strike. Has anyone stopped to consider just what it would cost to pay strike benefits to such a large number of men? Then, again, we must stop and consider just how many men of this vast number have remained on picket duty after they failed to receive benefits, and again we must consider just how many of those who are now on picket duty will remain when benefits are discontinued. Your officers did the only thing that could be done under the circumstances. To discontinue strike benefits without giving the men a chance to say whether or not they desired to continue the strike under such conditions, would have been unfair to those who have stood the brunt of the fight; we would have been accused of forcing men to do one of two things, either quit the strike, or go to work on the struck roads. If the strikers vote to continue the strike without benefits, then they have decided the question for the time being.

The circular sent out to the membership is a plain statement of the conditions now confronting at least a majority of the organizations we endeavored to avoid being accused of trying to influence the vote either for or against the proposition. We give the men full credit for the splendid efforts put forth and the many sacrifices they have made and then asked them to decide whether or not they desired to continue the strike under the conditions that would become effective December 1, 1914.

The question of continuing a strike has often been submitted to strikers under similar conditions, and will, no doubt, be submitted in any strike of the future under the same conditions.

We have given the several protests received, a careful perusal, and this leads us to believe that few, if any, of the originators of the resolution and letters have presented thoughts or expressions worthy of true union men or men who have the qualities they claim the officers are lacking in. The methods adopted bear a close relation to the tactics and mode of procedure of certain well-known agencies engaged by certain employers in their efforts to sow the seed of dissension within our ranks, hoping thereby to create a suspicion in the minds of the members against the honesty and integrity of the officers, which would naturally weaken if not disrupt, our movement.

The campaign of unwarranted vilification and abuse directed at the officers and the wide publicity made available through the columns of the Strike Bulletin and the Railway Federationist certainly cannot be expected to be of benefit either to the strikers or the organizations with which they are affiliated.

The men who have adopted such tactics are themselves guilty of the very act they would have the rank and file believe the officers have committed.

It is neither our desire nor intention to enter into a prolonged controversy with the very few who have seen fit to belittle themselves and bring discredit on the movement by their uncalled-for, cowardly attempt to discredit the officers who have fulfilled the duties of their respective officers without fear or favor.

At least four out of the five officers were acting with the full knowledge and approval of the members of their respective General Executive Boards in the discontinuance of strike benefits. The charge that these officers were attempting to call off the strike is not true, and the circular letter of October 31 will bear this out.

Reference has been made to the indorsement of these strikes by the R. E. Department convention held in Kansas City, April last; that is true; it is also true that this convention indorsed resolutions calling for financial assistance to aid the strikers, also the proposed investigation of the strikes by the Industrial Relations Commission, and the raising of funds for the defense of Carl E. Person. The Grand Lodge officers assumed the responsibility of paying for the preparing and presenting of the evidence before the Industrial Relations Commission. We carried out the instructions of the Kansas City convention in making arrangements for the defense of Brother Person; we could furnish some very interesting details in connection with this matter, but will refrain from doing so at this time. We are still indebted to Attorney Frank Comerford to the extent of some seven thousand dollars.

We have also complied with the instructions of the Kansas City convention in regard to raising funds to finance the strike. We sent an appeal to something like three thousand, five hundred lodges, comprising all local lodges of all organizations affiliated with the department. We have also appealed directly to the delegates attending the Kansas City convention, calling their attention to the action taken, and as a net result of all our efforts we herewith submit a brief summary dating from May 9 to the close of November, 1914:

Locals Contributing.	Amount.
B. R. C. of A..... 8	\$ 246.00
I. B. of B. & H..... 7	115.75
I. B. of B., I. S. B. & H..... 2	19.25
I. A. of M.....26	1,786.45
A. S. M. W. I. A..... 1	13.00
S. U. of N. A..... 1	10.00
Personal	4.00
Bal. on hand from 4-6-14....	24.50
<hr/>	<hr/>
Total	45 \$2,218.95

In regard to the Industrial Relations Commission, many of the members have an

entirely erroneous opinion of the functions of this commission. Their powers are confined to investigating the causes underlying industrial unrest and the recommending of remedial legislation; they have no authority to adjust or in any manner act as a mediator in any strike or impending strike. There is nothing in the proposition submitted by the officers that will react to the detriment of those directly concerned; we say this without fear of successful contradiction; we have had the pleasure of meeting various members of the commission and we speak advisedly. Practically the entire scope of the investigations deal with matters arising from conditions that existed prior to the appointment of this commission.

Because of the publicity given those who saw fit to rush into print and air their views before the public in general, we shall expect this statement to be given the same consideration, and it is with regret that we take this action, because we believe that matters of this kind should be handled through the regular channels of our organizations.

However, this is the inevitable result of having men editing and publishing so-called labor papers, who fail to properly safeguard the interests of the vast majority under the cloak of maintaining what they please to term "free press" and "free speech."

In the circular of October 31, we stated that we expected criticisms from certain individuals, and we say now that we welcome criticism, but some of the bulletins circulated and articles published in the Railway Federationist and the Strike Bulletin cannot by any stretch of the imagination be termed a criticism; they rather reflect a determination to coerce and intimidate the officers from performing their duty because of the fear of publicity.

The editors of the Railway Federationist and Strike Bulletin seem to fully coincide with the views expressed by some of the thoughtless and impulsive members who are so shortsighted that they fail to see that in their efforts to malign and bring into disrepute their officers, they are simply undermining the very foundation of the structure to which they must look for support.

A. O. WHARTON,

President Railroad Employes' Department.

Algiers, La.

Dear Sir and Brother:

Lodge No. 206 had the pleasure of being honored by our Second International Vice-President Thomas Nolan, the Grand Old Man of the Brotherhood, on November 13, 1914. This was the first time Brother Nolan ever visited Lodge No. 206. As the night was a stormy one, Brother Nolan had a strenuous time crossing from the New Orleans side, in company with Brothers Joseph Shea and John McCabe of

Lodge No. 442. Brother Nolan spoke on many matters of interest. He explained the good accomplished at the San Francisco convention for the uplift and protection of our members; he also explained the amendment to the Boiler Inspection Bill and why it was introduced, and appealed to all present to get interested, and be ready to act when called upon by the International President.

Brother Joseph Shea of Lodge No. 442 was the next speaker and gave us a good talk on organized labor in general and how much labor has accomplished in the last ten years. Brother John McCabe, also of Lodge No. 442, gave a short and interesting talk. Brother Charles Kenney of Lodge No. 206 spoke on conditions in the contract shops along the river front. Brother Ed Barry, also of No. 206, gave a short and interesting talk. Brother William J. Smith, the old reliable, was the next speaker, but just at this time the refreshments were about to be served, and the brother in his genial way excused himself for the present so that he could do justice to what Lodge No. 206 had prepared for the occasion; nevertheless, he gave us a good talk, anyway.

Next on the program was a song by Brother William Powers, entitled "Solomon Levy," which was enjoyed by everyone present, and it started all the members in to show how much vocal talent they possessed, before we adjourned.

Since the meeting of November 13, Brother Nolan has been doing some excellent work here, and has made many friends among the boiler makers, not to mention the numerous outsiders he met and won their confidence. Brother Nolan had ten helpers to promise him that they would put applications in Lodge No. 206 at their next regular meeting.

Am glad to say that everyone of them lived up to their promise and got in line at our regular meeting December 11. This makes the T. & P. 100 per cent organized as far as boiler makers, apprentices and helpers are concerned. The lodge gave a banquet on the head of it, and it was one of the most enjoyable evenings we have had in a long time. Brother Kenney, as usual, had the refreshments prepared and saw to it that no one was neglected. In conclusion, I wish to thank the officers and members for their co-operation in 1914 and hope the incoming officers for 1915 will show the same activity as their predecessors.

Hoping I have not taken up too much space in our valuable Journal and will see this in the next issue, I am

Yours Fraternally, JOSEPH KOENIG,
President and Cor. Sec., Lodge No. 206.

Sedalia Mo., Dec. 19, 1914.

Mrs. Jas. B. Casey,
Editor and Manager of Journal,
Dear Sir and Brother:—The undersigned

respectfully request that you publish the following as an expression of thanks or appreciation of the members of Royal Lodge No. 113, to the Brotherhood at large for their generosity in responding to the call for assistance for the wife of our worthy brother, H. Z. Wagner:

To Our International Officers and Brotherhood at Large:

This is to certify that Royal Lodge No. 113, through its secretary, has just recently received a bank draft for the sum of nine hundred and forty-two (\$942.00) dollars, made payable to Mrs. H. Z. Wagner, issued by F. P. Reinemeyer, International Secretary Treasurer, this being the amount derived from the watch raffled for the benefit of Mrs. H. Z. Wagner.

To those who were entrusted with the care of making arrangements for this very important affair, have doubtless conveyed to the members of our Brotherhood the true spirit of unionism and we should feel that we had failed to do justice to our best impulse if we did not at least try to express our appreciation for courtesies shown in our behalf. We speak this way because of the fact that Brother Wagner was one of our very best members; a good union brother who always stood ready and willing to help his fellow man if distressed.

To the brothers at large and especially to those who so generously responded to the call of our appeal for assistance, we certainly appreciate the kindness you have conveyed to our Brother Wagner's wife. We feel that our Brotherhood is going forward at such a rate that it will only be a very short time until we will be, and should be able to care for the unfortunate members of our Brotherhood and it does seem that it would be a good business proposition if each and every local lodge would install a relief fund and have their local laws made so as to protect this fund against the drawing out of any money from this fund except for the purpose specified in the laws governing this fund. This fund should be set aside for the sole purpose of helping our unfortunate brothers by using it to purchase raffle tickets or donations as a lodge gift and so on.

Again thanking all who have co-operated with us in our request for financial assistance in behalf of our unfortunate brother, H. Z. Wagner, with best wishes, a Merry Christmas and a Happy New Year to all, we are,

Fraternally yours,

W. H. SIMS,
J. L. JACKSON,
G. H. GREEN,

Committee.

Newport News, Va.

Mr. James B. Casey,
Editor Journal.

Dear Sir:

On December 9, 1914, a sad and distressing accident occurred in the yards of the Chesapeake & Ohio Railroad, Newport News, Va., which resulted in the death of

Brother W. S. Wuezbachs, a member of Lodge 292, Parsons, Kas., Reg. No. 69756.

An open space in a train of freight cars on a siding was the cause of Brother Wuezbachs' untimely end, not thinking for a moment there was any danger whatever in passing through, but was caught between the cars and almost crushed to death, as he only lived a short while after the accident occurred. Brother Milford Martin of Deer Lodge No. 528, was with him, and present when Brother Wuezbachs passed away.

Brother Healey, president of Lodge 55, who was then visiting Wheeling, West Virginia, wired Brother Hickey to have the members of Lodge 55 take charge of the body and have his remains shipped to his mother in far away Los Angeles in case a request was forwarded to do so.

The officers and members by vote of Lodge 55 desire through the columns of the Journal, to extend to his sorrowing mother and other members of his family, as well as the officers and members of Lodge No. 292, our most heartfelt sympathy, knowing that Almighty God will comfort and console them, for He doeth all things well. Although cut down in the flower of manhood yet we bow our heads in humble submission. May he rest in peace.

W. M. LECOMPTE,
W. F. McCANLEY,
JAS. E. McINTYRE,
Committee.

A LETTER OF THANKS FROM MRS. WAGNER.

Sedalla, Mo., Dec. 15, 1914.

Editor Journal.

Dear sir:—I kindly ask you to grant space in your publication for this, my letter of thanks and sincere gratitude, to all the lodges and members, also Grand Lodge officers who so generously co-operated in the watch raffle of which I am the beneficiary.

Sincerely and gratefully yours,
MRS. H. Z. WAGNER.

Dear Friend: Teague, Tex.

I am inclosing a New Year's card, thinking perhaps there may be some readers of the Boiler Makers' Journal who have just such a friend to whom they would like to send a New Year's card.

Do you know who I have sent one to? I cannot buy a present, because he is the one I have to ask for the price, so I just sent him this card. (My husband.) It is something he did not produce, and it tells him more than anything I could have given him—my gratitude to him and how much I honor his friendship and protection. This may seem out of place to some, but not to me, for I feel when my husband works hard all day in order to earn my daily bread I owe him my purest and best thoughts, so that is what I sent him for a New Year's card.

Wishing all a Happy New Year, I humbly remain,

MRS. JOHN CURE,

Lafayette, Ind.

Dear Brother and Editor:

I am returning to you the cut of the official emblem under separate cover which I hope you will receive O. K. We, the committee, wish to thank you for the use of same.

Lodge No. 360 gave its first annual card party and dance at the Bartenders' Hall, corner Third and Ferry Streets, December 12, 1914.

Starting at 7 p. m., with the card party and playing until 9 p. m. and then everyone was invited to partake of the excellent lunch of ice cream, cake, coffee and sandwiches, which were prepared free of charge.

The hall was decorated in very nook and corner. Every one present enjoyed themselves and are eagerly looking forward to the next time 360 puts on her war paint for a good time.

The prizes at cards were awarded to Brother Willus Wiendorf and Mrs. James Nelson, wife of the well known local car builder.

The rest of the evening was devoted to dancing, and as we had about seventy-five couples present the committee was certainly pleased with their effort to get out a big crowd, for it showed the people in this burg that the boiler makers were not dead. And were on the job when it came to entertaining.

The committee first appointed James A. Peacock, Richard A. Davis and John Halpins, but as we soon saw the job was too big for us to handle alone, Brother Frank Goodman came forward and volunteered to handle the refreshments and he did to everyone's satisfaction.

Brothers Frank Bongen, William H. Cassman and Charles Larhman also assisted the committee at the hall and if it had not been for the good will of the boys we would have been snowed under.

Hoping you and all the boys have a Merry Christmas and a Happy New Year and you can spare us a small space in the Journal for our little write up. I beg to remain,

Yours fraternally,
JAS. A. PEACOCK,

Corresponding Secretary, Local 360.

Tulsa, Okla.

Dear Sir and Brother:

I am sending you five names of party who got state charter of The Independent Steel Tank Builders of America. It was filed in Oklahoma City November 12, 1914. I wish you would publish in the Journal in large type so the other lodges take notice if they apply for card. Their names are W. F. Burcham, D. V. Kelly, J. W. Phillips, W. E. Etter, B. D. Fritchey. Address Drumright, Okla.

Hoping to see this in the Journal. With best wishes I beg to remain,

Yours fraternally,
M. PEASE,
Asst. Sec'y of 592.

The Brotherhood of Boiler Makers & Iron Ship Builders of America.
Gentlemen:

Replying to your request for a statement of my views regarding the proposed amendment to the Federal Boiler Inspection laws which would authorize the district inspectors to inspect the various parts of an engine, as well as the boiler.

I understand that this amendment is opposed by the railway companies, as well as by your organization. I will take pleasure in complying with your request, but the short time allotted to me to reply does not give me time to give it as much thought as I think it really deserves.

In the first place, who originated the proposed amendment? If you will refer to the Second Annual Report of the Chief Inspector to the Interstate Commerce Commission, dated November 1, 1913, you will find that it contains a recommendation for this legislation; therefore, it originated in the Chief Inspector's office in Washington, and similar to all other efforts of this character, it was immediately supported by those who might be benefited thereby. It must, however, be noted that there was no outside demand for this legislation either by the railroad companies or from the general public. What was the object?

When the boiler inspection law became effective July 1, 1911, there immediately arose a contention as to the eligibility of others than boiler makers as chief and district inspectors. It is obvious that the primary object of introducing this amendment was to defeat the boiler makers' claims to these positions rather than any special desire on the part of the originators to promote public safety.

This contention being the real reason for proposing this amendment, it is necessary that a brief reference be made to the merits of the claims of the boiler maker's organization.

The law as it now is says (Sec. 3) that the chief inspector and his two assistants shall be selected with reference to their practical knowledge of the construction and repairing of boilers.

Many boiler makers claim that this part of the law was never carried out in making the appointments. They claim that none of the men appointed as chief or assistant had a practical knowledge of the construction or repairing of boilers, the authorities making these appointments, as far as I can learn, made no extended investigation into what qualifications were necessary to construct and repair a boiler. No examinations were held to determine whether the men appointed filled the requirements of the law. It is certain that the President is not competent of his own knowledge to select men capable of constructing and repairing a boiler, without being advised.

It seems that engineers, firemen, machinists and boiler makers were held to be eligible. No boiler makers were appointed

as chief or assistant chief inspectors, and when the fifty district inspectors were appointed, it was claimed that only ten boiler makers in the entire United States could be found that were qualified to hold these positions and as a further aggravation to the boiler makers' vacancies were filled as late as July 1, 1914, without any further examinations to give the boiler makers who might have qualified themselves in the meantime, an opportunity to compete for the positions.

It would, therefore, seem apparent that boiler makers were not wanted or desired as inspectors; this naturally caused a friction. The writer does not know what authorities advised the President in making the appointments, but does know that engineers, firemen or machinists are not qualified to construct and repair a locomotive boiler. I will quote you an authority on this subject who no one can deny is one of the best informed mechanics in this country. I refer to Mr. Samuel Vauclain, Vice-President and General Manager of the Baldwin Locomotive Works. Mr. Vauclain says, in reference to a locomotive boiler:

"It is that portion of the locomotive which requires the greatest amount of thought, the greatest amount of skill and not only skill but dexterity. Huge plates must be rolled into shape, their nature must be studied, the amount of heat that can be applied, the method of turning a flange so as not to destroy the material, and a thousand other things that must come into the handling of the material which goes into the boiler. A thorough knowledge of the mechanical side, how to calculate stresses, and to correct the mistakes the draftsman is sure to make and is constantly making in the designs he sends in, and were it not for this honest criticism of designs, many and many a failure would go out from the manufacturing plant unnoticed and disaster would occur."

From Mr. Vauclain's statements, and it is also known to mechanics that to be qualified to construct a boiler there are many things necessary to know that are not taught in technical books or schools, and this knowledge can only be gained by practical experience. Therefore, a man who has not had that experience cannot possibly fill the requirements of Section 3 of the federal laws.

Self-preservation is said to be the first law of nature and in this we find the motive for the proposed amendment—the safety of their own positions being the object. The safety of the public and the large, unnecessary expense that the railroads are put to are not considered. I will now show the effect this law would have if passed.

The engineers have a strong organization and in indorsing this amendment they are seeking to find places for the weaker members of their organization. It is a well-known fact that the engineers are the

highest paid organization in the world working for wages. The best class of engineers make from \$200 to \$250 per month. These men could not afford to take a position as district inspector at \$150 per month; therefore, the government in taking engineers as district inspectors, must take that class of engineers who are incompetent by lack of experience with a railroad company to hold an important run.

It is the duty of an engineer to thoroughly examine his engine before starting on a run, his own life depending to a certain degree on his competency in making his examination. If this amendment should become effective, it would mean that this competent engineer would have to have his defects pointed out to him by a less competent engineer, a fireman, a machinist or a boilermaker, who doesn't know anything about an engine, and the opinion of these men would be enforced by law.

"O, Consistency, Thou Art a Jewel."

The writer is a foreman boiler maker. The interest of each individual boiler maker is his interest in the advancement of our business. I cannot close without an appeal for fair play for boiler makers. No railroad in the world has ever appointed an engineer or a fireman or a machinist to the position of boiler inspector. There was no precedent for the President to appoint these men. If the President was called on to appoint a district attorney, would he appoint a doctor? The doctor might obtain a set of law books and his decisions might be equally as fair as far as the general public would know, just as intelligent, as those of the lawyer would be. But would it be law? However, should the President presume to appoint a doctor it is very probable that the doctor would decline from a sense of honor and professional courtesy. I shall be very glad when the same spirit of honor and courtesy actuates all of our people. The writer has no grouch against the federal inspectors—they are all good fellows. Industrious and intelligent—some of them are my personal friends. They are fully equal to a good doctor in a lawyer's job. I hope they will keep their position as long as they want to, but when new appointments are to be made I would like very much for those making the appointments to remember that passage of Scripture which reads:

"Render, therefore, unto Caesar the things that are Caesar's."

With my best wishes to each and every member of the organization, I beg to remain

Yours very truly,
J. H. NOONAN.

Vallejo, Cal.

Whereas, the United States Civil Service Commission has issued an order curtailing and suppressing the inviolable rights of American citizenship guaranteed us by our National Constitution, to the extent of

denying labor the very necessary right of working for desirable legislation, and men who pledge our interest and their support.

Resolved, That we, the members of Lodge No. 148, emphatically condemn the present gag rule and usurped authority of this commission as a dangerous weapon against workingmen and subservient to good citizenship, and we further

Resolve, That this lodge urge our International officers to use all their power to have these undesirable rulings rescinded, at least to the extent of exempting all employees not in a supervisory capacity.

E. B. WOLF,
J. F. JONES,
GEO. HARRIS,
Committee.

Carbondale, Pa.

Dear Friends and Brothers:

I, acting as corresponding secretary of Carbondale Lodge No. 547 of the International Brotherhood of Boiler Makers and Iron Ship Builders and Helpers of America, will try to let you all know of the wonderful growth of our lodge during the last few months. Through the efforts of our ONE GREAT district organizer, Mr. Chas. F. Scott, who has devoted a couple of weeks of his precious time right here with us, he has worked, striven earnestly and brought a weak, scrawny lodge, which it was when he arrived on the scene, through his perseverance with the assistance of our lodge president, E. T. Dickinson, finally began bracing it up by degrees. They have at last succeeded in getting every boiler maker and boiler maker's helper on the Pennsylvania division of the D. & H. Company in line for the worthy cause; they then got the boiler makers of the Hendricks Manufacturing Company, Carbondale, Pa., to "fall in"; they then got a line on boiler makers employed at Mayfield Yard Terminal of New York, Ontario & Western Railroad Company to "come across," finally making a strong and flourishing lodge of about 65 or 70 members, where we had but 25 or so when Mr. Scott got "a-working," so you all can see what a "good hustling organizer" is worth to an organization of this kind.

While in our city of Carbondale, Mr. Charlie Scott made a number of friends for himself; shortly before his departure the lodge called a special meeting, which finally closed with a form of a small banquet (blow-out) as you may call it, or departing reception for Organizer Scott. At the meeting there was voted a hearty vote of thanks to Mr. Scott for the good work he done while with us; there was a very pleasing number on the entertainment. We had Brothers Thos. Carden and Geo. Hall giving a few piano selections and vocal solos. Brother Carmeno Cerra followed with a recitation. Brother Harry Quinn also done his share, as well as Brothers Lieberum and Tanner, in a "rapid-fire" dialogue on "Who's Who in War." After a closing

address by Brother John Santanna, the entertainment was adjourned with all hands happy.

It is the intention of Lodge 547, however, if possible to run entertainments regularly during the long winter months.

Hoping all the boys and brothers will try to wake up a little as our little lodge did, I remain, wishing all the brothers in behalf of Lodge 547 a Merry Christmas and a Happy New Year.

Yours fraternally,
JAMES A. FLANNERY.

Ft. Worth, Tex.

Dear Sir and Brother:

By request I am writing to ask that you publish in the next issue of the Journal that Herman Kessler has squared his accounts here and is O. K. as far as this lodge is concerned.

Also that Chas. Maseman, after due investigation, has been exonerated of charges that appeared in the official Journal some months since.

The official roster for this lodge for the next term will be as follows: President, G. E. Chester, 951 Jefferson Avenue; Vice-President, L. F. Green; Recording Secretary, S. K. Grammer, 918 St. Louis Avenue; Corresponding and Financial Secretary, L. A. Freeman, 2250 Jennings Street (without opposition); Inspector, J. M. Craig, 504 Missouri Avenue; Treasurer, T. H. Kelley, 1900 Sixth Street; Trustees, L. Bauer, Chairman, 925 Josephine Street; R. N. Parmley, 912 Avans Avenue; W. A. Bigley, 1302 Bluff Street.

Also attached please find revised mailing list effective January 1, 1915. Trusting this will be satisfactory, and wishing you a Merry Christmas and a Happy New Year, I remain,

Yours fraternally, **L. A. FREEMAN.**

Milwaukee, Wis.

Dear Sir and Brother:

Inclosed find list of the following officers that were elected at Tuesday night's meeting of Cream City Lodge No. 107, Milwaukee, Wis.: J. Hoppens, president; J. Benish, vice-president; P. Sonnenberg, business agent and corresponding secretary; R. Dale, financial secretary; O. Kannenberg, treasurer; Ed Reininger, recording secretary; M. Miller, inspector; D. Ellix, inside guard; H. Pwers, N. McLean, Ed. Leyman and C. Ceperski were appointed trustees.

The following officers' addresses are: P. Sonnenberg, business agent and corresponding secretary, 623 Greenbush Street; J. Hoppens, president, 1302 Fraterney Street., and R. Dale, financial secretary, 319 Fourth Avenue.

Hoping to see this in your next monthly Journal and thanking you for past favors, I beg to remain,

Yours fraternally,
R. DALE, Financial Secretary.

P. S.—Wishing you and all a Merry Christmas and a prosperous New Year.

Brainard, Minn.

Dear Sir:

Inclosed please find a group of boiler makers of the night gang, Lodge No. 116, Brainard, Minn. Standing from left to



A GROUP OF THE BOILER MAKERS ON NIGHT GANG, LODGE 116, BRAINARD, MINN.

right—"Goldie" Senti and "Moonshine" Brady. Sitting, left to right—"Cyclone" Kohn, "Brick Arch" Mielke and "Smoke Box" Hurley.

Hoping to see this in the journal, I remain

Yours fraternally,
JACK HURLEY.

A NEW YEAR'S CARD—BY MRS. JOHN CURE.

Teague, Tex.

My Friend:

I call you my friend because in some way in this world that seems so full of chance, yet through which I am persuaded there runs a deep and intelligent purpose, you and I have been thrown together. We come to know each other.

And when we touched, you and I, two human atoms in this big universe, a fire was kindled.

I liked you; you liked me.

Why, none can tell; it is just one of those wondrous miracles that happen in this wondrous life.

That fire still burns in me. I want you to know that I am still your friend. The sight of you this day, the sound of your voice, the touch of your hand, could make me happy.

I don't like to grow away from my friends. Life is so crowded and the necessary work so absorbing that well-beloved faces drift into the gray fog of forgotten days. But here comes the new year and reminds me that the best part of my life consists in its friendships. So I send you this, in the hope that you may kindle a little today at the thought of me, that you may have a little wish that I were near you, and that you and I may meet at least in thought. I have no present to send you, but I am sending what is better—genuine

heart throbs. They are through and through these lines. If you hold the paper close to your own breast, I am sure you can feel them. The days we have spent together, I have not lost one of them; they are with me now, walking through my memory, not like sad ghosts, but like smiling angels, to remind me I stand soul to soul with one who likes me and whom I like, and we are marching bravely and blithely toward that unknown world.

Think of those days when you read this and reach out your hand and touched mine across the distance of years and miles.

I meet enough people who do not like me or what I do; the world has plenty of destructive forces of envy, misunderstanding and antipathy. Nobody gets along with everybody, but you and I belong to the great invisible Order of Friends. We stand against the world. We feel eternity. If we should not meet in this life again, we will surely meet in the next, and on some peaceful star our laughter shall ring out there, where there is no shadows of parting. Then hail to you, my friend, and the best in life for you! Contentment and love be yours, and plenty of good work to do. May your heart be always brave. May your nature grow rich in all that happens to you. Hoping we will soon meet again and often to "knit up the raveled sleeve" of friendship.

Wishing each and all a Happy New Year, I am

Very truly,
MRS. JOHN CURE.

Chicago, Ill.

To All Members of Organized Labor:
Dear Sirs and Brothers:

As we are now closing the books of our anniversary ball given by the Burnside Local Board of the I. C. System Federation, we wish to submit the following report, with our hearty thanks to the members who so loyally supported our cause through the purchase of tickets.

We have held the books open up to this time owing to the fact that we had a number of tickets out unheard from, and hoping to hear from them before making our report.

We are glad to say that our ball was a success both socially and financially. Receipts from Blacksmiths' organization. \$ 97.00
Receipts from Boiler Makers' organization. 75.00
Receipts from Machinists' organization. 214.50
Receipts from various other organizations. 313.27
Receipts from political candidates. 54.50
Receipts from program. 94.00
Receipts from cloak and lunch room. 22.85
Total receipts. \$871.12

Disbursements.

To Carl E. Person Defense Fund. . . \$100.00
To printing bill. 118.55
To stationery and postage. 84.00
To hall rent. 20.00
To orchestra. 18.00
To refreshments, cigars, etc. 28.83
To decorating hall and all other expenses. 77.06

Recapitulation.

Total receipts. \$871.12
Total expenses. 446.44

Leaving a balance of. \$424.68

This amount was distributed among thirteen pickets in equal proportion to service rendered, and a small donation to two old aged strikers who have received no support scarcely from their respective organizations. One of them belonged to the Federal Labor Union and the other is a member of the Sheet Metal Workers.

Respectfully submitted,
I. J. CUNDIFF,

Secretary-Treasurer Burnside Local Board
I. C. S. F.

Elizabeth, N. J.

Dear Sir and Brother:

Please publish in the next issue of the Journal that we held our regular meeting Wednesday night, Thanksgiving eve, and after the meeting about a dozen of the brothers stopped at Kraussl Cafe, where they were having a raffle for turkeys and chickens and various other things good to eat on Thanksgiving day, and want to say that the boiler makers won everything in the place. Brother John Reynolds won two turkeys, 23 and 19 pounds respectively; Brother Frank Ruben won a pig and a duck; Brother Tom Duff won a lamb; Jake Monohan won a goose; Tommy O'Brien won three chickens. The rest of the brothers won a chicken apiece. I got the dice. Next day we went visiting one another, had lots to eat and drink—some session, and I dare say we had a rather delicious Thanksgiving.

With best wishes to all brothers, I am,
Yours fraternally,
S. M. RANKIN, Sec. 176.

Tulsa, Okla.

Dear Sir and Brother:

We are sending Brother Reinemeyer, secretary, a draft for \$1,000.00. Brother Ryan is in the office now, and the brothers of 592 desires for you to make a cut of said draft and publish the same in the Journal next issue.

Hoping that we are not asking too much and that Local 592's request will be granted, with best wishes,

Fraternally yours,
WM. CAREY, Secretary.

Kansas City, Kas., Dec. 17, 1914.

The above is a fac-simile of a draft received from Wm. Carey, secretary of Lodge 592, Tulsa, Oklahoma.

Accompanying this draft was a supply blank ordering supplies of seven hundred eighteen boiler makers' due stamps, three hundred helpers' due stamps, one thousand due books, and one report book, making a total of one thousand dollars worth ordered;

long will we continue to swallow bitter defeat, so long will our brothers suffer in vain. We feel that the workers have not kept pace with the development of capital, and that it is essential to our welfare that we form a closer union so that a solid front may be presented when we seek our rights. We urge all our members at this time to give their earnest consideration to the position we and our brother union men are in.

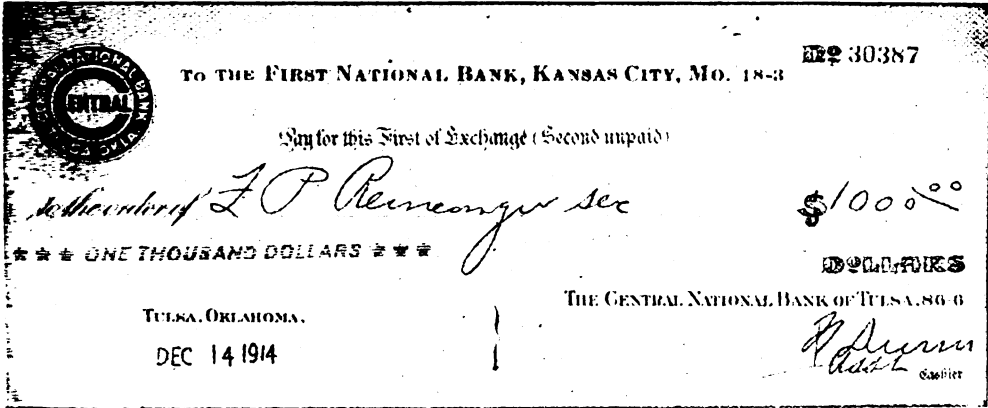

one of the largest cash orders that has been received at this office.

Lodge 592 is one of the largest lodges we have in the Brotherhood. They reported six hundred and sixty-nine boiler makers and three hundred ninety-four helpers, a total of one thousand sixty-three members in good standing for the month of November.

Yours fraternally,
F. P. REINEMEYER, I. S.-T.

RESOLUTION.

WHEREAS, A ballot has been presented to the members of the Harriman, Illinois Central and Pere Marquette lines to decide whether or not the strikes should be called off, and

WHEREAS, The Harriman and Illinois Central have been our strongest organized roads, and,

WHEREAS, The reason given for this action by our officers is that the finances are exhausted, which means that these strikes cannot possibly be won, and,

WHEREAS, It has been fully demonstrated to us during the past few years that we can no longer successfully fight or even hold our own against a powerfully entrenched capitalist class controlling government, courts and press with our present form of individual craft organizations; therefore, be it

RESOLVED, That we, the members of No. 116, conscious of the fact that we are engaged in the world-wide struggle between capital and labor, realize that, so long as we endeavor to secure justice through futile methods of individual craft organizations, so

We feel that conditions demand that we solidify our forces, for only then will we become a power able to maintain our rights and occupy our proper level in society.

L. A. REFEURATH,

Cor. Sec. No. 116.

Note.—The editor does not believe the publication of resolutions like the above is for the best interests of our organization or its members and on receipt of the above, wrote to the secretary of the lodge, expressing this opinion; however, we received a reply in which the request to publish was reiterated, with the statement that the lodge would assume full responsibility for same, and rather than have any just grounds for complaint for censoring articles, we are publishing the above resolutions; however, we cannot refrain from pointing out some of the errors of reasoning they contain. The resolution gives "individual craft unionism" as the cause of our failure to so far win the strikes mentioned, when, as a matter of fact, they are federated strikes in which each trade acted in concert with each other and could not have done any more were they in "one big union." Therefore, this reasoning is from false premises, and the true cause for failure to so far win out will have to be sought in some other direction. In our humble opinion there were several contributory causes, but we do not believe the present is the proper time to discuss them, as the result of the vote taken by the men on strike had decreed that the fight be kept up, so instead

of discussing matters of this kind, it will be more to the purpose to make every possible effort to renew the contest with all the vigor possible, so that a favorable result may yet be achieved; until then, it seems to us discussions of this kind are out of order.—The Editor.

East Boston, Mass.

Dear Sir and Brother:

At our regular meeting on December 3, our good friend and associate, Sixth International Vice-President John Dowd, was a welcome visitor and he received a cordial reception from the members. Brother Dowd spoke in detail regarding his efforts to better the working conditions of the workers in our trade in this vicinity, particularly the boiler makers and assistants in the employ of the Boston & Maine Railroad System, who have had serious grievances and whom have been on the verge of quitting their work for several weeks, previous to the arrival of John J. Dowd on the scene, but it speaks volumes for the sagacity and humanity of Brother Dowd who pointed out the foolishness of calling a strike at this time of the year, and the cruel suffering that would result to the innocent mothers and children if such action was taken—thus Brother Dowd in his sincere and logical mode of reasoning prevailed upon the would-be striking railroad men to take no such drastic action until conditions and opportunities were more propitious. Meanwhile, Brother Dowd has mapped out a program of conference and propositions for the mutual consideration of the men and magnates that there is every reason to believe will pave the way for satisfaction to all concerned. Diplomacy and sensible argument—not threats of a resort to violence, intimidation, etc.—have inevitably marked the course of John J. Dowd's successful solutions of intricate and puzzling wage problems in the boiler making and iron ship building industry in the New England states and the great Empire state.

Lodge 585 also received a very encouraging report from its business agent, Brother Daniel N. Generson, who has been right on the job ever since he took office. Brother Generson (with the able assistance of John J. Dowd who has accompanied our business agent in his quests for jobs for good Union men, and his efforts to reorganize this city and state and to bring back delinquents to the fold) is having a rough road to travel but if perseverance, courage and industry deserves success then Bro. Generson will achieve the same.

DANIEL B. McINNES,
C. S. Lodge No. 585.

Milwaukee, Wis.

Editor Journal:

Just a line to you and the rest of the brothers to let you know that Local Lodge 302 is doing business all the time, even

though we do not get into print through the pages of our Journal.

At our last regular meeting, on December 2nd, 1914, our members went on record as not forgetting the members of our local that are unfortunate in being laid off or out of employment just at the time of the year that work is needed the most, and that is around the holidays, when the dear little ones are expecting the arrival of Dear Old Santa, but may it be said for our members that they have not been lost sight of, as we took steps at our regular meeting to provide funds to give them a good joyous Xmas at home with the little ones, by a liberal donation out of our treasury so that life and joy may prevail on that day of blessing.

A committee of eight was appointed by the local divided up in four sections to cover the city as our brothers live in all sections of the city to look after their wants and to see that they will be well taken care of and to see that the little ones would not be forgotten. Now, brothers, I don't pretend to be a writer, but I hope that these few lines may go home to some of the careless brothers that never give a thought for anyone but themselves and if we find that our brothers need a helping hand, we are the ones that are fortunate in having steady work should be willing to at least do what we can for our less fortunate ones, and if our treasury will not stand these calls on it, to be willing to go down in our own pockets for such a worthy cause and in this way show the outside shopmate that there is a motive in being a union man other than to walk up and pay your monthly dues and carrying a card in his pocket. So here's for more success along these lines and hoping that some of the other locals have taken steps along these same lines.

Trusting you will find space in the January Journal for these few lines, with best wishes to the grand officers, also to the rest of our brothers, for a happy and prosperous New Year, I beg to remain,

J. DU BRUCQ, Local 302.

Brainerd, Minn., December 5, 1914.

Mr. Editor and Brothers, Greetings:

During the past four years, the working class of America has gone through many bitter experiences, particularly in West Virginia, Michigan and Colorado, and what more closely affects us on the Harriman and Illinois Central lines. We have watched our brothers in all these conflicts put up an heroic stand against overwhelming odds. We have seen how they have sacrificed all that a man holds dear, aye, even their lives, in defense of the principles of labor. It is not necessary for me to recount the terrible suffering that our brothers have gone through. You are all familiar with the whole history of these strikes, at least you should be, for they have been repeated again and again.

But what do we learn from these industrial battles, brothers? Do we learn anything? If so, why do we not seek to prevent them? Do we simply see the effect? Namely, a body of men—workers—trying to secure more wages and better conditions from employers who refuse to pay more wages or grant better conditions. Now, this is simply the effect of some underlying cause.

The cause is the **ANTAGONISTIC ECONOMIC INTERESTS**. On one side we have the employers, or capitalists, always seeking more profits, a greater share of the products; on the other side, we have the great masses, who own nothing but their ability to work, always seeking more wages and better working conditions, in a word, **ECONOMIC FREEDOM**.

For over half a century, this struggle has been going on in this country. In normal times, we have been able to adjust the opposing interests by the peaceful means of agreements, but all the time, smoldering under the surface, lies the inherent, antagonistic interests, which, at times, break forth in bitter, open conflicts, such as in Colorado and Michigan. In these battles, the worker does not meet the capitalists as capitalists, but under the disguise of courts, legislatures, federal and state troops, the press and the capitalist private army of thugs and gunmen.

Little wonder then that the worker is crushed and defeated when he gives battle to such an array of force. Little wonder, indeed. We might as well expect an army such as Washington had to successfully combat the highly efficient German fighting machine as for the workers with our isolated organizations to successfully fight capital with the whole powers of government behind it.

It seems sheer folly to me to continue as we have been doing. Why quibble and refuse to face facts? I **BELIEVE ORGANIZED LABOR IS GOING TO HAVE A TREMENDOUS STRUGGLE IN THE NEAR FUTURE TO HOLD WHAT IT HAS**, and it seems to me, unless we can solidify our forces and quickly, we are going to receive a severe reverse. I am not a pessimist, for I am satisfied that labor will eventually triumph, but, brothers, before that time comes, we will have more bitter experiences. We will see many of our brothers shot down and their families hounded over the hills like beasts, for this is the penalty union men have paid and will pay for daring to stand for their rights.

Now, brothers, I am of the belief that the only way in which labor can win is by adopting the modern methods employed by our masters. I do not mean their gunmen and thugs or their armored trains and high-power rifles. We will not need such brutal forces as they employ. But we should adopt their wise policies; namely, to unite ourselves into one solid body, conscious of our

economic interest, to secure our own representatives in our Congress, legislatures and courts. These are things we can easily do. **FURTHER BLOODSHED IS NOT NECESSARY.**

Why persist in bucking a stone wall? We have done that long enough. Labor is powerful. It is only a lack of consciousness of its power that keeps it in submission. Once the workers become conscious of their strength, they will become an irresistible force that nothing on earth can resist. Therein lies our only hope. **GET TOGETHER, STAND TOGETHER, ONE FOR ALL, ALL FOR ONE.**

The labor question is a world problem; it will never be solved by capitalists or professional politicians. It can only be solved by the working class. This is the lesson we must learn.

Fraternally yours,
J. G. BROWN,
Lodge No. 116.

**' IN MEMORY OF BROTHER
E. E. SANDERS.**

Sedalia, Mo.

After a life's fitful fever, he sleeps well; after life's arduous toils and struggles, we say, "Rest, Rest, Perpetual Spirit." Brothers, with bowed head I venture to write an item of respect for one that is gone. If we could all feel that so many and sweet things could be said of us as have been said of Brother Sanders, it would mitigate the horrors of the grave and smooth our passage to the land beyond. I have heard the highest tributes paid to the memory of our beloved brother that I have heard paid to anyone for a long time, and I said that a life that could inspire the expression of so many lofty and virtuous sentiments had not been lived in vain. The estimation in which he was held as a good citizen is well known to all who knew him.

Sweet was the fragrance of these flowers upon his casket, but sweeter far the fragrance of his memory. There is a voice from the tomb sweeter than song.

He has left a void in our ranks which none can fill and the first feeling that came to me when I received the sad news was that there is nothing serious in mortality when such young and useful men are so stricken down, but while we feel his loss so heavily, what must be the feeling of her whose whole soul has been occupied by his image for many years? Truly, for her the heavens seem hung with black, but in such an hour can only commend her to some higher source for consolation.

He has left her but little of this world's goods, but has bequeathed to her a far richer legacy, the priceless heritage of a spotless name. During all the years that I knew and worked with Brother Sanders I never asked him his religion, because we are told that by their fruits ye shall know them.

His very remains now rest in Crown Hill Cemetery, and with heavy hearts we gave him up. Brother Sanders, we are lonely without you. Good night, sweet peace, and flight of angels sing thee to thy rest.

M. J. DONOHUE.

Chicago, Ill.

Dear Sir and Brother:

I have been waiting for the brothers that still hold tickets to either send them or the money in, and as they have not done so I will write and thank our brothers and sisters who were so kind as to take them, and those that could not on account of poor times returned them, I therefore take this means to say thank you to one and all.

Our dance and card party of October 17th was not such a big success as we had hoped it would be, the weather man had sent rain to greet us and of course the people who are afraid of melting stayed at home and the old timers all turned out. We had about 65 couples—just a nice crowd to have a good time.

The card party prizes were pretty and donated by the following people: One ladies' party box, one guest's leather pocket book, both donated by "The Fair," State, Adams and Dearborn Streets. One hand painted cake plate, donated by Mrs. L. Brown, 3723 W. Chicago Avenue. Pair fine suspenders donated by James Garland, 3824 W. Chicago Avenue. One box fine cigars donated by Sister Lux and two consolations by Sister Green. One creamer and sugar bowl donated by lodge.

I thank each and every one that was so kind to help us and I hope the brothers who still have tickets will at least please return them.

Anna Grace Sawyer, our friend and florist, was with us on the night and donated 200 carnations for the dancers and words cannot express our thanks to all our donators and we hope the Brothers and sisters will show our thanks by trading with these kind people.

I hope you will find room in the Journal for this letter and I wish all the brothers and sisters a Merry Christmas and a Happy New Year. Thanking you and all the brothers and sisters also donators again, we remain,

Fraternally yours,
MRS. JAS. W. SANDY,
MRS. FRANCIS,
MRS. SELDON,

Committee Garfield Park Lodge No. 12, L. A.

Wilkes Barre, Pa.

Dear Sir and Brother:

Just a few lines in regards to Local 547 of Carbondale, Pa. Held a special meeting on Monday evening, November 23, and had a very large meeting and had the honor of having Brother Chas. F. Scott, deputy organizer, present, who has been in this

section of the state and had been meeting with success and has put new life in 547, besides increasing our membership from about 23 members to 65 at present. Out of this number there are six from Wilkes Barre, Pa. Brother Scott has also met with success in Wilkes Barre, Pa., in securing an agreement and closed shop with MacCullum Bros'. Machine and Boiler Works.

And I want to inform the Brotherhood at this special meeting a vote was taken and thanks extended to Brother Scott for the good work he has done for Lodge No. 547 in increasing our membership—43 new members.

Also enjoyed a good talk by Brother Scott and after the business of the lodge was finished, refreshments were served.

Hoping to see this in January Journal, and wishing all the members success, I beg to remain

THOS. CAVAN,

Wilkes Barre Representative, Local No. 547.

Dear Sir and Brother:

By unanimous vote of Lodge 220 in regular session Tuesday, November 3rd, I was instructed to notify you of the action taken by Lodge 220 relative to the action of the Executive Council, of the Brotherhood discontinuing the strike benefits on Dec. 1, 1914, and to request you to publish same in the Journal.

Action Taken by Lodge 220.

It was moved and seconded and carried by unanimous vote to send a protest to the Grand lodge protesting against the action of the executive councils in discontinuing the strike benefits, and request that the Grand Lodge continue to pay strike benefits until the strike is entirely settled or called off, and that this action be published in the next issue of the Journal.

By vote of the majority of the members of Local No. 220 in attendance at our regular meeting last night, October 6, 1914. I was requested to write you relative to calling off of the strike on the I. C. & Harriman Line Railroads, and ask you to take the matter up with the other organizations affiliated with the R. E. department to that effect, and to put out a referendum in our organization to be voted on.

Trusting you will handle this matter as it should be, I remain,

Yours fraternally,

I. J. CUNDIFF,
Secretary No. 220.

I desire to call your attention to the inconsistency contained in the first of the foregoing letters, where a protest is presented against the discontinuance of benefits in view of the action taken by the same lodge as shown by the last of the letters under date of October 7, wherein Lodge No. 220 requested that I take the matter of calling the strike off up with the other or-

ganizations affiliated with the Railroad Department and requested that we put out a referendum vote to our organization to be voted on.

You will note the lodge is now protesting against the very action that they requested that we take in their letter of October 7.

Without further comment or discussion, I will leave it to the membership to pass judgment on.

With best wishes, I am

Yours fraternally,

J. A. FRANKLIN,
International President.

Chicago, Ill.

Dear Sir and Brother:

By request of a number of members of Lodge No. 39 who sold raffle tickets for the benefit of M. Griffin, we wish to announce that No. 433 was the winning number, and Brother Griffin, who is a union engineer, wishes to thank one and all for their kindness in assisting him.

Hoping you can find space in our official Journal, and with best wishes, I am

Fraternally yours,

JOHN S. COGLAN.

Dear Sir and Brother:

A few words to the members on behalf of Brother W. J. O'Bryan's application for pardon:

Brothers Thos. Culligan, John Call and I visited the state's prison at San Quentin Thursday, December 10. We had the regular half hour allowed all visitors with Brother O'Bryan, found him very cheerful and bearing up well, also looking well.

Brother O'Bryan's conduct has been excellent and he is now helping take care of the cells. He is very thankful and appreciates what the brothers are trying to do for him.

The situation in the matter of the application to the governor of the state of California for a pardon of William J. O'Bryan is now ready to be filed. The delay in filing the application has been caused by the necessity of obtaining thousands of signatures throughout the state. Nothing would have been gained to have filed the application for the pardon before this, owing to the activities of people who are prominent in the state in political matters.

We have been informed that we have splendid and valid reasons to present to the Governor for O'Bryan's pardon. One of the most reassuring matters that has come to our attention recently is the statement made by the non-union man who was the companion of Avall, the man that O'Bryan shot, that on the night of the shooting Molina made a statement in the presence of a number of witnesses to the effect that Avall, on the night of the shooting, went armed, looking for O'Bryan, and that if O'Bryan had not got him (Avall) he, (Avall) would have killed O'Bryan.

We have been informed that had such

testimony been available at the trial of O'Bryan for the murder of Avall, it is quite probable that a different verdict might have been obtained.

On the whole we are very sanguine when the Governor of the State of California is thoroughly acquainted with the entire history of O'Bryan's case, that some relief will be granted him.

It is necessary that the application for the pardon, as well as all other matters necessary in connection therewith be carefully handled, and therefore we are going slowly and surely about the business of securing the pardon, and we have every cause to feel optimistic of the final outcome.

Decatur, Ill.

Dear Sir and Brother:

Lodge No. 447 of Decatur, Ill., had a warm time on the night of December 15. It was our regular meeting and we elected officers for the year 1915. War was declared at 9:45 p. m., all officers and 96 men on the firing line. The first to be brought up for slaughter was His Majesty the President, Brother James Gray. Well, this brother has held this job for five years, which shows that good union men do stick. Next was the office of vice-president; well, we have a brother in this position who can repeat the ritual from cover to cover. Now comes the best secretary in the United States, corresponding and financial, Charles J. Younger; this brother is a war horse by deeds, as well as name; he has held this job for over seven years, which shows that he is a business man as well as a wielder of the hammer.

Brother M. J. Kelley was made recording secretary; now for any man to accept this job, it shows that he is certainly a man of vim, for we assuredly need two or three to keep up with the smeary salve, which is plentiful at this time. Brother Leo Singer was given the job as gold keeper, which is at present not a very great deal. Inspector Richard Conroy of Dublin, Ireland, had no opposition.

Trustees are as follows: H. J. Freischlag, chairman; Al. Reinking, Law, Bridgewater; and poor little me was made the goat—Journal correspondent. Well, brothers, should you come this way, please bring a good paid-up card, for no other kind is recognized here.

Yours fraternally,

EDW. E. IVEY,
Journal Secretary, No. 447.

Teacher: "Earl, did you whisper today?"

Earl: "Yes; wunst."

Teacher: "Clarence, should Earl have said 'wunst'?"

Clarence: "No, he should have said 'twicet.'"—Everybody's Magazine.

A Compilation of Labor News.

BY THE A. F. OF L. NEWS SERVICE.

WOULD DEFEAT SEA TREATY.

Washington.—On the ground that life at sea will not be protected, that the LaFollette seamen's bill, now pending in the Senate, will be valueless, and that legislation of this purport will be impossible, the American Federation of Labor is opposing the ratification of the treaty—or convention—signed in London last January by the world's maritime nations at their safety-at-sea conference.

In a public statement President Gompers gives the following reasons for this opposition:

"The convention, adopted by the London conference, instead of being a proposition for safety of life at sea, might better be termed a surrender by the United States to legislate in the interest of the people of our country, and to give away the freedom of the seamen, as well as to cripple the government in the regulation of immigration.

"In the first place, the proposed treaty does not afford protection of life at sea, and so far as practicability is concerned would not safeguard life or property to any appreciable degree more than the disasters which have occurred within the past decade.

"The proposed treaty places the power to regulate the well-being and health of passengers, that is, of emigrants subject to the legislation of the countries from which they depart and hence would not be subject to the laws of the United States, to which they would be immigrants. Thus, though a seeming impartiality in practice, the emigration is from other countries, the emigration is into the United States. There is little if any immigration from the United States to other countries in the sense in which emigration is understood.

"The question of the welfare and the freedom of seamen when vessels are in safe harbor is wholly disregarded in the proposed treaty. If the proposed treaty were ratified by the Senate it would make it impossible for the Congress of the United States to enact the just and humane provisions of the seamen's bill now pending before Congress.

"If the Senate desires to ratify the proposed treaty, then it should adopt the action of the committee on foreign relations in June, 1914, when the following was recommended:

"Provided that the United States reserves the right to abrogate 'treaties, conventions, and agreements' indicated in Article 68, in accordance with the terms of such treaties, conventions, and agreements, and to impose upon all ves-

sels in the waters of the United States such higher standards of safety and such provisions for the health and comfort of passengers and immigrants as the United States shall enact for vessels of the United States.

"With that proviso adopted, the government and the people of the United States retain for themselves the right to legislate for our own protection and advancement and to the advantage of all. Without such a proviso the treaty should not be ratified."

PRESIDENT GOMPERS TALKS IN SOUTHERN CITY ON WORKERS' HOPES AND AIMS.

Richmond, Va.—During his short stay in this city, last week, President Gompers addressed the National Society for the Promotion of Industrial Education, the members of the city's administration board, and one of the largest mass meetings ever held in Richmond, which was arranged by local unionists.

In his address before the educational conference, the trade unionist defended strikes, as much as they are to be deplored, because they are the most civilized method of expressing a natural and warranted discontent. In referring to the fight organized labor is making on convict labor, President Gompers said the workers did not believe that convicts should not be employed, but they insisted that these unfortunates should not be exploited for the gain of employing contractors or for the profit of the state. He favored the state-use system of solving this question. President Gompers said no argument by him was required in support of industrial education, as a great part of his life had been devoted to combating wrong-headed notions about the attitude of organized labor with reference to every sort of social and economic questions, and that the degree of ignorance of the workers is not so great as the presumptuous and supercilious often assume it to be. He declared organized labor is not opposed to the development of industrial education in the schools, but is eager to co-operate in instituting them. Labor, the speaker insisted, cannot favor any scheme of industrial education which is lop-sided, and the only way to avoid working an injury to organized labor under the name of industrial education would be to find out what the demand is in any given community.

At the mass meeting, held under the auspices of the Central Trades and Labor Council, President Gompers said that men and women today no longer beg for consideration, that they no longer present gaunt figures of hunger in demand of their needs, but that they demand right, they demand

justice and freedom. "Though it is hunger still," he said, "it is a new form of hunger. It is the hunger for better food, the hunger for better raiment; the hunger for better homes, for better surroundings; the hunger for better opportunity for our children, so that they may no more be the subjects of exploitation, but that they have equal rights and liberties with other people. What is the labor movement? It is the crystallization of a sentiment of indignation, of the expression of the discontent of the masses of the working people who desire relief from burdens too long borne, who ask for privileges too long denied them."

President Gompers said every law enacted during the past ten years of benefit to the workers was advocated by organized labor twenty-five years ago. He said James Donahue Sullivan, a printer, member of New York Typographical Union, was the first man to propose the initiative and referendum; that the Australian ballot, direct nominations, the corrupt practices' act, direct primaries, child labor laws, safety appliance acts, and even the public school system were the result of organized labor's efforts.

"We want industrial peace," said Mr. Gompers, "but we do not want it at any price. It must be peace with a progressive improvement. The masses should have the improvements they desire, if the world is to be made a better world. As to compulsory arbitration and enforced award, that is but another species of slavery. Our aim is that every man shall have his own best concept of right and justice—that he shall be able to enter upon a contract upon an equality of terms."

STATE EQUIPS HEALTH TRAIN.

New Orleans, La.—The Louisiana "health train," in charge of the state board of health has made a successful tour of many southern cities in the interest of cleanliness and right living. The state recently voted an appropriation to meet expenses, but in many cases railroads have made no charge for hauling the equipment, and invariably gave it the right of way. Medical authorities made addresses to visitors and explained the exhibits, which include sanitation, care of babies and dangers that follow the use of "consumption cures" and other fake medicines.

"We now have our own train of two big Pullman cars, owned exclusively by the state of Louisiana," said Dr. Dowling. "When we began this work four years ago, we had to borrow two old cars from the railroads.

"Next year we expect to equip another train, carrying out other ideas so that we can visit a town in Louisiana twice each year and carry a different message to them on both trips. We expect to have many other models illustrating the proper manner of living in the home, in the schoolroom, and in the business office."

FAVORS OLD AGE PENSIONS.

Washington.—In his annual report, Secretary Redfield, of the Department of Commerce, declares the United States cannot longer hold off from giving protection in their old age to its faithful employes.

"In spite of the occasional loss of aged employes, due usually to death or resignation," says the secretary, "superannuation still increases, thus accentuating the disadvantages of an impaired service, the discouragement of a retarded rate of promotion for young and deserving employes and the feeling of unrest and perhaps dread of dismissal by those who are aware of the fact that the best service they are able to render does not reach the average standard of the younger employes of the same class and grade.

"While superannuation probably exists, it has been found difficult under present conditions to obtain admissions of the actual conditions from the higher officials under whom aged employes serve.

"Naturally, so far as may conscientiously be done, officials are reluctant to make any statement which might lead to the separation from the service of those who have given the best years of their lives to the government and who, if deprived of their income, would face poverty and want.

"In both governmental and commercial centers retirement on some system of pensions for superannuated employes is becoming more generally recognized as both a practical and profitable movement. That such a policy can be carried out by the government so as to be ultimately a means of economy seems to have been demonstrated.

"A system of retirement has been adopted by the leading governments of Europe; and its growth among business corporations indicate the value of the results accruing from the policy. It is found to affect not only immediate relief, but its benefits are seen in its influences on the younger and more active class of employes.

It removes much of the incentive to seek other employment where the prospects are brighter; it induces many to render more nearly the maximum of service; and improves the esprit de corps when it is known that the faithful employes may expect to be cared for after they have become incapacitated in the service."

WOULD END WIRE MONOPOLY.

Washington.—"I expect to make an effort, together with other members of Congress, who have studied the question, to bring up a bill to turn the telephone systems of the United States over to the postoffice department, during the present session of Congress, and I have reason to believe that we shall be able to pass it," said Representative Lewis, a member of the labor group.

"The American postal service averaged 60,000 pieces of mail matter handled per

employe, in 1913; 13,000,000,000 in all. The average cost to the consumer was about 2 cents. Private monopoly would require from 5 cents to 10 cents for such service. In June, last, the express companies were losing about a cent on each package carried, on an average charge of about 50 cents. The same month parcel post charged an average of 15 cents for the packages it carried, and after paying all costs, including the railway pay, has some 3 cents profit less on each package. Telephone communication is in the same class as express service. It is a natural monopoly, and must be in the hands of the public to be either cheap or efficient."

DEFENDS COMPENSATION LAW.

San Francisco.—Harris Weinstock has answered the charge of an insurance company that the state's promise to refund 15 per cent of its premiums to policy holders in the state compensation insurance fund is a "get-rich-quick scheme," and is a "pilfering of a fund set aside to protect industrial cripples."

Weinstock shows that these reductions now total 40 per cent over the charge of private companies, and that the state, in the matter of efficiency, has broken all records in the settlement of 3,000 claims. Of these there have been only eleven disputed cases, and out of these there have been only three cases where the injured worker's right to compensation had to be determined by the commission. In the remaining eight cases the issue was simply to determine who were the rightful dependents of the injured workers, the extent of such dependency, or the extent of permanent disability.

STEEL CARS FAVORED.

Washington.—In its annual report to Congress, the Interstate Commerce Commission recommends the use of steel cars in passenger trains, and prohibition of the use of wooden cars between or ahead of steel cars.

Definite penalties for violations of the hours of service act is also favored. At the present time the A. F. of L. and the railroad brotherhoods are urging the passage of a law that will fix a minimum fine of \$100 for violations of this act. Courts, in many instances, have nullified the purpose of this legislation by the small fines inflicted on railroads found guilty of working their employes more than sixteen hours in twenty-four.

The commission also asks for explicit and certain authority to examine all documents and records of the railroads. A plea for standard operating rules is included in the report.

AGAINST "SURPRISE TESTS."

Chicago.—Abolition of the "surprise tests" given engineers will be demanded of the arbitration board now hearing grievances of engineers and firemen in this city.

The "surprise test" is as follows:

While running a through train at high speed in the night the engineer is assured by a white signal that all is safe. Then, as the engine turns a curve, he sees a sudden flash of red light and he realizes that possibly death awaits him and his passengers.

With nerves taut, the engineer begins to apply his brakes. And immediately the red light disappears, a white one shows, and again the engineer is told by signal that all is safe and he has the right of way.

This sort of test may prove to be a lasting blight upon the engineer's physical and nervous constitution, according to the engineers.

O. K. COMPENSATION LAW.

Columbus.—The Ohio Manufacturers' Association has changed its mind toward the state compensation law, and at its fourth annual convention O. K.'d this measure, and recommended that no change be made in the law for at least six years, or until it is given a fair trial, if a longer period is necessary. Members of the association were among the most bitter opponents of the law last year, and resisted to the utmost efforts of organized labor to secure the passage of the act.

The employers favor stronger organization, but hasten to assure the public this view is not urged for the purpose of "exterminating employes' organizations, but for the purpose of having the manufacturers' side presented."

LABOR EDITOR JAILED.

Stockton, Cal.—Five days in jail and a fine of \$250 is the sentence imposed on F. P. Lamoreux, editor of the Stockton Labor News, by Judge Norton, of the Superior Court, who found the unionist guilty of contempt because, in referring to an injunction issued by the court, he expressed editorial views as follows: "When a judge wants to do something not authorized by law, he simply makes a law to suit himself." The court held this was a contempt, and on motion of one of the attorneys for the anti-union association of employers, cited Lamoreux and several other unionists. The latter were discharged, while the editor was jailed, although the court assured him "there was no personal feeling in the matter."

STIR UP HORNET'S NEST.

Battle Creek.—The followers of one Dan Cupid are rushing to the support of this little gent because the board of education has put its ban on weddings among school teachers. The practice is verging on an epidemic, and the authorities have resolved to stop it by ordering the county clerk to refuse marriage licenses to any young woman employed in the schools, on the ground that the brides-to-be are "contract-breakers." The county clerk is "dared" to

POISONS IN INDUSTRY.

In his annual report, Chief Factory Inspector Nelson suggests that the state of Illinois is not adequately conserving the health of its working people in trades which expose them to the dangers of occupational diseases.

"The large number of cases of sickness reported in the tinware, car seal, paris green and china color transfer industries," explains Mr. Nelson, "undoubtedly cause room for anxiety. Our law is very narrow in scope and does not include all of the harmful industries in the state. In many of the industries, such as the transfer of pictures and designs on chinaware, boys and girls are employed and quickly contract lead poisoning. The children in this industry, being just above the child labor law in age, cannot be prohibited from working in this trade. This is just one instance where the law should be amended to prohibit any one under the age of twenty-one from working in any occupation where they are exposed to the dangers of trade poisonings.

"The manufacture of paris green is another industry made difficult to control under our present law. Here the danger lurks in the dust-laden air, filled with paris green powder. The use of respirators is rendered prohibitory on account of the friction around the mouth and nose. The workers in this trade within a few days become covered with ulcers on the mucosa of the mouth and nose. Almost ever case reveals scrotal ulcerations.

"Another dangerous trade is that of painting. While the painting occupation shows only a few cases of plumbism in our monthly reports, it is to be noted that only an insignificant number of painters in this state is being reported on. Almost 30,000 painters are employed in this state, yet our law does not offer them any protection except in a few cases, where they are employed in shops of carriage and automobile body makers and car shops. No one state bureau in this country nor even the United States government knows to a certainty how many painters suffer from lead poisoning, although no other trade risks greater exposure to it. No nation-wide survey of the ravages of lead poisoning in the ranks of painters has been made in this country. Our law should be amended to include this vast host of workmen and bring the same benefits to obtain as in the other industries.

"To the suggestions I have just offered as amendments to our present law should be added still another. Industrial wood alcohol poisoning attacks varnishers and furniture finishers, lacquerers and hatters. Alcohol should, therefore, be designated in the list of dangerous substances such as are enumerated in the present law.

"And, finally, the law should be made to apply to calsson workers. The increasing amount of calsson work connected with the building of bridges, tunnels, subways and skyscrapers has made the dis-

ease commonly called the 'bends' a formidable one.

"I have pointed to the vigorous enforcement of the present law and the narrow scope of the same. My numerous suggestions for amendments to the present law show that the state is not offering the most adequate protection to the working people in the many trades and occupations which endanger their health."

APPLAUD WILSON'S ANSWER.

Trinidad, Colo.—The Free Press, this city, applauds Secretary of Labor Wilson as follows because of this trade unionist's speech before the recent A. F. of L. convention:

"Answering his foes and maligners a few days ago in Philadelphia, William B. Wilson, Secretary of Labor, said:

"If securing justice to those who earn their living by the sweat of their face is partisanship, then count me a partisan on the side of the man that labors."

"You have been criticised and accused of partisanship, but only by those greedy corporations which would rob the workingman of his last right or crust that they might more the speedily and surely pile up their dividends. No one with fairness or justice in his soul has so accused you, though, and it is good to see that you possess the courage and manhood to come right back at your traducers, although it was known all along that you did own to these things.

"Your office was created in the interests of the working public. You were appointed in order that the workingman might have a friend and a word in the big works going forward at Washington. You sensed the intention of your job, and you have proved yourself the man for the job.

"It is really lamentable that the enemies of labor should live to see the day when the toiler would have a real friend in a high place. It is quite too bad that the day should have arrived when the worker should be looked after just a trifle. But that day seems to be here, and while we are vastly sorry for them, it begins to look as if this harsh and labor fighting corporation would have to swallow their chagrin and make the best of the new conditions.

"Go to it, Mr. Wilson. Every time a corporation abuses you, we are going to go right out in front, throw our hat in the air and give three cheers. Because we will know that when you are being abused you are doing your work in the right way."

HONOR A VETERAN.

Philadelphia.—Organized carpenters of this city are improving the home of Mrs. Peter J. McGuire, located at Camden. The carpenters take this occasion to again honor the memory of a trade union veteran, who founded the Brotherhood of Carpenters and Joiners and who did pioneer work in upbuilding the American Federation of Labor.

FREE LABOR COMES FIRST.

St. Paul.—Free labor must be given first consideration, is the thought behind a decision by Attorney General Smith, who has ruled on the contemplated action of the prison board in manufacturing chairs and settees of wood wrapped with prepared paper. This is proposed to furnish work for convicts in place of the prison shoe contracts, which were ended last summer.

In answer to the board's query as to the legality of this action, the attorney general said:

"The object of the law is to permit introduction in the state prison, under proper conditions, such industries as are not carried on in the state and which do not diminish the market for free labor in the state.

"If the proposed industry is to be deemed an independent industry and is not carried on in the state, then you may introduce such industries into the state prison.

"Your board should make a thorough investigation and ascertain whether it is probable that in the introduction of this industry you would not reduce the amount of the work in the state by persons not confined in prisons.

"The law must be interpreted in the light of its purpose, which is to employ a certain amount of the convict labor in some industry, provided it does not interfere with the employment of their labor in the state."

PROFESSIONAL LIST GROWS.

Washington.—In ten years the list of persons engaged in professional pursuits in this country has increased 500,000, according to figures given out by the federal census bureau. In 1910 the number was 1,825,127, compared with 1,258,538 in 1900. Of those engaged in professional occupations in 1910, 1,151,709 were males and 673,418 females. This compares with 827,941 males and 430,597 females in 1900.

During the decade the proportion of males decreased in the professions from 65.8 to 63.1 per cent, while that of females increased from 34.2 to 36.9 per cent. In 1910 there were four women to every seven men engaged in professional service, a large proportion of the women being teachers.

Some of the noteworthy increases follows. Architects, males 110.55, females 200.7; literary and scientific persons, males 102.9, females 126.0; actors, males 95.0, females 88.1. The smallest increase was in the number of lawyers, being males 6.5 and females 33.0.

SCHOOL SANITATION URGED.

Washington.—Insanitary rural schools result in physical defects which cause needless suffering and hardship in later life, says the United States public health service, in a bulletin just issued.

"The necessity of extending to rural schools the same sanitary advantages now enjoyed by urban schools is obvious," declare the investigators. "This neglect of

sanitary precautions observed in rural communities is undoubtedly due to lack of sanitary knowledge. Instructing the people in the value of sanitation will naturally serve to make them adopt measures such as are now in force in cities for the proper construction and maintenance of school buildings and the regular medical inspection of school children. School hygiene has a great economical value, in that it serves to prevent the spread of disease and makes the children now in the schools healthier members of the community and the country at large."

WATCH NEW CONSTITUTION.

Brooklyn, N. Y.—The Central Labor Union will recommend to the executive board of the State Federation of Labor that it agree upon certain measures to be embodied in the new state constitution. The state body will be asked to appoint a special committee on constitutional convention to work for labor measures when the convention meets, and in the meantime to become acquainted with the demands of organized labor, that same may be properly presented. It is further suggested that a special convention of New York trade unionists be called at Albany next spring, while the constitutional convention is in session, to consider a platform and a program.

NAVY YARD ECONOMY PRAISED.

Washington.—That the gunboat *Monocacy* was built by the government at the Mare Island (Cal.) navy yard, transported to Shanghai, China, and there re-erected by contract at a cost totaling only two-thirds of the sum asked by private ship builders, is one of the references on navy yard economy found in the annual report of Rear Admiral Watt, chief of the bureau of construction and repair of the navy.

"There is now a greater value of new ship building work in progress and authorized at navy yards, and a larger number of navy yards so employed at new construction than ever before in the history of the new navy," the report declares.

PEONAGE LAW ILLEGAL.

Washington.—The United States Supreme Court has held that the code of Alabama, which permits peonage, is unconstitutional because it conflicts with the thirteenth amendment of the Federal Constitution. It was charged that one J. A. Reynolds held E. W. Fields in peonage to work out a debt, and that Reynolds had Fields arrested, according to law, for the purpose of compelling him, by involuntary servitude, to pay the debt.

The defense was that Fields was convicted and fined by a court for selling mortgaged property, after which the court allowed Fields to confess to judgment in accordance with the Alabama law, which was questioned in this case. Fields signed a contract to "work out" the debt, but later refused to abide by it, and was arrested.

CITIZENS MUST BE AROUSED.

Boston, Mass.—In a public address, Health Commissioner McLaughlin declared the average American citizen would not obey a sanitary order unless its purpose was understood. "Once the matter is made clear to him," said the speaker, "his is no perfunctory compliance." To make this possible, it was urged that a campaign of education be started. The health official said:

"The press, the pulpit and the schools can all be made powerful factors in this campaign for better hygienic conditions. Settlement workers, nursing associations and other philanthropic agencies can be enlisted.

"Certainly one of the most important agencies is the public school. I know of no field so promising for public health instruction as the public schools, and especially the lower grades.

"We tested this plan thoroughly in the Philippines in time of cholera epidemics, and this was the most effective way of reaching the parents in the poorest homes."

TO PAY UNION RATES.

St. Louis.—An ordinance providing for union scales of wages on city work is now before the mayor for signature, and it is believed by local organized workers same will be approved. The ordinance calls for the payment of wage rates "as shall from time to time be the prevailing rate for such mechanics and laborers, respectively, as are members of organized labor unions in said city." It is further provided that: "For the purpose of ascertaining such prevailing rate of wages, from time to time the officers charged with the duty of employing such mechanics and laborers shall be and are hereby authorized to resort to and make inquiry of the executive officers of such organized labor unions and to fix from time to time the rate of wages to be paid to such mechanics or laborers employed by the city so ascertained to be the prevailing rate among members of such unions."

SURVEY FOR ALASKA RAILROAD.

Washington.—Chairman Edes, of the commission named by Secretary of the Interior Lane to select routes for the proposed government-owned railroad in Alaska, has returned to this city after a field survey, and is now preparing a report on prospective routes. It is believed the commission will also recommend the government taking over the Copper River or the Alaska Northern railroad.

WILL ACT TOGETHER.

Oklahoma City, Okla.—The joint legislative board, consisting of representatives of the State Federation of Labor, Farmers' union, and the Brotherhoods of Engineers and Firemen, will meet in this city, December 15, for the purpose of framing remedial legislation to be introduced at the next session of the state legislature.

STATE DECLARES DIVIDEND.

New York.—The workmen's compensation commission has authorized the state insurance fund to "announce that it expects to declare dividends averaging 15 per cent on the business of the six months' period, July 1 to December 31, 1914."

It is also announced that "employers who placed their insurance in the state fund will save, on the basis of initial rates, 8 1-3 per cent below the rates of the liability companies, and prospectively 15 per cent dividends, approximately \$250,000, on the cost of their insurance for the first six months, as compared with what they would have been obliged to pay if insured in stock companies. On the other hand, employers who elected stock company insurance will pay, according to the same estimate, at least \$1,250,000 more than their insurance would have cost them in the state fund."

It is stated that readjustments of rates for the next six months' period will be made, and this will reduce the state fund charges 20 per cent below those of liability companies.

URGE BOYS TO JOIN UNION.

Detroit, Mich.—In an address to union newsboys, Judge Jeffries, the well-known police court official of this city, said:

"The world has come to the point where we must belong to some kind of an organization in order to exist. Men in unions are getting high wages because they are in an organization. They are getting wise, and they are learning that by combination they can get better conditions. You boys, as you come together, one, two and three, help yourselves. The world is no longer beginning to rate men by physical strength. Some men accumulate fortunes and don't know how to spend them. What we want is to let all have better houses, better food and better clothing."

BLOCK ARMOR INQUIRY.

Philadelphia, Pa.—Armour plate manufacturers in this state have blocked every effort of the congressional committee to secure information that will enable congress to determine whether the government should erect mills and manufacture its own armor plate. While the steel magnates have been placed on oath, the committee has practically failed in its purpose. The manufacturers defend their position on the ground that the United States is their competitor, and will be treated as such.

COLLECT COMPENSATION.

Waterbury, Conn.—While collecting insurance, Henry J. Larke suffered a freezing of the nose and nasal tissues, resulting in erysipelas, from which he died last March. His widow sued the company, and in a decision just filed by Compensation Commissioner Williams, it is held that employes subjected to excessive cold, which results in injuries or death, can collect compensation.

WAR BUDGET GREATEST YET.

Washington.—Appropriations aggregating \$104,124,512, to carry the army through the coming year, are proposed in estimates which the war department has completed for submission to Congress. This is an increase of \$3,105,300, over the total carried by the army bill for the current year, although reductions are made in the allowances for many branches of the service.

A new item of \$100,000 for purchase of automatic rifles is asked. Altogether \$2,900,000 is sought for ammunition, compared with \$3,000,000 carried in the current law. For field artillery for the organized militia \$2,000,000 is asked, \$2,100,000 having been appropriated last year.

The estimates of the navy exceeds last year's total of \$145,000,000 by about 1,000,000. This department also wants an increase of 240 additional officers and about 4,500 men to fully equip American warships.

COMPLAIN OF DISCRIMINATION.

Washington.—Clerks and draftsmen employed by the government in Washington and at other navy yards and naval stations are discussing methods to secure a thirty days' annual leave, enjoyed by other classified civil service employees. The complaining workers are now only given fifteen days, and in the event of a failure of the department officials to equalize the leaves, it is said Congress will be appealed to.

EXTEND COMPENSATION ACT.

San Francisco.—The state industrial accident commission has ruled that an employe is protected by the state compensation act when he enters the employer's premises,

even though the accident occurs outside of working hours. This decision was made in the case of a worker who was being conveyed to his place of employment in a vehicle owned by the employer. The horse took fright and overturned the wagon, injuring the worker. The commission held the injured man was technically on the premises of the employer and awarded damages.

TO TEST WOMEN'S LAW.

Washington.—Briefs have been filed in the United States Supreme court attacking the constitutionality of the Oregon minimum wage law for women. Summed up, the briefs hold that such legislation is beyond the power of a state, is unsupported by public opinion, would be destructive of business, and would increase the cost of living.

Noncompulsory legislation in Massachusetts and Nebraska is approved in the briefs, but the compulsory legislation in Oregon, Washington, Colorado, Wisconsin, Minnesota, California, and Utah is condemned.

WIRELESS TO RUN TRAINS.

Scranton, Pa.—After a six months' trial, officers of the Delaware, Lackawana & Western railroad announce that they will replace the wire system of telegraphy for wireless telegraphy in the operation of their passenger trains between Hoboken, N. J., this city, and Binghamton, N. Y. It is said that the company is equipping a wireless station in Buffalo, and when this is in operation the transportation department will be able to communicate direct from its western terminal to its eastern terminal, Hoboken.

Among Our Exchanges.

TEMPERANCE, NOT PROHIBITION, IS DEVELOPING THE HIGHEST FACULTIES IN MAN.

Have you not often wished to be able to get away from the humdrum of work, of business, the routine of public, and even, at times, of home life? Have you not asked yourself, if there is really nothing else in this world but hard work and the hunt for the dollar? Have you not longed for a quiet retreat? Have you not gone out with your wife to theater or country, or to a cozy corner in a comfortable eating house, and reveled once more in the blissfulness of exclusive companionship, as you did while you were engaged, or almost so, and not yet married?

"It is foolish and unjustifiable to put a stop to even the most moderate enjoyment or the aforementioned stimulus" (alcoholic drink), quotes Prof. Lafayette B. Mendel, of Yale University. "One does not need to have recourse to the argument that the inclination to acquire it in some form or

other is really the expression of an inextinguishable human instinct which has made itself felt in all ages and by all peoples. One needs only to ask: 'Must our machine, then, always work in the same monotonous, tiresome tempo as the pendulum of a clock? What harm is there if from time to time it pumps somewhat more quickly under a high pressure of steam it, subsequently, during a period of slower work, it can make good this slight unnecessary expenditure of force by drafts from an abundant store of energy, and repair any small damage which its mechanism may have suffered? It is certainly a fact that many a bright fruitful idea has been born from a bumper of fragrant Rhine wine which, perhaps, would never have come from the water jug of a vegetarian. Many a bitter heartache, which would have eaten deeper and deeper by drinking raspberry lemonade, has been softened by a nice cup of coffee; many a trouble, many a care, has disappeared in the smoke of a cigar—and

that is surely worth something in this poor human existence."

It is not he who indulges temperately in alcoholic drink that produces or promotes crime, insanity, poverty or other misery. Rather is it he who would deprive us of part of the joy of living, for he is responsible for that spiritual starvation from which much of this misery and wrong-doing spring.

Time was when the enjoyment of physical existence was the chief aim of living men. With the growth of higher moral ideas came the knowledge that this could not be all there was in life. Unrest took hold of the ancient world, there were protests against the sensual life on the one hand, while the great accumulations of wealth led to greater indulgence on the other hand. Out of the mysticism of the East came the great religious revolution, and the medieval church, going to the opposite extreme, condemned all enjoyment of physical existence.

In the present day we are beginning to see that here, as in other things, truth lies midway—temperance. We see that the men of the middle ages went too far in the reaction from extreme sensuality when they contrasted the "prince of this world" with the prince of the spiritual world and condemned all enjoyment of life as being of the flesh and the devil. We are beginning to see as, according to the biblical account, the Creator saw in the beginning, that the world is good, and we, being in and of the world, have a right to enjoy it, not in the old animal and sensual way, by abandoning ourselves to the lusts of the flesh, but in that temperate way which becomes civilized man.

The prohibitionist has taken only the first step from the ancient days. He remains standing on the ground of medieval morality. For him there is either swinish indulgence or ascetic abstinence and self-mortification. He has not yet taken the second step which would place him in the full sunlight of modern ethical thought recognizing the propriety of temperately enjoying this world as not only compatible with, but conducive to, the development of the highest faculties of man. It always ends in the same thought—temperance—
Ex.

THE SUN AND THE WIND.

Turn back your memories to the old school days, and turn over the pages of the second reader, and you will find the story of the Sun and the Wind. You all remember it. How the Sun and the Wind met one day, and the Wind began to boast about its strength, and challenged the Sun to match forces. The Sun accepted.

"See that old man," said the Wind. "I can take that coat off of him much quicker than you can." So the Wind started. The Sun went behind a cloud, the temperature dropped and a fierce gust of wind swept

round the old man. But the harder the wind blew the tighter the old man buttoned his coat, and the tighter he clung to it, until finally the Wind gave up in despair.

Then the Sun came out from behind the cloud, and cast its mellow golden beams upon the silvery hair of the old pedestrian. The old man mopped his head with his handkerchief. Soon he unbuttoned his coat, and at last as the Sun broke upon him in one grand smile of warmth he took off his coat and placed it on his arm.

The Brother in the Labor Movement who you think wears a coat of prejudice because he does not exactly agree with you on every fine point of economics and tactics, his friends say is but a little strong minded. Perhaps you yourself are not wholly without fault. One thing remember you can never make him change that coat by blowing and blustering at him, and telling him he is positively wrong.

Why not try a little sunshine? Why not cultivate his acquaintance, and talk things over with him. You will find that the average man you consider prejudiced has some mighty good ideas of his own. Ideas you have never dreamed of, and which it will benefit you to know about.

There is need of a lot more sunshine in the Minneapolis Labor Movement, and of a lot less bluster and wind.—Labor Review, Minn.

REAL WORK TO DO.

No one should think himself privileged to give his time and ability to amusement only. Everyone has a duty in the world to be of use to himself and to those with whom he has to do. The most satisfactory life is that which has been of most benefit to his fellow man. It is not only in great things that this duty calls. There are boys and girls to whom a word given at the right time might be the means of putting them on a better path. There are the old who are wearied and discouraged in the life struggle and to whom a word of appreciation gives real joy. A cheerful little chat does much to brighten the day for an old person. There are sick to be cheered and encouraged; there are neglected ones who would be made happier by some timely little attention. The eye should be kept open and the ears alert that no opportunity of doing a good, kind deed may be lost. To bring happiness in place of sorrow, to relieve suffering, to guide the wayward—this is leading a useful life. No one who lives rightly, can live for himself alone.—Milwaukee Journal.

SPIES DISCOVERED IN LABOR COUNCIL IN AN OHIO CITY.

American Federation of Labor Organizer Howard Keating, sprung a real sensation at Akron, O., when he notified the Central Labor council that H. E. Ellis, financial secretary of that body, and B. Furey, corresponding secretary, were spies in the pay

of the employers of that city. Ellis made a confession implicating a number of supposed union men and women who were also drawing pay as spies.

Those spies are held responsible for many of the controversies arising between the employers and workers in the Ohio city.—Detroit Labor News.

REPLIES TO NAVAL CRITICS.

Secretary Daniels Declares That Navy Is in Fine Shape.

Washington.—Statements made by Senator Lodge and Representative Gardner, Massachusetts, regarding the need for an investigation of the nation's military and naval defenses, brought responses from Secretary of the Navy Daniels.

Referring to Representative Gardner's statement that there were only fifty-eight long range torpedo tubes in the navy, Secretary Daniels asserted that inasmuch as these tubes can be used only on the new ships beginning with Nevada and Oklahoma, the navy was really preparing in advance instead of being delinquent in this respect.

"Senator Lodge has been a member of the naval affairs committee of the senate for many years," the statement says, "and if he knows, as he says, what we have, why does he want an inquiry? Congress determines what the navy shall have. We have been making progress and the navy is in fine shape."—Daily Paper.

BAD TEETH A CAUSE OF CANCER.

Constant irritation of any part of the body is now well recognized as an important contributory cause of cancer. One of the forms of irritation which has been repeatedly observed to result in this disease is the constant friction of the sharp edges of bad teeth or of imperfect plates against the sides of the tongue. To be sure, sores on the tongue caused in this way do not always become cancer. Neither are wounds from toy pistols always followed by lock-jaw. But there is danger in both cases, and it is as easy to avoid it in the one as in the other. A bad tooth should never be tolerated in any event, and the danger of cancer is only one more good reason for having it attended to. Cancer of the tongue may occur at any age, but it is most common between 40 and 60. Statistics show very few cases under thirty. The majority of these cases occurred in females, while in later years males were found to be more frequently attacked. Cancer of the tongue in young subjects is especially fatal. Out of thirty cases there were only two recoveries. The others died within ten months or could not be traced. As one-third of all the cases investigated have been shown to be definitely associated with jagged or decayed teeth or imperfect plates it would seem that here, at least, is one method of preventing cancer. It is probable that other conditions occurring in combination with the bad teeth increase the likli-

hood of cancer of the tongue as a result, but the removal of this form of irritation is so simple a matter that deaths in cases of this kind must be mostly charged to pure neglect. Where a sore place caused by a jagged tooth does not promptly heal there is real danger of cancer. If the removal or treatment of the tooth does not relieve the situation and the ulcer continues, prompt operation is necessary, for this form of cancer is quickly fatal.—Journal, American Medical Society.

BOILER MAKERS' BANQUET PROVES A BIG SUCCESS.

About two hundred members of Boiler Makers' Local 317 enjoyed a banquet at the Labor Temple Wednesday evening. Practically all of the members of the organization employed in the oil fields were present. Automobile stages were run to Pond and Taft to bring the boys in and take them back to their work.

At 7 p. m. a business session was held and following the business meeting which ended at 9 o'clock the banquet was served in the main hall at the Temple. From 10 o'clock until midnight the boiler makers and their guests partook of the sumptuous dinner which had been prepared and was served by a crew of caterers from the French Cafe under the direction of Jack Wallace.

W. W. Harris, editor of the Union Labor Journal, acted as toastmaster and among the speakers who responded were William Jones, secretary of 317; J. Thompson Stanton, president of the Labor Council; R. W. Henderson; Barclay McCowan, district attorney-elect; J. J. Fitzpatrick, Tommy Egert, Richard C. Miller, Coral F. Roberts, associate editor of the Union Labor Journal, C. B. Dantelson, Arch Dixon, coroner-elect; Frank Walker and J. W. O'Connor of the Boiler Makers' organization.

The meeting was called to order by John Dick, international organizer for the Boiler Makers, who stated that the purpose of the banquet was to afford the members of Local 317 working in this jurisdiction to have an opportunity to meet with local representatives of organized labor and express to them their appreciation of the efforts of the local union men in behalf of the Boiler Makers in the strike early in the present year.

Many were the appreciative remarks addressed by the speakers to the Boiler Makers who are accredited with having one of the most militant and at the same time most efficient organizations in the country.

Selections on the piano were rendered by Professor Mott which were among the most appreciated features of the evening.

A flash light picture was taken by artists from the Marcell studio. Those desiring a picture can secure one at the studio.

The banquet was in every way a success and will long be remembered by members of 317 and their guests.—The Union Labor Journal, Bakersfield, Calif.

WHY SHOULD LIGHT COME FROM LEFT SIDE.

The well known fact that, when using the eyes for any near work, the illumination should come from the left side rather than the right is often disregarded. Let anyone who considers the matter of little importance once demonstrate to himself the difference and he will never forget it. Take a pencil and paper and try to write while in such a position that the light will fall from the right side. The shadow of the hand or pencil or both is thrown on the paper in such a way as partly to cover the characters one is making. This necessitates a closer viewpoint and a conscious strain on the eyes. Now let the position of the writer be reversed so that the light falls on the work from the left side. He will notice that the shadows fall away from the work he is doing and leaves the field unobscured. In making the change he cannot help but notice the feeling of ease that immediately is experienced by the eyes. This applies to any other kind of near work in which the fingers work under the guidance of the eyes. This fact should be remembered in planning school-rooms, workrooms, offices and any places where steady close work is to be performed.—Journal American Medical Society.

THE "AIR TOWEL."

Agitation for the suppression of the roller or common towel for public use has swept over the entire country, as it is considered a menace to public health. Shortly after the elimination of the public drinking cup by all authorities, the crusade on the common towel in public places started, and some ten months ago Massachusetts, Ohio, and Michigan passed laws prohibiting its use; since then more than thirty states have made similar laws.

The common towel was succeeded by the paper towel, the use of which requires, besides the initial expense of the towels, an attendant to supply fresh and remove soiled and wet towels from the lavatories. Now the last word in economical and sanitary innovations is the "air towel" used in the large public lavatory in the District Building at Washington, D. C. This "air towel," or electric hand drier, is the invention of J. M. Ward, superintendent of the District Building. In appearance it resembles a rectangular box 11 by 13 inches set on a sanitary base having 12-inch legs, with an opening in the top of the case in which the wet hands are held while being dried. The device consists of a blower that forces air through an electric heating element to ducts and deflectors suitably placed for distributing the warmed air to all parts of the hands at the same time, and is operated by a foot lever or pedal, which in turn operates a quick-acting switch, thereby setting the blower in motion; by removing the foot the device is put out of operation: the hands come in contact with no part of the device, thus assuring a perfectly sanitary operation.

It takes just thirty seconds to dry the hands, and although this seems long while standing with the hands in the drier and practically unoccupied, tests have shown that the ordinary operation of drying the hands with a towel consumes more time if the hands are to be dried as thoroughly as by the electric drier. Being dried perfectly, there is no unpleasant sensation.—The Granite Cutters' Journal

LEARNING TO KNOW EACH OTHER.

In the school house in Bellevue, Wis., a few evenings ago, upon motion of the Catholic priest, the Methodist minister was elected president of the community's social center for the coming winter.

Then three basket ball teams were formed, including the priest, the minister, the blacksmith, the editor, a farmer, the keeper of the village restaurant, a dentist, a clothier, a teamster, a druggist, a garage owner, the banker, the saloon keeper, a hardware merchant and a house painter.

They differed in religion, in politics, in incomes, in social status, about as widely as men can differ. But in the common school building, in the free democracy of the social center, they agreed to lay aside their differences for the novel purpose of discovering how much good fellowship there was in meeting together, now and then, as equals, as brothers.

In the democracy of play, in the democracy of rank, fair discussion of public questions, they are finding out, these differing men of Bellevue, that, as human beings, they're amazingly alike, once you get below the surface.

And out of this agreeable discovery will come, for Bellevue, more tolerance, more kindness of feeling, more give and take, than it had ever known before. Even when they shall differ again—as of course, they often will—it won't be with as much bitterness, as much bigotry, as much mean hate, as of yore.

It's a wonderful solvent, is brotherhood.—Stockton Record.

THE FREIGHT RATE DECISION AND PUBLIC OWNERSHIP.

For the benefit of the railroad corporations the Interstate Commerce Commission has consented to the levy of a special tax on the already over-burdened industry of the United States. That is what the 5 per cent increase in freight rates means. The action taken is not surprising, in view of the heavy pressure brought to bear upon the commission for many months. Resistance to such pressure was difficult, and this fact should be borne in mind in passing judgment on its action. But clearer than ever, through this decision, is it shown to be a fallacy that in public regulation is the solution of the public utility question. For a while it seemed as though the Interstate Commerce Commission had furnished an example of a regulative body that actually regulated. But the very restraint it

put on the predatory tendencies of the railroads must have stirred these corporations to stronger efforts to subdue of commission. These efforts seem finally to have met with success. The two latest appointments evidently strengthened corporation influence. Even in the case of so efficient a body as the commission, it is now shown possible for the regulators to fail to regulate. How can anything better be expected, then, of the many public service commissions, created to evade application of the real remedy for franchise monopoly—public ownership? The commission's decision, however, is a severe blow to the cause of private monopoly of public highways. It makes clear that nothing but public ownership of railways can prevent railroad domination of government.—The Public.

THE RIGHT OF PETITION MUST NOT BE ABRIDGED.

Is the right of petition guaranteed in our constitution a paper right or one that may be invoked by every citizen? Does a government employe alienate this right because he works for the government? If they have not the right to petition for redress of grievances, how do they differ from the subjects of an absolute despotism? Free men cannot with safety give up the right of petition or the right of self-protection, whatever the nature of their employment. The railway mail clerks charge that they have been denied this right. Some time ago the railway mail service introduced a system of "scientific efficiency" based upon the stop-watch and time study researches. The motions and the reactions of the clerks were noted and timed by "experts" in efficiency who stood guard with stop-watches in hand. The clerks were treated like machinery, to be speeded up to the highest rate possible. They charged that the real purpose of this humiliating treatment was to establish standards to prevent many from securing promotion.

The railway clerks exercised their constitutional right and sent petitions to representatives and senators, protesting against the efficiency system. Meanwhile Senator Borah had introduced a bill prohibiting a time study of the movements of employes by means of a stop-watch or any time-measuring device and also prohibiting payment of a premium or bonus as wages.

In September Mr. Alexander H. Stephens, general superintendent of the railway mail service, made a speech in Indianapolis, in which he said:

"And let me tell you that anybody that signs that petition with that statement is up before the General Superintendent of this service for removal for lying. Tell your fellow clerks that. I do not think any of you gentlemen in Indianapolis have signed that petition, but whoever signs it is going to come up before the General Superintendent for removal."

Such a threat was a gross, illegal and tyrannical interference with the constitutional rights of the railway clerks, rights which are peculiarly valuable to them, since they are denied the usual methods of redress used by employes in private industries. So pressing were the needs of these clerks and so great was the coercion exercised by the superintendent that many of them wrote to Senator Borah, asking to have their names removed from the petitions. These letters state directly or indirectly that the writers cannot afford to imperil their means of earning a livelihood.

This is indeed a serious situation and should be carefully and thoroughly investigated by the Senate Committee on Education and Labor, to which the letters were referred.

So great a value did our forefathers who established the independence of our country put upon this right that they demanded it to be put in the amendments to the constitution. The following is the first amendment:

"Congress shall make no law respecting an establishment of religion, or prohibiting the free exercise thereof; or abridging the freedom of speech or of the press; or the right of the people peaceably to assemble, and to petition the government for a redress of grievances."

This right of petition is a right necessary to a free people and must be maintained inviolate. The railway mail clerks must and will be protected, and they themselves must insist upon their rights.—American Federationist.

THE GIRL AND THE YOUNG MAN.

No girl who respects herself will accept from a young man attentions which she knows he is not able to give. When a young man on a \$15 a week salary splurges around on a \$15 a day basis, something is wrong, and the girl who allows such a young man to spend money for her entertainment is indirectly a party to the wrongdoing of which he may be guilty. A case in point is a young man, only 18 years old, who has been brought back from Toronto to New York, charged with the theft of \$4,000 worth of jewelry. His first stealing he confessed, was to "make a front" with a girl at a dancing contest. He took a pin and a ring from his employer, expecting to return them. He never did return them, and this first theft, made in order to shine with a "little beauty" at a dancing contest, led to many other thefts for himself and others. No one would be foolish enough to seek to excuse a young man for stealing in order that he might make a dashing appearance in a tango. The less obvious moral we would draw from the incident is that a girl is not using her influence as she should when she countenances or encourages extravagance in a young man.—Leslie's Weekly.

SPOTS BEFORE THE EYES.

The prevalence of this condition has given rise to a great many curious ideas. Almost everyone either sees fixed or floating spots at times, or hears some friend complain of these conditions, so that it is not strange that many misconceptions have arisen. The commonest form of floating spots are those which are known by the name of *muscae volitantes*, an old name which indicates how long the condition has been observed. These are tiny transparent chains, or strings, which are seen especially on a white or brightly illuminated field. They persistently float in the line of vision, and though a shake of the head may carry them out of the way, they at once float back again. These spots are probably caused by the remains in the fluid part of the eye of certain cells which should have been completely absorbed in the development of the eye. They never lead to impairment of vision and, as before stated, are perfectly transparent. Other floating spots are due to cob-web-like masses of inflammatory material which are thrown out into the fluid of the eye by some low grade inflammation.

These spots usually obscure the vision, which is their great point of difference from the former ones. It is, of course, very important to find out in any case whether the spots are due to inflammation or not, and this can only be done by a skilled observer. It is a prevalent idea that the wearing of a dotted veil may leave permanent spots in the field of vision. While the dotted veil may be a source of strain by causing the wearer to pull on the eye muscles in order to avoid the obstruction to vision, it certainly is not the case that the dots, or any other object seen, can be permanently photographed on the nerve tissues of the eye. There is only one exception to this statement. Many people who have carelessly looked too much at the sun, generally in observing the eclipse, have actually produced a slight inflammatory change in the retina, so that there is always a blurry spot wherever they look. But it is doubtful if any light less brilliant than the sun can produce a permanent spot, and certainly a dark object cannot do so.—Journal of the American Medical Association.

News of General Interest.

A COMMUNICATION FROM THE SECRETARY OF THE AUSTRALIAN BOILER MAKERS AND SHIP BUILDERS' UNION.

Note.—The following communication was received from Secretary O'Toole of the Australian Union, which was in response to our letter of greeting after having secured his name and address in one of our foreign exchanges, and is reproduced for the benefit of our members.—The Editor.

Newcastle, October 29, 1914.

James B. Casey, Esq.,
Editor-Manager Boiler Makers' Journal,
America.

Dear Sir and Brother:

I have to acknowledge receipt of your favor of August 31, which reached me a few days ago; also the two copies of your official journal, for which I thank you.

I regret to say that I cannot return the compliment, as we in Australia have not yet published a journal or report, but I hope to be able to do so in the very near future.

I shall be very glad to have a copy of your constitution, as you were kind enough to suggest, and I will forward under separate cover a copy of our Interstate Conference, which was held in 1911 and a second one in 1913; the former contains a copy of our rules, but in this connection I have to state that at the present time we are having them revised by our legal advisers, as in their present form they are not quite in accord with our Federal Arbitration Act, etc.

I inclose a couple of our balance sheets, which may be of interest to you.

I have read your journals with interest, and will be greatly obliged if you could forward them to me regularly, and expense in connection with the matter will be gladly borne by me.

A brief outline of the career of our society may also be of interest:

For a number of years the Boiler Makers in Australia carried on in their respective states in their own particular way without any connection with each other whatever. In October, 1902, an Interstate Conference was held at Sydney, N. S. W., at which representatives of the Societies in N. S. Wales, Queensland, S. Australia and W. Australia were present. The result of this conference was that a federal funeral fund was established and it was agreed that each state should contribute the sum of 4/4 per annum for each financial member on their books towards this central funeral fund. Further conferences were held in 1905 and 1908, and although the question of a closer amalgamation was debated at these conferences, nothing tangible was done in the way of bringing the societies together before the Interstate Conference, which was held in 1911. As a result of the deliberations at this conference a Federal Council was established and they took over the control of the Federated Boiler Makers and Iron Ship Builders, etc., was then registered as an industrial union, with the Federal Arbitration Court.

We have at the present time 15 branches of the society in Australia, with a total membership of about 2,900.

Each branch still controls its own finances and is empowered to make its own rules to suit local requirements, provided such rules do not infringe on the federal code. The Council is sustained by a fee of 2/2 per member per quarter, which is paid by each branch for the members on the books at the end of each quarter. We have a system of clearances which hold good all over Australia and members benefit accordingly. Each state has its own industrial legislation, which differs very largely so that we have found it extremely difficult to set up a constitution which will meet the peculiar requirements of each state. The Federal Arbitration Act is of little or no use to us in its present form, so that up to the present we have not bothered about trying for a federal award for Boiler Makers. In N. S. W. we have a Wages Board system which has contributed largely to our difficulties, as there are no less than 12 tribunals which have boiler makers' condition included in their constitution. Although we have fought hard and spent much money we have not been successful in altering this condition of affairs.

We are working along the line of amalgamating the funds of the branches and ultimately having one central board of control, this I hope to see achieved ere long.

I shall be very glad to communicate with you at any time and to afford you any information as to Australian conditions of labor so far as boiler makers are concerned.

I read with interest your report re the Boiler Inspection Act, particularly as we have for a number of years been trying to have such a measure introduced into our legislation here, but without success up to the present. All our states have a Boiler Inspection Act but N. S. Wales have not placed such desirable act on their statute book yet. The railway systems being state-owned have competent boiler makers for the periodical inspection of locomotive boilers and as a result of their strict inspection very few boiler accidents have occurred. I sympathize with your desires to have competent boiler makers appointed as inspectors; we have had the same trouble with the marine inspections, where invariably an engineer is appointed, as he inspects the machinery as well as the boilers and hulls of steamships at their bi-annual inspections.

The matter of an acknowledgement of transfers or clearances will be placed before my executive at the first opportunity and personally I should like to see the arrangement accomplished.

I have only recently taken over the secretaryship of the Council and I am trying

hard to bring our organizations closer together than they are at present.

With fraternal greetings from Australia to our comrades across the sea and with best wishes to yourself, I am

Yours fraternally,

JNO. O'TOOLE,

Secretary Australian Federal Council.

NAPOLEON.

(By Robert G. Ingersoll.)

A little while ago I stood by the tomb of the first Napoleon, a magnificent tomb of gilt and gold, fit almost for a dead deity, and here was a great circle, and in the bottom there, in a sarcophagus, rested at last the ashes of that restless man. I looked at that tomb, and I thought about the career of the greatest soldier of the modern world. As I looked in imagination I could see him walking up and down the banks of the Seine contemplating suicide. I could see him at Toulon; I could see him at Paris, putting down the mob; I could see him at the head of the army of Italy; I could see him crossing the bridge of the Lodi, with the shadow of the Pyramids; I saw him returning; I saw him conquer the Alps, and mingle the eagles of France with the eagles of Italy; I saw him at Marengo; I saw him at Austerlitz; I saw him in Russia where the infantry of snow and the blast smote his legions, when death rode the icy winds of winter. I saw him at Leipzig, hurled back upon Paris; banished; and I saw him escape from Elba and retake an empire by the force of his genius. I saw him at the field of Waterloo, where fate and chance combined to wreck the fortunes of their former king. I saw him at St. Helena, with his hands behind his back, gazing out upon the sad and solemn set; and I thought of all the widows he had made, of all the orphans, of all the tears that had been shed for his glory; and I thought of the woman, the only woman who ever loved him, pushed from his heart by the cold hand of ambition—and I said to myself as I gazed: I would rather have been a French peasant and worn wooden shoes, and lived in a little hut with the purple grapes growing red in the amorous kisses of the autumn sun—I would rather have been that poor French peasant, to sit in my door, with my wife knitting by my side and my children upon my knees with their arms around my neck—I would rather have lived and died unnoticed and unknown except by those who loved me, and gone down to the voiceless silence of the dreamless dust—I would rather have been that French peasant than to have been that imperial impersonation of force and murder who covered Europe with blood and tears.

BURLAP WRAPPINGS ON STEEL PIPE.

By Frank C. Perkins.

The use of saturated burlap wrappings on lock bar steel pipe as utilized at the West Jersey Pipe Works at Paterson, N. J., may be noted in the accompanying illustration. It is claimed that the use of insulating wrappings for large water mains prevent corrosion and are useful in the mitigation of electrolysis of buried pipe and either underground structures with complete insulation by impervious wrappings possess great practical merits.

Greater mechanical strength of the common protective coatings against abrasion is secured during transportation and installation if some sort of fabric is wrapped around the pipe. The effective thickness of pro-

Where the pipe has been dipped in the mineral rubber coating and the coating has sufficiently set to prevent flow in the subsequent operations, it is wrapped with 10-ounce Calcutta burlap cut into strips 18 inches wide. The pipe is placed on centers of the wrapping machine where it is carried on the reel of a carriage traveling longitudinally during the rotation of pipe.

It is drawn from the reel by the revolving pipe through a tank containing a hot solution of mineral rubber pipe coating and is then wound spirally on the pipe, the burlap being lapped upon itself to about the width of an inch. The tension of the burlap while winding is sufficient to cause the burlap to lap close and snug on the pipe, but not enough to strain or tear it.

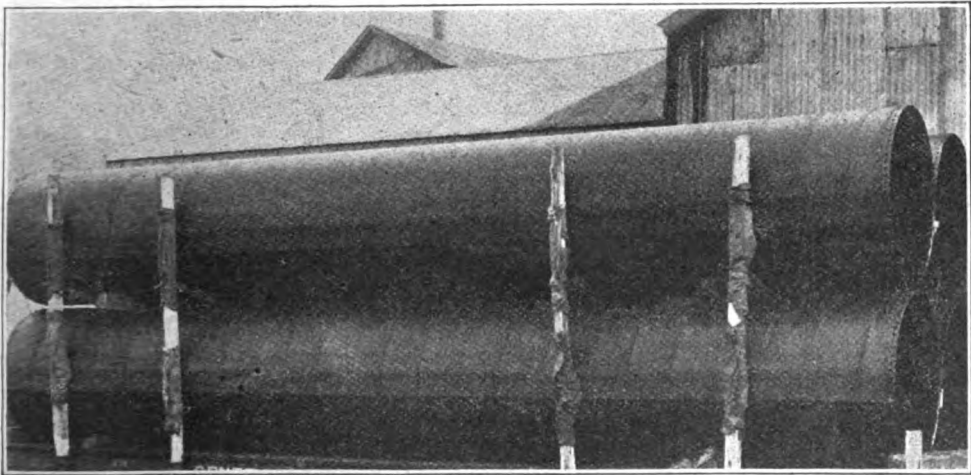

tection is also cheaply increased. At first the pipe is dipped in the regular pipe coating (mineral rubber) as usual, and after this coat has set, it is sent to a wrapping machine in which the pipe is rotated on centers. The bed of a lathe-like machine carries a shallow pan containing pipe coating maintained in a liquid condition by a furnace built under the pan. A carriage travels longitudinally over the pan, carrying burlap strips 18 inches wide and wound on a reel.

This is unwound from the reel and wrapped on the pipe by the rotation of the latter and in traveling from the reel to the pipe the burlap is passed, by means of guide rolls through the coating in the pan so that it becomes thoroughly soaked. The combination of the rotating motion of the pipe and the longitudinal travel of the carriage results in giving the pipe a spiral wound burlap covering with a lap about an inch and strongly adhesive to the pipe.

The wrapping is kept back far enough from the ends of the pipe to leave the rivet holes accessible and not interfere with the making of the field joints.

After the pipe is laid, riveted, calked and tested, the field joints are wrapped with one wind of the burlap which has been immersed in field coating. This insulated pipe has been used $\frac{3}{4}$ and $7\frac{1}{2}$ feet in diameter by the cities of Winnipeg, Minneapolis and Montreal. The cost of this wrapping is from 35c to 60c per foot of pipe.

DISCUSS WORKMEN'S COMPENSATION.

Philadelphia.—With more than two hundred delegates in attendance from all parts of the country, the American Association for Labor Legislation opened its eighth annual meeting here today at the Hotel Walton, with a joint session with the City Club of Philadelphia, for the discussion of work-

men's compensation measures. The meeting was opened by the reading of a message from Dr. Martin Brumbaugh, governor-elect of Pennsylvania, on Pennsylvania's opportunity to enact an adequate workmen's compensation law in 1915.

Congressman Daniel J. McGillicuddy, of Maine, spoke on "Workmen's Compensation for Federal Employees," a modern bill for which he has introduced in the House of Representatives. "In a 330-page report," said Mr. McGillicuddy, "the Federal Bureau of Labor Statistics recently described the first five years' operations under the present out-of-date and inadequate compensation law for federal employes. The report showed that fractures of an arm or a leg have led to payments in amounts less than \$25, the loss of an eye in amounts varying between \$25 and \$50, and in a case of the loss of a right arm the injured workman was entitled to a payment of less than \$50, while in three cases of the loss of both legs the average compensation was \$377.40. No other country, furthermore, offers to the widow and children of an employe killed in its service an amount so pitifully and disgracefully small." The new bill, Mr. McGillicuddy continued, has been drafted with great care to supplant the existing law. It covers all civilian employes of the government, it provides compensation for occupational diseases as well as for accidental injuries, and establishes a scale of 66 2/3 per cent of pay during disability.

John Mitchell, of the New York State Workmen's Compensation Commission, gave a brief statement of the successful operation of the New York law, the most liberal as well as one of the newest in the country. "The State Workmen's Compensation Commission of New York," said Mr. Mitchell, "is handling compensatable claims under the new law of that state at the rate of 70,000 per annum, and first notices of injury at the rate of over 200,000 per annum. The commission is now able to keep up with its business, which is creditable in view of the fact that the compulsory law became effective on a given day in July, and the full onslaught of the state's business was felt by the commission. Naturally, there still remain some crudities to be worked out, and a few exasperating delays, but the progress of organization indicates that within a few weeks everything will be running smoothly.

"It may be said that the law gives general satisfaction, with the possible exception of the matter of insurance rates, which experience is proving to have been too high. But this is the common experience of every state adopting such laws. Lack of compiled statistics compels the rate makers to put themselves on the safe side, and a rate to be safely high must be too high. However, in the administration of the state insurance fund the commission has been able to declare a general average of 20 per cent,

reduction in rates, and in addition to that to refund 15 per cent dividend upon business of the first semi-annual period.

"In its schedule of benefits, New York offers the most generous measure of compensation in the entire country, and it can be safely said that it has the best balanced schedule. That the schedule of 66 2/3 per cent is not too high is best evidenced by the fact that according to the present payments the law, when it has settled to a firm basis of administration, will entail little or no added burden upon the industries of the state. The money hitherto paid out by employers for liability insurance, for time off aid and for medical services, will more than accomplish the full measure of compensation.

"Some embarrassment of administration results from doubtful coverage under the law, it being sometimes difficult to determine whether or not an employe has his rights under the common law or under the compensation law.

"In the expense of administration, which is a good index, New York's early experiences are favorable. Based upon the total premium income the expense ratio is smaller than 4 per cent; and based upon the aggregate payment of compensation it is about 10 per cent. This is in fine contrast with the very expensive system heretofore prevailing.

"It can be said for the New York statute that it is a practicable one, and that the end of the first year of administration will amply justify its enactment. Employers will be more and more satisfied as the rates are adjusted to actual cost. Employes will be more and more satisfied as speed is developed in the handling of claims. Both of these requirements will easily be made by the development of experience and the lapse of a few months."

A number of speakers took part in the informal discussion which followed.

MOVING CHICAGO STEEL GRAIN TANKS

By Frank C. Perkins.

The accompanying illustration shows the method utilized in the moving of the great steel grain tanks at Chicago, Ill.

This remarkable undertaking of the moving of large steel storage tanks a distance of about five miles in connection with the removal of the Albert Dickinson seed plant of Chicago to a new location at Washtenaw Avenue and Thirty-fifth Street, near the Drainage Canal, was accomplished without difficulty.

The old site was being cleared for the new terminal work of the Pennsylvania Lines. The plant included 22 steel storage tanks 60 and 40 feet high and 30 feet and 40 feet in diameter, weighing 40 to 50 tons each, and as these were in good shape it was desired to move them to the new plant.

It will be noted that the tanks were covered with conical tops supported on light radial trusses. A timber gallows frame was built, large enough to straddle a 60-foot tank, and having two sets of hoisting tackle on the crossbeam. This was set up over a tank, and the hoisting hooks attached to two sling plates bolted to the top of the tank. It is stated that then the rivets of the middle circular seam were cut out by hand, and the upper half of the tank was lifted by the tackle. The lower half was raised by jacks sufficiently to allow of placing under it four heavy timbers, with blocking and wedges to support it at various points.

and the tank sections hauled on this and onto a large deck scow, the scow holding three sections. The scow was then towed down the river and the Drainage Canal to a point near the new plant. A roller runway supported on piers of blocking was extended from the deck to the bank, and the tanks were hauled off by a horse winch.

It is said that the final disposition had not been decided. They may be erected on a site adjacent to the canal, or they may be moved to the site occupied by the rest of the plant. In the latter case, they will have to be raised and transferred across two railway embankments and a small canal.

It is held that the tanks could have been

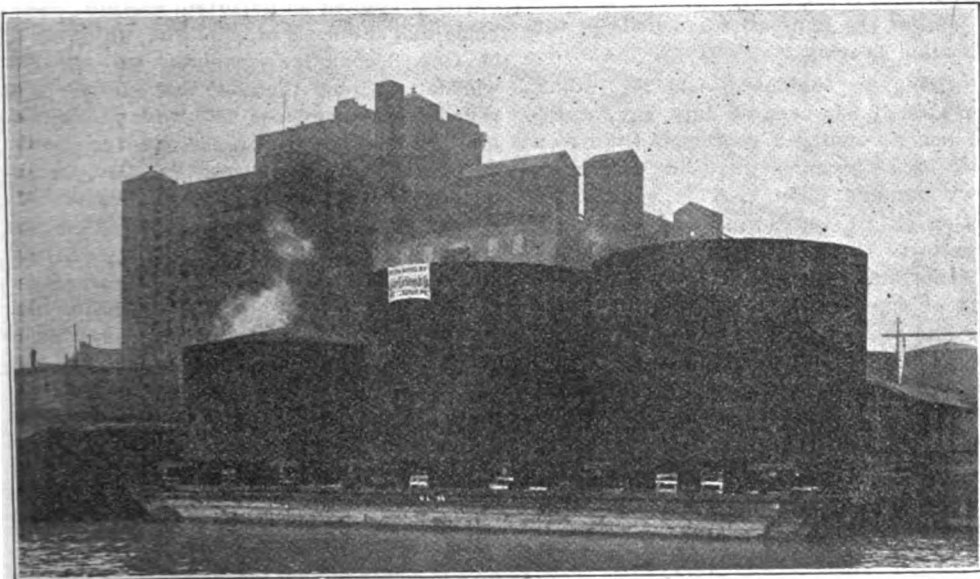

Finally under the supporting frame were two lines of timbers with planking, forming roller runways for the wooden rollers used in moving buildings. The lower section of the tank was then hauled out by a hoisting engine, the block of the hauling rope being hooked to a bridle attached to the two side timbers of the supporting frame.

There was a similar frame built and the upper section of the tank lowered upon it. These frames remained under the tanks throughout their removal. Each section of tank was held in shape by an interior frame of four timbers, with blocking between these and the tank shell.

There was also interior ties of wire cable attached to threaded rods which passed through rivet holes and were secured by nuts. A double-track roller runway was built through the yard to the river bank,

moved without cutting them apart, but for the large number of electric wires and cables strung along the Drainage Canal. The river trip was somewhat slow, as there were 17 bridges to pass. The Western Avenue swing bridge over the canal had no operating machinery, and to be operated by the tugs, which cast loose the scow and hitched their two lines to chains hanging from the ends of the adjoining bridge.

This remarkable work was accomplished by the Pittsburgh engineers, John Eichleay, Jr., Company.

RELEASED ON RECEIPT.

Chicago.—The first week of the arbitration hearing of the demand of 65,000 employes of the Western railroads for better wages and working conditions developed important testimony favoring the employes. Four witnesses were on the stand during the week

and all of them by word of mouth and by strong exhibits of statistics and regulations proved that the requests of the workmen are just. The introductory speech for the engineers' and firemen's brotherhoods was made by Warren S. Stone, Grand Chief Engineer of the Brotherhood of Locomotive Engineers. Mr. Stone drew a vivid picture of the hardships, long hours, constant strain and unpleasant working conditions at present the rule among railroad employes in the west.

He spoke of the so-called surprise test as conducted by several of the western railroads as amounting almost to torture. This was one of the impressive moments of the arbitration hearing.

"Imagine an engineer," said Mr. Stone, "who already has been on duty, say for sixteen hours, running a passenger train at a speed of sixty miles an hour through a snowy winter's night. This engineer is fighting off tired nature, doing his utmost to perform the very serious labor which confronts him. He sees ahead through the mass of snow flakes a white light which tells him the way is clear; there is a curve just beyond and the giant locomotive leaps and bounds around it at a speed which a layman would say in itself is not exactly safe.

"Through the woolly haze now the engineer sees a line of freight cars on a siding and just as he detects them, there is flashed a red light which instantaneously carries to his mind a warning of danger and possible death. He resorts to the air brakes, and he and the fireman both prepare to jump, knowing that if the heavy passenger train takes the siding and jams into the freight cars there is no chance for either of them in the locomotive cab. His heart is in his mouth—I may say here that if these surprise tests are kept up it will be no uncommon thing for engineers to be found dead in their cabs—when suddenly a white light again is flashed before him, he has the right-of-way and he discovers that the whole event has been a stage affair. That is, some minor official of the railroad has gone to the trouble of arranging conditions with the devilish idea of giving old employes of the line a severe trial.

"What we object to, Mr. Chairman, is not a fair surprise test, or rather an efficiency test, as it should be termed, but to the test

which is overdrawn, which is not a routine affair of travel, and which the engineer and fireman probably never in their careers would have to face. This condition has become so bad that we have even sought legislation against it. In Kansas, we will show, a law has been passed forbidding offensive surprise tests. However, we will show that despite this law railroads in Kansas still are resorting to it."

William S. Carter, President of the Brotherhood of Locomotive Firemen and Enginemen, was one of the strongest witnesses of the hearing during the week. Mr. Carter presented an important exhibit which holds that the basis of employes' pay should be the locomotive's weight on driving wheels; not only this, but that the more a railroad employe does to produce higher profits for his employer, the greater should be the employe's compensation. Mr. Carter under cross-examination by James M. Sheean, counsel for the railroads, emphasized the fact that the higher cost of living and installation of so-called safety first devices should be given great weight by the arbitration board in adjusting the wage scale. The witness held that the increased cost of living is obvious and that the installation of safety devices, although they inure to the benefit of the traveling public, has vastly added to the engineers' and firemen's responsibilities and cares.

Where inventive genius has been able to put devices in the modern locomotive which give it power to haul longer and more profitable trains, not adding to the burdens of the men in the cab, President Carter contended that the profit sharing idea should enter here. That is, he held that where the installation of such devices on locomotives conspire to increase the profits of the railroad companies, the economic theory is, and the philanthropic idea is, to share with the employe such gains.

Other witnesses of the week were M. W. Cadle, Assistant Grand Chief of the engineers' brotherhood; Walter D. Moore, a clerk in the grand lodge office of the firemen's order; and Samuel T. Steinberger, another clerk in the firemen's office force. They presented figures and rules and regulations proving that many roads in the western territory not only at the present time pay as high wages as the brotherhoods are requesting, but in many instances are doing even better than that.

Smiles.

THE SMUTTY STORY AND ITS DIRE EFFECT.

It advertises your own ignorance.
 It displays your lack of a sense of decency.
 It indicates the state of your inner character.
 It exhibits the nature of your inner soul.
 It shows your better self is being suppressed.
 It illustrates the sordidness of your soul.
 It typifies the meagerness of your resources of entertainment.
 It proclaims the coarseness of your ideas of humor.
 It tells of the inadequacy of your means of expression.
 It reveals the depth of defilement you have already reached.
 It proves to your friends how greatly they may be disappointed in you.
 It stultifies the testimony of those who said you were a good fellow.
 It soils the imagination of your hearers.
 It hangs vulgar pictures on the inner chamber of the imagination of other men from which they cannot escape.
 It disgusts men of finer sensibilities who care for the clean and wholesome things of life.
 It nauseates good men who love fun and hate dirt.
 It dishonors your parents and your wife and your children, and your friends and your home and your business and your God.
 —Ex.

HE WON THE BET.

A traveler came across two men having a heated argument. One said:
 "What do you know about the Lord's Prayer? I'll bet you \$10 you can't repeat the first line."
 "I'll take the bet," said the other man, and, turning to the stranger, asked him to hold the money.
 "Now, what is the first line?" asked the first one.
 "Now I lay me down to sleep."
 "You win," said the first man. "I didn't think you knew it."—Lippincott's.

ONLY HOME AT MEAL TIMES.

"Get away from here or I'll call my husband," threatened the hard-faced woman who had just refused the tramp some food.
 "Oh, no, you won't," replied the tramp, "because he ain't home."
 "How do you know?" asked the woman.
 "Because," answered the man as he sidled toward the gate, "a man who marries a woman like you is only home at meal times."—Dallas News.

The apoplectic little man pounded the counter with his apoplectic little list.

"I never dealt here before and I'll never deal here again!" he shouted. "The management here is rotten. You have nothing, nothing! I'll try once more. Have you any tomatoes?"

"No, sir; sorry, sir," replied the clerk.

"What? Not even in cans?"

"Not even in bottles."

The apoplectic little man crushed his hat down further on his head and bit his mustache until the blood came. He consulted the list in his hand.

"I'll give you another chance! Have you any potatoes? Think carefully now!"

"Not a potato in the place," said the clerk apologetically.

"Ye gods! Well, I'll give you one more chance. I'd like to see the end of this. Have you any sugar?"

"Not a grain, sir. Sorry, sir."

The apoplectic little man sank down on a stool and let his list flutter to the floor.

"And you call this a grocery store!" he said, tauntingly.

"No, sir," corrected the clerk, mildly. "This is a cigar store."

The apoplectic little man rolled off the stool in a fit.—Detroit Free Press.

A reporter on a Kansas City paper was among those of a relief train that was being rushed to the scene of a railway wreck in Missouri. About the first victim the Kansas City reporter saw was a man sitting in the road with his back to a fence. He had a black eye, his face was somewhat scratched, and his clothes were badly torn but he was entirely calm.

The reporter jumped to the side of the man against the fence. "How many hurt?" he asked of the prostrate one.

"Haven't heard of anybody being hurt," said the battered person.

"What was the cause of the wreck?"

"Wreck? Haven't heard of any wreck."

"You haven't heard of any wreck? Who are you, anyhow?"

"Well, young man, I don't know that that's any of your business, but I am the claim agent of this road."—Harper's Magazine.

Hungry Hawkins—Do yer mean to say ye got a square meal o' dat sour woman?

Diplomatic Mike—Sure.

Hungry Hawkins—Well, yer a wonder. How'd yer do it?

Diplomatic Mike—When she opened de door I sez: "Is yer mother at home, miss?"

TIT FOR TAT.

A noted wag met an Irishman in the street one day, and thought he would be funny at his expense.

"Hello, Pat!" he said. "I'll give you eight (in) pence for a shilling."

"Will ye, now?" said Pat.

"Yes," he replied.

The Irishman handed over the shilling, and his friend put eight pence into his palm in return.

"Eight in pence," he explained. "Not bad, is it?"

"No," answer Pat; "but the shilling is!"
—London Tit-Bits.

WHEN SCOT MEETS SCOT.

The lady was the owner of a small shop, writes the London Telegraph, and her squire acquired the habit of seeing her home, and carrying the cash bag that contained the day's receipts. It was generally heavy.

"You must be doin' weel," remarked the gentleman, frequently.

Oh, ay," the lady would reply, "it's a guld bit business."

But she did not disclose that besides the moderate drawings the bag contained the counter weights. The canny lover only discovered that fact after marriage.

One day a college youth went West and got work on a farm. He wasn't very well informed about farm life, but as he was willing to work, the farmer hired him. That night the farmer said, "How are you—a pretty good runner, hey?"

The collegian swelled with pride. "I took the prize at college for being the fastest runner."

"Well, then," said the farmer, "you can bring in the sheep."

Two hours later the young man entered exhausted, his breath coming in short gasps.

"Have any trouble?" asked the farmer, grinning to himself.

"I got the sheep in easy enough," said the youth, "but I had an awful time catching the lambs."

"Why, I haven't any lambs," said the farmer, in surprise.

Together they walked to the pen. There were all the sheep and also five jack rabbits.

The school teacher had punished Tommy so often for talking during school and the punishments being apparently without effect, that as a last resort she decided to notify Tommy's father of his son's fault.

So, following the deportment mark on his next report were these words: "Tommy talks a great deal."

In due time the report was returned with his father's signature, and under it was written, "You ought to hear his mother."

—Harper's Magazine.

TOOK NO CHANCES.

Robert W. Chambers, the author, says that a certain man, who lives in a suburban town in North Jersey, is no beauty. He is not only long and angular, but has a face and complexion that neither pale blue, sky yellow nor any other color in dress effect will attune to.

One day, according to Mr. Chambers, the aforesaid party called to see an acquaintance and, while waiting for him to appear in the parlor, was entertained by the little 8-year-old son.

"Well, what do you think of me?" asked the caller, after conversing several minutes.

Instead of replying the boy turned aside and thoughtfully hung his head.

"You haven't answered me," smilingly persisted the caller. "Aren't you going to tell me what you think of me?"

"No, sir," returned the youngster. "Do you suppose that I want to get a licking?"

Professor Sudbury, who was extremely near-sighted, went to the barber's, sat down in the barber's chair, took off his glasses, and allowed himself to be shaved. When the artist was done with him he did not move and for a while nobody disturbed him. But other customers began to arrive and the chair was needed. The head barber, suspecting that his learned patron had fallen asleep, asked his boy to wake him. The professor overheard the order.

"No, my good man," he said, "I am not asleep. The fact is I am frightfully near-sighted. When I took my glasses off just now I was no longer able to see myself in the mirror opposite. Naturally I supposed I had already gone home."—New York Evening Post.

The old-fashioned farmer, who liked nothing more than to dicker, bobs up now and then to rub elbows with the moderns.

In a department store recently one of the old-fashioned kind approached the clerk and inquired:

"How much are you asking for rubber boots today?"

Then, when he was told the price, he looked wise and queried:

"And how much are you gettin'?"

Captain: "All is lost. We cannot save the ship."

Ikey: "Do you hear what he says, Moses, the ship is going to sink?"

Moses: "Vell, let it sink. Vat do we care? Ve don't own de boat."

"I tell you," said Bill, "there is an indescribable sense of luxury in lying in bed and ringing one's bell for his valet."

"You've a valet?" asked Bill's friend.

"No," replied Bill, "but I've got a bell.—
Ex.

NEEDED GLASSES.

Bitter experience is a wonderful teacher. No doubt the young lady had often been told that she ought to wear glasses, but had neglected or refused to do so.

There was a most determined look in her eye, however, as she marched into the optician's shop.

"I want a pair of glasses immediately," she said. "Good, strong ones. I won't be without them for another day!"

"Good, strong ones?"

"Yes, please. I was out in the country yesterday, and I made a very painful blunder which I have no wish to repeat."

"Indeed! Mistook an entire stranger for an old friend, perhaps?"

"No, nothing of the sort. I mistook a bumblebee for a blackberry."—Judge.

One morning Gifford met his old friend Hall. After they had greeted each other, Gifford said:

"Say, will, I heard today that your son Thomas was an undertaker. I thought you told me he was a physician."

"Oh, no," replied Hall positively; "I never told you that!"

"I don't like to contradict you, old friend," insisted Gifford, "but really I'm positive you did say so."

"No; you probably misunderstood me," explained Hall. "I told you he followed the medical profession."—Boston Herald.

"Do you know, Bill, I nearly lost a sovereign today."

"How was that?"

"Well, you see, I went to call on a friend of my wife's, and he asked me to lend him a sovereign. 'Yes, certainly,' says I, and I brought out a sovereign, but it got no further than my hand."

"How was that?"

"Well, you see, one of his daughters commenced to sing 'Kathleen Mavourneen.'"

"Well, what has that got to do with lending a sovereign?"

"Everything, Bill, for she started like this: 'It may be for years, or it may be forever,' so I popped the guid back in my pocket."—"Tit-Bits."

Poetical Selections.

THE CRY OF THE DREAMER.

I am tired of planning and toiling
In the crowded hives of men;
Heart weary of building and spoiling,
And spoiling and building again.
And I long for the dear old river,
Where I dreamed my youth away;
For a dreamer lives forever,
And a toiler dies in a day.

I am sick of the showy seeming
Of life that is half a lie;
Of the faces lined with scheming
In the throng that hurries by.
From the sleepless thought's endeavor,
I would go where the children play;
For a dreamer lives forever,
And a thinker dies in a day.

I can feel no pride, but pity
For the burdens of mart endure;
There is nothing sweet in the city
But the patient lives of the poor.
Oh, the little hands too skillful,
And the child-mind choked with weeds!
The daughter's heart grown wilful,
And the father's heart that bleeds!

No, no! from the streets' rude bustle,
From trophies of mart and stage,
I would fly to the wood's low rustle
And the meadow's kindly page.
Let me dream as of old by the river,
And be loved for my dreams away;
For a dreamer lives forever,
And a toiler dies in a day.
—John Boyle O'Reilly.

WHAT HAVE WE DONE TODAY?

We shall do so much in the year to come,
But what have we done today?
We shall give our gold in a princely sum,
But what did we give today?
We shall lift the heart and dry the tear,
We shall plant a hope in the place of fear,
Who shall speak the words of love and cheer,
But what did we speak today?
We shall be so kind in the afterwhile,
But what have we been today?
We shall bring to each lonely life a smile,
But what did we bring today?
We shall give to truth a grander birth,
And to steadfast faith a deeper worth
We shall feed the hungry souls of earth,
But whom have we fed today?
We shall reap such joys in the by and by,
But what have we sown today?
We shall build us mansions in the sky,
But what have we built today?
'Tis sweet in idle dreams to bask,
But here and now do we do our task?
Yes, this is the thing our souls must ask:
"What have we done today?"
—Nixon Waterman.

USE WELL THY FREEDOM.

Use well the freedom which thy Master gave.
(Think'st thou that Heav'n can tolerate a slave?)
And he who made thee to be just and true
Will bless thee, love thee, ay, respect thee, too.
—Holmes.

FOOLS IS RIGHT.

Two friends were hanging on a bar and
speaking of the war
And wondering what all those guys should
shoot each other for.
"What fools those fellows are!" said one.
"What fools they are to fight!"
The other man agreed with him and an-
swered: "Fools is right!
The Kaiser sure will lose his goat—he
hasn't got a chance
To win from England, let alone from Rus-
sia and from France."
"Aw, rent a hall!" the other said. "You're
talking like a yap,
When this here war is ended France will
not be on the map."
And so they argued back and forth until
they came to blows,
And ere the barkeep stopped them they had
smashed each other's nose.
And one of them had just remarked: What
fools they are to fight!
The other had agreed with him and an-
swered: "Fools is right!"
—Geo. E. Phair.

THE JOY.

The joy is in the doing,
Not the deed that's done;
The swift and glad pursuing,
Not the goal that's won.

The joy is in the seeing,
Not in what we see,
The ecstasy of vision,
Far and clear and free!

The joy is in the singing,
Whether heard or no;
The poet's wild sweet rapture,
And song's divinest flow!

The joy is in the being—
Joy of life and breath;
Joy of a soul triumphant,
Conqueror of death!

Is there a flaw in the marble?
Sculptor, do your best;
The joy is in the endeavor—
Leave to God the rest!

—Julia C. R. Dorr.

Might we not resolve that every day
we will do at least one act of kindness?
Let us write a letter in such terms that the
post will bring pleasure next day to some
house; make a call just to let a friend know
that he has been in our heart; send a gift
on someones' birthday, marriage day or any
day we can invent. Let us make children
glad with things which they long for and
cannot obtain. And a thousand other things
which we could do within a year, if we had
eyes to see and a heart to feel and had the
will to take some trouble.—Ian Maclaren.

HUMAN PROGRESS.

All is action, all is motion,
In this mighty world of ours,
Like the current of the ocean,
Man is urged by unseen powers,

Steadily but strongly moving
Life is onward evermore;
Still the present is improving
On the age that went before.

Duty points with outstretched fingers,
Every soul to action high;
Woe betide the soul that lingers—
Onward, onward, is the cry.

Though man's form may seem victorious,
War may waste and famine blight,
Still from out the conflict glorious,
Mind comes forth with added light.

O'er the darkest night of sorrow,
From the deadliest field of strife,
Dawns a clearer, brighter morrow,
Springs a truer, nobler life.

Onward, onward, onward, ever,
Human progress none may stay;
All who make the vain endeavor
Shall, like chaff, be swept away.

—Earl D. Laraby.

TELL HIM NOW.

If with pleasure you are viewing any work
a man is doing,
If you like him or you love him tell him
now;
Don't withhold your approbation till the par-
son makes oration,
As he lies with snowy lillies o'er his brow;
For no matter how you shout it, he won't
really care about it,
He won't know how many teardrops you
have shed;
If you think some praise is due him, now's
the time to slip it to him,
For he can not read his tombstone when
he's dead!

More than fame and more than money is the
comment kind and sunny,
And the hearty, warm approval of a friend,
For it gives to live a savor, and it makes you
stronger, braver,
And it gives you heart and spirit to the
end.
If he earns your praise, bestow it; if you
like him, let him know it;
Let the words of true encouragement be
said;
Do not wait till life is over and he's under-
neath the clover,
For he can not read his tombstone when
he's dead.

—Selected.

THE MINT-BED OF VIRGINIA.

(Written for the Columbia Record.)

In the State of Old Virginia where the
peach-and-honey flows,
Where the gardens teem with verdure and
the fragrant mint plant grows,
There is sadness deep and lasting 'mong
the courtly F. F. V.'s,
For they've voted prohibition, and the pros-
pect does not please.

From the Allegheny Mountains to the sunny
"Eastern Shore,"
They will close the spirit fountains and
the booze will flow no more.
Not even in the cities can they "wink the
other eye,"
For 'tis useless when the commonwealth
has gone so very dry.

Empty will the old decanter be, with nary
drop to give
To the thirsty soul dependent on its con-
tents to revive
His Spirits sad and drooping when he feels
so "down-and-out,"
Oh, it is a doeful story; 'tis a shame be-
yond a doubt.

In the stately Old Dominion where the mint
so fragrant grew,
There'll be lack of inward comfort and the
dearth of "mountain dew."
There'll be moaning there and groaning in
the land of Cavaliers,
A pall will be upon the land, the common-
wealth in tears.

Shades of heroes long departed looking
from the other shore
Shake their heads in disapproval that the
julep is no more.
And their sympathies go out from their
long home beyond the Styx,
To the prostrate state whose people are in
such an awful fix.

They say the Old Dominion State has al-
ways set the pace,
For matchless hospitality and gentle, court-
ly grace,
Yet I fear me that she's fallen on some very
evil ways;
For "mine host" can hardly give the cheer
he gave in former days.

"What is life without the julep?" cries the
irate F. F. V.,
" 'Tis a garden void of tulip; 'tis a fruit-
less, leafless tree.
'Tis a purposeless existence; 'tis the play
with Hamlet gone.
Oh, would that I had perished ere this evil
deed was done!"

No julep in Virginia! Do I read the news
aright?
Is it possible that such should be the Old
Dominion's plight?
Is it really true that "mountain dew"
(though known by other names),
Can not be found in any town—'en "Rich-
mond on the James"?

So the mint beds of Virginia will soon have
passed away,
Though memories of their fragrance will
live for many a day.
Here's to the Old Dominion! We love her
wet or dry,
And our candid opinion is she'll stay "wet"
on the sly.

—Edward C. Elmore.

NEVER MIND THE KNOCKER.

Go ahead and make your play;
Never mind the knocker,
They're in every worker's way;
Never mind the knocker;
Every one who seeks to shine,
If successful, they malign:
'Tis of fame a certain sign—
Never mind the knocker.

If you have a task to do,
Never mind the knocker;
Have your nerve and see it through;
Never mind the knocker,
When your labor has been done,
You may know that you have won,
If the pounding is begun
Never mind the knocker.

They strike only those who climb,
Never mind the knocker.
'Tis success they deem a crime,
Never mind the knocker.
If they hammer at your name,
Then be sure you're in the game,
'Tis a species of acclaim—
Never mind the knocker.

—Selected

In Memoriam

MEMBERS.

Brothed Wade C. Gamer, Reg. No. 88097,
of Lodge 382, Childress, Texas. Died No-
vember 22, 1914, from an operation for ap-
pendicitis, age 26. Married.
Peter Hanley of Lodge 130, Butte, Mont.

RELATIVES OF MEMBERS.

Mrs. Mary McGough, mother of Wm. Mc-
Gough of Lodge 37, New Orleans, La., died
October 7, 1914, at Dayton, Ohio, age 75
years.
— Cox, father of Brothers Harvey
and Ernie Cox of Lodge 587, Beaumont,
Texas.

Lodge Notices

Dust, et al.—Lodge No. 418.

Any corresponding secretary taking up the cards of Brothers Henry Nick Dust, Reg. No. 25437 or C. F. Lannon, Reg. No. 38812, or B. G. Jenkins, Reg. No. 42728, will please hold same and correspond with 418, as all these brothers left here owing bills, and have never let their whereabouts be known.

Erratta.

In the last issue we published the name of Paul Sorgen, as having been fined and suspended by Lodge 322, for scabbing as boiler maker. Carbondale, Pa., was given as the place where he is working. This is a mistake it should have been Carbondale, Ill., which is on the I. C. System.—The Editor.

Huff—Lodge No. 360.

Will you please publish in the next Journal the following: Will Talmage Huff, Reg. No. 93506, please correspond with Lodge No. 360 at once on important business.

J. A. PEACOCK, Cor. Sec. 360.

Fitzpatrick—Lodge No. 47.

Please insert in the Journal for the information of Brother Jos. Fitzpatrick, Reg. No. 95353, who left Des Moines. The brother left Lodge 47 on June 15, 1913, and as his father is anxious to hear from him, please communicate with him or the financial secretary.

F. JOHNSON, Fin. Secy, 47.

C. P. REDDICK, C. S., L. 418.

McManus—Lodge No. 592.

Anyone knowing the whereabouts of Brother Peter McManus, Register No. 91387. He is 30 years old, 6 feet tall, has brown hair and gray eyes. Please notify the undersigned, or if you should see this please correspond with your mother.

WM. CAREY.

C. & F. S., Lodge 592.

Richardson.

Anyone knowing the whereabouts of J. J. Richardson, Reg. No. 89151, please correspond with Lodge 100.

J. P. O'NEIL, C. S., L. 100

Teague, Texas, Dec. 18, 1914.

J. D. Landuall, Register No. 87363: Will you please make some arrangement with me to pay the thirty-nine dollars and ninety-five (\$39.95) cents grocery bill you left unpaid, that I stood good for, believing in your honesty. I will be glad to get it in payments of \$10.00 per month. Remember John Cure earns his money working at the same trade you do. Hoping your manhood will step forward, I am,

Respectfully,

MRS. JOHN CURE.

Swain—Lodge No. 567.

Any secretary taking up the card of Brother T. D. Swain, No. 38826, will please hold same and notify corresponding secretary of Lodge No. 567, as this brother left here owing a note of \$75.00 with one of his brothers securing it and he had to pay it off and he has never paid one cent on it.

To all boiler makers coming this way, please have a paid up card as we have got a new agreement here and everything will be all O. K.

R. L. WHITE, C. S. 567.

Robertson—Lodge No. 173.

Any secretary knowing the whereabouts of Brothers H. E. or Earnest Robertson will please correspond with the secretary of Lodge 173, as the brothers borrowed money which they failed to make good, and also left his due book in "Hock."

J. P. TAYLOR, Secy, 173

NOTICE, TEXAS UNIONS.

Want address of Frank Farley, boiler maker, recently from Mexico, to clear land title. J. M. Daniel, Laredo, Texas.

Lost and Found

Lost Due Book—Senn.

Due book of John Senn, Reg. No. 56050, was lost or stolen on train in Clinton, S. C., on October 15. Anyone finding same please return to E. S. Ryan, Sec. L. No. 20

Lost Due Book—Reynolds.

Due book of James Reynolds, Reg. No. 49061, was lost at Calgary, Alberta, Can. Finder will please forward to A. Doornbos, C. S., L. 596, Casper, Wyo.

Lost Due Book—Hoag.

Lost due book of F. D. Hoag, Reg. No. 33842. Finder please return to Secretary Lodge 267.

F. R. LEE.

Found Due Book—Desenger.

Found at Casey, Ill.—Due book and card of Brother L. F. Desenger. Said book was issued by Lodge 25. The brother may have same by proving his claim.

F. P. REINEMEYER, I. S.-T.

Found Due Book—Jones.

Found at Danville, Ill., due book of Brother Frank Jones. Said book was issued by Lodge 447. The brother may have same by proving claim.

F. P. REINEMEYER, I. S.-T.

LIST OF MEMBERS PREVIOUSLY ADVERTISED.

H. Czatlenski, Reg. No. 64922, by Lodge 32 for non-payment of room rent. Earl Bennett, Reg. No. 75435, wanted by Lodge 100 for non-payment of bills amounting to \$67.65.

OFFICIAL ROSTER—International Officers

J. A. FRANKLIN.....International President
Room 15, Law Bldg., 721 Minnesota Ave., Kansas City, Kas.

F. P. REINEMEYER.....Int. Secretary-Treasurer
Rooms 10 to 12 Law Bldg., 721 Minnesota Ave., Kansas City, Kas.

JAMES B. CASEY.....Editor-Manager of Journal
Room 9, Law Bldg., Kansas City, Kas.

A. HINEMAN.....First Int. Vice-President
Room 15, Law Bldg., 721 Minnesota Ave., Kansas City, Kas.

MISSOURI AND MISSISSIPPI DISTRICT †
States of Iowa, Missouri, Kansas, Nebraska, Arkansas, Mississippi, Alabama (other than Mobile), Tennessee, North and South Dakota, Oklahoma and Minnesota.

THOS. NOLAN.....Second Int. Vice-President
700 Court St., Portsmouth, Va.

GULF AND SOUTH ATLANTIC DISTRICT
States of Texas, Louisiana, Florida, Georgia, North and South Carolina, Virginia, Maryland and Delaware, and Mobile, Ala.

J. P. MERRIGAN.....Third Int. Vice-President
91 Manufacturer St., Montreal, Que., Can.
CANADIAN DISTRICT
The Dominion of Canada.

LOUIS WEYAND.....Fourth Int. Vice-President
6201 Fir Avenue, N. W., Cleveland, Ohio.
GREAT LAKES AND TERRITORY DISTRICT
States of Wisconsin, Michigan, Cities of Chicago, Toledo, Cleveland and Lorain, O., Erie, Pa., State of New York (other than the City of New York).

WM. ATKINSON.....Fifth Int. Vice-President
212 South Pittsburg St., Spokane, Wash.
ROCKY MOUNTAIN AND PACIFIC COAST DISTRICT

Honolulu, States of California, Oregon, Washington, Idaho, Utah, Nevada, Montana, Wyoming, Colorado, Arizona, Old Mexico, New Mexico and Canal Zone, Panama.

JOHN J. DOWD.....Sixth Int. Vice-President
Home address, 168 Wilkinson Ave., Jersey City, N. J.

EASTERN SEABOARD DISTRICT
States of Maine, New Hampshire, Vermont, Massachusetts, Rhode Island, Connecticut, New Jersey and New York City.

M. A. MAHER.....Seventh Int. Vice-President
1401 Center St., Portsmouth, Ohio.

OHIO VALLEY AND TERRITORY DISTRICT
States of Pennsylvania (other than the city of Erie), Ohio, West Virginia, Kentucky, Indiana and Illinois (other than the City of Chicago).

JOS. P. RYAN.....Eighth Int. Vice-President
5830 Wentworth Ave., Chicago, Ill.
Phone Wentworth 8739.

HELPERS' VICE-PRESIDENT OF WESTERN DIVISION
All states west of dividing line between Indiana and Ohio

JOHN F. SCHMITT.....Ninth Int. Vice-President
1489 N. Fourth St., Columbus, Ohio.

HELPERS' VICE-PRESIDENT OF EASTERN DIVISION
All states east of dividing line between Indiana and Ohio.

District Lodges and Officers

DISTRICT No. 2—New York
N. Y. Meets 1st and 3rd Wed.
Patrick T. Kenneally, President, 9 Magnolia Ave., Jersey City, N. J.

Harry L. Davis, Vice-President, 351 5th Ave., Brooklyn, N. Y.
Daniel J. Markham, Sec.-Treas., 196 Schermerhorn St., Brooklyn, N. Y.

E. J. McCarthy, B. A., 201 Williams St., New York City.

DISTRICT No. 5—St. Louis, Mo.
Mo. Pac. and Iron Mountain R. E. Lodges represented: 32, 38, 44, 66, 82, 106, 113, 117, 286, 322, 402, 507, 521, 542, 543, 565, 583 and 599.

John C. Morrow, Pres., 613 W. 4th St., Coffeyville, Kans.
Hal Stack, Vice-Pres., Van Buren, Ark.

John J. Murphy, Secy., 3404 Eads Ave., St. Louis, Mo.

J. N. Shirley, Treas., Box 495, Hoisington, Kans.
A. E. Stewart, Member Ex. Board, 2533 Myrtle Ave., Kansas City, Mo.

A. J. Radford, Member Ex. Board, 624 Oak St., Little Rock, Ark.
Chas. A. McDonald, B. A., 4414 Winoor St., Kansas City, Mo.

DISTRICT No. 6—Southern Pacific R.R. Lodges represented: 32, 33, 46, 48, 52, 74, 92, 49, 98, 101, 113, 179, 193, 206, 216, 223, 239, 252, 309, 345, 339, 538, 553, 189.

J. J. Jones, Pres. and C. S., 1630 New Hampshire Ave., Los Angeles, Cal.
J. C. Carroll, V.-P., North Platte, Neb.

S. T. Feaselle, Sec.-Treas., Gate City Hotel, Pocatello, Idaho.

DISTRICT No. 10—Davenport, Ia.
Rock Island System. Lodges represented: 377, 144, 246, 199, 240, 293, 223, 424, 429, 491, 96, 32, 66, 476, 522, 523.

Geo. W. Pring, Pres. & B. A., 677 28th St., Des Moines, Ia.

John Mitchell, V.-P., 1502 McGowan St., Little Rock, Ark.
S. T. Sample, C. & F. S., 515 N. Jackson St., Pratt, Kas.
J. J. Lynch, Treas., Box 655, Herington, Kas.

DISTRICT No. 12—New York
New York Central System. Lodges represented: 5, 7, 10, 64, 67, 85, 150, 157, 169, 175, 197, 218, 223, 229, 321, 413, 492.

A. M. Anderson, Pres., 2208 Franots St., Jackson, Mich.
G. H. Gates, Vice-Pres., 148 N. Orchard St., Watertown, N. Y.
J. J. Leamy, Sec.-Treas., 68 Livingston Ave., Albany, N. Y.
Trustees—Wm. Weber, E. J. McNamara and Thomas Ranger.

DISTRICT No. 13—Birmingham, Ala.
Southern R. R. System. Organized Feb. 23, 1904. Lodges represented: 2, 4, 12, 14, 40, 50, 28, 105, 143, 170, 226, 235, 312, 320 334 344, 369, 419, 511, 524; H. D., 27, 111, 175, 240.

Thos. J. Garvey, Pres., 414 E. Byrd St., Richmond, Va.
A. E. Barksdale, V.-P., 543 E. Lafayette St., Jackson, Tenn.
P. E. Berney, Sec.-Treas., R. F. D. 12, Knoxville, Tenn.

DISTRICT No. 15—Chicago, Ill.
C. & N. W. R. R. Lodges represented: 38, 60, 129, 145, 161, 201, 227, 311, 395, 440, 485, 496, 539, 597.

W. F. Scholes, Pres., 1929 Ave., B. Council Bluffs, Ia.
J. W. Francis, V.-P., 534 Springfield Ave., Chicago, Ill.

T. E. Burdette, Sec.-Treas., 428 North Chesnut Ave., Green Bay, Wis.

DISTRICT No. 19—Roanoke, Va.
Norfolk & Western System. Lodges represented: 28, 402, 50, 405, 557. Meets Union Labor Hall.

C. D. Craft, Pres., 1402 Center St., Portsmouth, O.
M. F. Glenn, V.-P., 1414 McConnell Ave., Portsmouth, Ohio.

J. B. O'Brien, Treas., Roanoke, Va.

E. J. Horgan, C. & F. S., 404 7th Ave., S. E., Roanoke, Va.

DISTRICT No. 20—Ill. Cent. R.
R. Headquarters, Chicago, Ill. Lodges represented: 56, 83, 133, 137, 40, 224, 426, 180, 230, 234, 300, 315, 363, 399, 95; H. D., 97, 106, 116, 102, 230, 174, 232, 223.

K. H. Eicker, Pres., 315 Dane St., Waterloo, Ia.
W. T. McCoid, V. P., 412 Madison St., Clinton, Ill.

E. G. Pullen, C. S. & Treas., 303 Columbia St., Waterloo, Ia.

DISTRICT No. 22—D. R. G. System
Colorado and Utah. Meeting place, Denver, Colorado; Date meeting, 2d Monday in July, 1915; Lodges represented: 44, 103, 179, 335, 427, 448, 473.

Geo. S. Warden, Pres., & B. A. 1507 E. 7th St., Pueblo, Colo.
H. F. Jones, Vice-Pres., 135 Sackett Ave., Salida, Colo.

A. A. Duncan, Sec.-Treas., Box 611, Alamosa, Colo.

DISTRICT No. 23—Meets at St. Louis, Mo., 2d Monday in October, 1914.
Lodges represented: 4, 22, 27, 70, 95, 98, 130, 286, 418, 449, 458, 530, 581, 542, 546, 565, 575.

A. F. Bingham, Pres. and B. A., 701 Lombart St., Springfield, Mo.
L. W. Lawson, V.-P., 821 N. Maxey St., Sherman, Texas.

J. W. Reddick, Financial and Recording Secretary, 817 Lincoln St., Springfield, Mo.

A. A. Denton, Cor. Sec. and Treas., 1044 W. Mt. Vernon St., Springfield, Mo.

DISTRICT No. 24—Springfield, Ill.
Advisory Board Wabash System. Lodges represented: 54, 81, 267, 384, 447, 581.

E. R. Lee, Pres., 324 Taylor St., Moberly, Mo.
James Gray, V.-P., L. No. 447.

Gus L. Kloes, Sec., Box 215, Montpelier, Ohio.

DISTRICT No. 25—Livingston, Mont.
Northern Pac. R. R. J. G. Brown, Pres., 610 N. 2nd St., Missoula, Mont.
Frank Depender, V.-P., 735 E. Nora Ave., Spokane, Wash.
Thos. W. Everett, Sec.-Treas., P. O. Box 554, Livingston, Mont.

Trustees—A. H. Shanks, 221 N. 2nd St., Missoula, Mont.; Hugh Roberts, Gen. Del., Glendive, Mont.; G. M. Owens, 312 So. E. St., Livingston, Mont.

DISTRICT No. 26—Aberden, S. D. C. M. & St. P. and Puget Sound R. Ra. Lodges represented: 11, 15, 32, 38, 41, 104, 244, 302, 485, 520, 528, 568, 588, 595, 603, 606. G. H. Hawksworth, Pres., Box 817, Deer Lodge, Mont.

F. J. O'Brien, Vice-Pres., Avery, Idaho.
Ed. McSkinnitt, Secy., Miles City, Mont.

P. W. Gunn, Treas., 3316-30 Ave., South, Minneapolis, Minn.
J. L. Callahan, B. A., 3106 Clifton St., Milwaukee, Wis.

DISTRICT No. 27—Int. G. N. R. R. W. O. Faulk, Pres., Palestine, Tex.

W. K. Saddler, Vice-Pres., Mart, Texas.
E. H. Frick, Sec.-Treas., San Antonio, Tex.

W. B. Graham, B. A., Palestine, Tex.

DISTRICT No. 30—Canadian Pacific. District Headquarters, Winnipeg, Man. Lodges in affiliation: 126, 134, 194, 379, 392, 451, 466, 478, 506, 529, 548, 417. Geo. F. Chadburn, Pres. and Acting Sec.-Treas., 1585 Alexander St., Winnipeg, Man.

J. E. Smith, V.-P., 162 Annette St., Toronto, Ont.
R. Carswell, V.-P., 684 Home St., Winnipeg, Man.

DISTRICT No. 31—Cincinnati, O. B. & O. System. Lodges represented: 5, 10, 79, 99, 105, 135, 241, 259, 318, 326, 332, 444, 493, 498, 514, 579, 578.

H. D. Horchler, Pres., 717 Blane St., Newcastle, Pa.
John Sweeney, B. A., 3339 N. 5th St., Philadelphia, Pa.

John P. Mangen, Sec.-Treas., 612 S. W. 1st, Washington, Ind.

DISTRICT No. 32—Grand Rapids, Mich., Pere Marquette System. Lodges represented: 34, 124, 413.

DISTRICT No. 34—Boston, Mass. Boston & Maine System. Lodges represented: 245, 371, 388, 481, 515, 517. Meets at Boston, Mass., 1st Monday in August and 2d Monday in February.

W. H. Wells, Pres., 103 Westford St., Lowell, Mass.
P. J. Kelley, Vice-Pres., 3 Devon St., Greenfield, Mass.
T. J. Donahue, Sec.-Treas., 5 Fernald St., Lowell, Mass.

DISTRICT No. 35—Parsons, Kas. M., K. & T. R. R. System. Lodges represented: 292, 209, 501, 576 and 265.

Fred Aldorf, Pres. & B. A., 515 W. Owings St., Denison, Tex.
C. Dudding, V.-Pres., 2229 Crawford St., Parsons, Kas.

Robt. Rosbottom, Sec.-Treas., 600 W. Texas St., Denison, Tex.
C. A. Denton, Rec. Sec., Parsons, Kas.

Wm. Dickerson, Chairman Trustees, 810 Cleveland St., Waco, Tex.

DISTRICT No. 37—Texarkana, Tex. Cotton Belt R. R. System. Meets 3d Saturdays in January and July.

R. M. Cummins, Pres. & B. A., 308 E. Valentine St., Tyler, Tex.
John A. Smith, V.-P., 1908 E. 8th St., Pine Bluff, Ark.

O. E. Shields, Sec.-Treas., 1503 E. 7th Ave., Pine Bluff, Ark.

DISTRICT No. 38—Atlantic Coast Line. Lodges represented: 20, 26, 239, 422, 425, 448, 570.

A. J. Dixon, Pres., Rocky Mount, N. C.
W. A. Cahill, Vice-Pres., Montgomery, Ala.

E. S. Ryan, Sec.-Treas., 508 Lackawana Ave., Jacksonville, Fla.

DISTRICT No. 39—Central of Georgia System. Meets 1st Friday after Thanksgiving each year at Columbus, Ga. Lodges represented: 4, 12, 26, 436, 510.

R. J. Black, Pres., 913 2nd St., Macon, Ga.
J. J. Dean, Vice-Pres., 226 Taylor St., Savannah, Ga.

Chas. A. Buchheil, Sec.-Treas., 103 Gordon W., Savannah, Ga.
E. M. Kendrick, Rec. Sec., Route 5, Cedartown, Ga.

R. S. Barry, Cor. and Fin. Sec., 1109 5th Ave., Columbus, Ga.

DISTRICT No. 40—Hamlet, N. C. Seaboard Airline and leased lines. Lodges represented: 2, 20, 26, 298.

E. M. Jewell, Sec.-Treas., 421½ Forest St., Jacksonville, Fla.

DISTRICT No. 41—Hinton, W. Va. Chesapeake & Ohio System. Lodges represented: 170, 238, 249, 384, 384, 525.

David W. Morris, Pres., Forest Park, Peru, Ind.
R. L. King, V.-Pres., 807 N. 24th St., Richmond, Va.

C. L. Barnett, Sec.-Treas., 207 2d Ave., Hinton, W. Va.

Trustees—M. L. Steinbuck, Box 336, Clifton Forge, Va. D. C. Dowdy, 2048 7th Ave., Huntington, W. Va. John J. Fielding, 1389 Scott St., Covington, Ky.

DISTRICT No. 42—Danville, Ill. Chicago & Eastern Illinois R. R. Meets 1st Tues. in Feb., 1916.

Lodges represented: 22, 95, 575. G. D. Davis, Pres. and B. A., 18 N. Hazel St., Danville, Ill.
James B. Keenan, V.-P., 1006 E. Madison St., Danville, Ill.

Oliver Henthorn, R. & F. S., 102 Iowa St., Danville, Ill.
A. Welch, Cor. Sec. & Treas., Villa Grove, Ill.

Subordinate Lodges and Officers

1—CHICAGO, ILL. 2d-4th Wed., Bricklayers' Hall, Monroe and Peoria Sts.

James McKiernan, Pres.
John E. Burke, C. & F. S., 3009 Archer Ave.
John Dohney, 8123 So. Peoria.
Frank Condon, B. A., 912 Monroe.

2—ATLANTA, GA. 2d-4th Thurs. A. D. Lundbon, Pres., 224 E. Fair.
John Fitcher, C. S., 406 Pullman.

3—ST. PAUL, MINN. 2d-4th Fri., Odd Fellows' Hall, 5th and Wabash Sts.

Pat Walsh, Pres., 849 Western.
W. Parranto, C. S., 400 Jenks St.

4—BIRMINGHAM, ALA. Each Tues., K. of C. Hall.
G. F. Williams, Pres., 2708 Alabama Ave.

A. L. Carmack, F. S. & B. A., Office: 335 Hood Bldg.

5—CLEVELAND, OHIO. 1st-3d Thurs., Room 3, Federation Hall, 310 Prospect.

John Spears, Pres., 1065 E. 69th.
G. H. Brady, C. S. & B. A., 1182 E. 113th St.

6—COLUMBUS, O. Meets 2d-4th Thurs., F. of L. Hall.
Chas. L. Nicklaus, Pres., 473 Poplar Ave.

Fred Dennis, C. S. 628 Mt. Vernon Ave.

10—INDIANAPOLIS, IND. 2d-4th Thurs., 114 N. Delaware.

E. P. Leopard, Pres., 206 N. Fremont Ave.
Wm. Frohlinger, C. S., 542 East Louisiana St.

11—MINNEAPOLIS, MINN. 2d-4th Mon., Richmond Hall, 223 5th St.

Joseph Kovhummel, Pres., 89 Summit Ave., St. Paul, Minn.
E. A. Conlin, C. S., 2404 Bloomington Ave.

12—MACON, GA. 2d-4th Friday, Lackey's Hall.

I. E. Hall, Pres., 459 Elm.
Thomas Gilbert, C. & F. S., 2838 Houston Ave.

14—CHATTANOOGA, TENN. Central Labor Hall, 8th and Cherry Sts., 2d-4th Mon.

Sam Hartman, Pres., North Chattanooga, Tenn.
J. F. Anderson, Secy-Treas., 505 Read Ave.

15—DUBUQUE, IOWA. 1st-3d Tues., Union Hall, 19th and White Sts.

C. W. Cooper, Pres., 541 Garfield Ave.

P. Ruof, C. & F. S., 975 Clay St.

16—JERSEY CITY, N. J. 1st-3d Mon., Fischer's Hall, Newark Ave., cor. Erie St.

Patrick J. Keeneally, Pres., 209 Magnolia Ave.
Hugh Fitzpatrick, C. S., 244 York.

Ed. McCarthy, B. A.

19—PHILADELPHIA, PA. 2d-4th Fridays, Bricklayers' Hall, Broad and Fairmount Ave.

Frank Goodfellow, Pres., 159 W. Palmer St.
George Higgs, C. S., 2024 Bouvier

20—JACKSONVILLE, FLA. Meets every Monday, Central Labor Hall, 46½ W. Bay.

C. A. Clarke, Pres.
E. S. Ryan, C. & F. S., 508 Lackawana Ave.

21—NEW YORK, N. Y. 2d-4th Tuesdays.

John J. Lynch, Pres., 322 10th Ave.

Dan Ward, C. S., 444 W. 19th St.

22—DANVILLE, ILL. 1st-3d Tues., Brewery Workers' Hall, East Main St.

W. E. Flynn, Pres., 4 Nicholas St.
Henry C. Poll, C. S., 414 Kimbel.

Geo. Davis, B. A.

25—SAN FRANCISCO, CALIF. Roesch Hall, 15th and Mission Sts., 2d-4th Thurs.

John Kane, Pres., 41 Collingwood.

Thos. J. Sheridan, C. S. & Treas., 2312 24th St.

Wm. P. Bowser, B. A., 314 14th.

26—SAVANNAH, GA. 2d-4th Tues., Board of Trade Bldg.

J. P. Masey, Pres.
R. B. Allen, C. S., 509 E. 32d St.

27—ST. LOUIS, MO.

29—ROANOKE, VA. 2d-4th Wed., Labor Home Hall, Commerce and Salem Ave.
G. J. Lucas, Pres., 1121 2d Ave. N. W.

J. F. Murray, C. S., 1023 3d Ave. N. W.

30—ROANOKE, VA. 2d-4th Mon., Labor Hall, cor. Commerce St. and Salem Ave.
C. E. Eades, Pres., 318 7th Ave. N. E.
B. I. Wade, C. S., 811 Jamison Ave.

- 31—**ST. JOSEPH, MO.** 2d-4th Mon., Jucker Hall.
B. E. Stitts, Pres., 2228 So. 6th.
Edward Knight, C. S., 2119 So. 9th St.
- 32—**KANSAS CITY, MO.** 2d-4th Fri., Labor Temple, 14th and Woodland.
Thomas Mulvihill, Pres., 3715 Springfield St., Rosedale, Kas.
W. E. Dwyer, C. & F. S., 4402 Windsor.
- 37—**NEW ORLEANS LA.** 2d-4th Wed., Martin's Hall, Iberville and Exchange Place.
Louis Mason, Pres., 116 S. Touff.
Lewis J. Costella, C. S., 636 N. Olympia.
James Curry, B. A., 560 Washington Ave.
- 38—**OMAHA, NEB.** 1st-3d Wed., Bairright Hall, 19th & Farnum.
M. J. McGovern, Pres., 1617 Burt.
L. G. Rankin, C. S., 2825 Cass.
J. H. Massman, F. C., 1511 Locust.
- 39—**SOUTH CHICAGO, ILL.** 2d-4th Tues., Union Headquarters, 92d St. and Erie Ave., South Chicago.
Frank Bacton, Pres., 10149 Ave. J.
John Cogan, C. S. & B. A., 9944 Ave. H.
- 40—**LOUISVILLE, KY.** 2d-4th Wed., in Beck's Union Hall, 1st and Jefferson Sts.
Thomas Mitchell, Pres., 1422A Broadway.
- R. Terrell, C. S., 308 N. 19th St.
- 41—**HARLOWTON, MONT.** 2d-4th Thurs., Winer Hall.
M. J. Griffin, Pres.
R. W. Jones, C. & F. S., Box 523.
- 42—**NASHVILLE, TENN.** 2d-4th Thurs., Carpenters' Hall, 342½ 4th Ave. N.
James B. Keenan, 1006 E. Madison St., Danville, Ill.
H. R. Brown, Pres., 611½ Church.
W. T. Pentecost, C. S., 2143 Oakland Ave.
- 44—**PUEBLO, COL.** Every Thurs., Carpenters' Hall, So. Union Ave.
A. E. Jacobs, Pres., 933 E. Evans Ave.
- Almon Treesh, C. S., 188 Union Av.
- 45—**BROOKLYN, N. Y.** Greenpoint and Manhattan Aves., 2d-4th Thurs.
Gerald A. Daly, Pres. & C. S., 676 60th St.
M. J. Callahan, F. S., 204 Nassau Ave.
- 46—**CHEYENNE, WYO.** Union Hall, 2d-4th Wed.
Geo. R. Wallace, Pres., P. O. Box 151.
E. Cole, C. S., 215 E. 9th St.
- 47—**DES MOINES, IA.** 1st-3d Thurs., Trades Assembly Hall.
James Gillespie, Pres., 1113 Columbus Ave.
Fritz Johnson, C. & F. S., 922 W. 1st St.
- 48—**LARAMIE, WYO.** 1st-3d Tues., Moose Hall.
Jacob Claus, Pres., 114 Cedar St.
Frank M. Lepper, C. S., 360 N. 3d St.
- 50—**CHARLESTON, S. C.** 1st-3d Tues., Y. M. C. A. Hall, George St.
H. J. Hartnett, Pres., 18 Anson St.
John J. Clair, C. & F. S., 196A Spring St.
- 51—**ST. LOUIS, MO.** 2d-4th Wed., Lafayette Hall, 17th and Cass Ave.
Wm. Hass, Pres., 1846A Cass Ave.
M. J. Gleason, B. A., Office 1101 Cass Ave.
Harry Lueper, C. S., 3234 Itaska.
- 54—**FOOT WAYNE, IND.** Last Wed., West Berry St.
Edward F. Siebold, Pres. & C. S., 1130 St. Mary's Ave.
O. P. Ewald, F. S., 1419 S. Calhoun.
- 55—**NEWPORT NEWS, VA.** Every Wed., 8 p. m., C. L. U. Hall, 33d and Wash. Ave.
- Wm. H. Healy, Pres. & B. A., 3711 Thoa. J. Richards, C. S., P. O. Box 430.
- 56—**VICKSBURG, MISS.** 1st-3d Tues., K. of P. Hall, N. Washington St.
Ed. Snelling, Pres., 3127 Washington St.
W. C. Hughes, C. & F. S., 2312 Mulberry.
- 57—**PORTSMOUTH, VA.** 1st-3d Thurs., C. L. U. Hall.
Elmer Johnkin, Pres.
Geo. Thomas, C. S., 304 Lincoln.
- 60—**PEORIA, ILL.** 1st-3d Mon., 411 Cedar St.
Andy Yates, Pres., 1709 S. Adams.
F. Hierspiel, C. S., 410 Warner Ave.
- 61—**NEW HAVEN, CONN.** 1st-3d Thurs., Boardman Bldg., cor. State and Chapel Sts.
Eric R. Swan, Pres., 192 Clinton Ave.
M. J. Whalen, C. S., 138 Carlisle.
- 64—**JACKSON, MICH.** Every Tues., Labor Hall, Main and Jackson Sts.
Geo. Bones, Pres., 140 Bates.
Ed. McNamara, C. S., 619 South Pleasant St.
- 65—**VICTORIA, VA.** 2d-4th Sundays, Lumburg Hall.
J. H. Jones, Pres. & Treas., Gen. Del.
F. C. Kimmerling, Vice-Pres., Gen. Del.
H. S. Bacon, Rec. Sec., Gen. Del.
E. M. Widdle, C. & F. S., Gen. Del.
- 66—**LITTLE ROCK, ARK.** 1st-3d Thurs., Moose Hall.
Thomas Norton, Pres., 1009 Markham St.
E. Wortsmith, C. & F. S., 300 W. 11th St., Argenta, Ark.
Chas. A. McDonald, B. A., 4414 Windsor, Kansas City, Mo.
- 67—**BAY CITY, MICH.** 1st-3d Thurs., Central Trades Council Hall.
Wm. H. Benedict, Pres., 703 E. Winona Ave., W. S.
Joe Malton, V.-P., 317 S. Jackson.
Nelson Heglung, C. & F. S., 514 Adams St.
- 68—**PINE BLUFF, ARK.**—2d-4th Wed., Labor Temple.
A. J. Barton, Pres., 1701 W. 6th.
B. E. Shields, F. S., 1503 E. 7th.
J. A. Smith, C. S., 1908 E. 8th.
- 70—**SPRINGFIELD, MO.** 2d-4th Wed., Eagles' Hall, E. Commercial St.
R. A. Lines, Pres., 816 W. Atlantic St.
Scott Daffer, C. & F. S., 987 Broad St.
A. F. Bingham, B. A., 701 Lombard St.
- 72—**PORTLAND, ORE.** 2d-4th Thurs., Cor. 2d and Yamhill Sts.
Frank Poehler, Pres., 654 E. 25th.
F. E. Disbrow, C. & F. S., 810 E. 11th.
Joe Reed, B. A., 742 E. 8th.
- 73—**TROY, N. Y.** 2d-4th Mon., Swan and Georgia Sts., Mechanics' Hall.
Huntington Ave.
A. C. Lacy, C. S., 552 27th St.
James Keating, Pres.
David Boyd, C. S., 319 9th St., Watervliet.
- 74—**HOUSTON, TEXAS.** 1st-3d Wed., Woodman Hall, 1823 Washington St.
D. C. Bryan, Pres., 4607 Washington.
F. C. Jackson, C. & F. S., 2118 Lubbeck St.
- 79—**GARRETT, IND.** 1st-3d Tues., K. of P. Hall, Randolph.
C. W. Frances, Pres.
J. C. Smith, C. & F. S., Box 282.
- 80—**ANACONDA, MONT.** 2d-4th Wed., M. & M. Hall, Lodge Box 372.
J. C. Smith, Pres., 510 Cherry St.
James W. Hogan, C. S., 800 Birch.
- 81—**SPRINGFIELD, ILL.** 2d-4th Tues., Fortunes Hall.
Ed Sellers, Pres., 1628 S. 7th.
Louis L. Mutter, C. S. & B. A., 1621 S. 8th.
- 82—**OSAWATOMIE, KAS.** 1st-3d Mon., K. & L. Sec. Hall.
M. P. Churchill, Pres.
J. E. Sturgean, C. & F. S., Box 64.
- 83—**KANSAS CITY, KAS.** 2d-4th Tues., K. P. Hall, 624 Minn. Av.
Thomas Knowles, Pres., 760 Shawnee.
Frank Stover, C. & F. S., 322 Nebraska Ave.
- 84—**GRAND RAPIDS, MICH.** 1st-2d Mon., Trade & Labor Hall, 67 Monroe Ave.
Frank C. Lemke, Pres., 551 Shamrock St.
Nelson M. Warren, C. S., 127 E. Delaware St.
- 85—**TOLEDO, OHIO.** 2d-4th Tues., Mitchell's Hall, cor. Walnut and Summit Sts.
J. S. Durst, Pres., 153 Gibbons St.
Ellsworth Richardson, C. S., 1137 Western St.
- 86—**DALLAS, TEX.** 1st-3d Mon., Broadnax Hall.
W. H. Riley, Pres., 1408 Corinth.
P. B. Foote, Cor. Sec., 2817 Howell St.
- 88—**JACKSON TENN.** 2d-4th Fri., Labor Hall.
B. B. Seward, Pres.
A. E. Barkdale, C. S., 119 E. Orleans St.
- 90—**SUGAR CREEK, MO.** 2d-4th Thurs., Woodman's Hall.
Wm. H. Reese, Pres., Independence, Mo.
Matt Delles, C. & F. S. Box 4.
- 91—**ELMWOOD PLACE O.** 1st-3d Mon., Kellers Hall.
Geo. Urban, Pres., St. Bernard.
O. John Cullen, C. S., 39 Prosser Ave.
- 92—**LOS ANGELES, CAL.** 2d-4th Wed., Union Labor Temple, 540 Maple Ave.
Charles Clarke, Pres., 206 S. Workman St.
H. E. Herman, C. & F. S., 520 S. Griffin Ave.
- 93—**JOLIET, ILL.** 1st-3d Tues., Conner's Hall.
Charles Brown, Pres., Gen. Del., Lockport, Ill.
Charles Mork, C. S., 424 Landen Ave.
- 94—**SACRAMENTO, CAL.** 1st-3d Thurs., Labor Temple.
J. Grabfelder, Pres., 3001 G St.
J. G. Heller, Acting C. S., 1317 19th St.
- 95—**EVANSVILLE, IND.** 3d-4th Mon., Ruhl's Hall.
Frank Hahn, Pres., 1319 Law Ave.
Herman H. Grundman, C. S., 807 Mary St.
- 96—**FORT WORTH, TEX.** B. of L. F. & E. Hall, 1st-3d Thurs.
Geo. E. Challor, Pres., 951 Jefferson Ave.
L. A. Freeman, C. & F. S., 2250 Jennings St.
- 99—**NEWARK, OHIO.** Druid's Hall, S. 3d St., 1st-3d Sun.
Cecil C. Roberts, C. S., 45½ S. Third St.
- 100—**MARSHALL, TEX.** 1st-3d Tues., I. O. O. F. Hall.
John D. Young, Pres., 206 Park Ave.
J. P. O'Neil, C. S., 708 E. Rusk.
- 103—**SALT LAKE CITY, UTAH.** Labor Temple, 3d East, bet. 1st and 2d S. St., 1st-3d Wed.
Ernest L. Wilcox, Pres., 520 Mortenson Court.
B. S. R. Harrison, C. & F. S., 862 Ouray Ave.
- 104—**SEATTLE, WASH.** 1st-3d Thurs., Labor Temple, 6th and University St.
Wm. G. Cooper, Pres., 1820 Jackson St.
Dan McKillop, C. & F. S., 166½ 10th Ave.

- 105—CINCINNATI, OHIO. 2d-4th Tues., Workman's Hall, Mercer and Walnut Sts.
Chas. Graeger, Pres., 329 Union St., Bellevue, Ky.
D. L. O'Brien, C. S. & B. A., 28 Forest Ave., Ludlow, Ky.
- 106—MCGHEE, ARK. 2d-4th Wed., K. of P. Hall.
Wm. E. Crupper, Pres., Box 215.
Chas. A. Stewart, C. & F. S., Gen. Del.
- 107—MILWAUKEE, WIS. 1st-3d Tues., Speers Hall, Cor. National & 3d Ave.
J. Hoppens, Pres., 1302 Fratney.
R. Dale, Fin. Sec., 319 4th Ave.
P. Sonnenberg, C. S. & B. A., 623 Greenbush.
- 108—AUGUSTA, GA. 2d-4th Tues., Machinists' Hall, Broad.
Patrick Rice, Pres. & C. S., 1342 Walton way.
- 109—CHADRON, NEB.
J. W. Boyd, Pres.
John Paulson, C. & F. S.
- 111—MISSOULA, MONT. 2d-4th Tues., Eagles' Hall.
Hiram Watson, Pres., 122 N. 2d.
A. H. Shanks, C. S., 221 N. 2d.
- 113—SEDALIA, MO. 1st-3d Tues., Labor Temple.
J. C. White, Pres., 817 E. 5th St.
W. H. Sims, C. S., 1306 E. 7th St.
- 116—BRAINERD, MINN. 2d-4th Fri.
J. L. Ellis, Pres.
L. A. Rifsenrath, C. S., Mahlum Block.
- 117—DE SOTO, MO. 1st-3d Mon., Union Labor Hall.
G. J. Devlin, Pres.
H. J. Brummer, C. & F. S., Box 395.
- 118—NORTH PLATTE, NEB. 4th Sat., K. of P. Hall.
John Seth, Pres.
Peter McGovern, C. S., 511 Locust.
- 123—LIVINGSTON, MONT. 1st-3d Fri., Odd Fellows' Hall.
C. J. Maes, Pres., 201 S. I. St.
Theo. W. Everts, C. S., P. O. Box 554.
- 124—SAGINAW, MICH. 1st-3d Fri., Petre & Meek's Hall, Genesee Ave.
John Doyle, C. & F. S., R. F. D. No. 1.
- 126—WINNIPEG, MAN. 1st Wed. and 2d Sun., 2 o'clock, Labor Temple.
Charles Davies, Pres., 514 Atlantic Ave.
A. E. Page, C. S., 1380 Elgin Ave.
- 129—CLINTON, IOWA.
H. Qualman, C. S., 231 14th Ave.
- 130—BUTTE, MONT. 1st-3d Tues., Carpenters' Hall, cor. Granite and Montana Sts.
G. C. Wright, Pres., 1007 S. Arizona St.
W. H. Goodland, C. S., 177 E. Center.
- 132—GALVESTON, TEX. 2d Mon., Cooks and Waiters' Hall, 23d St.
M. M. Hart, Pres., 911 33d St.
E. T. Chester, C. & F. S., 3209 Ave. I.
- 133—WATERLOO, IOWA. Central Labor Hall, 2d-4th Wed.
E. G. Pullen, Pres., 502 Columbia St.
Geo. A. McMillan, C. S., 702 Barclay St.
- 134—MONTREAL, QUE., CAN. 1st-3d Fri., Monument National St. Lawrence and Main Sts.
Stephen Craig, Pres., 1251 Mossier.
R. Chorlton, C. S., 1184 Delormier Ave.
- 135—CHILLICOTHE, O. 1st-3d Mon., Flaacker Hall.
Edward Carroll, Pres., 739 Adams Ave.
James Hunsinger, C. & F. S., 390 E. 4th St.
- 136—COLORADO CITY, COLO. Red Men's Hall, 1st-3d Fri.
H. J. Norton, Pres., 108 Colo. Ave.
F. Fullman, C. & F. S., 1522 Colo. Ave., Colo. Springs, Colo.
- 137—PADUCAH, KY. 1st-4th Sun., Central Labor Hall, 122 1/2 N. 4th.
F. H. Pruess, Act. Pres., 1006 So. 11th.
Wm. Black, C. & F. S., 315 N. 3d St.
- 138—HARRISON, ARK.
H. C. Heppard, Pres.
T. T. Chubb, C. S.
- 140—PEN ARGYL, PA. 2d-4th Mon., Steinmitt's Hall, Bangor, Pa.
Joseph Wenninger, Pres. & C. S., care Realty.
J. A. Morgan, Fin. Sec., care Albion House.
- 143—KNOXVILLE, TENN. 319 N. Gay St., 1st-3d Tues.
Joseph Galloway, Pres., 1000 N. Broadway.
H. H. Lane, C. S., 1114 W. 5th Ave.
- 144—CEDAR RAPIDS, IOWA. 1st Monday in June and every other Mon. thereafter. I. O. O. F. Hall, cor. 2d Ave. and So. 1st St. W.
Chas. E. Kacer, Pres., 822 D. Ave. W.
Gus Liepold, C. & F. S., 605 I Ave. West.
- 145—MISSOURI VALLEY, IOWA. 1st-3d Thurs., Walker's Hall.
Hans Witt, Pres., Box 181.
Harvey Nichols, C. S.
- 148—VALLEJO, CALIF. 1st-3d Fri., Labor Temple.
Wm. Fountain, Pres., 225A Pennsylvania.
Wm. Kelly, C. S., 1008 York St.
- 149—MARSHALLTOWN, IOWA. 1st-3d Tues., Trades and Labor Assembly Hall, Main St.
Chas. Vyskocial, Pres., 9 E. Boone.
W. E. Pouley, C. S., 1110 W. Cole.
- 150—CHAMPAIGN, ILL. 1st-3d Sun., 2:30 p. m., I. C. System Fed. Hall.
Thos. H. Monahan, Pres., 511 W. Washington St.
A. E. Strode, C. S., 15 Hickory.
- 153—GASSAWAY, W. VA. J. E. Perkins, Pres., Gen. Del.
R. Lee Boone, C. & F. S., Gen. Del.
- 154—PITTSBURGH, PA. 1st-3d Fri., Labor Temple, cor. Washington and Webster Ave.
Frank Bann, Pres., 304 South Ave. N. S.
Henry J. Thumel, C. & F. S., 1218 Ith St. N. S.
James P. Carr, B. A., Labor Temple, Wash. and Webster Ave.
- 155—BLOOMINGTON, ILL. 2-4 Thurs., Machinists' Hall, West Chestnut St.
H. F. Lambrecht, Pres., 1004 N. Livingston St.
H. C. Nelhus, C. S., 1510 W. Chestnut.
L. J. Metzner, F. S., 1207 N. Mason.
- 157—SYRACUSE, N. Y. 1st-3d Wed., Bartenders' Hall, Clinton & W. Genesee St.
J. J. Hardeny, Pres., 214 Hartson.
Thomas Ranger, C. S., 120 Lydell.
- 161—BOONE, IOWA. 1st-3d Mon., at Electrical Workers' Hall.
Boyd Hedrick, Pres., 1421—half Story St.
H. W. Martens, C. & F. S., 1329 Meridan St.
- 163—HOBOKEN, N. J. 2d-4th Fri., 500 Bloomfield St.
Edwin L. Norwood, Pres., 933 Garden St.
P. L. Growney, C. S., 1034 Willow Ave.
- 165—DULUTH, MINN. 2d-4th Sat., Irwin-Sloan Block, 20th Ave. and Superior St.
James A. Graham, Pres., 5705 Grand Ave., W. Duluth, Minn.
Alfred S. Nelson, C. & F. S., 5705 Grand Ave., W. Duluth, Minn.
- 169—DETROIT, MICH. 2d-4th Fri., 235 Gardiot Ave.
Charles Komes, Pres., 31 Celarea.
Chas. F. Aderholdt, C. & F. S., 3 Driven St.
- 170—RICHMOND, VA. 1st-3d Wed., Labor Temple, 5th and Marshall Sts.
R. L. King, Pres., 822 N. 26th St.
E. M. Daywait, C. S., 2203 Venable St.
- 173—RALEIGH, N. C.
B. F. Long, Pres., 218 N. McDowell.
J. P. Taylor, C. & F. S., 615 W. North.
- 175—OSWEGO, N. Y. 2d-4th Mon., 8 p. m., Forester Hall, E. Bridge St.
Wm. Perau, Pres., 90 Hart St.
James Gorman, C. S., 64 Murray.
- 176—ELIZABETH, N. J. 2d-4th Wed., Dahnen Hall, 4th and E. Jersey St.
John H. Reynolds, 33 Delaware St.
Samuel M. Rankin, Secy., 64 Florida.
- E. J. McCarthy, B. A., 67 St. Mark's Place, New York City.
- 178—DENVER, COLO. 2d-4th Wed., Room 301 McPhee Bldg., 17th and Glenarm.
Geo. Zelts, Pres., 4255 Decatur St.
H. Shaffroth, C. & F. S., 3749 Wynkoop St.
- 180—MEMPHIS, TENN. Italian Hall, 1st-3d Fri.
W. T. Funston, Pres., 389 Webster Ave.
C. F. Gillenwater, C. S., 140 W. Iowa Ave.
- 187—MIAMI, ARIZ. Every Tues., Miami Hall.
J. B. Grenallt, Pres., P. O. Box 1132.
D. E. Reinhardt, C. & F. S., P. O. Box 1121.
- 191—VICTORIA, B. C. 2d-4th Tues., 1424 Government St.
A. Clyde, Pres. Sub. P. O. No. 2.
A. Stewart, C. S., Box 48, Beaumont, P. O. Esquimalt, B. C.
- 193—BALTIMORE, MD. Every Tues., Patterson Bldg., Baltimore and Gay Sts.
John Shanley, Pres.
James Chaney, F. S., 1419 Patapsica St.
Phillip Klingling, C. S., 410 E. 27th St.
- 194—VANCOUVER, B. C., CANADA 1st-3d Mon., at Labor Temple.
F. W. Jureit, Pres., 2140 Bernard St.
A. Fraser, C. S., 1151 Howe St.
- 195—KEWANEE, ILL. 1st-3d Fri., O'Donnell's Hall, 3d St.
M. J. Carney, C. S., 411 N. 1st St.
- 197—ALBANY, N. Y. 31 Green St., 2d-4th Sat.
J. H. Sullivan, Pres. & B. A., 173 2d St.
Jno. J. Leamy, C. S., 68 Livingston Ave.
- 198—OGDEN, UTAH. 2d-3d Tues., Union Labor Hall on 24th St., bet. Washington and Grant.
F. S. Dunn, C. & F. S., 116 23d St.
- 199—HORTON, KAS. 1st-3d Thurs., Carmen's Hall.
Barney Drew, Pres.
E. E. Myers, C. & F. S.
- 200—STATEN ISLAND, N. Y. I. O. G. T. Hall, W. Brighton, S. L. N. Y., 1st-3d Mon.
Richard Hough, Pres., 55 Bay Ave., Pt. Richmond, S. I.
Ethan A. Johnson, C. S., 208 Broadway, W. Brighton S. L. N. Y.
E. McCarty, B. A., 67 St. Mark's Place, N. Y. City.
- 201—WINONA, MINN. Labor Temple, 1st-3d Thurs.
Frank Rice, Pres., 574 W. 7th St.
Al. G. Kukowski, C. S., 219 Mankato Ave.
- 204—HONOLULU, H. I. Waverly Hall, 2d-4th Thurs.

Wm. Brown, Pres., Honolulu Iron Works.
 Thos. Murrey, C. S., 1541 King.
205—SAN FRANCISCO, CALIF. 2d-4th Tues., Rosch Hall, 15th and Mission.
 Wm. P. Bowser, Pres., 507 20th.
 J. M. Enright, C. S., 1431 Delores.
 Walter Anderson, F. S., 607 And-over.
 Wm. P. Bowser, B. A., 314 14th.
206—ALGIERS, LA. 2d-4th Fri., Renecky Hall.
 Jos. Koenig, Pres. & C. S., 825 Elmira Ave.
 C. A. Reynolds, F. S., McDonoghville, La.
209—DENISON, TEXAS. 2d-4th Mon., over State Nat. Bank.
 A. McDowell, Pres., 504 W. Owings St.
 S. E. Harris, C. & F. S., 923 W. Morgan St.
210—EL PASO, TEXAS. 2d-4th Thurs., Union Labor Hall.
 Wm. Beeson, Pres., Gen. Del.
 Frank H. Balt, C. S., 114 S. Stanton St.
212—SPRINGFIELD, MASS. 2d-4th Wed., Winkler's Hall, Bridges and Water St.
 Michael Fitzgerald, Pres., 843 Caren St.
 Wm. E. Donovan B. A., 9 Arbor.
 Jerh C. Driscoll, C. S., 141 Patton.
220—CHICAGO, ILL. 1st-3d Tues., 75th St. and Ellis Ave.
 A. G. Smith, Pres., 7036 Harper Ave.
 L. J. Cundiff, C. & F. S., 6029 Dorchester Ave.
221—PITTSBURG, KAN. 1st-3d Tues., Red Men's Hall, W. 3d St.
 E. E. Hielt, Pres., 1808 N. Grand Ave.
 P. J. Hielt, C. S., 1801 N. Grand.
222—MABT, TEXAS. W. O. W. Hall.
 E. J. Blount, Pres.
 G. W. Coates, C. & F. S.
223—UTICA, N. Y. Labor Temple, 2d Fri.
 Louis Wengert, Pres., 8 Wiley St.
 Edward Wengert, C. S., 43 Fass Ave.
226—ELMIRA, N. Y. 2d-4th Sun., Trades & Labor Hall, 200 E. Water St.
 A. E. Stevenson, Pres., 944 McGee.
 N. P. Durnin, R. & C. S., 519 Penn Ave.
 James Haley, F. S., 215 Bloomer Ave.
226—SALISBURY, N. C. W. O. W. Hall, Innes and Main Sts., 2d-4th Fri.
 L. C. Woodington, Pres., 319 E. Fisher St.
 E. A. Cowan, C. S., Box 271, Spencer, N. C.
227—CHICAGO, ILL. Garfield Park Hall, 4039 W. Madison St. 2d-4th Sat.
 John Seidon, Pres., 1107 Keeler Ave.
 Thomas Dean, F. & C. S., 2214 W. 13th St.
229—ROCHESTER, N. Y. 2d-4th Wed., 14 N. Water St.
 W. Weston, Pres., 17 Coffrey Place.
 Robt. Little, C. S., 211 Garfield.
232—OAKLAND, CAL. 2d-4th Mon., cor. 7th and Peralta Sts.
 H. Brown, Pres., 1003 Pine St.
 Geo. Young, C. S., 1788 9th St.
233—COLUMBIA, S. C. 2d-4th Tues., Plumbers' Hall, 1623 Main St.
 E. R. Fenell, Pres., 1712 Blanding.
 J. W. Bankhead, C. & F. S., 1705 Thompson Ave.
236—MARQUETTE, MICH. 4th Thurs., E. Seigle's Hall.
 Albert Bastien, Pres., 347 West Washington.
 Arthur Bourgois, C. S., 317 North 3d St.

237—HARTFORD, CONN. 2d-4th Wed., at C. L. U. Hall, Central Row.
 James Thornton, Pres., 52 Green.
 John J. Reilly, C. S., 46 Plurey.
238—CLIFTON FORGE, VA. 1st-3d Fri., Junior Hall.
 A. G. Burton, Pres.
 M. L. Steinbuck, C. S., Box 336.
239—ROCKY MOUNT, N. C. 1st-3d Mon., Machinist Hall, cor. Sunset and Main Sts.
 A. J. Dixon, Pres., 208 Atlantic Ave.
 H. M. Myers, C. S., 313 Maderson.
241—WASHINGTON, IND. Zinkin's Hall, 3d and Vantrees Sts., 1st-3d Tues.
 J. C. Mooney, Pres., East George.
 M. W. Luke, C. & F. S., 1007 W. Main.
242—SPOKANE, WASH. 2d-4th Wed., Carpenters' Hall, No. 9 Madison St.
 Frank Depender, Pres., 611 E. Indiana Ave.
 R. L. Mason, C. S., 218 S. Pittsburg St.
244—SIOUX CITY, IOWA. Labor Temple, 5th St., near Pierce, 3d Wed.
 John Ewing, Pres., 103 Alice St.
 Robt. O'Hern, C. S., No. 5 14th.
245—CONCORD, N. H. 2d-4th Mon., Central Labor Union Hall.
 El La Flamme, Pres., 125 N. Main, Pennacook, N. H.
 James Berryman, C. & R. S., 143 S. Main.
 Andrew Beauchouse, B. A., 89 S. Main St.
246—TERRE HAUTE, IND. Cor. 8th and Wabash Ave., 1st-3d Tues.
 H. M. Showalter, Pres., 1410 S. 17th.
 Jesse Dukes, C. S., 1561 S. 18th.
 F. Wittke, F. S., 1709 N. 12th.
247—TACOMA, WASH. 1st-3d Mon., Odd Fellows' Hall, S. Tacoma.
 P. F. Redding, Pres., 5644 Lawrence St.
 Wm. Polzin, C. & F. S., 5814 S. Lawrence St., So. Tacoma, Wash.
249—HUNTINGTON, W. VA. Every Fri., Thompson Bldg., cor. 20th St. and 3d Ave.
 John Myers, Pres.
 J. E. Stoll, C. & F. S., 1911 11th Ave.
 D. C. Dowdy, B. A., 2048 7th Ave.
250—BOSTON, MASS. Hollis Hall, 724 Washington St., 1st-3d Fri.
 Joseph F. Gilchrist, Pres., 194 W. E. Rhine.
 Jeremiah Murphy, C. S. & B. A., 107 Union Park St.
254—CHICAGO HEIGHTS, ILL. 1st-3d Mon. at Trades & Labor Assembly Hall, West End Ave.
 Thomas Hines, Pres., 1656 West End Ave.
 Thomas Brooks, C. & F. S., 306 W. 15th Place.
256—POTTSVILLE PA.
 Wm. Greaff, Pres., 542 E. Market.
 W. Smith, C. S., 215 Front, Minersville, Pa.
259—LIMA, OHIO. 2d-4th Thurs.
 W. C. Burns, Pres., 115 W. McKibbin St.
 Harry Gunn, C. S., 723 Wayne.
265—SMITHVILLE, TEXAS. 1st-4th Mon.
 E. C. Rovillo, Pres.
 G. L. Payton, C. S., Box 344.
267—MOBERLY, MO. 2nd and 4th Thurs. Painters' Hall.
 J. J. Cadagin, Pres.
 F. R. Lee, C. S., 601 Monroe Ave.
276—ST. LOUIS, MO. 2d-4th Fri., N. E. Cor. 11th and Locust.
 Herbert Abbey, Pres., 2618 Ann Av.
 Henry Waackler, C. S., 2919A Miami.
 Clyde Stevens, F. S., 1419 N. 21st.
 E. St. Louis, Ill.

278—ELKINS, W. VA. 2d-4th Thurs., Kendall Hall.
 C. L. Caskey, Pres., 10 Second.
 C. H. Godwin, C. & F. S., 312 Center St.
281—NORWOOD, MASS. 2d-4th Fri., 724 Washington St., Boston.
 Amos Bennett, Pres., 135 Appleton St., Boston, Mass.
 Robert Henderson, C. S., 274 Metropolitan Ave., Rosindale, Mass.
284—FREEPORT, ILL. Every 3d Wed. at Blust Hall.
 J. W. Daniels, Pres. and C. S., 27 Shawnee St.
286—FORT SCOTT, KAS. 1st-2d Mon., Redmen's Hall, 111 E. Wall St.
 J. W. McNow, Pres., 816 Marion Ave.
 J. C. Bonestell, C. S., 739 Croford.
287—KINGSVILLE, TEXAS.
 W. B. Poor, Pres.
 E. C. Martin, C. S.
290—BREMERTON, WASH.
 Sam Reardon, Pres.
 John Kornby, C. S., Gen. Del.
292—PARSONS, KAS. 2d-4th Tues., Moose Hall.
 C. Dudding, Pres., 2229 Crawford St.
 E. P. Butler, C. S., 1723 Gabriel.
293—SHAWNEE, OKLA. Trade Assembly Hall, 2d-4th Mon.
 Floyd Ott, Pres., 313 E. 9th St.
 A. D. Ross, C. & F. S., 429 N. Park Ave.
298—PORTSMOUTH, VA. C. L. U. Hall, 2d-4th Thur.
 J. W. Ford, Pres., 2225 High St.
 Robt. T. Howe, C. S., 826 4th St.
300—WATER VALLEY, MISS. I.
 O. O. F. Hall, 1st-3d Thur.
 C. H. Baker, Pres. and Treas.
301—CANTON, OHIO. 1st-3d Mon., Switzer Hall, Cherry and 9th Sts.
 Cleo Walker, Pres., 1021 Cherry St. N.
 E. J. Gussett, C. S., 1202 S. McKinley.
302—MILWAUKEE, WIS. 1st-3d Sat., Lipp's Hall, 3d and Prairie.
 R. Berger, Pres., 1427 Pratinet.
 J. L. Callahan, C. S., 3606 Clifton Ave.
 F. P. Youngbluth, F. S., 37 35th.
305—PORT ARTHUR, TEXAS. 2d-4th Tues., Labor Hall.
 L. G. Reil, Pres., Gen. Del.
 T. O. Riley, C. & R. S., Box 683.
 James Rose, F. S., Box 81.
309—EVANSTON, WYO. I. O. O. F. Hall, 1st-3d Wed.
 John T. Whittle, Pres., County Road.
 J. H. Willoughby, C. S., Box 419.
311—SOUTH KAUKAUNA, WIS. 2d-4th Mon., Odd Fellows' Hall.
 Ed. Hohnemann, Pres.
 Chas. F. Weigmann, C. & F. S., Box 133.
312—SELMA, ALA. 1st-3d Wed., at R. R. Y. M. C. A.
 J. F. Ryals, Pres.
 W. P. Fawcett, C. S., 1509 Selma.
315—McCOMB, MISS. Central Trade and Labor Hall, 1st-3d Wed. at 7:30.
 R. O. Bean, Pres. & C. S., Box 654.
317—RICHMOND, CALIF. Union Hall, 2d-4th Tues.
 Thos. J. Keegan, Pres., clo Germania Hotel.
 Wm. Jones, C. & F. S., Box 634.
318—PITTSBURGH, PA. 1st-3d Mon., Hazlewood Bank Bldg., cor. 2d and Hazlewood.
 W. Mertz, Pres., Path Alley.
 T. A. Hudson, F. S., 310 Johnston Ave.

- 320—MERIDAN, MISS.** B. L. E. Hall, 5th St. and 40th Ave., 1st-3d Thurs.
J. A. Smitheren, Pres., 511 40th Ave.
J. E. Alexander, C. & F. S., 3817 7th St.
- 322—ST. LOUIS, MO.** 1st-3d Tues., Reddy Hall, 3100 Chautau
John Coots, Pres., 2726 Washington Ave.
M. Renth, C. S., 4537 Michigan Ave.
- 323—CHICKASHA, OKLA.** 2d-4th Fri., Labor Hall, 4th and Choctaw.
C. A. Chincholl, Pres., P. O. Box 502.
W. L. Harkins, C. & F. S., 528 S. 15th.
- 325—SHREVEPORT, LA.** K. of P. Hall, over West End Drug Store, 2d-4th Thurs.
H. Abbott, Pres., 1542 Luchina Ave.
H. W. Huff, C. S., 1863 Texas Av.
- 332—CUMBERLAND, MD.** 1st-3d Wed., Chapel Hill House.
G. H. Little, Pres., 401 1st St.
C. J. Deal, C. S., 48 Penn Ave.
- 334—PRINCETON, IND.** 2d-4th Fri., 110 E. State St.
Fred Day, Pres., 617 S. Gibson.
Henry Schimmelman, C. & F. S., 1023 S. Prince.
- 335—GRAND JUNCTION, COLO.** 2d-4th Fri., Eagles' Hall.
P. F. Duffy, Pres.
E. H. Friend, C. & F. S., 308 Pitkin Ave.
- 339—SPARKS, NEV.** 2d-4th Wed., Engineers' Hall.
Wm. Daseler, Pres., P. O. Box 214.
C. E. Crouch, C. S., P. O. Box 214.
- 340—HERINGTON, KAS.** 1st-3d Sat., I. O. O. F. Hall.
John Olson, Pres.
Harry W. Willis, C. S., Box 224.
- 341—PHILADELPHIA, PA.** 2d-4th Tues., 8 p. m., Labor Headquarters, 232 N. 9th St.
Wm. J. Boyle, Pres., 208 N. 58th St.
Chas. Heberly, C. S., 3034 Aramingo Ave.
- 344—SHEFFIELD, ALA.** 1st-3d Wed. at I. O. O. F. Hall, Montgomery Ave.
G. I. Ferich, Pres., Tusculmbia, Ala.
Joseph Meyers, C. S., Tusculmbia, Ala.
- 345—SAN ANTONIO, TEXAS.** Trades Council Hall, 3d Thurs.
P. G. Sunmany, Pres., 221 Josephine.
H. H. Frick, C. & F. S., 1223 W. Traves St.
Delrympel, B. A., 410 River Ave.
- 346—TRENTON, MO.** 1st-3d Tues., at Cutlip's Hall.
Walter Mason, Pres., 1726 Lula Ave.
Geo. W. Singer, C. & F. S., 1801 Maine St.
- 353—HANNIBAL, MO.** Wm. James, Pres., 300 Rock.
J. J. Sughnee, C. & F. S., 836 Grand Ave.
- 354—BROOKFIELD, MO.** 1st-3d Tues., 212 N. Main St.
Martin Murphy, Pres., 291 Elm St.
J. K. Burnham, C. S., 212 W. John St.
- 355—CONNEAUT, OHIO.** 2d-4th Fri., in C. L. U. Hall, Main St.
Chas. Ward, Pres., Lake View Av.
J. M. Irish, C. S., 530 Sherman.
W. J. Brockett, F. S., 7 Blair St.
- 356—HAMMOND, IND.** 3d Wed., Long's Hall, State St.
Wm. J. Davis, Pres.
Albert Gragedo, C. S., 647 Calumet Ave.
- 360—LAFAYETTE, IND.** 1st-3d Thurs., Bartenders' Hall, 3d and Ferry Pt.
J. H. Goldsberry, Pres., 1620 N. 13th St.
J. A. Peacock, C. S., 1810 Charles Ave.
R. A. Davis, B. A., 1900 Schuyler Ave.
- 363—EAST ST. LOUIS, ILL.** 1st-3d Fri., Barry's Hall, cor. Coll and Ohio.
John Roach, Pres., 614 Ohio.
James E. Whitmore, C. & F. S., 314 Market.
- 364—COVINGTON, KY.** 1st-3d Mon., Heidels' Hall, N. W. cor. 21st and Russell Sts.
Herman Dedden, Pres., 19th and Euclid Ave.
R. F. Powers, C. S., 2011 Pearl St.
- 367—HAVRE, MONT.** 3d Sat., Oxford Hall.
Kyle Cope, Pres., 1423 3rd St.
Elmer Burns, C. S., 1037 2nd St.
- 369—ALEXANDRIA, VA.** 1st Thur. in month during summer months, 108 N. Patrick St.
James Moran, Pres., 1219 Duke.
R. B. Craddock, R. & F. S., 309 Cameron.
- 371—LOWELL, MASS.** 1st-3d Sat.
James Larrigan, Pres.
Geo. W. Smith, C. S., 68 Loring.
- 377—MOLINE, ILL.** 1st-3d Fri., Industrial House Bldg., Moline, Ill.
Wm. Colling, Pres., Silvis, Ill.
C. R. Kiser, C. S., Box 581, Silvis, Ill.
Walter S. Schneider, B. A., 1317 25th St., Rock Island, Ill.
- 378—MONCTON, N. B., CAN.** 2d-4th Fri., Sons of Temperance Hall.
Alex McDougall, Pres., 143 High St.
R. D. Donnelly, C. S., 69 Downing St.
- 379—McADAM JUNCTION, N. B., CAN.** 2d-4th Fri., Orange Hall.
Geo. Guest, Pres.
A. J. McLaggan, C. S.
- 381—AMARILLO, TEXAS.** 1007 Buchanan.
M. L. Parker, Pres., Box 407.
Joe Wilson, C. S., 1007 Buchanan.
- 382—CHILDRESS, TEXAS.** 2d-4th Fri., at 7:30 p. m., in Labor Temple.
Mack Leopold, Pres., P. O. Box 835.
J. M. Neal, C. S.
- 384—PERU, IND.** 2d-4th Tues., Labor Trades Hall.
Paul Uhlig, Pres.
W. H. Hawkins, F. & C. S., 404 W. 12th St.
Frank Sullivan, B. A., 673 W. Main.
- 388—MECHANICSVILLE, N. Y.** 2d-4th Tues., A. O. H. Hall, North Main St.
Wm. Sawyer, Pres., 321 Park Ave.
Sidney Crozier, C. S., 28 Railroad St.
- 390—TRINIDAD, COLO.** 2d-4th Wed., Labor Union Hall, East Main St.
W. T. Flynn, Pres., Arizona Ave.
A. A. Loftus, F. & C. S., 107 Goddard St.
- 391—DAVENPORT, IOWA.** 2d-4th Fri., Danish Hall.
John Schach, Pres., 516½ W. 3d.
R. F. Stewart, C. S., 616 Tremont Ave.
W. C. Richards, F. S., 1938 Bridge Ave.
- 392—CALGARY, ALBERTA, CAN.** 2d Sun. and 4th Tues., Labor Temple.
P. Willis, Pres., 1614 11th Ave. W.
F. Adams, C. S., Ogdens, near Calgary, Alb.
- 393—GOODLAND, KAS.** 1st-3d Tues., Calvert & Sparks' Law Office.
John McPeak, Pres.
John Maher, C. & F. S.
- 395—NORTH FOND DU LAC, WIS.** 1st-3d Fri., Trades and Labor Hall, cor. 3d and Main.
Elmer Shields, Pres., 109 Wible St.
Wm. Ford, C. S., 526 Main St.
- 396—NORWICH, N. Y.** 4th Wed. in Cook Block.
James E. Callahan, Pres., 1 Columbia St.
R. J. Condon, C. S., 10 Division.
- 398—RIVIERE DU LOUP, QUEBEC, CANADA.** Rioux Hall.
Pierre Loperriere, Pres., Blais Ville.
Ludger Oullet, C. & F. S., Blais Ville.
- 400—MIDDLETON, N. Y.** 2d-4th Sat., Odd Fellows' Hall.
Wm. Springer, Pres., 55 Beattie Ave.
W. S. Seeley, 7½ Sproat St.
- 402—PORTSMOUTH, OHIO.** 2d-4th Fri., C. L. U. Hall.
Fred Miller, Pres., cor Robinson and Summit Sts.
Edward Snyder, C. S., 2113 17th St.
- 403—HOISINGTON, KAS.** I. O. O. F. Hall, 1st-3d Mon.
M. C. Butcher, Pres., Box 525.
J. N. Shirley, C. & F. S., Box 495.
- 405—BLUEFIELD, W. VA.** 1st-3d Fri., Masonic Temple.
E. K. Collins, Pres., Princeton Ave. E.
W. F. Dupree, C. & F. S., Gen. Del.
- 409—VAN WERT, OHIO.** 3d Thurs., Suite 226 Home Guard Bldg.
E. K. Murlin, Pres., 208 N. Race.
- 410—SAN FRANCISCO, CAL.** 2d-4th Wed., Pollta Hall, 3265 16th St.
Ed Hannay, Pres., 518 Alvarada.
Ed Bohland, C. S., 3649 19th St.
Wm. P. Bowser, B. A., 314 14th St.
- 412—ST. THOMAS, ONTARIO, CAN.** 2d-4th Tues., Machinists' Hall, Talbot St.
Frederick Brooks, Pres., 5 Maama St.
Frank Roberts, C. S., 61 Wilson Ave.
- 414—ONEONTA, N. Y.** 2d-4th Mon., at Trades and Labor Hall.
Chas. Williams, Pres., 31 Church St.
David Lawrie, C. S., 73 W. Broadway.
- 415—JACKSONVILLE, ILL.** F. McKenna, C. S., 476 E. State.
- 417—NORTH BAY, ONT., CAN.** 2d-4th Fri., Liberal Rooms, Brennan Bldg.
M. V. Milton, Pres.
Frank Crother, C. S., Box 1775.
- 418—NEODESHA, KAS.** 1st-3d Sat., Baldwin Hall.
B. Boyle, Pres.
E. F. Reddick, C. S., Box 775.
A. F. Bingham, B. A.
- 419—SOMERSET, KY.** 1st-3d Tues., at Owen's Hall.
C. J. Shepenson, Pres., Station A.
Henry Schulte, C. S., Station A.
- 421—HAMILTON, ONT.** 1st-3d Fri., Labor Hall, John St. So. L. Lawton, Pres., No. 21 Tuckett.
F. Honison, C. & F. S., 6 Bristol.
- 422—SANFORD, FLA.** 2d-4th Wed., Eagles' Hall.
H. B. Purden, Pres.
Geo. Randall, C. & F. S., P. O. Box 1194.

423—BIG SPRINGS, TEXAS. W. O. W. Hall, 2d-4th Mon.
 W. E. Moore, Pres.
 W. P. Warren, C. & F. S., 201 N. 1st.
424—FLORENCE, S. C. 2d Thurs., Y. M. C. A.
 L. H. Mims, Pres., 222 Covington St.
 A. H. Dickman, C. & F. S., 609 Day St.
425—WAYCROSS, GA. 1st-3d Thurs., Plant Ave.
 C. W. Shultz, Pres., Nicholls St.
 Wm. J. Hauf, C. S., 83 Folks.
427—SALIDA, COLO. 2d-4th Thurs., Adilas Hall.
 H. F. Jones, Pres., 135 E. Sacket Ave.
 Wm. Dargavel, C. S., 821 E. St.
428—NORFOLK, VA. 2d-4th Wed., Pythian Castle Hall.
 W. M. Wood, Pres., 617 Liberty St., Berkely, Va.
 Thos. F. Callahan, C. S., Box 317, Berkely, Va.
429—CAPE GIRARDEAU, MO. 1st-3d Tues., Haas Hall.
 Geo. Stanley, Pres., 223 Frederick St.
 Oscar O. Berry, F. S., 415 S. Frederick St.
431—BOSTON, MASS. 2d Thurs., Naomi Hall, 724 Washington.
 Thos. R. Keenan, C. S., 80 W. 5th St., So. Boston.
434—CHICAGO, ILL. 2d-4th Wed., Boulevard Hall, 55th and Halstead Sts.
 H. Fischer, Pres., 6507 Sangamon.
 Ed Osborne, C. S., 48 E. 43d.
435—BRISTOL, TENN. 2d-4th Fri., Sixth and Shelby Sts.
 M. C. Cooper, Pres., V. & S. W. Ry. Shops.
 J. B. Wood, C. & F. S., 27 Lancaster St., Bristol, Va.
436—COLUMBUS, GA. 1st-3d Fri., K. C. Hall, cor. 13th and Broad Sts.
 R. S. Barry, Pres., 1109 5th Ave.
 E. W. McMichael, C. & F. S., 1103 21st.
437—TWO HARBORS, MINN. 2d and last Thurs., Iron Dock Grove Hall.
 Wm. Richards, Pres., Gen. Del.
 Frank J. Kontny, C. & F. S., Box 806.
438—GALETON, PA. 2d-4th Tues., Eagles' Hall.
 Daniel B. Shine, C. S., 20 First St.
439—FAIRBURY, NEB. Labor Temple, 2d-4th Tues.
 Fred Hurst, Pres.
 Edgar Sullivan, C. S., Box 301.
 B. Z. Millikan, C. S.
440—BELLE PLAINE, IOWA. 2d-4th Mon., Fireman's Hall.
 Charles Corns, Pres., 10th St.
 Warren Wheeler, C. S., P. O. Box 605.
442—NEW ORLEANS, LA. 3d Tues., Marlin Hall, Werville and Exchange Alley.
 James Miller, Pres., 1204 S. Franklin.
 John Mocklin, C. S., 606 Tele-machus St.
444—CONNELLSVILLE, PA. J. W. Easley, C. S., 113 Porter Av.
446—ALAMOSA, COLO. 2d-4th Wed., Trades Assembly Hall.
 Albert Jacobson, Pres.
 Chas. F. Darling, C. S., Box 64.
447—DECATUR, ILL. 1st-3d Tues., Ashley Hall, Mason Temple.
 Jaa. Gray, Pres., 817 N. Broadway.
 Chas. J. Younger, C. & F. S., 432 E. King St.
448—MONTGOMERY, ALA. 1st-3d Wed., Young's Hall.
 J. E. Johnson, Pres., 89 Morgan Ave.
 E. J. Ford, C. S., 75 Morgan Ave.
449—SAPULPA, OKLA. 2d-4th Mon., Pane Hall.

D. A. Clifton, Pres.
 J. D. Allen, C. & F. S., 1133 E. Hobson.
450—WASHINGTON, D. C. 2d-4th Wed., Weiler's Hall, 8th & I. St., S. E.
 S. Kelchner, Pres., 1020 B. St., S. E.
 W. F. Kilroy, C. S., 11 I St., N. E.
451—WINNIPEG, MAN., CAN. 1st Tues. and 3rd Sun., Labor Temple.
 D. Nelson, Pres., 322 Morley Ave.
 J. Tomes, C. & F. S., 378 Madison St., St. James, Man.
453—COPPERHILL, TENN. 1st-3d Tues., I. O. O. F. Hall.
 Chas. Frens, Pres., Box 711.
 E. N. Hall, C. S., Box 382.
454—CHICAGO, ILL. 2d-4th Thurs., Persey Hall.
 Walter Love, Pres., 752 E. 69th St.
 E. R. Dettmer, C. S., 9245 Stoney Island Ave.
458—SHERMAN, TEXAS. 2d-4th Thurs., Labor Hall.
 A. T. Green, Pres., 501 W. Morgan St., Denison, Tex.
 John W. Plexco, C. S., 424 S. Gribble.
463—BALBOA, CANAL ZONE, PANAMA. Empire Lodge Hall, 2d-4th Fri.
 Alex McKenzie, Pres.
 W. H. Keenan, C. & F. S., Box 26, Culebra, C. Z.
464—PALESTINE, TEXAS. Labor Temple, 2d-4th Wed.
 Phil Lyser, Pres., 111 Irwin.
 J. D. Mallette, C. & F. S., 503 La.
466—REVELSTOKE, B. C. 3rd Sat., Selkirk Hall.
 M. M. Keller, Pres., Box 138.
 A. Harris, C. & F. S., Box 138.
467—PORTSMOUTH, N. H. 2d Wed., Eagles' Hall.
 John Quinn, Pres., Court St.
 Alfred Olson, C. S., Box 27, Kittery, Me.
469—TERRELL, TEXAS. 2d-4th Fri., Trades and Labor Hall, 202 E. Moore Ave.
 J. R. Poston, Pres., 608 E. College St.
 R. E. O'Reilly, C. S., 906 E. Moore Ave.
471—CRISTOBAL, C. Z. 2d-4th Thurs., Building No. 1.
 J. Z. Knapp, Pres., Gatum, C. Z. 369.
472—HELPER, UTAH. 1st-3d Wed., K. of P. Hall.
 Wm. R. Welsh, Pres.
 R. W. Smith, C. & F. S., Box 411.
475—GRAND ISLAND, NEB. 1st-3d Mon., City Hall, 2d St.
 H. W. Hunt, Pres.
 Sherman Aldrich, F. S., 1014 E. 4th St.
476—DALHART, TEXAS. 1st-3d Sat., each month.
 A. W. Williams, Pres.
478—MOOSE JAW, SASKATCH- C. A. Johnson, C. S., Box 486.
EWAN, CANADA. 2d-4th Mon., Trades and Labor Hall, High St., E.
 J. L. Jones, Pres., 78 Choteau St. W.
 Geo. Walters, C. S., 30 Duffield.
479—DEVIL'S LAKE, N. DAK. 1st Fri., Opera House Hall.
 J. A. Thompson, Pres., Box 324.
 Andrew Ruthford, C. & F. S., 714 Flint Ave.
481—LYNDONVILLE, VT. 1st-3d Wed., Eaton's Hall.
 B. A. Hinds, Pres.
 Phil L. Rheume, R. & C. S., Box 105.
 J. M. Breason, B. A.
482—ALTON, ILL. Schwartzbeck Hall, 3d and Ridge. 1st-3d Tues.
 Fred Emmel, Pres., 1410 E. 3rd St.
 Robt. Dale, C. S., 3008 Edwards.

485—GREEN BAY, WIS. 1st Thur. and 3rd Sun., Boiler Makers' Hall, 711 Main St., Bridge.
 John Christianson, Pres., 332 S. Maple Ave.
 John Slater, C. & F. S., 425 5th St.
486—TYLER, TEXAS. 1st-3d Wed., K. O. T. M. Hall.
 J. A. Fuller, Pres., 1116 Irvin.
 J. M. McCarty, C. & F. S., 221 Center St.
 C. R. Welch, B. A., 1428 N. Fannie Ave.
490—SEATTLE, WASH. 3d Wed. J. R. Martin, C. S., The Broadway, Yeslerway.
491—VALLEY JUNCTION, IOWA. 1st-3d Tues., I. O. O. F. Hall.
 Frank S. Hoppe, Pres.
 J. C. Carroll, C. S., Box 165.
 Geo. W. Fring, B. A., Treas.
492—WORCESTER, MASS. 1st-4th Thur., Foresters' Hall.
 Patrick I. Curran, Pres., 4 Wil-son.
 John Casey, C. S., 61 E. Central.
493—NEW CASTLE, PA. Every other Wed., Trades Assembly Hall.
 Seth Marshall, Pres., 316½ Nesh-annock Ave.
 E. A. Horchler, C. & F. S., 906 E. Washington.
495—HATTIESBURG, MISS. J. O'Brien, Pres.
 A. H. Waddell, C. S., 500 Boule.
496—HURON, SOUTH DAKOTA. 2d-4th Fri., Labor Hall.
 Peter Paluszak, Pres., Box 325.
 C. Storkson, C. S., 228 Beach St.
500—EVERETT, WASH. 2d-4th Tues., Labor Temple, 3506 Everett Ave.
 Wm. Faulke, Pres., 3506½ Ever-ett Ave.
 Bert Bloomington, C. S., 4001 Smith Ave.
501—WACO, TEXAS. 2d-4th Fri., Labor Hall.
 Chas. Bullock, Pres., R. F. D. No. 2.
 Wm. Dickerson, C. & F. S., 810 Cleveland St.
502—TEAGUE, TEXAS. 1st-3d Mon., Davis Hall.
 Thos. McGrath, Pres., Box 244.
 A. B. Campbell, C. S.
503—FITZGERALD, GA. 1st-3d Wed., I. O. O. F. Hall.
 M. J. Mauns, Pres., P. O. Box 686.
505—MUSKOGEE, OKLA. 1st-3d Wed., Carpenters' Hall.
 Thos. Graham, Pres., 233 S. C.
 Wm. Sohner, C. S., 616 N. F. St.
505—FORT WILLIAM, ONTARIO CAN. 1st-3d Fri., Electricians' Hall, Murphy Block, Simpson Ave.
 Isaac Hunter, Pres., 213 Freder-ica St.
 A. Cruickshank, C. S., 1007 Minn. Ave.
507—ATCHISON, KAS. 1st-3d Mon., Fireman's Hall, 1521 Main St.
 J. F. Coyle, Pres., 1418 Kansas Ave.
 John J. Freibott, C. & F. S., 1420 Kansas Ave.
509—JACKSON, OHIO. 2d-4th Mon., Hibernian Hall.
 O. B. Reynolds, Pres., 77 High St.
 Albert Edmonds, C. S., 77 Hunt St.
 J. B. Fillinger, B. A. and Journal Cor., 53 Main St.
510—CEDARTOWN, GA. E. M. Kendrick, Pres.
 I. C. Smith, C. S.
511—WHISTLER, ALA. 1st-3d Mon., I. O. O. F. Hall.
 J. L. Scholls, Pres.
 C. C. Crane, C. S.
515—EAST CAMBRIDGE, MASS. Engineers' Hall, 164 Canal St., Boston, Mass., 1st-3d Fri.

- Geo. A. Mitchell, Pres., 39 S. Russell St., Boston, Mass.
Joseph Irwin, C. & F. S., 36 Glendale St., Everett, Mass.
- 517—GREENFIELD, MASS. 2d-4th Sat., Forester Hall.
Z. E. Pallin, Pres., 6 Devens St.
M. J. Cummuskey, C. S., 287 King St., Northampton, Mass.
- 518—WICHITA, KAS. 1st-3d Thurs., 216 N. Main St.
Roy Connors, Pres., 1440 S. Market St.
J. M. Devlin, C. & F. S., 620 Hiram Ave.
- 520—MILES CITY, MONT. 2d-4th Mon., I. O. O. F. Hall.
P. J. Gallagher, Pres., 602 N. Lake St.
Chas. E. Cook, C. & F. S., 725 Phillips St.
- 521—VAN BUREN, ARK. 1st-3d Thurs., W. O. W. Hall.
E. C. Norman, Pres., Box 343.
Otto Pyles, C. S.
- 522—EL BENO, OKLA. 1st-3d Tues., Redmen's Hall.
D. F. Rowe, Pres., 207 N. Barker.
H. E. Hart, C. & F. S., Box 624.
- 523—PRATT, KAS. 2d-4th Tues., at S. T. Sample's residence.
Frank Stephens, Box 612, Pres.
Lox Logan, C. S., 607 N. Jackson.
- 524—MURPHYSBORO, ILL. 2d-4th Wed., Machinists' Hall, 107 S. 10th.
H. P. Fay, Pres., 1812 Pine.
E. P. Herin, C. & F. S., 2107 Wall.
- 525—HINTON, W. VA. 1st-3d Mon., Big Four Bldg.
W. L. Taylor, Pres., 108 Grace St.
C. L. Barnett, C. & F. S. & B. A., 207 2d Ave.
- 526—DEER LODGE, MONT. 2d-4th Fri., I. O. O. F. Hall.
O. T. Bidlingmeyer, Pres.
G. B. McNurlin, C. & F. S., Box 564.
- 529—TRANSCONA, MAN., CAN. 1st Sun., Campbell Hall, Transcona, 3rd Sun., Labor Temple, Winnipeg, 3 p. m.
Wm. S. Douglas, Pres.
James Fraser, F. & R. S., Yale Ave.
- 530—SPRINGFIELD, MO. 3d Mon., Dengeldem's Hall.
J. W. Reddick, Pres., 817 Lincoln.
John Cain, C. & F. S., 507 Fort.
A. F. Bingham, B. A., 701 Lombard St.
- 531—CHAFFEE, MO. 1st-3d Thurs., City Hall.
T. C. Davis, Pres.
C. P. Bourlon, C. & F. S., Box 365.
- 537—COVINGTON, KY. 2d-4th Fri., Workman Hall, 122 Pike St.
John J. Fielding, Pres., 1389 Scott St.
John H. Zerhusen, F. S., 862 Crescent Ave.
J. J. Fielding, B. A., 1389 Scott.
- 541—BEDFORD, IND. 2d-4th Thurs., Labor Union Hall.
Dan J. Kane, Pres., 511 N. I St.
Chas. J. Bordenet, C. S., 628 N. I St.
- 542—COFFEYVILLE, KAS. Labor Temple, 2d-4th Wed.
R. M. Jones, Pres., 807 W. 14th.
J. C. Morrow, C. & F. S., 613 W. 4th St.
- 543—WICHITA, KAS. 216 N. Main St., 2d-4th Mon.
R. J. Molyneux, Pres., 528 Baltimore Ave.
C. E. Grove, C. S., 701 W. Central.
- 546—MONETT, MO. 1st-3d Tues., K. C. Hall.
David Elder, Pres., 406 9th St.
John Linebarger, C. & F. S., 214 Pearl St.
- 547—CARBONDALE, PA. Pughanas Hall, 2d-4th Fri.
Eli T. Dickenson, Pres.
James A. Flannery, C. & F. S., Box 185.
Wilkes Barre Representative, T. J. Cavan, 60 Chester St., Wilkes Barre, Pa.
- 548—TORONTO, CAN. 2d-4th Wed., Labor Temple, Church Jas. Dobson, Pres., 280 Perth Ave.
W. H. Watson, C. S., 162 Annette St.
- 549—MIDDLEPORT, O. Woodman Hall, 1st-3d Wed.
F. B. Williams, Pres.
Perry Cooper, C. & F. S.
- 551—PRINCETON, W. VA. Castle Hall, 1st-3d Thurs.
J. J. Bower, Pres., 821 Princeton Ave.
J. H. Blackwell, C. S., Box 312.
- 553—LA GRANGE, ORE. Wm. Andis, Pres., 1506 V Ave.
Jas. H. Guttridge, C. S., Box 197.
- 556—OKLAHOMA CITY, OKLA. C. S. Cochran, Pres., 406 W. Frisco.
E. F. Ryan, C. & F. S., 400 West Frisco.
- 557—WILLIAMSON, W. VA. 2d-4th Tues., Justice Bldg.
H. W. Blas, Pres., 15 5th Ave. E.
Bert Howard, C. & F. S., Box 113.
- 558—FALLS CITY, NEB. 1st-3d Thurs., W. O. W. Hall.
C. W. Jones, Pres.
E. Woodington, C. & F. S., 710 E. 16th St.
- 567—SAN ANGELO, TEX. 1st-3d Wed., Eagles' Hall.
J. H. Dozier, Pres., cor. Ave. I and Sam St.
R. L. Wright, C. S., 27 West Ave.
- 568—TACOMA, WASH. Maccabee Hall, 1109 1/2 C St., 2d-4th Thurs.
Chas. Manning, Pres., 5808 S. Lawrence St.
Geo. B. Hutchinson, C. & F. S., 6210 S. Warner.
- 570—HIGH SPRINGS, FLA. H. A. Smith, Pres., P. O. Box 273.
F. C. Magerstaadt, C. S.
- 571—DE PERE, WIS. De Both Hall, 1st Sun.-3d Wed.
T. J. McDonald, Pres., Lock Box 44, W. De Pere, Wis.
A. B. Steinfeldt, R. S., P. O. Box 207.
- 573—LANSFORD, PA. Wm. J. Williams, C. S., 843 East Ridge St.
- 575—VILLA GROVE, ILL. 1st-3d Fri., Red Men's Hall.
H. Downer, Pres.
A. Welch, C. S., Box 152.
- 576—WICHITA FALLS, TEX. 2d-4th Thurs., Labor Hall.
J. H. Gibson, Pres., 309 Lee St.
C. K. Matthews, C. & F. S., Box 760.
C. H. Shoemaker, B. A., Box 18, Haldilton, Okla.
- 577—CUMBERLAND, MD. J. L. Teets, 14 Arch St.
- 578—HAGERSTOWN, MD. Moose Hall, 2d-4th Thurs.
L. J. Murray, Pres., 25 Vine St.
Fred H. Stouffer, C. S., 817 Summit Ave.
- 579—KEYSER, W. VA. 1st-3d Tues., St. Mary Hall, James St.
W. H. Wolf, Pres., Gilmore St.
Joseph F. Hines, C. S., Box 524, Piedmont, W. Va.
- 581—MONTPELIER, O. 1st-3d Wed., Ry. Trainmen's Hall.
S. Brown, Pres.
J. Birmingham, C. S.
- 582—BATON ROUGE, LA. 2d-4th Thurs., Odd Fellows' Hall, 3d St.
W. P. Kidd, Pres., 302 St. Philip St.
S. V. Acosta, C. & F. S., 918 St. Ferdinand St.
- 583—NEVADA, MO. Socialist Hall, Hall, So. Main St., 1st-3d Fri.
G. C. Matney, Pres., 531 E. Locust St.
A. C. Le Quellec, C. & F. S., 530 E. Cherry St.
- 584—LUDLOW, KY. 1st-3d Thurs., Morley Hall.
Thos. Jackson, Pres., 17 Cherry.
H. J. Stroer, C. S., 832 Main, Covington, Ky.
- 585—BOSTON, MASS. 1st Thurs., 8 p. m., and 3d Sun., 2:30. Hemstead Hall, 724 Washington St.
Wm. E. McNabb, Pres., 263 Chelsea, E. Boston, Mass.
Daniel B. McInnes, C. S., 288 Marginal Ave., E. Boston, Mass.
- 586—SLATER, MO. 1st-3d Mon., Firemen's Hall.
A. Phillips, Pres.
S. E. Nicholson, C. & F. S.
- 587—BEAUMONT, TEX. Every Sun. night, Trades Assembly Hall, Pearl St.
O. H. Greer, Pres., Box 149.
T. C. Maddy, F. & C. S., 229 Fulton.
- 588—CHICAGO, ILL. 2d-4th Tues., Koop's Hall, California & North Ave.
Thomas Godfrey, Pres., 930 E. 44th St.
John McNaney, C. & F. S., 2613 Iowa St.
- 589—MILWAUKEE, WIS. 2d-4th Thurs., 923 E. Water St.
Chas. Pable, Pres.
M. J. Gleason, C. & F. S., 202 Michigan St.
- 590—MONROE, LA. 3d Fri., J. J. Devereux's House, 615 Colypso St.
J. W. Grant, Pres., 501 Wood St.
J. J. Devereux, C. & F. S., 615 Colypso St.
- 591—GLENVIEW, MONT. 2d-4th Fri., Noderhoff Hall.
V. B. O'Connor, Pres. & C. S., 317 Valentine St.
J. J. Shinault, F. S., Gen. Del.
- 592—TULSA, OKLA. 2d-4th Sat., 214 1/2 S. Main.
John Ingram, Pres., Gen. Del., Sand Springs, Okla.
Wm. Carey, C. & F. S., Room 201 Union Labor Hall.
- 594—STANBURY, MO. 2d-4th Tues., K. of P. Hall.
John Inman, Pres.
E. W. McNew, C. & F. S.
- 595—AVERY, IDAHO. 1st-3d Sat., Farrell's Hotel.
Wm. Lally, Pres.
A. Anderson, C. & F. S., Gen. Del.
- 596—CASPER, WYO. 2d-4th Mon. B. F. Holiday, Pres.
A. Doornbos, C. & F. S., Box 272.
- 597—ESCANABA, MICH. 1st-3d Thurs., Lemmer Hall, Ludington St.
Jos. Vickers, Pres., 506 Wells Ave.
Wm. Grosnick, C. & F. S., 714 Wells Ave.
- 598—SALAMANCA, N. Y. 1st-3d Mon., 3 Maple St.
A. G. Frey, Pres., 165 E. State St.
D. J. Carpenter, C. & F. S., 3 Maple St.
- 599—PARAGOULD, ARK. 1st-3d Thurs., Carpenters' Hall.
J. W. Frey, Pres., 321 E. 2d St.
L. M. Bounin, C. & F. S., 310 W. Garland.

600—AKRON, OHIO. Walsh Bldg.
Jas Shaughnessy, Pres., 876 So.
Main St.
R. C. Price, C. & F. S., 150 Ad-
ams St.
601—QUEBEC, CAN.
J. Thompson, Pres., 130 3d St.,
Simillon.
G. Dery, C. S., 183 4th St., Li-
morlow, Can.

602—GREAT FALLS, MONT. 1st-
3d Tues., Judge Safford's Court
Room.
Frank Yelocan, Pres., 1500 8th
Ave. N.
Roy J. Preston, C. & F. S., 706 8th
Ave. So.
603—OTHELLO, WASH. 1st-3d
Mon., I. O. O. F. Hall.
O. W. Bohusock, Pres.
W. A. Clark, C. S., Box 137.

604—JOLIETTE, QUE., CAN.
H. Fournier, Pres., Gen. Del.
W. C. Williams, C. & F. S., Box
238.
605—TOOELE, UTAH. 1st-3d
Tues.
C. A. Blair, Pres.
E. H. Sorensen, C. & F. S.
606—MORBRIDGE, S. D. 1st-3d
Thurs., Moose Hall.
J. P. Schnellkrath, Pres.
E. L. Adams, Box 166.

International Officers of the Ladies' Auxiliary

MRS. J. W. EDWARDS.....President
1234 S. 9th East St., Salt Lake City, Utah.
MRS. F. R. REINEMEYER1st Vice-President
Tauromee Ave., Kansas City, Kans.
L. A. 5—SALT LAKE CITY,
UTAH.
Mrs. J. W. Edwards, Pres. & C.
S., 928 W. South Temple St.
Mrs. Lydia Smithen, V.-Pres., 360
West 1 South St.
Mrs. J. C. Walton, F. S.
Mrs. Jane Foreman, Treas.
Mrs. Morton, R. S., 116 Markham.
L. A. 7—SUNFLOWER, Parsons,
Kas. 2d-4th Tues. aft., Ken-
nedey Hall.
Mrs. Dorothy Howell, Pres., 2531
Dirr Ave.
Mrs. Anna Hawksworth, V.-Pres.,
2202 Main St.
Mrs. Zita Rever, Treas., 1706 Ga-
briel Ave.
Mrs. Lillian Dudding, C. S., 2229
Crawford Ave.
Mrs. Lillian Van Vleck, R. S., 2701
Clark Ave.
Mrs. H. W. Smith, F. S., 2718
Chess Ave.
L. A. 8—FRANKLIN, McComb,
Miss., Ladies' Aux. Hall, Ave.
F. East McComb, 2d-4th Thurs.
Miss Lula Hassfield, Pres., R. F.
D. No. 1.
Mrs. E. Sullivan, V.-P. & Treas.,
725 Ave. F.
Miss Emma Sullivan, C. S., 725
Ave. F.
Miss Lulu Hassfield, R. S.
L. A. 9—GRAND JUNCTION,
COLO.
Mrs. W. H. Holeman, Past Pres.,
914 S. 5th St.
MRS. MOLLIE GEARY.....2nd Vice-President
6428 S. Albany St., Chicago, Ill.
MRS. A. F. BINGHAM.....Secretary-Treasurer
701 Lombard St., Springfield, Mo.
Mrs. F. N. Davies, Pres. & Treas.,
538 Ute Ave.
Mrs. J. W. Cox, C. & F. S. & V.-
P., 925 S. 5th St.
Mrs. L. A. Turner, R. & S. T.
L. A. 10—SPRINGFIELD, MO.
Mrs. R. A. Linnis, Past Pres., 818
W. Atlantic.
Mrs. A. F. Bingham, Pres., 701
Lombard St.
Mrs. Ira Fowler, V.-Pres., 821 W.
Brower.
Mrs. Wm. Specht, C. & F. S.,
Route No. 6.
Mrs. C. S. Gilliland, R. S., 1915
Johnson Ave.
Mrs. G. M. Scott, Treas., 1015
Locust St.
Mrs. C. A. Pachehofer, Chaplain,
36 W. Calhoun.
Mrs. W. Sharp, Marshal, 634
Smith St.
Mrs. Harry Jeans, Conductress,
1246 Broad.
Mrs. W. C. Connett, Inside Guard,
Route 7.
Mrs. Henry Beckley, Mrs. C. S.
Gilliland and Mrs. Wm. Sharp,
Trustees.
L. A. 11—LONE STAR, Palestine,
Texas, Labor Temple, 2d-4th
Tues. afternoons.
Mrs. Frances Brunson, Pres., 15
Cottage Ave.
Mrs. Helen Redus, V.-P., 106
Queen St.
Mrs. Florence Payne, R. S. &
Treas., 212 Palmer Ave.
Mrs. Willie Welch, C. & F. S., 511
Green St.
L. A. 12—GARFIELD PARK, Chi-
cago, Ill., 1st-3d Sat., 3 p. m.,
Garfield Park Hall, 4039 W.
Madison.
Mrs. Maud Reinemeyer, Past
Pres., 111 W. Chestnut St.
Mrs. Mollie Geary, Pres., 1535 W.
61st St.
Mrs. E. Farrell, V.-P., 4118 Car-
roll Ave.
Mrs. Helen Hughes, Cor. & Rec.
Sec., 716 N. Avers Ave.
Mrs. Mary Driscoll, Fla., Sec. &
Treas., 4135 Carroll Ave.
L. A. 14—TOLEDO, O.
Mrs. E. Richardson, Pres.
Mrs. Allen Thomson, V.-Pres.
Mrs. C. F. Haga, R. S.
Mrs. C. J. Sugrue, C. & F. S.
Mrs. Carrie Stephan, Treas.
Mrs. Louise Brown, Conductress.
Mrs. Lena Kern, Inspectress.
L. A. 15—SAPULPA, OLKA.
Mrs. Cora Johnson, Pres.
Mrs. Myrtle Clifton, V.-Pres.
Mrs. Addie Allen, R. S.
Mrs. Bessie Lewis, C. S.
Mrs. Hester Chapman, F. S.
Mrs. Ethel Edwards, Treas.
Mrs. Hettie Rondon, Chaplain.
Mrs. Ferrel Wells, Conductress.
Mrs. Emma Davis, Inside Guard.
Mrs. Katie Hoover, Marshal.
Trustees—Laura Cargill, Mrs. Em-
ma Davis, Mrs. Addie Allen.

Boilermakers' Lodges by States.

Alabama.	Macon12	Maryland.	New Jersey.	Tennessee.
Birmingham . 4	Savannah ... 26	Cumberland . 332	Elizabeth176	Bristol435
Montgomery .443	Waycross ...425	Cumberland .577	Hoboken163	Copperhill ...453
Selma312		Baltimore ...193	Jersey City ...16	Jackson 88
Sheffield344	Idaho.	Hagerstown .578		Knoxville ...143
Whistler511	Avery595		New York.	Memphis ...189
Arizona.	Illinois.	Massachusetts.	Albany197	Nashville ... 42
Miami187	Alton483	Boston250	Brooklyn ... 45	Chattanooga .14
Arkansas.	Bloomington 155	Boston431	Elmira.225	Texas.
Harrison ...138	Chicago 1	Boston585	Mechanics-	Amarillo321
Little Rock . 66	Chicago 39	Cambridge .515	ville388	Beaumont ...587
McGhee106	Chicago220	Dorchester .574	Middletown .400	Big Spring .423
Paragould ...699	Chicago227	Greenfield .517	Norwich396	Childress ...382
Pine Bluff ... 68	Chicago454	Lowell371	Oneonta414	Dalhart476
Van Buren ...521	Chicago484	Norwood281	Rochester ...229	Dallas 85
Canada.	Chicago Hts.254	Springfield .218	Salamanca .598	Denison209
Calgary.	Chicago588	Worcester ...492	Staten Island.200	El Paso216
Alberta ...392	Danville 22		Syracuse157	El Worth 96
Ft. William.	Decatur447	Michigan.	Troy 73	Ft. Worth ...132
Ont.505	Freeport ...284	Bay City ... 67	Utica223	Galveston ...132
Hamilton,	Joliet 93	Detroit169	N. Y. City... 21	Houston 74
Ont.421	Kewanee ...195	Escanaba .597	North Carolina.	Kingsville ...287
Joliette, Que.604	Mattson ...224	Grand Rapids 84	Raleigh173	Marshall ...100
McAdam Jct.379	Moline377	Jackson 64	Rocky Mount.239	Mart222
Moncton, N.B.378	Peoria 60	Marquette ...238	Salisbury ...226	Palestine ...464
Montreal ...134	Murphysboro 524	Saginaw ...124		Sherman458
Moose Jaw,	Springfield .81		North Dakota.	Port Arthur.305
Sask.478	E. St. Louis.383	Minnesota.	Devils Lake.479	Smithville ...265
North Bay,	Urbana150	Brainerd ...116		San Antonio.345
Ont.417	Villa Grove.575	Duluth165	Oklahoma.	Teague502
Quebec601	Indiana.	Minneapolis .11	Muskogee ...504	Terrell469
Revelstoke .466	Bedford541	St. Paul 3	Okl. City ...556	Tyler486
Riviere du	Evansville ... 95	Two Harbors.437	Sapulpa449	Waco.501
Loup, Que.398	Ft. Wayne . 54	Winona201	Shawnee ...293	Utah.
St. Thomas,	Garrett79	Mississippi.	Chickasha ...323	Helper473
Ont.413	Hammond ...356	McComb City.315	El Reno522	Ogden198
Toronto, Ont.548	Indianapolis .10	Meridan320		Salt Lake
Transcona,	Lafayette ...360	Vicksburg ... 56		City103
Man.529	Peru 384	Water Valley.300		Tooele605
Winnipeg, M.126	Princepton .334	Missouri.	Ohio.	Vermont.
Winnipeg, M.451	Terre Haute.246	Brookfield .354	Akron600	Lyndonville...481
British	Washington .241	Cape Girar-	Canton301	
Columbia.	Wabash324	deau430	Chillicothe .135	Virginia.
Vancouver ...194	Iowa.	Chaffee531	Cincinnati...106	Alexandria ...369
Victoria191	Belle Plaine.440	De Soto117	Cleveland ... 8	Clifton Forge.238
California.	Boone161	Hannibal ...353	Columbus ... 5	Newport News. 55
Los Angeles. 92	Cedar Rapids.144	Kansas City . 32	Conneaut ...355	Norfolk426
Oakland233	Des Moines... 47	Moberly267	Elmwood	Portsmouth .298
Pt. Richmond.317	Dubuque15	Monett546	Place 91	Portsmouth .57
Sacramento . 94	Marshalltown.149	Nevada583	Jackson509	Richmond ...170
S. Francisco. 25	Mo. Valley...145	Sedalia113	Lima 269	Roanoke 30
S. Francisco.205	Sioux City .244	Springfield .70	Middleport .549	Roanoke ... 29
S. Francisco.410	Valley Jct. .491	Springfield .530	Montpelier .581	Victoria 65
Vallejo148	Waterloo ...133	Stater586	Newark 92	Washington.
Colorado.	Kansas.	St. Louis ... 27	Niles275	Bremmerton .290
Alamosa446	Atchison ...507	St. Louis ... 51	Portsmouth .402	Everett500
Colorado ...136	Coffeyville .542	St. Louis ...276	Springfield .18	Othello603
Denver179	Ft. Scott ...286	St. Louis ...322	Toledo 85	Spokane242
Grand Jct. .335	Goodland ...393	St. Joseph . 31	Van Wert ...409	Seattle104
Pueblo 44	Herington .340	St. Joseph .31	Oregon.	Seattle489
Salida427	Holington .408	Stanbury ...594	La Grand ...553	Tacoma247
Trinidad ...390	Horton199	Sugar Creek. 90	Portland ... 72	Tacoma568
Connecticut.	Kansas City.83	Trenton346	Panama.	West Virginia.
Hartford ...237	Neodesha ...418	Montana.	Empire, C. Z.463	Bluefield ...405
New Haven. 61	Oswatomie . 82	Anaconda ... 80	Cristobal ...471	Elkins278
Delaware.	Parsons292	Deer Lodge .528	Pennsylvania.	Gassaway ...152
Dist. of Columbia	Pittsburg ...221	Glendive ...591	Carbondale .547	Hinton525
Washington 450	Pratt523	Great Falls.602	Connellsville .444	Huntington .249
Florida.	Wichita543	Harlowton . 41	Galeton438	Keyser579
High Springs.570	Wichita618	Havre367	Lansford ...573	Princeton ...551
Jacksonville . 20	Kentucky.	Livingston ...123	New Castle.493	Williamston .557
St. Augustine.230	Covington ...537	Miles City .520	Philadelphia .341	Wisconsin.
Sansford ...573	Covington ...364	Missoula ...111	Pen Argyl ...140	Butler589
Sanford422	Louisville ... 40	Butte130	Pittsburgh .154	De Pere571
Georgia.	Ludlow584	Nevada.	Pittsburgh .318	Green Bay .485
Atlanta 2	Paducah ...137	Sparks339	Philadelphia. 19	Milwaukee ...107
Augusta ...108	Somerset ...419	Nebraska.	Pottsville ...256	Milwaukee ...302
Cedartown .510	Louisiana.	Chadron ...109	South Carolina.	N. Fond du
Columbus ...426	Baton Rouge.532	Fairbury ...439	Charleston . 50	Lac395
Fitzgerald ...503	New Orleans. 37	Falls City .565	Columbia ...235	S. Kaukauna.311
	New Orleans.442	Grand Island.475	Florence ...424	Wyoming.
	Shreveport .323	North Platte.118	South Dakota.	Casper596
	Algiers206	Omaha 38	Huron496	Cheyenne ... 46
	Monroe590	New Hampshire.	Mobridge ...606	Evansston .309
		Concord245		Laramie 48
		Portsmouth .467		



**"I like the way Sweet-Orr Overalls
are made--they're Great!"**

They have an extra high apron or bib that gives complete protection. They are big, roomy overalls and fully cover the body. No cloth is skimped and no workmanship spared in their manufacture.

SWEET-ORR "Ace of Spades" Non-Shrinkable OVERALLS

Best of all, they stay the same in fullness and size and remain just as comfortable from the day you buy them to the day they wear out. That's because they do not shrink. All the shrink has been taken out by a special SWEET-ORR process. No matter how often you wash them, SWEET-ORR "Ace of Spades" will never shorten up—not even one-sixteenth of an inch. Try a pair and be sure they have the special label like those illustrated here. Union Made.



Sweet-Orr & Co. Inc.

*"43 Years in the Overall
business"*

**817-819 Broadway
NEW YORK**



By Insisting Upon Purchasing Union Stamp Shoes



You help better shoemaking conditions.
 You get better shoes for the money.
 You help your own labor position.
 You abolish child labor.

Do not be misled by retailers who say: "This shoe does not bear the union stamp, but is made under union conditions." This is false—no shoe is union made unless it bears the union stamp.

Boot and Shoe Workers' Union

246 SUMMER STREET, BOSTON, MASS.

JOHN F. TOBIN, President.

CHAS. L. BAINE, Sec.-Treas.

THE COMMERCIAL NATIONAL BANK

of KANSAS CITY, KANSAS.

CAPITAL AND SURPLUS, \$550,000.00.

DEPOSITS.....\$5,000,000.00

We cordially invite the Boiler Makers and Ship Builders of the United States who desire to transact banking business with us (which can be done readily by mail), to write to any of their officers and ask any questions they may desire to ask about our reliability and standing.

F. W. GOEBEL, President.
 A. C. FASENMYER, Vice-President.

C. L. BROKAW, Cashier.
 G. J. BISHOP, Asst. Cashier.

When Writing Advertisers

PLEASE MENTION

The Boiler Makers' Journal

Notice to Subscribers of the Journal

When members change their address, or do not receive Journal promptly, fill out the following blank and forward to the editor:

Name Reg. No. Lodge.....

Old Address, Street..... City State.....

New Address, Street..... City State.....

I have not received Journal for month of.....

KANSAS CITY, KAS., FEBRUARY, 1915.

THE BOILERMAKERS JOURNAL

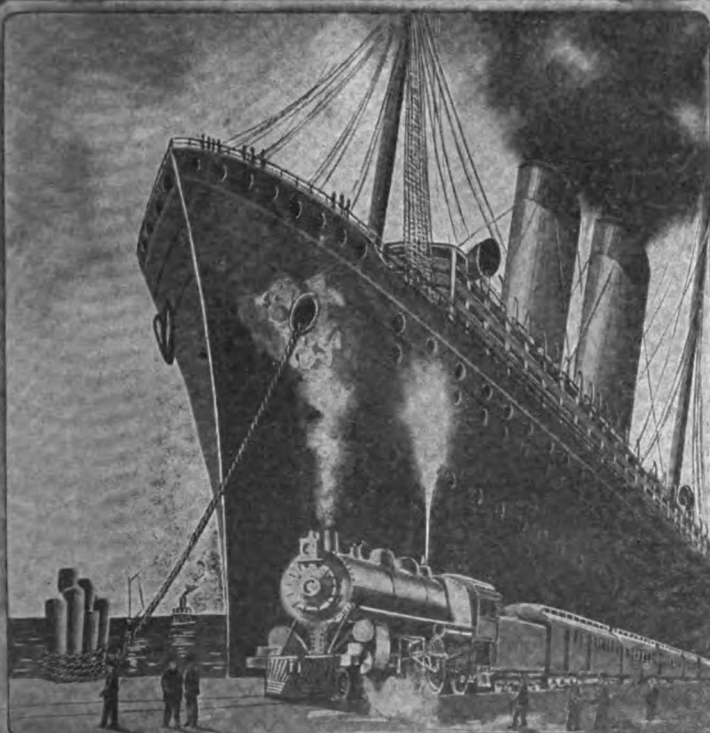

OFFICIAL ORGAN OF THE
INTERNATIONAL BROTHERHOOD
OF BOILERMAKERS, IRON SHIP BUILDERS
AND HELPERS OF AMERICA

"A smile of satisfaction with every pair"

HEADLIGHT UNION MADE OVERALLS



Unusually high cut waist comes two inches above band of trousers

Extra wide suspenders, guaranteed not to cut the shoulders or slip off

Wide, comfortable legs

Unusually big pockets

Scientifically constructed crotch, allowing perfect comfort for the body in any position

Larned Carter & Co. Detroit Mich

WORLDS GREATEST OVERALL MAKERS

Factories Detroit, Pt. Huron Mich. St. Louis Mo. Sarnia Ont.

SECURITY SECTIONAL ARCH

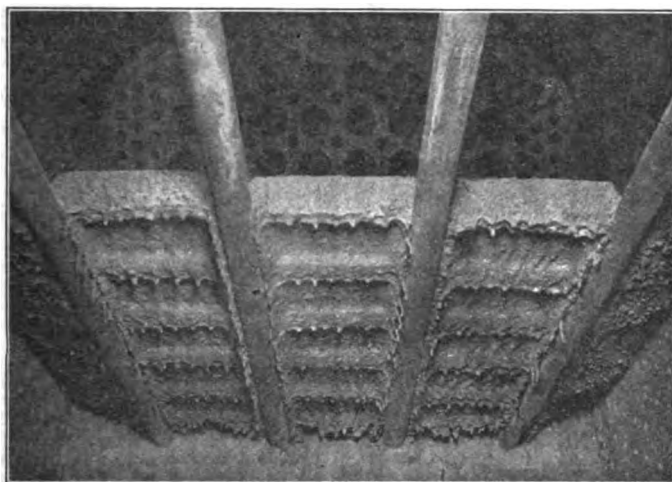

This arch is of light weight
It is built up of small sections
So made as to cool off quickly
It is easily removed for work
Made so to help the boilermaker

AMERICAN ARCH COMPANY

30 CHURCH STREET, NEW YORK

McCORMICK BUILDING, CHICAGO

You know OVERALLS,
Uniforms, Shirts, etc., are



if they have
this  mark
on the back of
the material on
the inside of the
garment.

*It's the cloth in the
garment that gives the
wear.*

Stifel's Indigo Cloth

Standard for over 75 years.

Its continuous use by three generations of the "men of the road," factory and field is certain proof of extraordinary quality. Stifel Indigo wears like leather. Every washing makes it like new.



This little mark is put on the back of the cloth on the inside of the garments for your protection.

Look for it before you buy.

Cloth manufactured by

J. L. STIFEL & SONS
Indigo Dyers and Printers

WHEELING, W. VA.

SALES OFFICES

NEW YORK.....260-262 Church Street
CHICAGO.....223 W. Jackson Boulevard
SAN FRANCISCO.....Postal Telegraph Building
ST. JOSEPH, MO.....Saxton Bank Building
ST. PAUL.....238 Endicott Building
TORONTO.....14 Manchester Building

Give Number of Articles Wanted in Left Hand Margin.

Give Price of Articles in Right Hand Margin in Figures.

Supply Blank

All Secretaries must keep duplicate of all orders on file in their Lodges.

Lodge No. Date.....191..

International Sec.-Treas. Boiler Makers, Iron Ship Builders and Helpers of America:

Please forward the below mentioned articles to

Cor. Sec.

Address.....

City.....State.....

Charter, each	\$2.00
District Charter	2.00
Seal, each	2.75
Ledger, 400 pages each.....	1.50
Ledger, 600 pages each.....	1.75
Minute Book, 400 pages each.....	1.00
Day Book or Journal, 400 pages each.....	1.00
Index Roll Book, each.....	.40
Rituals, each20
Punch, each	1.00
Constitutions, each 5c, or 50c per doz.	
Polish Constitutions, each 5c, or 50c per doz.	
Letterheads, per 100.....	.50
Envelopes, per 100.....	.40
1 Large Book Monthly Report Blanks.....	.75
1 Small Book Monthly Report Blanks.....	.40
Application Blanks, B. M. or H., per doz.....	.05
Clearance Cards, B. M. or H., each.....	.01
Receipt Books, Treas., each.....	.25
Order Books, R. S., each.....	.25
Receipt Books for Members, B. A. or F. S.....	.25
Rolled Gold Charm, each.....	1.75
Solid Gold Charm, each.....	8.00
Official Emblem Buttons, each.....	1.50
Official Emblem Buttons, in clubs of five or more, each	1.40
Delinquent Member's Notices, B. M. or H., doz.	.10
Withdrawal Cards, B. M. or H., each.....	.10
Official Ribbon Badges: 1 Badge, \$1.50; 2 or more, each net, \$1.00; 6 or more, each net, 75c; 12 or more, each net, 56c.	
Due Book, B. M., each.....	.10
Due Book, Helpers, each.....	.10
Duplicate Due Books, B. M. or H.....	.25
Labels, Supply Blanks, Grievance Blanks, Pedigree Blanks, Affidavit Blanks, Trial Blanks, Roster Blanks, Strike Rolls, Blank Bond Free.	
Member's Reinstatement Stamps, each.....	.50
Helper's Reinstatement Stamps, each.....	.50
Apprentice's Reinstatement Stamps, each.....	.50
Member's Monthly Due Stamps, each.....	1.00
Helper's Monthly Due Stamps, each.....	.60
Apprentice Monthly Due Stamps, each.....	.60
Member's Out-of-Work Stamps, each.....	.20
Helper's Out-of-Work Stamps, each.....	.10
Apprentice Out-of-Work Stamps, each.....	.10
Member's Initiation Stamps, each.....	1.00
Apprentice Initiation Stamps, each.....	.50
Helper's Initiation Stamps, each.....	.50
Ballot Boxes, each	1.25
Gavels, each25
Ballot Balls, White, Black, Per doz.....	.10

District Lodge.

100 Letter Heads.....	\$1.25	100 Envelopes.....	\$0.75
200 Letter Heads.....	2.25	200 Envelopes.....	1.50
300 Letter Heads.....	2.50	300 Envelopes.....	1.75
400 Letter Heads.....	2.75	400 Envelopes.....	2.00
500 Letter Heads.....	3.00	500 Envelopes.....	2.25
600 Letter Heads.....	3.25	600 Envelopes.....	2.50
District Due Stamps, 100 for.....	.25		
District Assessment Stamps, 100 for.....	.25		
Local Assessment Stamps, 100 for.....	.25		

When ordering, be sure to state plainly, Boiler Makers, Helpers or Apprentice, and mention what month Assessment Stamps wanted.

Secretaries will give full name and correct address and number of article wanted in left hand margin.

When ordering be sure to state plainly what month Assments are for.

No Supplies Sent Unless Cash Is Sent with the Order.

The Boilermakers' Journal

Official Organ of the
**International Brotherhood of Boilermakers
Iron Ship Builders and Helpers of America**

Vol. XXVII.

KANSAS CITY, KAS., FEBRUARY, 1915.

No. 2.

ADDRESS OF HON. W. B. WILSON,
SECRETARY OF THE DEPARTMENT
OF LABOR, BEFORE THE A. F. OF
L. CONVENTION AT PHILA-
DELPHIA.

Mr. President and Fellow Trades Unionists—Immediately following my talk to you at the Seattle convention I was severely criticised by such employers of labor as the president of the Founders' Association and by some metropolitan newspapers because I had addressed you as "Fellow Trades Unionists," and because of some other statements which I had made to you at that convention. I want to say to you now that I would not change one iota or tittle of the statements that I made to you then, from the salutation as "Fellow Trade Unionists" down through to the statement that every little property is a law-created and a law-protected title. And the same elements that criticised those statements asserted that the Secretary of Labor was partisan to labor.

It will be forty-three years on the 22d day of this month since I became a trade unionist, under our former great leader of the miners' movement, John Siney. In the time that has intervened I have been a member of the various trades unions as they succeeded each other among the miners of the United States, and am today a member of the United Mine Workers of America. During these forty-three years' experience, most of it active experience in the trade union movement, I have never understood that the trade union movement stood for anything else than justice to the wage workers. It has never desired to impose an injustice upon anybody else; and if the securing of justice to those who earn their bread in the sweat of their face constitutes partisanship, then count me as a partisan of labor.

The new Department of Labor, when instituted, was directed to utilize its energy for the promotion of the welfare of wage workers and their opportunities for profitable employment. In carrying out the purposes of the Department one of the first steps that we took was to communicate with the other departments of the Government, asking them to make arrangements by which the Department of Labor would

be notified of every contract let by them, in order that we might have available for the use of the public, trade unionists and non-unionists included, the information concerning the contracts that were let, and whether or not the eight-hour workday was applied.

We have concluded those arrangements and we are now receiving from the various departments of the Government statements relative to the contracts that are being let, and the conditions and terms under which they are let, and the sub-contractors working under them. In carrying through the eight-hour law, while it was pending in Congress, both in its consideration before the committee and its consideration upon the floor, we met with some obstacles, some difficulties that had to be overcome before an eight-hour bill could be enacted.

One of the first difficulties we met in dealing with the eight-hour workday from a general standpoint, as applying to all contracts for supplies for the Government, was the question as to whether it was intended by the eight-hour law to require the eight-hour workday to follow back all of the supplies purchased by the Government to the original point of producing the raw material. For instance, in purchasing supplies of foodstuffs for the army and navy, the question was asked whether it was the intention of the bill to apply the eight-hour workday to the men on the farm, many of them owning their own places, who raised the foodstuffs that were to be purchased. It was thoroughly understood by those who were handling the bill in behalf of labor, and those who were handling the bill on the floor of the house and in committees, that any bill which carried the eight-hour workday back to the farm and the farmer could not be enacted into law. And in that situation the proviso was inserted excluding from the operations of the eight-hour law those things which could be usually bought in the open market.

In interpreting that clause of the amended bill the position by those in charge of it was that the question of whether or not an article could be usually purchased in the open market was not a legal question; it was not a question of law; it was a question of fact, and the department letting the contract was the department authorized to pass upon the question of facts and not

the Department of Justice. The Department of Justice passes upon questions of law; the other departments pass upon questions of fact. And I may say to you here that in the debate upon that question it was clearly stated that dressed stone was an article that in the judgment of those in charge of the bill, could not be usually bought in the open market, and consequently came within the operations of the eight-hour law.

A statement has been made with reference to the Lincoln Memorial. Unfortunately for us and unfortunately for the labor movement the decision upon the Lincoln Memorial question was a decision involving a point of law and not a point of fact. And that decision grew out of this situation—that the bill authorizing the appropriation of two million dollars for the building of the Lincoln Memorial, and the actual appropriation of fifty thousand dollars of that amount to begin the work, was made seventeen months before the new eight-hour bill went into effect, and consequently comes under the provisions of the old eight-hour bill. That is the situation so far as it applies to the Lincoln Memorial, and it is an unfortunate situation for us.

In further carrying out the work of the Department we have inaugurated a system of mediation in trade disputes. Section 8 of the organic law of the Department provides that the Secretary of the Department may act as a mediator or he may appoint conciliators in trade disputes. During the year and a half, or a little more, that the Department has been in existence we have handled scores of trade disputes, and out of those scores there have been but three or four in which we have failed of success; there has been the Pere Marquette shopmen's strike, the Calumet miners' strike and the Colorado miners' strike. In those three we have not succeeded in bringing about a satisfactory adjustment of the difficulty. In all of the others, some of them involving many more men than were involved in either of these three strikes, we have succeeded in bringing about an adjustment that was satisfactory to all parties concerned, thereby promoting industrial peace, and at the same time promoting the welfare of the wage workers.

We have taken the ground, and we think justly, that employers and employes have a mutual interest in securing the largest possible production with a given amount of labor; the larger the amount that is produced, the larger the amount that is available for distribution; that their interests only diverge when it comes to a determination of the share that should go to each and the methods under which the material should be produced. As their interests only diverge at those points, it is the proper thing for employers and employes alike to sit down around the council table and work out the problems they have to deal

with on as nearly a correct mathematical basis as possible.

Working from that theory of the mutual interest that each has in production, we have proceeded to the consideration of these problems. And again, Mr. President, we have been criticized as being partisans, upon the theory that the Department of Labor in acting as a mediator performs judicial functions. Now, the Department of Labor, in acting as a mediator, does not perform any judicial functions; what it performs are diplomatic functions, and there is no more reason that the Department of Labor should be debarred from handling trade disputes upon a diplomatic basis because it is interested in the welfare of the workers, than that the Department of State should be debarred from handling international disputes because of the fact that it is a part of the Federal Government and interested in the welfare of the United States.

What we need, in handling trade disputes, and what we have attempted to select in handling trade disputes, is men who have had experience and who are levelheaded and understand the technicalities of the subject-matter they are to deal with. You cannot take a man who has had no experience, you cannot take a man who knows nothing about a trade, no matter how big he is, and inject him into the negotiations for the settlement of a trade dispute and expect to get beneficial results from his injection into it. You must take men who have had practical experience.

And so, in carrying out the work of the Department, we have invariably selected one man who had a technical knowledge of the affairs, as seen from the standpoint of the worker; and we select one who had a technical experience and a knowledge of the standpoint of the employers, and we have sent those two men into the trade dispute conditions with instructions to endeavor to bring about a settlement of the difficulty upon a basis that would be just to all parties concerned; because, after all, while we desire industrial peace, while we want industrial peace, and we want it permanently, we realize that there can be no permanent industrial peace that is not based upon industrial justice.

And so we have gone on with this line of work, and, as I have said, in nearly every instance we have been successful. And those instances where we have been unsuccessful have been principally due to that class of employers, extremists, a class becoming smaller and smaller as the years go by, who look upon their employes as simply a part of the machinery of their establishments; to be treated in exactly the same way as they would treat other machines, with this difference; that the inanimate machine in their shop is so constructed and so standardized that they can calculate with almost mathematical accuracy what the working strain and what the breaking

strain of the machine is; and they know that if they crowd the machine up to the breaking strain, and it does break, it will cost them something to replace the machine. Not so with the human being that is employed by them, and that they look upon as a machine. He is not standardized, he is not uniform in his physical and mental equipment; there has been no method determined by which you can calculate the breaking strain or the working strain of a human being. Even the worker himself does not know what his own breaking strain is, and if you crowd that human machine up to the breaking strain, and it does break, then it costs the employer nothing to replace it.

We have held throughout that the human being is an entirely different thing from the machine, and should be treated entirely different from the manner in which you treat the machine. The human being who is employed in the plant is a living, moving, sentient being like themselves, with all the hopes and all the aspirations that God has implanted in the human breast, and is entitled to the same consideration as you would give to any other human being who is not engaged as a wage worker.

During the year we have made at least one great step forward in the passage of the Clayton anti-trust bill, which is also an anti-injunction bill. To my mind it is the greatest step that has been taken by labor and for labor within the past two generations. Since 1878 our courts have been issuing injunctions in trade disputes. These injunctions are based upon the theory that some one has a property right in the labor of an employe. Any lawyer will tell you that the writ of injunction is a writ that issues from an equity court only, and they will also tell you that an equity court deals with property and property rights; and when an injunction is issued restraining Jim from interfering with John, because the interference with John will affect John's employer, it can only be upon the theory that the employer has a property right in the labor of John. Now, the employer cannot have a property right in the labor of John without having a property right in John himself, because labor, as you have so often declared, is a part of man, it is inseparable from him. The moment labor is applied and something results from the application of that labor, the material that results from the application of it is property, it is a commodity, it can be treated as such, but the labor that produces it is a part of the man himself. You cannot have a property right in the labor of the man without having a property right in the man, and a property right in man is contrary to the spirit of our institutions.

And so the Clayton anti-trust anti-injunction bill declares that the labor of a human being is not a commodity of an article of commerce. If that statement alone were all that was in the bill it would still be a big

step forward; but that statement is only an interpretation, it is only a means of backing up and making valid the other items in the anti-trust bill relative to the issuance of injunctions. And so labor is now placed in the position that it ought to occupy in that respect, where it is recognized as being a part and parcel of the community instead of being classed as a "brother to the insensible clod that the rude swain turns with his share and treads upon."

We have all along recognized that the employers own the land, that they own the plants, that they own the machines; but we have positively denied, continuously denied, that they own the men, and for the first time in the history of this or any other country we have that idea embodied in legislation—that labor is no longer a commodity or article of commerce, and cannot be any longer considered as such.

So we are making progress, step by step, slowly, it is true, because large bodies move slowly. It has been a gradual evolution. The change from the feudal system to the present system and the removal of those ideas, the removal of those lines of thought that grew out of the feudal system itself, has been a slow process that has only been brought about as a result of the militant organizations of labor.

It is said that the Department of Labor has to deal with others than organized labor; that it represents other workers than organized workers, and that is true. The Department of Labor represents and looks after the interests of all the wage workers of our country whether organized or unorganized. The same may be said of every trade union in our country. There isn't a trade union in existence in trade or industry that has made progress that has not, in making that progress, also benefited every man working in the industry who is not a trade unionist. So far as the Department of Labor is concerned, it will utilize every force that it finds available to its hands for the purpose of promoting the welfare of those who toil. It will use most those agencies which are most effective; and, in my experience, those agencies which have been most effective in improving the conditions of the wage workers have been the trade unions of this country. I thank you.

**ADDRESS OF FRATERNAL DELEGATE
FROM THE CANADIAN TRADES AND
LABOR BEFORE THE A. F. OF L.
CONVENTION.**

Fraternal Delegate Rigg: Mr. Chairman and Delegates to the Thirty-fourth Annual Convention of the American Federation of Labor—I want to express to you the deep sense of honor with which I regard the privilege of my attendance at this convention as a representative of the Dominion Trades and Labor Congress. Although divided from you by a boundary line, which on

the other side of it we invariably refer to as the "imaginary line," the Canadian trade union movement is cognizant of an indissoluble association with the American Federation of Labor; and every delegate elected to fraternally represent that congress in the conventions of this great body esteems it a great privilege and a high honor to be selected for such a position. When President Gompers attached to my coat yesterday morning the badge of this convention I felt as though I had been privileged to receive a great and honorable distinction—proud to wear it, proud to be privileged to meet you in this convention.

This convention is an important gathering, charged with the responsible duty of protecting and promoting the interests of the great mass of the organized wage earners of this North American continent. I come to you today as the bearer of a gift which, from the point of view of the great possibilities that are wrapped up in the trade union movement of this continent I deem a great deal more precious than a gift of frankincense and myrrh. I come to you bearing the gift of the brotherly spirit of the entire trade union movement of the Dominion of Canada. North of latitude 49 degrees, the trade union movement has no feeling that the geographical lines of demarcation can separate it from the bond of fellowship and brotherhood with the trade-union organizations south of that line.

Perhaps it is necessary for me to say something with regard to the reason for the existence of an organization north of that line, which is separate from and independent of the American Federation of Labor. I should feel that I had failed absolutely in the performance of my mission here today if I did not succeed in impressing upon your minds, those of you who may not be familiar with the reasons of the existence of the Trades and Labor Congress of Canada, that the reason I am here in an ambassadorial capacity is not due to any weakness of the bond that binds the trade unionists of Canada with the trade unionists of the United States. The badge that I wear, the membership that I carry, is that of the International Brotherhood of Bookbinders, an international organization that I have in the past had the pleasure of representing in a full delegate capacity.

And what is true in my own case is true concerning every member affiliated with the Trades and Labor Congress, with the exception of just a few organizations of wage earners for whom there exists no international organization. I think you all see that the Trades and Labor Congress is not organized as a rival institution to this great American Federation of Labor. As trade unionists organized along industrial lines, we are a component, integral part of this body, and that institution is so highly valued and prized by the trade unionists of the Dominion of Canada that we are jealous that nothing shall come between us to

separate the Canadian trade-unionist movement from the trade-union movement of this entire North American continent. This is an inheritance, this association, of which we are proud and which we will maintain with all our zeal.

The Canadian Trades and Labor Congress exists solely by virtue of that accident of fate which caused Canada to be governed separately from the rest of this North American continent. In this city of Philadelphia one cannot help being made aware of that tragic result of 1776, whereby through the folly, through the autocracy, through the injustice which the British Government of that day sought to impose upon the colonists of this country, impositions which could not be borne by self-respecting men and women, the break came, and a separate nation was established on this continent. While that has been the cause of separating the United States from Canada, there are many causes, there are many results, rather, which today makes us feel and understand that, so far as the establishment on this continent of another nation is concerned, the results, so far as the great ambitions and purposes of working class freedom are concerned, have never been impaired thereby; but that the declarations which are embodied in your Constitution have made for the promotion of a spirit of democracy, to such a degree that it has been a valuable contribution to the development and upbuilding of democratic institutions throughout the world.

The condition of affairs that separates Canada along governmental lines from the United States makes it imperative that there shall exist an organization north of that imaginary boundary line of a strictly Canadian character, an organization whose function is to protect the wage earners along legislative lines. This is the sole reason for the existence of the Trades and Labor Congress of Canada, which is the legislative mouthpiece of the workers of that country. Matters that affect the jurisdiction of trade unions or the control of trade unions along industrial lines do not come within the province of our congress. This is the place where all these matters legitimately belong, and where, so far as the Congress of Canada is concerned, they will be permitted to belong. We have no desire whatever to invade the scope of the operations of the American Federation of Labor.

The Dominion Trades and Labor Congress is pledged very specifically to the recognition of a principle which is, and has been for the past few years, at least, embodied in the constitution of the American Federation of Labor; that principle which was enunciated by Chairman O'Connell on Monday morning has been the principle that, in spite of the bigness of this North American continent, it is much too small to harbor the existence of two separate organizations for trade-union purposes in the one craft. And the very strictest adherence is practiced by the Congress of Canada to this

vital principle, that there shall not be more than one organization for the one craft.

The practice of the Congress during the last few years has abundantly evidenced, I think, the sincerity of that organization with regard to this matter. Some two years ago, when this Federation very definitely and specifically and finally disposed of the long-standing struggle which had been taking place between the Amalgamated Society of Carpenters and the United Brotherhood of Carpenters, the Trades and Labor Congress very quickly decided what its attitude would be. When the Amalgamated Carpenters had been expelled from the Federation they were just as promptly expelled from the Trades and Labor Congress. Immediately upon action having been taken by this Federation the Executive Council of the Trades and Labor Congress returned the per capita tax of the Amalgamated Carpenters when it was next offered; and that action was unanimously approved by the delegates at the succeeding convention, with the result that the Amalgamated Carpenters, who were very largely represented in the Dominion of Canada, recognized the necessity of throwing down the weapons of their warfare and linking themselves with the United Brotherhood of Carpenters and Joiners.

In another and more recent instance, that of the Electrical Workers, the same action was automatically taken by the Trades and Labor Congress; and it was one of the proud moments of our convention in St. Johns, N. B., that, so far as the Canadian District Council of the Reid-Murphy Electrical Workers were concerned, in a referendum vote then being taken the sentiment was going overwhelmingly in favor of uniting with the organization affiliated with the American Federation of Labor. And since the holding of our convention in St. John, N. B., in September of this year, that great work of unity has also been consummated and another strike of years has been ended.

This attitude of loyalty to internationalism, while adhered to most closely by the Congress, is still a practice which is most repugnant to the great mass of the employers of Canada. With much warring of words, with much flying of flags, and with a great deal of fervent patriotic pleading the employers of the Dominion of Canada tell us that it is unpatriotic and un-Canadian for us to send our good Canadian money south of the line to the headquarters of organizations located in the United States. They tell us it is a serious breach of the principle of self-respect for us not to have our own Canadian trade unions organized and controlled solely along national lines. In the last convention of the Congress, as you have just heard in the report of your fraternal delegate, the spirit of internationalism received just about the most severe test it could possibly have received, and came out unanimously triumphant so far

as the expression of the mind of the Congress is concerned.

We had in that convention Bro. Frank Farrington, of the United Mine Workers of America, and the Hon. Mr. Crothers, Minister of Labor, a position that carries with it a cabinet portfolio. During the last session of the Canadian House of Commons discussions took place relative to the barbaric and czar-like attitude of the government toward the striking coal miners on Vancouver Island; and the same minister of the British Crown in making his defense in connection with that strike, explaining the lethargy and the indifference of his department to the welfare of the miners who were in that great struggle, referred to Bro. Frank Farrington as a foreign agitator. And again, after he had been accused of this deed, in his defense before the Canadian Trades and Labor Congress, he carried with him the "Journal of the United Mine Workers of America," and turning over the pages he called the representatives of trades unionism in the Dominion of Canada to witness that the same Frank Farrington had, while he was in charge of the United Mine Workers' strike of Vancouver Island, repeatedly made reports to his international headquarters, which were addressed to the United Mine Workers of the United States, if you please. He said the term "America," being limited so far as its application is concerned, in the mind of the Minister of Labor and in the minds of multitudes more, as applicable only to the United States. As far as the workers of this continent are concerned it has no limitations, the great mass of the wage earners of this North American Continent are indissolubly joined together, and when we talk of the United Mine Workers of America we mean the United Mine Workers of the North American Continent. If any doubt now exists in the mind of the Minister of Labor with regard to the standing of the Canadian trade union movement on this matter in the future it will be solely due to his utter incapacity to receive any mental impression whatever.

The Congress of Canada stands foursquare for the principle of international trade unionism, and the sophistries, the subtle, deceptive influences which employers of labor and ruling bodies bring to bear upon us in an endeavor to separate us in order that they may fleece and exploit us more effectively. We have noticed that so far as the patriotic Canadian employer is concerned, his patriotism evaporates when it comes to a matter of a strike. Then he himself is very eager and very glad to fall back upon an appeal to these organizations of strike-breaking thugs which are recruited in this country for the purpose of beating into subjection the workers of the United States and Canada when they seek to promote their own interests.

But a new spirit of patriotism has been awakened in the minds and has stirred in the hearts of the trade-union movement of

this century, a spirit of patriotism based upon the fact of the common interests of the wage earners of the world. And while we regret exceedingly that the spirit has not been sufficiently developed yet to have averted that murderous carnage that is taking place on the fields of Europe, we are sure of one thing, and that is that the spirit of brotherhood which has been generated on this continent by virtue of the practice of international trade unionism is such as to make it a safe prediction that the workers of the United States and the workers of Canada will never consent, either by secret diplomacy or by any other means, to fly at each other's throats or spill each others' blood.

For more than one hundred years peace has existed between Canada and the United States. Four thousand miles of frontier are unguarded by any fort, and, so far as the democracy represented by our trade-union movement is concerned, there will never be a fort erected on that frontier line to menace and jeopardize those peaceful relations which exist today. I am not here to talk to you about the European war; I respect too much those obligations which are imposed upon me as the guest of the American Federation of Labor, and as one who temporarily finds himself in a neutral country, because Canada, as a component part of the British Empire is today in a state of war.

I am not going to discuss the war in any of its phases, but I do want to say just this word—and I think you will pardon me for the saying of it, I think I ought to say it—that coming from Canada and knowing that there are present in this convention, two well-known representatives of the British Trade Union Congress, I think I speak that which the Canadian Trades and Labor Congress would have me speak, and that I also voice the sentiment of our British brothers when I say that it is the fervent hope and desire of our hearts that this bloody conflict should be brought to a speedy termination and those international relations fostered by our movement again be established and promoted.

There has been a very remarkable movement in recent years owing to the sympathetic relations existing between the Congress and this Federation. Some forty-six international organizations have affiliated their entire Canadian membership with the Congress and pay their per capita tax from headquarters. This has been done because of the recognition of the principle that the Trades and Labor Congress of Canada seeks to preserve and advance the interests of the wage earners of Canada along legislative lines, which it would be practically impossible for the American Federation of Labor to do.

One of the great problems with which the workers of Canada are confronted is that of immigration. For years the Government has fostered every means of attracting labor

to Canada, with a complete and fatal disregard of the ultimate consequences. Immigration agencies operating on the bonus principle have carried on a vigorous trade. Employers' organizations have taken advantage of the situation and have most grossly misrepresented conditions that exist in that country; and, because of that great benevolent heart of theirs which seeks to attract the oppressed of Europe and give them a larger and freer life in Canada—that is the language of the Canadian employers when they are seeking to deluge the country with surplus labor—these workers have been imported into Canada with an utter disregard of what is likely to take place.

So far as the Trades and Labor Congress is concerned we have no objection to leaving our doors open to the toilers of Europe so long as they seek to come in along natural lines; but we have set our face like flint against the unscrupulous method adopted to artificially foster and promote immigration to Canada. This reckless policy of immigration, coupled with the merciless exploitation of those same workers when they reach Canada, and the mad spirit of land speculation has precipitated a condition of affairs industrially and commercially in Canada which makes sober-minded men and women afraid for what may happen in the near future. And this condition has been considerably intensified as a result of the war. Today we have throughout Canada a great mass of the unemployed for whom there are no bright prospects for this winter and for whose welfare every man and woman who is at all touched with the sentiment of human sympathy is deeply concerned. There is going to be a great deal of suffering in the Dominion of Canada, among the wage-earning class during this coming winter. In normal times during past years Canada has not exhibited those extreme symptoms of social disease which are so very manifest in the older and more thoroughly developed industrial nations.

Fraternal Delegate Riggs gave a brief review of the history and development of Canada in the past one hundred years, the increase in her population and in her manufacturing and agricultural development, and continued:

Canada's future development, it is easily seen from what I have told you, in spite of her rich agricultural resources, will be very largely along industrial lines, and it is extremely important that at the present stage an ample and an enduring foundation should be provided and maintained in connection with our trade union organizations. Now is the time, while our industries are young, while our wage-earning population is comparatively small, to cultivate in the minds of the workers those great principles which underlie and are vital to the welfare of the labor movement.

Recently I received a letter signed by

three international organizers, Brother Potts, of the Carpenters; Brother Hunter, of the Painters, and Brother McClellan, of the Machinists, in regard to the industrial condition in the maritime provinces in Eastern Canada. The call there is for international organizers to establish firmly the foundations of our trade union organizations, and at the same time to uproot and destroy forever an organization which has for a number of years had a disturbing and irritating affect upon the trade union movement of Canada. This Canadian Federation of Labor, as it is called, is cursed with the benediction of certain Canadian employers and seeks to rival your organization so far as Canada is concerned, can be very easily uprooted and destroyed in the maritime provinces if only the necessary attention is paid to that locality.

Fraternal Delegate Riggs spoke in an interesting manner of the general conditions of the labor movement, of the spirit and ideals and hopes and ambitions of the Canadian Trades and Labor Congress. He referred to the legislative matters in which the Congress was deeply interested, both in the Dominion Parliament and in the Provincial Parliaments, and at the attitude of the Government toward labor measures.

In concluding Fraternal Delegate Riggs said: We talk a great deal today about the progress that we have achieved in recent years; we tell of the wonderful accomplishments of genius; we speak of the tremendous power which has been exercised by humankind in the wrestle with Mother Nature until she has yielded her great secret. We are fond of speaking about how we have harnessed the forces of nature and made them the obedient servants of man. But I want for a few brief minutes to call your attention to another aspect of the situation. What about this wonderful progress we are making and have made in the past few years from the point of view of the unemployed. Unemployment is rampant and its effects upon our humanity are of a most disastrous and degrading character. I am told that in this country 1 per cent of the people own more wealth than the remaining 99 per cent. An ex-member of the Crown in the Dominion of Canada made the statement two years ago in the Dominion House that twenty-three men controlled the finances of Canada. With our great machinery for wealth production today, with our huge units of capital, with our specialization of labor, we have invented a wealth producing system which put to shame all the fabulous activities of ancient geni. And this has produced a crisis in our social system which has given us a multi-millionaire at one end of the scale, to whom wealth flows whether he sleeps or dissipates it, and the toiler who toils from early childhood until he falls into the grave, keeping company with poverty all the way, at the other end of the scale. What shall we say of the progress of our day from the

point of view of the sweated toilers, of the child slave or of the white slave, that modern product of which Victor Hugo speaks as bartering away a soul for a bit of bread.

These are the problems which challenge us, they demand our attention, they will insist upon forcing themselves before us for solution. And we are the men and women to face these problems, to find that solution. The great spirit and ambition and ideal of our labor movement must be to create a newer world wherein dwelleth righteousness; that no child shall cry for bread; that no mind shall be stunted by ignorance; that no maiden shall sell herself in order that she may secure food for her body; that mothers shall be protected from the incessant care and worry and heartbreak incidental to the life of the poor; where manhood shall be vigorous, healthy, intelligent, noble—these are the ideals for our labor movement in this twentieth century. The great ambition that must permeate us is that oppression of every species shall be dethroned and the good of the common people shall be conserved.

I have endeavored to indicate to you the relation of our Congress to this Federation of Labor, to tell you something of its activities, to show to you the spirit that inspires it. And now I want to say that the twentieth century belongs to the labor movement; that it calls to you and to me, not merely that we shall be trade unionists and wear our buttons and maintain those outward forms of association in our movement which consist of keeping our names on the register, attending meetings and all that kind of thing. These are but the forms of the spirit of our unionism. The true spirit demands from us that we shall go forth to meet the pressing problem that confront us today, and instead of merely giving of our money we shall give of ourselves; that we shall hear this appeal of the great mass of the community for enlightenment and emancipation, for salvation, if you please, and that we shall dedicate to this movement more and more as the spirit attaches itself to us our life, our time and our energy, our life blood, if you will, in order that there may be a dawn of a day in the not very distant future when there shall be given to every man, woman and child an opportunity to realize a full-orbed life, rounded and entire; where there shall be opened to the members of the working class those avenues which enrich and ennoble human life; that art and science and literature and music may be more diversified in the experience and the possession of the working class; that a new day shall dawn where burdens shall be lifted, where hope and comfort and joy and happiness shall take the place of sorrow and ignorance and crime.

Again I say to you that I am proud to bring to you today the fraternal greetings of the trades unionists north of parallel 49 degrees latitude, and to assure you, if such

assurance should be necessary, that, so far as the future is concerned, we will see to it as in us best may be that nothing shall come to separate us from our cherished association and affiliation with the international trade union movement of this North American continent.

THE VOLUNTARY NATURE OF THE LABOR MOVEMENT.

(By Samuel Gompers)

Mr. President, Officers and Delegates of the Building Trades Department: My presence with you this morning is a bit belated, but you who were in attendance at the convention of the American Federation of Labor will know that at the close of that convention I had about reached my vocal limit, and it was necessary to repair the pipe organ of expression before I could come here. Although I was not in the convention I was in the ante-room and heard much of the discussion of your first day and part of your second day's proceedings. I have come in contact with a number of the delegates to this convention individually and I am exceedingly pleased, more pleased than I can find words to express to you, at what I regard as one of the most satisfactory situations that have come under my observation in, lo, these many years. I shall refer to that perhaps a little later on. First, I want to extend to you the felicitations of the A. F. of L. in its entirety, as well as that of the delegates to the Federation, and as well, I believe, the feelings of the great rank and file of the organized labor movement which we have the honor jointly to represent.

I shall not take up much of your time, because I realize that time is exceedingly valuable to you, as it is to me, and that you want to conclude your business at the earliest possible moment. The work of the A. F. of L. convention, closed last Saturday at midnight, was of the most tremendous importance and significance. The horizon of the work of the labor movement has been clearer and higher and better and will go farther to cement the bonds of unity and fraternity among the organized working people of America, and to bring hope and encouragement even to the unorganized toilers who have not yet had the opportunity or conceived it to be their duty to join hands with us and make common cause for the protection and promotion of the common interests of the masses of Labor.

Quite apart from the work for external activities, or activity upon external matters and affairs of an economic, of a material, of an industrial, of a political, of a social and of a moral force, we have done some work in the convention of the A. F. of L. of governing our internal affairs and our internal relations which I am confident will not only be of far reaching consequence, importance, and benefit to the toiling masses of our movement, but has already accomplished a

great advance and brought much benefit.

I have already said that I heard part of your deliberations and have come in contact with some of the delegates to this convention; and I am confident that from your collective action in this convention and of the individual demonstration and feeling of sentiment of the delegates in and outside of the convention, much good has already been accomplished. Within this past few days I have seen men fraternize and shake hands and talk as though they were old time friends, and they are men who for several years turned their backs upon each other, or else hissed hateful and hating words to each other; men who have walked upon the other side, though organized in the same labor movement. I refer, of course, as you know, to the action of the A. F. of L. in the endeavor to bring about a better state of affairs in the relation of the various Departments in the A. F. of L. and the relation of the unions to the Departments, and the Departments themselves. I know, Mr. President, that it is a seemingly disagreeable position when we have power, or imagine that we have the power, and it is not always exercised. But my experience in the labor movement, as well as my study and observation of all affairs of man, is that it is a good thing to have power—that power is essential to the well-being of all organized labor movements; but the limitations of power set upon ourselves by ourselves, the exercising of power with moderation is to bring the greatest potentiality to the exercise of whatever power we have.

We find autocratic governments of the world in which power and absolute power is vested, and yet let at any time the autocratic power be exercised to such an extent as will outrage the sense of those governed and even autocracies are overturned. There is in the human breast a willingness to do the right thing. There is in the makeup of man that feature—and thank goodness it is implanted there—that when men feel there is a power attempted to be exercised over them, that compulsion, that coercion attempted upon them, a feeling of repugnance and resentment arises, and as a result we find that when asked within reason to do anything, when they are asked and persuaded that thus and so are the right courses to pursue, they will gladly yield in most instances. But you tell a man to do the same thing and accompany the command with the coercive threat, and say, "Unless you do thus and so we will mete out to you a punishment that will directly affect you and yours," the likelihood is that he and his associates will and the very earliest opportunity not only to resent it, but to follow the course directly opposed.

Let me say to you in all candor—I have said it upon occasions, not in public, I think, but this is an open meeting and I am willing to say it now in public—that for more than a year and up to the close of the convention of the A. F. of L. I have grave

misgivings as to the fate of our organized labor movement. You know that I have been associated with the organized labor movement for more than forty years; you know that I was one of those who participated in the convention which formed the A. F. of L. in Pittsburgh in 1881. You know, I think, that I may say without any appearance of vanity or vainglory, that I have been a strong and staunch adherent of the A. F. of L., and that I have tried to give some service to it; that I have tried to help in the organized labor movement, to extend its growth and its power and its influence, and that if any men had faith in its growth and permanency that I was one among them.

But I say to you again that with the tension that has grown up there was something sure to break. The alternative was presented that we would come to the point where our Departments and our international unions would be guaranteed their rightful position in the labor movement; that the international unions, the fundamental sovereigns and sovereignties of the organized labor movement, both in the Departments and the Federation itself, were to be guaranteed their rights, or else as sure as the sun rose and set the fate of the A. F. of L. would be sealed.

And, as I say, I almost despaired, and that opinion was shared with me by the active men in the labor movement of our country. Believe me when I say that the proposition changing and modifying the laws of the Departments and their relations to the international unions and the A. F. of L. were not the result of hasty, ill-considered action. Month after month, aye, for years, this question was in the minds of our men, and hour after hour of the meetings of the Executive Council of the A. F. of L. was devoted to discussion and thought of this matter. Conferences were held with the representatives of the Departments, conferences with the representatives of the international unions, all of them with the purpose of impregnating the minds of us all with the idea that there must be some easing up.

The E. C. of the A. F. of L. during the past year selected a committee composed of Brother James Duncan, Secretary Morrison and myself. We gave day after day to the consideration of the subject, then reported to the E. C. of the A. F. of L., and the matter as considered and proposed by the Council was reported to our Philadelphia Convention. In the convention it was referred to a committee and the report, modified by experience and immediate needs, was adopted by unanimous vote of the convention. I am glad, Mr. President, glad beyond expression and words, to be informed that your convention adopted, by unanimous vote, the proposition of Article XV of the constitution of the A. F. of L. relating to the Department. It does you credit as union men, as intelligent union men, as men who have the understanding of the responsibil-

ties resting upon them and of the great future in store for your Department and for our movement generally.

Let me say this: that I have no more doubt now of the permanency of the Department; I have no more doubt now of the permanency and the perpetuity and the constant growth and success of the Departments of our Federation than I have a doubt of the universality of mankind. I haven't the slightest doubt in expressing the thought that under the new conditions the organization of the United Brotherhood of Carpenters and Joiners will, in the very near future, reaffiliate where it rightfully belongs—in the Building Trades Department; I haven't the slightest doubt that under the new declaration of purposes and laws governing the A. F. of L., organizations of labor bona fide in character that should be with our movement, will soon be knocking at our doors. I feel confident that, as Philadelphia conventions of our Federation, first in Donaldson Hall and second in Independence Hall, each witnessed a growth in the development and expression of the American labor movement, so will the recent convention of the A. F. of L., and the convention of this Building Trades Department mark a new era of growth and development and power for the benefit and advantage, not only of our movement, but of every man and woman who toils, and will bring hope and comfort to the children of our time.

I said at the outset that I would not take up much of your time. Perhaps I have already trespassed beyond what I should have done, but I desire to say to you, Mr. President and gentlemen, from the bottom of my heart I extend congratulations to you upon the splendid position you have taken and the new relations of amity and good will which have been brought about, and for the future of your sessions that the same harmony will prevail. There will be a clash of opinion and judgment, but there will be no longer that clash of feeling among the men who ought to be brothers in this great uplift work.

Your officers know, and I am very glad so to testify, that during the year that is between conventions we meet frequently as much as twice a week. That does not occur always, but we have practically joint E. C. meetings, we have conference meetings, and there go over the interests which affect the working people of our country and our times. And these conferences are of great advantage. I shall want to enjoy the privilege, at least for this coming year, to meet with the officers and representatives of your Department as well as other Departments. We shall try to work out a law or a bill governing the hours of labor as affecting the government employes and those who do work for government through contractors and sub-contractors; and inasmuch as we have had the experience of misinterpretation of eight-hour laws in the past, interpre-

tations by attorneys-general who, by the aid of the most improved microscope found a comma in the wrong place and thereby gave the narrowest interpretation of the eight-hour law because of the comma rather than the broad interpretation of the law, we propose to co-operate with your officers, and they with us, to see whether we can not get an interpretation of the eight-hour law as it was designed, as we know it was really meant to be; or, if we can not, we are going to see if we can not get a bill enacted into law that shall mean eight hours, as the present law was intended by its designers and promoters.

And we shall do everything in our power without stint and without limit to try to bring about a greater growth of our labor movement, even a greater respect for it than is now entertained, and a greater confidence in it and a greater hope for it and its purposes. And in that work I am sure we shall be able to count upon the support, the active, enthusiastic support, of not only the officers of our international unions and not only the delegates to this convention, but the union man at home working at his trade or calling who realizes the benefit and advantage that the organized labor movement has been to him and his, and upon whom, after all, the success and the permanency of our movement depends, to bring home the cheering words of encouragement and hope to our fellow-workers and fellow-citizens, which is the mission of the delegates to this convention.

And as we are going from our convention to our homes, in behalf of the A. F. of L. and its great rank and file, I thank you for the courtesy of your attention, and wish you permanent, constant, growing success and power, and with it the wisdom with which that power shall be used in the interest of our common humanity.

TO PREVENT UNEMPLOYMENT.

Regularization of industry, establishment of public employment exchanges, systematic distribution of public work, prevention or absorption of surplus labor, unemployment insurance, and constructive care of the unemployable, are the six steps proposed in a practical program for the prevention of unemployment just issued in a twenty page report by Dr. John B. Andrews, secretary of the American Association on Unemployment, from the association's headquarters at 131 East 23d St., New York.

"The time is past," says Dr. Andrews, "when the problem of unemployment could be disposed of either by ignoring it, as was the practice until recent years in America, or by attributing it to mere laziness and inefficiency. We are beginning to recognize that the causes of unemployment are not so much individual and due to the shiftlessness of 'won't works' as social and inherent in our present method of industrial organization."

Employers, employes and the public as consumers, it is pointed out, all have a duty in helping to regularize industry. By establishing employment departments in their plants, planning output ahead, offering inducements for slack season trade and in other ways employers are urged to do what they can to make every job a steady job. At the same time employes are advised to encourage adjustments through short-time and overtime agreements rather than by discharge of part of the force, while discouraging excessive overtime by a demand for double pay for such work. "The slogan of the consumer should become 'shop regularly!'" says the program, in deprecating irregular and capricious purchasing.

Public employment exchanges are advanced as a matter of business organization and not of philanthropy. Both municipal and state exchanges are advocated, supplemented by a federal bureau of employment to secure similarity of operation and of information throughout the country. Neutrality in labor disputes is made a cardinal principle for all exchanges.

"Public work," says the program, "should be made to act as a sponge absorbing the reserves of labor in bad years and slack seasons and setting them free again when the demand for them increases again in private business." Successful operation of public works in several countries is cited.

Limitations on child labor, thorough industrial training, a revival of agriculture and country life, and a constructive policy of regulating and distributing immigration, are coupled with the regulation of working hours of adults as possible steps in preventing or absorbing the surplus of labor which intensifies the unemployment problem in large industrial centers.

For those who nevertheless are unemployed although able and willing to work, it is proposed that unemployment insurance such as is in operation in England since 1913 be established in America also. Out-of-work benefits by trade unions, either assisted or not assisted by public contributions, and a national system of public employment insurance, are suggested as possible methods. All have found successful application in various countries.

When all these steps have been taken, it is pointed out, there still remains the problem of the unemployable, including those who are sick, aged, inefficient, feeble-minded, or semi-criminal, as well as those who refuse to work. To these different groups it is proposed to give varied constructive care, aiming wherever possible at their early restoration to normal working life and independence.

The general scheme of economic reconstruction and organization outlined will, its backers believe, lead to conspicuous and permanent improvement. The plan is being widely circulated for criticism and suggestions.

THE BOILER MAKERS' JOURNAL

Official Organ of the International Brotherhood of Boiler Makers, Iron Ship Builders and Helpers of America.

A Monthly Publication Issued the First of Each Month from Room 3, Law Building, Kansas City, Kansas.

JAMES B. CASEY, Editor and Manager.

Subscription Price.....\$1.00 Per Year in Advance

ADVERTISEMENTS.

Advertising Rates Will be Furnished Upon Application to ..the Editor-Manager. No Reading Space Will be Sold for Advertising Purposes Under Any Circumstances.

All New Members Must Have Their Name and Address Sent in Through the Secretary of Their Lodge. After That They May Have Changes Made in Their Address by Filling Out Blank Form in Back of Book and Forwarding to the Editor.

All Copy Must be Received by the Editor by the 18th of the Month to Insure Publication in the Following Issue.

All Contributions and Correspondence Relating to the Journal, Should be Addressed to J. B. Casey, Editor, Room 3, Law Building, Kansas City, Kansas.

Entered at Postoffice, Kansas City, Kansas, as Second Class Mail Matter.

DEATH OF FORMER INTERNATIONAL SECRETARY-TREASURER GILTHORPE.

The International Lodge was very much shocked to learn of the death of former International Secretary-Treasurer Gilthorpe, which occurred at Mendon, La., Saturday night, January 9, of double pneumonia, after less than two days' sickness. After retiring from office last fall Brother Gilthorpe and his wife went South for the purpose of spending the winter in a warmer climate. He was enjoying the change and in good health and spirit until a short time before his death. Since he had retired from active duty and could take it easy his friends confidently expected he would live many more years to enjoy his honors and emoluments, and we are sure there are none who do not regret his early demise.

Brother Gilthorpe was one of the oldest in point of service, of any International officer of the labor movement, having served continuously from the consolidation of the old National and International in June, 1893, and was secretary of the old International with headquarters at New Orleans, previous to that time; he further bore the distinction of being among the first of any National or International officer being retired with pay.

The remains were brought to Kansas City and the funeral took place Tuesday morning from St. Mary's Catholic church. A solemn requiem mass was celebrated by Bishop Ward of the Leavenworth diocese. As a mark of respect to his memory all work at the International headquarters was suspended for the day.

The remains were followed to St. John's cemetery, where the interment took place, by a large concourse of relations and friends.

The floral offerings were numerous and beautiful. May he rest in peace.

A LOCKOUT IN THE OIL FIELDS OF OKLAHOMA.

What to all intents and purposes, amounts to a lockout, exists in the oil fields of Oklahoma and Texas, and effects the employes of about half of the tank building companies operating in the oil fields. They are as follows: Warren City Boiler and Tank Co., of Warren, Ohio; The Standard

Boiler and Plate Iron Co., of Niles, Ohio; Reeves Brothers, of Alliance, Ohio; Hammond Iron Works, of Warren, Pa.; The Petroleum Iron Works, of Sharon, Pa.; The Treadwell Construction Co., of Midland, Pa. and Riter-Conly Construction Co., of Pittsburgh, Pa.

While all of these companies operate open shop plants, they either had agreements with the men in the oil fields or they were paying the scale asked by the men. However, last fall work became slack and these companies true to their open shop proclivities, took advantage of the dull period through which we have been passing, and organized an association for the purpose of starting up operations in the fields under open shop conditions; our men were notified that after January 1, no job stewards would be tolerated, or committees from the organization recognized.

The Grand Lodge, as well as the officers of Lodge 592, have done everything to avoid trouble, but to no purpose, these firms seem determined to pursue their short sighted policy for the present. However, we believe they will soon be convinced of their error, and they will find their experiment a costly one, for when they seek a settlement they will find they will have to agree to be fair not only in the field, but in their shops as well, and their agreement will have to cover the men in the shops as well as the field, and they will have to agree to pay a living wage to all of their employes, no matter where employed.

It will be noticed all of these companies are from a section of the East in which a very poor standard of wages prevail, and they seemingly are seeking to drag down the standard in the oil fields, to that where they hail from, but we feel confident the loyal union men in the fields will soon convince them it cannot be done. As all efforts to adjust the matter failed for the reason the companies refused to answer communications, the Executive Council of our organization authorized our members to refuse to work under open shop conditions, and about 500 members of Lodge 592 suspended all work for the companies on January 18.

Furthermore Lodges 37, 39, 86 and 305 were notified to have their members discontinue work for these companies also, as all have been declared unfair.

There is another group of contracting companies from the Middle West that are doing work in the oil fields. These number about the same as those concerned in the lockout. These all have agreements with our men and are paying the scale and employ about half of the members of Lodge 592, which was given jurisdiction over the oil fields of Oklahoma, and which we believe has more than one thousand members.

The men voted to a man to refuse to work under these unfair conditions and are confident of winning out at an early date. These men are mostly all seasoned, expert tank builders, and are by years of training well fitted for the arduous task they have to perform and which is done under such a terrific speed, that only those well broke in can stand. Our members everywhere are advised to stay away from the oil fields until they are informed, through an official source of a settlement. Our members locked out

are warned of the possible efforts of their enemies, to cause some breach of peace, in order to secure the sympathies of the public. The men should avoid large assemblies in the street or highways, and should report to headquarters promptly each day and cheerfully perform the duties assigned them. Act peaceably and courageously, and stand together as union men and victory will be yours.

AMENDMENT TO LOCOMOTIVE BOILER INSPECTION LAW PASSES HOUSE.

The Amendment, offered some time ago, to the Federal Boiler Inspection law, and which has been on the unanimous consent list for some time, was taken up just after the holidays and passed by the house. It required unanimous consent to take this bill up, and if we only had one loyal friend present to raise his voice in objection the bill would still be on the waiting list of the House; as it is the measure has now gone to the Senate for action.

What the Senate will do remains to be seen, however, there seems to be considerable influence exerted in behalf of the measure.

This amendment would amend the boiler inspection law so as to take in the inspection of trucks, tenders, wheel tires and in fact the whole locomotive in general, this would more than double the present work and the work is altogether different from inspecting boilers, the idea seems to be to divert the principal work away from the inspection of boilers, this would offer a more plausible excuse for using other than boiler makers as inspectors, they have more than two of other trades to one boiler maker now under the old law, and if this amendment carries it is quite likely the bars will be lowered still further in order that incompetents of other trades might qualify.

The A. F. of L. Convention went on record as being opposed to this amendment, and the Railway Department did likewise. Our members should pass resolutions condemning the amendment in its present form and let their Congressmen and Senators know about it as soon as possible so that when it comes up for action in the Senate we may defeat it for good and all.

The transportation organization, strange to say, have indorsed the amendment of just and equitable laws, designed for theirs and the traveling public. Inspection of the parts of engines should come under the safety appliance law, extend this law and appoint more safety appliance inspectors, rather than try to mix things as the amendment referred to above would do.

KANSAS BOILER MAKERS HOLD A CONFERENCE.

A number of representatives from the lodges in Kansas held a conference in Topeka on the 27th day of December last, for the purpose of considering the necessity of an equitable boiler inspection law for Kansas. A very enthusiastic meeting was held and after the matter was discussed at length, it was decided to make a determined effort to secure such a law at

the present session of the Legislature which convened on January 12th and Bro. S. T. Sample, Secretary-treasurer of District Lodge No. 10, was selected to attend the session of the Legislature to work for its passage.

A large number of other labor organizations have indorsed the matter and officers of the State Federation of Labor have promised their co-operation and assistance and it is confidently expected that success will attend this systematic and determined effort to secure protection for the lives of those who are thrown around boilers, by seeing that unsafe boilers are not used.

The Kansas lodges thus sets a good example for other states to follow that have not yet enacted such a law.

TRYING TO KNOCK OUT WOMEN'S MINIMUM WAGE LAW.

Employers of the State of Oregon, who have been fighting the minimum wage law of that State, have appealed their case to the United States Supreme Court, and that body has concluded its hearing of argument of the case and taken it under advisement. Louis D. Brandies of Boston, represented the Oregon Wage Commission in defense of the law, and besides making oral argument of one hour's duration, has presented a written brief.

It will be remembered that it was Mr. Brandies who presented the masterly defense of the eight hour law for women several years ago, which more than anything else outside of its merit, was the cause of the law being declared valid. While we have not been a zealous supporter of the minimum wage law, as we believe the minimum would prove to be the maximum too, still if the people of a sovereign State deemed it necessary or beneficial for the protection of the female workers of that State to enact such a law, we believe they should have the right to do so without any interference from the Federal Courts.

Nine States have already passed women's minimum wage laws, and if the Oregon case is decided against the law, all of these State laws would be declared unconstitutional.

THE INDUSTRIAL COMMISSION TO INVESTIGATE ROCKEFELLER FOUNDATIONS.

The daily papers inform us that it is the intention of the Federal Industrial Commission to make an investigation of the activities of the Rockefeller, Sage and Carnegie "Foundations" and seek to learn how far they influence public opinion, and whether it is used for good or evil purposes. These foundations have been promoting industrial training especially in the Southern States, and it is charged they have tried to influence the opinion of the scholars, especially in reference to organized labor; furthermore it is openly stated that certain educators in different sections of the country have had their salary increased by a supplementary gift from these foundations on condition that, in return, these teachers are to teach such books and theories as are agreeable to those behind these foundations.

It is well to have these foundations investigated at this time, and if it is found they are seeking to influence the standard of education taught to our youths, they should be promptly wiped out of existence. These foundations represent hundreds of millions of dollars, the interest from which is used as those in charge of them desire. It will be recalled that a few years ago an effort was made to secure a perpetual charter for the hundred million dollar foundation of Rockefeller; however, we are glad to say the effort did not succeed and we hope no such effort will, as they are potent influences for evil in the hands of unscrupulous and designing men.

The activities and subjects which these seek to cover should be looked after by the State or National government, and under no circumstances should educational standards depend upon the benevolence of private wealth but should be supported by the government. By all means, let us have this investigation and let it be a thorough one, laying bare the whole workings and effects of these foundations. If they can stand the scrutiny of a rigid investigation, they will gain public opinion the quicker, and if they cannot stand the searchlight of the investigation, then the quicker we find out the better.

TOO MANY LAWYERS IN CONGRESS, SAYS ONE.

While many lawyers, as well as nine-tenths of the rest of us, realize it, only one lawyer that we have so far heard of, has admitted that we have too many lawyers in Congress for the public good. The papers tell us this man hails from Chicago. He is quoted as saying that "Out of the 531 members of both Houses of Congress, there are 302 lawyers." While we have not looked up the records as to the authenticity of this statement, if it is true we most heartily agree with his conclusion. The best governed community is that which selects its lawmakers, as far as possible, from all the different groups that go to make up the community.

The records of the achievements of the small labor group in Congress during the past two or three sessions fully demonstrate the trouble with Congress has been there were too few members in this labor group and too many lawyers and others without practical experience concerning the real problems that confront us at the present time. By all means, reduce this lawyer group and increase that of the labor group, and the country will be the gainer.

U. S. SUPREME COURT AWARDS DAMAGES TO HAT MANUFACTURERS.

A recent decision "handed down" by the Supreme Court of the United States awarded damages to Danbury Hat Manufacturers, which they allege they sustained because of a strike of their union employes. The amount awarded is three times as much as the real amount of the alleged loss.

This is the final outcome of the fight which has been made in the

courts for the past seven years, unless this same court opens the matter again on an error or some technical grounds.

What action of the Hatters or the A. F. of L. will be taken in reference to meeting the demands of the verdict is at present problematical; however, the decision is met with far more equanimity by organized labor because of changed conditions than it would have, had the law not been changed, for it would have created an intolerable condition that would not be tamely submitted to by organized labor, for it would have created conditions as bad as in the feudal days in Europe, centuries ago, when men were bound to the glebe (or land) and changed owners with the land, and could not go from one place to another without a permit of their master. The right to strike—to quit work whenever or wherever men may please, either singly or in a body—is an inalienable right that cannot be abridged so long as this right is exercised peaceably.

We hope some means may yet be found to thwart this nefarious decision, which is not based on constitutional law of this country, but upon the Taft Case decision of the House of Lords of England a few years ago, which was acknowledged to be a revolution in court decisions in that country, which has no written constitution like that of our own; however, corporation sharks in this country eagerly seized upon this decision and urged it upon the judges (of our courts) and they in this case lent a pliant ear, and it would bid fair to become general in a short time had not Congress, at the urging of labor, changed the laws recently so that another decision of this kind should be impossible, or if it is, an investigation of the court making it would be very much in order.

The decision affects 186 members of the Hatters' Union and the damages awarded to D. E. Loewe & Co. amount to \$252,130.

STANDARD TIME HUMBUG SHOWS UP AGAIN.

The receivers for the Chicago and Eastern Illinois Railroad have been trying to inaugurate a "standard time" system very much like that in vogue in the American Locomotive Company's plants a few years ago, and which our members in these plants succeeded in exterminating, root and branch, and that, too, single handed, and alone. However, it ought not to be very hard to displace such a questionable system, as it proved to be a dishonest proposition from the start, for men would receive 30, 40 or 50 cents over and above a nominal wage, for a whole week of strenuous work.

The plan is based upon the Taylor system of so-called scientific management. The standard time was secured by timing the swiftest workmen, working under the most favorable conditions; therefore there was no likelihood of the average workman, working under ordinary conditions, reaching par and thus secure the twenty per cent bonus held out as a bribe to induce men to strive to the limit, to secure; furthermore, a man might possibly earn a small bonus today and forfeit it all tomorrow because bad luck or a thousand and one things may prevent the next job being completed anywhere near the allotted time, and, as the system provides for taking the

average for each pay period, rather than each job, therefore what was made by hurrying on the first job would be absorbed by the lost time on the second job, and while the workman may have worked hard in each case and the cause for delay in completing the second job may have been entirely beyond his control, still there would be no compensation to him for the extra efforts put forth.

The whole system is a wilderness of red tape—records to be kept, and an abnormal increase in overhead charges, which, reduced to its last analysis, means an added burden for the workman without an adequate increase in the amount of compensation received.

However, while we are unalterably opposed to this pernicious system of work, we are equally opposed to the method used in trying to introduce the system, which is directly in conflict with an agreement entered into by the management with the Federated Shop Trades under date of September 1, 1913, and which was to continue in effect until a thirty-day notice was given by either side that a change was desired, and as no such notice was given, this agreement is still in force and it is based upon a straight day's work basis. The introduction of this bonus system is a direct violation of its provisions, and upon the face of it, it looks as if the management have tried the supervision of the United States Courts, the receivers should not allow to take advantage of dull times and slip one over on the men.

However, as this road is in the hands of receivers and therefore under the supervision of the United States Courts, the receivers should not allow such sharp practices to prevail.

It is often charged that the members of unions won't live up to their agreements, but it looks as if the shoe is on the other foot.

We hope the receivers will take prompt action in this matter as did Judge Clark in reference to the Wheeling & Lake Erie, as reported in the last issue of the Journal.

MR. FORD, OF PROFIT SHARING FAME, DENOUNCES MILLIONAIRE PHILANTHROPISTS.

Among the witnesses who testified before the Industrial Commission recently was Mr. Henry Ford, the Detroit millionaire motor car builder, who has justly earned a world-wide reputation as an employer of labor and who has inaugurated a real profit sharing system in his plants that means good wages to his employes. Mr. Ford expressed his contempt for men who by sharp practices and unfair dealings extract millions out of business and then became philanthropists; he justly and correctly states the attitude of all free workmen when he says "they want justice, not charity." He is quoted as saying: "The methods in vogue in my factory would permit taking over the entire population of Sing Sing prison and making good citizens of them." Since the inauguration of his profit sharing plan and a minimum wage of \$5.00 per day, he testifies that the efficiency of the men has increased from 15 to 20 per cent over their former standard of work produced, notwithstanding the hours were also reduced from nine to eight.

This result speaks for itself and should encourage other manufacturers to pay a fair part of the profits to the workers as wages. From all reports the plan as inaugurated by Mr. Ford has had splendid results upon the employes and their families—bank accounts and life insurance have greatly increased, as have also the number of homes owned by the employes; others have moved from squalid quarters to nice homes with healthful and uplifting influences surrounding them.

George W. Perkins also appeared before the Industrial Commission and extolled the alleged merits of the profit sharing of the steel trust. He apologetically states that ONLY 22 per cent of this trust's employes were forced to work twelve hours per day. He defended the efforts of the trust to sell its stock, water and all, to its employes. He attributed the FAILURE of this trust to make profits to the new tariff law. This seems to us a very cheeky statement, when the facts in the case all show the steel trust has stocks and bonds to the amount of about a billion dollars, which does not represent anything but water. The dividends and interest on this fabulous amount must be paid before the men get anything, as this is set down as fixed charges. One suggestion, I believe Mr. Perkins made, has considerable merit, that is that the working men (employes) should select one of their number to act on the board of directors of the company they are employed by. We spoke of this kind of a proposition some time ago, and believe there is merit in it, if it is honestly carried out, as it would inspire confidence of the men in what was being done, and this confidence would beget more confidence between the management and the men, and if it was backed up, by fair and frank dealings with each other, the result would be gratifying to all concerned.

SECRETARIES SHOULD SEND IN DEPOSITED CLEARANCE CARDS PROMPTLY.

From circumstances and information coming under our observation recently, it would seem that some of our secretaries are not promptly carrying out the law in reference to sending the clearance cards deposited in their lodges to the International Secretary-Treasurer. This law was enacted at our last convention and it is very important that the law be carried out promptly by each secretary so that the records at headquarters may be kept complete. Furthermore, there is a fine liable to be imposed upon any secretary failing to carry out its provisions.

It is not a hardship or much trouble to comply with, for after each meeting when the cards have been accepted, the secretary has only to indorse them, the date of deposit, number of lodge, and sign his name on each, and put them in an envelope and address to the secretary-treasurer. There is very little work attached to it and it can be transacted in a couple of minutes; furthermore, it is important that this information be in the hands of the International Secretary-Treasurer.

Therefore we trust all secretaries will follow out the law promptly. Get the habit of doing so right after each meeting and it will be an easy matter.

M. O. & G. STRIKE DECLARED OFF.

The federated strike which has been in force for nearly two years on the Missouri, Oklahoma and Gulf Railroad has been declared off by the railway department of the American Federation of Labor, effective December 28, 1914. This action was taken at a meeting of the executive officers of the railway department held in St. Louis on December 22, 1914, and was in response, we believe, to a petition signed by a large majority of the men involved.

We are sorry to learn this strike did not have a more favorable ending, and believe it would have been settled long ago had some of the officials of the company shown a disposition to be fair; as we visited Muskogee several months ago for International President Franklin to look after some other business and while there, on request of the M. O. & G. federation, sought to bring about a settlement, some of the officials of the company we found friendly, but those who had the determination of the matter in their hands were so hostile they would not even consent to discuss the matter. Later on, after returning to headquarters, we took the matter up with one of the receivers of the road, who at first talked fair and promised to take the matter up with us later on, but failed to do so, even though we tried on several occasions to meet him for that purpose.

DEATH OF FIRST INTERNATIONAL VICE-PRESIDENT HINZMAN'S MOTHER.

Just as the Journal was about ready for the press a wire was received by International Vice-President Hinzman, which announced the death of his mother at her home in Centerville, Ia. A paralytic stroke, which occurred at Christmas, summoned the family to her bedside during the holidays. After several days she seemingly rallied and grew stronger, and it was hoped her recovery would be permanent; however, her advanced years was against her and she gradually grew weaker until death.

The Journal desires to extend our sympathy and condolence to the two brothers, Al and Dutch, as well as the other members of the family.

No arrangements have been made for the funeral at this writing, but we presume it will take place in Centerville, near her former home.

PERSONAL MENTION.

Brother W. D. Walpole of Lodge 521, Van Buren, Ark., was a recent visitor to headquarters, and reports that he received a severe scalding while visiting the M.-P. round house there in December. The brother speaks in high praise of the brothers of No. 521 who nursed and looked after him

until fully recovered, and he desired that we make public their generous actions and his appreciation of same.

THE CORRECTION OF AN ERROR.

Among the lodge notices which appear in this issue will be found one from the secretary of Lodge 32, Kansas City, Mo., concerning the publication of the name of Brother H. Czatlenski, Reg. No. 64922, in the past two issues of the Journal for alleged failure to pay room rent, and as the lodge found a mistake had been made, now offers an apology to the brother.

It seems this brother's due book was stolen from him in Huron, S. D., last August and was advertised in October Journal, and a duplicate was issued to him by the I. S.-T. on request of his lodge. This brother left Kansas City soon after getting duplicate book and went south, and the person who got this book came here and went to work and secured room rent in the name of Brother Czatlenski, showing the stolen book to prove his identity. After working a short while he skipped out without paying his rent, and upon a complaint, Lodge 32 advertised him in the Journal. Brother Czatlenski was deprived of securing work in a couple of places because of this ad in the Journal, and as he is evidently an innocent sufferer, we hasten to get this in the Journal, even though our forms were practically closed for this issue.

QUOTATIONS.

'Tis education forms the common mind;
Just as the twig is bent, the tree's inclined.—Pope.

The best may slip, and the most cautious fall;
He's more than mortal that ne'er err'd at all.—Pomfret.

The poorest day that passes over us is the conflux of two Eternities; it is made up of currents that issue from the remotest past and flow onwards into the remotest future.—Carlyle.

Great men are they who see that spiritual is stronger than any material force; that thoughts rule the world.—Emerson.

There is but one way I know of conversing safely with all men; that it not by concealing what we say or do, but by saying or doing nothing that deserves to be concealed.—Pope.

To everything we call a cause we ascribe power to produce the effect. In intelligent causes, the power may be without being exerted; so I have

power to run when I sit still or walk. But in inanimate causes we conceive no power but what is exerted, and therefore measure the power of the cause by the effect which it actually produces. The power of an acid to dissolve iron is measured by what it actually dissolves.—T. Reid.

The adequate meaning of chance as distinguished from fortune, is that the latter is understood to befall only rational agents, but chance to be among inanimate bodies.—Bently.

The wise man has his follies, no less than the fool; but it has been said that herein lies the difference—the follies of the fool are known to the world, but are hidden from himself; the follies of the wise are known to himself but hidden from the world. A harmless hilarity and a buoyant cheerfulness are not infrequent concomitants of genius; and we are never more deceived than when we mistake gravity for greatness, solemnity for science, and pomposity for erudition.—Colton.

STRIKES NOW IN FORCE.

- Spokane, Wash., Union Iron Works. (Metal Trades strike on.)
- Farrer Traft Contract Shops, Buffalo, N. Y. (Strike on.)
- Illinois Central R. R. (Federated Trades strike on.)
- Harriman Lines. (Federated Trades strike on.)
- Pere Marquette R. R., Grand Rapids and Saginaw, Mich. (System Federation strike.)
- Contract shops, Mobile, Ala. (Metal Trades strike.)
- Boiler shops, Newport News Ship Building & D. D. Co., Newport News, Va. (Strike on.)
- Atlantic Basin Iron Works (Shields & Moran, New York.) (Strike on.)
- Hibbon & Co., contract shop, South Chicago, Ill. (Unfair.)
- Stockton, Calif. (Metal Trades strike.)
- Warren City Boiler & Tank Co., Warren, Ohio. (Strike on.)
- Standard Boiler & Plate Iron Co., Niles, Ohio. (Strike on.)
- Reeves Bros., Alliance, Ohio. (Strike on.)
- Hammond Iron Works, Warren, Pa. (Strike on.)
- The Petroleum Iron Works, Sharon, Pa. (Strike on.)
- The Treadwell Construction Co., Midland, Pa. (Strike on.)
- Riter-Conley Construction Co., Pittsburgh, Pa. (Strike on.)

Mechanical Department.

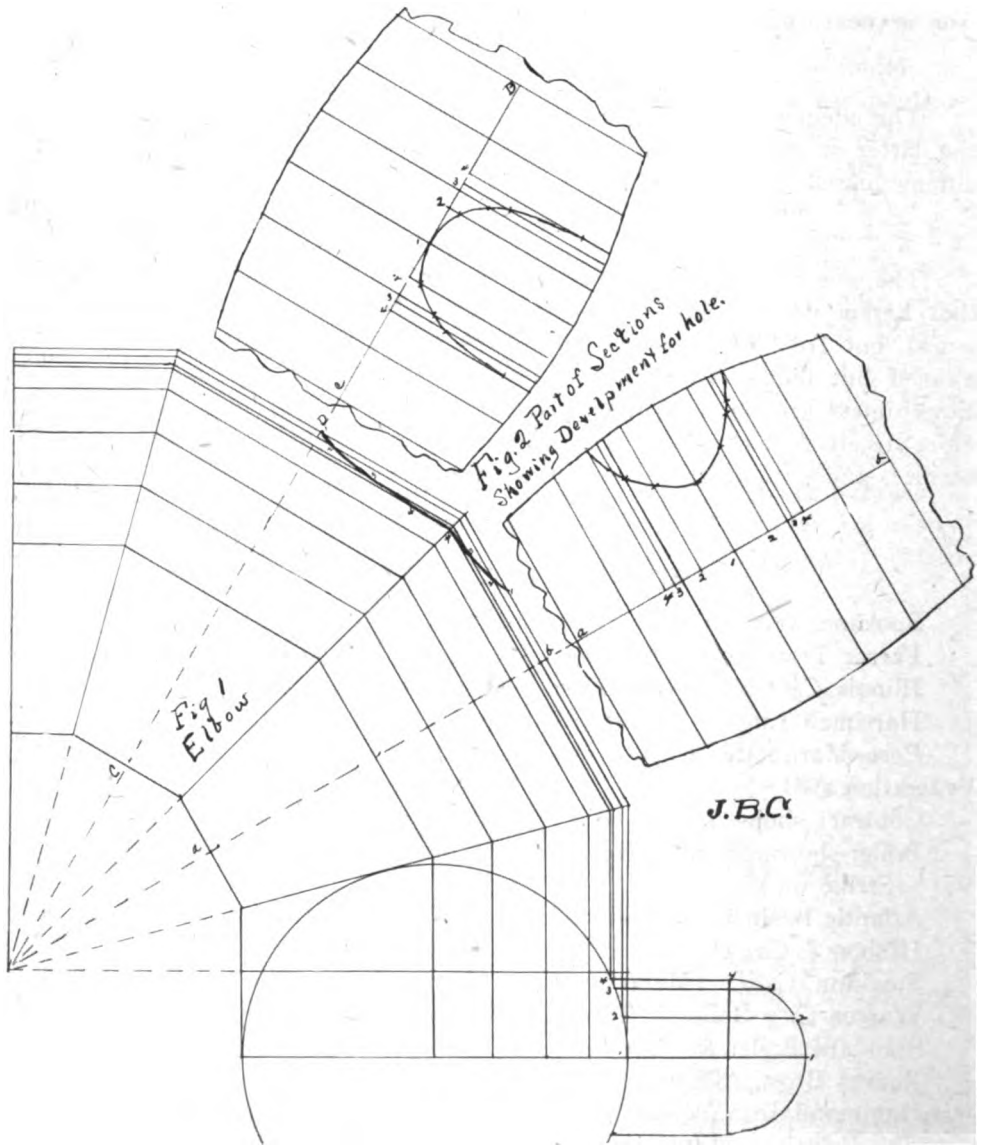

To develop the hole for a small pipe connecting an elbow at an angle.

Fig. 1, shows an elbow and the dark line at the top center is an outline of a hole for a small pipe connecting with the elbow at an angle.

Fig. 2, shows segments of sections with the method for developing hole. The method of laying out section of small pipe to connect with the elbow was reproduced last month. After marking elbow as shown and develop divisional lines on outside of elbow, which

are measured from 1 to 4, where these lines cross the dark line at middle of elbow, are points of measurements in developing hole. On line a-b, set one point of dividers at b, and the other at point 1, transfer this distance to line 1 of template, next take distance from line a-b to point 2 and transfer as before to lines 2 on each side of center-line. Continue in like manner with points 3 and 4, then trace a line through these points, this will give outline for hole in this template. The other part of hole is made in the other template in like manner.

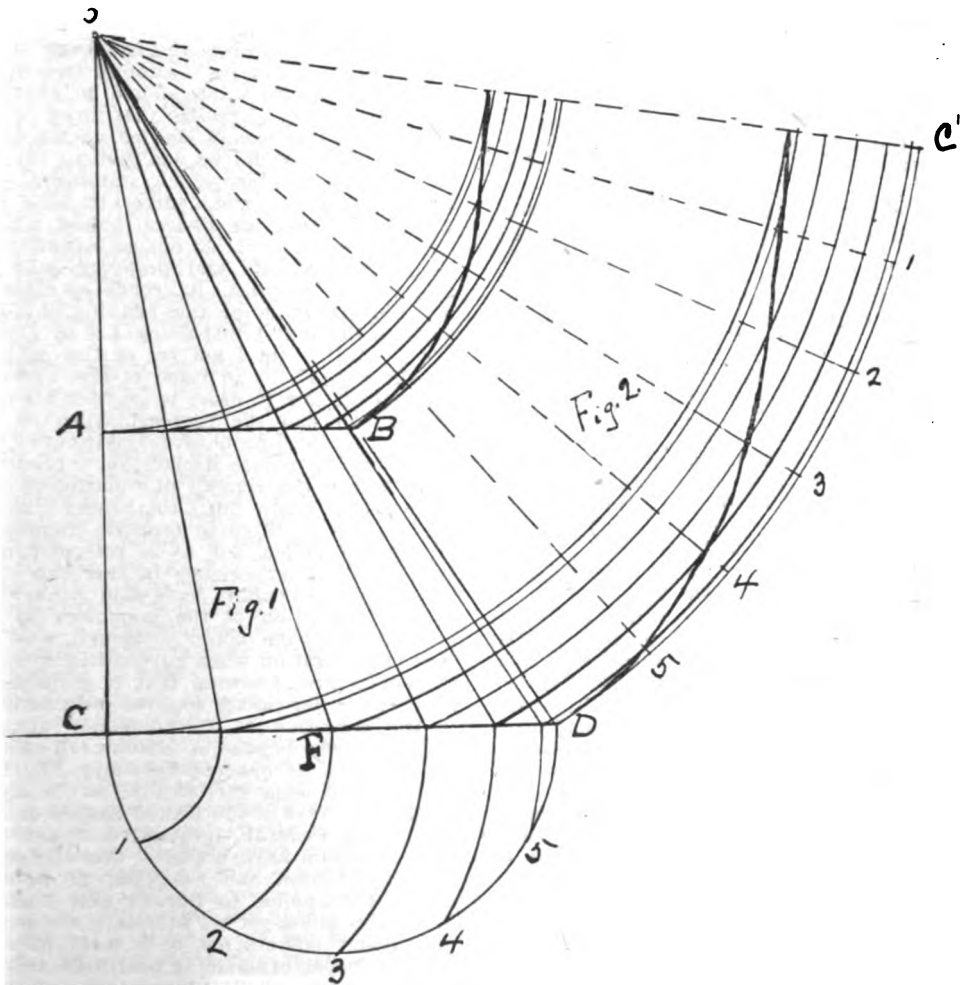

TO DESCRIBE THE PATTERN FOR AN OBLIQUE CONE.

To develop pattern, proceed to lay out outline of cone such size as wanted, as A, B, C, D, Fig. 1. Continue vertical A, B, C, D until they meet at O. Bisect large diameter C, D at F. Describe semi-circle from C to D, divide into any equal number of parts, in this case six, as C, 1, 2, 3, 4, 5 D; set one point of dividers at C and describe

lines to O. With O as a center, radius O, D strike circular line to C, Fig. 2, which equals one-half of diameter of base of cone; divide into the same number of parts as that of cone, strike lines from these division points to O, with O as center and radius from O to divisional points on both large and small divisional points as shown, if it is to be a lap joint allow sufficient extra for lap. This will complete one-half of template.

International Officers' Reports.

REPORT OF SECOND INTERNATIONAL VICE PRESIDENT NOLAN.

Since my last report for Journal my time has been mostly taken up in connection with the Amendment to the Boiler Inspection Bill passed by Congress February 17th, 1911, which has been fully explained on several occasions in the columns of our official and has gone through many parliamentary stages in an effort to pass it, namely, the House Calendar, Consent-Calendar, the Committee on Rules, and back again on the Consent Calendar.

But the transportation Organizations have failed to get the necessary support in Congress to have the Amendment become a law, at the closing of this report, January 2, 1915, although the usual sentimental appeal has been mailed to all Congressmen urging them to pass the Amendment as a Christmas present to the Transportation Brotherhoods for the protection of life and property on American Railroads.

If such a claim was the real purpose of the Amendment, it would have the unanimous endorsement of the entire American labor movement, but the object of the Amendment is not for the purpose claimed by any means. And all the mechanics employed in the railroad shops know it, on the contrary, instead of protecting life and property on American railroads, it would simply jeopardize it even to a much greater extent than at present in placing incompetent men in positions having only a theoretical knowledge and no practical experience whatever in the construction or repairing of boilers, as the pending Amendment purposes, that the inspectors of locomotive boilers will also be inspectors of locomotive engines and all its parts.

It is strange how some men's opinions change even in the face of statements made, and absolute knowledge from experience, knowing they are wrong, but there is a motive sometimes, that destroys some judgment, although aware that law is violated and justice discredited in order to gain a temporary advantage over his fellow man, or perhaps secure a position regardless of law or the required qualifications.

In considering past incidents in connection with the Boiler Inspection law, I find that in 1909 a meeting of labor representatives was held in the Bureau of Commerce and Labor, Washington, D. C., to discuss several important propositions that confronted labor at that time, and one of the propositions was a Federal locomotive boiler inspection law, among others who took part in that meeting was a representative of the Brotherhood of Locomotive Engineers, who participated in its deliberations and especially on the great necessity of a Federal locomotive boiler inspection

law, in order to protect the members of his organization. And in discussing the many reasons why such a law should be enacted, he said in part: I realize that none of my men will enter class of service, as none but boiler makers would be qualified to inspect a locomotive boiler, which statement was absolutely correct, and if correct in 1909 why not now, so that the Federal boiler inspection law may be carried out as intended by Congress, that life and property may be protected on American Railroads, as claimed by the advocates of the pending Amendment to the Boiler Inspection Act of February 17, 1911. But I am yet of the opinion should it come to an issue in the enforcement of the law, in order to protect his men in the cab that the representative of the Brotherhood of Locomotive Engineers will stand by his public declaration made in 1909, before the Bureau of Commerce and Labor, that none but competent boiler makers are qualified to properly inspect a locomotive boiler, for as a railroad man with years of experience in the cab of a locomotive he couldn't have said otherwise, as the protection of the members of his organization from boiler disasters was his first consideration when advocating a boiler inspection law, knowing that it required a practical boiler maker to pass judgment as to the condition of a locomotive boiler, which proves beyond a shadow of doubt, why the law as enacted February 17, 1911, should have been carried out, as intended by the Congress of the United States, namely; that a Federal locomotive boiler inspector should have practical knowledge in the construction and repairing of boilers, which law applies to Bureau and District Inspectors alike, yet we find only about sixteen boiler makers out of a total of fifty District Inspectors holding positions as Federal locomotive boiler inspectors, while a sufficient number of practical and technical boiler makers with all the necessary qualifications, could have been secured in the southeastern district alone, not to speak of other sections of the country. Still we find about thirty-four inspectors of locomotive boilers holding Federal positions who know nothing about the trade of boiler making unless from observation. The question is, what is the cause, or who is responsible for such a condition of affairs. In considering the selection of bureau chiefs from a mechanical standpoint, great care should have been exercised in securing competent inspectors for such important positions, for all must admit an error has been made, and a very serious one, from the viewpoint of law as enacted as well as practical mechanical efficiency, which is apparent to all fair minded men who understand the situation at issue, as the issue is not, who shall hold those positions, but on the contrary, the enforcement of the law.

Therefore, in consideration of the above, there should have been selected after the Federal Boiler Inspection law had been passed by congress, and signed by President Taft, a committee of well known practical and technical railroad boiler makers, having years of railroad shop experience as an examining board to pass upon the qualifications of applicants for the positions of chief, and two assistant chiefs of the Bureau of Federal Boiler Inspection, said board to make their recommendations for those positions to the President, who would make the appointments and be confirmed by the Senate, in that way, and no other, can a staff of competent inspectors be served or the law enforced and justice established.

There are many bills in the interest of labor introduced during the 63rd Congress, some of which have not received favorable consideration in committee, due to the fact that co-operation of labor representatives is necessary in order to prevent misunderstanding in securing favorable legislation to organized labor. There seems to be a disposition to follow in the same old rut of years ago, get what you can and let the other fellow take what is left. It won't work now days, as conditions have changed what effects on organization as a general proposition will effect kindred organizations, at that time, or later on.

If the railroad shop organizations should attempt to carry out the old methods of individual efforts when in conference with railroad managements, and be successful, system federations would be both useless and expensive, but experience has taught them that individual efforts in doing business with railroad officials have proved a failure on many occasions, hence joint action of all affiliated trades was the only logical move to cope with changed economic conditions in order to get favorable results in the interest of their members.

Therefore similar joint co-operation is just as necessary in trying to get state or national legislature, as joint action of a federation because the principle involved is just the same protection. The railroad employes department was organized for the same purpose, greater power through co-operation of its affiliated organization in getting results, either in the interest of the individual organizations or the federation as a whole, in that way misunderstandings and friction very seldom crops up, and experience has taught many of us that results along legislative lines cannot be successful in any other way, unless in extreme cases, when public clamor demands certain legislation, but as a general proposition labor legislation don't receive very much public indorsement by any means. On the contrary oppositions from certain co-operations is evident at all times, and on the job to defeat any measure that would benefit labor. The transportation organizations understands the necessity of joint action, while

I don't approve of their selfish propoganda in connection with the labor movement, or in securing state or national legislation, yet the four brotherhoods have secured and are securing legislation which no one who understands the situation can deny, has a joint legislative committee at all times in Washington with suitable quarters to properly carry on the work required, so as to keep in touch with their local organizations or legislation when pending, so as to be prepared to act according to instructions at any time, and have got results. Why not the various International organizations affiliated with the A. F. of L., railroad and metal trades department, have also a legislative committee in Washington, D. C., when necessary, as we are up against a problem either on national or state legislation in order to get some measure of justice in the halls of legislation, otherwise our chances for success along the above line will be very limited, as capital is organized and on the job, and without a particle of friction among its representatives with a well defined understanding as to what they want and how to get it.

I have received several letters of late from navy yard lodges of the Brotherhood, requesting information as to how to proceed in bringing about a close co-operation among the organized boiler makers, iron ship builders and helpers employed in government navy yards.

Lodges No. 57, 450, 19 and 148, realize the necessity of a naval district so the interest of all navy yard lodges of the Brotherhood can be looked after through the Navy Department at Washington when necessary.

Portsmouth, N. H., Boston, Mass., Brooklyn, N. Y., Charleston, S. C., and Bremerton, Wash., are yet to be heard from on the above proposition, but hope that in the near future a move will be set on foot to bring about a delegate meeting of all navy yard lodges of the Brotherhood at some central point in the East as all of the navy yards are in that territory with the exception of No. 148 and No. 290. I must say from past experience in connection with organization in government navy yards, that navy yard lodges of the Brotherhood are an absolute necessity in the interest of their members, even when railroad or contract lodges of the Brotherhood are in the same vicinity.

In the locality of the Norfolk navy yards there are three lodges of the Brotherhood—No. 57, a navy yard lodge; No. 298, a railroad lodge, and No. 428, a contract lodge, all three working in perfect harmony with each other, as they should be; no friction whatever, and when joint action is necessary for the benefit of all, they are right on the job, shoulder to shoulder as one. Navy yard lodges are an absolute necessity, for the protection of its members, as there seems to be a disposition on the part of the naval officials to extend the building of new ships in government navy yards, and with in-

crease of war ships of various types. A corresponding increase in the mechanical forces will be required on both new and repair work. Therefore, every effort should be made to get every eligible craftsman employed in government navy yards, members of the Brotherhood, so as to be in a position to co-operate jointly, either on legislation, through their Senators or Congressmen in Washington, or on working conditions or wage, which sometimes have to be taken up with the navy department, when local efforts fail.

There are many other matters of vital interest to members of the Brotherhood employed in navy yards that also require joint action to either introduce or prevent, and until such time as the boiler makers, iron ship builders and helpers employed in government navy yards realize the necessity of organization and become members of it very little progress can be made by any representative in Washington, D. C., in the way of securing what belongs to them, recognition, and when that is once accomplished unfair conditions is hardly ever forced.

I have been an advocate for several years of a naval federation of the trades employed in government navy yards, was a member of the navy yards league which was organized a few years ago and would have done much good, had not the leaders of the league showed a disposition at every opportunity to carry on their negotiations on an independent basis with the department, entirely ignoring their international representatives and of course the movement fell to pieces on that account, from the lack of united co-operation.

At present a Naval Federation of Trades should be organized among the various crafts employed in government navy yards, but no effect has been made whatever, as there seems to be a disposition to stand by the old adage, survival of the strongest numerically, and let the weak organizations get what they can, and if they get nothing, but promises, alright; that's not the object of the labor movement by any means.

The boiler makers employed at the Washington navy yards have a kick coming alright, as the recent action of the erecting shop relief association in debarring them from membership, smells pretty fishy.

There is what is known as a relief association in many of the shops for the benefit of the employes in sickness and accidents. The erecting shop association of which the boiler makers were formerly members of, changed their by-laws in order to debar the boiler makers from continuing their membership on the ground that the boiler trade was a hazardous occupation.

If such was the case, the boiler makers wouldn't have any protest against the relief association, nor could they raise any objection in excluding them from membership. But as members of the relief association, I

have been informed by authority that can't be questioned, that the association in the past haven't been called on to pay any more benefits to the boiler makers than other members of the association. There must be a reason. The boiler makers don't care very much either one way or the other, yet they feel that a great injustice has been done them and fail to see why the boiler trade is any more hazardous than other metal trades. Notwithstanding the relief association to the contrary.

As the great majority of work performed in the boiler shops (so called) is not the construction and repairing of marine boilers as generally supposed, but a different class of work altogether, both requires experience and skill to turn out, but a large percentage of work done by the boiler makers at the Washington navy yard is ordinance work, which requires first class mechanics trained from experience on that particular class of work, and don't have any more accidents among their men than any other metal trade in the yard, at least there is no record to prove to the contrary.

It is with extreme regret I have to report the untimely death of Brother W. S. Wurzbach, Reg. No. 69756 of Los Angeles, Cal., who was almost instantly killed on December 9, 1914, while crossing the yards of the Chesapeake and Ohio Railroad at Newport News, Va., and in company with Brother Wilford Martin of Lodge No. 528, Deer Lodge, Mont., who was present when the fatal accident occurred.

I met Brother Martin on December 12, at a special meeting of Lodge No. 55, who explained cause of sad accident. There are a number of tracks in the yards of the Chesapeake and Ohio railroad at Newport News, and in crossing them Brother Martin and the late Brother Wurzbach saw a train coming and stopped to let it pass, and stopped right opposite them, separated and left a small opening in train, thinking there was no danger in going through, they started, Brother Wurzbach first, was just between the couplings when the engine backed down and crushed him almost to death, as he only lived a few minutes after the accident.

Brother Healey, president of Lodge No. 55, was at that time visiting in Wheeling, West Va., but on getting information of the death of Brother Wurzbach, wired to several member of Lodge No. 55, to have the body properly looked after until his family or lodge would be heard from.

In company with Brother Hickey and Healy of Lodge No. 55, I called at Caffees' Undertaking Establishment, saw the remains which had already been embalmed, after which we arranged to have the members of Lodge No. 55 escort the remains of Brother Wurzbach to the railroad station when shipped to his late home, Los Angeles, Cal.

The writer joins with the officers and members of Lodge No. 55 of Newport News,

Va., in extending to his dear mother and sister, other members of his family as well as his brother members of the brotherhood, and friends in Los Angeles, Cal., our most sincere sympathy on account of the sad ending of Brother Wurzbach. May he rest in peace.

In conclusion let me say that conditions don't show very much improvement either in railroad or contract shops, in the south-eastern district as jobs are few and hard to get, this report is not made in the spirit of a calamity howler, but on the contrary from industrial conditions as they exist, and seen by the writer. There surely must be something radically out of joint when jobless men by the thousands find it impossible to secure employment, willing to work in order to support their families, and can't get it, in the land of plenty with a bumper crop in 1914. For when men and women must go hungry from lack of employment it becomes a pretty serious matter to think about that, in the development of a great nation, thousands of her citizens should be driven into enforced idleness, while none of our great statesmen seem able to apply a remedy, therefore, the time has come when organized labor must seriously consider the problem that comforts them for self-preservation.

Some of our statesmen are in favor of a great standing army with big appropriations for military purposes in order to prepare for war and any nation that fosters and cultivates that ideal will have war.

Europe has played the war game for years, and what has she got for her policy, ruined homes, hundreds of thousands killed in battle, with cripples, orphans and widows, in defense of what, that kings and their allies may gratify their ambition in the best blood of their people, but let us hope for changed conditions through the political efforts of the labor movement at the ballot box so this great nation of ours will devote her energy in the proper direction, in order to make prosperous citizens, instead of jobless ones. I am

Yours fraternally,
THOS. NOLAN, I. V. P.

To Officers and Members of all Lodges,
Brotherhood of Boiler Makers, Iron Ship
Builders and Helpers of America.
Dear Sirs and Brothers:

Your attention is called to the fact that there is a bill in the United States Senate at present which is known as the Goeke House Bill No. 17894, that provides for the inspection of the machinery and tenders of a locomotive, as well as the boiler itself. The indications are that the bill may be reported out by the Senate without further hearings, and passed at this session of Congress.

The bill in its present form is unsatisfactory and your attention is called to resolution No. 141, passed at the Thirty-fourth Annual Convention of the American Federa-

tion of Labor, held in Philadelphia. The resolve of which reads as follows:

"Resolved, That this, the Thirty-fourth Annual Convention of the American Federation of Labor, go on record as favoring the appointment of inspectors with practical experience in addition to the other qualifications demanded by the Boiler Inspection Bureau, and, be it further

"Resolved, That the officers of the American Federation of Labor be instructed to cooperate with the organizations directly interested who are affiliated to the American Federation of Labor in drafting a suitable bill and in having it enacted into law to cover the inspection of locomotive boilers, engines and tenders and the appurtenances thereto, said proposed bill to contain provisions for the appointment of inspectors having practical shop experience, clearly specifying and recognizing the indisputable fact that none but those who have had such practical experience in their respective callings can qualify for these positions."

Acting on this resolution the President of the Railway Department, in conjunction with the General Officers of the Trades interested met in Washington, D. C., the week of January 11 to 16, and drafted a bill that provides for the inspection of boilers, engines and tenders by practical experienced men who have had not less than five years shop experience at their respective trades. It further provides that fifty additional inspectors shall be appointed, to not only inspect the boiler as a separate proposition, but that the engine and tender inspectors will be separate from the boiler inspectors. This bill has been approved by the Executive Council of the American Federation of labor. Unless there is some quick action on the part of the shop trades to arrest the Goeke Bill No. 17894, the probability is that it will be passed before the bill we have drawn up and approved by the Executive Council of the American Federation of Labor can be presented to the Senate. You are, therefore, instructed to make this circular a matter of business at your next regular meeting and notify your Senator that the Goeke Bill, H. R. No. 17894, in its present form is not satisfactory and should be amended to conform to the bill drafted by the officers of the Railway Department and approved by the Executive Council of the American Federation of Labor.

Our reason for opposing the Goeke Bill, H. R. No. 17894, is that it simply extends the jurisdiction of the present Boiler Inspection Bureau to include the engine and tender. The present boiler inspection law provides for the appointment of fifty District Boiler Inspectors who were presumably to be selected because of their fitness and practical experience in the construction, repairing and testing of boilers. A large majority of the District Boiler Inspectors who were appointed and are now attempting to inspect locomotive boilers, had no practical experience and are incompetent to inspect

a boiler. If the Goeke Bill H. R. No. 17894 should become a law, the duties of the fifty District Boiler Inspectors would be extended to include the inspection of the locomotive engine and tender. Very few of these inspectors have ever had any practical experience in the construction, repairing and testing of machinery.

Our contentions are, and we feel sure that we can prove them:

First: That, only men with practical shop experience and training in the construction, repairing and testing of boilers, are competent or qualified to inspect a boiler.

Second: That, only men with practical shop experience and training in the construction, repairing and testing of locomotive machinery, are competent or qualified to inspect the engine and tender.

Third: That, it is absolutely necessary to at least double the number of District Inspectors if the work of inspection is extended to include the engine and tender, and is to become in any manner productive of the benefits to be obtained by proper and efficient inspection.

We urge that you not only have your officers, but as many of your members as can, write to Senators individual letters and get your Central Body and shop organizations to write to their respective Senators, protesting the passage of the Goeke Bill H. R. No. 17894, in its present form.

The necessity for prompt and immediate action is due to the fact that the four transportation organizations are flooding the Senate with letters urging the passage of the Goeke Bill No. 17894 at this session of Congress.

This bill passed the House January 4, and is now before the Senate Committee. It is therefore, essential that you take immediate action in line with the suggestions given above. We will be glad to have you send us a copy of your letter to the Senators, as well as copy of the reply received.

This action is in line with the action taken by the Convention or the Railway Department held in Kansas City, April last, and has since been approved by the Philadelphia Convention of the American Federation of Labor and by the Executive Council at its meeting January 11 to 16, 1916.

The success of the efforts of your officers in this matter largely depends upon your support and co-operation, and nothing will bring the desired results to a greater degree than by your voicing your sentiments directly to your respective members in the United States Senate. To facilitate and assist you in the work, we enclose a sample letter as a guide.

In writing your Senators we advise that you use your own phraseology.

Fraternally submitted,

WM. H. JOHNSTON,

MARTIN F. RYAN,

JAMES W. KLINE,

J. J. HYNES.

F. J. McNULTY,

J. J. CARRIGAN,

S. E. HEBERLING,

Executive Council.

A. O. WHARTON,

Pres. Ry. Employees Dept.

J. A. FRANKLIN,

International President.

Correspondence.

Miami, Ariz.

Dear Sir and Brother:

I am sending you a list of the members of Local No. 187, Miami, Ariz. As far as I know, this list will reach all the addresses of the members that I have been able to obtain.

The prohibition law is enforced here and the lid is on very tightly. Throughout the state, from information I get from the newspapers, the law is obeyed.

The law which is of more benefit to Arizona comes up for a hearing in Los Angeles before three judges of the Federal Court. An injunction is being asked for to restrain the state officials from enforcing the law known as the 80 per cent law. What will be the decision of the judges I do not know.

The law known as the 80 per cent law was a measure voted on and carried by a large majority of the electors in this state at the last general election.

The measure states that where five or more persons are employed, 80 per cent must be a citizen of the United States. A strong fight will be made against that law,

as the mining companies like the foreigners better than the natives.

A corporation in this place known as the Miami Copper Company made a statement through their legal counsel that 1,200 men were employed, and 100 were registered. At the mines of the Arizona Copper Company at Clifton and Metcalf, Ariz., there were two of the employees registered out of a total of 800 persons. At the United States Verd Copper Company's mines at Jerome, Ariz., on one of the levels of the mine 400 men were employed and only one American, and he was not old enough to vote.

There are other mining camps all over the state where an American is an undesirable, a dago looks good, but a Jap or a Chinaman looks better still to the corporation.

Drastic measures had to be taken and if the injunction is denied I am sure the law will be enforced. If the Arizona law is valid, I think that every state which has the initiative and referendum will enact similar laws in a short time.

Yours fraternally,

ROY DRUMMOND.



A GROUP OF THE MEMBERS OF LODGE NO. 434 WORKING FOR THE BELT LINE OF CHICAGO.

Champaign, Ill.

Dear Sir and Brother:

It is not often that Lodge No. 150 has much to write for the Journal, but as we have received quite a number of letters in regard to what we are going to do with our former members on the New York Central line whose cards were revoked in November, 1911, we thought in order for all lodges that have had the same experience that we have had, it would be a good way to let all members know just what we think is no more than fair to do.

While we do not believe in placing a fine of \$1,000 and having a former member suspended for 99 years, we do think it no more than right that the former members pay to belong to the union, and we think the best way to have the former member pay dollar for dollar, just the same as if they had not had their cards revoked, that is to pay each month's dues, and the \$20 assessment, the three-dollar (\$3.00) penalty and the cost of reinstatement stamp.

We have made out each former member's standing until January 1, 1915; this amount will increase \$1.50 a month until such time until the former member gets reinstated or unless by special dispensation by the lodge.

Chas. Mullin, \$78; H. C. Howard, \$74; T. Riordan, \$77; S. Alston, \$75; G. Reinhold,

\$76; L. McKinney, \$76; H. Phillips, \$79, and E. L. Wanamaker, \$76.

"CORRESPONDENT,
Twin City Lodge No. 150,
Champaign and Urbana, Ill.

Green Bay, Wis.

Dear Sir and Brother:

Green Bay Lodge No. 485 held their installation of officers, meeting at 3 p. m. Sunday afternoon, January 3, at the Boiler Makers and Helpers' Hall, 109 Donsman Street, which was very widely appreciated by all the members and families in attendance. As we were very fortunate in having Brother John Du Brucq of Milwaukee and wife and son in our midst, Mr. Du Brucq being a man of wide experience in lodge circles and committees and conventions was appointed to conduct the installation which was very well performed.

After the officers were all installed, Mr. DuBrucq gave the members a very interesting speech on very many important subjects which was of a great benefit to all our members and I hope will always be a guide to each and every member of our local. After this was over, refreshments were served and other amusements, and everyone enjoyed a very pleasant afternoon and evening, and departed for their homes with the best of feeling and hoping that we

have another installation that will be as well enjoyed and conducted as the one commencing the year 1915, and hope it will still be a more prosperous year than the one ending the year 1914.

Yours fraternally,
JOHN M. SLATER,
Fin. & Cor. Sec. Lodge No. 485.

Miles City, Mont.

Dear Sir and Brother:

Just a line to let the members at large know that Local No. 520, of Miles City, Mont., is still doing business at the same old stand. In the month of December we had Brother Callahan, District Business Agent of the Milwaukee System, with us, and made us a good social talk of the get-together spirit, and the members of Lodge No. 520 think that District No. 26 was fortunate in securing the services of so capable and honorable a man as Brother Callahan.

We also had with us about a week later, the 5th inst., Vice-President Wm. Atkinson, who is so well known to the members of No. 520 that he does not need an introduction when he comes around. The majority of the members of Lodge No. 520 have been shop mates of Bro. Atkinson, and we don't notice any difference in Billy Atkinson, although he is our Fifth International Vice-President, and one of our most trusted and popular officers, and Lodge No. 520 extends him an invitation to call on us at any time and he will be received with a glad hand, or in fact, any of the Official Family.

On December 31, 1914, we gave our sixth annual ball at Kinres & Havens' new Auditorium, and to say that it was a success would be expressing it mildly. The following members were on the dance committee: P. J. Gallagher, M. C. Sullivan, Ed. McSperritt, C. G. Simmons, Glen A. Fry, Chas. E. Cook and L. McNurlin. And we wish to publicly thank each and every member of Lodge No. 520 for their hearty co-operation, in which they supported the dance committee.

Brother Andrew Fleming, of Melstone, Mont., was present at the dance, and we would have been glad if all our out-of-town members could have attended.

Brother Ed McSperritt manufactured some punch, and to say he knew how to make the best ever, goes without saying, as they consumed 30 gallons in two hours, indicating that it was too good to keep. Brother Roy McNurlin disposed of the greatest amount of tickets sold by one, total of 34 to his credit, which is not bad, considering we are working on a four days a week basis, hard times having hit our shop for the first time in its history. The shop force is reduced to about one-half and also the road force.

Inclosed you will find a clipping from the Miles City Star, which we would like to see in print along with this letter in the official Journal.

Wishing you all a happy and prosperous

New Year, I remain,

Yours fraternally,
CHAS. E. COOK,
C. & F. S., No. 520.

East Boston, Mass.

Dear Sir and Brother:

Lodge No. 585, on January 7, elected officers for the ensuing term as follows: Wm. E. McNabb, President; Thos. Farmer, Vice-President; Daniel B. McInnes, Recording and Corresponding Secretary; James Vincent, Financial Secretary; Bernard F. McDonnell, Treasurer; John Kerrigan, Inspector, and James Kerrigan, Inside Guard. The following were elected as Trustees: James Kerrigan, John Warnock, John Cartright, Patrick Frawley and Robert Mills.

The old war horse, John J. Farrell, retired as Cash Steward, and Brother Harry Higgins being selected in his place. All the officers were elected by a unanimous vote, and they all made appropriate addresses, thanking the members for the confidence reposed in them, and stating their determination to further the interests of the Lodge and the Brotherhood to the best of their ability during their respective terms of office.

A pleasant feature of the proceedings was the action of the Lodge, on motion of Brother Thos. Farmer, in presenting Brother D. B. McInnes, the Recording and Corresponding Secretary, with a handsome leather traveling and document bag. The bag affair, which was engineered by President McNabb and his "joy committee," comes as a pleasant surprise to the writer, who fittingly expressed his appreciation of the generosity of his fellow members.

Brother Wm. E. McNabb has the sympathy of all the members in the recent death, after a long illness, of his nephew, Robert McNabb, a young man who was well known and highly respected in his community.

The Lodge went on record as favoring the giving to women the right to vote for all election of officers in this state, as we believe that the philosophy of history and the fundamental ethics of reason and justice, justifies that course, and we granted the request of the Massachusetts Women Suffrage Association to have one of their speakers address us on the subject of equal suffrage.

The Business Agent, Brother Generson, made a very encouraging report and the Lodge has decided that it will join the Metal Trades Section and the Building Trades Council, of the American Federation of Labor; and our action in this regard has received the approval of our true blue good friend and associate, Brother John J. Dowd, Sixth International Vice-President, whose messages of timely advice to us, have made a lasting impression for good on all the members.

Fraternally,
DANIEL B. MCINNES,
C. D., Lodge No. 585.

Decatur, Ill.

Dear Sir and Brother:

Life is like the morning rose. We never know when its life shall close.

On January 9, 1915, at 10:30 A. M., God called Mrs. Emma Abbott, the wife of our Brother Earl Abbott, home to her reward. He that is wise in all things always takes that which is best.

We, the members of Lodge No. 447, mourn with our brother. May God grant rest to the family in their hours of sorrow.

EDW. E. IVEY.

It is swet to be remembered and a pleasant thing to find that, though you may be absent, you are still kept in mind.

There was born to our Brother Leo Singer and wife a little boy on New Year's Morn, but God called the little soul home on January 3, 1915.

We mourn with our brother. May God help the mother and father bear their burden. We, the members of Lodge No. 447, extend our sympathy to the family.

EDW. E. IVEY, JR.,

Correspondent.

Rocky Mount, N. C.

Dear Sir and Brother:

That there now exists amongst the various labor unionists upon railroads considerable difference of opinion regarding the question of kindred amalgamation, as there is also commendable reasons to believe this issue is the outgrowth of modern industrial development augmented by the fact that engagement with railroads in recent years have approximately rendered scant encouragement, admitting a fair percentage of this showing can be attributed to a dominant inactivity. The question of amalgamation, closer alliance or industrial organization is of essential importance, and must be met with logical argument. For this purpose, and in view of the fact that our International Officers in their last executive session was requested by International President Johnson of the Machinists, to give this proposition consideration. I am of the opinion a few remarks along this line will not prove objectionable. While I appreciate the many contentions and in favor of this movement and believe the agitation will tend to stimulate and keep alive the militant spirit. I am also convinced there must be taken into account a factor of safety, or more properly expressed. Precautionary measures in controlling the destructive tendencies which are generally rampant to any change.

Let us dwell briefly upon the question of Federation, in the prospective, this is our adopted policy, considering the scope and expectations that may be realized "in this direction." To me it seems this work is scarcely begun. I see no better plan to bring together to educate and train the workers for United Solidarity, and until it has been demonstrated that federation is

inadequate to meet satisfactorily the needs of the workers, we should render every available assistance in extending this work. There is considerable speculation as to what form of organization will be necessary in measuring up to that standard, which will measure within a reasonable degree, concessions proportionate to the financial expenditures and energy put forth, class action. Industrialism, kindred amalgamation and craft unionists have their sponsors, but upon the plan of federation is placed the stamp of indorsement.

Then necessarily and logically the imperative duty of railroad trades is to yield harmoniously in perfecting this plan of organization. There is liberal assurance, the expected energy in furthering this work will bear fruit in due seasons, experience invariably teaches, without unnecessary sacrifice or waste at least. To insure genuine and lasting benefits it is best to adhere to the principle of expediency. Notwithstanding we at times can see in the distance, visions of more promising achievement.

We can at best keep step with the standard of intelligence or the strength of mental reasoning. Herein lies our greatest difficulty, educational improvement to grasp the situation as one of business in which we all must play our part. The plan adopted by the Kansas City convention of the R. E. Dept., as I wrote on previous occasions is well balanced and there is a vast field for active endeavor in co-operating and placing on a workable basis the plans outlined. There is I freely anticipate with this divisional plan of federation of federations, solidified for joint action more than a favorable prospect of commanding national attention. In this event we should be just as well able to establish our position as the transportation organizations.

I desire to add in conclusion railroad drafts will do well to work hand in hand in facilitating this work, which on close inspection will be found comparatively in line with the general trend of progress.

Trusting your limited space will permit, I remain, with best wishes,

Fraternally,

A. J. DIXON.

Banford, Fla.

Dear Sir and Brother:

I wish to inform you of the accident that happened to Bro. George Randall on Sunday, Jan. 3rd; he was run over by an automobile and had his right leg smashed. He is in a critical condition, in the hospital at Waycross, Ga.

J. H. SHUMAN,

Rec. Sec.

Roslindale, Jan. 11, 1915.

Dear Sir and Brother:

On Friday evening, January 8, 1915, Norwood Lodge No. 281 held their regular meeting and installed their officers for the en-

suing year. Brother Lidington officiating in the chair and I wish to say that Brother Lidington deserves to be congratulated for the efficient manner in which he conducted the installation of officers, also for the kind words of advice he tendered to the members present.

After all the important business being concluded, the refreshments and entertainment committee got busy, under the chairmanship of the Baltimore lightweight, which he conducted in an excellent manner. It was an interesting sight to see our Davy, the wee Doc and Doran slinging out the refreshments with a regular old costermonger cry, with the able assistance of Bro. J. Donovan, Bro. Lee and Bro. Dolly Gray, the renowned old boiler buster. Bro. Jas. Flynn, our sergeant-at-arms was there with bells on to grab anybody who did not the renowned old boiler buster. Bro. Jas. strictly adhere to the rulings of our honorable chairman.

During the entertainment, the gold dust twins were admitted i. e. Okie the kid, and Panama, the heavyweight. Okie gave us his old favorite song entitled, "The Old Wooden Bucket," which made us all sad for the time being, on account of the big tears rolling down the poor kid's face. Panama, the heavyweight twin gave us a recitation, which to tell the truth I can't recall, which probably is just as well, for my wife says I talk in my sleep, sometimes, so believe me if ever I come to go over that recitation in the middle of the night and my wife should hear it, it would be good night for me. O you Panama and O Kie!

At this time our worthy chairman, Bro. Bussey made a great hit with his old favorite monologue entitled, "The Wandering Jew Who Murdered the Ould Pig in Donegal."

Our vice-president, Brother Paton, entertained us with his old favorite song "Deer Island Down the Bay." Then up steps to the front, Sammy the Italian kid, with his war song. I could not tell the exact words of the song as I am not an expert interpreter, but just the same we thought it was alright, although it was a little high toned.

Our dear old Billy Brown, the pride of the Fairmount Hotel was there with old wind jammer bellows slinging out the music to perfection. The last we saw of him was about eight miles from our meeting hall, and his old bagpipes were still screeching, "It's a Long Way to Tipperary."

Jock Anderson was there with his new hat on, and strange to say, Jock got his lid safe home, which is a wee bit unusual for Jock.

Another of our celebrated artists was there, Johnny Scott, frae the auld toon O Dundee and gave us his old favorite, "She Cost Me Seven and Sixpence." The water Willie.

Taking everything into consideration, we had a very enjoyable evening and although everyone of the members who were present has and is passing through a most critical

and financial period, you could see nothing but smiling faces and behind those smiles you could see a determination to stand together, united to a finish.

There is one of our most genial members whom I almost forgot to mention, our own dear little sloan, our boiler maker jockey, bowling expert and beer slinger. Good boy Tod.

In conclusion I wish to tender the thanks of your humble servant and the members of Lodge No. 281 to the committee of arrangements for their painstaking efforts in making our entertainment a pronounced success.

ROBERT HENDERSON,
Cor. Sec. Norwood Lodge No. 281.

Waycross, Ga.

Dear Sir and Brother:

Last Sunday morning at Sanford I was run down by an automobile and rolled and dragged for several yards. I came out with my right leg broke above the ankle and bruised and smashed all over.

I was taken up and hustled up here to the company's hospital and will not get out for three or four months as the break in my leg was an exceptional one. For four inches of bone were smashed to splinters and broken off at both ends, making a bad place to heal quickly. I was in such agony that I forgot to give instructions about the lodge business, and things may not come very regular or straight until I get my hands on them again.

I would like for a notice of my accident to appear in the Journal so the boys that are in our jurisdiction will know why their letters are not answered.

Hoping this is satisfactory, I am

Yours fraternally,
GEO. RANDALL, S. L. 422,
A. C. L. Hospital.

Chicago, Ill.

Dear Sir and Brother:

Will you kindly insert the following in your February edition of the Journal and oblige the member of Local No. 1, Chicago, Ill., Jno. Burke, Secretary.

To my brothers and friends who so generously purchased tickets for the benefit raffle that was given under the auspices of Local No. 1. The raffle was postponed from December 9th, until January 9th and the lucky number that won the watch was held by Brother Jno. Magee, No. 167. I take this means for thanking my many brothers and friends for their kindness.

Yours sincerely and fraternally,
MICHAEL CLEARY.

Indianapolis, Ind.

Dear Sir and Brother:

A few lines for the Journal for all boiler makers and iron ship builders and helpers to stay away from Indianapolis, iron workers are doing our work.

Yours fraternally,
WM. S. FROHLINGER, C. S. 10.

Ludlow, Ky.

Dear Sir and Brother:

Your favor of January 6 at hand. Inclosed you will find list of officers installed at our last meeting. I wish to state we had a full attendance. Immediately after the meeting we enjoyed a Dutch lunch with refreshments and cigars. All enjoyed the entertainment given by the brothers. Nearly all the brothers gave a recitation or sang a song. The star of the evening, however, was our president, Brother Chas. Grainger, he is some entertainer, believe me.

Business is not very good in this vicinity at present, but hope to give a better report in the near future. I am in receipt of a telegram from Grand President Franklin, advising me of strike in oil fields in Oklahoma, Louisiana and Texas. Have advised all brothers not to go in that direction.

Hoping to see this in the next issue of our Journal, I remain,

Fraternally,
D. L. O'BRIEN,
Lodge No. 105.

Nevadam, Mo.

Dear Sir and Brother:

Can you find room for these remarks in the Smiles columns of our Journal?

The most stupendous joke of the universe is the educated ignoramus.

With every increase in knowledge there comes a corresponding increase in responsibility.

Some men and women can be bought with money, others with position, others with flattery.

Just as it's unmanly to fight, when seeking personal reward, so it's unmanly not to fight, when duty calls, and we are restrained only by fear.

When a mother fails in her high and sacred duties toward her child, that child is very liable to fail in its high and sacred duties toward the home and the world.

The world will find itself many miles toward the higher goal, when men become as much interested in better bred boys and girls as they are now interested in better bred horses, cows, sheep and hogs.

No boy or girl has been properly educated unless they have been taught to do nobly and well some definite work—some service that goes to complete the total of the world's toil.

Men who sit in the house do not see the house in which they sit, they see the house across the way; or, marching in a parade, they do not see the parade, they see the folks along the way. Sometimes we know less about ourselves than those who stand about us.

It may not be ours to increase the bulk of our brain or our body, but we can increase—beyond measure—the value of each. The mind is to be cultivated and seeded; and it will produce accordingly. It is ours to reap what we sow, in the gardens of the mind.

Men are often accused of being inconsistent, when the fact is, facts are inconsistent. To ponder certain facts, approached from different angles, will lead to two, and sometimes three widely separate and pronouncedly conflicting decisions.

If you don't agree; just try pondering a few facts.

L. E. WHITEHEAD.

Lima, Ohio.

Dear Brothers:

I have read Journal for January, and have read with pleasure the report of Brother Joe Reed, Deputy Organizer, Pacific Northwest, and I would like to use a small space in our Journal to let Brother Reed know that an old friend of his, situated now nearly across the continent from him, has watched his work in our behalf, with interest. I was working with Brother Reed when he was elected business agent of Lodge No. 72, Portland, Ore., and made my home with him for some time, and I know Brother Reed to be a union man in every respect, and a hard worker in the interest of our Brotherhood.

I read with pleasure of his statement where he informs us of the progress he is making with the Willamette Iron Works of Portland, and when I read that I read good news. Any Brother who has ever stopped in Portland will realize just what this means for the Brotherhood, as that shop is one of the very few well-equipped shops on the coast, and has always been very antagonistic to organized labor, locally and otherwise.

This is certainly a boost for us and a boost for Brother Reed. I am glad to count Brother Reed among my friends, and take this means to thank him for the gains he has made in his territory for us.

Hoping Brother Reed will always continue with the same success and that some of the brothers in Lodge No. 72 will remember me, and wishing them all a successful and prosperous new year, I am,

Yours fraternally,

A. THOMPSON.

Beaumont, Tex.

Dear Editor:

I note an article in January Journal written by Mrs. John Cure that forcibly impressed on me the necessity of the wife's interest and co-operation in the affairs of our organization. Faithfully has she portrayed life's lofty ideals. Her voluntary efforts toward her husband's happiness cannot go unnoticed. Her interest in his personal welfare infuses into the article that which is divine and beautiful in womanhood. The priceless value and far-reaching influence of the wife or mother cannot be over-estimated. In life's arduous toil and through the most depressing circumstances, she still maintains her cheering thoughts of harmony which is wafted to you from the pure soul of the individual. I hope the

day is not far off when every wife and mother takes an active interest in our organization and furnishes favorable environment for the upbuilding and progress of our craft.

G. SPRATLEY.

THE BOILER MAKERS' RIDE.

By G. Spratley.

When I was a boy the boilers were made
Of common iron, and a very good grade;
The rivets were hammered and the flues
were rolled,
Hand chipped and caulked, in those days
of old.

How well do I remember the old iron track,
The cross-head pump and the diamond
stack;
The well-kept jacket and its polished bands,
The neat tin tally in the fireman's hands.

The engineer would say: "If you want to
ride,
If you've got a card, get on the other side."
He'd lower the hook, she'd do her best.
"We're off," he'd say, "for the golden
West."

But in these days of the six-foot wheel,
With boilers that bend, and made of steel,
The rivets are bulled, the mur-ring slants,
The back-head's filling while the air pumps
dance.

She has superheater tubes, a cast-steel
frame,

And easily handles a mile of train;
Electric lights, flange rollers and outside
gear,

Twenty tons of coal quite close in the rear.

The engineer will say: "If you want to
ride,
Go back, get in a boxcar and hide."
He'll work the rabbit and she does her best.
Your're off (maybe) for the golden West.

Note.—The following night letter was received over the Western Union wires from Lodge No. 22, Danville, Ill., and consists of resolutions adopted on the death of Brother Gilthorpe:

Danville, Ill., January 15, 1915.

At a regular meeting of Lodge No. 22, Danville, Ill., the following resolutions were adopted upon the death of William Gilthorpe:

Whereas, He was a loving husband and a kind and indulgent father, an honest and upright brother who was always ready to extend the hand of fellowship to a brother, true to his friends, forgiving to his enemies, if he had any, and ever faithful to his obligations, whose wise counsel will be sorely missed by all;

Resolved, That we, the members of Local Lodge No. 22, city of Danville, extend our sincere sympathy to the beloved wife and children of William Gilthorpe and join with them in their hour of sorrow and pray that

God will send the Angel of Peace to them; and be it further

Resolved, That a copy of these resolutions be spread on the minutes of our regular meeting and a copy be sent to the official Journal for publication, also a copy be sent to the bereaved family, and our charter to be draped for thirty days.

J. B. KEENAN,
RAY SCHENK,
WILLIAM J. IRWIN.

Chicago, Ill.

Mrs. William J. Gilthorpe and Family:

The officers and members of Lodge No. 454 extend their heartfelt sympathy to you and your family in your hour of sadness, occasioned by the death of your beloved husband and father, and our worthy, esteemed grand officer, whose good work has always spoken for itself.

Resolved, That while we lament with sorrow, we must submit to the will of our Divine Maker, who doeth all things well.

Respectfully yours,

CHARLES A. LEAHY,
E. R. DETTMER.

St. Louis, Ill.

Dear Sir and Brother:

Please find inclosed new roster of the new officers elected for the ensuing year for Lodge No. 377 of Moline, Ill. If you have space in the next issue of Journal, please insert same.

Carl Robison, president; John Parel, vice-president; William Murphy, recording secretary; C. R. Kizer, corresponding secretary; John Fulton, financial secretary; Carl F. Hipskind, treasurer; Charles McGown, business agent; John Gustavison and J. R. Kyle, trustees.

Wishing you a Happy and Prosperous New Year, I remain

Yours fraternally,

C. R. KIZER,
Cor. Sec. Lodge No. 377.

Chattanooga, Tenn.

Dear Sir and Brother:

Inclosed herein find copy of resolutions adopted by Lodge No. 14 relative to the death of Mrs. Anderson, wife of our worthy secretary, which please publish in our Journal, and oblige Lodge No. 14.

Yours sincerely and fraternally,

JACK GRIBBEN.

At the regular meeting of Lodge No. 14, Chattanooga, Tenn., the following resolutions were adopted:

Whereas, It has pleased the Almighty God in His divine wisdom to remove from this life the beloved wife of our worthy and esteemed brother, James F. Anderson, secretary of Lodge No. 14; therefore, be it

Resolved, that we, his brothers, extend to Brother Anderson and his family our heartfelt sympathy in this their sad hour of bereavement and pray that the Almighty

God may comfort and console them that they may bear their trial with Christian patience.

Mrs. Anderson died after a protracted and painful illness, which she endured with Christian fortitude and resignation. In early girlhood she affiliated with the church of her belief and was always a consistent member, a loving wife and mother and dearly beloved and esteemed by all who knew her; and be it further

Resolved, That these resolutions be spread on the minutes of Lodge No. 14's meeting and a copy sent to our bereaved brother, a copy to our official Journal for publication, and that the charter of Lodge No. 14 be draped for thirty days.

JACK GRIBBEN,
J. E. EVANS,
WILLIAM QUIGLEY,
Committee.

Danville, Ill.

Dear Sir and Brother:

A noble man, indeed, a loving father, a kind husband, a true friend, a good mechanic, a true union man was Brother Al Ranking, who for 43 years gave his life to others. God called our brother home on Thursday, January 4, 1915, at 10:20 p. m. He was stricken with pneumonia while at work, just one week to the day that he died.

This brother was a native of Indiana; Fort Wayne was his home. He leaves a wife and son, and we, the members of Lodge No. 447, do extend our sympathy to his family.

May God grant that we meet the noble soul in the Great Beyond.

Thoughts for Companions.

Just as the pansy petals fold
Closely about their heart of gold.
So in these lines may there be
Enfolded golden thoughts for the dear
friend who is far away,
Yet have you in their heart today,
And thoughts of all the happy past,
The sweet, sweet days that couldn't last.

CORRESPONDENT.

Newport News, Va.

Dear Sir and Brother:

I am inclosing you a copy of the resolutions adopted by Lodge No. 55, extending to the relatives of our deceased brother, W. L. Wurzbach, our heartfelt sympathy, for publication in our official Journal.

Yours fraternally.

T. F. RICHARDS,
Cor. Sec. Lodge No. 55.

At a regular meeting of Lodge No. 55 the following resolutions were adopted:

Whereas, It has pleased the Almighty God in his divine wisdom to remove from our midst our beloved brother, W. L. Wurzbach, we realize the loss is great to his father, mother, sisters and brothers, but remember the words of our Saviour, "Not my

will, but thine, O Lord, be done"; And be it further

Resolved, That we, his fellow brothers, extend to his father, mother, brothers and sisters our heartfelt sympathy in this sad hour of bereavement and pray that our divine Savior will comfort them in their inconsolable loss. Be it further

Resolved, That a copy of these resolutions be sent to the bereaved family, a copy spread upon our minutes and a copy forwarded to our official Journal for publication.

W. F. McCAULEY,
JAMES C. McINTYRE,
W. M. LE COMPTE,
Committee.

Balboa, C. Z., Panama.

Dear Sir and Brother:

At a special meeting of our local, No. 463, Dec. 29, 1914, the following resolutions were adopted:

Whereas, It has pleased Almighty God to take from our midst our esteemed brother, Thomas Scheler,

Resolved, That we, his brother members who sadly miss him, extend to his family our most sincere sympathy and pray and hope the Almighty God may give them strength to bear their cross with Christian fortitude; and be it further

Resolved, That a copy of these resolutions be spread on the minutes of our meeting, and a copy sent to our official Journal for publication, and a copy to the bereaved family, and the charter be draped for a period of thirty days.

GEORGE F. WOOD,
ALEX MCKENZIE,
W. H. KEENAN,
Committee.

Norwood, Mass.

Dear Sir and Brother:

At a meeting of the system federation of the N. Y., N. H. & H. R. R. System, held in New Haven, Conn., Room 39 Insurance Building, December 23, 1914, the following resolutions were adopted:

Whereas, It has pleased our Heavenly father to remove from our midst our worthy brother, J. J. Gallagher, General Vice-President of the Brotherhood of Railway Carmen of America, therefore, be it

Resolved, That we, the delegates to the System Federation of the New York, New Haven and Hartford Railroad System, fully realize having lost one of our true and faithful labor leaders, a man of high ideals, an exemplifier of unionism in every respect, a believer in justice to all; his power will be sorely missed. As a loving husband and father, his place can never be filled by those who loved him best. Therefore, we extend our sympathy to his bereaved family and pray Almighty God may comfort and console them in their hour of sorrow; and be it further

Resolved, That a copy of this resolution

be sent to his family, a copy spread on our minutes and a copy sent to the official Journals of the following organizations for publication:

International Brotherhood of Boiler Makers and Helpers,

International Association of Machinists and Helpers,

Amalgamated Sheet Metal Workers' Alliance,

International Brotherhood of Blacksmiths and Helpers, and

Brotherhood of Railway Carmen of America.

Signed:

J. CARNIE,

For the Machinists;

ROBERT HENDERSON,

For the Boiler Makers;

J. P. CAVANAUGH,

for the Blacksmiths;

J. M. BURNS,

For the Sheet Metal Workers;

D. J. COLLINS,

For the Carmen.

REPORT OF PRESIDENT OF AUXILIARY NO. 10 FOR 1914.

Springfield, Mo.

To the Members of Auxiliary No. 10,
Springfield, Missouri.

Dear Sisters:—

While my report will be far from as encouraging as I had hoped to be able to make at the close of the year, still, taking into consideration our many disappointments and reverses, I feel that we, the few faithful that remain, are to at least be congratulated upon our faithfulness and energy in standing by each other and doing all in our power to prevent the little band from becoming extinct.

At the beginning of 1914 we had forty-six members; we now have twelve. We had in our treasury at that time \$21.90; we now have a balance of \$10.00. When we remember the fact that we lost \$34.87 by burglary during the year, and our membership has decreased until we have about one-fourth the number we had last year, it seems that we are more than holding our own in a financial way. While it is discouraging to have so many members drop out of the organization, it is not so hopeless to us who know the whys and wherefores of the case. It has not been merely a lack of interest. The first great blow came when we lost all our savings in a way that we can never hope to regain the amount, which caused many insinuations and remarks, which, as they always do, had a tendency to tear down rather than build up. Some members became offended at others; while others seemed to think it a loss of time and money to work and build up a treasury whose bottom could so easily drop out. About this time came the report from the International Convention, bringing the tidings that a per capita tax of 15c per member would be laid upon all auxiliaries for the purpose of maintaining a Grand

Lodge independently of the Boilermakers. Much to my surprise, this created consternation among the members of our lodge. While I felt this was the corner stone being laid for the foundation of the Auxiliary, others seemed to think it was some kind of scheme to get their money for which they would receive nothing in return, hence, the loss of about three-fourth of our members. I am merely stating these facts to show why our membership has fallen off so suddenly. While we regret the loss of these members, we feel that if we persevere, keep L. A. No. 10 alive, and prove our loyalty until such time as all can begin to feel the workings of the Grand Lodge and see and understand why a per capita tax should be assessed, our old members will begin to come back to us and new ones be added, until within a few years we will have a larger and more wide awake lodge in Springfield than we ever had before. At least we can profit by past experience and be a much wiser organization. We cannot have another loss of money, because our officers who handle money will be bonded and in case of any such loss, our interests will be safeguarded.

I will now proceed to enumerate some of the things for the good of the order that our Auxiliary has done during the past year. In the early part of the year a new set of local by-laws were drawn up and adopted by the lodge, but through some misunderstanding on the part of the secretary, were never submitted to the Grand Lodge officers for approval. When we discovered the mistake, it was so near the date for the convention, we decided to await until we saw how many were embodied in the new International Constitution before submitting them for approval. The President called a special meeting for all the officers of the lodge, when a whole afternoon was devoted to studying and instructing the officers in their duties in the lodge room. In the early summer we donated \$5.00 to a purse that was being made up for the purpose of a helper reported to have tuberculosis, to go to Arizona for his health. By securing a benefit show at the Jefferson Theatre and selling tickets on 50c commission, we were able to contribute to the Carl Person Defense fund the sum of \$47.15. With a view of adding a little more to our treasury, we organized the New Idea fancy work club, the dues being 5c per member per meeting, which amount was to go into the Treasury of the Auxiliary. Later when many new members not belonging to the auxiliary were taken in, the by-laws of this club were changed and the dues were put in the treasury of the club. However, at each meeting, some member of the club donates an article to be raffled off for the benefit of the auxiliary.

The New Idea Club adds greatly to the social side of our work. We have also had quite a few social gatherings among the members of the Auxiliary and their families, which were fully enjoyed by all. The anniversary of the organization of the Auxiliary was celebrated in a very appropriate

manner in the home of Mrs. A. E. Welch. Another affair which was a great success was a farewell party given Brother and Sister Raden just before their departure for their new home in Sapulpa. Many little surprise parties and showers have been given members who are unable to attend lodge, which is a pleasure to all parties who participate, and causes a feeling of good fellowship to exist between the members.

In the early fall, the Local No. 70 of the Brotherhood, who had until that time been kind enough to pay our hall rent for us, notified us that our organization had become so small that they could not see their way clear to pay our rent longer. We held one more meeting in the hall, and after discussing the matter, decided it would be wise until such time as the membership increased sufficiently to warrant us in renting a hall, to meet in some private home. Sister Gestring kindly offered her home for a meeting place, which offer was gratefully accepted. Since that time we have been meeting in this home, and while we appreciate the hospitality and courtesy of Sister Gestring, we hope to be able in the very near future to relieve her of this burden and move into a hall where we will have ample room to carry on our work as we did last year. Since meeting in this private home where we have not space to go through with our regular work, we have decided to improve our time by studying unionism in all its phases, and further equip ourselves by studying parliamentary law. Therefore, by a vote of the lodge, the last meeting in each month is devoted to two papers on unionism and a parliamentary drill, in addition to the regular routine of business. We feel that we have been greatly benefited by these papers and drills, and perhaps have gotten more good out of our little "round table" and heart to heart talks than we would have gotten out of our regular lodge work had we remained in our old quarters.

While this is not a very flattering report, I feel that a great work has just started in L. A. No. 10, and have great confidence and faith in the members we now have. I appreciate your help and support and hope to be able to secure about a dozen new members of the same material and energy, when there will be no question as to the success and future of our Auxiliaries.

Respectfully submitted,
MRS. A. F. BINGHAM,
President L. A. No. 10.

Mechanicsville, N. Y. Jan. 22, 1915.

Dear Sir and Bro.:

Enclosed find Resolutions adopted at our last regular meeting:

Whereas, It has pleased the Almighty God in His Divine Wisdom to be moved from our midst, our beloved and worthy Brother Morris Forelick,

Therefore, Be It Resolved, that we, his Brothers, extend to his family our heartfelt sympathy in their hour of sorrow and pray

that the Almighty God may comfort and console, that they may bear this trial with fortitude; and be it further

Resolved, That a copy of these Resolutions be placed on the minutes of our meeting, and a copy be sent to the Official Journal for publication.

SIDNEY CROZIER,
THOS. BALDWIN,
J. FEELEY,
Committee.
Per W. A. SAUNDERS.

Springfield, Mo.

Let each and every union man look back over the past few years and see the good that has been accomplished by organized labor.

They have worked hard for what they have gained, as we know, now let them go in their home and talk the advantage and the good that can be derived from the demanding of the union label, and by explaining the good they can do for the cause of the laboring class by organizing themselves in Auxiliaries, and the men that will take this trouble on themselves to do this will generally find the wife, mother or sister willing to do all they can to help the cause.

The working man who joins a union must bring himself to realize that if he gets anything out of it he must pay the price; let him take his family in full as a partner and get them interested in his own welfare and he will find their service of great benefit.

Therefore, let the few women that are organized go among our sisters that are not organized and explain to the best of our ability, the good that has been done for home and family and what can be done if we work for the cause of labor unions not for ourselves alone, but for the vast multitude of men, women and children, though we know the world is full of people willing to accept anything that comes without an effort on their part; therefore, the few that are willing to do their part are all too scarce to do much good without help; let each one that is willing to help assume an attitude to those that are not of the helping kind that will show them a cause that is worth working for. At the close of the coming year let each one look back and say, "I have tried."

MRS. WM. SPECHT,
L. A. No. 10.

Chicago, Ill.

I desire to call the attention of our readers to the article of Brother Franklin's in the January Journal relative to two letters from Lodge 220, published in same Journal.

I do not think his criticism just and fair as it reflects upon the intelligence of the members of No. 220, and it is as unwarranted as it is inexplicable.

You will note one of No. 220's letters was written October 6th, the other November 3rd, a month apart, the subject matter of the first letter was requesting Brother Franklin to take up with the other organiza-

tions affiliated with the R. E. Department, a question relative to calling off the strikes on the I. C. & Harriman lines and to put out a referendum vote in our Brotherhood to that effect.

You will note that there was nothing said in this letter about strike benefits, as anyone might know if the strike was called off the benefits would be discontinued. This letter was requested published, however, there was no objection to its being published in the Journal, but if he wanted it published, why didn't he publish it in the November or December issue of the Journal, but instead he waits until he gets the other letter a month later, then runs them in the Journal, and speaks of the inconsistency contained in the letter of November 3rd, which I cannot see, and I don't think anyone else can conscientiously see, as one might be in favor of calling off the strike, but not in favor of discontinuing the strike benefits until it was called off, and that is exactly the position that the members of No. 220 took that was in favor of calling off the strike, they wanted steps taken to call it off, and that is what prompted the protest letter of November 3rd, for the ballot itself when sent out conveyed the fact that the strike benefits would be discontinued on Dec. 1st, 1914, and the members was opposed to discontinuing the benefits until the strike was called off or finally settled and there is nothing inconsistent about that and is plain enough it seems to me for the ordinary intelligent to understand.

If Brother Franklin had a feeling of criticism in his heart and felt in a writing mood he should have taken up A. O. Wharton's letter, as there is a wide field for criticism in his communication, almost every paragraph is open for severe criticism, as in many places he makes absolute false statements, in fact his whole article sounds like the dictations of the railroad companies.

But I will not say anything further upon these subjects and will leave them to the judgment of the rank and file.

With best wishes for a prosperous new year, I am,

Yours fraternally,
I. J. CUNDIFF,
Lodge No. 220.

Ft. Worth, Texas.

Dear Sir and Brother:

By special request I am writing to give you a little news regarding a little stunt that was pulled off by a bunch of the members of Lodge No. 96, who have been erecting a fifty-five thousand barrel steel tank at Kennadale, Texas, for the Magnolia Petroleum Co.

This gang has been selected from the men who have been employed on the erection of the refinery being constructed here by the Magnolia Company to build tanks in various places in the state, which, when completed, will form a chain of tanks from here to the Gulf of Mexico.

While working in Kennadale, the men conducted themselves in such manner as to gain the friendship and respect of all the citizens. Whenever there was to be a social affair of any kind the men all received an invitation. To say that they enjoyed themselves would be putting it very mildly. They enjoyed themselves to the limit and to show their appreciation, they decided that when the job was completed they would return the favors shown them.

With this in view they appointed a committee of three to make the necessary arrangements. However, the whole gang, twenty-nine men, decided that the occasion demanded the attention of all concerned, so they lit into it with a will and the ultimate result was one of the most unique as well as one of the most entertaining social events ever pulled off in this section of the country.

Part of the committee secured feeds of all kinds, including a good supply of oysters and the necessary trimmings to go with them. Fruits and candies and everything else to make the eating part of the occasion complete were secured and the committee deserves special credit for their efforts.

The banquet hall was the tank that had just been completed. The tables were laid in the tank and all the citizens invited.

The doorway to this banquet was a thirty-six inch manhole, which, all who attended the banquet were compelled to negotiate.

The writer not being present cannot speak from experience, but from all accounts there was some excitement attached to the taking of the password and admitting those qualified to a seat in the hall.

However, when all had arrived it is said that there was not a man, woman or child, who resided in this vicinity who was not in the hall. Of course some of the fat folks had a rather strenuous time getting in and after the banquet they had a worse time getting out.

Some of the ladies objected to this mode of entering and retiring but being assured that there was no other method except to go over the top by way of a block and fall they all slid in.

The committee had borrowed an organ and as there were several musicians in the crowd they were well able to entertain the crowd.

Several speeches were made by various members of the organization thanking the citizens for the courtesies extended.

The citizens through their representative men and women responded and after one of the most enjoyable events of the season, the guests and hosts departed about midnight to their homes, the guests with a better understanding of what a bunch of organized men really are.

The papers of Ft. Worth had a representative on the job and their staff photographer who made a flashlight picture of the whole bunch.

I am sending you under separate a cut of the picture which we hope you will be able to reproduce in the journal.

Will further state that this section of the state is one hundred per cent organized and if you are coming this way have your ticket in good shape.

Thanking you in advance, I remain,

Yours fraternally,

L. A. FREEMAN.

Pittsburg, Pa.

Dear Sir and Bro.:

At the last regular meeting of Lodge No. 154 the following preamble and Resolutions were unanimously adopted:

Whereas, humanity in general, and the labor movement in particular has suffered a distinct loss in the passing to the Heavenly Throne of our late veteran I. S. T. Bro. Wm. J. Gilthorpe, and

Whereas, We recognize the many years of faithful service of Brother Gilthorpe was a great factor in bringing the recognition and influence exercised by our craft today, and

Whereas, We realize that the achievement of Brother Gilthorpe constitute a movement more durable than any of stone or bronze, so be it

Resolved, That Local No. 154, Brotherhood of Boiler Makers, Iron Ship Builders and Helpers of America extend our sincerest condolences to the bereaved family and beg them to accept the wisdom of Almighty God in calling to His bosom a faithful servant, a loving husband, and father, and a follower of the teachings of the Redeemer, and be it further

Resolved, That a copy of these resolutions be sent for publication in our Official Journal, a copy furnished the bereaved family and a copy preserved for the permanent records of Local Lodge No. 154, and be it further

Resolved, That as a further token of our love and respect that our charter be draped in mourning for a period of thirty days, and the Lodge participate in a service in the memory of the deceased.

FRANK BANN,

President.

JAMES P. CARR,

Business Agt.

JAMES G. SAUSE,

JOHN O'FLAHERTY,

PETER McLAUGHLIN

WM. WIGLE,

Committee,

A Compilation of Labor News.

BY THE A. F. OF L. NEWS SERVICE.

CONGRESS PASSES IMMIGRATION BILL; IS NOW BEFORE PRESIDENT WILSON.

Washington, D. C.—The Burnett immigration bill, containing the illiteracy test, has passed both branches of Congress and is now before President Wilson for signature.

The bill originally passed the House nearly a year ago—February 4, 1914—by a vote of 252 to 126. Since then it has been in Senate committee or in conference between the two legislative bodies because of amendments. At no time was the illiteracy test questioned, except in the Senate, early this month, when a motion to strike it out received but twelve votes.

On Friday of last week—January 15—the House, by a vote of 227 to 94, gave final approval to the bill. The day previous the Senate accepted the bill by a yea and nay vote. The House won its point to strike from the bill a section inserted by the Senate which would admit Belgians to our shores regardless of all immigration laws.

With the passage of the bill closes one of the most fiercely contested battles of this Congress. Against the proposal was arrayed large corporations and steamship companies, together with every ally these powerful forces could muster.

In the House the bill was debated for five days. An analysis of the vote shows that from twenty-one states every vote cast was for the bill; thirteen states gave a majority for the bill; three split even; six gave a

majority against the bill and only four voted solidly against the bill—Connecticut, New Mexico, Rhode Island and Utah—or ten votes.

In answer to the claim that the south and west favor unrestricted immigration, it is shown that the vote in favor of an illiteracy test was: southern states, 78 to 6; southwestern states, 33 to 9; northwestern states and the coast, 38 to 14, the Pacific Coast alone being 17 to 1.

The struggle to insert an educational test in our immigration laws has been waged for eighteen years. May 20, 1896, the House of Representatives favored a test by a vote of 195 to 26. During these years there have been 19 votes in favor of a reading test. Three of these were votes taken in committee of the whole, and 16 were votes in regular session of either the House or Senate. There have been seven record votes in the House, the average being 192 to 73 for the test; the five record votes in the Senate show an average vote of 52 to 19.

The following legislatures have asked for restrictive legislation: Arkansas (House), California, Massachusetts (House), Nevada, Ohio, Oregon, Pennsylvania, Tennessee, Vermont, Virginia, Washington and Wyoming.

The A. F. of L. has repeatedly declared for a test. At the Toronto convention, in 1909, it was agreed: "The illiteracy test is the most practical means of restricting the present stimulated influx of cheap labor,

whose competition is so ruinous to the workers already here, whether native or foreign." This position has been sustained by the railway brotherhoods and the organized farmers of this country, who have repeatedly declared in their conventions for an educational test that American standards may be maintained. In a recent issue of the National Field, official journal of the Farmers' National Union, a strong editorial in favor of an illiteracy test closed as follows:

"Time was when the generality of people could not read or write in any language. And in that time no shame attached to them, or any one else, except the despotisms which needed ignorance in their business. The same despotic spirit is behind all this piffle about 'the honest, the industrious, the moral' type. Much they care for the real welfare of this type.

"What they want is plenty of cheap laborers. After trustifying the industries through special privilege legislation on one hand, and pauperized labor on the other hand, they are now turning to the blessed vision of 'trustifying' agriculture."

HATTERS' CASE DISCUSSED.

Executive Council States Position of A. F. of L.

Washington, D. C.—At the meeting of the American Federation of Labor Executive Council, held in this city, much time was devoted to a consideration of the judgment of the United States Supreme court against the Danbury, Conn., hatters and the Hatters' Union. Officers of the Hatters' Union were heard and consultations had with attorneys for the A. F. of L. who conducted the case, while consideration was given various suggestions by unionists regarding this matter.

The conclusion reached is as follows:

"The executive council, while feeling that a great injustice has been done the hatters, finds that, despite that feeling, that the American Federation of Labor has neither the means nor the authority to pay the award or the damages, in whole or in part. The suit was brought by the Loewe company against the hatters; later, when the United Hatters of America were financially unable to bear the expense of defending the case in the courts up to and including the appeals to the highest courts of our land, the American Federation of Labor pledged itself to financially aid in the procedure. This pledge, contained in the resolution adopted by the Denver convention of the A. F. of L., has been fully performed. The American Federation of Labor, by its activities, growing out of the necessity as developed in the hatters' case, has secured the enactment of the labor provisions of the Clayton anti-trust law, October 15, 1914. This law precludes the possibility of any similar suit being brought in the federal courts for the exer-

cise of normal activities as performed by the hatters, when such activities have been performed since the enactment of the law, and thus the Federation has performed its full duties to the hatters and to all labor in the premises."

FAVOR COMPENSATION LAW.

Jefferson City, Mo.—In its favorable report on the question of workmen's compensation to the state senate, a commission appointed by that body exempts from the proposed law's operation domestic service, farm labor and employment of three or less employes. The commission says:

"The social principle upon which laws (compensation) are founded is that industry should bear the burden of its accidents and distribute the cost upon the consumers of its products, as it does other cost items. One of the principles of justice upon which this proposition is, that modern industry can be easily, intelligently and universally done. It therefore follows as a corollary, that there should be no compulsion to any employment which is not so organized that it can easily, intelligently and universally distribute this cost."

The commission shows by figures that a compensation law not only has humane qualities, but it possesses merit as a tax-saver. Statistics from California, Wisconsin and Massachusetts are used to illustrate this point. It is shown that in these states there were 84,633 accidents in one year covered by compensation law, and only forty of them reached a law court. The commission makes this comment:

"On the basis of 50,000 accidents a year in Missouri, only eighteen would get into the courts, whereas now such cases constitute more than 10 per cent of all judicial business."

Opposition to a compensation law is assured. Meetings have been held between Kansas City and St. Louis business men for the purpose of making plans to fight the proposal. The familiar claim is made that the law would put "an unreasonable burden on industry."

DANGERS ON GREAT LAKES.

Washington, D. C.—The excursion and passenger boat interests on the Great Lakes are among the most bitter opponents of the seaman's bill now pending in the United States Senate.

Last week a memorial was presented from the Michigan legislature against the seamen's bill, in which it was urged that proposed laws against Great Lakes shipping was unnecessary, as "steamers are passing and repassing each other at very short intervals, so that assistance is always near at hand in the case of any accident."

In answer to this claim, Senator La Follette had inserted in the records last year's report of Chicago public school authorities on "Lake Boat Excursion Dangers," which stated:

"It was found that the boats only carried lifeboats and life rafts to save the lives of 30 per cent of their passengers, and this means that a boat licensed to a capacity of 2,600 to 3,000 passengers during the excursion period—May 15 to October 15—would be able to provide life rafts for less than one-third on board if the boat was crowded to its capacity. These boats are crowded to the rail on holidays and week-end trips. Life preservers are plentiful, but life preservers are not adequate protection for small children. The crews are small, and unless there is amended national legislation to compel excursion boats to increase their lifeboat equipment, personal safety on an overcrowded Lake Michigan excursion boat is a risk in which humanity must depend upon fate as to whether it would be numbered among the 'one-third saved' or the two-thirds that would be dependent upon life preservers. Among the latter would doubtless be many children with only a circle of cork around them to float their frightened souls to rescue."

A WARLIKE SOLON.

Denver, Col.—The Honorable Alphonse P. Ardourel, member of the state legislature, is the latest to offer a remedy against strikes. According to the United Labor Bulletin, this warlike solon will include strikes in the list of things treasonable. The penalty will be death. Mr. Ardourel has it all figured out. At the present time there is no penalty for resisting armed cossacks or private armies in the pay of corporations. By defining this as "rebellion," and making Colorado the first state in the union to provide a penalty for treason against the state, the legislator is confident that agitators will disappear and this commonwealth will become the proverbial land of milk and honey.

HOLLAND TRADE UNIONISTS TELLS STORY OF BELGIUM'S MISERY BECAUSE OF WAR.

Washington, D. C.—At the last meeting of the A. F. of L. executive council it was ordered that the following appeal be printed in the American Federationist and the A. F. of L. Weekly News Letter:

"Nederlandsch Verbond Van Vakvereeningen.

"(Dutch Federation of Trade Unionists.)
"Headoffice: Reguliersgracht 80, Amsterdam.

"Amsterdam, December, 1914.

"To Trade Union National Centers:

"Dear Sirs and Brothers: It is more than four months now since the Belgian people were, against their own will, forced to take part in this war which has set aflame the larger part of Europe. For more than four months the war, with all its horrors, has completely paralyzed the economic life of that little country, plunging the whole population and especially the working classes into the most pitiful misery.

"It will scarcely be necessary to explain to you in detail the general condition prevailing in a country so ravaged by the war. You have, no doubt, learned all this from the daily press of your own country.

"It appears necessary, however, to call your attention to the consequences this war has had for the Belgian laboring classes.

"Work had been stopped in all factories and workshops the first day hostilities commenced, condemning the employes who were not called upon to defend their country, to the terrible consequences of complete unemployment.

"One part of the country after the other has been conquered and occupied by German troops. Wherever battles and other military engagements took place, the inhabitants had to leave their dwellings fleeing to some other city or to some other part of the country, under continual fear that they might soon be compelled to flee anew to some new place of refuge.

"It will be easily understood that under such conditions unemployment has developed to such an extent that the trade unions are powerless and unable to effectively fight the miseries accruing therefrom.

"Everything necessary has been suggested and done by all public boards where the workers are represented, with a view of providing for the maintenance of this unhappy, semi-starved population. Food has been distributed on a very modest scale and, once in a while, money as well.

"All this, however, is in no way sufficient to keep the workers, their wives and children alive. Extreme misery prevails all round and this threatens to become more acute with the approaching winter.

"The Belgian trade unions have used possible means to save their organizations from complete destruction and to support their members during these tragic moments, but there is a limit to everything and the means at the disposal of the Belgian trade unions are entirely exhausted.

"The National Centre of the Trade Unions of Holland (the Nederlandsch Verbond van Vakvereeningen), after thorough examination of this sad state of affairs, has decided to issue an urgent appeal for help on behalf of the Belgian fellow-workers. We have been communicating with the management of the International Federation of Trade Unions (President Carl Legien in Berlin), whom we informed of our intention. Whereupon we received his immediate reply was that he had taken notice of our plan.

"We now approach your organization, dear sirs and brothers, praying that you might render whatever help you can give to the Belgian unions who at the present moment are undergoing the most serious and sinister trial.

"Will you kindly take cognizance of the fact that our Belgian friends have been brought to these trist conditions without

any fault of their own and we are convinced that you will do everything within your power to render practical help to the Belgian working class which desires nothing else but to be permitted to continue quietly their efforts for the improvement of their economic conditions and their struggle for social liberation.

"Will you kindly forward your contributions as early as possible to the above address, to be sent to the Belgian trade union center from here. Let us express our sincere thanks in advance for all you can do.

"Awaiting your early reply, we beg to remain,

"Yours fraternally,

"J. OUDEGEEST,

President.

"On behalf of the Dutch Trade Union Centre."

COAL BARONS RETRACT.

Denver, Col.—President Lincoln's statement that the people can't be fooled all the time is recalled by the action of the Colorado Fuel and Iron company in publicly retracting former declarations regarding moneys expended by officers of the United Mine Workers' Union.

The company stated, several months ago, that these moneys covered a period of nine weeks. When President Welborn was cross examined by the industrial relations commission, he was compelled to acknowledge the statements were untrue. The company has now issued another bulletin, which states that the moneys expended by Vice-President Frank Hayes, Mother Jones, and others were for one year instead of nine weeks.

Having in mind the operators' disregard for state laws, which caused all the trouble in Colorado, unionists are asking what this closing declaration by President Welborn means:

"No company can succeed permanently which does not deserve and receive the confidence of both its own employes and the public. It is the policy of the management of the Colorado Fuel and Iron Company to command this confidence."

MINERS ADOPT NEW PLAN.

Lanford, Pa.—Officers of the United Mine Workers' Union have been notified by state mining officials that their request to appoint a committee of mine inspectors to investigate a colliery at this place has been granted. The mine is owned by the Lehigh Coal and Navigation Company. Seven men lost their lives there recently, and the verdict of coroners' juries in each case was that the cause of death was unknown. The miners, however, have contrary evidence. The law says that enough air shall be circulated in mines so to render harmless and sweep away noxious or dangerous gases. The workers claim that when accidents occur every effort is made to find out who, or what, was responsible for gas ignition,

but never a word why the company permitted gas to accumulate, in defiance of law. The miners are determined that henceforth causes shall be discussed, instead of effects.

ASK UNIONISTS' AID.

Chicago, Ill.—Trade unions are receiving copies of State Insurance Superintendent Potts' report to Gov. Dunne on "Investigation of Fire Insurance Conditions and Rates in Illinois." With the report is a circular which calls attention to an article, published in a newspaper devoted to insurance agents' interests, urging fire insurance men to oppose the theory or state compensation funds for the reason that "if the camel once gets its nose within the tent it will not be satisfied until it has crowded everyone out." Superintendent Potts says he wants to work in harmony with the trade unionists in "securing proper legislation, and they, likewise, can be of very great help to me in securing the necessary legislation for insurance reform."

STATE HAS SAFETY EXHIBIT.

Columbus, O.—Ohio's first annual industrial safety exposition, held in this city last week, was a success and a revelation. The exposition was arranged and conducted by the state industrial commission, the executive body that is carrying into effect the provisions of the workmen's compensation law and other statutes relating to industry. A large hall was secured, and all manner of safety devices were arranged in both. Attendants demonstrated the utility of each device. Railroad companies, large steel concerns, and other Ohio industrial corporations were represented, while other states occupied large booths. The most important feature of the exposition was the "round table" discussions, at which representatives of large corporations and representatives of organized labor discussed the relation of employer and employe and suggested measures to meet the problems presented. President Voll and Secretary Donnelly, of the Ohio State Federation of Labor, took a leading part in the debates. If even one-half of the betterments claimed to have been instituted by the companies is a fact, these concerns have revolutionized their methods in dealing with employes since the organized workmen of this state secured the enactment of the workmen's compensation law. The Ohio Manufacturers' association, at its last convention, declared in favor of co-operating with the labor unions in making the compensation law effective. Members of this organization resisted the adoption of the law.

A STRIKE NO CONSPIRACY.

New York, N. Y.—A strike is not a conspiracy, declared Judge Gibbs, of the Bronx County court, in discharging five strikers who were arrested on complaint of a paving contractor, whose workers struck because

of a violation of union rules. Failing to employ non-unionists, the contractor secured a grand jury indictment against the strikers. Their attorney raised a question of law on the matter of conspiracy.

In dismissing the strikers, the court said: "Labor has a right to organize and use every legal means to protect its own interests, raise wages, shorten hours, and enforce working rules. Labor has the same right to protect itself against outside competition that business has. This was a legitimate strike, called by a legitimate union and there was no criminal conspiracy."

COURT CAN'T DEFINE "MINING."

Hazleton, Pa.—The miners have been defeated in their efforts to make effective the state mine certificate law through Judge McCarrell's refusal to restrain state mine officials from pursuing their present course of issuing certificates to other than practical miners. The miners insist that the law intended that a man shall dig coal before he is qualified as a miner and can secure a foreman's certificate. The court holds that the legislature has failed to define the term "mining." As a result of this decision, the miners say a man who is employed in laying tracks or handling dynamite may receive a certificate which places him in a position most important to the workers' lives. The decision will be appealed.

WILL URGE LABOR LAWS.

Montgomery, Ala.—Organized labor in this state will urge the following laws before the Alabama legislature: A compulsory education bill, mechanics' lien law, taking convicts out of the mines and putting them on public roads work, a compensation law, strengthening the mining and child labor laws, provisions for a state constitutional convention.

POETIC JUSTICE.

Washington, D. C.—The Senate has confirmed Frederick L. Siddons as judge of the Supreme court of the District of Columbia. Judge Siddons was a member of the law firm that defended Messrs. Gompers, Mitchell and Morrison in the contempt proceedings caused by the sentencing to jail of these three unionists by Judge Wright. Later, Judge Wright resigned while charges against him were being investigated by the House committee on the judiciary, and now, with a justice that is poetic, Mr. Siddons succeeds him.

AGAINST CONVICT LABOR.

Washington, D. C.—While the Senate was discussing the District of Columbia appropriation bill, Senator Kern of Indiana, secured the adoption of an amendment prohibiting the sale of brick manufactured at the District workhouse "in competition with the products of free labor, or otherwise to any department or institution of the government of the District of Columbia

or of the United States, or to any public or private corporation, partnership, person or persons."

TO BUILD ALASKA RAILROAD.

Washington, D. C.—Actual construction of the government railroad to connect the Alaskan coal fields with the coast, authorized by Congress last March, will begin during the coming spring, according to federal authorities. Under the law providing for the construction of the railroad the President is authorized to decide on the route, on whether railroads already constructed shall be purchased as part of the line, and other details.

MORE CO-OPERATIVE STORES.

Chicago, Ill.—Two new co-operative stores have been established in this city. The union miners of Cedar Point have started a co-operative store with \$1,000 capital. It is stated that the business of this venture already amounts to over \$70 a day.

HATTERS LOSE CASE IN HIGHEST COURT.

Washington.—Last Tuesday the United States Supreme Court, in a unanimous opinion, decided that the union hatters of Danbury, Conn., must pay \$252,000 to the firm of D. E. Loewe Company, as the result of a strike and boycott started against this firm in 1902.

The firm sued for \$80,000, and under the Sherman anti-trust law was awarded three times this amount. The additional \$12,000 allowed was for attorneys' fees and other expenses. The homes of 186 union hatters have been held under attachment orders for the past several years, and the judgment of lower courts is now finally affirmed.

During the long years of this legal controversy, the American Federation of Labor has supported the hatters in their position that they have the right to ask friends and sympathizers to join with them in withholding patronage from an unfair employer.

This position has been indorsed by the United States Congress by its passage of the Clayton bill, which provides "nor shall such organizations (labor unions) or the members thereof, be held or construed to be illegal combinations or conspiracies in restraint of trade, under the anti-trust laws."

Under the Clayton law judges are prohibited from issuing an injunction against any person or persons from withholding their patronage from any party to a labor dispute, or "from recommending, advising or persuading others by peaceful and lawful means so to do."

In urging the passage of the Clayton law, the unionists showed the unlimited power possessed by the courts, through their interpretation of the Sherman anti-trust law, and the workers have insisted that under this interpretation the homes and savings of toilers were seized as a penalty for exercising their rights.

The United States Supreme court, in its

decision in the hatters' case, has not only verified these claims, but has emphasized the wisdom of Congress in passing a law that will curb the judiciary in its policy of reading into the Sherman anti-trust law a meaning that was never intended.

WORKERS ROBBED BY AGENTS.

St. Paul, Minn.—In the annual report of the state department of labor the evils of private employment offices are shown. It is a common practice for the employment agent to make an agreement with a foreman or superintendent to send a given number of men each month and then divide the fees. In order to make places for the men who are coming in the foreman has to discharge men that he has on, so that it has become a saying with respect to some of these concerns, that they have one crew coming, one crew working and one crew going. It is often difficult to prove the truth of the charge of fee splitting. Foreign laborers in particular are the victims of exorbitant fees. In one case the agent charged the men \$4 for jobs as railroad laborers at \$1.50 a day with the understanding that \$3 of the \$4 would be refunded to the men if the work lasted less than ten days. If the men worked ten days they had to pay the fee of \$4. They paid \$4 for the privilege of earning \$15.

The report recommends that the hours of labor law for women be extended to cover the whole state, instead of merely the three large cities; that street trades should be so regulated as to prevent the employment of small children, and that boarding camps of all sorts should be covered by legislation, regulating ventilation, sanitation and lighting of bunk houses and kitchens, and providing for state inspections of these places.

ECHO OF STOCKTON STRIKE.

San Francisco.—The settlement of Stockton's strike has put an end to the talk in non-union circles that the strike would be spread to this city, or that a similar attack would be made on the organized workers of San Francisco.

The Bulletin makes this editorial comment:

"Congratulations to the union men of Stockton, who have won a victory for organized labor. Congratulations also to the employers of Stockton, who have recognized the one principle on which a just industrial peace is now possible, that of collective bargaining between organized unions and organized employers."

"Organized bargaining, on equal terms, between employer and workingman, is the only basis on which the interests of the community, of the worker, and of the employer himself can be at once justly and sensibly served."

Stockton, Cal.—As the terms of the strike settlement is better understood by trade unionists, they realize to a greater extent

the value of this peace pact which their representatives secured. The strike—or rather lockout—was caused by the unionists' refusal to act favorably on a letter forwarded them June 26 last by the Merchants, Manufacturers and Employers' association of Stockton, which announced that if the workers did not stop a boycott "this association will take immediate steps to protect its members by insisting that the present employers of the members shall withdraw from the union with which they are now affiliated or resign their positions."

Under the terms of settlement the employers agree to withdraw their letter and the unions agree to stop the boycott. The employers abandon their anti-union position and agree to the following:

"That a committee of three from each side be appointed to which shall be referred all questions affecting wages and hours, which may arise between the two parties, the decision of said committee to be binding on both sides; it being definitely understood that no drastic action shall be taken by either side until after said committee has considered the matter and rendered a decision."

OFFERS UNEMPLOYED PLAN.

Chicago.—"The city has failed to develop any adequate, systematic machinery by means of which the manless job and the jobless man may be brought face to face," is one of the views of the municipal markets commission on the unemployed question in a report to the city council.

These recommendations are made:

"Municipal insurance against unemployment.

"Reorganization of state employment agencies.

"Establishment of an efficient municipal employment bureau in the department of public welfare.

"Appointment of an advisory committee of ten business men and ten labor men to study the problem of unemployment.

"The city should pass suitable ordinances strictly regulating private employment agencies in order to eliminate the grave misrepresentation, extortion and dishonest practices frequently complained of and found to prevail.

"Your commission, however, believes that the only effective means of eliminating private employment agencies is by the establishment of efficient and competent public employment agencies in their stead.

"An efficient municipal employment office is the surest method of eliminating private employment agencies with their resulting dishonesty, fraud and unlawful practices.

"The city should promote insurance against unemployment in order to prevent destitution and misery when unemployment cannot be prevented by the operation of a municipal employment bureau, public work for the unemployed and part time work. Provision should be made for the honorable

maintenance at public expense of the surplus laborers.

"Experience has shown that soup kitchens and bread lines for the unemployed are as a rule indiscriminating and do more harm than good.

"Work undertaken by the city as a means of relief or charity should be considered as a last despairing effort to aid the unemployed when it has or knows no better alternative.

"Relief work of this nature, while blameless and unexcusable, as long as human beings are starving and homeless, is almost wholly useless for benefiting the people thus relieved.

"The city council by all means should avoid appropriating money for charitable purpose."

APPROVE OF UNIONS.

Springfield, Ill.—The state board of administration, in charge of all state institutions, has issued the following order as a result of conferences with the organized employes of these institutions:

"General Orders No. III:

"Employes of the state in the state institutions are not to be interfered with by their superior officers because of the fact that they may have joined or contemplate joining a labor organization. Labor organizations in this regard are in the same class as religious and fraternal organizations and no employe is to be handicapped or discriminated against on account of the fact that he is affiliated with them.

"The attitude of the board toward all of these organizations is one of toleration, and in their efforts to better mankind or improve conditions, social, economic, or moral, it is one of sympathy and encouragement, and under no circumstances the reverse. The rule of unrestricted freedom is the policy of the board in this controversy."

SERVICE NOT A COMMODITY.

Little Rock, Ark.—The supreme court of this state distinguishes between "service" and a commodity. The decision was made in the case of the State vs. Frank et al., who, as launderers, had agreed with each other to fix the price to be charged to their customers, and carried on their business under such agreement, and also combined to launder for the city of Malvern at less prices than those charged in Little Rock, where they were located. The state held this agreement was in violation of the state anti-trust law, which prohibits unlawful combinations to regulate or fix "the price of any article of manufacture, mechanism, commodity, convenience, repair, any product of mining or any article or thing whatever." The supreme court held that the agreement did not come within the terms of the provision of the anti-trust statute. The court said that the business of laundering was a mere service done; that an agreement to regulate the price to be charged therefore

was in its last analysis merely an agreement to fix the price of labor or service, and that the legislature had not made such an agreement unlawful.

STOCK FOR EMPLOYEES; U. S. TO TAKE PHONES.

Chicago.—Is the American Telephone & Telegraph company, the patent company of the Bell system, preparing to "unload" stock on employes because of continued agitation for government ownership? The company has announced that employes may now purchase stock in the company for \$110 a share on easy terms.

Washington.—Representative Lewis, a member of the House labor group, is urging the taking over by the government of the various telephone systems in this country. It is proposed that the interstate commerce commission be instructed to appraise the value of the lines, which would then be paid for by the government under this valuation. In a speech last week the unionist made a notable defense of this position which included a history of the world's telephone systems.

NAVY YARD WAGES NOT CUT.

Washington.—Employes of the Washington navy yard have secured a victory by Secretary of the Navy Daniels' reversal of recommendations by a wage board that wages be reduced. The machinists, one of the largest trades at the yard, were hit the hardest by the wage board's decision. In this case a general reduction of eight cents a day was favored. Representatives of the machinists protested and showed that the new rule would wipe out the 7½ per cent increase in their pay granted by Congress two years ago. Secretary Daniels agreed with this point and ordered that wages remain as they are.

NAVY YARD GETS AWARD.

Washington.—The navy department has awarded the Mare Island navy yard the contract for building a torpedo boat destroyer, the first contract of its kind ever given to a government yard. In the bidding for the contract, Mare Island underbid private plants by nearly \$200,000. The navy bureau chiefs do not seem to fancy this condition and declared the contract will not be fulfilled in time. Officers of the yard predict some one is due for surprises, as the boat will be delivered as per schedule.

SUSTAINING TUBERCULAR POOR.

New York.—The burden of institutional care of the consumptive is being shifted from the private purse to the general public purse, according to a report of the National Association for the Study and Prevention of Tuberculosis. In 1914, more than \$20,500,000 was spent in the United States anti-tuberculosis campaign and of this sum 66.8 per cent was derived from public funds, compared with 53 per cent in 1909.

PUBLIC CUP ABOLISHED.

Albany, N. Y.—The state board of health has issued an order abolishing the public drinking cup and the use of the roller towel in public places and fixing sanitary rules to govern barber shops, manicure parlors and chiropodists' offices. The rules regarding the drinking cups and roller towels practically are the same as those enforced in interstate trains.

The order requires that all instruments used by barbers, manicurists and chiropodists must be sterilized. Violation of the order will be a misdemeanor.

REPORT ON IMMIGRATION.

Washington.—According to a report issued by the federal health service there were 41,236 immigrants last year who were found to be diseased to such an extent as to be deportable or reportable under the immigration laws.

More than 100 steamship lines bring immigrants to this country, and in all there are more than 175 avenues of immigrants travel from foreign countries to the United States. These immigrants came from 25 different foreign ports and entered this country at 80 different points, 25 of which were seaports.

SAFETY-AT-SEA PACT FAILS.

Washington.—It is now proven that the London conference on safety at sea was held to no purpose, because the United States Senate refused to accept the treaty agreed upon, and representatives of the world's maritime nations could not be gotten together because of the war. The last day for acceptance was December 31. The United States government made no effort to present its amended ratifications to the nations, in view of present conditions. It is agreed that the shipping trust was at least not opposed to the London treaty, but the United States Senate spoiled the plan when it attached an amendment providing, in effect, that this country refused to surrender to other nations the right to make laws governing shipping and relating to the condition of seamen.

START A CO-OP. BAKERY.

Galveston, Texas.—As a result of the bakers' strike in this city, organized labor has formed a company to conduct a bakery along co-operative lines. It is stated that \$7,500 has been subscribed, and efforts will be made immediately to compete with employers who refuse their workers a shorter work day. Trade union officials have been appointed on a committee to select a location, order machinery and complete other details.

PRINTERS START PAPER.

New Orleans, La.—Printers who have been locked out by three newspapers in this city have started a morning paper—the Southern American. The strikers are confident of

success. Differences first arose over a five day law these workers adopted and which the newspapers objected to. Because the law was not repealed instantly, the publishers presented new demands, which were followed by the lockout order.

WAGES REDUCED BY JUDGE.

Sydney, New South Wales.—Justice Heydon, of the court of industrial arbitration, has suspended wage increases recently awarded railroad workers, and trade unionists now declare: "Wage boards which kept wages down in prosperous times, ought to be able to keep them up when times are bad."

The application for a suspension of rates was made by the chief commissioner for railways and tramways as a result of a hint previously made by Justice Heydon that this could be done because of present industrial conditions. The interested unions were represented by a strong corps of attorneys, who entered vigorous protest against the proposal and who declared the drought that has prevailed throughout the country, and not the European war, was responsible for depressions. The unions' attorneys insisted that another factor was the possibility that railroads were constructed or being constructed in places where they were not paying, and that if decreases were to be made in connection with the development of the country, the men should not be called upon to bear the loss.

The court refused to accept this viewpoint, and said he could not be called upon to criticize the government of its policy of building railroads.

After the court listened to arguments by attorneys representing the workers, the railroads and the government's railroad department, the request for a suspension was complied with.

PUBLIC OFFICIALS "TOO BUSY."

Sydney, New South Wales.—Working men in this city have been notified by Acting Premier Cann that public officials "are too busy" to receive a deputation of laborers who would urge the adoption of resolutions passed intended to remedy unemployment.

Among the suggestions were an amended income tax act starting with ten per cent on all incomes of \$750 per annum; a reduction of salaries of certain public officials; a loan by the Federal government to the States of sums of money to start public works; an act to limit charges of rents.

A committee appointed by the meeting to present these resolutions was then notified the ministers could not see them. A resolution to call "a special conference of laborites to discuss the matter further" was lost and the secretary was instructed to again attempt to secure the premier's consent to receive the deputation.

Among Our Exchanges.

WAR.

What no honest lover of mankind, and furtherer of peace ever dared to anticipate, is now actually a fact. The civilized States of Europe are in the act of tearing one another to pieces, with the most modern, wholesale-destructive machines, in order to bring to an end certain existing uncertainties. For years the prospect of such a mighty conflict has been ever present, like some grim monster, to the consciousness of the peoples of Europe; for years this fearful foreboding has prejudiced trade and commerce, and has restrained the keen, ardent spirit of enterprise. The European weathercock, the Balkans, was a source of uneasiness to the States of Western Europe, led to paralysis of trade and industry, and matured among the organized workers in the shape of great insecurity in the means of subsistence, wide-spreading unemployment, interrupted only by short spells of full-time work. For years Europe has been like a magazine, the explosion of which has been from time to time threatened, with sparks of various sizes. Hitherto such an issue had, however, been prevented, although the apprehensive feelings of the peoples of Europe was an index that they were wandering at the brink of a precipice. It was again the European weathercock which was the starting point, which gave the sign for the storm. It is idle now to inquire whether some settlement of the points at issue was not possible, whether the peoples of Europe could not have succeeded in preserving a so necessary peace. Equally vain is it to ask whether the assassination of the successor to the throne of Austria, in Sarajewo, is a sufficient cause, for the slaughter of a multitude of innocent persons, for the perpetration of such a gigantic murder, in order to secure a requital for one villainous deed. Such questions are idle at a time when the whole of the European peoples are involved in so great a calamity, and it is also at present useless to inquire whether the causes of this present war lie in foreign politics, or arise out of deeprooted economic conditions. But just as the European weathercock, perhaps in consequence of this or that ruthless deed, of a single individual, of a party, a nation or of a government, may seem to point towards war, and attempt to raise up general, universal abhorrence and bitterness, just as this weathercock, is not, as a matter of fact, the weathercock which is really feared, so the assassination in Sarajewo is not the real cause of the present war. "Greater Servian Agitations," "Pan-Slavism," "Revenge," and such like expressions which are bandied about, as the explanations of the reasons why the people have set themselves against one another, are no more than catchwords, which throw

a veil over deeprooted economic influences. Tendencies to expand, to throw down deeper roots, bring nations into sharp opposition, they rob one another of the light which is necessary to all for growth. Just as in the life of a single nation an association or company feels itself in its chains threatened by the existence of another, regards that other with distrust, seeks to prevent that other from making headway, so is it also in the larger economic interests in the life of nations. That the love of power of a few definite groups plays a role, which in some cases may even decide the time of the outbreak of a conflict, does not alter the fact, that it is really economic factors which set the nations against one another and ultimately precipitate a war.

Although the working classes may regard such a conflict as a blow to civilization, and therefore, steadily set themselves in opposition, that does not prevent the organized workers from accepting a given situation, and even to throw themselves ardently into a struggle, because they recognize the preservation of nationality as indispensable, and by such a struggle mean to defend the civilization peculiar to their own land. So it has been in the present struggle, in which almost every country where military service was compulsory, the workers did everything they could to prevent the war, but, when their efforts had failed, brought their mental qualities and culture to the defense and preservation of their nationality, to the arbitrament of the sword, although they knew that in so doing, in entering into such a struggle, they would do grievous harm to the life and spirit of sister organizations in other lands, whose thoughts and feelings were similar to their own. Organized and outspoken workers declare that no other cause except the preservation of their nationality and the civilization peculiar to it, would have justified their appeal to arms. Whether such claims can be justified or not, must be left to the tribunal of history, but today it is a certainty that such claims are held by almost every nation, so far as the mass of the people are concerned, and are the mainspring of their activities. This high flood of Nationalism, which carries with it at present, practically every member of the nations engaged in war, seems at a blow to have severed the international thoughts and feelings of the workers. The international seems but as a corpse before the high flood of national enthusiasm. Is it really so, and shall we ever be able to build up again so powerful an intercommunal life? The answer to this question, too, lies also in the lap of the future. We, who have steadily maintained the standpoint that nationalism and internationalism are not mutually exclusive, that internationalism represents but a further step in the development of the

life of nations, and assumes a firmly established nationality, cannot believe that the unfortunate war now destroying the peoples of Europe, will bring with it a lasting adversity in the international relations of the workers of the various countries. On the contrary, we regret the sacrifices of this war, the terrors and horrors to which it has given birth, deeply, and we are, consequently, absolutely convinced that these very sacrifices, these very terrors and horrors will create a new and large influx of the friends of peace, who will establish peaceful methods of international understanding. We are, however, also convinced, that before such an end can be reached, the co-operation of the peoples in every sphere of civilization is necessary. All those who desired peace among the peoples, who worked to secure this triumph, and whose efforts have now been frustrated, because they were too weak, must not despair of the ultimate victory of the idea of peace. A time of peace will succeed to the time of war—must succeed—because the nations of today are so dependent upon one another. The very destruction of goods, whether they be raw materials, or the products of industry, or creations of the human mind, will draw the enemies of today nearer to one another. The workers also will rediscover each other, as they must have done before, and simply because they must do so.

If hence a permanent burden will not be laid upon the co-operative work of organized labor in the international field, there still remains with us the anxious care, whether or not the chaos of war will not bring in its train a lengthy estrangement of the workers in those countries which have taken part in the war, and thereby postpone the time in which we shall be able once more to co-operate in international matters. The banishment of this danger appears to us a primary duty, the achievement of which will be very difficult, because on account of the war, the intercourse with a part of our affiliated comrades has been cut off, the relations with whom latterly promised to become exceedingly cordial. The preservation of these feelings are very important for our later relations, and we must seek by all possible means to maintain them. To this end our organ, the International Metal Workers' Review, was created. It was brought into being to facilitate intercourse between the Trade Unions of Metal Workers, to make the reports of the committee men of one country accessible to the unions of the remaining countries, to give information about the world's market, about the protection of workers, insurance legislation, and the work of the trade union organizations. In short, it was to bring to light all that concerned the trade union movement of the workers, whether directly or indirectly.

During the time of war we must all put our hands to the plough to see that these duties are carried out. Under the present

circumstances, of course, every possible duty cannot be carried out, not only because existing arrangements render impossible a part of these duties, but also because of the fact that the war influences the economic life not only of those states actually fighting, but affects all remaining nations, which are, or have been until now, identified in buying and selling. Today, in practically every industrial state, the organized workers are suffering from unemployment. The latter already imposes new duties upon peoples and governments, in which we are also interested in a high degree. Increased unemployment must depress trade union organizations, absorb more and more of their funds, reduce the stream of membership, or dry it up altogether. The trade union organizations in those states where compulsory military service obtains, cannot remain uninfluenced through the calling up of members to the flag, while in those countries in which military service is voluntary, the work of the recruiting officer will be visibly affected by the degree of unemployment. All these phenomena are of decisive significance in the life of trade unions. They remove the props from under them, and impose new duties upon the unions, some mention of which is well worth while.

If during the time of war, some care for international relations, in spite of all limitations, is possible, this only can happen through the good will of those interested. In the first place the trade unions in those countries which are maintaining a neutral attitude can render a very useful service by undertaking the transmission of news, and by giving us information as to the occurrences in these lands. Efforts must be made not only to forward reports from neutral lands, but also to obtain material from those countries which are actually taking part in the war. For this purpose, intermediary relations must be established between the international secretariat and the trade unions in the neutral states, so that material can be forwarded to the secretariat from the various lands, which cannot be obtained directly. In this way also, the International Metal Workers' Review will be able to reach those members in countries which are taking part in the war. Only through such co-operation of the members of the International Metal Workers' Federation will it be possible to maintain the International through these difficult times, and prevent the hard work of twenty years from being nullified, work which must be continued so soon as the war comes to an end. If all our past efforts are not to be razed to the ground, but preserved, it can only come about through the co-operation of those whom the outbreak of war has not divided, and who will not allow themselves to be withdrawn from any one of these obligations. To the members in all states which are struggling against one another, we recommend the preservation of an open mind,

and through all the terrors of war, and the wild passions which it lets loose, to cherish the cause of humanity and the solidarity of the workers, and not allow these to be sacrificed.—International Metal Workers' Review.

BOILER MAKERS EXPRESS THEIR APPRECIATION.

Grateful for the Patronage Given Their Annual Dance at Auditorium.

The annual ball of the Boiler Makers at the Auditorium on New Year's Eve was one of the most enjoyable social events of that nature that has been given in Miles City in many a day. Upwards of 140 couples were present. Besides a large number of tickets were disposed of to parties who did not find it convenient to attend, so that financially the affair was as much a success as it was socially. Naturally the boys feel elated over the consideration shown them by the public and through the columns of the Star they desire to thank everybody who had anything to do with its success. Said one of the members to the Star yesterday:

"We want to thank the newspapers and the moving picture shows which advertised the event for us, and last, but not least, the large number of people who purchased tickets. From every viewpoint the dance was a success, and we trust that the people enjoyed themselves."

The Boiler Makers' dance, next to the Engineers' ball, was the largest that has been given at the Auditorium this season.—Miles City Star.

FOR PEACE, JUSTICE AND DEMOCRACY

A world-wide war now demonstrates the failure of the prevailing methods of diplomacy. Secret diplomacy is an anomaly in an age of democratic ideas and ideals. Secret diplomacy is the twilight zone which enabled the "interest" to retain a controlling hand upon the powers of state. The people now demand their right to know what has been concealed. They demand that the element of secrecy be eliminated because the affairs of diplomacy are the affairs of the nation.

America's workers did not shirk responsibilities revealed by the present war. Their sense of duty to the state and to all their fellow workers has been stirred to the depths. Several resolutions introduced in the Philadelphia Convention showed the broad sympathies of the labor movement for the suffering caused by the war, and their longing for constructive measures that would make national relations embody the highest concepts of rational conduct and justice.

These resolutions all proposed definite plans of action that the welfare of the

masses of the people may be impressed upon those who have in their hands diplomatic power. In addition to the endorsement of the Executive Council's report upon international war and peace was the unanimous adoption of Resolution No. 104, the full text of which is as follows:

Whereas, The whole civilized world is torn by the awful titanic struggle which is now devastating continental Europe, disturbing the commercial and industrial conditions of the whole world, submerging the nations of Europe in the shadows and horrors of war, touching sharply our sympathy and stirring the depths of our emotion; and

Whereas, All history has proved that trial by conflict does not result in permanent peace when it does not establish justice as its foundation, while peace promotes the establishment of those agencies which seek to regulate the relations between men that justice may prevail; and

Whereas, Political experience shows that the welfare and the interests of all the people are promoted in proportion as they are represented in the government and the government is responsive and responsible to them, it is necessary that the workers have a will and an effective voice in determining international relations; and

Whereas, The workers of every age have had special and imperative reasons for advocating and endeavoring to secure provisions insuring the maintenance of peace with justice, since upon them fall the burdens of actual warfare and the real fighting in the ranks, while the hardships and the suffering accompanying war and following it are felt most keenly and most palpably by them and those dependent upon them, and the costs of war ever fall disproportionately upon their already inadequate resources; and

Whereas, The workers of all countries have been leaders in protesting against injury and violence to human life in peace as well as in war, and against the cruelty and the waste of needless war, and they have steadfastly endeavored to rouse the general public to realize the enormity of war, thereby rendering public opinion alert and sensitive to the responsibility of all men for the existence of war, and, moreover, the workers have been inspired to assist in constructive movements for the prevention of wars whereby peace may be maintained with justice; and

Whereas, The organized wage workers of the civilized nations have established fraternal relations for the purpose of binding together the trade unions of all countries for the promotion of common interests and ideals, and by frequent and regular communication, co-operation and exchange of representatives have brought about an understanding and sympathy between the organization and their members in the va-

rious countries, relations which are necessary for the inception and the continuance of peace; and

Whereas, Out of the experience of these workers, out of their burden-bearing and their wrongs, out of their hopes and their victories, have developed principles of justice and the conviction that the establishment of these principles as practical forces in the lives of the workers is conditioned upon establishing dependable representative agencies for the realization of purposes and agreements determined upon; therefore, be it

Resolved, That we, the delegates of the organized labor movement of America, express and hereby convey to the organized labor movements of Europe fraternal greetings and our sympathy with their great suffering and distress, and that we express our most earnest hope for the early cessation of the terrible warfare now desolating the lands, destroying the families and impoverishing the nations of our fellow-workers; and be it further

Resolved, That we desire that fraternal relations between national labor movements shall continue with no more interruption than shall be absolutely unavoidable during the war, to the end that our regular intercourse and co-operation shall be resumed immediately at the close of the war; and be it further

Resolved, That the convention of the A. F. of L., in view of the general Peace Congress which no doubt will be held at the close of the war, for the purpose of adjusting claims and differences, hold itself in readiness and authorize the E. C. to call a meeting of representatives of organized labor of the different nations to meet at the same time and place, to the end that suggestions may be made and such action taken as shall be helpful in restoring fraternal relations, protecting the interests of the toilers and thereby assisting in laying foundations for a more lasting peace; and be it further

Resolved, That copies of these resolutions be sent to the International Federation of Trade Unions, to all national trade union centers throughout the world and to the President of the United States.

In compliance with the instructions these resolutions have already been transmitted to the trade union centers of all countries affiliated to the International Federation of Trade Unions, and to the International Federation of Trade Unions. This was done to obtain official views upon the practicability, the wisdom of the proposition for holding a conference as urged by the resolutions. It is the earnest hope of America's workers that the terrible conflict may be ended soon, and ending, effect the establishment of permanent international peace based upon principles of justice, freedom and democracy.—The American Federationist.

OCCUPATIONAL EYE DISEASES.

Many eyes are injured or lost from disease contracted in certain occupations. In some trades absorption of poisons produce serious eye diseases. Among these poisons are tobacco, alcohol, lead, bisulfid of carbon, nitrobenzol, aniline dyes, etc. One of the most dangerous is alcohol. Not the high grade grain alcohol but the cheap wood or methyl alcohol, sometimes masquerading under the names "Columbian spirits," "Colonial spirits," or "Manhattan spirits." This poison sometimes drunk by ignorant people, and not infrequently causes death and blindness. Even ten drops have produced such results in susceptible people. Turkish bath attendants and masseurs sometimes use wood alcohol with bad results, both to the rubber and the rubbed. The inhaling of wood alcohol in such trades as painting and hat making not infrequently produces blindness or fatal results. It is used as a solvent for shellac and if used in confined spaces is very dangerous. In a pencil factory, where wood alcohol was used, a roomful of girls suffered from serious disturbance of vision, which passed away with the removal of the cause. Wood alcohol under this or under any other name should not be manufactured or sold. It is too dangerous. What is called denatured alcohol is just as cheap and comparatively harmless. Another vocational eye disturbance is found where eyes are unduly exposed to very bright lights, such as "blow outs" or "short-circuits," where the light is sudden and intense. Such accidents may, by the overpowering influence on the retina, produce poor sight or blindness, partial or complete, for a variable length of time. Constant and intense electric light produces retinal exhaustion, and an excessive pupillary contraction, which secondarily overworks the muscle of accommodation, and occasions great ocular fatigue. People who work continually on polished surface such as gilders, metal polishers and glass workers experience the same trouble. Factories that are brilliantly illuminated by incandescent gas and electric lights are apt to injure the eyes, as these lights contain much violet and ultraviolet rays which produce an effect on the eye similar to "snow-blindness." These rays may also seriously affect the eye. Stokers, bottle-makers, and glass-blowers, whose eyes are continually exposed to intense heat and light, are very apt to have cataracts and the eye nearest the fire is always the one first affected. Another kind of occupational eye disease can be found in people who are compelled to work for hours at a stretch, on work that requires close inspection of small things. Bookkeeping, drawing, watchmaking, sewing and dentistry, all close work, require a strain of the muscle of accommodation, even if people have normal eyes. Many people have errors of refraction for which glasses should be properly fitted. Even if glasses are properly fitted, there is still an accommodation

strain where the eye is unwisely taxed. This accounts for the headaches, tired and red eyes and nervous exhaustion so frequently seen in those who work long and hard at occupations requiring close visual exertion, and where at the same time perhaps the light is poor and badly arranged.

Shortsightedness is a disease aggravated by the close use of the eyes and is found in students, type-setters, etchers and engravers, in fact, in any vocation where close and continuous use of the eyes is demanded. The proper adjustment of glasses is essential in such cases, as well as health up-building, open-air life, proper lighting and the judicious use of the eyes, for it must be remembered that shortsightedness is a progressive disease and sometimes causes blindness. Shortsighted people should endeavor to secure some occupation which does not require the close and continuous use of the eyes.—Journal, American Medical Association.

TREATING MEN AS MEN.

Such a service to mankind as the Rufus F. Dawes hotel in Chicago is performing when it supplies a man with a room, a good bed and a comfortable meal at a charge of 14 cents is always interesting. It is peculiarly interesting that the Dawes hotel last year came within a little of paying expenses and that it treats its guests as regular hotel guests and not as the recipients of charity. It has shown what it is possible to do in a business way, for a slightly higher charge would have meant a profit on the enterprise.

Better than this, if anything could be better, is the idea on which Mr. Dawes operates the hotel erected in memory of his son. He says of it.

"It is no different from any other hotel except that its charges are lower. It assumes that its guests are gentlemen and appreciative of gentlemanly treatment. The fact that in the operation of the hotel a small deficit results, is not made the excuse for any different treatment of its guests than in other first-class hotels."

In other words, Mr. Dawes realizes that men like to be treated as men and not as an inferior class because they happen to suffer the misfortune of not having much money. They pay for what they get, and if not quite all it costs, it is all they are asked for. And in return they are not made to feel themselves paupers or semi-criminal.

What one man in Chicago has achieved, other men elsewhere will do. The work Mr. Dawes is doing in memory of the son who did not live to carry out his own plans is likely to be better remembered than his service as comptroller of the currency. And the best part of his work is that he looks on the men he wants to help not as "objects of charity." but as fellow men—Milwaukee Journal.

ALIEN LABOR AND PUBLIC WORK.

The efforts of the contractors engaged in building the great subways of the city of New York to have the alien clause in the labor law concerning public work declared unconstitutional presents a characteristic phase of the all-important immigration problem, the exploitation of the unskilled or semi-skilled foreigner by large employers of labor to the detriment of American wage-earners and as a means of lowering those standards of labor and of living which have been built up and fostered by the American trade union movement.

According to figures available there has already been expended on subway work in New York City over \$200,000,000, and there has been some 20,000 men employed since the work began. Of these latter the great proportion of from 80 to 90 per cent were aliens who were content to work at a low rate of wages. The subway contractors have also endeavored to destroy recognized trades in the metropolis by using what are called "handy-men" to do the work of mechanics. These "handy men" are usually aliens who will do mechanical work for wages ranging anywhere from \$2.00 to \$3.50 per day in a city like New York where the standard of living is exceptionally high.

Of late various unions of the building trades have taken a determined stand to put an end to the notorious violations of the alien clause in relation to public work. Strong representations were made to the Public Service Commission and notices were sent to the contractors demanding compliance with the law. When the latter saw that the Public Service Commission meant business they retained two well known lawyers to attract the validity of the law and have it declared unconstitutional as impairing the right of contract, and illegal, as contravening the terms of a treaty with Italy, and other treaties with other foreign countries. As a preliminary step an injunction was secured tying the hands of the Public Service Commission.

Organized labor is preparing to strongly contest this attempt to have this law declared unconstitutional and John Gill, representing the bricklayers', masons' and plasterers' union, has been made a party to suit by consent of all parties in order that organized labor may be represented. The New York trade unions intend to contest the case thoroughly and will carry it to the U. S. Supreme Court if necessary in order to obtain justice for the American working man.

In its narrower aspects it is of vital importance that the provisions of the labor law and the alien clause should be strictly enforced in the city of New York, just now where there are over one hundred thousand wage-earners unemployed. In the building trades alone it is estimated that there are more than 35,000 citizens at present un-

employed, with families dependent upon them, who are able, ready and willing to do this work. It is almost needless to say also that if the contractors succeed in having this law declared unconstitutional or illegal the trades union will have a much harder battle in the future against inroads of alien labor.—The Carpenter.

THE AMERICAN FEDERATION OF LABOR.

Does what all federations of labor unions do, attempts to give solidarity to the labor movement by getting the various sections of the labor army into touch with each other. It refuses to admit that occupation can be a barrier to the community of interest running through the wage-earning masses. From its inception it has taken the stand that while unions of miners, sailors, shoemakers, cigar makers and printers, must each and all be left entirely free to govern themselves within their own borders, yet, that between the members of all these unions there should be a bond as great as that between the members of the same union. The great aim and object of the federation is to strengthen that bond, and its method is, by organization, education and inculcation, to place the labor movement upon a higher and more effective plane. The strength of a chain is in its weakest link, and the Federation, therefore, endeavors to organize all labor, recognizing that while many non-unionists may be sympathetic with unionism, yet that the unorganized are far more exposed to the pressure of unjust conditions than are the organized, and being thus necessarily weaker in maintaining wages, keeping down hours, and resisting other encroachments, are the source of constant danger to the organized as well as to themselves. And there is this that the American Federation of Labor has already done: It has largely swept away the old and foolish jealousy that existed between the skilled and unskilled workmen; it has taught the great lesson that a man is a man, no matter whether he sets type or scales the ladder, whether he sews the garment together or sells it behind the counter, whether he makes the machine that spins the cotton or gathers the cotton in the field. Whatever a man may be, so long as he works honestly and seeks to wrong no other man, or to advantage himself at the cost of another, he is a man. The Federation maintains this and seeks to swing all into line regardless of how they may happen to be employed.

The Federation is opposed to strikes, as are all peaceful institutions; but when struck, it will strike back as best it can. Strikes are barbaric in the act, but highly moral and absolutely necessary when forced by aggressive employers who would curtail the liberties of a portion of the community for the advancement of another, who refuse fair and open conference and adopt arrogance and forceful measures. Though

strikes do not always win, even those that are lost at least induce the employers to forbear in the future and teach them a lesson they do not readily forget, that labor is the most important factor in production, entitled to consultation on the wages, hours and conditions under which labor shall be performed. Strikes pave the way to voluntary arbitration, but that such arbitration shall not be one-sided, labor must be possessed of determination, steadfastness, business methods, and perfected organization, the highest form of which is had in Federation.—The Wisconsin Labor News.

KEEP ON LEARNING.

Lincoln once said, "There is not much to a man who is not wiser today than yesterday." This is universally true. It is only the fool who never changes his mind. The wise man is always endeavoring to add to his knowledge. If what he learns today is different from what he learned yesterday and gives him different views of things, he should keep his mind open to new knowledge. He will not change his opinions for light reasons, but will consider all that comes to him and change when he sees good reasons for changing. If one is not willing to listen to the arguments of others, he need not expect them to listen to his opinions. He gets in a mental rut and sticks there, never improving. The wise man learns something, be it ever so little, from everyone with whom he has to do. Even the fool teaches him to keep his mouth shut when he has nothing to say, and many wise thoughts come from the prattle of a child. No man is so ignorant that he does not know something that may be of benefit to others. Learn something in old age as well as in youth. There is a proverb, "Live to learn and you will learn to live." Keeping the mind active is one way of keeping your youth. Learning at all times and in all ways gives one a cultivated mind. The man who has cultivated his mind is ready to make his knowledge useful to others. Unexpected occasions often arise when knowledge is needed for immediate action. The man with cultivated mind is ready, while the man who has lived in a mental rut cannot adapt himself to the occasion.—Milwaukee Journal.

SUBSTANTIAL PROGRESS.

Despite the small number of states which have held legislative sessions in 1914, several measures which indicate substantial progress in the work of improving labor conditions nationally, have been enacted into law, according to the recent report of the American Association for Labor Legislation.

Noteworthy among these in New York's action in establishing a state-wide system of free employment bureaus within the state department of labor. The special signif-

cance of this measure lies in the fact that it denotes a renewed determination to make scientific provision for meeting the unemployment problem, which at present is undoubtedly the most pressing of all industrial questions.

The recently approved theory that every industry must bear the cost of industrial accidents as well as other operating expenses, is embodied in the workmen's compensation laws which have been passed in Maryland, Kentucky, New York and Louisiana. A number of states—including Massachusetts—have amended their compensation laws to liberalize the provisions of the already existing codes.

Massachusetts is conducting a study of old age and its relations to dependency and is also preparing to initiate inquiries into other forms of social insurance. New Jersey has brought her law for the prevention of occupational diseases to a high standard by adopting measures for the prevention of compressed air illness and lead poisoning. Eleven states legislated for the protection of the child worker. Arkansas, Kentucky, Virginia, Georgia and Mississippi passed entirely new codes, the general trend of which is to raise the minimum age for any employment and for specifically dangerous occupations, to reduce hours of labor for child workers, to prohibit night work and to raise requirements for the issuance of employment certificates.

These are only a few of the things which have been accomplished for the worker. Far-reaching, humane legislation has not dragged in the year which just closed; on the contrary, much that is constructive in the best sense of the word has been done. It has been said that the next decade will see less effort to legislate in the interest of the worker—especially the woman and the child employe. But those who are in touch with sentiment all over the country know that labor legislation which conserves the worker's life and energy and makes him a more efficient producer cannot be refused. The call of business is efficiency, and surely it is no more than good business sense for the nation and the states to legislate for working conditions which make for efficiency.—Milwaukee Journal.

COLORADO MINERS' STRIKE COMMISSION.

The fact that the mine operators of Colorado rejected the agreement proposed by the federal government did not change President Wilson's conviction that the plan was obviously fair and sensible. A sense of duty forbade that he do nothing. He, therefore, appointed the commissioners provided for in the proposed plan of adjustment. The men named are to serve as a committee through which the miners may state their case and to which differences are to be referred for decision. The com-

mission constitutes an agency through which the differences of the employers and the miners can be adjusted. The following experienced men compose the board: Seth Low, president of the National Civic Federation, who has served as mediator in several labor disputes; Charles W. Mills of Philadelphia, a bituminous operator who has acted as mediator for the Department of Labor several times, and Patrick Gilday, president of District No. 2 of the United Mine Workers, who has served as mediator with Mr. Mills on other occasions.

The miners' organization had agreed to the President's plan as conceding many of their contentions. When the President appointed this commission the miners voted to declare the strike off in order not to embarrass or impede the work of the federal commission. Upon that commission now rests the duty to ascertain what is just and to use its good influences for its establishment.

The emphatic condemnation which the mine operators of Colorado have evoked from the American people has not been decreased by their unqualified and unreasonable rejection of all proposals to adjust the mining difficulties that caused the strike.

The arrogance which the mine operators manifested in dealing with the federal government and the nation's interests was a counterpart to the arrogance with which they treated the miners as employes and as strikers. That arrogance has its root in the great power which their property holdings give them—power which enabled them to control not only the working conditions, but the home lives of their employes; power which enabled them to declare any act, social, economic or political, not in furtherance of their financial interests, a violation of their property rights. We have asserted again and again that the fundamental problem, not only in Colorado but in West Virginia and in Michigan, is the tremendous power that results from owning large tracts of land which take on the outward semblance of feudal estates, governed and policed by private individuals and under ownership of absolutism. The problem of preventing private property rights from interfering with social welfare cannot be solved by the federal commission.

The Colorado coal strike has not failed; the miners step aside that the federal commission may have an open field. The Colorado strike has done more to burn the cause of unionism into the hearts and habits of the coal miners than decades of agitation could have done. It has demonstrated that the only power that stands between them and ruthless exploitation by their employers is the trade union organization. The lawlessness, the cynical brutality and disregard for human life have furnished unanswerable arguments for the necessity of organization. Unionism born of such desperate struggles is unionism that endures.

The Colorado strike has given wide publicity to the wrongs and injustice which have been inflicted on the miners. Benefits will come to them because they have demonstrated their power, because employers will no longer dare to continue all the former abuses, since they have been made to understand and feel that financially it

is too costly, and their course stands condemned before the judgment of the people.

The work of organization will go steadily on in Colorado. Collective action is the only defense the miners have against private aggression and exploitation—the only instrumentality of justice upon which the workers can rely.—American Federationist.

News of General Interest.

THE CRIMINAL "SPEEDING UP" SYSTEM MUST STOP.

The recent report of the House Committee on Labor upon the Taylor system of shop management emphasizes the physical effects of "speeding up." Persistent efforts to have this system introduced into the War Department have resulted in its partial installation in the Watertown and Rock Island arsenals. Those establishing this system have concerned themselves principally with "speeding up" the workmen.

The report divides the system under three headings—standardization, systematization and stimulation. The expense incurred for the first and second purposes of the system falls upon the operators; the costs of the third, stimulation, are paid by the workers in their physical health. This the House Committee's report recognizes:

"The Taylor system regards the workman as a machine to be 'speeded up' to its maximum capacity. When this human machine fails to function to the satisfaction of the management it is to be cast aside to make room for the new machine—a fresh workman. The authors of the system do not appear to have concerned themselves about the ultimate fate of the human derelicts who may be compelled to drop out because they cannot stand the pace. Mr. Taylor boasts that when he installed his system in the Bethlehem steel works he purposely made the tasks so hard that 'not more than one out of five laborers (perhaps even a smaller percentage than this) could keep up.'

"That may be the kind of 'efficiency' which produces dividends for the steel trust, but it is surely not the system which a beneficent government should force upon its employees."

The Taylor system endeavors to work men up to the very edge of a breaking strain. Stop-watch observations are used as a basis for setting a pace for workers. Upon the effectiveness of this method the House Committee on Labor quotes from a report made to the Sixty-second Congress. Two members of the present Cabinet, Secretaries Redfield and Wilson, were members of the committee making the report, which said in part:

"By the stop-watch you may be able to determine the time in which a piece of work can be done, but you do not thereby alone

determine the length of time in which it ought to be done.

"The time study of the operations of any machine can be made with a reasonable degree of accuracy because all of the elements can be taken into consideration in making computation. A machine is an inanimate thing—it has no life, no brain, no sentiment, and no place in the social order. With a workman it is different. He is a living, moving, sentient, social being; he is entitled to all the rights, privileges, opportunities and respectful consideration given to other men.

"He would be less than a man if he did not resent the introduction of any system which deals with him in the same way as a beast of burden or an inanimate machine."

The relation between the fatigue caused by speeding up and predisposition to disease has not been generally recognized. Nerve diseases are not generally classified as occupational diseases and yet it is difficult to set limits to the effects of work upon the nerves. A recent book, "The Occupational Diseases," by Dr. W. Gilman Thompson, emphasizes this relation and designates as occupational diseases paralysis, atrophy, neuritis, neuralgia, spasms, neurasthenia, hysteria, sciatica and others that are usually considered diseases of the leisure class. Frequently the occupation is only a contributing cause; nevertheless, the conditions of modern industry necessitate longer rest periods with absolute change of interests. The workers often cannot have proper rest because they cannot pay for proper conditions. In this connection Charles L. Dana, quoted by Dr. Thompson, has said:

"It is not occupations themselves, but the industrial and domestic conditions to which working people are subjected, which cause the mass of nervous and mental diseases. Scientific management, therefore, which speeds up the human machine, must give it longer rest and an absolute change of nervous and mental interest."

Dr. Thompson's statement upon general fatigue is suggestive of many physical results of industrial conditions:

"Fatigue of muscles, nerves and the mind constitutes an important factor in predisposition to disease among many classes of workmen and operatives. Its effects have

become very noticeable of recent years, owing to the practice of 'speeding up' or increase in frequency of accidents from tracts where time-saving is an essential matter. General fatigue is most often met with among mill and factory operatives in the textile fabric industries. In these industries much complicated machinery is employed and the faster it is operated and the longer the hours of work the greater the physical and mental strain and consequent fatigue reaction. These problems have been most comprehensively studied by Josephine Goldmark in her admirable book on 'Fatigue and Efficiency,' comprising the results of studies made under the auspices of the Russell Sage Foundation.

"Potent factors in inducing fatigue found in large factories are incessant floor vibrations, as where many looms are working, constant noise, the confusion resulting from overcrowding, poor air, poor light and monotony of work. Fatigue is known to diminish the quantities of antibodies in the system, and hence to increase its susceptibility and lower its resistance to infectious diseases such as grippe, pneumonia and tuberculosis. General fatigue further acts by inhibiting digestion and ultimately interfering with nutrition. Another important result of general fatigue is in the decided increase in frequency of accidents from machinery which it occasions by lessening the alertness of the operative.

"In many industries, such as those of clothing manufacture, fruit and vegetable canning, etc., the season of the year makes the work periods very uneven, so that the employe may alternate idleness with physical strain and mental worry. For women and children this is particularly bad. Women possess as a rule less reserve strength than men for endurance in such tasks, and owing to the menstrual function frequently becoming disordered under fatigue, they are liable to suffer serious and sometimes permanent impairment of health. They are also more liable to suffer from constipation, digestive disorders and anemia, especially of chlorotic type.

"In some industries, such as work with blast furnaces, men are sometimes required to work in twenty-four-hour shifts, although of late years this has been found to be an economic disadvantage and is, therefore, less common than formerly. Engineers of fast trains are liable to the strain of long hours of concentrated work and attention, and the fatigue thus induced so lowers their power of alertness that serious accidents have in the past resulted from it.

"Continued fatigue results in muscular tremor and weakness, somnolence or sometimes insomnia, and has a marked tendency to lessen the activity of the digestive functions. If greatly prolonged it results in neurasthenia, hysteria and a variety of functional nervous disorders. Neuralgias also are induced by it. Very similar to the effects of physical fatigue are those of worry

which are more or less associated with occupation. Among these must be reckoned the fear of losing work, inability to complete allotted tasks on time, and a host of domestic anxieties, most of which resolve themselves into the matter of low wages and the consequent inability to secure adequate food and housing."

The discussions of specific diseases will be very helpful to those studying so-called scientific management. Every local and international union should make it a particular duty they owe to their membership in the trade or industry to secure the fullest and most reliable information upon the important question of safeguarding the health and the lives of the workers in their respective jurisdictions. In addition, the information is a refutation and indictment of the claims of the "speeding-up" system.

Only an orientation has been made into the study of occupational diseases. The study does not reveal new diseases, but search for preventive methods reveals casual relations between industry and diseases. The workers themselves are primarily interested in this phase of medical progress and must avail themselves of all information that will help them to protect their lives and health. It is as necessary to heed the warnings which modern science gives of impending dangers from disease as warnings of impending accidents.—Samuel Gompers, in the American Federationist.

"FIRST TIME IN HISTORY."

Exploits of John Paul Jones Recalled as Being Yet "Unparalleled."

"The first time in history" is a dangerous phrase to play with. How the country has been misusing it The Philadelphia Public Ledger recalls thus:

London correspondents who describe the German raid upon a British port as "unparalleled in English naval history" have not read much history.

Any American boy could tell them about John Paul Jones, and how he sailed into Whitehaven, spiked forty guns of the fort and later cruised all around the British domain, capturing or destroying dozens of ships. Dashing into an enemy's harbor was one of his commonplace stunts, and he didn't do it in any submarine, either.

Why, a crew from his bold Ranger even went ashore and sacked the home of the Earl of Selkirk. Jones gallantly sent back to Lady Selkirk the silver plate his men had stolen from her castle.

The smartest German submarine will have to travel at a furious clip to match the record of destruction around Great Britain wrought by this most daring of all American sea rovers.

Yes, John Paul Jones did not do business with any sneaky little submarine. He sailed in, above water, as bold as brass. His exploits along England's coast are still "unparalleled in English naval history."

HYDRAULIC RIVETING THE STEEL STRUCTURE OF THE WHITE STAR LINER "BRITANNIC."

By Frank C. Perkins.

The new White Star liner, "Britannic," has a length over all of about 900 feet and breadth of about 94 feet, while the moulded depth is 64 feet 3 inches, and the total height from keel to navigating bridge measures 104 feet 6 inches.

The gross tonnage of the "Britannic" is said to be about 50,000 tons and it has a load draft of 34 feet 7 inches, with a displacement at load draft of over 53,000 tons.

This great ocean liner is propelled by reciprocating engines of 32,000 indicated horse power and a steam turbine of 18,000 horse power.

keel is formed by a single thickness of plating $1\frac{1}{2}$ inches thick, and a flat bar $19\frac{1}{2}$ inches wide by 3 inches thick. The bottom plating is hydraulic-riveted up to the bilge, the strakes being arranged clincher fashion for this purpose; and the frame bottoms are joggled, to avoid the use of tapered packing pieces. To reduce the number of butts and overlaps to a minimum, plates of large size are adopted. The shell plates generally are 6 feet wide and about 30 feet long, with a weight of $2\frac{1}{2}$ to 3 tons. The largest shell plates are 36 feet long and weigh $4\frac{1}{4}$ tons each.

There is a cellular double bottom, extending right out to the ship's sides, with floors on every frame, and this double bottom is 5 feet 3 inches deep, and is increased 6

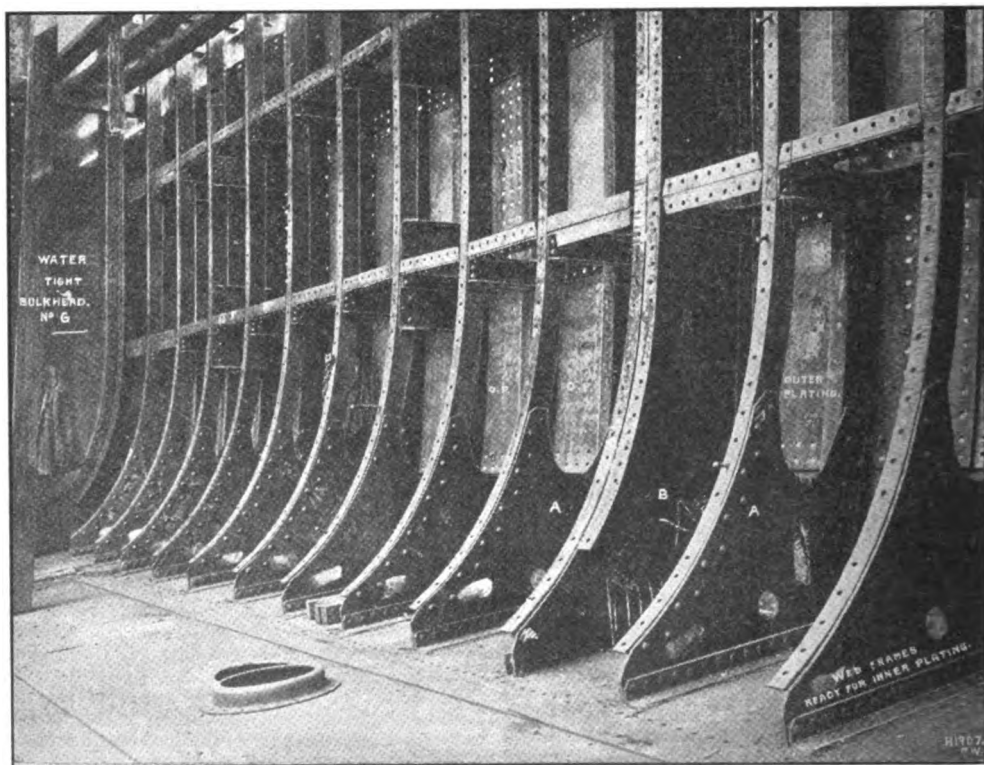

WHITE STAR LINER BRITANNIC, SHOWING ARRANGEMENT OF WEB FRAMES.

The Britannic was designed to carry a crew of 950 men and 2,500 passengers. There are eight steel decks amidships—the boat deck, promenade deck, bridge deck, shelter deck, saloon deck, upper deck, middle deck and lower deck—while at the ends there is an extra deck, known as the orlop deck—making nine decks in all.

It is pointed out that the main structure of the vessel extends to the bridge deck, which is carried for 550 feet amidships, and the superstructure at the ends of the ship consists of a poop 106 feet long, and a fore-castle 128 feet long. All of mild steel the

feet 3 inches in the reciprocating engine room. The subdivision of the double bottom into separate tanks is arranged to provide ample facilities for trimming the vessel, or for correcting any list due to unequal disposition of coal or cargo. The double bottom is divided into four compartments transversely by the water-tight center keelson and water-tight longitudinals on each side, 30 feet from the center line, the subdivision being completed in the usual manner by transverse water-tight floors. The subdivision into four tanks transversely is also of benefit to the stability of the ship,

owing to the limited width of the free water surfaces in the tanks used for the boiler feed water and for the passenger water service. Besides the continuous tank girder mentioned above, there are five intercostal tank girders amidships on each side of the center keelson, and additional girders are fitted beneath the engine rooms.

It is of interest to note that the spacing of the frames is 3 feet amidships, reduced to 24 inches forward and 27 inches aft. The frames are of 10-inch channel sections, except at the extreme ends, where a built section of frame and reverse bar is adopted. The channel frames extend from the tank top to the bridge deck, some of these bars

bulkheads, of which there are sixteen in all, and a number of other bulkheads forming the cross bunker ends. The decks have a camber of 3 inches. The beams of the bridge, shelter, saloon and upper decks amidships are supported by four longitudinal girders, which are in turn carried by solid round pillars spaced 9 feet apart. Below the middle deck in the boiler rooms round pillars are also adopted, 9 feet apart, in conjunction with strong beams carried across at the lower deck level in way of each web frame. In the case of the inner rows the pillars are spaced out so that they do not interfere with the working passage. In the engine rooms and holds the pillars

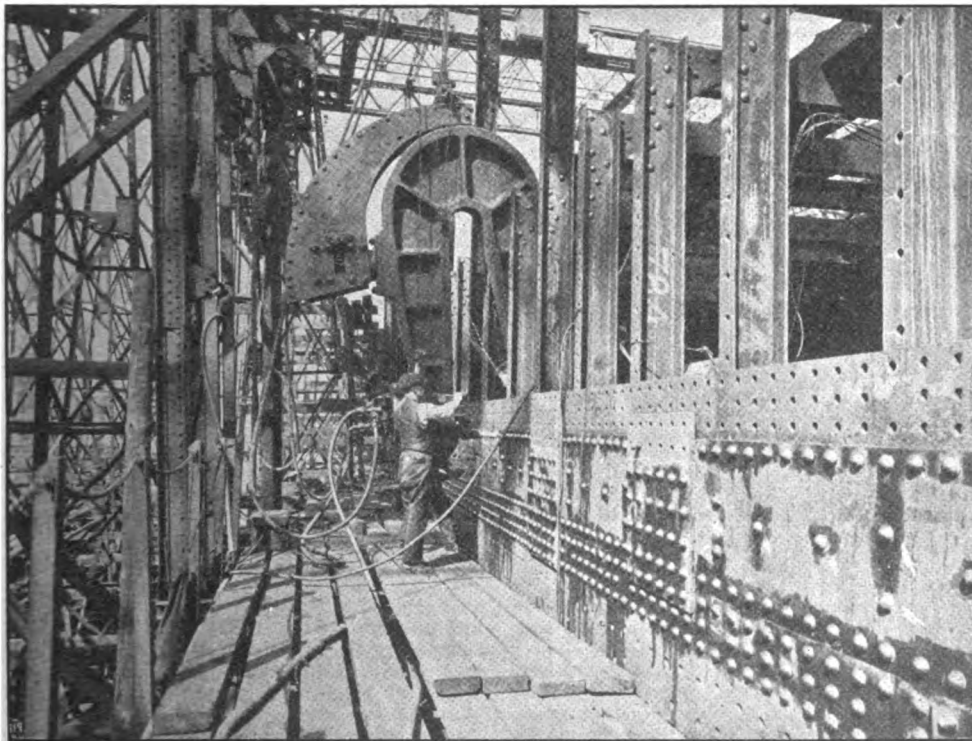

HYDRAULIC RIVETING ON THE WHITE STAR LINER BRITANNIC.

having a length of about 66 feet and weighing nearly one ton. An inner skin is fitted from the tank top to 3 feet 6 inches above the middle deck, a point well clear of the water-line, and it extends the length of the engine and boiler spaces. It is composed of steel plating, with 6-inch channel frames spaced 3 feet apart, and 5 longitudinal stringers running right fore and aft, well connected to the shell and inner skin. The beams of the main structure are of channel section, 10 inches deep amidships, the largest being 93 feet 6 inches long and weighing about $1\frac{1}{4}$ tons.

The beams are connected to the frames by bracket knees. The transverse strength is also maintained by the watertight

below the middle deck are wide spaced and of circular built section, the deck girders being increased in strength to suit the longer span.

As the ship gets narrower at the ends the number of rows of pillars is reduced. Bilge keels, 25 inches deep, are fitted for about 300 feet of the vessel's length amidships, to minimize rolling in a seaway. The two decks forming the superstructure of the ship and the navigating bridge are built to insure a high degree of rigidity. At the sides they are supported on built-up frames in line with the hull frames, but at wider intervals. The deck-houses are specially stiffened by channel section steel fitted in the frame work; and where, as on the boat

deck, the public rooms pierce the deck, heavy brackets are introduced to increase the resistance to racking forces when the ship is steaming through a heavy seaway. The boat and promenade decks are increased to 96 feet wide, to enlarge the promenade space. Exposed decks are sheathed with wood, but inside deck-houses and decks not exposed to the weather are covered with composition.

In order to insure the best workmanship, hydraulic riveting was adopted whenever possible. Nearly the whole of the double bottom—including the bottom shell plating up to the turn of the bilge, and the top side shell and stringer plates and doublings—have been riveted by hydraulic power. The seams of the bottom plating are double riveted, and of the topside plating treble and quadruple riveted. The butts of the bottom plating are overlapped and quadruple riveted, as are also the butts of the side

The firebars are of the Campbell type and all boilers have Blake's patent furnace bridges. The shells of the single-ended boilers are formed in one strake, the double-ended boilers having, as usual, three strakes. All the shell plates are of mild steel, 1 11-16 inches thick. The arrangement of uptakes, by which the smoke and waste gases are conveyed to the funnels, is of an elaborate nature, no less than twenty branches being required to one funnel in the case of boiler rooms 3 and 4. The branches from adjoining boiler rooms are united immediately above the water-tight bulkhead separating the rooms, the bulkhead thus forming a valuable support to the uptakes and funnel above. There are four funnels which have an elliptical cross section, and measure 25 feet 6 inches by 19 feet 9 inches. Their average height above the level of the furnace bars is 160 feet. The bunkers consist of a 'tween deck space

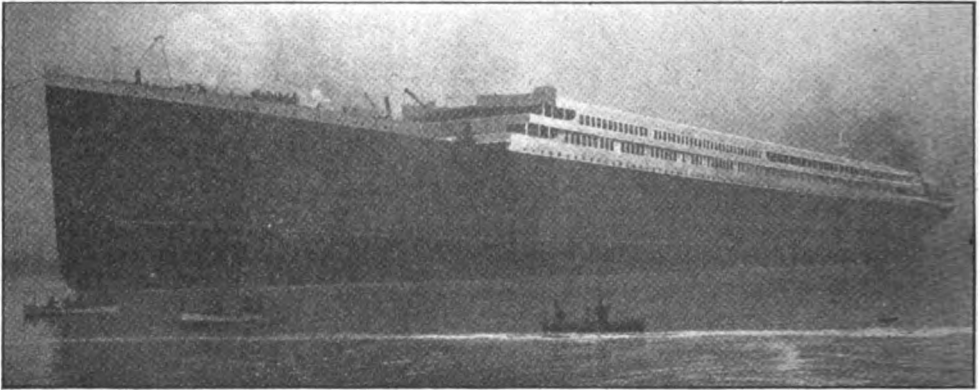

WHITE STAR LINER "BRITANNIC" AFTER BEING LAUNCHED.

plating, except in the way of the topside shell and doublings, where double traps are adopted.

The boiler plant includes altogether twenty-four double-ended and five single-ended boilers designed for a working pressure of 215 pounds, which it is anticipated will be maintained under natural draught conditions. The aftermost, or No. 1 boiler room, contains the five single-ended boilers; boiler rooms No. 2, 3, 4 and 5 contain five double-ended, and the foremost, or No. 6 boiler room, contains four double-ended boilers. Owing to the great width of the ship, it was found possible to arrange five boilers abreast, except in No. 6 boiler room, where only four abreast are fitted. Each of the double-ended boilers is 15 feet, 9 inches in diameter and 21 feet long, and contains six furnaces; while the single-ended boilers, which are of the same diameter as the double-ended, but are 11 feet 9 inches long, contain three furnaces, so that the total number of furnaces is 159. The latter are all of the Morison type, 3 feet 9 inches inside diameter, and are provided with fronts of the Downie "boltless" pattern.

on each side of the ship, between the lower and middle decks, into which the coal is first shipped, and from thence distributed into the cross bunkers extending the full width of the vessel in each boiler room. The stokers obtain the coal from doors in the cross bunker end bulkheads at the stockhold level, immediately opposite the furnaces, an arrangement which reduces the amount of handling of the fuel for each boiler to a minimum. A further advantage of the bunker arrangement is that no water-tight doors are required in the bunker ends, as each set of boilers has the necessary coal supply provided in the same water-tight compartment, the water-tight bulkheads dividing the boiler rooms being placed at the center of the cross bunkers. Six Underline Ash Expellers are used, one in each boiler room, and in addition there are four ash hoists for use when the vessel is in port. Ash hoists of this type have proved remarkably free from wear and tear, and require a very small supply of steam, a ¼-inch pipe only being used for the steam inlet. There is no forced draught provided, it being the practice of

the White Star line to have forced ventilation only to the boiler rooms of their ships. For the latter purpose, twelve Sirocco fans, two for each boiler room, have been supplied by Davidson & Co., of Belfast, fitted with Allen motors. The fans are placed at the middle deck level, and draw in air through ventilating shafts from the boat deck, supplying the same through trunks led down the bulkhead to the level of the furnaces.

U. S. DEPARTMENT OF LABOR CHILDREN'S BUREAU, WASHINGTON.

"Infant Care" is the title of a pamphlet just issued by the Children's Bureau of the United States Department of Labor. It is the second of a series of popular pamphlets for the use of mothers on the care of children. The new publication takes the baby from birth through its second year, dealing with such questions as feeding, clothing, bathing, sleep and exercise, or in other words, with the questions which all mothers must face, sooner or later, in the care of the baby. The book is written in simple, non-technical language, easily understood by the average American mother. Special mention is made, also, of the care of American babies in the tropics. It contains 84 pages, is illustrated with a number of plates, and pictures and includes an appendix and a useful index. The appendix gives a list of other government publications regarding matters of domestic economy, such as milk, foods, home sanitation, and other subjects of importance in the work of making the home suitable for the rearing of children.

The pamphlet will not, of course, take the place of the advice of a physician, but it includes a section on how to keep the baby well, which describes the minor ailments of babyhood and the symptoms indicating the onset of more serious illness. Special emphasis is placed on the danger to infants of whooping cough and measles.

The pamphlet was prepared, under the direction of Miss Julia C. Lathrop, Chief of the Bureau, by Mrs. Max West, who also prepared the pamphlet on Prenatal Care, which was the first of the Care of Children Series. Infant Care, like all the other publications of the Bureau, may be obtained free of charge by addressing a postal card request to the Chief of the Children's Bureau, Department of Labor, Washington, D. C.

"EUROPEAN TOUR" CONTEST."

Los Angeles Union Labor Temple Association Offers Two Trips to Europe.

A trifle less than eleven years ago a mass-meeting of the representative officers of the labor organizations in the city of Los Angeles, Cal., was called for the purpose of discussing the advisability of erecting a Labor Temple. The members present commended the idea unanimously, and

shortly thereafter a Board of Directors was elected and a state charter secured. The By-laws provided that to be eligible as a director a person must belong to a bona-fide labor organization, own stock in the association, and that no two directors should be selected from the same craft. Thus, briefly, was the project launched to erect a Labor Temple in the city of Los Angeles.

A site centrally located was selected, plans perfected, and in a few years a magnificent seven-story building erected—80 feet front by 125 feet in depth—admittedly the most imposing structure ever erected by Organized Labor in this country. The value of the property is conservatively estimated at \$350,000. Approximately, 100,000 shares of stock have been issued to labor organizations and individual members. To date, the property has been economically managed and is in first-class condition, notwithstanding the assertion made by the union-wrecking Los Angeles Times that "The laborites were not competent to handle the Los Angeles property, and that it would soon pass into the hands of the stable citizenship of the community."

Construction of Building.

The construction is of steel and brick, with hollow tile partitions, maple floors, except in toilets, which are tile. There are drinking fountains on each floor with an ice coil on the top of the building. The building is equipped with a first-class ventilating system provided with large fans on the roof. No money was spared in providing proper fire escapes and adequate exits. The building is equipped with two electric elevators and is steam heated. There are fourteen meeting halls, a banquet room and kitchen, one extra-large hall for dancing and mass-meetings, a large auditorium for entertainments, conventions, etc., and eighteen office rooms. On the ground floor are two rooms which at the present time are rented for commercial purposes, but which are expected to be utilized for banking purposes in the near future. There is also a barber shop, billiard hall and reading room on this floor. Provision has been made in the basement for the installation of machinery to generate light and power.

There is an outstanding indebtedness of \$120,000 at the present time, and the Board of Directors have determined to cancel this indebtedness by selling the remainder of the stock at \$1.50 per share in connection with a popular voting contest.

Immigration Problems.

Assuming that the opening of the Panama Canal will attract the major portion of the immigration of the world to the Pacific Coast, and that unless some steps are taken to educate our brothers and sisters across the water to the necessity of coming to this country in a prepared state, much suffering will follow. The Union Labor Temple Association purposes to send two representatives—one a woman—to the Continent of Europe for the purpose of getting in touch

with prospective European immigrants and acquainting them with conditions which will confront them upon their arrival if they come in an unprepared financial state.

Eligibility of Contestants.

No doubt the honor of representing Labor in such a meritorious undertaking, and the further incentive of the opportunity it will give to study conditions in the Old World, will cause intense rivalry and bring forward a large number of aspirants. Any member of a bona-fide labor organization (directly connected with the American Federation of Labor, or indirectly through a Central Labor body), or the wife, daughter, sister or mother of such a member, is eligible to enter the contest. The voting power will be based on the number of shares of Union Labor Temple stock sold and credited to the contestants.

At the present time the Temple is carrying an interest-bearing burden that will cease to exist just as soon as the remainder of the stock is floated, when every share of stock will pay a handsome dividend, probably as large as any legitimate investment on the market today. Unions or individuals could not make a safer or better investment.

The Association has opened headquarters in Room 203, Union Labor Temple, Los Angeles, Cal., and a vigorous campaign will be conducted until the last share of stock is sold.—Bulletin issued by Los Angeles Labor Temple Association.

A NEW CANADIAN CONSOLIDATION LOCOMOTIVE.

By Frank C. Perkins.

The accompanying illustration shows a new Canadian consolidation locomotive recently constructed at Kingston, Ontario,

tives weigh in working order 190,000 pounds, and are of the usual type of consolidation engines, with semi-wide fire box over frames. A complete installation of flexible staybolts are applied; also the latest type of Schmidt fire tube superheater, capable of producing steam continuously at an average temperature of 600 degrees Fahrenheit. The oil burning equipment is of the C. L. Co. standard design used in connection with the Von-Roden-Ingles type of oil burner.

It may be stated that the Walschaert valve gear is used with self centering valve stem. Radial bugger is fitted between the engine and tender. The headlights are electric front and back, as are also the classification and marker lamps, as well as those inside the cab, electricity being furnished by a turbo generator set, placed on top of the boiler in front of cab. Outside steam pipes are used, incased within an airtight jacket secured to cylinder and smoke box. This arrangement eliminates most of the obstruction in the smoke box met with the inside steam pipes. The feed water enters in the top of the boiler near the front tube sheet through a combination check valve of the C. L. Co. standard pattern. Hard grease lubricators used on all driving journals.

It may be maintained that the tender tank holds 6,000 Imperial gallons of water and 2,700 Imperial gallons of oil. The frame is built of 10" and 13" heavy steel channels. The truck is of the outside equalized type with a cast steel bolster, cast steel wheel centers with open hearth steel tires bolted on. The Canadian Westinghouse Air brake is used and duplex air pump. The following data is of interest: The tractive effort is said to be 36,300 lbs., while the weight of the engine in working order is about 190,000 lbs.

The weight of engine and tender loaded is

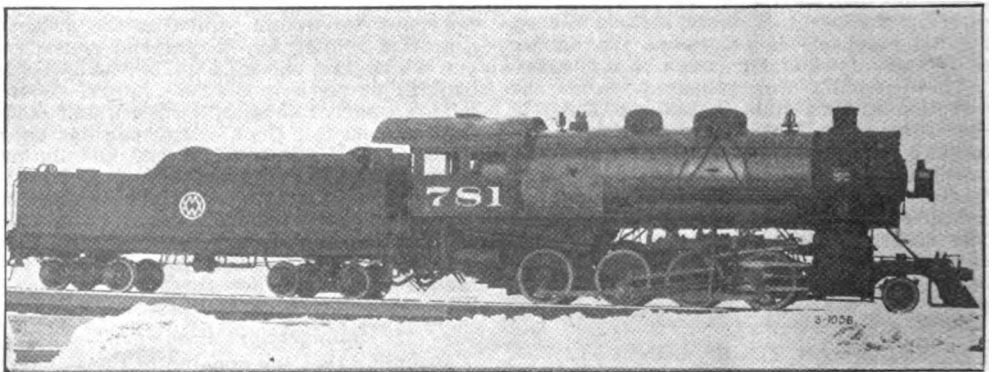

Canada. There were four oil burning locomotives of this type placed in operation on the new Pacific Great Eastern Railroad. This road runs out of the city of Vancouver, British Columbia, and when completed will connect up that city with the Grand Trunk Pacific Railway.

It is of interest to note that these locomo-

held to be 343,000 lbs. The wheel base rigid, measures 15 feet 6 inches, while the total wheel base engine 23 feet 9 inches, while the cylinder diameter and stroke is 22x28 inches and piston valves are employed, 12 inches in diameter.

On this engine the boiler pressure utilized is 180 lbs. and the boiler has a diameter at

the first ring of 66 $\frac{1}{2}$ inches, while the fire box length is 120 inches, and the width is 40 $\frac{1}{2}$ inches. The boiler has 183 tubes of 2-inch diameter each.

A WESTERN MARYLAND HIGH POWER LOCOMOTIVE.

(By Frank C. Perkins.)

The accompanying illustration shows a new western Maryland high power locomotive of interest. Its cylinders have a diameter of 25" and a stroke of 30". The driving wheel diameter is 52". The boiler has a diameter of 84 $\frac{1}{2}$ " and a pressure of 200 lbs. The firebox has a length of 110" and a width of 80 $\frac{1}{2}$ ". It has 36 tubes 5 $\frac{1}{2}$ " in

the chlorin content of untreated flour may run as high as 576 parts per million, chlorin-treated flour will contain over 600 parts per million. Chlorin-treatment increases the acidity of the flour. The gluten tests run practically alike for the bleached and unbleached flour. The baking experts report that there are no differences in loaf volume; but the bleached flour gives a loaf having an objectionable color and texture. In nearly every case the bread made from the unbleached flour graded better. The chlorin-bleaching cannot be defended on the ground that bread-making qualities of the flour are improved.—Journal of the American Medical Society.

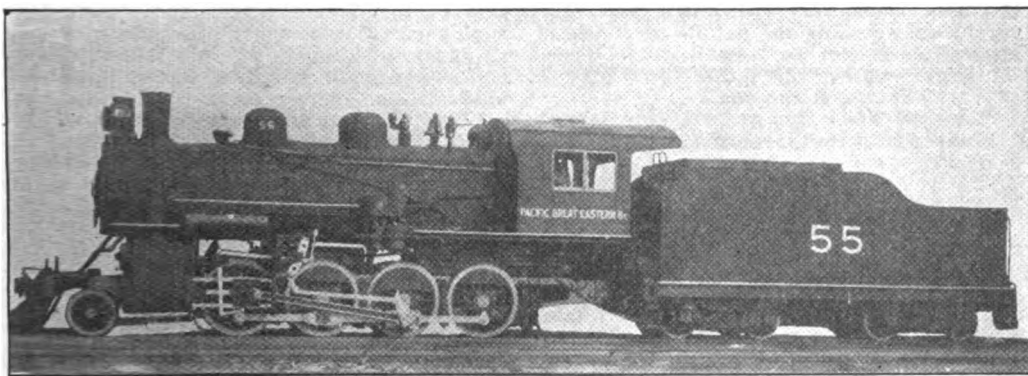

diameter with each a length of 15' 3", and 239 tubes 2 $\frac{1}{4}$ " diameter.

The driving wheel base is 16' 8" and the engine wheel base is 26' 2". The weight in working order of the engine is 244,500 and of the tender 177,000 lbs.

The fuel used is soft coal and the boiler has a total heating surface of 3147.8 square feet and a grate area of 61.3 square feet. The maximum tractive power is 61,300 lbs. and the factor of adhesion is 3.54. The tender has a capacity for water of 9,500 gallons and for fuel, 14 tons.

CHLORIN-BLEACHED FLOUR.

Since the bleaching of flour with the oxids of nitrogen has been forbidden in the United States under the Food and Drugs Act, there are signs of the introduction of other processes intended to produce similar changes in the wheat product. In one of these chlorin is the bleaching agent employed, the anhydrous gas being diluted with an inert gas and then used to "mature and whiten" the flour. Without commencing at this time on the legal aspects of the matter, we may fairly ask whether the new process confers any advantages on the cereal which will render it superior to the ordinary unbleached patent flour. Mere appearance need not be taken into consideration here. Experiments conducted in connection with the pure food work at the Kansas State Agricultural College in Manhattan have shown that although

THE INFECTIONS OF IMMIGRANT SHIPS

Under present regulations, ships having on board such diseases as scarlet fever and measles are not held at the maritime quarantine stations. Williams says in The Survey, that this is especially unsatisfactory with reference to immigrants arriving by sea, among whom the children often develop infectious diseases while on shipboard. Many persons are then exposed to the contagion, are landed and later develop these diseases in communities to which they go. Of the immigrants arriving at Ellis Island, for instance, many (in 1913, 87 per cent) land and proceed at once to their destinations. Among those detained for various reasons it is found that infectious diseases frequently develop, a majority falling ill within the period of incubation of these diseases as calculated from the date of landing, indicating that they were infected on shipboard. These outbreaks occur so regularly that it seems reasonably certain that the same thing happens among those not detained. For the year ended June 30, 1913, out of 834 patients with measles admitted to the Contagious Disease Hospital at Ellis Island, 576 were taken from ships on the day of arrival, and 258 additional cases developed among detained immigrants subsequent to arrival. Of the latter number, 167 fell ill within a period after arrival indicating that they had been infected on board. These 167 cases developed among the 13

per cent of immigrants detained. At the same rate among the 87 per cent not detained there would have occurred 1,117 cases of measles, distributed wherever these immigrants scattered themselves, each case becoming a possible focus for the further spread of the disease. Fifty-six cases of scarlet fever developed among the 13 per cent of detained immigrants, which, with a like calculation, would give 375 cases among the 87 per cent of those not detained. The

possibilities of the spread of these dangerous infections from this source are therefore great. Williams suggests as a remedy the proper isolation and handling of the cases on board ship, which is not at present carried out. Of the 576 cases of measles referred to, only 70 per cent were "manifested" on the ship surgeon's report, while the other 30 per cent were discovered only on examination at Ellis Island.—American Medical Society Journal.

Smiles.

ALL THERE.

The Pennsylvania Dutch have the reputation of being very economical and very careful in watching the details of domestic affairs, no matter how small.

"Heiny!" called the father.

"Vat?" answered the son.

"Run and count dem geese again, Heiny."

Heiny went; Heiny returned.

"Heiny!" said the father.

"Did you count dem geese again, Heiny?"

"Yes."

"How many vas dey, Heiny?"

"Vun."

"Dat's right, Heiny."

A small boy seated on the curb by a telephone pole, with a tin can by his side, attracted the attention of an old gentleman who happened to be passing.

"Going fishing?" he inquired, good-naturedly.

"Nope," the youngster replied. "Take a peek in there."

An investigation showed the can to be partly filled with caterpillars of the tusssock moth.

"What in the world are you doing with them?"

"They crawl up trees and eat off the leaves."

"So I understand."

"Well, I'm fooling a few of them."

"How?"

"Sending 'em up this telephone pole."—Judge.

One Sunday morning, a deacon observed a boy industriously fishing. After the lad had landed several, he approached and said: "My son, it is very cruel to impale that poor, helpless beetle upon that sharp hook."

Said the boy: "Oh, say, mister, this is only an imitation! It ain't a real bug."

"Bless me!" replied the deacon. "Why I thought it was a real bug!"

The boy, lifting a fine string of fish, said: "So did these suckers!"—Judge.

A country editor wrote: "Brother, don't stop your paper just because you don't agree with the editor. The last cabbage you sent us didn't agree with us either, but we didn't drop you from our subscription list on that account."—Boston Transcript.

A group of San Francisco stevedores were lunching in a sheltered nook on a wharf. One of them went across the street for a plug of tobacco, and during his absence another substituted for his tin of pale coffee and milk his own tin of milkless black coffee.

When the first stevedore returned to his lunch he could hardly believe his eyes.

"Well," said he, "I have heard of clever thieves, but to swipe the milk out of a guy's coffee is sure going some!"—"Everybody's."

Scene—Editor's sanctum. Printer (rushing in excitedly,—Here's a fine go! Giggigg, the murderer, has just been found innocent, and the Government has telegraphed a pardon. We've got the whole account of the hanging set up, with illustrations, and the form is on the press.

Editor (coolly—Don't get excited, man. Put over the account, in large capitals, "Giggigg" pardoned. Full account of what he escaped."

Tom Ochiltree, having been hurt in a railway accident, brought suit for damages. Walking with the aid of crutches some months afterward, he met a friend, who inquired:

"Can't you get along without crutches, Tom?"

"The doctor says I can," said Ochiltree, "but my lawyers says I can't."

THE CONVERSATION VERBATIM.

From Tit-Bits:

Counsel—I insist on an answer to my question. You have not told me all the conversation. I want to know all that passed between you and Mr. Jones, on the occasion to which you refer.

Reluctant Witness—I've told you everything of any consequence.

"You have told me you said to him, 'Jones, this case will get into the court some day.' Now I want to know what he said in reply."

"Well, he said, 'Brown, there isn't anything in this business that I'm ashamed of, and if any snooping, little, yee-hawing, four-by-six, gimlet-eyed lawyer with half an ounce of brains and sixteen pounds of jaw ever wants to know what I've been talking about, just tell him.'"

Lodge Notices

Notice.

All Brothers of All Organized Labor:

Anyone giving any information as to the whereabouts of my father, S. W. Hill, will notify me, at the address below, and will say I will appreciate same.

S. W. HILL,
507 Taylor St.,
Davenport, Ia.

Mason, Reg. No. 70238.

J. T. Mason, Reg. No. 70238, correspond with secretary of Lodge No. 499, J. D. Allen, and will save him trouble. Sapulpa, Okla.

Dear Sir and Bro.:

I wish you would publish in the next issue of our Journal an apology to Bro. H. Czatlenski, Reg. No. 64923 from Lodge No. 32. This Brother didn't beat this room rent in Armourdale, but some other boilermaker that had stolen his card and book did it. I have already written the brother a letter and sent it to him at Ottumwa, Iowa.

WALTER E. DWYER,
Secretary Lodge No. 32.

Tupen, Reg. No. 64677.

Herman Tupen, Reg. No. 64677, please correspond with Charles Loeb, Tulsa, Okla., care Frisco Shops.

HUGGINS—MARSHALL.

C. W. Huggins is requested to correspond with the undersigned.—J. B. Marshall, 1114 So. Frisco, Tulsa, Okla.

Thompson—His Wife.

Anyone knowing the whereabouts of Brother Thomas S. Thompson, Reg. No. 5942, formerly a member of Lodge No. 11, will please notify Mrs. Thomas S. Thompson, 1508 East Twenty-sixth Street, Minneapolis, Minn., who states she and the three small children are cold and hungry, as he has not provided for them in months.

NOTICE, TEXAS UNIONS

Want address of Frank Farley, boiler maker, recently from Mexico, to clear land title. J. M. Daniel, Laredo, Texas.

In Memoriam

MEMBERS.

Rudolph Polite, Reg. No. 97662, of Lodge 37, age 25, New Orleans, La. Fell 40 feet into the river on December 2, 1914. Single.

J. H. Wingo, Reg. No. 95558, of Lodge No. 4, Birmingham, Ala. Was born in South Carolina. Killed on December 15, 1914, by being caught in a shaft.

W. L. Wurzbach, Lodge No. 45, Newport News, Va.

ROWAN.

Brother John Rowan, Reg. No. 43141, of Lodge 15, Dubuque, Iowa. Died January 7, 1915, by being run over by an engine while on the way to work. Age 59.

GILTHORPE.

Wm. J. Gilthorpe, of Lodge 32, Kansas City, Mo., died January 9, 1915, of Pneumonia. He was born in Dublin, Ireland, June 5, 1844; age 70. Until recently International Secretary-Treasurer.

Thomas Scheler of Lodge No. 463, Balboa, Canal Zone, Panama.

RELATIVES OF MEMBERS.

Mrs. Anderson, wife of J. F. Anderson, c. Lodge No. 14, Chattanooga, Tenn.

Mrs. Mollie Brannom, sister of Brother J. C. Sentell, of Lodge No. 143, Knoxville, Tenn., died at her home, 131 West Fourth Avenue, December 14, 1914. Age, 28 years.

Mrs. J. M. Hansell, sister of Brother W. T. Harris, of Lodge No. 143 Knoxville, Tenn., died at her home, 1112 Lutrell Street, December 27, 1914. Age, 48.

Master Roy Lee Pack, age 3, son of Brother and Mrs. R. L. Pack, died at their home, 1523 Van Street, Knoxville, Tenn., December 15, 1914. Brother Pack is a member of Lodge No. 143.

Charles Flick, Sr., age 55, father of Brother Charles Flick of Lodge No. 37, New Orleans, La. Mr. Flick was murdered with a sledge hammer on December 24, 1914.

Mrs. Nervesta McNeil, mother of Charles McNeil, of Lodge 143, Knoxville, Tenn., died January 10, 1915, of Pneumonia. She was born in Clairborn Co., Tenn., April 10, 1862. Age 53 years, 9 months.

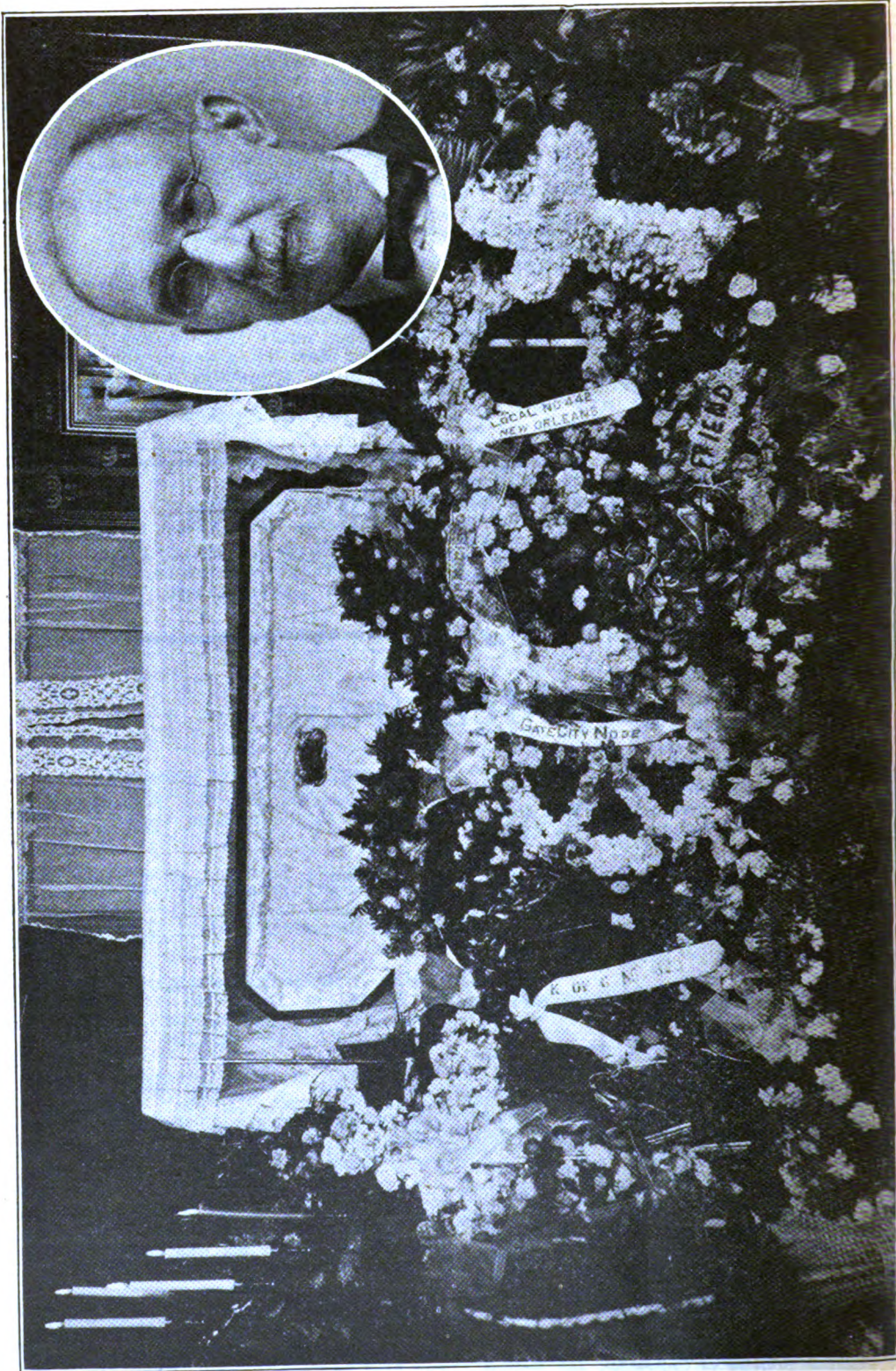

THE ABOVE PHOTO SHOWS THE REMAINS OF FORMER INTERNATIONAL SECRETARY-TREASURER GILTHORPE AND SOME OF THE

WM. J. GILTHORPE

Mr. Wm. J. Gilthorpe, a highly esteemed and prominent resident of Kansas City, Kansas, died suddenly Saturday, January 9th, at 6:15 P. M. at the home of his daughter, Mrs. A. B. Campbell of Minden, La., where he and his wife were visiting for the winter.

Mr. Gilthorpe made no complaint until Thursday night, and no thought of death entered anyone's mind. Mr. Gilthorpe was in his 71st year and an almost life-long resident of New Orleans, having come to Louisiana when a boy. He was born in Dublin, Ireland, June 5, 1844. His parents were both natives of Dublin. The foundation of his good solid education was laid in Ireland.

Throughout his younger manhood, Mr. Gilthorpe was a boiler maker and for years worked successfully at his trade. In 1890 he organized the International Local No. 42, in New Orleans and became its first president, later the consolidation of National and International Brotherhood became Lodge No. 37 of which he was president.

In 1891 at the convention in St. Paul, Minn., he was elected International Secretary-Treasurer. After this consolidation the Brotherhood established headquarters at Kansas City, Kansas, and Mr. Gilthorpe and his family made their home in Kansas. He was 23 years Secretary-Treasurer. At the last convention of the Brotherhood held in San Francisco, June, 1914, the delegates in recognition of his untiring and valuable service of the Brotherhood, and believing that he should be permitted to spend the balance of his days in ease and away from care and worry, which the office of secretary imposed, retired him upon an annuity of one hundred dollars (\$100.00) per month. The first time this has been done in the history of organized labor. In New Orleans his friends are legions and his worth was fully recognized in Kansas, his home for twenty years, as well as all over the United States in labor circles.

James Waters, a boiler maker and a life-long friend, accompanied the family with the remains from Minden, La.

Lodge 328, boiler makers of Shreveport, La., held a special meeting and a delegation was at the depot to meet the remains, as also a delegation of the Knights of Columbus, where a requiem mass was said Sunday morning at the Jesuit Church, celebrated by Rev. Father Filliger, who delivered a beautiful sermon over the remains.

The funeral took place Wednesday morning, the 13th, from his home, 831 Tauroomee avenue to S. Mary's Church, Kansas City, Kansas, at 9:30 A. M. at a solemn Pontifical Mass celebrated by Bishop Ward of Kansas City, Kansas, assisted by Father Michael as deacon, Father McKenna as sub-deacon, Father Cajetan, O. F. M., and Father McDonald, O. S. B., as deacon of honor. Father Vallia as master of ceremonies. The sermon was preached by Father Jennings, pastor of St. Mary's Church, and who gave such a tribute to the mortal remains of Wm. J. Gilthorpe, that only his Father confessor could speak.

By celebrating mass for Mr. Gilthorpe, Bishop Ward said his first mass for a layman since consecrated bishop. The funeral was largely attended by relatives, friends and business men, as well as a large delegation of his own and affiliated crafts. Burial in St. John's cemetery, Kansas City, Kansas.

The pall-bearers were chosen from the boiler makers and Knights of Columbus:

Charles McDonald, Lodge No. 32, Kansas City; J. J. Murphy and John Coots, Lodge No. 322, St. Louis, Mo.; Thos. Donegan, Judge M. E. Manning and F. Hauber, Domain Council, K. of C. Lodge No. 826.

Floral designs were sent from "The Executive Council of the Brotherhood, Lodge No. 32, Kansas City; Lodge No. 25, San Francisco, Cal.; Lodge No. 322, St. Louis, Mo.; Lodge No. 328, Shreveport, La.; Lodge No. 422, New Orleans, La.; Lodge No. 66, Little Rock, Ark.; Industrial Council and Organized Labor of Kansas City, Mo.; Geo. R. Stoll, Grand Junction, Colo.; Domain Council No. 826, Knights of Columbus, St. Vincent de Paul Society, Kansas City, Kansas. his employees who were under his charge and numerous friends.

Surviving him are his most devoted and faithful wife, who was Miss Catherine O'Keefe of New Orleans, his son Harry J. Gilthorpe, superintendent Station "D" Post Office, New Orleans, La., and his daughters Mrs. Andrew L. Reiling of Kansas City, Kansas; Mrs. A. B. Campbell, Minden, La., and only sister, Mrs. Richards of San Antonio, Texas.

No tribute beyond the good moral life of Mr. Gilthorpe is necessary to keep his memory forever fresh in the hearts of those who knew him.

Poetical Selections.

MEDDLER'S ITCH.

I guess we are all of us knockers,
In a delicate way, to be sure;
And we meddle with other folks' business
In a way that is hard to endure.
There's Smith, down the street, bought an
auto,
A car to make any man glad.
Poor man, he's a salaried person,
And at once you can bet he's in bad.

Old Crocker, a rheumatic banker—
A tightwad for fifty good years,
Purses up his fat lips and expresses
His doubts and also his fears.
"These young men are gettin' too speedy,"
He declares to his trembling spouse,
"Look at Smith in that devilish auto!"
"I suppose he has mortgaged his house.

"And one of these days he'll be comin'
To me to afford him relief,
And I'll tell him, to my way of thinkin',
He's about on a par with a thief."
Miss Jane, a slim maiden lady,
With most of her years gone before,
At once takes a crack at the auto,
And finds it a thing to deplore.

She's sure the Smiths can't pay the grocer,
And it makes her withered heart bleed
To see the Smith boy going barefoot,
A victim to gasoline speed.
The Smith girl, a peachy young creature,
She knows can't afford a new hat,
And the old maid mumbles her false teeth,
And asks what you know about that.

As for Smith, he laughs, "I should worry,"
Take the missus and kids for a run,
And speeds them away to the country,
A load of real rollicking fun.
He's healthy, contented and happy,
And though he'll never be rich
Can afford to be sorry for neighbors
Afflicted with Meddler's Itch.

—A. M. Hopkins.

THE STUMBLER.

There is none so wise or great,
But has faltered in his gait,
Left the pathway that is straight,
And been humbled.
And in every great man's wake
There is many a mistake,
That his courage tried to shake
When he stumbled.
Just because you've lost one fight
Do not cease to seek the right,
Battle on with all your might,
Fame will crown you;
Yesterday is passed and gone,
Its mistakes don't dwell upon,
If you'll only struggle on,
They can't down you.

—Detroit Free Press.

THEY'VE GIVEN PA A RAISE.

Say, you ought to hear ma singin'—she's as
happy as a lark.
And her smile stays on from mornin' till a
long time after dark;
She's been buyin' rugs and gettin' a new
costly switch to wear,
And she takes a cab whenever she goes
callin' anywhere;
She has bought herself a dimund, and you
ought to see it blaze;
Ma's as cheerful as a robin—they have giver.
pa a raise.

Sister's busy gettin' dresses that'll cost an
awful pile,
And the hats that she's been buyin' are the
very latest style;
She's to go abroad this summer with people
named the Cooks;
Is she happy? Well, I guess so! You can
see it by her looks;
She goes hummin' songs and dancin' and in
forty thousand ways
Let's us know that she is cheerful since
they've given pa a raise.

Pa still works the same as ever and he's
smokin' stogies yet
Wears the suit he got last summer, and I
guess he's still in debt;
Anyhow he starts off early and comes home
fagged out at night,
And his forehead's gettin' wrinkled and his
hair is turnin' white;
Can't, somehow, help feelin' sorry as I sit
and watch him gaze
With a vacant look at nothin'. Yes, they've
given pa a raise.—S. E. Kiser.

ALL IS WELL.

And all is well, though faith and form
Be sundered in the night of fear;
Well roars the storm to those that hear
A deeper voice across the storm.

Oh, yet we trust that somehow good
Will be the final goal of ill,
To pangs of nature, sins of will,
Defects of doubt, and taints of blood;

That nothing walks with aimless feet;
That not one life shall be destroyed,
Or cast as rubbish to the void,
When God hath made the pile complete;

That not a worm is cloven in vain;
That not a moth with vain desire
Is shriveled in a fruitless fire,
Or but subserves another's gain.

Behold! we know not anything;
I can but trust that good shall fall
At last—far off—at last, to all,
And every winter change to spring.

—Tennyson (In Memoriam).

DON'T STOP AT THE STATION DESPAIR.

We must trust the conductor, most surely;
 Why, millions by millions before
 Have made this same journey securely
 And come to that ultimate shore.
 And we, we will reach it in season;
 And ah, what a welcome is there;
 Reflect then, how out of all reason
 To stop at the Station Despair.

Ay, midnights and many a potion
 Of bitter black water have we
 As we journey from ocean to ocean
 From sea unto ultimate sea,
 To the deep sea of seas, and all silence
 Of passion, scorn and care—
 That vast sea of Eden-set islands—
 Don't stop at the Station Despair!

Go forward, whatever may follow,
 Go forward, friend-led or alone;
 Ah me, to leap off in some hollow
 Or fen, in the night and unknown—
 Leap off like a thief—try to hide you
 From angels all waiting you there!
 Go forward, whatever betide you
 Don't stop at the Station Despair!
 —Joaquin Miller.

THE VERDICT.

Puck, a-sitting on the hill,
 Spied two lovers by the rill,
 Doing things that lovers do
 When their love is fond and true;
 Just a pressure of the hand,
 Flash of eyes—and you understand.
 Glancing toward the couple, he
 Cried: "What fools these mortals be!"

Later on he spied a pair—
 Strephon strong, and Phyllis fair;
 Deep affection in each heart,
 Yet their ways ran far apart!
 He'd no courage for the test,
 She deemed coldness for the best.
 Puck observed impatiently:
 "Oh, what fools these mortals be!"

I don't know what can be done
 For to please this jeering one,
 If we do, or if we don't;
 If we fail, or if we won't;
 Spite of how we play the game,
 Still the verdict is the same.
 Hard to such a fate to bow—
 Guess we're all fools, anyhow!
 —John Kendrick Bangs, in Aainslee's.

WHAT'S THE USE?

Weep and you're called a baby,
 Laugh and you're called a fool,
 Yield and you're called a coward,
 Stand and you're called a mule.
 Smile and they call you silly,
 Frown and they'll call you gruff;
 Put on a front like a millionaire,
 And some guy calls you bluff.
 —Stockton Review.

"IT CAN'T BE DONE."

The man who misses all the fun
 Is he who says, "It can't be done."
 In solemn pride he stands aloof
 And greets each venture with reproof.
 Had he the power, he'd efface
 The history of the human race;
 We'd have no steam nor trolley cars,
 No streets lit by electric stars;
 No telegraph nor telephone.
 We'd linger in the age of stone,
 Where when some keen barbaric brain
 Of life's conditions dared complain,
 And planned a wheel on which to roll
 That ever scoffs at what is new.
 The load his arms could not control,
 Sneers rose from all the mighty crew
 The world would sleep if things were run
 By men who say, "It can't be done!"
 —Selected.

Lost and Found**LOST DUE BOOK.**

The Due Book of Brother Wm. Griffin was lost in Jacksonville, Fla. The finder will please forward same to the writer.—Leonard Flohr, C. S. L. 425.

Lost Due Book—Ledergerber.

LOST—Due book belonging to Brother G. Ledergerber, helper, Reg. No. 94484. Finder please send same to John Roche, Secretary No. 363.

Lost Due Book—McIvers.

Lost due book belonging to Bro. Donald McIvers. Anyone finding same will confer a favor by returning it to the undersigned.

R. W. SMITH,
 C. S., L. 473.
 Cor. Sec. Lodge No. 473.

LIST OF MEMBERS PREVIOUSLY ADVERTISED

J. D. Landualt, Reg. No. 87363, left Teague, Tex., owing a grocery bill of thirty-nine dollars and ninety-five cents (\$39.95). He is wanted by Mrs. John Cure, Teague, Tex., who stood good for the amount.

T. D. Swain, Reg. No. 38826, by Lodge No. 567, for non-payment of a note of seventy-five dollars (\$75.00).

R. L. WHITE,
 Cor. Sec. Lodge No. 567.

H. E. or Earnest Robertson is wanted by Lodge No. 173, for failing to make good some money he borrowed.

J. P. TAYLOR,
 Lodge No. 173.

Earl Bennett, Reg. No. 75435, wanted by Lodge No. 100 for non-payment of bills amounting to \$67.65.

OFFICIAL ROSTER—International Officers

J. A. FRANKLIN.....International President
Room 15, Law Bldg., 721 Minnesota Ave., Kansas City, Kas.

F. P. REINEMEYER.....Int. Secretary-Treasurer
Rooms 10 to 12 Law Bldg., 721 Minnesota Ave., Kansas City, Kas.

JAMES B. CASEY.....Editor-Manager of Journal
Room 9, Law Bldg., Kansas City, Kas.

A. HINZMAN.....First Int. Vice-President
Room 15, Law Bldg., 721 Minnesota Ave., Kansas City, Kas.

MISSOURI AND MISSISSIPPI DISTRICT.
States of Iowa, Missouri, Kansas, Nebraska, Arkansas, Mississippi, Alabama (other than Mobile), Tennessee, North and South Dakota, Oklahoma and Minnesota.

THOS. NOLAN.....Second Int. Vice-President
700 Court St., Portsmouth, Va.

GULF AND SOUTH ATLANTIC DISTRICT.
States of Texas, Louisiana, Florida, Georgia, North and South Carolina, Virginia, Maryland and Delaware, and Mobile, Ala.

J. P. MERRIGAN.....Third Int. Vice-President
91 Manufacturer St., Montreal, Que., Can.

CANADIAN DISTRICT.
The Dominion of Canada.

LOUIS WEYAND.....Fourth Int. Vice-President
6201 Fir Avenue, N. W., Cleveland, Ohio.

GREAT LAKES AND TERRITORY DISTRICT.
States of Wisconsin, Michigan, Cities of Chicago, Toledo, Cleveland and Lorain, O., Erie, Pa., State of New York (other than the City of New York).

WM. ATKINSON.....Fifth Int. Vice-President
212 South Pittsburg St., Spokane, Wash.
ROCKY MOUNTAIN AND PACIFIC COAST DISTRICT.

Honolulu, States of California, Oregon, Washington, Idaho, Utah, Nevada, Montana, Wyoming, Colorado, Arizona, Old Mexico, New Mexico and Canal Zone, Panama.

JOHN J. DOWD.....Sixth Int. Vice-President
Home address, 168 Wilkinson Ave., Jersey City, N. J.

EASTERN SEABOARD DISTRICT.
States of Maine, New Hampshire, Vermont, Massachusetts, Rhode Island, Connecticut, New Jersey and New York City.

M. A. MAHER.....Seventh Int. Vice-President
1401 Center St., Portsmouth, Ohio.

OHIO VALLEY AND TERRITORY DISTRICT.
States of Pennsylvania (other than the city of Erie), Ohio, West Virginia, Kentucky, Indiana and Illinois (other than the City of Chicago).

JOS. P. RYAN.....Eighth Int. Vice-President
5830 Wentworth Ave., Chicago, Ill.
Phone, Wentworth 8739.

HELPERS' VICE-PRESIDENT OF WESTERN DIVISION.
All states west of dividing line between Indiana and Ohio.

JOHN F. SCHMITT.....Ninth Int. Vice-President
1489 N. Fourth St., Columbus, Ohio.

HELPERS' VICE-PRESIDENT OF EASTERN DIVISION.
All states east of dividing line between Indiana and Ohio.

District Lodges and Officers

DISTRICT No. 2—New York, N. Y. Meets 1st and 3rd Wed. Patrick T. Kenneally, President, 9 Magnolia Ave., Jersey City, N. J.

Wm. Brown, Vice-Pres., Elizabeth Ave., Elizabeth, N. J.

Gerald A. Daly, Sec.-Treas., 676 60th St., Brooklyn, N. Y.

DISTRICT No. 5—St. Louis, Mo. Mo. Pac. and Iron Mountain R. R. Lodges represented: 32, 38, 44, 66, 82, 106, 113, 117, 286, 322, 403, 507, 521, 542, 543, 565, 583 and 599.

John C. Morrow, Pres., 613 W. 4th St., Coffeyville, Kans.

Hal. Stack, Vice-Pres., Van Buren, Ark.

John J. Murphy, Secy., 3404 Eads Ave., St. Louis, Mo.

J. N. Shirley, Treas., Box 495, Hoisington, Kans.

A. E. Stewart, Member Ex. Board, 2533 Myrtle Ave., Kansas City, Mo.

A. J. Radford, Member Ex. Board, 624 Oak St., Little Rock, Ark.

Chas. A. McDonald, B. A., 4414 Winsor St., Kansas City, Mo.

DISTRICT No. 6—Southern Pacific R.R. Lodges represented: 32, 33, 46, 48, 52, 74, 92, 49, 98, 101, 113, 179, 193, 206, 216, 223, 239, 252, 309, 345, 339, 538, 553, 169.

J. J. Jones, Pres. and C. S., 1630 New Hampshire Ave., Los Angeles, Cal.

J. C. Carroll, V.-P., North Platte, Neb.

S. T. Feazelle, Sec.-Treas., Gate City Hotel, Pocatello, Idaho.

DISTRICT No. 10—Davenport, Ia. Rock Island System. Lodges represented: 377, 144, 346, 199, 340, 293, 323, 434, 439, 491, 96, 32, 66, 476, 522, 523.

Geo. W. Pring, Pres. & B. A., 677 38th St., Des Moines, Ia.

John Mitchell, V.-P., 1502 McGowan St., Little Rock, Ark.

S. T. Sample, C. & F. S., 515 N. Jackson St., Pratt, Kas.

J. J. Lynch, Treas., Box 655, Herington, Kas.

DISTRICT No. 12—New York Central System. Lodges represented: 5, 7, 10, 64, 67, 85, 150, 157, 169, 175, 197, 218, 223, 229, 321, 413, 492.

A. M. Anderson, Pres., 2208 Francis St., Jackson, Mich.

G. H. Gates, Vice-Pres., 148 N. Orchard St., Watertown, N. Y.

J. J. Leamy, Sec.-Treas., 68 Livingston Ave., Albany, N. Y.

Trustees—Wm. Weber, E. J. McNamara and Thomas Ranger.

DISTRICT No. 13—Birmingham, Ala. Southern R. R. System.

Organized Feb. 23, 1904. Lodges represented: 2, 4, 12, 14, 40, 50, 28, 105, 143, 170, 226, 235, 312, 320, 334, 344, 369, 419, 511, 524; H. D., 27, 111, 175, 240.

Thos. J. Garvey, Pres., 414 E. Byrd St., Richmond, Va.

A. E. Barksdale, V.-P., 543 E. Lafayette St., Jackson, Tenn.

P. E. Berney, Sec.-Treas., R. F. D. 12, Knoxville, Tenn.

DISTRICT No. 15—Chicago, Ill. C. & N. W. R. R. Lodges represented: 38, 60, 129, 145, 161, 201, 227, 311, 395, 440, 485, 496, 539, 597.

W. F. Scholes, Pres., 1929 Ave. B., Council Bluffs, Ia.

J. W. Francis, V.-P., 534 Springfield Ave., Chicago, Ill.

T. E. Burdette, Sec.-Treas., 428 North Chesnut Ave., Green Bay, Wis.

DISTRICT No. 19—Roanoke, Va. Norfolk & Western System.

Lodges represented: 28, 402, 30, 405, 557. Meets Union Labor Hall.

C. D. Craft, Pres., 1402 Center St., Portsmouth, O.

M. F. Glenn, V.-P., 1414 McConnell Ave., Portsmouth, Ohio.

J. B. O'Brien, Treas., Roanoke, Va.

E. J. Horgan, C. & F. S., 404 7th Ave., S. E., Roanoke, Va.

DISTRICT No. 20—Ill. Cent. R. R. Headquarters, Chicago, Ill.

Lodges represented: 56, 88, 133, 137, 40, 224, 426, 180, 220, 234, 300, 315, 363, 399, 95; H. D., 97, 106, 116, 102, 230, 174, 232, 223.

K. H. Elcker, Pres., 315 Dane St., Waterloo, Ia.

W. T. McCoid, V. P., 412 Madison St., Clinton, Ill.

E. G. Pullen, C. S. & Treas., 303 Columbia St., Waterloo, Ia.

DISTRICT No. 22—D. R. G. System, Colorado and Utah. Meeting place, Denver, Colorado; Date meeting, 2d Monday in July, 1915; Lodges represented: 44, 103, 179, 335, 427, 446, 473.

Geo. S. Warden, Pres. & B. A., 1507 E. 7th St., Pueblo, Colo.

H. F. Jones, Vice-Pres., 135 Sackett Ave., Salida, Colo.

A. A. Duncan, Sec.-Treas., Box 611, Alamosa, Colo.

DISTRICT No. 23—Meets at St. Louis, Mo., 3d Monday in October, 1914. Lodges represented: 4, 22, 27, 70, 95, 96, 190, 286, 418, 449, 458, 530, 531, 543, 546, 565, 575.

A. F. Bingham, Pres. and B. A., 701 Lombart St., Springfield, Mo.

L. W. Lawson, V.-P., 821 N. Maxey St., Sherman, Texas.

J. W. Reddick, Financial and Recording Secretary, 817 Lincoln St., Springfield, Mo.

A. A. Denton, Cor. Sec. and Treas., 1044 W. Mt. Vernon St., Springfield, Mo.

DISTRICT No. 24—Springfield, Ill. Advisory Board Wabash System. Lodges represented: 54, 81, 267, 384, 447, 581.

E. R. Lee, Pres., 324 Taylor St., Moberly, Mo.

James Gray, V.-P., L. No. 447.

Gus L. Kloes, Sec., Box 214, Montpelier, Ohio.

DISTRICT No. 25—Livingston, Mont. Northern Pac. R. R.

J. G. Brown, Pres., 610 N. 9th St., Brainerd, Minn.

Frank Depender, V.-P., 735 E. Nora Ave., Spokane, Wash.

Theo. W. Everett, Sec.-Treas., P. O. Box 554, Livingston, Mont.

- Trustees—A. H. Shanks, 221 N. 2nd St., Missoula, Mont.; Hugh Roberts, Gen. Del., Glendive, Mont.; G. M. Owens, 312 So. E. St., Livingston, Mont.
- DISTRICT No. 26**—Aberden, S. D. C. M. & St. P. and Puget Sound R. Ra. Lodges represented: 11, 15, 32, 38, 41, 104, 244, 302, 485, 520, 528, 568, 588, 595, 603, 606. G. H. Hawksworth, Pres., Box 817, Deer Lodge, Mont.
- F. J. O'Brien, Vice-Pres., Avery, Idaho.
- Ed. McSperritt, Secy., Gen. Del., Miles City, Mont.
- P. W. Gunn, Treas., 3316-30 Ave., South, Minneapolis, Minn.
- J. L. Callahan, B. A., 3606 Clifton St., Milwaukee, Wis.
- DISTRICT No. 27**—Int. G. N. R. R. W. O. Faulk, Pres., Palestine, Tex.
- W. K. Saddler, Vice-Pres., Mart, Texas.
- E. H. Frick, Sec.-Treas., San Antonio, Tex.
- W. E. Graham, B. A., Palestine, Tex.
- DISTRICT No. 30**—Canadian Pacific. District Headquarters, Winnipeg, Man. Lodges in affiliation: 126, 134, 194, 379, 392, 451, 466, 478, 505, 529, 548, 417. Geo. F. Chadburn, Pres. and Acting Sec.-Treas., 1685 Alexander St., Winnipeg, Man.
- J. B. Smith, V.-P., 162 Annette St., Toronto, Ont.
- R. Caraway, V.-P., 684 Home St., Winnipeg, Man.
- DISTRICT No. 31**—Cincinnati, O. B. & O. System. Lodges represented: 5, 10, 79, 99, 105, 135, 241, 259, 318, 326, 332, 444, 493, 498, 514, 579, 578.
- H. D. Horchler, Pres., 717 Blane St., Newcastle, Pa.
- John Sweeney, B. A., 3339 N. 5th St., Philadelphia, Pa.
- John P. Mangen, Sec.-Treas., 612 S. W. 1st, Washington, Ind.
- DISTRICT No. 32**—Grand Rapids, Mich., Pere Marquette System. Lodges represented: 34, 124, 413.
- DISTRICT No. 34**—Boston, Mass. Boston & Maine System. Lodges represented: 245, 371, 388, 431, 515, 517. Meets at Boston, Mass., 1st Monday in August and 2d Monday in February.
- W. H. Wells, Pres., 108 Westford St., Lowell, Mass.
- P. J. Kelley, Vice-Pres., 3 Devon St., Greenfield, Mass.
- T. J. Donahue, Sec.-Treas., 5 Fernald St., Lowell, Mass.
- DISTRICT No. 35**—Parsons, Kas. M., K. & T. R. R. System. Lodges represented: 292, 209, 501, 576 and 265.
- Fred Alsdorf, Pres. & B. A., 515 W. Owings St., Denison, Tex.
- C. Dudding, V.-Pres., 2229 Crawford St., Parsons, Kas.
- Robt. Rosbottom, Sec.-Treas., 600 W. Texas St., Denison, Tex.
- C. A. Denton, Rec. Sec., Parsons, Kas.
- Wm. Dickerson, Chairman Trustees, 810 Cleveland St., Waco, Tex.
- DISTRICT No. 37**—Texarkana, Tex. Cotton Belt R. R. System. Meets 3d Saturdays in January and July.
- R. M. Cummins, Pres. & B. A., 308 E. Valentine St., Tyler, Tex.
- John A. Smith, V.-P., 1908 E. 8th St., Pine Bluff, Ark.
- B. E. Shields, Sec.-Treas., 1503 E. 7th Ave., Pine Bluff, Ark.
- DISTRICT No. 38**—Atlantic Coast Line. Lodges represented: 20, 26, 239, 422, 425, 448, 570.
- A. J. Dixon, Pres., Rocky Mount, N. C.
- W. A. Cahill, Vice-Pres., Montgomery, Ala.
- E. S. Ryan, Sec.-Treas., 508 Lackawana Ave., Jacksonville, Fla.
- DISTRICT No. 39**—Central of Georgia System. Meets 1st Friday after Thanksgiving each year at Columbus, Ga. Lodges represented: 4, 12, 26, 436, 510.
- R. J. Black, Pres., 913 2nd St., Macon, Ga.
- J. J. Dean, Vice-Pres., 226 Taylor St., Savannah, Ga.
- Chas. A. Buchheil, Sec.-Treas., 103 Gordon W., Savannah, Ga.
- E. M. Kendrick, Rec. Sec., Route 5, Cedartown, Ga.
- R. S. Barry, Cor. and Fin. Sec., 1109 5th Ave., Columbus, Ga.
- DISTRICT No. 40**—Hamlet, N. C. Seaboard Airline and leased lines. Lodges represented: 2, 20, 29, 298.
- B. M. Jewell, Sec.-Treas., 421½ Forest St., Jacksonville, Fla.
- DISTRICT No. 41**—Hinton, W. Va. Chesapeake & Ohio System. Lodges represented: 170, 238, 249, 364, 384, 525.
- David W. Morris, Pres., Forest Park, Peru, Ind.
- R. L. King, V.-Pres., 807 N. 24th St., Richmond, Va.
- C. L. Barnett, Sec.-Treas., 207 2d Ave., Hinton, W. Va.
- Trustees—M. L. Steinbuck, Box 336, Clifton Forge, Va. D. C. Dowdy, 2048 7th Ave., Huntington, W. Va. John J. Fielding, 1389 Scott St., Covington, Ky.
- DISTRICT No. 42**—Danville, Ill. Chicago & Eastern Illinois R. R. Meets 1st Tues. in Feb., 1916. Lodges represented: 22, 95, 575.
- G. D. Davis, Pres. and B. A., 18 N. Hazel St., Danville, Ill.
- James B. Keenan, V.-P., 1006 E. Madison St., Danville, Ill.
- Office: Henthorn, R. & F. S., 102 Iowa St., Danville, Ill.
- A. Welch, Cor. Sec. & Treas., Villa Grove, Ill.

Subordinate Lodges and Officers

- 1—CHICAGO, ILL.** 2d-4th Wed., Bricklayers' Hall, Monroe and Peoria Sts.
- James McKiernan, Pres.
- John E. Burke, C. & F. S., 3009 Archer Ave.
- John Dohney, 8123 So. Peoria.
- Frank Condon, B. A., 912 Monroe.
- 2—ATLANTA, GA.** 2d-4th Thurs
- A. D. Lundbon, Pres., 224 E. Fair.
- John Fitcher, C. S., 406 Pullman.
- 3—ST. PAUL, MINN.** 2d-4th Fri., Odd Fellows' Hall, 5th and Wabash Sts.
- Pat Walsh, Pres., 849 Western.
- W. Parranto, C. S., 400 Jenks St.
- 4—BIRMINGHAM, ALA.** Each Tues. K. of C. Hall.
- G. F. Williams, Pres., 2708 Alabama Ave.
- A. L. Carmack, F. S. & B. A., Office: 335 Hood Bldg.
- 5—CLEVELAND, OHIO.** 1st-3d Thurs., Room 3, Federation Hall, 310 Prospect.
- John Spears, Pres., 1065 E. 69th.
- G. H. Brady, C. S. & B. A., 1182 E. 118th St.
- 6—COLUMBUS, O.** Meets 2d-4th Thurs., F. of L. Hall.
- Chas. L. Nicklaus, Pres., 473 Popular Ave.
- Fred Dennis, C. S. 628 Mt. Vernon Ave.
- 10—INDIANAPOLIS, IND.** 2d-4th Thurs., 114 N. Delaware.
- E. P. Leopard, Pres., 206 N. Tremont Ave.
- Wm. Frohlinger, C. S., 542 East Louisiana St.
- L. E. Himsch, F. S., 851 Ashland Ave.
- 11—MINNEAPOLIS, MINN.** 2d-4th Mon., Richmond Hall, 223 5th St.
- Joseph Kovichumel, Pres., 89 Summit Ave. St. Paul, Minn.
- E. A. Conlin, C. S., 2404 Bloomington Ave.
- 12—MACON, GA.** 2d-4th Friday, Morgan's Hall, cor. Elm and Broadway.
- J. T. Fenlon, Pres., 1974 Third St.
- C. T. Williamson, C. & F. S., 2554 Houston Ave.
- 14—CHATTANOOGA, TENN.** Central Labor Hall, 8th and Cherrle Sts., 2d-4th Mon.
- Sam Hartman, Pres., North Chattanooga, Tenn.
- J. F. Anderson, Secy-Treas., 505 Read Ave.
- 15—DUBUQUE, IOWA.** 1st-3d Tues., Union Hall, 19th and White Sts.
- E. Keck, Pres., 1272 Lincoln Ave.
- R. Rouf, C. & F. S., 975 Clay St.
- 16—JERSEY CITY, N. J.** 1st-3d Mon., Fischer's Hall, Newark Ave., cor. Erie St.
- Patrick J. Kenneally, Pres., 209 Magnolia Ave.
- Hugh Fitzpatrick, C. S., 244 York.
- Ed. McCarthy, B. A.
- 19—PHILADELPHIA, PA.** 2d-4th Fridays, Bricklayers' Hall, Broad and Fairmount Ave.
- Frank Goodfellow, Pres., 159 W. Palmer St.
- George Higgs, C. S., 2024 Bouvier
- 20—JACKSONVILLE, FLA.** Meets every Monday, Central Labor Hall, 46½ W. Bay.
- E. A. Clarke, Pres.
- E. S. Ryan, C. & F. S., 508 Lackawana Ave.
- 21—NEW YORK, N. Y.** 2d-4th Tuesdays.
- John H. Sullivan, Pres., 607 W. 46th St.
- James McGeney, C. S., 352 Schermerhorn St., Brooklyn, N. Y.
- Thomas Broadley, F. S., 519 W. 42d St.
- 22—DANVILLE, ILL.** 1st-3d Mon., Trades and Labor Hall.
- Ray Schenk, Pres., California St.
- Wm. J. Irwin, C. S., 7 Illinois.
- Frank Jergens, F. S., 418 N. Bowman Ave.
- G. D. Davis, B. A., 18 N. Hazel.
- 25—SAN FRANCISCO, CALIF.** Roesch Hall, 15th and Mission Sts., 2d-4th Thurs.
- John Kane, Pres., 41 Collingwood.
- Thos. J. Sheridan, C. S. & Treas., 2312 24th St.
- Wm. P. Bowser, B. A., 314 14th.
- 26—SAVANNAH, GA.** 2d-4th Tues., Board of Trade Bldg.
- J. P. Masey, Pres.
- R. B. Allen, C. S., 509 E. 32d St.
- 27—ST. LOUIS, MO.** 2d-4th Thurs., 10th and Carr.
- Larry Kickham, Pres. & B. A., 5322 Vernon Ave.
- James Callahan, C. S., 3408 Laclede Ave.
- Henry Selkman, F. S., 1942 Benton.

- 29—ROANOKE, VA.** 2d-4th Wed., Labor Home Hall, Commerce and Salem Ave.
G. J. Lucas, Pres., 1121 2d Ave. N. W.
- 30—ROANOKE, VA.** 2d-4th Mon., Labor Hall, cor. Commerce St. and Salem Ave.
C. E. Eades, Pres., 318 7th Ave. N. E.
- 31—ST. JOSEPH, MO.** 2d-4th Mon., Joucker Hall.
B. E. Stitts, Pres., 2228 So. 6th. Edward Knight, C. S., 2119 So. 9th St.
- 32—KANSAS CITY, MO.** 2d-4th Fri., Labor Temple, 14th and Woodland.
Thomas Mulvihill, Pres., 3715 Springfield St., Rosedale, Kas.
W. E. Dwyer, C. & F. S., 4402 Windsor.
Chas. A. McDonald, B. A., 4414 Windsor.
- 37—NEW ORLEANS LA.** 2d-4th Wed., Martin's Hall, Iberville & Exchange Place.
Wm. J. Smith, Pres., 228 Morgan St., Algiers, La.
Lewis J. Costella, C. S. & B. A., 636 N. Olympia.
Victor Escaussac, F. S., 617 Alix St., Algiers, La.
- 38—OMAHA, NEB.** 1st-3d Wed., Balright Hall, 19th & Farnum.
M. J. McGovern, Pres., 1617 Burt. L. G. Rankin, C. S., 2825 Cass.
J. H. Massman, F. S., 1511 Locust.
- 39—SOUTH CHICAGO, ILL.** 2d-4th Tues., Union Headquarters, 92d St. and Erie Ave., South Chicago.
Frank Bacton, Pres., 10149 Ave. J. John Cogan, C. S. & B. A., 9944 Ave. H.
- 40—LOUISVILLE, KY.** 2d-4th Wed., in Beck's Union Hall, 1st and Jefferson Sts.
Thomas Mitchell, Pres., 1422A Broadway.
R. Terrell, C. S., 308 N. 19th St.
- 41—HARLOWTON, MONT.** 2d-4th Thurs., Winer Hall.
John Dennis, Pres.
Harry Schultz, C. & F. S.
- 42—NASHVILLE, TENN.** 2d-4th Thurs., Carpenters' Hall, 342½ 4th Ave. N.
James B. Keenan, 1006 E. Madison St., Danville, Ill.
H. R. Brown, Pres., 611½ Church. W. T. Pentecost, C. S., 2143 Oakland Ave.
- 44—PUEBLO, COL.** Every Thurs., Carpenters' Hall, 117½ S. Union Ave.
Walter M. Pitts, Pres., 653 E. 5th St.
Geo. S. Warden, C. & F. S., 1507 E. 7th St.
- 45—BROOKLYN, N. Y.** Greenpoint and Manhattan Aves., 2d-4th Thurs.
Gerald A. Daly, Pres. & C. S., 676 60th St.
M. J. Callahan, F. S., 204 Nassau Ave.
- 46—CHEYENNE, WYO.** Union Hall, 2d-4th Wed.
Geo. R. Wallace, Pres., P. O. Box 151.
E. Cole, C. S., 215 E. 9th St.
- 47—DES MOINES, IA.** 1st-3d Thurs., Trades Assembly Hall.
James Gillespie, Pres., 1113 Columbus Ave.
Fritz Johnson, C. & F. S., 922 W. 1st St.
- 48—LARAMIE, WYO.** 1st-3d Tues., Moose Hall.
Jacob Claus, Pres., 114 Cedar St.
Frank M. Lepper, C. S., 360 N. 3d St.
- 50—CHARLESTON, S. C.** 1st-3d Tues., Y. M. C. A. Hall, George St.
H. J. Hartnett, Pres., 18 Anson St.
John J. Clair, C. & F. S., 196A Spring St.
- 51—ST. LOUIS, MO.** 2d-4th Wed., Lafayette Hall, 17th and Cass Ave.
Wm. Hass, Pres., 1846A Cass Ave.
M. J. Gleason, B. A., Office 1101 Cass Ave.
Harry Lueper, C. S., 3234 Itaska.
- 54—FORT WAYNE, IND.** Last Wed., West Berry St.
Edward F. Siebold, Pres. & C. S., 1130 St. Mary's Ave.
O. P. Ewald, F. S., 1419 S. Calhoun.
- 55—NEWPORT NEWS, VA.** Every Wed., 8 p. m., C. L. U. Hall, 32d and Wash. Ave.
Wm. H. Healy, Pres., 3714 Huntington Ave.
Thos. J. Richards, C. S., P. O. Box 430.
- 56—VICKSBURG, MISS.** 1st-3d Tues., K. of P. Hall, N. Washington St.
Ed. Snelling, Pres., 3127 Washington St.
W. C. Hughes, C. & F. S., 2312 Mulberry.
- 57—PORTSMOUTH, VA.** 1st-3d Thurs., C. L. U. Hall.
Elmer Johnkin, Pres.
Geo. Thomas, C. S., 204 Lincoln.
- 60—PEORIA, ILL.** 1st-3d Mon., 411 Cedar St.
Andy Yates, Pres., 1709 S. Adams.
F. Hierspiel, C. S., 410 Warner Ave.
- 61—NEW HAVEN, CONN.** 1st-3d Thurs., Boardman Bldg., cor. State and Chapel Sts.
Eric R. Swan, Pres., 192 Clinton Ave.
M. J. Whalen, C. S., 138 Carlisle.
- 64—JACKSON, MICH.** Every Tues., Labor Hall, Main and Jackson Sts.
Geo. Bones, Pres., 140 Bates.
Ed McNamara, C. S., 619 South Pleasant St.
- 65—VICTORIA, VA.** 2d-4th Sundays, Lunenburg Hall.
J. H. Jones, Pres. & Treas., Gen. Del.
F. C. Kimmerling, Vice-Pres., Gen. Del.
H. S. Bacon, Rec. Sec., Gen. Del.
E. M. Widdle, C. & F. S., Gen. Del.
- 66—LITTLE ROCK, ARK.** 1st-3d Thurs., Moose Hall.
Thomas Norton, Pres., 1009 Markham St.
E. Wortsmith, C. & F. S., 300 W. 11th St., Argenta, Ark.
Chas. A. McDonald, B. A., 4414 Windsor, Kansas City, Mo.
- 67—BAY CITY, MICH.** 1st-3d Thurs., Central Trades Council Hall.
Wm. H. Benedict, Pres., 703 E. Winona Ave., W. S.
Joe Malton, V.-P., 317 S. Jackson.
Nelson Heglung, C. & F. S., 514 Adams St.
- 68—PINE BLUFF, ARK.**—2d-4th Wed., Labor Temple.
A. J. Barton, Pres., 1701 W. 6th.
B. E. Shields, F. S., 1503 E. 7th.
J. A. Smith, C. S., 1908 E. 8th.
- 70—SPRINGFIELD, MO.** 2d-4th Wed., Eagles' Hall, E. Commercial St.
R. A. Lines, Pres., 816 W. Atlantic St.
Scott Daffer, C. & F. S., 987 Broad St.
A. F. Ringham, B. A., 701 Lombard St.
- 72—PORTLAND, ORE.** 2d-4th Thurs., Cor. 2d and Yamhill Sts.
Frank Poehler, Pres., 654 E. 25th.
F. E. Disbrow, C. & F. S., 810 E. 11th.
Joe Reed, B. A., 742 E. 8th.
- 73—TROY, N. Y.** 2d-4th Mon., Swan and Georgia Sts., Mechanics' Hall.
Huntington Ave.
A. C. Lacy, C. S., 552 27th St.
James Keating, Pres.
David Boyd, C. S., 319 9th St., Watervliet.
- 74—HOUSTON, TEXAS.** 1st-3d Wed., Woodman Hall, 1823 Washington St.
D. C. Bryan, Pres., 4607 Washington.
F. C. Jackson, C. & F. S., 2118 Lubbock St.
- 75—ARRETT, IND.** 1st-3d Tues., K. of P. Hall, Randolph.
Geo. Richmond, Pres., 214 E. Keyser.
- J. C. Smith, C. & F. S., Box 282.
- 80—ANACONDA, MONT.** 2d-4th Wed., M. & M. Hall, Lodge Box 372.
J. C. Smith, Pres., 510 Cherry St.
James W. Hogan, C. S., 800 Birch.
- 81—SPRINGFIELD, ILL.** 2d-4th Tues., Fortunes Hall.
Ed Sellers, Pres., 130 E. Edwards.
Louis L. Mutter, C. & F. S., 1621 S. 8th.
- 82—OSAWATOMIE, KAS.** 1st-3d Mon., K. & L. Sec. Hall.
M. F. Churchill, Pres.
J. E. Sturges, C. & F. S., Box 64.
- 83—KANSAS CITY, KAS.** 2d-4th Tues., K. P. Hall, 624 Minn. Av.
Thomas Knowles, Pres., 760 Shawnee.
Frank Stover, C. & F. S., 322 Nebraska Ave.
- 84—GRAND RAPIDS, MICH.** 1st-2d Mon., Trade & Labor Hall, 67 Monroe Ave.
Frank C. Lemke, Pres., 551 Shamrock St.
Nelson M. Warren, C. S., 127 E. Delaware St.
- 85—TOLEDO, OHIO.** 2d-4th Tues., Mitchell's Hall, cor. Walnut and Summit Sts.
J. S. Durst, Pres., 153 Gibbons St.
Ellsworth Richardson, C. S., 1137 Western St.
- 86—DALLAS, TEX.** 1st-3d Mon., Broadnax Hall.
W. H. Riley, Pres., 1408 Corinth.
F. B. Foote, Cor. Sec., 2817 Howell St.
- 88—JACKSON TENN.** 2d-4th Fri., Labor Hall.
B. B. Seward, Pres.
A. E. Barkdale, C. S., 119 E. Orleans St.
- 90—SUGAR CREEK, MO.** 2d-4th Thurs., Woodman's Hall.
L. Novak, Pres.
C. R. Snider, C. & F. S., 1222 W. Electric St., Independence, Mo.
- 91—ELMWOOD PLACE O.** 1st-3d Mon., Kellers Hall.
Geo. Urban, Pres., St. Bernard, O.
John Cullen, C. S., 39 Prosser Ave.
- 92—LOS ANGELES, CAL.** 2d-4th Wed., Union Labor Temple, 540 Maple Ave.
Charles Clarke, Pres., 206 S. Workman St.
H. E. Herman, C. & F. S., 520 S. Griffin Ave.
- 93—JOLIET, ILL.** 1st-3d Tues., Conner's Hall.
Charles Brown, Pres., Gen. Del., Lockport, Ill.
Charles Mork, C. S., 424 Landen Ave.
- 94—SACRAMENTO, CAL.** 1st-3d Thurs., Labor Temple.
J. Grabfelder, Pres., 3001 G St.
J. S. Heller, Acting C. S., 19th St.
- 95—EVANSVILLE, IND.** 3d-4th Mon., Ruhf's Hall.
Frank Hahn, Pres., 1319 Law Ave.
Herman H. Grundman, C. S., 807 Mary St.

- 96—FORT WORTH, TEX.** B. of L. F. & E. Hall, 1st-3d Thurs. Geo. E. Challor, Pres., 951 Jefferson Ave.
L. A. Freeman, C. & F. S., 2250 Jennings St.
- 99—NEWARK, OHIO.** Druid's Hall, S. 3d St., 1st-3d Sun. Emil Indelekoper, Pres., 68 Curtis Ave.
Cicli Roberts, C. & F. S., 45 1/2 S. Third St.
- 100—MARSHALL, TEX.** 1st-3d Tues., I. O. O. F. Hall. Smith Hayden, Pres., 514 Greenwood Ave.
J. P. O'Neil, C. & F. S., 708 E. Rusk.
- 103—SALT LAKE CITY, UTAH.** Labor Temple, 3d East, bet. 1st and 2d S. St., 1st-3d Wed.
Ernest L. Wilcox, Pres., 520 Mortison Court.
B. S. R. Harrison, C. & F. S., 862 Ouray Ave.
- 104—SEATTLE, WASH.** 1st-3d Thurs., Labor Temple, 6th and University St.
Wm. G. Cooper, Pres., 1820 Jackson St.
Dan McKillop, C. & F. S., 166 1/2 10th Ave.
- 106—CINCINNATI, OHIO.** 2d-4th Tues., Workman's Hall, Mercer and Walnut Sts.
Chas. Granger, Pres., 329 Union St., Belleview, Ky.
D. L. O'Brien, C. S. & B. A., 23 Forest Ave., Ludlow, Ky.
Frank Bareswilt, F. S., 1028 5th Ave., Dayton, Ky.
- 106—McGHEE, ARK.** 2d-4th Wed., K. of P. Hall.
Wm. E. Crupper, Pres., Box 215.
Chas. A. Stewart, C. & F. S., Box 432.
- 107—MILWAUKEE, WIS.** 1st-3d Tues., Speers Hall, Cor. National & 3d Ave.
J. Hoppens, Pres., 1302 Fratney.
R. Dale, Fin. Sec., 319 4th Ave.
P. Sonnenberg, C. S. & B. A., 623 Greenbush.
- 108—AUGUSTA, GA.** 2d-4th Tues., Machinists' Hall, Broad.
Patrick Rice, Pres. & C. S., 1342 Walton Way.
- 109—CHADRON, NEB.**
J. W. Boyd, Pres.
John Paulson, C. & F. S.
- 111—MISSOULA, MONT.** 2d-4th Tues., Eagles' Hall.
H. A. Chase, Pres., Box 1304.
E. H. Shanks, C. & F. S., 221 N. 2nd.
- 113—SEDALIA, MO.** 1st-3d Tues., Labor Temple.
J. C. White, Pres., 817 E. 5th St.
W. H. Sims, C. S., 1306 E. 7th St.
- 116—BRAINERD, MINN.** 2d-4th Fri.
J. L. Ellis, Pres.
L. A. Riftenrath, C. S., Mahlum Block.
- 117—DE SOTO, MO.** 1st-3d Mon., Federation Hall.
R. B. Parks, Pres.
S. L. Johnson, C. & F. S., Box 248.
- 118—NORTH PLATTE, NEB.** 4th Sat., K. of P. Hall.
John Seth, Pres.
Peter McGovern, C. S., 511 Locust.
- 123—LIVINGSTON, MONT.** 1st-3d Thurs., Trades and Labor Hall.
C. D. Caln, Pres., 204 S. K St.
Theo. W. Everet, C. & F. S., P. O. Box 554.
- 124—SAGINAW, MICH.** 1st-3d Fri., Petre & Meek's Hall, Genesee Ave.
John Doyle, C. & F. S., R. F. D. No. 1.
- 126—WINNIPEG, MAN.** 1st Wed. and 2d Sun., 2 o'clock, Labor Temple.
Charles Davies, Pres., 514 Atlantic Ave.
A. E. Page, C. S., 1330 Elgin Ave.
- 129—CLINTON, IOWA.**
H. Qualman, C. S., 231 14th Ave.
- 130—BUTTE, MONT.** 1st-3d Tues., Carpenters' Hall, cor. Granite and Montana Sts.
G. C. Wright, Pres., 1007 S. Arizona St.
W. H. Goodland, C. S., 177 E. Center.
- 132—GALVESTON, TEX.** 2d Mon., Cooks and Waiters' Hall, 23d St.
S. Nawdascher, Pres., 3328 Ave. H.
E. T. Chester, C. & F. S., 3209 Ave. I.
- 133—WATERLOO, IOWA.** Central Labor Hall, 2d-4th Wed.
E. G. Pullen, Pres., 502 Columbia St.
Geo. A. McMillan, C. S., 702 Barclay St.
- 134—MONTREAL, QUE., CAN.** 1st-3d Fri., Monument National St. Lawrence and Main Sts.
Stephen Craig, Pres., 1251 Mosier.
R. Chorlton, C. S., 1184 Delormier Ave.
- 135—CHILLICOTHE, O.** 1st-3d Mon., Flaecker Hall.
Edward Carroll, Pres., 739 Adams Ave.
James Hunsinger, C. & F. S., 390 E. 4th St.
- 136—COLORADO CITY, COLO.** Red Men's Hall, 1st-3d Fri.
H. J. Norton, Pres., 231 Lincoln Ave.
R. D. Wing, C. S., 12 So. 12th, Colorado Springs, Colo.
J. H. Cook, F. S., 216 N. 12th.
- 137—PADUCAH, KY.** 2d-4th Sun., Central Labor Hall, 122 1/2 N. 4th.
B. C. Beadles, Pres., 1029 Madison.
- Wm. Black, C. & F. S., 315 N. 3d St.**
- 138—HARRISON, ARK.**
H. C. Heppard, Pres.
T. T. Chubb, C. S.
- 140—PEN ARGYL, PA.** 2d-4th Mon., Steinmiltz's Hall, Bangor, Pa.
Joseph Wenninger, Pres. & C. S., care Realty.
J. A. Morgan, Fin. Sec., care Albion House.
- 143—KNOXVILLE, TENN.** 319 N. Gay St., 1st-3d Tues.
J. D. Krause, Pres., R. F. D. No. 1.
J. C. Wells, C. S., 508 E. 4th Ave.
W. D. Amames, F. S., R. F. D. No. 12, Lincoln Park.
- 144—CEDAR RAPIDS, IOWA.** 1st-3d Wed., I. O. O. F. Hall, cor. 1st St. and 2nd Ave. W.
Chas. T. Bowman, Pres., 816 Ellis Blvd.
Gus Liepold, C. & F. S., 605 I Ave. West.
- 145—MISSOURI VALLEY, IOWA.** 1st-3d Thurs., Walker's Hall.
Hans Witt, Pres., Box 181.
Harvey Nichols, C. S.
- 148—VALEJO, CALIF.** 1st-3d Fri., Labor Temple.
Wm. Fountain, Pres., 225A Pennsylvania.
Wm. Kelly, C. S., 1008 York St.
- 149—MARSHALLTOWN, IOWA.** 1st-3d Tues., Trades and Labor Assembly Hall, Main St.
Chas. Vyskocil, Pres., 9 E. Boone.
W. E. Pouley, C. S., 1110 W. Cole.
- 150—CHAMPAIGN, ILL.** 1st-3d Sun., 2:30 p. m., I. C. System Fed. Hall.
Thos. H. Monahan, Pres., 511 W. Washington St.
A. E. Strode, C. S., 325 Hickory.
- 153—GASSAWAY, W. VA.**
J. E. Perkins, Pres., Gen. Del.
R. Lee Boone, C. & F. S., Gen. Del.
- 154—PITTSBURGH, PA.** 1st-3d Fri., Labor Temple, cor. Washington and Webster Ave.
Frank Bann, Pres., 804 South Ave. N. S.
- Henry J. Thumel, C. & F. S., 1218 Iin St. N. S.
James P. Carr, B. A., Labor Temple, Wash. and Webster Ave.
- 155—BLOOMINGTON, ILL.** 2-4 Thurs., Machinists' Hall, West Chestnut St.
H. F. Lambrecht, Pres., 1004 N. Livingston St.
L. J. Metzner, C. & F. S., 1207 N. Mason.
- 157—SYRACUSE, N. Y.** 1st-3d Wed., Bartenders' Hall, Clinton & W. Genesee St.
J. J. Hardeny, Pres., 214 Hartson.
Thomas Ranger, C. S., 120 Lydell.
- 161—BOONE, IOWA.** 1st-3d Mon., at Electrical Workers' Hall.
Frank Whitman, Pres., 1603 Benton.
H. W. Martens, C. & F. S., 1329 Meridan St.
- 163—HOBOKEN, N. J.** 2d-4th Fri., 500 Bloomfield St.
Edwin L. Norwood, Pres., 933 Garden St.
P. L. Grownay, C. S., 1034 Willow Ave.
- 165—DULUTH, MINN.** 2d-4th Sat., Irwin-Sloan Block, 20th Ave. and Superior St.
James A. Graham, Pres., 5705 Grand Ave., W. Duluth, Minn.
Alfred S. Neison, C. & F. S., 5705 Grand Ave., W. Duluth, Minn.
- 169—DETROIT, MICH.** 2d-4th Fri., 235 Gardlot Ave.
Charles Komes, Pres., 31 Celaren.
Chas. F. Aderholdt, C. & F. S., 9 Sylvan St.
- 170—RICHMOND, VA.** 1st-3d Wed., Labor Temple, 5th and Marshall Sts.
R. L. King, Pres., 822 N. 26th St.
F. C. Blount, F. S., 1101 N. 23d.
E. M. Daywait, C. S., 2208 Venable St.
- 173—RALEIGH, N. C.**
B. F. Long, Pres., 218 N. McDowell.
J. F. Taylor, C. & F. S., 615 W. North.
- 175—OSWEGO, N. Y.** 2d-4th Mon., 8 p. m., Forester Hall, E. Bridge St.
Wm. Perau, Pres., 90 Hart St.
James Gorman, C. S., 54 Murray.
- 176—ELIZABETH, N. J.** 2d-4th Wed., Dahmen Hall, 4th and E. Jersey St.
John H. Reynolds, Pres., 33 Delaware St.
Samuel M. Rankin, Secy., 64 Florida.
- E. J. McCarthy, B. A., 67 St. Mark's Place, New York City.
- 179—DENVER, COLO.** 2d-4th Wed., Room 301 McPhee Bldg., 17th and Glenarm.
Geo. Gauss, Pres., 3869 Newton.
H. Shaffroth, C. & F. S., 3749 Wynkoop St.
- 180—MEMPHIS, TENN.** Italian Hall, 1st-3d Fri.
W. T. Funston, Pres., 889 Webster Ave.
C. F. Gillenwater, C. S., 140 W. Iowa Ave.
- 187—MIAMI, ARIZ.** Every Tues., Miami Hall.
J. W. Landers, Pres.
Roy Drummond, C. & F. S., Box 1121.
- 191—VICTORIA, B. C.** 2d-4th Tues., 1424 Government St.
A. Clyde, Pres., Sub. P. O. No. 2.
A. Stewart, C. S., Box 48, Beaumont, P. O. Esquimalt, B. C.
- 193—BALTIMORE, MD.** Every Tues., Patterson Bldg., Baltimore and Gay Sts.
John Shanley, Pres.
James Chaney, F. S., 1419 Patapsca St.
Philip Yingling, C. S., 410 E. 27th St.

- 194—VANCOUVER, B. C., CANADA. 1st-3d Mon., at Labor Temple.
F. W. Jurett, Pres., 2140 Bernard St.
A. Fraser, C. S., 1151 Howe St.
- 195—KEWANEE, ILL. 1st-3d Fri., O'Donnell's Hall, 3d St.
M. J. Carney, C. S., 411 N. 1st St.
- 197—ALBANY, N. Y. 31 Green St., 2d-4th Sat.
J. H. Sullivan, Pres. & B. A., 173 2d St.
Jno. J. Leamy, C. S., 68 Livingston Ave.
- 198—OGDEN, UTAH. 2d-3d Tues., Union Labor Hall on 24th St., bet. Washington and Grant.
F. S. Dunn, C. & F. S., 116 23d St.
- 199—HORTON, KAS. 1st-3d Thurs., Carmen's Hall
Barney Drew, Pres.
E. E. Myers, C. & F. S.
- 200—STATE ISLAND, N. Y. I. O. G. T. Hall, W. Brighton, S. I., N. Y., 1st-3d Mon.
Richard Hough, Pres., 55 Bay Ave., Pt. Richmond, S. I.
Ethan A. Johnson, C. S., 208 Broadway, W. Brighton S. I., N. Y.
E. McCarty, B. A., 67 St. Mark's Place, N. Y. City.
- 201—WINONA, MINN. Labor Temple, 1st-3d Tues.
Frank Rice, Pres., 574 W. 7th St.
W. Kukowski, C. S., 176 Mankato Ave.
J. H. Buchholtz, F. S., 251 E. King.
- 204—HONOLULU, H. I. Waverly Hall, 2d-4th Thurs.
Wm. Brown, Pres., Honolulu Iron Works.
Thos. Murrey, C. S., 1541 King.
- 205—SAN FRANCISCO, CALIF. 2d-4th Tues., Rosch Hall, 15th and Mission.
Wm. P. Bowser, Pres., 507 20th.
J. M. Enright, C. S., 1431 Dolores.
Walker Anderson, F. S., 607 Andover.
Wm. P. Bowser, B. A., 314 14th.
- 206—ALGIERS, LA. 2d-4th Fri., Renecky Hall.
Jos. Koentg, Pres. & C. S., 825 Elmira Ave.
C. A. Reynolds, F. S., McDonoghville, La.
- 209—DENISON, TEXAS. 2d-4th Mon., over State Nat. Bank.
A. McDowell, Pres., 504 W. Owings St.
S. E. Harris, C. & F. S., 923 W. Morgan St.
- 216—EL PASO, TEXAS. 2d-4th Thurs., Union Labor Hall.
Wm. Beeson, Pres., Gen. Del.
Frank H. Balt, C. S., 114 S. Stanton St.
- 218—SPRINGFIELD, MASS. 2d-4th Wed., Winkler's Hall, Bridges and Water St.
Michael Fitzgerald, Pres. 843 Caren St.
Wm. E. Donovan B. A., 9 Arbor.
Jerrh C. Driscoll, C. S., 141 Patton.
- 220—CHICAGO, ILL. 1st-3d Tues., 75th St. and Ellis Ave.
A. G. Smith, Pres., 7036 Harper Ave.
L. J. Cundiff, C. & F. S., 6029 Dorchester Ave.
- 221—PITTSBURG, KAS. 1st-3d Tues., Red Men's Hall, W. 3d St.
E. E. Hiett, Pres., 1803 N. Grand Ave.
P. J. Hiett, C. S., 1801 N. Grand.
- 222—MART, TEXAS. W. O. W. Hall.
E. J. Blount, Pres.
G. W. Coates, C. & F. S.
- 223—UTICA, N. Y. Labor Temple, 2d Fri.
Louis Wengert, Pres., 8 Wiley St.
Edward Wengert, C. S., 43 Fass Ave.
- 225—ELMIRA, N. Y. 2d-4th Sun., Trades & Labor Hall, 200 E. Water St.
A. E. Stevenson, Pres., 964 McGee.
N. P. Durain, R. & C. S., 519 Penn Ave.
- 226—SALISBURY, N. C. W. O. W. Hall, Innes and Main Sts., 2d-4th Fri.
L. C. Woodington, Pres., 319 E. Fisher St.
E. A. Cowan, C. S., Box 271, Spencer, N. C.
- 227—CHICAGO, ILL. Garfield Park Hall, 4039 W. Madison St. 2d-4th Sat.
John Seidon, Pres., 1107 Keeleer Ave.
Thomas Dean, F. & C. S., 2214 W. 13th St.
- 229—ROCHESTER, N. Y. 2d-4th Wed., 14 N. Water St.
W. Weston, Pres., 17 Coffrey Place.
Robt. Little, C. S., 211 Garfield.
- 232—OAKLAND, CAL. 2d-4th Mon., cor. 7th and Peralta Sts.
H. Brown, Pres., 1003 Pine St.
Geo. Young, C. S., 1788 9th St.
- 235—COLUMBIA, S. C. 2d-4th Tues., Plumbers' Hall, 1623 Main St.
E. R. Fenell, Pres., 1712 Blanding.
J. W. Bankhead, C. & F. S., 1705 Thompson Ave.
- 236—MARQUETTE, MICH. 4th Thurs., E. Seigle's Hall.
Albert Bastien, Pres., 347 West Washington.
Arthur Bourgois, C. S., 817 North 3d St.
- 237—HARTFORD, CONN. 2d-4th Wed., at C. L. U. Hall, Central Row.
James Thornton, Pres., 52 Green.
John J. Reilly, C. S., 46 Pliny.
- 238—CLIFTON FORGE, VA. 1st-3d Fri., Junior Hall.
A. J. Hauer, Pres., 34 Alleghany.
M. L. Steinbuck, C. & R. S., Box 336.
D. G. Clark, F. S., 192 Ridgeway.
- 239—ROCKY MOUNT, N. C. 1st-3d Mon., Machinist Hall, cor. Sunset and Main Sts.
A. J. Dixon, Pres., 208 Atlantic Ave.
H. M. Myers, C. S., 313 Maderson.
- 241—WASHINGTON, IND. Zinkin's Hall, 3d and Vantreese Sts., 1st-3d Tues.
J. C. Mooney, Pres., East George.
M. W. Luke, C. & F. S., 1097 W. Main.
- 242—SPOKANE, WASH. 2d-4th Wed., Carpenters' Hall, No. 9 Madison St.
Frank Depender, Pres., 611 E. Indiana Ave.
R. L. Mason, C. S., 218 S. Pittsburg St.
- 244—SIOUX CITY, IOWA. Labor Temple, 5th St., near Pierce, 3d Wed.
John Ewing, Pres., 103 Alice St.
Robt. O'Hern, C. S., No. 5 14th.
- 245—CONCORD, N. H. 2d-4th Mon., Central Labor Union Hall.
Geo. Tanner, Pres., Hall St.
J. Berryman, C. S., 143 S. Main.
J. R. New, F. S., 120 Broadway.
- 246—TERRE HAUTE, IND. Cor. 8th and Wabash Ave., 1st-3d Tues.
H. M. Showalter, Pres., 1410 S. 17th.
Jesse Dukes, C. S., 1561 S. 18th.
F. Wittke, F. S., 1709 N. 12th.
- 247—TACOMA, WASH. 1st-3d Mon., Odd Fellows' Hall, S. Tacoma.
Andrew Hansen, Pres., 5406 So. Paks St.
Wm. Polzin, C. & F. S., 5814 S. Lawrence St., So. Tacoma, Wash.
- 249—HUNTINGTON, W. VA. Every Fri., Thompson Bldg., cor. 20th St. and 3d Ave.
John Myers, Pres.
J. E. Stott, C. & F. S., 1911 11th Ave.
D. C. Dowdy, B. A., 2048 7th Ave.
- 250—BOSTON, MASS. Hollis Hall, 724 Washington St., 1st-3d Fri.
Joseph F. Gilchrist, Pres., 194 W. Brookline.
Jeremiah Murphy, C. S. & B. A., 107 Union Park St.
- 254—CHICAGO HEIGHTS, ILL. 1st-3d Mon. at Trades & Labor Assembly Hall, West End Ave.
Thomas Hines, Pres., 1656 West End Ave.
Thomas Brooks, C. & F. S., 306 W. 15th Place.
- 256—POTTSVILLE PA. Wm. Graeff, Pres., 542 E. Market.
W. Smith, C. S., 215 Front, Minersville, Pa.
- 259—LIMA, OHIO. 2d-4th Thurs. 334 No. Main.
A. C. Thompson, Pres., East Finley.
Pat Corley, C. S., 1020 Northwest.
Harry Gunn, F. S., 723 West Wayne.
- 265—SMITHVILLE, TEXAS. 1st-4th Mon.
E. C. Rovillo, Pres.
G. L. Payton, C. S., Box 344.
- 267—MOBERLY, MO. 2nd and 4th Thurs. Painters' Hall.
J. J. Cadagin, Pres.
F. R. Lee, C. S., 601 Monroe Ave.
- 276—ST. LOUIS, MO. 2d-4th Fri., N. E. Cor. 11th and Locust.
Herbert Abbey, Pres., 2618 Ann Av.
Henry Waeckerle, C. S., 2919A Miami.
Clyde Stevens, F. S., 1419 N. 21st, E. St. Louis, Ill.
- 278—ELKINS, W. VA. 2d-4th Thurs., Kendall Hall.
C. L. Caskey, Pres., 10 Second.
C. H. Godwin, C. & F. S., 312 Center St.
- 279—EDMONTON, ALB. CAN. 1st Mon., Calder, Edmonton.
Wm. J. Fitzmaurice, Pres., Box 2100, of E. D. & B. C. Ry.
James McLean, C. & F. S., 10236 113th St.
- 281—NORWOOD, MASS. 2d-4th Fri., 724 Washington St., Boston.
Amos Bennett, Pres., 135 Appleton St., Boston, Mass.
Robert Henderson, C. S., 274 Metropolitan Ave., Roslindale, Mass.
- 284—FREEPORT ILL. Every 3d Wed. at Blunt Hall.
J. W. Daniels, Pres. and C. S., 27 Shawnee St.
- 286—FORT SCOTT, KAS. 1st-3d Mon., Redmen's Hall, 111 E. Wall St.
J. W. McNow, Pres., 816 Marlon Ave.
J. C. Bonestell, C. S., 739 Croford.
- 287—KINGSVILLE, TEXAS. W. B. Poor, Pres.
E. C. Martin, C. S.
- 290—BREMERTON, WASH. Sam Reardon, Pres.
John Kornby, C. S., Gen. Del.
- 292 — PARSONS, KAS. 2d-4th Tues., Moose Hall.
C. Dudding, Pres., 2229 Crawford St.
E. P. Butler, C. S., 1723 Gabriel.
- 293—SHAWNEE, OKLA. Trade Assembly Hall, 2d-4th Mon.
Floyd Ott, Pres., 318 E. 9th St.
A. D. Ross, C. & F. S., 429 N. Park Ave.
- 298—PORTSMOUTH, VA. C. L. U. Hall, 2d-4th Thur.
J. W. Ford, Pres., 2225 High St.
Robt. T. Howe, C. S., 826 4th St.
- 300—WATER VALLEY, MISS. I. O. O. F. Hall, 1st-3d Thur.
C. H. Baker, Pres. and Treas.

- 301—CANTON, OHIO.** 1st-3d Mon., Switzer Hall, Cherry and 8th Sts.
Joe Petch, Pres., 1119 5th St., N. E.
E. J. Gussett, C. & F. S., 1202 McKinley Ave., S. W.
- 302—MILWAUKEE, WIS.** 1st-3d Sat., Lipp's Hall, 3d and Prairie.
Henry J. Murray, Pres., 113 29th St.
Hugh Fuller, C. S., 500 34th St.
F. P. Youngbluth, F. S., 37 35th St.
- 303—PORT ARTHUR, TEXAS.** 2d-4th Tues., Labor Hall.
C. L. Bragg, Pres., Gen. Del.
T. O. Riley, C. S. & B. A., Box 683.
James Rose, F. S., Box 8.
- 300—EVANSTON, WYO.** I. O. O. F. Hall, 1st-3d Wed.
John T. Whittle, Pres., County Road.
J. H. Willoughby, C. S., Box 419.
- 311—SOUTH KAUKAUNA, WIS.** 2d-4th Mon., Odd Fellows' Hall.
Ed. Hohnemann, Pres.
Chas. F. Weigmann, C. & F. S., Box 133.
- 312—SELMA, ALA.** 1st-3d Wed., at R. R. Y. M. C. A.
J. F. Ryals, Pres.
W. P. Fawcett, C. S., 1509 Selma.
- 315—MCCOMB, MISS.** Central Trade and Labor Hall, 1st-3d Wed., at 7:30.
R. O. Bean, Pres., & C. S., Box 684.
- 317—RICHMOND, CALIF.** Union Hall, 2d-4th Tues.
Frank Mallinson, Pres., care Randall Hotel.
Wm. Jones, C. & F. S., Box 634.
- 318—PITTSBURGH, PA.** 1st-3d Mon., Hazlewood Bank Bldg., cor. 2d and Hazlewood.
W. Mertz, Pres., Path Alley.
T. A. Hudson, F. S., 310 Johnston Ave.
- 320—MERIDAN, MISS.** B. L. E. Hall, 5th St. and 40th Ave., 1st-3d Thurs.
J. A. Smitheren, Pres., 511 40th Ave.
J. E. Alexander, C. & F. S., 3817 7th St.
- 322—ST. LOUIS, MO.** 1st-3d Tues., Reddy Hall, 3100 Chautau.
John Coots, Pres., 2726 Washington Ave.
M. Renth, C. S., 4537 Michigan Ave.
- 323—CHICKASHA, OKLA.** 2d-4th Fri., Labor Hall, 4th and Choctaw.
C. A. Chincholl, Pres., P. O. Box 502.
W. L. Harkins, C. & F. S., 528 S. 15th.
- 323—SHREVEPORT, LA.** K. of P. Hall, over West End Drug Store, 2d-4th Thurs.
H. Abbott, Pres., 1542 Luchina Ave.
H. W. Huff, C. S., 1863 Texas Av.
- 332—CUMBERLAND, MD.** 1st-3d Wed., Chapel Hill House.
G. H. Little, Pres., 401 1st St.
C. J. Deal, C. S., 48 Penn Ave.
- 334—PRINCETON, IND.** 2d-4th Fri., 110 E. State St.
Fred Day, Pres., 617 S. Gibson.
Henry Schimmelman, C. & F. S., 1023 S. Prince.
- 335—GRAND JUNCTION, COLO.** 2d-4th Fri., Eagles' Hall.
G. R. Stoll, Pres., 337 White.
E. H. Friend, C. & F. S., 308 Pitkin Ave.
- 335—SPARKS, NEV.** 2d-4th Wed., Engineers' Hall.
Wm. Daseler, Pres., P. O. Box 214.
C. E. Crouch, C. S., P. O. Box 214.
- 340—HERINGTON, KAS.** 1st-3d Sat., I. O. O. F. Hall.
John Olson, Pres.
Harry W. Willis, C. S., Box 224.
- 341—PHILADELPHIA, PA.** 2d-4th Tues., 8 p. m., Labor Headquarters, 232 N. 9th St.
Wm. J. Boyle, Pres., 208 N. 58th St.
Chas. Heberly, C. S., 3084 Aramingo Ave.
- 344—SHEFFIELD, ALA.** 1st-3d Wed., at I. O. O. F. Hall, Montgomery Ave.
W. H. Wilson, Pres., Tuscumbia, Ala.
Joseph Meyers, C. S., Tuscumbia, Ala.
- 345—SAN ANTONIO, TEXAS.** Trades Council Hall, 3d Thurs.
P. G. Summany, Pres., 221 Josephine.
E. H. Frick, C. & F. S., 1223 W. Traves Ave.
Delrympel, B. A., 410 River Ave.
- 346—TRENTON, MO.** 1st-3d Tues., at Cutlip's Hall.
Walter Mason, Pres., 1726 Lula Ave.
Geo. W. Singer, C. & F. S., 1801 Maine St.
- 353—HANNIBAL, MO.**
Wm. James, Pres., 300 Rock.
J. J. Sughnee, C. & F. S., 836 Grand Ave.
- 354—BROOKFIELD, MO.** 1st-3d Tues., 212 N. Main St.
Martin Murphy, Pres., 291 Elm St.
J. K. Burnham, C. S., 212 W. John St.
- 355—CONNEAUT, OHIO.** 2d-4th Fri., Stationary Eng. Hall, Main St.
Chas. Ward, Pres., 685 Lakeview Ave.
E. J. Dickson, F. S., 815 Main.
- 356—HAMMOND, IND.** 3d Wed., Long's Hall, State St.
Wm. J. Davis, Pres.
Albert Gragedo, C. S., 647 Calumet Ave.
- 360—LAFAYETTE, IND.** 1st-3d Thurs., Bartenders' Hall, 3d and Ferry Pt.
J. H. Goldsberry, Pres., 1620 N. 13th St.
J. A. Peacock, C. S., 1810 Charles Ave.
R. A. Davis, B. A., 1900 Schuyler Ave.
- 363—EAST ST. LOUIS, ILL.** 1st-3d Fri., Barry's Hall, cor. Coll and Ohio.
John Roach, Pres., 614 Ohio.
James E. Whitmore, C. & F. S., 314 Market.
- 364—COVINGTON, KY.** 1st-3d Mon., Heidels' Hall, N. W. cor. 21st and Russell Sts.
Herman Dedden, Pres., 19th and Euclid Ave.
R. F. Powers, C. S., 2011 Pearl St.
- 367—HAVRE, MONT.** 3d Sat., Oxford Hall.
Kyle Burns, C. S., 1428 3rd St.
Elmer Burns, C. S., 1037 2nd St.
- 369—ALEXANDRIA, VA.** 1st Thur. in month during summer months, 108 N. Patrick St.
James Moran, Pres., 1219 Duke.
R. B. Craddock, R. & F. S., 809 Cameron.
- 371—LOWELL, MASS.** 1st-3d Sat.
James Larrigan, Pres.
Geo. W. Smith, C. S., 68 Loring.
- 377—MOLINE, ILL.** 1st-3d Fri., Moline Industrial Home, cor. 14th St. and 5th Ave.
Carl Robison, Pres., 7th St., Silvis, Ill.
John Fulton, F. S., 7th St., Silvis, Ill.
Charles McGowan, B. A., 7th St., Silvis, Ill.
C. R. Kizer, C. S., Box 581, Silvis, Ill.
- Walter S. Schnelder, B. A., 1317 25th St., Rock Island, Ill.
- 378—MONCTON, N. B., CAN.** 2d-4th Fri., Sons of Temperance Hall.
Alex McDougall, Pres., 143 High St.
R. D. Donnelly, C. S., 69 Downing St.
- 379—MACADAM JUNCTION, N. B., CAN.** 2d-4th Fri., Orange Hall.
Geo. Guest, Pres.
A. J. McLaggan, C. S.
- 381—AMARILLO, TEXAS.** 1007 Buchanan.
M. L. Parker, Pres., Box 407.
Joe Wilson, C. S., 1007 Buchanan.
- 382—CHILDRESS, TEXAS.** 2d-4th Fri., at 7:30 P. m., in Labor Temple.
Mack Leopold, Pres., P. O. Box 835.
J. M. Neal, C. S.
- 384—PERU, IND.** 2d-4th Tues., Labor Trades Hall.
Paul Uhlig, Pres.
W. H. Hawkins, F. & C. S., 404 W. 12th St.
Frank Sullivan, B. A., 673 W. Main.
- 388—MECHANICSVILLE, N. Y.** 2d-4th Tues., A. O. H. Hall, North Main St.
Wm. Sawyer, Pres., 321 Park Ave.
Sidney Crozier, C. S., 28 Railroad St.
- 390—TRINIDAD, COLO.** 2d-4th Wed., Labor Union Hall, East Main St.
W. T. Flynn, Pres., Arizona Ave.
A. A. Loftus, F. & C. S., 107 Goddard St.
- 391—DAVENPORT, IOWA.** 2d-4th Fri., Danish Hall.
John Schach, Pres., 516 1/2 W. 3d.
R. F. Stewart, C. S., 616 Tremont Ave.
W. C. Richards, F. S., 1938 Bridge Ave.
- 392—CALGARY, ALBERTA, CAN.** 2d Sun. and 4th Tues., Labor Temple.
P. Willis, Pres., 1614 11th Ave. W.
F. Adams, C. S., Ogden, near Calgary, Alb.
- 393—GOODLAND, KAS.** 1st-3d Tues., Calvert & Sparks' Law Office.
John McPeak, Pres.
John Maher, C. & F. S.
- 395—NORTH FOND DU LAC, WIS.** 1st-3d Fri., Trades and Labor Hall, cor. 3d and Main.
Elmer Shields, Pres., 109 Wible St.
Wm. Ford, C. S., 536 Main Ave.
- 396—NORWICH, N. Y.** 4th Wed. in Cook Block.
James E. Callahan, Pres., 1 Columbia St.
Julius Schraft, C. & F. S., 13 Davis.
- 398—RIVIERE DU LOUP, QUEBEC, CANADA.** Rioux Hall.
Pierre Loperriere, Pres., Blais Ville.
Ludger Oullet, C. & F. S., Blais Ville.
- 400—MIDDLETON, N. Y.** 2d-4th Sat., Odd Fellows' Hall.
Wm. Springer, Pres., 55 Beattie Ave.
W. S. Seeley, 74 Sproat St.
- 402—PORTSMOUTH, OHIO.** 2d-4th Fri., C. L. U. Hall.
Fred Miller, Pres., cor. Robinson and Summit St.
Edward Snyder, C. S., 2113 17th St.
- 403—HOISINGTON, KAS.** I. O. O. F. Hall, 1st-3d Mon.
Ray Bowler, Pres., P. O. Box 72.
C. A. Cramer, C. & F. S., Box 494.
- 405—BLUEFIELD, W. VA.** 1st-3d Fri., Masonic Temple.
E. K. Collins, Pres., Princeton Ave. E.
W. F. Dupree, C. & F. S., Gen. Del.

- 409—VAN WERT, OHIO. 3d Thurs., Suite 226 Home Guard Bldg.
E. K. Murlin, Pres., 208 N. Race.
- 410—SAN FRANCISCO, CAL. 2d-4th Wed., Polita Hall, 3266 16th St.
Ed Hanny, Pres., 518 Alvarada.
Wm. P. Bowser, B. A., 314 14th St.
- 412—ST. THOMAS, ONTARIO, CAN. 2d-4th Tues., Machinists' Hall, Talbot St.
Frederick Brooks, Pres., 5 Maama St.
Frank Roberts, C. S., 61 Wilson Ave.
- 414—ONEONTA, N. Y. 1st Wed. and 3rd Sun., 2:30 p. m., Redmen's Hall.
James Walsh, Pres., 51 Church.
David Lawrie, C. & F. S., 73 W. Broadway.
- 415—JACKSONVILLE, ILL. F. McKenna, C. S., 475 E. State.
- 417—NORTH BAY, ONT., CAN. 2d-4th Fri., Liberal Rooms, Brennan Bldg.
M. V. Milton, Pres.
Frank Crother, C. S., Box 1775.
- 418—NEODESHA, KAS. 1st-3d Sat., Baldwin Hall.
B. Boyle, Pres.
E. P. Reddick, C. S., Box 775.
A. F. Bingham, B. A.
- 419—SOMERSET, KY. 1st-3d Tues., at Owen's Hall.
Peter Lefter, Pres., Sta. A.
J. A. Schofield, C. & F. S., Sta. A.
- 421—HAMILTON, ONT. 1st-3d Fri., Labor Hall, John St. So. L. Lawton, Pres., No. 21 Tuckett.
F. Honison, C. & F. S., 8 Bristol.
- 422—SANFORD, FLA. 2d-4th Wed., Eagles' Hall.
H. B. Purden, Pres.
Geo. Randall, C. & F. S., P. O. Box 1194.
- 423—BIG SPRINGS, TEXAS. W. O. W. Hall, 2d-4th Mon.
W. E. Moore, Pres.
W. P. Warren, C. & F. S., 201 N. 1st.
- 424—FLORENCE, S. C. 2d Thurs., Y. M. C. A.
L. H. Mims, Pres., 222 Covington St.
A. H. Dickman, C. & F. S., 609 Day St.
- 425—WAYCROSS, GA. 1st-3d Thurs., Plant Ave.
C. W. Shultz, Pres., Nicholls St.
Wm. J. Hauf, C. S., 33 Folks.
- 427—SALIDA, COLO. 2d-4th Thurs., Adliss Hall.
H. F. Jones, Pres., 135 E. Sacket Ave.
Wm. Dargavel, C. S., 821 E. St.
- 428—NORFOLK, VA. 2d-4th Wed., Pythian Castle Hall.
W. M. Wood, Pres., 617 Liberty St., Berkely, Va.
Thos. Callahan, C. & F. S., 116 Middleton St., Berkeley, Va.
- 430—CAPE GIRARDEAU, MO. 1st-3d Tues., Haas' Hall.
Geo. Stanley, Pres., 223 Frederick St.
Oscar O. Berry, F. S., 415 S. Frederick St.
- 431—BOSTON, MASS. 2d Thurs., Naomi Hall, 724 Washington.
Thos. R. Keenan, C. S., 80 W. 5th St., So. Boston.
- 434—CHICAGO, ILL. 2d-4th Wed., Boulevard Hall, 55th and Halstead Sts.
H. Fischer, Pres., 6507 Sangamon.
Ed Osborne, C. S., 48 E. 43d.
- 435—BRISTOL, TENN. 2d-4th Fri., Sixth and Shelby Sts.
M. C. Cooper, Pres., V. & S. W. Ry. Shops.
J. B. Wood, C. & F. S., 27 Lancaster St., Bristol, Va.
- 436—COLUMBUS, GA. 1st-3d Fri., K. C. Hall, cor. 13th and Broad Sts.
R. S. Barry, Pres., 1109 5th Ave.
E. W. McMichael, C. & F. S., 411 10th St.
- 437—TWO HARBORS, MINN. 2d and last Thurs., Iron Dock Grove Hall.
Wm. Richards, Pres., Gen. Del.
Frank J. Kontny, C. & F. S., Box 906.
- 438—GALETON, PA. 2d-4th Tues., Eagles' Hall.
Daniel B. Shine, C. S., 20 First St.
- 439—FAIRBURY, NEB. Labor Temple, 2d-4th Tues.
Fred Hurst, Pres.
Edgar Sullivan, C. S., Box 301.
B. Z. Millikan, B. A.
- 440—BELLE PLAINE, IOWA. 2d-4th Mon., Fireman's Hall.
Charles Corns, Pres., 10th St.
Warren Wheeler, C. S., P. O. Box 605.
- 442—NEW ORLEANS, LA. 3d Tues., 1112 Drayder St.
James Miller, Pres., 1204 Franklin.
- John Mocklin, C. & R. S., 606 S. Telemachus St.
- 444—CONNELSVILLE, PA. J. W. Easley, C. S., 113 Porter Av.
- 446—ALAMOSA, COLO. 2d-4th Wed., Trades Assembly Hall.
Albert Jacobson, Pres.
Chas. F. Darling, C. S., Box 64.
- 447—DECATUR, ILL. 1st-3d Tues., Ashley Hall, Mason Temple.
Jas. Gray, Pres., 817 N. Broadway.
Chas. J. Younger, C. & F. S., 432 E. King St.
- 448—MONTGOMERY, ALA. 1st-3d Wed., Young's Hall.
J. E. Johnson, Pres., 89 Morgan Ave.
E. J. Ford, C. S., 75 Morgan Ave.
- 449—SAPULPA, OKLA. 2d-4th Mon., Pane Hall.
D. A. Clifton, Pres.
J. D. Allen, C. & F. S., 1133 E. Hobson.
- 450—WASHINGTON, D. C. 2d-4th Wed., Weller's Hall, 8th & I. St., S. E.
S. Kelchner, Pres., 1020 B. St., S. E.
W. F. Kilroy, C. S., 11 I St., N. E.
- 451—WINNIPEG, MAN., CAN. 2d-4th Fri., Labor Temple.
D. Nelson, Pres., 322 Morley Ave.
F. Saure, C. & F. S., 263 Bradford St., St. James.
- 453—COPPERHILL, TENN. 1st-3d Tues., I. O. O. F. Hall.
Chas. Frenz, Pres., Box 711.
E. N. Hall, C. S., Box 382.
- 454—CHICAGO, ILL. 2d-4th Thurs., Persey Hall.
Walter Love, Pres., 752 E. 69th St.
E. R. Dettmer, C. S., 9245 Stoney Island Ave.
- 458—SHERMAN, TEXAS. 2d-4th Thurs., Labor Hall.
A. T. Green, Pres., 501 W. Morgan St., Denison, Tex.
John W. Plexco, C. S., 424 S. Gribble.
- 463—BALBOA, CANAL ZONE, PANAMA. Empire Lodge Hall, 2d-4th Fri.
Alex. McKenzie, Pres.
W. H. Keenan, C. & F. S., Box 26, Culebra, C. Z.
- 464—PALESTINE, TEXAS. Labor Temple, 2d-4th Wed.
Phil Lyser, Pres., 111 Irwin.
J. D. Mallette, C. & F. S., 503 La.
- 466—REVELSTOKE, B. C. 3rd Sat., Selkirk Hall.
M. M. Keller, Pres., Box 138.
A. Harris, C. & F. S., Box 138.
- 467—PORTSMOUTH, N. H. 2d Wed., Eagles' Hall.
John Quinn, Pres., Court St.
- Alfred Olson, C. S., Box 27, Kittery, Me.
- 469—TERRELL, TEXAS. 2d-4th Fri., Trades and Labor Hall, 202 E. Moore Ave.
J. R. Poston, Pres., 608 E. College St.
R. E. O'Reilly, C. S., 906 E. Moore Ave.
- 471—CRISTOBAL, C. Z. 2d-4th Thurs., Building No. 1.
J. Z. Knapp, Pres., Gatum, C. Z.
V. Z. McMullen, C. & F. S., Box 369.
- 473—HELPER, UTAH. 1st-3d Wed., K. of P. Hall.
Wm. R. Welsh, Pres.
R. W. Smith, C. & F. S., Box 411.
- 475—GRAND ISLAND, NEB. 1st-3d Mon., City Hall, 2d St.
H. W. Hunt, Pres.
Sherman Aldrich, F. S., 1014 E. 4th St.
- 476—DALHART, TEXAS. 1st-3d Sat., each month.
A. W. Williams, Pres.
- 478—MOOSE JAW, SASKATCHEWAN, CANADA. 2d-4th Mon., Trades and Labor Hall, High St., E.
J. L. Jones, Pres., 78 Chateau St. W.
Geo. Walters, C. S., 30 Duffield.
- 479—DEVIL'S LAKE, N. DAK. 1st Fri., Opera House Hall.
J. A. Thompson, Pres., Box 324.
Andrew Ruthford, C. & F. S., 714 Flint Ave.
- 481—LYNDONVILLE, VT. 1st-3d Wed., Eaton's Hall.
B. A. Hinds, Pres.
E. A. Phillips, C. & R. S., Box 121, Lyndon Center, Vt.
J. M. Bresson, B. A.
- 483—ALTON, ILL. Schwartzbeck Hall, 3d and Ridge. 1st-3d Tues.
Fred Emmel, Pres., 1410 E. 3rd St.
Robt. Dale, C. S., 3008 Edwards.
- 485—GREEN BAY, WIS. 1st Thur. and 3rd Sun., 109 Dousman St.
J. L. Callahan, B. A., 3606 Clifton Ave., Milwaukee, Wis.
John Christianson, Pres., 822 S. Maple Ave.
John Slater, C. & F. S., 425 5th St.
- 486—TYLER, TEXAS. 1st-3d Wed., K. O. T. M. Hall.
J. A. Fuller, Pres., 1116 Irvin.
J. M. McCarty, C. & F. S., 221 Center St.
C. R. Welch, B. A., 1428 N. Fannie Ave.
- 488—SEATTLE, WASH. 3d Wed. J. R. Martin, C. S., The Broadway, Yeslerway.
- 491—VALLEY JUNCTION, IOWA. 1st-3d Tues., I. O. O. F. Hall.
Frank S. Hoppe, Pres.
J. C. Carroll, C. S., Box 165.
Geo. W. Pring, B. A., Treas.
- 492—WORCESTER, MASS. 1st-3d Thur., Foresters' Hall.
Patrick I. Curran, Pres., 4 Willson.
John Casey, C. S., 61 E. Central.
- 493—NEW CASTLE, PA. Jan. 13, 1915, and every other Wed., Trades Assembly Hall.
D. E. Sturdevant, Pres., 516 Waldo.
E. A. Horchler, C. & F. S., 906 E. Washington.
- 495—HATTIESBURG, MISS. 1st-3d Tues., 500 Bonnie St.
C. W. LeBlanc, Pres., 107 Evans.
A. H. Waddell, C. & F. S., 500 Bonnie.
- 496—HURON, SOUTH DAKOTA. 2d Sun. and 4th Fri., Labor Hall.
Peter Paluszak, Pres.
C. Storkson, C. & F. S., 228 Beach St.

- 500 — EVERETT, WASH. 2d-4th Tues., Labor Temple, 3506 Everett Ave.
Wm. Faulke, Pres., 3506½ Everett Ave.
Bert Bloomington, C. S., 4001 Smith Ave.
- 501—WACO, TEXAS. 2d-4th Fri., Labor Hall.
Chas. Bullock, Pres., R. F. D. No. 2
Wm. Dickerson, C. & F. S., 810 Cleveland St.
- 502—TEAGUE, TEXAS. 1st-3d Mon., Davis Hall.
Thos. McGrath, Pres., Box 244.
A. B. Campbell, C. S.
- 503—FITZGERALD, GA. 1st-3d Wed., I. O. O. F. Hall.
M. J. Mauns, Pres., P. O. Box 686.
- 504—MUSKOGEE, OKLA. 1st-3d Wed., Carpenters' Hall.
Thos. Graham, Pres., 233 S. C. Wm. Sohner, C. S., 616 N. F. St.
- 505—FORT WILLIAM, ONTARIO, CAN. 1st-3d Fri., Electricians' Hall, Murphy Block, Simpson Ave.
Isaac Hunter, Pres., 213 Frederica St.
A. Cruickshank, C. S., 1007 Mmn. Ave.
- 507—ATCHISON, KAS. 1st-3d Mon., Fireman's Hall, 1521 Main St.
J. F. Coyle, Pres., 1418 Kansas Ave.
John J. Frelbott, C. & F. S., 1420 N. Kansas Ave.
- 508—JACKSON, OHIO. 2d-4th Mon., Hibernian Hall.
O. B. Reynolds, Pres., 77 High St.
Albert Edmonds, C. S., 77 Hunt St.
J. E. Fillingim, B. A. and Journal Cor., 53 Main St.
- 510—CEDARTOWN, GA. E. M. Kendricks, Pres.
I. C. Smith, C. S.
- 511—WHISTLER, ALA. 1st-3d Mon., I. O. O. F. Hall.
J. L. Scholls, Pres.
C. C. Crone, C. S.
- 515—EAST CAMBRIDGE, MASS. Engineers' Hall, 164 Canal St., Boston, Mass., 1st-3d Fri.
Geo. A. Mitchell, Pres., 39 S. Russell St., Boston, Mass.
Joseph Irwin, C. & F. S., 36 Glendale St., Everett, Mass.
- 517—GREENFIELD, MASS. 2d-4th Sat., Forester Hall.
Z. E. Paine, Pres., 6 Devens St.
M. J. Cummskey, C. S., 287 King St., Northampton, Mass.
- 518 — WICHITA, KAS. 1st-3d Thurs., 216 N. Main St.
Roy Connors, Pres., 1440 S. Market St.
J. M. Devlin, C. & F. S., 620 Hiram Ave.
- 520—MILES CITY, MONT. 2d-4th Mon., I. O. O. F. Hall.
P. J. Gallagher, Pres., 602 N. Lake St.
Chas. E. Cook, C. & F. S., 725 Phillips St.
- 521—VAN BUREN, ARK. 1st-3d Thurs., W. O. W. Hall.
E. C. Norman, Pres., Box 343.
Otto Pyles, C. S.
- 522—EL RENO, OKLA. 1st-3d Tues., Redmen's Hall.
D. F. Rowe, Pres., 207 N. Barker.
H. E. Hart, C. & F. S., Box 624.
- 523—PRATT, KAS. 2d-4th Tues., at S. T. Sample's residence.
Frank Stephens, Box 612, Pres.
Lex Logan, C. S., 607 N. Jackson.
- 524—MURPHYSBORO, ILL. 2d-4th Wed., Machinists' Hall, 107 S. 10th.
- A. R. McFarland, Pres., 638 N. 8th.
E. P. Herin, C. & F. S., 2107 Wall.
- 525—HINTON, W. VA. 1st-3d Mon., Big Four Bldg.
W. L. Taylor, Pres., 108 Grace St.
C. L. Barnette, C. & F. S. & B. A., 207 2d Ave.
- 528—DEER LODGE, MONT. 2d-4th Fri., I. O. O. F. Hall.
T. J. Messing, Pres.
J. H. Thomas, C. & F. S., P. O. Box 877.
- 529—TRANSCONA, MAN., CAN. 1st Sun., Campbell Hall, Transcona, 3rd Sun., Labor Temple, Winnipeg, 3 p. m.
Wm. S. Douglas, Pres.
James Fraser, F. & R. S., Yale Ave.
- 530—SPRINGFIELD, MO. 3d Mon., Dengeldem's Hall.
J. W. Reddick, Pres., 817 Lincoln.
John Cain, C. & F. S., 507 Fort.
A. F. Bingham, B. A., 701 Lombard St.
- 531—CHAFFEE, MO. 1st-3d Thurs., City Hall.
T. C. Davis, Pres.
C. P. Bourlon, C. & F. S., Box 365.
- 537—COVINGTON, KY. 2d-4th Fri., Workman Hall, 122 Pike St.
John J. Fielding, Pres., 1389 Scott St.
John H. Zerhusen, F. S., 862 Crescent Ave.
J. J. Fielding, B. A., 1389 Scott.
- 541—BEDFORD, IND. 2d-4th Thurs., Labor Union Hall.
Dan J. Kane, Pres., 511 N. I St.
Chas. J. Bordenet, C. S., 628 N. I St.
- 542—COFFEYVILLE, KAS. Labor Temple, 2d-4th Wed.
R. M. Jones, Pres., 807 W. 14th.
J. C. Morrow, C. & F. S., 613 W. 4th St.
- 543—WICHITA, KAS. 216 N. Main St., 2d-4th Mon.
E. C. Hadler, Pres., 358 Lulu Ave.
C. E. Grove, C. & F. S., 701 W. Central.
- 546—MONETT, MO. 1st-3d Tues., K. C. Hall.
David Elder, Pres., 406 9th St.
John Linebarger, C. & F. S., 214 Pearl St.
- 547—CARBONDALE, PA. Pugh-anas Hall, 2d-4th Fri.
E. T. Dickenson, Pres., 142 Wyoming.
James A. Flannery, C. & F. S., Box 185.
Wilkes Barre Representative, T. J. Cavan, 60 Chester St., Wilkes Barre, Pa.
- 548—TORONTO, CAN. 2d-4th Wed., Labor Temple, Church
Jas. Dobson, Pres., 280 Perth Ave.
W. H. Watson, C. S., 162 Annette St.
- 549—MIDDLEPORT, O. 1st-3d Tues., Firemen's Hall.
Lester Cunningham, Pres.
Perry Cooper, C. & F. S.
- 551—PRINCETON, W. VA. Castle Hall, 1st-3d Thurs.
J. J. Bower, Pres., 821 Princeton Ave.
J. H. Blackwell, C. S., Box 312.
- 553—LA GRANGE, ORE. Wm. Andis, Pres., 1506 V Ave.
Jas. H. Gutridge, C. S., Box 197.
- 556—OKLAHOMA CITY, OKLA. C. S. Cochran, Pres., 406 W. Frisco.
E. F. Ryan, C. & F. S., 400 West Frisco.
- 557—WILLIAMSON, W. VA. 2d-4th Tues., Justice Bldg.
- H. W. Bias, Pres., 15 5th Ave. E.
Bert Howard, C. & F. S., Box 113.
- 565—FALLS CITY, NEB. 1st-3d Thurs., W. O. W. Hall.
C. W. Jonas, Pres.
E. Woodington, C. & F. S., 710 E. 16th St.
- 567—SAN ANGELO, TEX. 1st-3d Wed., Eagles' Hall.
J. H. Dozier, Pres., cor. Ave. I and Sam St.
R. L. Wright, C. S., 27 West Ave.
- 568—TACOMA, WASH. Maccabee Hall, 1109½ C St., 2d-4th Thurs.
Chas. Manning, Pres., 5808 S. Lawrence St.
A. W. Rickett, C. & F. S., 920 So. 9th.
- 570—HIGH SPRINGS, FLA. H. A. Smith, Pres., P. O. Box 273.
F. C. Magerstaadt, C. S.
- 571—DE PERE, WIS. De Both Hall, 1st Sun.-3d Wed.
T. J. McDonald, Pres., Lock Box 44, W. De Pere, Wis.
A. B. Steinfeldt, R. S., P. O. Box 207.
- 573—LANSFORD, PA. Wm. J. Williams, C. S., 843 East Ridge St.
- 575—VILLA GROVE, ILL. 1st-3d Fri., Red Men's Hall.
H. Downer, Pres.
A. Welch, C. S., Box 152.
- 576—WICHITA FALLS, TEX. 2d-4th Thurs., Labor Hall.
J. H. Gibson, Pres., 309 Lee St.
C. K. Matthews, C. & F. S., Box 760.
C. H. Shoemaker, B. A., Box 18, Healdton, Okla.
- 577—CUMBERLAND, MD. J. L. Teets, 14 Arch St.
- 578—HAGERSTOWN, MD. Moose Hall, 2d-4th Thurs.
L. J. Murray, Pres., 25 Vine St.
Fred H. Stouffer, C. S., 817 Summit Ave.
- 579—KEYSER, W. VA. 1st-3d Tues., City Building.
W. E. Wolf, Pres., Gilmore St.
P. R. Douglass, F. S., Gilmore St.
Joseph F. Hines, C. S., Piedmont, W. Va.
- 581—MONTPELIER, O. 1st-3d Wed., Ry. Trainmen's Hall.
S. Brown, Pres.
J. Bermingham, C. S.
- 582—BATON ROUGE, LA. 2d-4th Thurs., Odd Fellows' Hall, 3d St.
W. P. Kidd, Pres., 302 St. Phillip St.
S. W. Acosta, C. & F. S., 918 St. Ferdinand St.
- 583—NEVADA, MO. Socialist Hall, Hall, So. Main St., 1st-3d Thurs.
A. C. LeQuellec, Pres., 520 E. Cherry.
L. E. Whitehead, C. & F. S., R. F. D. No. 1.
C. A. McDonald, B. A., 4416 Norledge, K. C., Mo.
- 584—LUDLOW, KY. 1st-3d Thurs. Morley Hall.
Thos. Jackson, Pres., 17 Pherry.
H. J. Stroer, C. S., 833 Main, Covington, Ky.
- 585—BOSTON, MASS. 1st Thurs., 8 p. m., and 3d Sun., 2:30, Hemstead Hall, 724 Washington St.
Wm. E. McNabb, Pres., 263 Chelsea, E. Boston, Mass.
Daniel B. McInnes, C. S., 288 Marginal Ave., E. Boston, Mass.
Daniel N. Benerson, B. A., 17 Bul-lard, Dorchester, Mass.
James Vincent, F. S., 615 E. 6th, So. Boston, Mass.

- 586—SLATER, MO.** 2d-4th Mon., I. O. O. F. Hall, Chas. Crawford, Pres. Andy Phelps, C. & F. S.
- 587—BEAUMONT, TEX.** 2d-4th Thurs., Trades Assembly Hall, M. J. Ickles, B. A., 249 College. O. H. Greer, Pres., Box 149. T. C. Maddy, F. & C. S., 229 Fulton.
- 588—CHICAGO, ILL.** 2d-4th Tues., Koop's Hall, California & North Ave. Thomas Godfrey, Pres., 930 E. 44th St. John McNaney, C. & F. S., 2613 Iowa St.
- 589—MILWAUKEE, WIS.** 2d-4th Thurs., 923 E. Water St. Chas. Pable, Pres. M. J. Gleason, C. & F. S., 202 Michigan St.
- 590—MONROE, LA.** 1st Fri., 615 A St. J. W. Grant, Pres., 501 Wood St. J. J. Devereux, C. & F. S., 615 Calypso St.
- 591—GLENDDIVE, MONT.** 2d-4th Fri., Noderhoff Hall. V. B. O'Connor, Pres. & C. S., 317 Valentine St. J. J. Shinault, F. S., Gen. Del.
- 592—TULSA, OKLA.** 2d-4th Sat. 214½ S. Main. John Ingram, Pres., Gen. Del., Sand Springs, Okla. Wm. Carey, C. & F. S., Room 201 Union Labor Hall.
- 594—STANBURY, MO.** 2d-4th Tues., K. of P. Hall. John Inman, Pres. E. W. McNew, C. S.
- 595—AVERY, IDAHO.** 2d-4th Mon., Godfrey's Home, West Avery. A. Anderson, C. & F. S., Gen. Del.
- 596—CASPER, WYO.** 2d-4th Mon. B. F. Holliday, Pres. A. Doornbos, C. & F. S., Box 272.
- 597—ESCANABA, MICH.** 1st-3d Thurs., Lemmer Hall, Ludington St. Jos. Vickers, Pres., 506 Wells Ave. Wm. Grosnich, C. & F. S., 714 Wells Ave.
- 598—SALAMANCA, N. Y.** 1st-3d Mon., 3 Maple St. A. G. Frey, Pres., 165 E. State St. D. J. Carpenter, C. & F. S., 3 Maple St.
- 599—PARAGOULD, ARK.** 1st-3d Thurs., Carpenters' Hall. J. W. Frey, Pres., 321 S. 2d St. L. M. Bounin, C. & F. S., 310 W. Garland.
- 600—AKRON, OHIO.** Walsh Bldg. Jas. Shaughnessy, Pres., 876 So. Main St. R. C. Price, C. & F. S., 150 Adams St.
- 601—QUEBEC, CAN.** J. Thompson, Pres., 130 3d St., Simolion. G. Dery, C. S., 153 4th St., Larmorlow, Can.
- 602—GREAT FALLS, MONT.** 1st-3d Tues., Judge Safford's Court Room. Frank Yelocan, Pres., 1500 8th Ave. N. Roy J. Preston, C. & F. S., 706 8th Ave. So.
- 603—OTHELLO, WASH.** 1st-3d Mon., I. O. O. F. Hall. O. W. Bohusock, Pres. W. A. Clark, C. S., Box 137.
- 604—JOLIETTE, QUE., CAN.** H. Fournier, Pres., Gen. Del. W. C. Williams, C. & F. S., Box 235.
- 605—TOOELE, UTAH.** 1st-3d Tues. C. A. Blair, Pres. B. H. Sorensen, C. & F. S.
- 606—MORBRIDGE, S. D.** 1st-3d Thurs., Moose Hall. J. P. Schneickrath, Pres. H. L. Adams, Box 166.

International Officers of the Ladies' Auxiliary

- MRS. J. W. EDWARDS**.....President
1234 S. 9th East St., Salt Lake City, Utah.
- MRS. F. R. REINEMEYER** ...1st Vice-President
Tauromee Ave., Kansas City, Kans.
- MRS. MOLLIE GEARY**.....2nd Vice-President
6428 S. Albany St., Chicago, Ill.
- MRS. A. F. BINGHAM**.....Secretary-Treasurer
701 Lombard St., Springfield, Mo.
- L. A. 5—SALT LAKE CITY, UTAH.**
Mrs. J. W. Edwards, Pres. & C. S., 923 W. South Temple St.
Mrs. Lydia Smith, V.-Pres., 360 West 1 South St.
Mrs. J. C. Walton, F. S.
Mrs. Jane Foreman, Treas.
Mrs. Morton, R. S., 116 Markham.
- L. A. 7—SUNFLOWER, Parsons, Kas.** 2d-4th Tues. aft., Kennedy Hall.
Mrs. Dorothy Howell, Pres., 2531 Durr Ave.
Mrs. Anna Hawksworth, V.-Pres., 2303 Main St.
Mrs. Zita Rever, Treas., 1706 Gabriel Ave.
Mrs. Lillian Dudding, C. S., 2229 Crawford Ave.
Mrs. Lillian Van Vleck, R. S., 2701 Clark Ave.
Mrs. H. W. Smith, F. S., 2718 Chess Ave.
- L. A. 8—FRANKLIN, McComb, Miss., Ladies' Aux. Hall, Ave. F. East McComb.** 2d-4th Thurs.
Miss Lula Hassfield, Pres., R. F. D. No. 1.
Mrs. E. Sullivan, V.-P. & Treas., 725 Ave. F.
Miss Emma Sullivan, C. S., 725 Ave. F.
Miss Lulu Hassfield, R. S.
- L. A. 9—GRAND JUNCTION, COLO.**
Mrs. W. H. Holeman, Past Pres., 914 S. 5th St.
- Mrs. F. N. Davies, Pres. & Treas., 538 Ute Ave.
Mrs. J. W. Cox, C. & F. S. & V.-P., 925 S. 5th St.
Mrs. L. A. Turner, R. & S. T.
- L. A. 10—SPRINGFIELD, MO.**
Mrs. R. A. Linnis, Past Pres., 816 W. Atlantic.
Mrs. A. F. Bingham, Pres., 701 Lombard St.
Mrs. Ira Fowler, V.-Pres., 821 W. Brower.
Mrs. Wm. Specht, C. & F. S., Route No. 6.
Mrs. C. S. Gilliland, R. S., 1915 Johnson Ave.
Mrs. G. M. Scott, Treas., 1015 Locust St.
Mrs. C. A. Pachehofer, Chaplain, 36 W. Calhoun.
Mrs. W. Sharp, Marshal, 634 Smith St.
Mrs. Harry Jeans, Conductress, 1246 Broad.
Mrs. W. C. Connert, Inside Guard, Route 7.
Mrs. Henry Beckley, Mrs. C. S. Gilliland and Mrs. Wm. Sharp, Trustees.
- L. A. 11—LONE STAR, Palestine, Texas, Labor Temple, 2d-4th Tues. afternoons.**
Mrs. Frances Brunson, Pres., 15 Cottage Ave.
Mrs. Helen Redus, V.-P., 106 Queen St.
Mrs. Florence Payne, R. S. & Treas., 212 Palmer Ave.
- Mrs. Willie Welch, C. & F. S., 511 Green St.
- L. A. 12—GARFIELD PARK, Chicago, Ill., 1st-3d Sat., 3 p. m., Garfield Park Hall, 4039 W. Madison.**
Mrs. Maud Reinemeyer, Past Pres., 111 W. Chestnut St.
Mrs. Mollie Geary, Pres., 1535 W. 61st St.
Mrs. E. Farrell, V.-P., 4118 Carroll Ave.
Mrs. Helen Hughes, Cor. & Rec. Sec., 716 N. Avers Ave.
Mrs. Mary Driscoll, Fla. Sec. & Treas., 4135 Carroll Ave.
- L. A. 14—TOLEDO, O.**
Mrs. E. Richardson, Pres.
Mrs. Allen Thomson, V.-Pres.
Mrs. C. F. Haga, R. S.
Mrs. C. J. Sugrue, C. & F. S.
Mrs. Carrie Stephan, Treas.
Mrs. Louise Brown, Conductress.
Mrs. Lena Kern, Inspectress.
- L. A. 15—SAPULPA, OKLA.**
Mrs. Cora Johnson, Pres.
Mrs. Myrtle Clifton, V.-Pres.
Mrs. Addie Allen, R. S.
Mrs. Beattie Lewis, C. S.
Mrs. Hester Chapman, F. S.
Mrs. Ethel Edwards, Treas.
Mrs. Hettie Rondon, Chaplain.
Mrs. Ferrel Wells, Conductress.
Mrs. Emma Davis, Inside Guard.
Mrs. Katie Hoover, Marshall.
Trustees—Laura Cargill, Mrs. Emma Davis, Mrs. Addie Allen.

Boilermakers' Lodges by States.

Alabama.
 Birmingham . . . 4
 Montgomery . . . 443
 Selma 312
 Sheffield 344
 Whistler 511

Arizona.
 Miami 187

Arkansas.
 Harrison 138
 Little Rock . . . 68
 McGhee 106
 Paragould 599
 Pine Bluff 68
 Van Buren 521

Canada.
Calgary.
 Alberta 392
 Ft. William, Ont. 505
 Hamilton, Ont. 421
 Joliette, Que. . . 604
 McAdam Jct. . . . 379
 Moncton N.B. . . . 378
 Montreal 134
 Moose Jaw, Sask. . . . 478
 North Bay, Ont. 417
 Quebec 601
 Revelstoke 466
 Riviere du Loup, Que. . . 398
 St. Thomas, Ont. 413
 Toronto 548
 Transcona, Man. 529
 Winnipeg, M. . . . 126
 Winnipeg, M. 451

British Columbia.
 Vancouver 194
 Victoria 191

California.
 Los Angeles. . . . 92
 Oakland 233
 Pt. Richmond. . . 317
 Sacramento 94
 S. Francisco. . . . 25
 S. Francisco. . . . 205
 S. Francisco. . . . 410
 Vallejo 148

Colorado.
 Alamosa 446
 Colorado 136
 Denver 179
 Grand Jct. 335
 Pueblo 44
 Salida 427
 Trinidad 390

Connecticut.
 Hartford 237
 New Haven. . . . 61

Delaware.
 Dist. of Columbia
 Washington 450

Florida.
 High Springs. . . 570
 Jacksonville . . . 20
 St. Augustine. . . 230
 Sanford 573
 Sanford 422

Georgia.
 Atlanta 2
 Augusta 108
 Cedartown 510
 Columbus 428
 Fitzgerald 503

Maton 12
 Savannah 26
 Waycross 425

Idaho.
 Avery 595

Illinois.
 Alton 483
 Bloomington . . . 155
 Chicago 1
 Chicago 39
 Chicago 220
 Chicago 227
 Chicago 454
 Chicago 434
 Chicago Hts. . . . 254
 Chicago 588
 Danville 22
 Decatur 447
 Freeport 284
 Joliet 93
 Kewanee 195
 Mattoon 224
 Moline 377
 Peoria 60
 Murphysboro . . . 524
 Springfield 81
 E. St. Louis. . . . 363
 Urbana 150
 Villa Grove. . . . 575

Indiana.
 Bedford 541
 Evansville 95
 Ft. Wayne 54
 Garrett 79
 Hammond 356
 Indianapolis . . . 10
 Lafayette 360
 Peru 384
 Princeton 334
 Terre Haute. . . . 246
 Washington 241
 Wabash 324

Iowa.
 Belle Plaine. . . . 440
 Boone 161
 Cedar Rapids. . . 144
 Des Moines. . . . 47
 Dubuque 15
 Marshalltown. . . 149
 Mo. Valley. 145
 Sioux City. 244
 Valley Jct. 491
 Waterloo 133

Kansas.
 Atchison 507
 Coffeyville 542
 Ft. Scott 286
 Goodland 393
 Herington 340
 Holsington 408
 Horton 199
 Kansas City. . . . 83
 Neodesha 418
 Osawatomie 82
 Parsons 292
 Pittsburg 221
 Pratt 523
 Wichita 543
 Wichita 518

Kentucky.
 Covington 537
 Covington 364
 Louisville 40
 Ludlow 584
 Paducah 137
 Somerset 419

Louisiana.
 Baton Rouge. . . 532
 New Orleans. . . . 37
 New Orleans. . . . 428
 Shreveport. . . . 322
 Algiers 206
 Monroe 590

Maryland.
 Cumberland 332
 Cumberland 577
 Baltimore 193
 Hagerstown 578

Massachusetts.
 Boston 250
 Boston 431
 Boston 535
 Cambridge 535
 Dorchester 574
 Greenfield 517
 Lowell 371
 Norwood 281
 Springfield 218
 Worcester 492

Michigan.
 Bay City 67
 Detroit 169
 Escanaba 597
 Grand Rapids . . . 84
 Jackson 64
 Marquette 236
 Saginaw 124

Minnesota.
 Brainerd 116
 Duluth 165
 Meridan 320
 Minneapolis 11
 St. Paul 3
 Two Harbors. . . . 437
 Winona 201

Mississippi.
 McComb City. . . . 315
 Meridan 320
 Vicksburg 58
 Water Valley. . . . 300

Missouri.
 Brookfield 354
 Cape Girar. 430
 Geau 531
 Chaffee 531
 De Soto 117
 Hannibal 353
 Kansas City 32
 Moberly 267
 Monett 546
 Nevada 553
 Sedalla 113
 Springfield 70
 Springfield 530
 Slater 586
 St. Louis 27
 St. Louis 51
 St. Louis 276
 St. Louis 322
 St. Joseph 31
 Stanbury 594
 Sugar Creek 90
 Trenton 346

Montana.
 Anaconda 80
 Deer Lodge 528
 Glendive 591
 Great Falls. . . . 602
 Harlowton 41
 Havre 367
 Livingston 123
 Miles City 520
 Missoula 111
 Butte 130

Nevada.
 Sparks 339

Nebraska.
 Chadron 109
 Fairbury 439
 Falls City 565
 Grand Island. . . . 475
 North Platte. . . . 118
 Omaha 38

New Hampshire.
 Concord 245
 Portsmouth 467

New Jersey.
 Elizabeth 176
 Hoboken 163
 Jersey City 16

New York.
 Albany 197
 Brooklyn 45
 Elmira 225
 Mechanicsville 338
 Middletown 400
 Norwich 396
 Oneonta 414
 Oswego 175
 Rochester 229
 Salamanca 598
 Staten Island. . . . 200
 Syracuse 157
 Troy 73
 Utica 223
 N. Y. City. 21

North Carolina.
 Raleigh 173
 Rocky Mount. . . . 289
 Salisbury 226

North Dakota.
 Devils Lake. . . . 479

Oklahoma.
 Muskogee 504
 Okla. City 556
 Sapulpa 449
 Shawnee 293
 Chickasha 323
 El Reno 522

Ohio.
 Akron 600
 Canton 301
 Chillicothe 135
 Cincinnati 105
 Cleveland 5
 Columbus 8
 Conneaut 355
 Elmwood 91
 Place 509
 Jackson 509
 Lima 259
 Middleport 549
 Montpelier 581
 Newark 92
 Niles 275
 Portsmouth 402
 Springfield 18
 Toledo 85
 Van Wert 409

Oregon.
 La Grand 553
 Portland 72

Panama.
 Empire, C. Z. 463
 Cristobal 471

Pennsylvania.
 Carbondale 547
 Connellsville 444
 Galeton 438
 Lansford 578
 New Castle. . . . 493
 Philadelphia 341
 Pen Argyl 140
 Pittsburgh 154
 Pittsburgh 318
 Philadelphia. . . . 19
 Pottsville 256

South Carolina.
 Charleston 50
 Columbia 235
 Florence 424

South Dakota.
 Huron 496
 Mobridge 606

Tennessee.
 Bristol 435
 Copperhill 453
 Jackson 88
 Knoxville 143
 Memphis 189
 Nashville 42
 Chattanooga 14

Texas.
 Amarillo 331
 Beaumont 587
 Big Spring 423
 Childress 382
 Dalhart 476
 Dallas 86
 Denison 209
 El Paso 216
 Ft. Worth 96
 Galveston 132
 Houston 74
 Kingsville 287
 Marshall 107
 Mart 222
 Palestine 464
 Sherman 458
 Port Arthur. . . . 305
 Smithville 265
 San Antonio. . . . 345
 Teague 502
 Terrell 469
 Tyler 486
 Waco 501

Utah.
 Helper 473
 Ogden 198
 Salt Lake City 103
 Tooele 605

Vermont.
 Lyndonville. . . . 481

Virginia.
 Alexandria 369
 Clifton Forge. . . . 238
 Newport News. . . . 55
 Norfolk 426
 Portsmouth 298
 Portsmouth 57
 Richmond 170
 Roanoke 30
 Roanoke 29
 Victoria 65

Washington.
 Bremmerton. . . . 290
 Everett 500
 Othello 603
 Spokane 242
 Seattle 104
 Seattle 489
 Tacoma 247
 Tacoma 568

West Virginia.
 Bluefield 405
 Elkins 278
 Gassaway 152
 Hinton 525
 Huntington 249
 Keyser 579
 Princeton 551
 Williamson 557

Wisconsin.
 Butler 589
 De Pere 571
 Green Bay 485
 Milwaukee 107
 Milwaukee 302
 N. Fond du Lac 395
 S. Kaukauna. . . . 311

Wyoming.
 Casper 596
 Cheyenne 46
 Evanston 309
 Laramie 48

By Insisting Upon Purchasing Union Stamp Shoes



You help better shoemaking conditions.
 You get better shoes for the money.
 You help your own labor position.
 You abolish child labor.

Do not be misled by retailers who say: "This shoe does not bear the union stamp, but is made under union conditions." This is false—no shoe is union made unless it bears the union stamp.

Boot and Shoe Workers' Union

246 SUMMER STREET, BOSTON, MASS.

JOHN F. TOBIN, President.

CHAS. L. BAINE, Sec.-Treas.

THE COMMERCIAL NATIONAL BANK

of KANSAS CITY, KANSAS.

CAPITAL AND SURPLUS, \$550,000.00.

DEPOSITS.....\$5,000,000.00

We cordially invite the Boiler Makers and Ship Builders of the United States who desire to transact banking business with us (which can be done readily by mail), to write to any of their officers and ask any questions they may desire to ask about our reliability and standing.

P. W. GOEBEL, President.

C. L. BROKAW, Cashier.

A. C. FASENMYER, Vice-President.

G. J. BISHOP, Asst. Cashier.

When Writing Advertisers

PLEASE MENTION

The Boiler Makers' Journal

Notice to Subscribers of the Journal

When members change their address, or do not receive Journal promptly, fill out the following blank and forward to the editor:

Name Reg. No. Lodge.....

Old Address, Street.....CityState.....

New Address, Street.....CityState.....

I have not received Journal for month of.....

KANSAS CITY, KAS., MARCH, 1915.

THE BOILERMAKERS JOURNAL

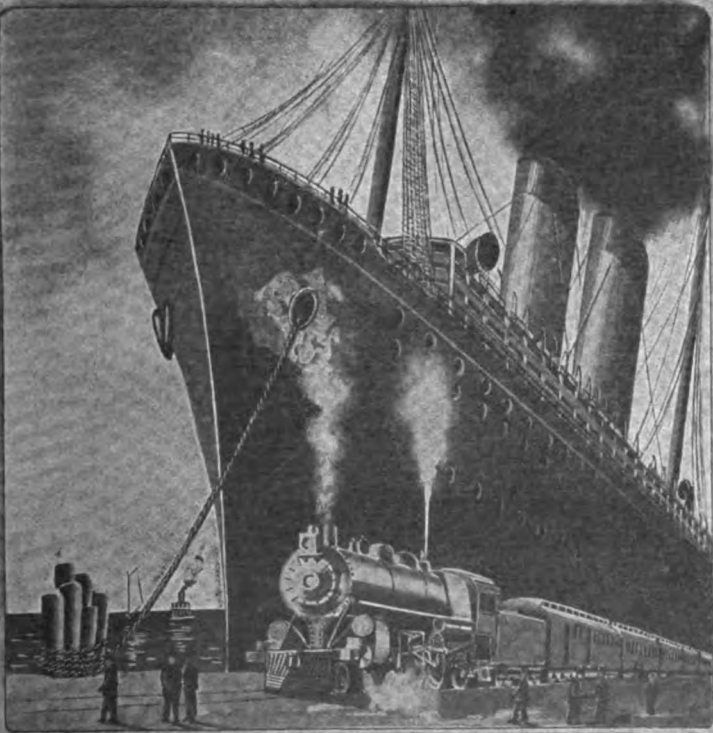

OFFICIAL ORGAN OF THE
INTERNATIONAL BROTHERHOOD
OF BOILERMAKERS, IRON SHIP BUILDERS
AND HELPERS OF AMERICA

HEADLIGHT UNION MADE OVERALLS

"A smile of satisfaction with every pair"

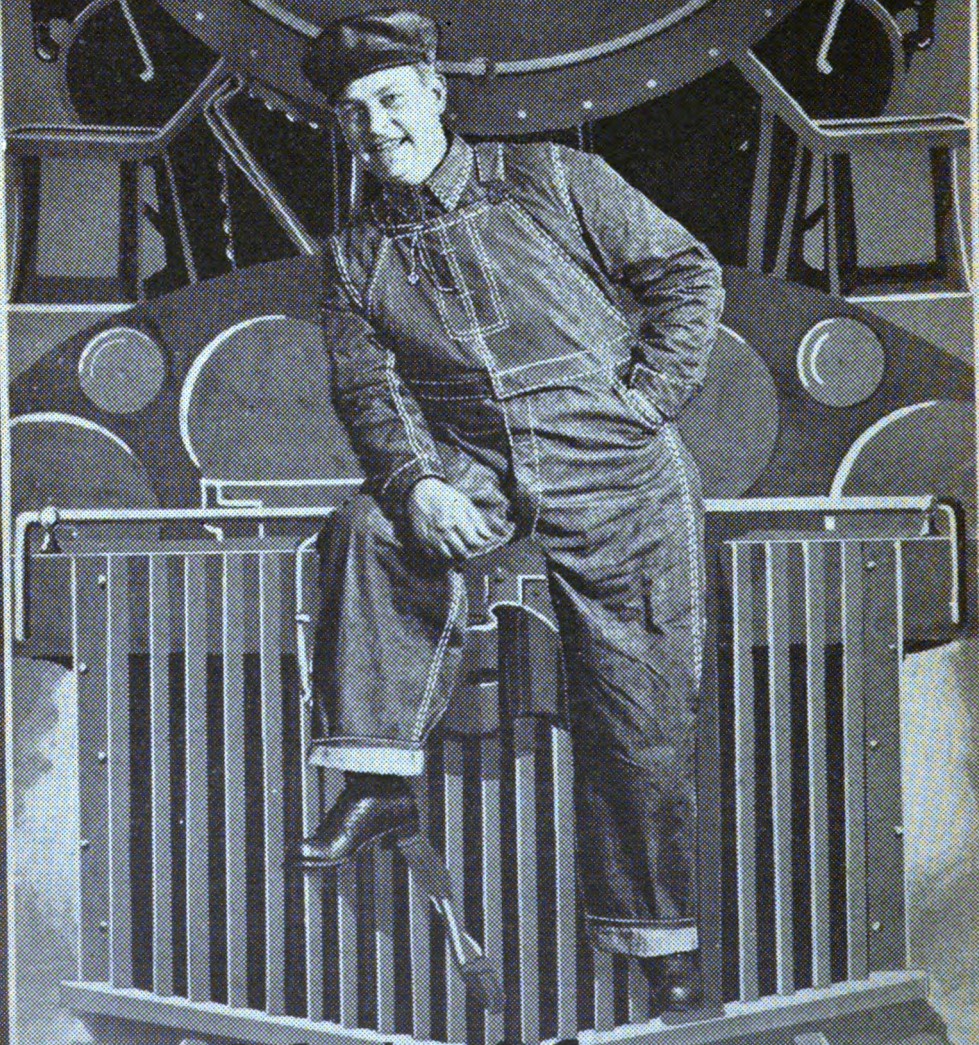

Larned Carter & Co. Detroit Mich
WORLD'S GREATEST OVERALL MAKERS
Factories Detroit, Pt. Huron Mich. St. Louis Mo. Sarnia Ont.

SECURITY SECTIONAL ARCH

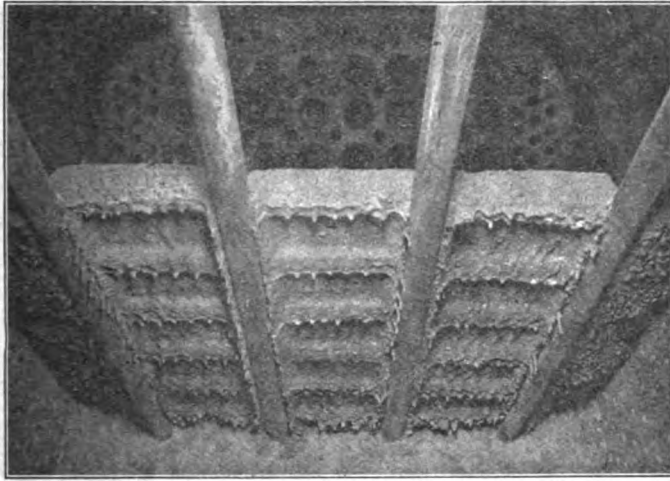

This arch is of light weight
It is built up of small sections
So made as to cool off quickly
It is easily removed for work
Made so to help the boilermaker

AMERICAN ARCH COMPANY

30 CHURCH STREET, NEW YORK

McCORMICK BUILDING, CHICAGO



Since the first railroads

Stifel's Indigo Cloth

Standard for over seventy-five years

has been the "old reliable" Over-all---Uniform---Shirt---Jumper---cloth for the "men of the road."

To three generations of railroaders it has demonstrated that *it's the cloth in the garments that gives the wear.* Stifel's Indigo wears like leather and looks good as long as it lasts.

Be sure you see this mark on the back of the cloth, *inside* the garments before you buy. It's your guarantee of the genuine Stifel Indigo.



Cloth manufactured by

J. L. STIFEL & SONS

Indigo Dyers and Printers. WHEELING, W. VA.

SALES OFFICES

NEW YORK.....	260-262 Church Street
BALTIMORE.....	114 W. Fayette Street
PHILADELPHIA.....	324 Market Street
BOSTON.....	31 Bedford Street
CHICAGO.....	223 West Jackson Boulevard
SAN FRANCISCO.....	Postal Telegraph Building
ST. JOSEPH, MO.....	Saxton Bank Building
ST. LOUIS.....	425 Victoria Building
ST. PAUL.....	238 Endicott Building
TORONTO.....	14 Manchester Building
WINNIPEG.....	400 Hammond Block
MONTREAL.....	100 Anderson Street



The Boilermakers' Journal

Official Organ of the
**International Brotherhood of Boilermakers
Iron Ship Builders and Helpers of America**

Vol. XXVII.

KANSAS CITY, KAS., MARCH, 1915.

No. 3.

THE DANGER OF SHIFTING DUTIES.

By Samuel Gompers, in the Federationist.

Two methods have been devised for dealing with the wrongs and injustice that have been imposed upon the workers. Some have put their faith in party political action and have trusted the solution of labor problems to legislation. Others have based all action upon the principle that free workers must never delegate to outside authority ultimate control over determining conditions and terms of personal relations between employers and employes, but the workers themselves must assume responsibility for their own welfare.

Those who advocate the first method are the parliamentarians who propose to secure reforms through enacting laws to establish desired purposes. The laws must be made by the official lawmakers and enforced by the administrative agents of the state. The people vitally affected by the legislation have indirect control, if any, over the formulation and enforcement of the regulation. Responsibility for ultimate results is shifted.

Those who advocate the second method are the trade unionists who subordinate political action to economic activity. They hold that the key to industrial freedom, which is real freedom for the working people is maintenance of strong, virile, resourceful organizations, aware of their power and using it most effectively. They hold that unions which let go ultimate control over industrial welfare, stultify initiative, weaken the fighting force of the trade unionists, and hence undermine their power physically, politically and socially.

Events during the past year prove that legislation does not "settle" things, that legislative action not only is not final, but increases the difficulties that confront workers in controlling matters affecting their own interests.

The members of the organized labor movement of the state of Washington have been consuming their energies in efforts to have the economic demands, rights and privileges taken care of by state legislation. But now the president of the Washington State Federation of Labor, Mr. E. P. Marsh, laments the fact that the state now has the most reactionary legislature which it has seen in years. He states that labor is unable to take advantage of an unusual opportunity to establish a state system of em-

ployment agencies and makes this significant assertion: "We are going to have to fight as well to hold labor legislation now upon the statute books and to make our initiative machinery more workable than it is at present." These exponents of legislative action to secure the demands of workers, are finding out that a law secured at one session of the legislature may be absolutely undone at the next, and that many vexatious and vicious restrictions may be imposed upon workers by scheming politicians who, as officeholders in the legislature, are able to follow their own reactionary ideas or are susceptible to the blandishments of the oppressors of labor.

What the Washington workers have experienced has been the experience of the workers of Massachusetts. Only a few weeks ago Governor Walsh of Massachusetts had the temerity to recommend that the labor laws of Massachusetts be suspended so as to enable the industries to take advantage of the unusual opportunities afforded by the terrible European war. In order to serve the interests of the manufacturers the governor of the state urged the revival of the ancient practice that the Stuart rulers of England exercised under their claim to the divine right of kings.

When necessary and humane laws are threatened with repeal by reactionary legislatures and with suspension by reactionary governors, it is a vain hope to trust the industrial welfare of the wage-earners to legislation. And this has been the experience of the workers of all ages.

Turn the pages of the history of England back to the Fourteenth Century, when Parliament adopted the policy of fixing wages, hours of labor and conditions of work by legislative enactment or judicial decree. Nowhere are the facts concerning the Statute of Laborers or the effects of the statutes presented more forcibly or convincingly than in a statement made by Mr. Paul Scharrenberg, secretary of the California State Federation of Labor, before the joint committee of the senate and assembly of the California State Legislature, which had under consideration several bills providing for minimum wage for women. Mr. Scharrenberg brought out clearly the dangers and the difficulties of attempting to regulate by law conditions of work for employes. The English statutes, of course, fixed maximum

standards, but Mr. Scharrenberg very properly concluded that there is no difference in principle between fixing maximum and fixing minimum standards.

He showed that England found it impossible to enforce legislative or judicial regulations of wages, hours or conditions of work in opposition to the desires of the workers or the employers. Violations of the Statutes of Laborers led to legislation declaring that a combination to raise wages or reduce hours of labor was a conspiracy. There was extension of the judicial machinery to enforce these laws and punish the "offenders." The powers of the courts were increased. Punishments for violating the laws were made increasingly drastic—but in vain. The economic laws of industry and enlightened self-interest prevailed over every effort to impose restrictions and burdens upon the wage workers. But those restrictions and burdens made progress many fold more difficult—needlessly difficult.

The English workers found that organization into aggressive, virile trade unions was necessary to free the workers from the fetters that legislation had fastened upon them, and to enable the workers to secure for themselves better conditions of work, higher wages and a shorter workday.

The lessons of English history, as well as the recent happenings in American states, raise fears as to the future of those workers who put their trust in laws to secure for workers higher wages, a shorter workday and better conditions of work.

The trade union movement of America has just finished one great stage in the effort to free the workers of America from legislation that hindered their efforts and activities to protect and advance their own interests and to work out their own welfare. The labor sections of the Clayton Act secure to the workers industrial freedom and give them the legal right to collective economic activity.

Is it wise then for the workers to jeopardize that industrial freedom by seeking to secure legislation establishing hours of work or minimum standards of pay? Administration of law is entrusted to political agents. There is no guarantee that standards or administrative acts determined by political agents will always be for the best interests of the workers. On the other hand, there is reason to fear that they will jeopardize the best interests of labor.

Free, enlightened men and women cannot submit tamely to that which they know will injure them and those who shall come after them. Does it take any great imagination to foresee that machinery for coercion will follow upon the footsteps of legislative or administrative determinations of the conditions of work and relations between employes and employers? May not combinations to secure changes in minimum standards be judicially declared "conspiracies" just as were combinations against maximum standards? Is there any guarantee that reactionary lawmakers or lawmakers subservi-

ent to the interests will not endanger the welfare of the workers by vicious legislation of that nature?

Let the workers keep in their own hands and under their immediate control regulation of matters that vitally affect industrial welfare. Organizations of workers aware of their own interests and alert to further that which promotes their own welfare are more capable of steadily securing wider opportunities and better things than any outside agents to whom this responsibility can be delegated. The way to industrial betterment and progress and freedom lies in our well-tried policy—Educate! Agitate! Organize!

TO FIGHT TUBERCULOSIS AMONG WORKINGMEN.

Realizing that the problem of the control of tuberculosis is closely linked with the problems of the workingmen of the United States, The National Association for the Study and Prevention of Tuberculosis has inaugurated a movement for closer co-operation with labor unions.

A committee has been appointed with Dr. Theodore B. Sachs of Chicago as chairman, to formulate plans for immediate and future action. Other members of the committee are Mr. Samuel Gompers of Washington, Mr. George W. Perkins of Chicago, Mr. John Mitchell of New York, Mr. Austin B. Garretson of Cedar Rapids, Iowa, Dr. William Charles White of Pittsburg, and Dr. David R. Lyman of Wallingford, Conn.

As the first step in the campaign, a special health bulletin has been prepared for the labor papers, and will be sent out monthly in co-operation with the members of the International Labor Press Association. These bulletins will contain articles of interest relative to the co-operation of labor unions in the anti-tuberculosis and public health movements; notes concerning the prevalence and prevention of certain diseases, especially those of an industrial character; and rules and suggestions on personal and community health.

A second step in the plan is an investigation into the various special experiments of co-operation between workingmen and the anti-tuberculosis campaign that have been carried on. Such work as that of the Tuberculosis Relief Association in Hartford and other Connecticut cities; the Trades Union Sections of Buffalo and Newark Anti-Tuberculosis Associations; the Tuberculosis Pavilion of the Albany Federation of Labor; and other similar efforts will be studied and reported upon.

At the recent Philadelphia meeting of the American Federation of Labor, a resolution (No. 51) was adopted endorsing the educational work of The National Association for the Study and Prevention of Tuberculosis and calling upon all officers and unions to help in promoting this work. The International Typographical Union adopted a similar resolution (No. 76).

THE BOILER MAKERS' JOURNAL

Official Organ of the International Brotherhood of Boiler Makers, Iron Ship Builders and Helpers of America.

A Monthly Publication Issued the First of Each Month from Room 8, Law Building, Kansas City, Kansas.

JAMES B. CASEY, Editor and Manager.

Subscription Price.....\$1.00 Per Year in Advance

ADVERTISEMENTS.

Advertising Rates Will be Furnished Upon Application to the Editor-Manager. No Reading Space Will be Sold for Advertising Purposes Under Any Circumstances.

All New Members Must Have Their Name and Address Sent in Through the Secretary of Their Lodge. After That They May Have Changes Made in Their Address by Filling Out Blank Form in Back of Book and Forwarding to the Editor.

All Copy Must be Received by the Editor by the 15th of the Month to Insure Publication in the Following Issue.

All Contributions and Correspondence Relating to the Journal, Should be Addressed to J. B. Casey, Editor, Room 8, Law Building, Kansas City, Kansas.

Entered at Postoffice, Kansas City, Kansas, as Second Class Mail Matter.

MORE FINANCIAL BENEFITS NEEDED.

While the policy of our organization for the past few years has been to increase the amount of financial benefits paid to our members and enlarge the scope or character of benefits provided, still there is another kind of benefit needed and that is sick benefits. Quite a number of incidents have come under our observation recently which unmistakably shows this necessity. For instance, many of our members become incapacitated for work through sickness or disease; they need the services of a doctor or possibly a surgeon; they should go to the hospital and take a regular course of treatment, and through one thing or another they have failed to save up anything for a rainy day. Under these circumstances it would be a great benefit to our members to be entitled to six or seven dollars a week. Were such a benefit available at the present time, we know of a number of cases in different sections to whom it would prove a real boon.

Therefore, our members should begin to study out a workable plan between now and our next convention. If such a feature should be adopted it would have to be guarded by positive laws and regulations as too often our members show a disposition to burden the Grand Lodge with a claim for one thing or another, which they would not think of asking of their local lodge. In other words they seem to think the Grand Lodge is something separate and apart from them, and therefore a fit subject to be mulced whenever possible. This, of course, is a fallacy; it is the combined strength and resources of all lodges and what affects its financial condition will speedily affect all of the lodges and through these the members.

It might be well for our members in a brief way to give an expression on the subject of benefits. At least as far as the general principles of sick benefits are concerned. We are not limited as to the possibility or extent of our benefits, our members can continue to add to those we have already provided until we provide against every adversity that may overtake us.

A LARGE AND SUCCESSFUL ENGINEERING FEAT COMPLETED

Associated Press dispatches recently announced the completion of a tunnel through the Cascade Mountains in Washington, which was cut through two and one-half miles of solid rock. The job was started back in 1912 and since the job started not a single life was lost. This is the most remarkable part of the whole feat, as jobs of this kind in the past was usually accomplished at the sacrifice of scores of lives.

The tunnel is on the Milwaukee Railroad, forty miles east of Seattle, and is known as the Snoqualmie. It has a concrete lining throughout and cost \$2,000,000. The completion of this tunnel will greatly reduce snow troubles and lower the cost of operation by lessening the grade, and consequently the number of extra engines previously required to negotiate a 443-foot rise and fall in sixty miles of track. Those in charge of the job are deserving of much praise for the efficient manner in which the job was completed.

AN UNWARRANTED DECISION.

The Supreme Court of the United States recently declared the Kansas anti-blacklist law unconstitutional. This law had for its purpose the protection of men who belonged to trades unions and prevent their being victimized by railroads because of their membership. This law was invoked in behalf of a switchman in the employ of a certain road in Kansas which ordered him to give up his membership in the Switchmen's Union under pain of dismissal. The road was convicted of violating this law, and appealed the case until it reached the Supreme Court with the above result. These wise Solomons no doubt tried to establish some new principles of law. They evidently, or at least, a majority of them did not grasp the principles for which organized labor stands, or its necessity for the protection of workingmen. However, we need not be surprised, as it was this same court which only recently upheld the verdict of the Federal District Court in awarding triple damages to a Danbury hatter because his employes went on strike against his unfair dealings, and it was this same court which a little further back tried to write into the anti-trust laws the word unreasonable a clear usurpation of power, as Congress did nor intend such a limitation.

The trouble with this court is the same as with the other Federal courts, the manner of their appointment and for life. They must be selected in a different manner and for a stated period, if their decisions are to be made responsive of the people's opinion. Under the present laws, after these judges are appointed by the president and confirmed by the Senate they are not amendable to any one, not even those who appointed and confirmed them, and the only way to discipline them is to impeach them by the House with the Senate acting as a court. It seems to us these decisions are rendered in order to arrest the growth and power of trade unionism. However, they can only arrest its progress, they cannot prevent its ultimate success. Another way will be found to protect men in their right to join unions.

A CONGRESSMAN CHARGES GOVERNMENT WASTE IN BUYING ARMOR.

According to Congressman Tavenner the U. S. Government is wasting millions of the people's money in buying armor and supplies from contractors rather than manufacture these by the Government. He charges that in 1913, 7,000 4.7 inch sharpnel shells were purchased at a cost of \$25.26 each, while at the same time these shells were being manufactured at a government owned plant for \$15.45 each, a difference of nearly ten dollars on each shell.

However, it is in armor plate that this Government has been held up and unmercifully robbed, the contractors can charge what they please for we have no government owned armor making plant. It is estimated that in the last twenty years the Government has spent \$175,000,000 for armor. If a Government plant had been in operation, one-half of this amount could have been saved. The present administration seriously talked of putting up a plant a couple of years ago, but nothing came of it, and we are still being robbed of millions by these contractors.

SOUTHERN PACIFIC MUST SELL SHIPS.

According to a recent press dispatch from Washington, the Interstate Commerce Commission has renedered a decision to the effect that the Southern Pacific Railway must sell its stock and holdings in the Pacific Mail Steamship Company, within sixty days or the latter must cease operating its vessels through the Panama Canal.

The Commission rules that it would be illegal for the ships of this company to operate through the canal, because a part of its stock and bonds are held by the Southern Pacific. It seems this company not only has a monopoly of the traffic on land along the Pacific coast, but that it also has nearly the same condition on water.

THE UNITED STATES SHOULD BE PREPARED.

We are among those who sincerely hope that eventually mankind will find some means of preventing warware being engaged in between civilized nations and that all will prevent any nation from taking any advantage of another nation, and that peace, good will and prosperity will reign on indefinitely throughout the world.

The awful conflict that has raged unceasingly since last August among most of the European nations, in which millions of men have been killed, wounded or captured, and millions of others have endured all kinds of tortures, and for what? Nothing! Each one blames the others, nevertheless they are engaged in a death struggle and neither will give in until completely exhausted. This is likely to have a far reaching effect, not only on the nations engaged, but the other white races of the world by destroying the equilibrium of the nations, and as a result tempt the hordes of Asia to again seek the conquest and supremacy of the world, as it did from the beginning of ancient Grecian civilization, on down through the different periods of the

Roman republic and into the fifteenth century when the Turkish hordes swept over half of Europe and finally spent its force around the Bosphorus and the Balkan peninsulas and established itself in Constantinople as its capital.

We see signs in the far East that prompts us to believe history will again repeat itself unless its development is arrested. With most of the larger nations of Europe at each other's throat, they have not the time or means to watch for distant dangers or enemies and the United States would have to bear the lion's share of a contest of this kind should it arise.

Furthermore there is a serious condition of anarchy existing to the south of us in revolution swept Mexico. This is another serious condition fraught with danger, then the possibilities of becoming involved in some way with the warring nations of Europe is plainly evident. Therefore, we believe it is but the part of wisdom for this nation to make preparations necessary to meet any eventuality that may arise, for in modern warfare, the nation which is prepared would come near destroying their opponents before they could get started. We do not believe in raising a large standing army, but our navy should be added to and strengthened until we could cope with any nation in the world on sea, and much larger quantities of ammunition, supplies, equipment, cannon and other arms should be gotten together and kept ready for use at short notice.

Some claim the organization of our army is very imperfect and that it has grave deficiencies, whether this is true or not, remains to be seen, but they should be promptly investigated and if necessary, a remedy applied, and a plan should be worked out for the building up of a reserve army that could be mobilized on short notice if necessary.

A policy of preparedness would, in case of war, save hundreds of thousands of lives, for a trained army of men would be available who would know how to fight and defend themselves, without needless loss of life, as would be the case if green recruits were sent to battle against a trained army. The latter were taught the science of warfare in time of peace, while the untrained army would have to learn the matter under fire, and while thousands of their comrades were being slaughtered around them.

Let us by all means avoid war if it can be done consistent with our honor and interests, but let us diligently set about getting prepared to meet any danger that may arise. If nothing arises that will require the use of our supplies or preparation we will be compensated by the sense of security it will give us, and will compensate us for the extra efforts made in getting them ready.

WE SHOULD DO MORE THAN ESTABLISH EMPLOYMENT BUREAUS.

While the Department of Labor and Federal Industrial Commission have promised an elaborate plan for connecting the man and the job, still it

seems to us we should go further than this and arrange for insurance against non-employment and sickness, for at best the free employment bureaus will only aid a portion of our people in times of depression in trade and in acute and protracted cases like we have been going through for some time, employment agencies have not been of much assistance, and thousands have been looking for work in vain. A matter of this kind could only be handled by the National Government. We believe a scheme of this kind could be worked out and made almost self-sustaining.

Let us hope our law makers will take up this problem and endeavor to solve it.

RAILROADS STILL TAKE HEAVY TOLL IN KILLED AND WOUNDED.

According to a Commerce Commission report for the year 1914, 9,893 persons were reported killed and 79,388 persons were reported injured by railroads last year. There were 13,806 railroad wrecks during the same period, in which 605 persons were killed and 11,437 were injured, and a property loss of \$10,965,181 was sustained. This seems to be an awful price to have to pay in order to have our railroads run for a year; and this too, after the safety first campaign has been so widely advertised, and the number of safety appliances that have been put into use, these should have reduced this army of crippled and maimed persons. At this rate how long will it take to make us a nation of cripples?

CONGRESS SEEKING TO PREVENT CHILD LABOR.

Organized labor has for years been pleading before state legislatures for legislation preventing the working of children of tender years in mine, factory or workshop. While some legislatures have at last given reluctantly some laws in reference to this matter, in no state is it effective, and such laws as they have regulating child labor seemingly is violated with impunity. However, Congress seems inclined to take a hand in the matter, as the House recently passed the Palmer bill which makes it "unlawful for producers, manufacturers or dealers to ship or deliver for transportation in interstate commerce the products of mine or quarry made wholly or in part by children under 16 years of age, or products of mills, canneries, workshops, factories, manufacturing establishments made by children under 14 years of age or those between 14 and 16 who work more than eight hours a day or more than six days a week or after 7 o'clock at night."

Let us hope the Senate will pass this measure also, for while it may not be perfect, still it will go a long ways towards eradicating this evil, which in some sections of the country threaten to sap the vitality of future generations.

FLUCTUATIONS IN EMPLOYMENT THE PROBLEM OF TODAY.

One of the most potent factors responsible for the extensive dissatisfaction and misery that prevails today arises from unemployment, fluctuations in the demand for workmen brings this about, and this dread of being thrown out of work—the uncertainty of continuous employment has a deadening effect upon the industry of the people. It is one of the great problems that confront mankind at the present and which must be solved before we can have permanent peace and prosperity.

Many investigations along different lines are being made with the hope of finding the correct solution. All these give hope of better conditions for the future.

Of course we are passing through a tremendously abnormal condition at the present time, due to the European war. There was never a time before in the history of mankind when the devastating hand of war extended over such a great expanse of territory or involved at one time so many millions of people. This condition was not long in destroying commerce and trade and paralyzing industry in all things except war supplies and engines of warfare. While business is gradually adjusting itself to the changed condition, still it is a long way from normal.

It seems to us the government—national, state, county and city—which contemplates doing work any ways soon should hasten to start without delay. Now is the time when new work, no matter of what nature, will do good towards relieving unemployment. However, government agencies should continue to search for a remedy. Steady employment for everyone is necessary for prosperity and contentment. If continuous employment cannot be guaranteed to everyone, we can at least arrange some form of insurance that will guarantee us against the evils of unemployment. If this is accomplished, it will result in removing dissatisfaction and increase industry and thrift; more and more would be induced to save in order to acquire a home and a little to lay aside for a rainy day.

THE STRIKE IN THE OIL FIELDS.

From all reports, there is no material change in the strike situation in the oil fields since our last report. Some of the contractors have tried to introduce strike breakers, but without apparent success. No competent men have been secured, and as a consequence what work was done has been condemned by the inspectors.

A number of conferences with the Labor Commissioner of Oklahoma have been held. President Franklin visited the field for that purpose, but so far no tangible results have been accomplished, due to the vacillating policy of the contractors. However, we believe most of the contracts unfinished have a time limit placed upon them and the contractor will soon be forced to come to terms.

A TALK WITH OUR MEMBERS.

We have been having for some time a gratifying increase in our correspondence. It is a healthy sign, as it shows our members are interested in the Journal; that they read what others write and take the trouble to write themselves. We hope our members will continue to take an ever-increasing interest and that a still larger number will write for it. However, there is a request that we desire to make, and that is to avoid personalities and subjects that will cause a controversy and argument. We have so far been free from all such and we hope to continue along this line. When we took hold of the Journal as editor, it was our ambition to build it up to a high standard of usefulness to our members as an educator and a disseminator of news of interest to the members of our trade. We determined to make it a valiant defender of the interests of our members, our organization and the trade-union movement in general, and that nothing would be printed that would in any way wound the feelings of anyone, or anything of a smutty or questionable nature. We have rigidly adhered to that resolve and we believe it has produced good results. We are continually getting information that shows our members are interested in the Journal and are anxious to get a copy of each issue. Men in isolated points in every part of the country write for the issues they have missed. Many of them say, "Please send me the Journal; I am lost without it." One of our most efficient organizers wrote recently to request a bundle of Journals to be sent in time for a meeting he had arranged for the purpose of organizing a bunch of men, and remarked, "I repeat what I have said before: 'There is an awful lot of interest being manifested in the Journal.' I find it of much benefit in my organizing work." We mention these incidents not in a vain or conceited manner, but to show our members that our policy in keeping the Journal on a high plane has produced good results in helping to build up our organization and to show the importance of keeping on the same plane for the future.

A few of our members seem to think because the Journal is the property of the Brotherhood and they are members, that they are privileged to write and have published anything they may wish without let or hindrance from the editor, good, bad, indifferent or worse. While our organization may meet at stated periods and adopt laws and policies, these few members seem to think they are privileged to use the pages of the Journal to condemn what was done and to vilify and abuse those who were selected as International officers. Surely they cannot hope to accomplish any good by such a course; they would help to pull down rather than build up. Fortunately this kind of members are few in number and we hope they will grow less. If we would be successful as an organization, we must not lose sight of the fundamental principles upon which we are organized. The trade union is organized upon a neutral platform; it is an economic movement and has a well defined platform of principles upon which the members stand and it also has specific plans and policies for putting its principles into execution. Our membership is composed of men of all political and religious faiths.

None of us surrender our opinion on politics or religion when we join organized labor, nor are we asked to. All we do is to agree to conform to the platform and principles of organized labor. The organization that is wise will not attempt to pass beyond this neutral platform. In consonance with these principles the Journal was established for the purpose of advocating the principles of trade unionism and promoting the organization of our trade's and our members' welfare. Let us all show a united stand in this matter. We may not agree as to what our policies should be, but once adopted, we should all agree to abide by them until they come up again for review.

A few seem inclined to want the Journal opened to the discussion of political principles, and we might as well say now as any other time that so long as our laws concerning the Journal remain as they are at present, no discussion of partisan politics will be allowed, as our laws expressly prohibit it. Personally, we have no objection to our members belonging to any political party they desire, but as a member we would object to having our organization furnish the means of exploiting the ideas of any political party.

QUOTATIONS.

Hunting after arguments to make good one side of a question, and wholly to neglect those which favor the other, is wilfully to misguide the understanding; and is so far from giving truth its due value, that it wholly debases it.—Locke.

Goodness answers to the theological virtue charity; and admits no excess but error; the desire of power in excess caused the angels to fall; the desire of knowledge in excess caused man to fall; but in charity there is no excess; neither can angel or man come into danger by it.—Lord Bacon.

Were we as eloquent as angels, yet should we please some men, some women and some children much more by listening than by talking.—Colton.

Intellectual education now, to be worthy of the time, ought to include in its compass elements contributed to it in every one of the great epoch's of mental energy which the world has seen. In this respect, most especially, we are, if we know how to use our advantages, inheritors of the wealth of all the richest times; strong in the power of the giants of all ages; placed on the summit of an edifice which thirty centuries have been employed in building.—Whewell.

The man who will live above his present circumstances is in great danger of living, in a little time, much beneath them.—Addison.

It is almost as difficult to make a man unlearn his errors as his knowledge. Mal-information is more hopeless than non-information; for error is always more busy than ignorance. Ignorance is a blank sheet on which we may write; but an error is a scribbled one on which we must first erase. Ignorance is contended to stand still with her back to the truth; but error is more presumptuous, and proceeds in the same direction. Ignorance has no light, but error follows a false one. The consequence is, that error, when she retraces her footsteps, has farther to go, before she can arrive at the truth than ignorance.—Colton.

STRIKES NOW IN FORCE.

- Spokane, Wash., Union Iron Works. (Metal Trades strike on.)
- Farrer Traft Contract Shops, Buffalo, N. Y. (Strike on.)
- Illinois Central R. R. (Federated Trades strike on.)
- Harriman Lines. (Federated Trades strike on.)
- Pere Marquette R. R., Grand Rapids and Saginaw, Mich. (System Federation strike.)
- Contract shops, Mobile, Ala. (Metal Trades strike.)
- Boiler shops, Newport News Ship Building & D. D. Co., Newport News, Va. (Strike on.)
- Atlantic Basin Iron Works (Shields & Moran, New York.) (Strike on.)
- Hibbon & Co., contract shop, South Chicago, Ill. (Unfair.)
- Milwaukee Boiler Co., Milwaukee, Wis. (Strike on.)
- Stockton Calif. (Metal Trades strike.)
- Warren City Boiler & Tank Co., Warren, Ohio. (Strike on.)
- Standard Boiler & Plate Iron Co., Niles, Ohio. (Strike on.)
- Reeves Bros., Alliance, Ohio. (Strike on.)
- Hammond Iron Works, Warren, Pa. (Strike on.)
- The Petroleum Iron Works, Sharon, Pa. (Strike on.)
- The Treadwell Construction Co., Midland, Pa. (Strike on.)
- Riter-Conley Construction Co., Pittsburgh, Pa. (Strike on.)

Mechanical Department.

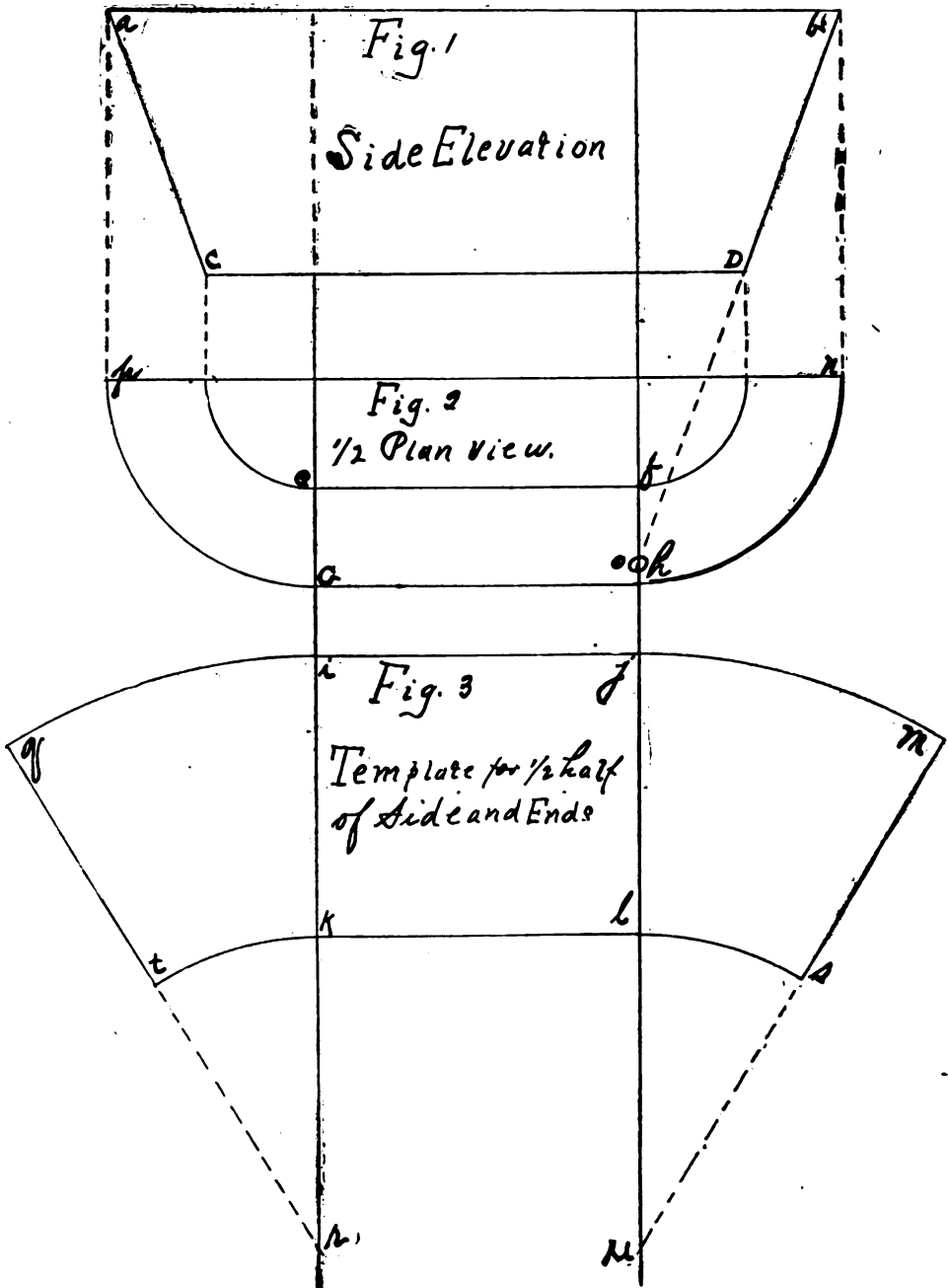

To lay out an oblong receptacle having tapering sides and ends. Fig. 1 gives the side elevation and Fig. 2 shows one-half of plan view. To lay out template for sides and ends, to be made in two pieces, with seams on ends, proceed as follows:

Lay out size and shape of one-half of

vessel, as shown in Fig. 2. Erect vertical lines, which divide sides from ends; erect side elevation, showing length and height, as in Fig. 1; bring down the line which marks end of vessel in Fig. 1 until it strikes vertical lines, as shown by dotted line, where the two lines cross is the apex of the cone

of which the end of vessel is one-half of frustrum. Strike the upper straight line of Fig. 3 between the two vertical lines; set trams to reach from B to O, place one point J and strike line at U, with point set at U strike circular line J N. Proceed in same manner for the opposite end; find length of curve line H-N, Fig. 2, and mark

off from J to M and I to Q, Fig. 3, strike lines M, S, U and Q, T, R; set trams at O and extend to D, Fig. 2. Place one point at U and strike curve line L S; strike similar line on opposite end, and strike straight line from K to L. This will complete the template. If the joints are to lap, add sufficient material.

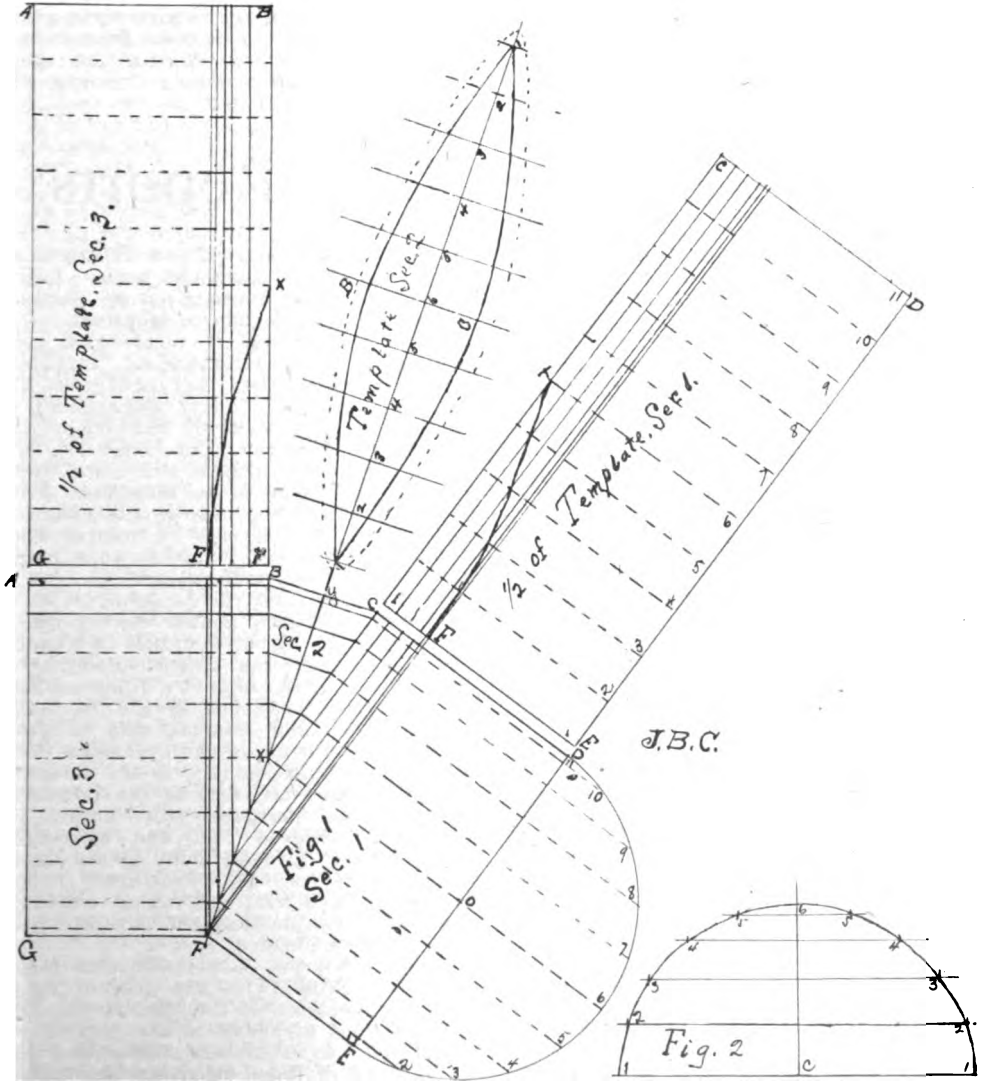

Pattern for a three-piece elbow, the middle piece being a gore;
 A-B-C-D-O-E-F-G, A, Fig. 1, shows the outline of elbow, and B-C-X-B shows the outline of section 2, the gore. Section 1 and 3 are the same and are laid off as follows: Strike a half circle at end of section 1 and divide it into ten equal parts, from these divisional points strike lines parallel with the sides of the section and continue them until they strike the division line F-X; next

mark off template, one-half of which is shown for sections 1 and 3, divide the half into ten equal parts and strike lines parallel with the ends. Next take the points where the divisional lines in section 1 cut line E-X, and from these points strike lines at right angles to the divisional lines, continue them through template, and where the two sets of lines cross each other, trace a line as shown, which will be the cutting line, for sections 1 and 3, from X to F.

Now, in laying out section 2, we have to obtain a correct section from X to Y; to do so we have to lay out Fig. 2, which shows correct outline; it will be noticed this is less than half of the diameter of elbow. To mark off Fig. 2, proceed as follows: Strike base line 1-C-1, erect a right angle line at C, then with one point of dividers at X, place the other point at the first cross line, and transfer this to Fig. 2, from C up, then get the distance from X to the second cross line and transfer to Fig. 2, and continue until reaching Y, and transfer to vertical line Fig. 2, and through these points strike lines parallel with base line 1-C-1.

Next take the distance from 0 to 6, Fig. 1, and transfer on each side of C; next take the distance from 7 to the center line and mark it on each side of the center line, on line 2, continue until all lines are covered, and through these points trace the semi-circle—this will be the true length of template for the gore. To lay out same, strike center line and divide it into the same number of parts as are contained in half circle, Fig. 2, which is ten; strike right angle lines and transfer the distance from center line X-Y, Fig. 1, to the sides of gore, through these points, trace a line and add lap all around, as shown.

International Officers' Reports.

REPORT OF INTERNATIONAL VICE-PRESIDENT MERRIGAN.

To the Officers and Members of the Brotherhood, Greeting:

At the conclusion of my last report I was in Winnipeg, September 2. Arriving in Winnipeg on the latter date I arranged to attend regular meeting of Lodge No. 126, in the evening. The following evening I was in a position to report to the president and secretary of Lodge No. 451 regarding my travels over the Canadian Northern Railway, as I had made a special visit over said road in the interests of Lodge No. 451, and our organization in general.

September 4 I left for Montreal, to investigate the methods being practiced by McFetrich, who was secretary-treasurer of District Lodge No. 30. This I had been requested to do, at my earliest convenience, as several lodges and the District President had complained of not receiving any attention to their requirements.

Arriving in Montreal on the 6th (Labor Day), I proceeded to the place where the parade started from, expecting to meet with the officers and members of Lodge No. 134. However, later on I was informed that at a regular meeting of Lodge No. 134 it was decided that the lodge would not participate in the annual Labor Day parade, for reasons better known by members who regularly attended meetings. The day was ideal for the parade. Several new unions were in the line. Owing to the outbreak of the European war the unveiling of the Charter Memorial was postponed. The bust of the father of Confederation being delayed in arriving from somewhere in Europe. The usual sports were held at Dominion Park in the afternoon, under auspices of the local T. & L. C.

After making inquiries of the local officers of Lodge No. 134 regarding McFetrich, I was informed that Brother Chadburn, District President, had been in Montreal during the latter part of the month of August, and had a meeting with McFetrich, and upon finding that the latter was not attending to his duties, Brother Chadburn collected all books and paraphernalia be-

longing to the District and returned to Winnipeg, taking charge of same. Later, information was received from Brother Chadburn as to his trip to Montreal.

While in Montreal, I received a communication from International President Franklin, to the effect that Lodge No. 134 had requested the Fidelity Department to foreclose on the bonds of McFetrich, who was Financial Secretary of Lodge No. 134, and to take action against McFetrich to recover any shortage in his accounts. I immediately placed the case in the hands of an attorney, with a view of hearing from McFetrich. Further inquiries were made, but no reply was forthcoming.

On the 18th, I left for St. John, N. B., to attend the thirtieth annual convention of the Trades and Labor Congress of Canada. The convention was called to order at 10:30 a. m., in St. Andrew's Rink, by Bro. J. L. Sugrue, president of the St. John, Trades and Labor Council, who extended the hearty welcome of the organized workers of the convention city, to the delegates assembled from all parts of the Dominion, and Fraternal delegates from across the line. He believed that the convention would tend to give an uplift to the organized workers of the Province of New Brunswick, and that everything would be done to make pleasant and profitable the stay of the delegates.

Brother Sugrue then introduced Mayor James H. Frink, who was present to extend the welcome of the city of St. John. He said that in behalf of the city it was his pleasure to extend the cordial and hearty welcome of those attending the convention. He recognized the importance of the Trades and Labor Congress of Canada in the Dominion and as Chief Magistrate was delighted to know that the Montreal convention had decided to hold their succeeding gathering in the New Brunswick city. He knew that the big cities of the west, such as Montreal, Toronto and Winnipeg, where there was all that goes to make life worth living, had a better chance to secure such a convention than the less pretentious city and while they were not as wealthy as the

cities of the West and had nothing disgustingly rich, they had none so poor that they could not get the necessities of life; and if there were, the municipality would see that they did not starve. He said that in the West there were many grave problems for which there could not be found a very ready solution. "You are only on the fringe of these problems that confront humanity," said Mayor Frink, "and I hope you will do all you can to unravel and dissect them so that those who work may get a reasonable share of the reward for their labor. These problems are more acute in the large centers but they are also beginning to develop here. There is a branch of your organization in this city beginning to grapple with them and in their efforts they are by no means discouraging the great body of which they are a part. There has been an arbitration with reference to a recent trouble which we had in this city and I am pleased to state a satisfactory settlement to all parties was reached. I realize that men banded together can do more than when they stand alone. They are able to submit and enforce their demands, not from an individual standpoint, but collectively. Having branches all over Canada, you can make your influence felt. I have observed that influence and feel that it will be stronger in the future. It is not my intention to enter into an address on capital and labor. Everybody recognizes that labor must have its due and fit reward. It is a matter of education and as conditions arise they will have to be intelligently coped with. Children educated at our free public schools are fit to enter any university on the continent. They know what comfort is and what want means. They feel that they have a right to live comfortably and equitably with their neighbors and while there may be an outcry that too much is spent in educating the masses, this outcry is altogether falacious. Conditions have materially changed in the past twenty-five years and these changes will continue to go on until a greater proportion of betterment has been accomplished. It has been charged that this congress wishes to embarrass capital in its operations, but I understand that it is your desire to give a fair day's work for a fair day's pay. (Applause.) You are not inclined to give them all for dividends with nothing for yourselves. I might enter into a discussion of such questions as child labor, war, and arbitration, but you do not expect me to do so in the time allotted to me. Although a public man, I read and observe a great deal and there is nothing attracts my interest so much as the labor problem. Everything we have is the result of labor; and we cannot get away from that fact. Those who have never had their hand to the plow cannot recognize the worth of such an organization as yours. It is my hope that the time will come when men who retire from industrial activity will feel that they are something more than a worn out chattel

and will have something more in store to enable them to enjoy in old age. I believe that there are much better times ahead." (Applause.)

Mr. F. L. Potts, one of the city commissioners, was then introduced by Chairman Sugrue. He said that it was a great pleasure to have the privilege of addressing the delegates. Up to the eleventh hour he did not know whether he would be at the convention. "I must say if there is one member of the council in sympathy with labor, I am that one," he continued. "I ran my election recently on the question of land tax and I won out as the representative of the people. I require the assistance of all the labor organizations in my endeavor to fulfill the promises I made to the electors." He concluded in saying, "I would advise you to get rid of the politicians who work merely for themselves. Have men come out on the platform and tell you what they will do if elected and if they do not fulfill their promises turn them out at the next election. The day is coming when there will be no power to swing our legislature but the power of Labor." (Applause.)

The Hon. John A. Wilson, Chairman of the Executive Council of the Legislature of New Brunswick, presented the welcome of the Legislative Assembly. He said he thanked the congress on behalf of the government of New Brunswick for the kind invitation extended, and was not surprised that the government should be recognized. He thought the relation between the government and labor organizations had been very satisfactory for many years, and while the government had not been able to place all the legislation on the statute books that had been asked for by organized labor, he could sincerely state that the government had endeavored to enforce all the good legislation on the statute books. In conclusion he said, "I hope your deliberations will be profitable for those you represent and I will always be ready to co-operate with you to bring about that for which you are striving." (Applause.)

Chairman Sugrue stated that the Hon. Thos. W. Crothers, Minister of Labor, had expressed his intention of being present at the opening of the convention, but he had received a letter from the Minister stating it was impossible for him to be present at the opening, but would take the opportunity of addressing the delegates at the Tuesday or Wednesday sessions. He then vacated the chair and introduced President J. C. Watters, who fittingly acknowledged the welcome extended by representatives of Labor, the Municipality and the Province. He said he had no doubt the delegates would carry away with them the most pleasant recollections of their visit to St. John, and would thoroughly appreciate the words of welcome extended by those who had preceded him. He emphasized the fact that the delegates were assembled for a common purpose and while there might be differences of opinion, he hoped such differences

would not degenerate into personal animosities. He said the convention was recognized as an open forum, where every delegate had the right to speak, but would be under the obligation to respect the right of other delegates. He warned the delegates not to occupy the convention in useless repetition and said it was not always what a man said but frequently what he didn't say that carried the most weight. "We want to expedite business and get home as soon as possible," said the President. "You all look alike to me; I have no friends and hope to have no enemies. Equal privilege will be extended to all delegates." President Watters then declared the convention open for business. President Watters then stated that he was pleased there was one fraternal delegate present and introduced Brother Mortimer M. Donoghue from Butte, Montana, the fraternal delegate of the American Federation of Labor, who was received with hearty applause, supplemented by the singing of "It's a long way to Tipperary." Brother Donoghue stated that the chorus just rendered by the delegates had a peculiar interest to him, as he had married the descendent of a former resident of Tipperary. He expressed his appreciation of the honor conferred on him by the American Federation of Labor in his election as fraternal delegate to the Congress Convention. He stated that he understood that he was not expected to make a long speech at that stage of the proceedings and would later deliver the fraternal message which he had come to give to the delegates. He would also tell of some of the conditions obtaining on the other side of the boundary line. Before sitting down he thanked the delegates for the kindness extended to him since his arrival at the convention.

In responding to the magnificent address delivered by the fraternal delegate, President Watters said that the American Federation of Labor had sent many excellent speakers as fraternal delegates, but never had the congress heard a better exponent of the aims of the American Labor Movement. He expressed the wish that a verbatim report of the address could be put in the hands of every citizen of Canada, and that more sermons would be preached in the pulpit that would be as expressive of as much good. Turning to Brother Donoghue, President Watters said that the delegates would always remember the words of wisdom and encouragement that had fallen from his lips.

Miss O'Reilly, the fraternal delegate from the National Women's Trades Union League was introduced the following day by President Watters and was given a hearty reception as she arose to address the convention. "Brothers, comrades, friends and especially women," said Miss O'Reilly, "I am glad that there is a handful of women here. They are in the position of the lad on the island who was fearful of the opposite sex. His daddy never let him see a little

girl. One day in crossing from the island the boy saw a little girl and asked his daddy what it was. The boy was informed that it was a goat. "Then I want a goat for myself," said the boy." (Laughter.) "Women are goats," said Miss O'Reilly, "and I want them for myself." We will get it over yet. When you really want to fight bring in the women. In New York I am known as 'Fighting O'Reilly.' Just as soon as you line up with the labor movement in New York you have got to understand that it is a fight to a finish. Miss O'Reilly spoke on many matters of interest to the workers. She referred to the splendid work of Miss Henty, the editor of Life and Labor, the official organ of the National Women's Labor League, and urged the delegates to subscribe for the paper. She gave a graphic description of the Triangle fire in New York City, where the lives of one hundred and sixty girls were lost because of the indifference of the employer to the needs of the employes. She emphasized the fact that when the workers sell their labor-power they sell themselves. She closed her address by thanking the delegates for the opportunity of addressing them and was tendered a great ovation as she sat down.

The fraternal delegate of the British Trades Union Congress, Brother Jos. Cross, Accrington, Eng., was unable to attend.

Credentials were received from the following: Fraternal Delegates, 3; Federation of Labor, 1; International Representatives, 17; Trades and Labor Councils, 23; International Local Trades Unions, 105. All were seated. The various committees were appointed. Reports were received from the Executive Council of the Congress. Provincial Executives, Legislative Lobbyist of New Brunswick, Immigration, by W. R. Trotter: Fraternal Delegate to the A. F. of L., G. Franco; Parliamentary Representative, J. C. Watters; President J. C. Watters; F. Bancroft, Vice-President; Organizer J. L. Sugrue; Organizer W. R. Trotter; Delegates to the Social Service Congress: James Simpson, on the Royal Commission on Industrial Training and Technical Education; P. M. Draper, Secretary-Treasurer, showed total receipts from all sources, including a balance from the previous year of \$9,396.05, was \$23,713.14. Total expenditures were \$12,762.10, leaving a balance of receipts over expenditures September 15, of \$10,951.04. The membership directly affiliated and paying per capita tax was 80,094. In addition to this forty-six Trades and Labor Councils, three Provincial Federations of Labor and eighteen Federal Labor Unions were chartered. Trades and Labor Councils chartered by Congress, forty-seven. Provincial Federations of Labor, three.

On the fourth day, morning session, the Hon. T. W. Crothers, Minister of Labor, was introduced by President Waters. The Minister spoke at length on many matters in connection with his department, and in part said: "That pride was not the noblest

element in human character, but the man who hadn't anything of which he was proud did not amount to very much. He said he had many things of which he was proud, one was that his father and mother were Irish and another was that he was born poor. "Abraham Lincoln was born poor," said the Minister, "and I am proud of the officer who sits on the cash box of the Congress because he is Irish. It is a guarantee that there will be no leakages. I am also proud that in my judgment the best speech of the convention came from the little Irish girl from New York." He said every workman should be a member of the appropriate organization in the locality where he lives, because it requires organization for human betterment. What chance has an individual workman to secure his rights if he goes and says his pay is not sufficient? His employer will perhaps tell him to go and get his time. If he is backed by thousands of fellow workmen his employer will say, "I am busy now, but call around later." That is the difference. He said he had in hand resolutions presented, fifty-four in number, and that he could not find a single word of appreciation of the Labor Department at Ottawa. In conclusion he wished all success to the Trades and Labor Congress of Canada, get all the men you can into your organization; and the men who do not join you are taking something they are not justly entitled to. (Applause.)

At the afternoon session Delegate Foster of Naniamo, and Brother Frank Farrington were given the privilege of the floor to explain the strike situation on Vancouver Island from its inception to the calling off of the strike. Following their representation of the case the Hon. T. W. Crothers, Minister of Labor, was given an opportunity to reply. Both sides were given a respectful hearing by the delegates and the opinion of the convention was expressed in a resolution submitted later to the convention.

About 65 resolutions were presented, dealing with matters pertaining to the welfare of the workers in the Dominion.

The Convention was in session September 21 to 26, and adjourned with three cheers and the singing of "Auld Lang Syne." The Congress Executives were re-elected. Vice-Presidents were elected for the Provinces. Delegates Rigg and Lodge were nominated for Fraternal Delegate to the Convention of the A. F. of L. Delegate Rigg was elected.

Invitations were received from the Mayor of St. Catharines, and the Trades and Labor Council, and from the Mayor of Vancouver, and R. P. Pettipiece of the B. C. Federationist, to hold the Congress Convention of 1915 in their cities. Vancouver was chosen as the Convention city for 1915.

After the adjournment of the Convention I visited McAdam Jct., Moncton and Riviere-du-Loup, and had meetings with the officers and members of Lodges 379, 378 and 398, respectively. This will conclude

my report up to October 1. With very best wishes to all, I am,

Yours fraternally,
J. P. MERRIGAN,
I. V. P.

COMMUNICATIONS FROM INTERNATIONAL SECRETARY-TREASURER REINEMEYER.

Kansas City, Kas.

To the Officers and Members of All Subordinate Lodges, Greeting:

Gentlemen and Brothers: I wish to make an explanation, through the columns of the Journal, in reference to the fourth quarterly report, under the head of "Support of Business Agents."

In making up this quarterly report, beginning with the name of D. J. Markham, of District Lodge No. 2, we dittoed the other districts all the way down to the name of Robert Rosbottom, and through an error of the printer he omitted the ditto marks, and as we had several inquiries as to an explanation of this kind, we thought it necessary to make a publication in the Journal to make this correction, in order to make it clear. If the members will check up the quarterly report with the district roster, they will find that these names in the quarterly report are the secretaries of the respective districts and are the official representatives to receive the money for the support of business agent.

Trusting this will set the members clear in reference to this error, with best wishes and kindest regards, I beg to remain,

Yours fraternally,
F. P. REINEMEYER,
International Secretary-Treasurer.

Kansas City, Kas.

To the Officers and Members of All Subordinate Lodges, Greeting:

Gentlemen and Brothers:

It has come to my notice that there are a great many of our secretaries who are not complying to the constitution in reference to sending in the clearance cards received and accepted by the local lodges, which is in Article 10, Section 3, page 62, and which reads as follows: "As soon as a clearance card is received and accepted by a lodge the local secretary shall write thereon the number of the lodge, the date of its deposit and attest same with his signature, and within ten days thereafter, he shall forward this card to the International Secretary-Treasurer for the purpose of recording in the Grand Lodge. Failure of the local secretary to forward any of these cards within the specified time shall subject him to a fine of \$2.00, which shall be collected by his lodge and forwarded to the Grand Lodge, on complaint of the International Secretary-Treasurer."

We have received several inquiries in reference to some of our traveling brothers, and if these clearance cards are not forwarded to the office within the specified time, we are unable to give the whereabouts

of these members, for the reason that the local secretaries do not send in the cards, and they are not traced until the report is checked up under the card index system, then occasionally we run across the member that someone is looking for.

Now, if the secretaries will co-operate with us in sending in these cards promptly, we can make a success of this card index system, but if the secretaries do not co-operate with us, it will be a big failure.

I also wish to inform the secretaries that it is not necessary to write a communication or anything, all they have to do after the card has been accepted by the lodge is to put them into an envelope and mail to this office.

Trusting that all Secretaries will comply with this part of the constitution and forward these cards immediately after the meeting, with best wishes and kindest regards, I beg to remain,

Yours fraternally,
F. P. REINEMEYER,
International Secretary-Treasurer.

PROPOSED AMENDMENT TO THE CONSTITUTION.

Livingston, Mont., Jan. 22, 1915.

Mr. J. A. Franklin,
International President,
Kansas City, Kas.

Dear Sir and Brother:

The following is a "Resolution," unanimously adopted at last regular meeting, and whereby I was instructed to send you a copy of same, requesting that you have it printed in our official Journal in the proper manner, so that the rank and file may vote their sentiment on the question embodied therein:

RESOLUTION.

An act to amend Article V, Section 3, of the Grand Lodge Constitution.

PREAMBLE.

Whereas, The San Francisco Convention increased the salary of the Grand President at a time when conditions of the trade, country and Grand Treasury did not justify it, and

Whereas, Conditions of the country and trade are growing steadily worse; and

Whereas, We believe the increase unwarranted, and excessive, as compared to the earnings of the average boiler maker or ship builder; and

Whereas, We believe the membership as a whole are not satisfied or would not have granted this increase, but that it was granted by a "machine controlled convention," with the majority of the members not represented; and

Whereas, The next convention will not meet until 1917, that this great wrong may be righted, and honesty and justice to all may prevail, we, the members of Subordinate Lodge No. 123, in regular meeting assembled, do hereby demand that the Grand President order a referendum vote on the question to strike out the words "twenty-four hundred dollars," in Article V, Section

3, lines 10 and 11, of our Grand Lodge Constitution, and insert the words "eighteen hundred dollars" in lieu thereof.

Fraternally submitted by

LODGE No. 123,
Theo. W. Evert, C. and F. S.

Kansas City, Kas., Feb. 19, 1915.

To the Officers and Members of All Subordinate Lodges, Greeting:

Gentlemen and Brothers:

In reference to the foregoing letter and resolution from Lodge No. 123, of Livingston, Mont., proposing an amendment to Article 5, Section 3, of the Grand Lodge Constitution, you will be governed by Article 3, Section 1, in considering this proposition.

Inasmuch as the law requires that a proposition for legislative enactment shall be published in the official Journal for two months, which notice must expire at the end of the month in which it was published, and in accordance with this provision all votes must be in the hands of the International Secretary-Treasurer not later than the tenth (10th) day of May. In the event the resolution shall be 20 per cent indorsement, the proposition will then be submitted for a referendum vote.

In voting on this, remember this is a lodge vote and requires majority of the lodge, either for an indorsement or rejection of the proposition. The vote is to be returned to the International Secretary-Treasurer in accordance with Article III, Section 1.

I regret very much that the fourth "whereas" in the foregoing resolution contains such a glaring misstatement of facts, and it becomes my duty to challenge the statement that the action of the San Francisco Convention was controlled by a machine. No more bare-faced falsehood or misrepresentation of facts could be made by anyone.

I refrained from placing International officers who were regularly elected delegates upon any committee as far as possible, and to my knowledge no undue influence was used or attempted with any committee. I did not personally appear before any committee at any time except when requested to do so by the committee themselves.

It appears that there are those among our members who, when unable to secure favorable action upon propositions favored by them personally, or to defeat matters proposed by others, immediately become disgruntled and, through a lack of any logical reason resort to slander and a misrepresentation of facts.

I feel that as a matter of justice and in order that those of our members who may not have read the proceedings of our convention, with reference to the action taken in amending Article V, Section 3, that after the amendment was carried by practically a unanimous vive voce vote, and hearing some objections on the part of a few of the delegates, I voluntarily threw the mat-

ter open for reconsideration on the floor of the convention, and, after a free and unlimited discussion, a roll call was taken, which resulted in a vote of 167 in favor and 87 opposed.

I desire to further call attention to the fact that the question had been disposed of and could not be reopened under parliamentary law, and that my action in placing it again before the convention was purely voluntary.

I regret that it becomes necessary to mention these facts, but in the face of the gross misrepresentation made in this resolution, also in other articles from the same source, these statements could not consistently be permitted to go unchallenged. The records of the convention will bear out every statement contained herein.

Assuring you, one and all, of my kindest regards, I am,

Fraternally yours,

J. A. FRANKLIN,
International President.

PROPOSED AMENDMENT TO THE CONSTITUTION.

Winnipeg, Man., Can.

Mr. J. A. Franklin, Kansas City, Kas.

Dear Sir and Brother:

Please find inclosed resolutions drawn up by Lodge No. 126, which I hope you will give your kindest attention.

With best wishes and kindest regards, I beg to remain,

Yours fraternally,

A. B. PAGE,
Cor. Sec'y. Lodge No. 126.

Whereas, The Constitution of this Brotherhood does not make ample provisions for the removal of Grand Lodge officers unless charges are preferred against them, and

Whereas, Causes sufficient for the removal of an officer, does not necessary provide grounds for charges being made, N. B., incompetency, etc., and

Whereas, The time set for holding conventions having been extended from two to three years, we think that provisions should be made whereby the rank and file will have some control over Grand Lodge officers between conventions; therefore, be it

Resolved, That Perseverance Lodge No. 126, place before the Brotherhood the following recall provisions as an amendment to the constitution for their approval.

Recall Provision.

(a.) Any subordinate lodge in good standing in this Brotherhood shall have the privilege of proposing the recall of one or more Grand Lodge officers through the referendum, by submitting to the International President a proposition naming the officer, or officers, whose recall is desired, giving specific reasons for the issuance of such recall, who, on the receipt of same, shall at once order it published in the official journal for two (2) months, which notice must expire at the end of the month in

which it was published. Lodges may vote up to the end of that period.

(b.) All lodges voting must make return of their vote in ten (10) days after the close of the voting limit, and if twenty (20) per cent of the lodges in good standing and voting at the time do indorse it, the International President shall immediately notify the officer, or officers, whose recall is proposed, said officer or officers, shall have the privilege within ten (10) days of receipt of such notice, to submit to the International President a written statement in his own defense, such statement shall not exceed three hundred (300) words, who shall order it published in the Journal at the same time as he issues the ballots for the recall of said officer, or officers, to all the subordinate lodges in good standing for their suffrage.

(c.) If the proposed recall receives a majority of all valid votes cast and returned within sixty (60) days, providing that the total vote cast shall be equal to at least fifty (50) per cent of the members in good standing as shown by the preceding quarterly report of the International Secretary-Treasurer. The services of the officer, or officers, whose recall has been decided on, shall immediately terminate, and his or their successors shall be appointed as per Article 5, Section 5.

Reasons Why We Should Have the Recall.

In view of the fact that it is only recently that this Brotherhood held its convention, a short explanation as to why Lodge No. 126 desires a constitutional amendment at this time, will not be amiss.

According to our constitution and the verdict handed down by the executive council at their annual meeting held in Kansas City, October, 1914, to Lodges No. 126, No. 451 and No. 529, an officer cannot be removed unless convicted of certain charges, inefficiency does not constitute a charge, so it does not matter how incompetent an officer may be, unless charge of dishonesty, etc., can be brought against him, the organization is compelled to carry him on the pay roll, until he can be legally removed at the next regular convention, which does not take place until September, 1917, or by the calling of a special convention, which would be too costly a procedure for the removal of probably a single officer.

When conventions are held at such long intervals as ours, it is essential that provisions should be made for the removal of officers when deemed necessary.

The extension of the time between conventions was considered after the referendum had been disposed of, the recall was not even discussed, or probably it might have been inserted in the constitution at that time. Be as it may conditions have arisen in this part of the country that evidently can only be removed by inserting a recall provision in the constitution, or by waiting another three years and once again attempting to get the desired change, and we do not feel inclined to wait that length of time.

The growth of the organization is being retarded, and it is imperative that something should be done.

Let us consider the question from the viewpoint of democracy; we are supposed to live in a democratic country, and we gradually see a determined desire on the part of the people to gain more and more control over public officials, and the means to that end is through direct legislation, referendum and recall, etc. Very, very few workers, especially members of organized labor, are opposed to the recall of public officials, and due to that fact we have provisions for the recall of public officials on the statute books of many cities, counties, states, etc., and many of the trade unions have followed suit; it had proved a success in cases too numerous to mention, that we see no reasons why it cannot be successfully worked out in our Brotherhood.

Then again through the referendum and recall you have a far better representation of the intelligence of the members in the organization, which in the last analysis is the real intelligence of any organization.

The oft repeated argument against the recall, is that only a small percentage of the membership take advantage of it. While it is true to some extent, that although every member is entitled to vote, they never do so, we must remember that any proposition enacted by referendum requires a voting power of at least fifty per cent of the total members in good standing before it can become law. So it does not matter how low the voting figures in favor of a certain proposition go, there is a limit beyond which it can't go and become law, and the lowest possible figures is higher than that required at conventions for the enactment of laws.

Let us see what percentage of representatives we have at conventions, taking the last convention as a criterion. We had three hundred and forty-two (342) lodges in good standing according to the September report; out of that number eighty (80) lodges were represented at the convention, roughly figuring, one hundred and twenty (120) delegates represented the eighty lodges. We have somewhere around sixteen thousand (16,000) members, which gives us the following percentage: Eighty (80) lodges out of three hundred and forty-two (342), twen-

ty-two (22) per cent, one hundred and twenty (120) delegates out of a total membership of sixteen thousand (16,000), less than one per cent. So it can readily be seen where the correct expression of the organization lies.

This is not a kick from a few disgruntled members, but is the unanimous verdict of all the lodges in this city, and we are prone to believe that if the grievances turned down by the executive council, as being not based on facts without any investigation on their part, were placed before all the affected lodges in Canada, that they could substantiate all the claims that we have made and properly add a great deal more to them.

We ask you to give this amendment every consideration, if the recall is not the proper method for the removal of an officer when deemed necessary between conventions, then please enlighten us as to the proper method. We have tried every other means within our knowledge and failed. Hence the reason for this resolution and proposed amendment to our Constitution.

Respectfully submitted,

C. DAVIS, President.

A. B. PAGE, Cor. Sec'y.

KANSAS CITY, KAS.

To the Officers and Members of all Subordinate Lodges:

Greeting:—The foregoing letter and resolution received from Lodge No. 126, contains a proposition to amend Article III, Section 1, and is published in accordance with Article III, Section 1. In considering this matter you will be governed entirely by Article III, Section 1, and all votes from Subordinate lodges must be in the hands of the International Secretary-Treasurer not later than the 10th day of May. Any votes received after that date will not be counted. You will remember, when voting on this proposition that it requires a majority vote of your local to indorse or reject and if the result should be a twenty per cent indorsement of all lodges in good standing, the proposition will then be submitted for referendum vote. With very best wishes, I beg to remain,

Yours fraternally,

J. A. FRANKLIN,

International President.

Correspondence.

Chicago, Ill., January 28, 1915.

Mr. A. O. Wharton,
Ghlo Building,
St. Louis, Mo.

My Dear Wharton:

Your esteemed favor of the 25th inst. received. On September 18, 1913, I addressed the Twelfth Convention of the B. R. C. of A. in Milwaukee, Wis. I directed the attention of the convention to the passage by the

Sixty-second Congress of a bill creating a Commission to be known as the Commission on Industrial Relations. I pointed out that President Wilson had, on June 26, 1913, appointed the members of this Commission; that the Commission was given power to hold public hearings, compel the attendance of witnesses and enforce the production of documentary evidence; that the Commission was directed to seek the underlying causes of industrial discontent and its ef-

fect upon public welfare, and report its findings and conclusions to Congress.

Realizing that publicity is the greatest corrective and that this Commission furnished organized labor an opportunity to place its side of the case before the American people, I urged that the Commission be petitioned to take up in public hearings the very serious controversy between the Illinois Central and Harriman Lines and their 35,000 locked-out employes, constituting the I. C. R. R. and Harriman Lines System Federation.

On November 12, 1913, I addressed the Convention of the American Federation of Labor in Seattle, Wash. Again I pointed out the advantage of asking the Commission to take up in a public hearing the I. C. and Harriman Lines controversy. While in Seattle you convened the Executive Council of the Railway Employes Department for the purpose of taking up in conference my suggestion.

While there was nothing in the act creating the Commission and defining its powers which prevented the Commission from granting such public hearings, it was feared by some that the body might not grant such a request. Our conferences ended in Seattle with the understanding that, before making the application, we would try to find out the attitude of the Commission toward such a hearing.

On April 13, 1913, I addressed the Railroad Employes Department in Kansas City, Mo. While in that city the plan of procedure was discussed and it was decided that application should be made to the Commission for a hearing.

Messrs. Ryan, Kline and yourself conferred with me later in my office in Chicago, and I was retained to represent the Department. It was agreed that I should receive \$2,000.00, out of which I was to pay all the expenses incident to gathering, preparing and presenting the evidence in the case for the Commission. This amount was to cover everything, including the fee for my time and services.

In May of 1914 you asked me to meet you and other members of the Executive Council in Washington, D. C. I complied with your request. President Johnston of the Machinists, Ryan of the Carmen, yourself and I called upon Chairman Walsh of the Commission. We were promised a hearing. Mr. Walsh suggested that we go on to New York for the opening session of the Commission and see Mr. Thompson, counsel for the body, and complete our arrangements with him. We went to New York, attended the opening sessions of the Commission, conferred with Mr. Thompson and were assured by him that the case would be heard in Chicago.

Learning through the daily press that the Commission would meet in Chicago on July 21. I wrote to the secretary and its counsel, William O. Thompson, for information regarding the date of the promised hearing of the System Federation controversy. Neither answered. The Commission met in Chi-

ago on July 21, 22, 23, 24 and 25. I called upon Mr. Walsh and he informed me that the present program of the Commission was to make a preliminary survey of industrial conditions and that controverted causes, such as ours, would be taken up in later public hearings. He assured me our case would be taken up among the first. I attended every session of the Commission in Chicago. The Commission left Chicago for points in the West, when I learned through the newspapers that the Commission had completed its preliminary survey, I wrote to the secretary of the Commission, with headquarters in Chicago, reminding him of the promise to hear our case and asking for a hearing at an early date. In reply to these letters I was informed that I would be notified of the date as soon as it was decided upon. Not hearing from the Commission again, I sent one of the Burnside men to the office of the Commission and he reported to me that he had been told that our case would be heard soon, and that I would be notified.

In October, 1914, Carl Person and myself met Mr. John B. Lennon, a member of the Commission, in Bloomington, Ill. He told us the Illinois Central and Harriman Lines case would be taken up early in January, 1915; that Chicago, Macomb, Miss., and Memphis, Tenn., were three places in which public hearings would be held on the Illinois Central.

To get our evidence in shape I drafted a "question sheet," containing fifty interrogatories. Sixty thousand of these were printed. I sent 40,000 to the grand lodge headquarters of the organizations involved, the balance were distributed through the Strike Bulletin and my office.

I requested the assignment of Grand Lodge Vice-Presidents for work of special investigation. My request was complied with. Conferences with the men sent to me were held in Chicago. I gave them special instructions as to the investigations I wanted made and sent them out over the lines. As the filled-out question sheets and the reports of the special investigators came in, I used a force of clerks to make a card index of the evidence. The classification of the evidence and the making of a card index was a slow and painstaking job.

I am waiting to hear from the Commission. I do not know why the Commission has not kept its promise. For printing, for clerk hire, for postage, for traveling expenses and hotel bills, I have spent a considerable portion of the \$2,000 agreed upon. I have spent time as well.

Now, I am waiting for a reply to my last appeal to the Commission to keep their promise to us. My last letter was written in triplicate, one addressed to Mr. Frank P. Walsh, chairman of the Commission; one to Mr. William O. Thompson, counsel, and one to the secretary.

I have been deluged with letters from all over the strike zone, each asking for the

cause of the delay. I am as much in the dark as anyone when it comes to the cause. The facts are as I have stated them.

As to the investigation, I shall try to secure an early answer from the Commission.

With best wishes, I am,

Fraternally yours,

Signed: FRANK COMERFORD.

ST. JOSEPH FRATERNAL WEEK ASSOCIATION.

When? March 1 to 6, 1915.

Where? St. Joseph, Missouri.

You are invited. Who? Everybody. Are you coming? Yes, of course you are, and so is your neighbor. Why? Because it is going to be the greatest event from a fraternal standpoint that has ever been known.

There will be something doing every minute, including two grand street parades, drill team contests, for which \$2,000 in cash prizes are offered, including band contests.

Speaking by leading fraternalists of the country will take place every afternoon and evening, interspersed with band concerts and vaudeville acts, including other special entertainments for our guests.

During this week the "City Worth While" is ours, and in turn we are giving it to you. No expense will be spared to make this the event of events. No entrance fee will be charged teams entering the contest.

Thirty thousand fraternalists of St. Joseph will meet you with a glad hand, and their lodge and club rooms will be open to you.

Fraternal Week is a home coming of the best people in the world, and we want to know you. First write us, and then come.

Address all communications to

W. A. KING, Secretary,
Sixth and Jule Sts.

REPORT OF INTERNATIONAL DEPUTY ORGANIZER REED.

Portland, Ore., Feb. 8, 1915.

Editor-Journal:

At the conclusion of my last report I was in Portland, where there was considerable work at the Willamette Iron and Steel Works, in connection with a large ship repair job. I was successful in reinstating twelve and initiating ten from this job; and also made arrangements for our members to go to Le Grande and erect some oil tanks. Also got in touch with a job on a pipe line at Preston, Idaho. Mr. C. Seaburg, of Portland, is in charge of the job and took three of our members with him, and promised to run a fair job. I notified President Franklin, who in turn notified Brother Dunn, corresponding secretary of Lodge No. 198, and I was under the impression that the job was running all right until I received a letter from Brother Dunn a few days ago informing me that he had been successful in placing boiler makers and rivet heaters on the job, but complained that they were using farmers as holder-ons. Now, we all know that conditions of this kind happen far too frequently on field work in connection with

our business, and I maintain that the fault lies with the men on the job. I feel sure on the job in question it was only necessary for the boiler makers and rivet heaters, who are all card men, to make a stand, and they would have got organized holder-ons on the job. I advised Brother Dunn along these lines, and if this stand has not already been taken, I hope it will be.

I left Portland for Seattle, where I met Brother Atkinson, Fifth International Vice-President, and together we visited several shops, and also attended meetings at Tacoma and Everett, Wash.

I was requested to go to Auburn, Wash., where there was a small gas holder in course of construction, and all the men on the job but two were members of Lodge No. 104. The brothers had tried to have them put off the job, but were told to quit if they were not satisfied. I took up the matter with the foreman, and he agreed to let them go, and the job was finished without any further trouble.

I left the Seattle district and went to Vancouver, British Columbia, and attended a meeting of Lodge No. 194, where I am glad to report they are having large attendances at these meetings. I was requested to go to Prince Rupert, British Columbia, where there is under construction a large floating dry dock. I had previously made arrangements for this job to be done by our members, and the men were to be furnished through Lodge No. 194, and that first class transportation would be allowed, but, in spite of this, some of our members paid their own fares and got on the job. Now, the brothers that were loyal and willing to take their chance of getting a job, when applications came for men, did not think they were getting a square deal, and as applications for membership were coming in from the job, they decided to entertain no more applications from that quarter. On reaching Prince Rupert I called a meeting of the brothers on the job and, after a long discussion, they decided that there would be no one allowed to start on the job except they came through the lodge. I talked the matter over with the foreman and he agreed to hire no one that the shop committee objected to. Under the conditions, as I left them, there is no reason why the job should not be completed without any further trouble. On my leaving I was requested to send four boiler makers and three helpers up. On reaching Vancouver we held another meeting, and everyone seemed satisfied with the arrangements made. Now, in connection with Lodge No. 194, I wish to take this opportunity of congratulating the members on their choice of officers. In Brother Campbell as president they have one of the best union men in the country, and the same can be said of the vice-president, Brother Jack McCall; and Brother Fraser continues as secretary, an office he has held for a number of years, and it can be said of him that he has the confidence of every member of the lodge.

Leaving Vancouver I returned to Seattle, and the same day went to Everett and visited the Great Northern shops and talked with several delinquent members, and three of them promised to come through. On returning to Seattle, I found a telegram requesting that I go to Victoria, British Columbia, where I went and met several of the brothers, including Brother Stewart, who arranged a special meeting, which was very well attended, and I am sure that when work picks up in Victoria we will be able to increase the membership considerably. I was requested to take up a matter of compensation on behalf of one of the brothers who had met with an accident about ten months ago, and they had kept him going and coming for months, promising to make a settlement, but the money was never there. I took the matter up and am glad to say that I was successful in getting a cash settlement that was satisfactory to all concerned.

Leaving Victoria I again returned to Seattle and assisted Brother Atkinson in arranging a special meeting of the members of Lodge No. 489, for the purpose of bringing about the consolidation of that lodge and Lodge No. 104. Unfortunately I was not able to be present at the meeting, but I have been informed that it was agreed to consolidate. I feel sure that this is the best thing that could have happened in Seattle.

This concludes my report to February 1, 1915. Hoping the same will be satisfactory, with best wishes, I remain,

Fraternally yours,

JOE REED,

International Deputy Organizer.

CINCINNATI, OHIO.

Dear Sir and Brother:

Just a few lines to inform you of the fact, that through the efforts of our worthy Brother, John F. Schmitt, our ninth I. V. P., who was very ably assisted by Brother Nolte, of the Carmen, that we have formed a boiler makers district and, of course, we belong to the System Federation, which was recently formed on the C. H. & D. Railroad.

We had our district meeting in this city on January 18th of this year, at which meeting Brother Schmitt presided, and as we went through the regular routine of business we naturally elected our officers for the ensuing year, of whom are the following brothers: Brother W. J. Redmond, president, Indianapolis, Ind.; Brother A. K. Greisheimer, vice-president, Lima, Ohio, and your humble servant as secretary-treasurer.

I really believe this bit of news will be gratifying to a number of brothers, who have passed through this section of the country at one time or another, to see how the boys on the C. H. & D. are at last awakening to the good results that are to be derived by this get-together movement. Now brothers, I don't desire to take up too much space in our very valuable Journal, as this is my first attempt in this line, but I will say just a few more words in regard

to the brothers along the line.

I feel very confident that all the boys along the line are heart and soul in this very important movement, and if I am to judge the caliber of the rank and file, from the actions of their delegates, and the sentiments these delegates voiced while in this city, then I can truly say without fear of ridicule, that the Boiler Makers will have a very success district on the C. H. & D., and that as a whole they can be fully relied upon as staunch supporters of the System Federation.

Hoping to see this in the next issue of our Journal, and thanking you in advance for your kind favor, therefore, I beg to remain,

Yours fraternally,

WM. J. MCGEE, Jr.

FORT WORTH, TEXAS.

Dear Sir and Brother:

Inclosed please find a memorial to Brother Wm. J. Gilthorpe, our personal friend. We wish to have it published in the Journal.

Hoping this will be favorably considered, we remain,

Yours respectfully,

MR. and MRS. C. T. BURKE.

IN MEMORIAM, WM. J. GILTHORPE.

He is sleeping, but not forever,
There will be a glorious dawn;
We shall meet to part, no, never,
On the resurrection morn.
From the deepest caves of ocean,
From the desert and the plain,
From the valley and the mountain
Countless throngs shall rise again.

He is sleeping but not forever,
In the lone and silent grave;
Blessed be the Lord that taketh,
Blessed be the Lord that gave.
In the bright eternal city
Death can never, never come!
In His own good time, He will call us,
From our rest to Home, Sweet Home.
To our dear departed friend.
From Mr. and Mrs. C. T. Burke.

PARSONS, KAS.

After perusing the Boiler Makers Journal, I sat for a while thinking. I allowed my thoughts to drift. They drifted back a number of months with many happy recollections, wondering what had become of the ones who partook in those happy times. I could hear a voice here, and one there, say, "I wonder what has become of L. A. No. 7." When I heard those voices, I arose and said: "We are very much alive and doing well, thank you."

So we wish to let you know through the Journal that we are progressing very nicely and still growing. We have had numerous disappointments, such as loosing a large number of members, by their husbands having been laid off at the shops which, of course, makes it hard for the faithful few who are left. Those have been working hard, however, in behalf of the L. A. all

the while, never forgetting that "all work and no play makes Jack a dull boy."

Will give you an account of a social eve, which will let all former members of No. 292 and L. A. No. 7, know that what few are left are all alive and doing well. On Kansas Day, Friday, January 29, 1915, Mr. and Mrs. D. M. Thompson entertained the L. A. No. 7 and their husbands in honor of the past and new president.

Old Pluvius tried to discourage us by getting out his last year's water wagon and sent us a very rainy and disagreeable eve; however, a large number braved the storm to spend the evening with Brother and Sister Thompson. It being Kansas Day the house was tastefully decorated with the Kansas flower, also several very appropriate songs were sung.

The evening was spent in various games and contests, some causing much merriment, especially along the line of artists and spirits. A bounteous and most delicious cafeteria lunch was served. At a late hour all departed for their respective homes, voting Brother and Sister Thompson ideal entertainers.

MRS. LUELLE VAN VLECK.

FORT WORTH, TEXAS.

Dear Sir and Brother:

Inclosed please find some pictures of



A GROUP OF MEMBERS LODGE No. 96.

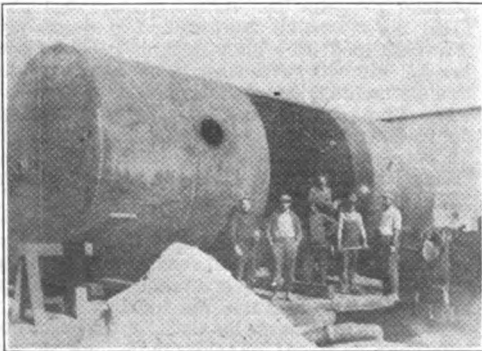

JOB AT 10-MILE STATION, FROM JACKSBORO, TEXAS, IN THE JUNGLE.

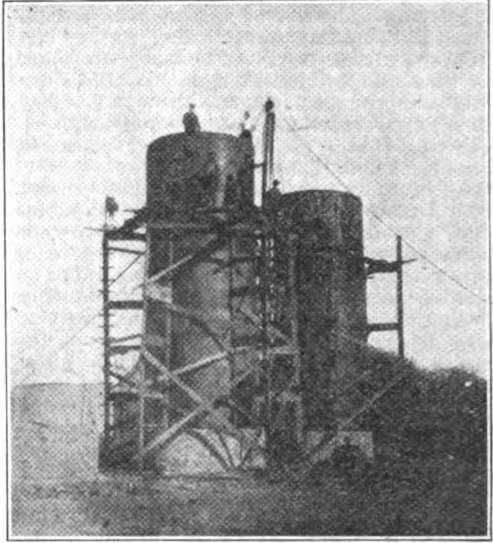

ONE OF THE STRUCK JOBS, TEXAS OIL FIELDS.

some of the gang and some of the work they were erecting when they were called out on strike.

This work was being done by one of the oil field firms that refused to come across but I am happy to state that they are not having any luck getting the work finished.

The jobs are just as the men left them when they quit work and there doesn't seem to be much prospect of having them finished right away. This job is under the jurisdiction of Lodge No. 96 and the gang are all members here.

With best wishes I remain,

L. A. FREEMAN,
Cor. and Fin. Sec. No. 96.

MISSOURI VALLEY, IOWA.

Dear Sir and Brother:

At a special meeting of Baldwin Lodge No. 145, B. of B. M. and I. S. B. & H. of America, the following resolutions were unanimously adopted:

Whereas, It has pleased Almighty God, in His infinite wisdom, to remove from our midst our worthy brother, John Halley, from his earthly home, Missouri Valley, Iowa; therefore, be it

Resolved, That we, his fellow brothers, offer our sympathy to his bereaved wife and family in this, their hour of affliction, and commend them to our Heavenly Father, Who doeth all things for our good; and be it further

Resolved, That a copy of these resolutions be given a separate page upon the minutes of this meeting, and a copy be sent to the bereaved wife and family; also a copy be sent to our official Journal for publication.

JOHN V. RICHARDSON,
ROBERT WARNOCK,
JOHN J. CHALOUPKA,
Committee.

FROM THE RAILWAY EMPLOYEES' DEPARTMENT.

St. Louis, Mo.

For the information of the membership at large, and particularly those who have been responsible for the misleading articles appearing in the Strike Bulletin and Railway Federationist, I am herewith submitting two letters for publication, which I trust will be the means of disabusing the minds of those who may have been lead to believe that either the officers of the Railway Employees' Department, or the Council members (composed of the General Presidents of all affiliated organizations), have been anything other than heartily in favor of having the Harriman and Illinois Central strikes investigated by the Industrial Relations Commission, and until informed to the contrary, we shall continue to believe that the Commission intends to hold the hearings, although we have no reason to assign for the delay.

Fraternally yours,

A. O. WHARTON,
President Ry. E. Department.

St. Louis, Mo., Jan. 25, 1915.

Mr. Frank Comerford,
905 Ashland Block,
Chicago, Ill.

My Dear Comerford:

I am taking the liberty to write you in regard to the arrangement we made with you last May in reference to your preparing for and representing the organizations involved in the Harriman and Illinois Central strikes, in presenting the entire subject matter before the Industrial Relations Commission.

You, no doubt, recollect the meeting we arranged for in Washington, D. C., during the month of May, at which you were present, when we talked this matter over with Chairman Frank P. Walsh, and on his advice we proceeded to New York to meet a Mr. Thompson, the attorney for the Commission, who, we were informed, had in charge the making of the Commission's itinerary. We met Mr. Thompson, I believe, on the 21st of May, 1914, and in my presence he assured you that our case would be heard when the Commission visited Chicago. Since that time I believed that the Commission would surely hear our case; we have left the matter entirely in your hands, believing that you would let us know if there was anything we might do to assist you, should occasion arise; for several months past articles have appeared in the Strike Bulletin and the Railway Federationist intimating that the Railway Employees' Department and the Council members thereof had, to say the least, become indifferent as to whether or not this case was heard. This, I believe, you know to be absolutely unfounded. We are, as stated to you on several occasions, particularly anxious to have this hearing held, and if you think that we can be of any assistance to you in this matter, we would be pleased to have you suggest what we can do. I can assure you

that we are absolutely at your service in this matter, and I trust that you will not be in the least offended because of my writing you on the subject, the matter having been left in your hands, we felt that you would call on us, if we could be of any service, not having done so, and feeling that something ought to be done, owing to the Commission having almost completed their hearings, I have, in conformity with the wishes and previous action of the Council, taken it upon myself to write you.

With best wishes, I am,

Sincerely yours,

Signed: A. O. WHARTON,
President Ry. E. Department.

SILVIS, ILL.

Editor-Manager Journal:

From time to time articles and letters appear in our official organ relative to industrial unionism or the one big union, but these articles are usually of a vague character and do not convey to the mind of the average reader as an intelligent analysis of this vexed question if—as it appears—to many of our members are interested in Industrial Unionism, let us carry on through the medium of the Journal a clean intelligent discussion, pro and con, let the members study this phase of the labor movement from every angle in a fair and broad-minded manner and let us have the results of their findings. The trouble has been heretofore, that some worthy brother would have a brain storm relative to some question, and before giving the matter second thought wanted to rush into print a long tirade of abuse and vilification of our grand lodge officers, which could not be permitted, or it would have a tendency to undermine and disrupt the organization and consequently, as some would have you believe, Brother Casey keeps the pages of the Journal under lock and key.

The writer is fairly well acquainted with our editor and I am of the opinion that anything that is in the advancement of the labor movement will gain ready admission to the pages of the Journal, as Brother Casey knows that the Journal is the mouth-piece of the members and as such it is maintained. I am fairly well convinced that the pages of our publication could be used to much better advantage than for a recital of what kind of an entertainment lodge so and so held, and how Bill Smith sang "Casey Jones," etc. These things are very nice and your humble servant likes his share of pleasure, but they fall dismally in telling us how to get a greater share of the products of our toil so that we can provide ourselves and those dependent on us with the necessities of life and a few of the luxuries.

Some of our members are condemning our Executive Council for rejecting the offer of the I. A. of M., for amalgamation. I fail to see how they could have done otherwise as our organization never has to my knowledge gone on record as favoring amalgamation with the Machinists, and when we do our officers will carry out the mandates of

the members as one of your delegates to the recent A. F. of L. convention. I had a good opportunity to study Industrial Unionism and hear the arguments of the proposers, which I may give later, but at this time I do not intend to go into the question any further than to say that I think the time will come when our individual craft unions will outline their usefulness as the gradual evolution of the world takes place institutions which fail to keep pace with the times go under so it behooves us to be ever on the alert and never let an opportunity go by to build up and strengthen our organization from time to time as in our good judgment we may deem necessary, but watching for the rocks and shoals and shaping our course accordingly.

Trusting to see this in print and many more along the same lines, I am

Yours fraternally,
CHAS. MACHOWAN.

PORT ARTHUR, TEXAS.

Dear Sir and Brother:

Your letter in reference to names I sent in for Journal under date of January 20th received, and will state that these names are to be added to those already in your office. I will endeavor to reconstruct our mailing list at an early date, but there will be some of these men here for possibly two months yet, that will be gone in that time.

Brother Casey, I am inclosing you two photos of the Sabine Netches Lock Gates which are now under construction six miles up the canal from here.

This work is being done for the government by contract, and the Chicago Bridge &

would give this work to our members, and that he had full charge and what he said went with the company, but in the face of all of his promises to us, when this work started he placed men on the job that he had imported here from Chicago for that express purpose. He never at any time intended to give our members this work. This firm, we have been able to learn, have run scab jobs all over this country, and was

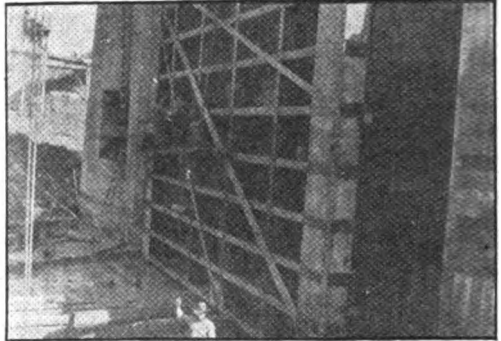

never known to pay the scale of wages. The strike situation here at this time stands about as it did after the first week of the strike. P. I. W. Co. are hiring scabs and we get them away from them about as fast as they come in. Scab A. M. Johnson, foreman, he secured the names of every man that he could before the strike took place and also their home address, and after the strike was called he rode around in his automobile and tried to get them to come out to work, some of these men he had been promising a job from day to day, as he expected every day would be his last day with the union men he started the job with, but when the men found that he only wanted them to come out and scab for him many of them refused and the others are coming off when they are informed by our pickets that the job is a scab job. No white man with love for his wife and children and his dear old mother at home would scab for such a corrupt outfit as the P. I. W. Co., when they are informed that the disgrace and shame of it will follow them and their children through life.

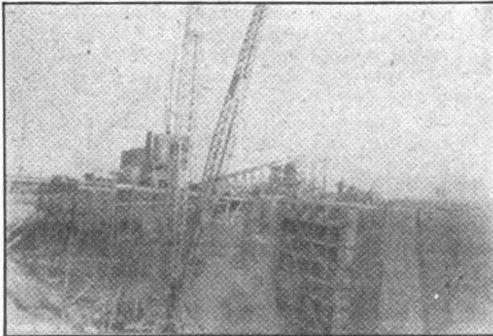

Iron Works have the contract. Local No. 305 has exhausted every effort to have this company employ our members and pay the union wages on this job, all to no avail, as this company has imported men in here from Chicago to do the work, and at less wages than the boiler makers and helpers here receive. Mr. T. J. Manley is the foreman of the job. Now Local No. 305 has declared this job unfair and efforts to get the men to come off the job have failed up to this date. This scab foreman, Manley, informed I. V. P., Jos. P. Ryan, a committee from Local No. 305 and B. A., who had several meetings with him before this job started, that he

I am also inclosing you one of the little cards that the Trades and Labor Council of this city are sending out to other central bodies in this and other states, notifying the different trades and laborers to stay away from Port Arthur, that all trades and classes of labor are overcrowded at the present. This is being done because the local papers and the Board of Trade are continually advertising all over the country that work is so plentiful here and what grand opportunities working men can find if they would only come here, when in reality, after the poor working man comes here and spends the last dollar to get here, he finds that he gets arrested for vagrancy and either has to work the streets to pay his fine, or walk

out of town, for the job he expects to find is not here, and he will find himself with hundreds of others looking for the same job.

I would appreciate it very much if you would reproduce this card in our Journal and keep it there for at least three issues.

The Reeves Brothers have made no effort to place scabs on their job here yet and the work lays just as it was left by our members.

Now we want to request all of our members to stay away from Port Arthur during this trouble, and we will put up a fight that will be a credit to the entire Brotherhood. Our cause is just and we are out to win and we will win, with the moral support of other organizations, and the keeping away from Port Arthur of all crafts. I am mailing you in today's mail under separate cover a copy of our labor paper. Hoping that you will be able to use part of this letter at least for the information of our members, and with best wishes to the editor of the Journal, I am,

Fraternally yours,

T. O. RILEY.

C. S. & B. A. Local No. 305.

RESOLUTIONS ADOPTED BY DISTRICT LODGE No. 15.

WHEREAS, There is a bill pending in the Senate and House of Representatives at Washington, D. C., known as (S. 6, 165), which bill is an amendment to "Boilers Inspection Law," and which, if enacted, will seriously effect the efficiency of this law as the inspectors have more work now than they can do justice to, and further, that a man may be qualified to inspect tenders and machinery, and not be qualified to inspect boilers.

Therefore be it resolved, That the convention of Boiler Makers and Helpers of District No. 15, now assembled, being held at Milwaukee, Wis., October 1, year 1914, demand that the Senators and Congressmen do all in their power to defeat said bill.

And be it further resolved, That practicable boiler makers be appointed as boiler inspectors.

GRANT BURGOYNE, Chair. No. 145.

WARREN WHEELER, No. 440.

ARTHUR EVANS, No. 589.

Committee.

NEWPORT NEWS, VA.

Editor of Journal,

Dear Brother:—

As President of Lodge No. 55, and one of many friends, I desire to express my most heartfelt sympathy through the columns of the Journal for the family of our late secretary and treasurer, Brother Wm. J. Gilthorpe, as well as my most sincere tribute of respect to his memory. His unexpected death was a shock to his many friends in Old Virginia.

The Brotherhood has lost a staunch and royal member, whose honesty was never questioned in the affairs of the organization. His name will go down in history of

the American labor movement as the Grand Old Man, courageous to a fault. When the interest of the Brotherhood, or its membership was at stake, his private life was above reproach; his official life was one of unquestioned integrity in the history of up-building of the Brotherhood of Boiler Makers from Ship Builders and Helpers of America."

He died in the work he loved so well; he fulfilled his mission in the cause he gave his life efforts to. I say farewell to his ashes, and trust that the members of the Brotherhood will erect a monument to his memory, on which the following words will be inscribed.

"William J. Gilthorpe, faithful until the end. Brotherhood of Boiler Makers from Ship Builders and Helpers of America. May he rest in peace.

Fraternally yours,

W. H. HEALY.

WAYCROSS, GA.

Whereas, It has pleased the Almighty God in His divine wisdom to remove from this world of trials and sorrow our former International Secretary-Treasurer, Brother W. J. Gilthorpe; therefore be it

Resolved, That we, the members of Lodge No. 425, extend to his relatives our heartfelt sympathy in this their sad hour of sorrow and may their sorrows be lightened by the thoughts that his spirit has departed to a higher and better world; and be it further

Resolved, That a copy of these resolutions be placed on the minutes and the charter be draped for thirty days.

C. W. SCHULTZ,

S. D. STALLINGS,

L. J. FLOHR,

Committee.

SILVIS, ILL.

Brother Casey:

Please insert the following in the next issue of our Journal:

Mr. John Koenig:

Our Dear Brother—The officers and members of Lodge No. 377 extend their heartfelt sympathy to you and your family in your hour of sadness, occasioned by the death of your only beloved son. May God help the mother bear her burden.

Resolved, That while we lament with sorrow we must submit to the will of our divine Maker who doeth all things well.

C. R. Kizer, C. S. L. 377.

CINCINNATI, OHIO.

Dear Sir and Brother:

Your favor of the 15th inst. at hand, and I wish you would please correct my article for the Journal and the roster which I sent you since I wrote you last. Brother Arthur Hileman, our vice-president, has secured a position at the C. & O. shops in Covington, Ky., and he was compelled to resign and take his card and deposit in Local No. 537. He was one of the best members we ever

had, a union man from head to foot, and never missed a meeting; so Brother John Davis was unanimously elected in his place as vice-president. He is an old war horse and will make good, as he has held various offices previously.

Wishing you success, I remain
Yours fraternally,
D. L. O'BRIEN, Secretary.

CHICAGO, ILL.

Dear Sir and Brother:

At our last regular meeting, January 20, the officers and members of Central Lodge No. 220 extended their heart-felt sympathy to Mrs. William J. Gilthorpe and family, in their hour of sadness, and join them in their hour of sorrow and pray that God will give them strength to bear their sorrow occasioned by the death of your beloved husband and father, and a brother who was one of our faithful and conscientious workers for the betterment of our organization.

Be It Resolved, That a copy of these resolutions be spread on the minutes of our meeting and a copy sent to our official Journal for publication, and a copy to the bereaved family, and the charter be draped for a period of thirty days.

JOHN KANE,
JOHN McDUGAL,
A. G. SMITH.

ROSLINDALE, MASS.

At a regular meeting of Norwood Lodge No. 281, the following resolutions were adopted:

Whereas, it has pleased Almighty God, in His infinite wisdom and power, to take to his reward our esteemed brother, William Sloan; therefore be it

Resolved, that while we bow to him above, we deeply lament the death of our worthy brother. We, his fellow brethren, extend to his bereaved wife and family our most profound sympathy, and may the Divine Ruler of the universe, who giveth and taketh away, give to them the strength and Christian fortitude to bear up under this great sorrow.

"A precious one from us is gone,
A voice we loved so well is stilled;
A place is vacant in that home
Which never can be filled."

Resolved, that a copy of these resolutions be sent to the bereaved wife and family, a copy sent to the official organ of our Brotherhood, and that our charter be draped for thirty days.

A. BENNETT,
W. PATTON,
R. HENDERSON,
Committee.

PORTSMOUTH, VA.

Dear Sir and Brother:

Local Lodge No. 298 held its annual election of officers in Central Labor Hall and afterwards the lodge with Locals 57 and 428 enjoyed a banquet in the private dining room in Hughes' Cafe. Sixty-five

boiler makers and apprentices were present.

The election of officers resulted as follows: M. A. Garriss, president; P. R. Peidmont, vice-president; G. C. Cherry, recording secretary; H. W. Jarrett, Financial secretary; Robert T. Howe, corresponding secretary and treasurer; Milton Claud, inspector; trustees, J. H. Pendleton, Theo. Carsten and J. W. Ford.

At the banquet, Brother A. E. Shultz acted as toastmaster; several short talks were made by members of the organization. It had been originally planned to have our International President, J. A. Franklin, and Second International Vice-President, Thomas Nolan, at the banquet, but owing to the pressure of business they were detained and could not attend.

An excellent menu was served and was enjoyed by all. The menu consisted of Lynnhaven oysters on half shell, fried oysters, chicken and potato salads, celery, sweet pickles, butter thin crackers, French drip coffee, fruit and cigars.

With best wishes, I remain,
Yours fraternally,
ROBT. T. HOWE,
Cor. Sec. Local No. 298.

DECATUR, ILL.

Lodge No. 447 gave its second annual ball February 11, 1915, which proved to be a great success. The advertising was properly handled by the chairman of our committee and his assistants, which resulted in a record-breaking crowd and a joyful time for all present.

The Boiler Makers ball beats them all for a jolly crowd and a good time. It was also a good success financially. Our committee deserves a great deal more credit and thanks than they received.

Boiler makers here are working eight hours per day, five and six days per week. Lodge No. 447 has a fine bunch of brothers and a large membership. If you have a good card you will get a hearty welcome, if you haven't any card stay away. Bill beaters will find rough sailing around No. 447 and you are not wanted; you are a menace to our organization.

CHAS. J. YOUNDER,
Cor. Sec'y.

NEWARK, OHIO.

Dear Sir and Brother:

I am a member of the Boiler Makers Union No. 99, and want to hear from the brothers living in the state of Texas; want to try the climate for asthma and lung trouble. Would like to have them tell me through the Journal of the climate in winter and summer, the price of land and labor of boiler makers, what vegetables and grains are raised there, is the climate a healthful one? Is it dry there in summer?

Would be pleased to hear from brothers living in Big Springs, Tex.

Fraternally,
J. D. BOWNEAN,

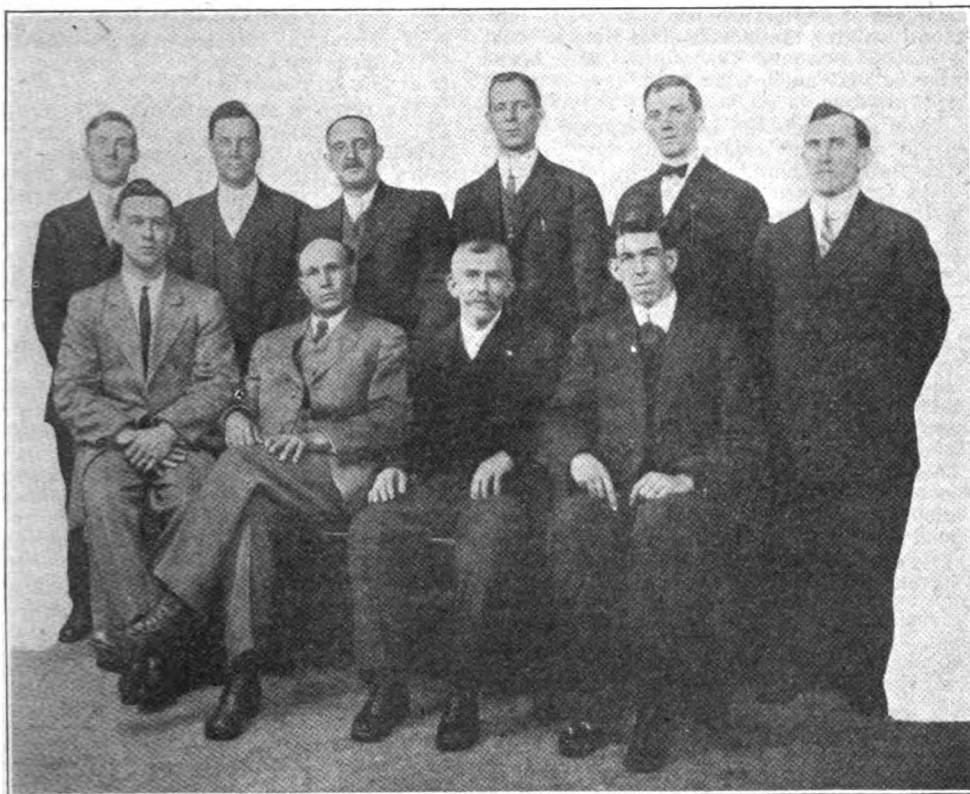

A GROUP OF THE DELEGATES TO A CONVENTION OF DISTRICT LODGE 31 (B. & O. SYSTEM) HELD AT PITTSBURG, PA., DECEMBER 1, 1914.

Standing Left to Right—318, T. A. Hudson; 135, T. E. Spence; 579, W. H. Wolf; 332, J. W. Drumming; 5, J. R. Cline; 444, T. Welsh.

Seated—493, D. E. Sturdevant; 79, S. Houser; 79, J. C. Smith, President; 241, M. W. Luke, Secretary and Treasurer.

WASHINGTON, IND.

Dear Sir and Brother:

I am mailing you herewith a picture of the delegates which represented District No. 31, of the B. & O. Railroad, for publication in our Journal. District No. 31 held its semi-annual meeting at Pittsburgh, Pa., December, 1914; delegates present are as follows: Standing left to right, No. 318, T. A. Hudson; No. 135, T. E. Spence; No. 579, W. H. Wolf; No. 332, J. W. Drenning; No. 5, J. R. Cline; No. 444, T. Welsh. Seated: No. 493, D. E. Sturdevant; No. 79, S. Houser; No. 79, President J. C. Smith; No. 241, Secretary-Treasurer, M. W. Luke.

Yours fraternally,
M. W. LUKE.

MIAMI, ARIZ.

Dear Sir and Brother:

Having never written for the Journal, I would like to put in a few lines in regards to Local No. 187, Miami, Ariz., as this local has done fairly well since Brother Dick organized it.

There was a strike here a little while back which was won. It lasted about two

weeks, but was the most peaceful strike I ever saw, and every man walked out except a few who were working for a contractor. He gave the conditions, which was all could be asked.

It started in this way. The men were talking for some time about going after the 10 per cent cut they got last fall, but what put speed to it was:

The master mechanic put a scab in the boiler shop at the Mine Mill. He was notified to take that man out as no one would work with him, but he said no. So it came to a show down; so out we came. Now the carpenters heard this and got busy as they thought the B. M. was after the 10 per cent, though all that walked out said, "might as well ask for the raise," which I must say we got. The boiler makers are getting \$4.25 now and the helpers \$3.25, and we also went up a notch on the outside scale to \$5.00 for boiler makers, \$4.50 for heaters and \$4.00 for helpers. As living expenses are not very cheap here I think we were justified in the demand. Some said we were too hasty, but I don't think so. I believe to strike while the iron is hot or don't strike at all. This

business of fooling around from two to four months giving the master class time to build a stockade around the works, they never give us that much time when they want to get rid of us.

Now what gets me is that I never saw a strike where all crafts went out together like they did here. As a rule each craft looks for its own hungry self. During this strike some work came up that belonged to the boiler makers, but was done by the bridgemen. We went after that work but did not get it. They would not live up to the agreement; said it conflicted too much with their constitution. That constitution I think was edited at Leavenworth, Kas., and rectified at San Quentin. They seem to consider every man a bum union man but themselves. I think their's is a bum organization when they won't live up to the agreements they make with the fellow craft men. There will be a blume flume coming up soon, but think we will have a fight on our hands to get it. I don't think that shows good union principle.

Hoping you will find space for this in the March number, I am

Yours fraternally,

E. J. BUEKLER,

Local No. 187.

Toledo, Ohio.

Buckeye Lodge No. 85 International Brotherhood of Boilermakers, Iron Ship Builders and Helpers of America, at their last regular meeting proposed and passed the following resolution:

Whereas, A certain body of men representing about one-tenth of one per cent of the men of Ohio seem to want the responsibility of making or having laws made for all the people, and to have radical changes made in several departments of the Industrial Commission of Ohio, such as separating the Engineers' Licensing Department and the Boiler Inspection Department from the Industrial Commission of Ohio and creating another Board, not to reduce expenses, nor to increase the efficiency of the departments, but to create jobs, therefore,

Be It Resolved, That this Lodge, in meeting assembled this Feb. 9, 1915, enter their protest against disturbing these departments or their consolidation of the Boiler Inspection Department with any other department; and be it further

Resolved, That we go on record as demanding that only boilermakers with practical experience in repairing, building and testing boilers be considered when vacancies occur in the Boiler Inspection Department; and be it further

Resolved, A copy of these resolutions be sent to all Representatives and Senators of Ohio Legislature for their guidance, and all Boilermakers for their endorsement.

E. RICHARDSON,

Corresponding Secretary No. 85.

CHICAGO, ILL.

J. A. Franklin, International President,
Kansas City, Kas.

Dear Sir and Brother:

The officers and members of Lodge No. 220, by a majority vote, wish to make an appeal to the Grand Lodge officers to restore the strike benefits to the striking members of the Illinois Central and Harri-man lines; said benefits were taken from them on December 1, 1914. Lodge No. 220, in requesting you to do the best you could in the calling off of the strike last October, did not have a thought as to the means you used in trying to have it called off, as she would not have made you that request, as we believe that as long as the strike continues, so long should benefits be paid, more so on account of being sanctioned by the Grand Lodge, and until the Grand Lodge officers call it off without the vote of the rank and file, we believe the pickets should be paid. For if the officers had power to take away the benefits without vote of the rank and file, so have they the power of calling it off.

The rank and file have stood loyally to the guns, and I believe they at least should be fed for so doing, and that is all they could possible do, would be to feed themselves, with the little compensation they would get.

The war in Europe would not last very long if the soldiers had to go very long with an empty stomach—such is the cast with the picket line, and if you think it is useless for them to do picket work any longer, then call it off before taking away what little compensation they received for so doing.

I do not see where the railway department of the Federation of Labor has a right or the power to dictate to our grand officers to violate our Constitution and take benefits away from the strikers. If such is the case then we had better change a few articles in it so as to protect men called on strike, such as the Blacksmiths are doing, for they are still paying benefits regardless of the railroad department of the Federation of Labor or their ruling.

We understand the conditions under which this strike was called, but since then there has been some changes made, one by which a certain amount of per capita tax was set aside in order to pay strikers who were called out by the Grand Lodge or their strike sanctioned by them and as long as there are sufficient funds it should be used for the purpose it was meant for.

Lodge No. 220 requests that a copy be made and placed in the Journal for publication, as we desire to hear from some of the other lodges and we would like to know their sentiment in regards to the paying of strike benefits.

Hoping this will demand your earliest attention, with best wishes, I remain,

Yours fraternally,

A. G. SMITH, C. F. S. Lodge No. 220.

WINNIPEG, CANADA.

The all important question, amalgamation, brought forward in the form of a resolution by President Johnston, of the I. A. of M., at our annual executive council meeting held October, 1914, at Kansas City, appears to have received but scant consideration at the hands of our executive, and the resolutions drawn up stating the reasons for their opposition is, to say the least, childish, and seems to have been drawn up by the committee while in a thoughtless attitude, as it contains absolutely no logic, is inconsistent and contradicts itself. Here is the resolution:

"Resolved, That we do not favor such amalgamation, for the following reasons: First—Past experiences have taught us that such an organization cannot be made a success. Second—We believe that our present form of organization will meet all the requirements of the workers, namely: The Metal Trades Department of the A. F. of L., the Railway Department of the A. F. of L., and the System Federation when perfected. The present forms of organization, not having been thoroughly tried, we are opposed to any movement whatever that will interfere in any way with a fair trial of same, and believe that all true unionists should lend their undivided support to the present form of organization, rather than to encourage new and untried forms, and thereby retard our progress."

This resolution was carried, with Brother Atkinson voting against it.

You will notice that it says, first: "Past experiences have taught us that such an organization cannot be made a success." Past experiences, where? Certainly not in the metal trades; at least, as far as our knowledge serves us; so the past experience referred to must be that of other organizations, and we must admit that we are ignorant of any labor organization that has tried amalgamation and found it unsuccessful. We will take a few labor unions who has tried out the scheme and see what results have been gained: There is the United Mine Workers' of America, the Western Federation of Miners, the Brewery Work and the Timber Workers. These four will suffice for our purpose.

The first two organizations are on the verge of a still closer amalgamation, evidently they don't think their form of organization has been unsuccessful; the fact is, that it has proved a success, so much so that they want a complete amalgamation of all workers engaged in the mining industry. When that becomes an accomplished fact, they will be the most powerful union in the country, if not in the world. As it is, they are at present the highest type of organization in the American Labor Movement. Let us follow: if we cannot lead.

Then there is the Brewery Workers, and Timber Workers. Have they been failures? Hardly. Of course, we do not desire to create the impression that the four unions mentioned are the personification of perfec-

tion; by no means. We are endeavoring to show that amalgamation is a step in the right direction, but many more steps will have to be taken before the workers come into their own, and that these unions having taken that step have benefited accordingly, and that they are more capable of looking after their own interest with their present form of organization, than they were under the past form. Why, the Timber Workers (previously the shingle weaver) have increased their membership over two hundred per cent—since they extended from the narrow craft lines to the broader industrial lines, which took place only some two years ago. So we think that we are justified in asking our executive to explain the first part of their resolution, giving us facts and not mere statements.

The second part of the resolution without re-quoting it, practically means, in fact definitely states, that the present form of organization fills the bill, and that it has not as yet received a fair trial, of course, what constitutes a fair trial is arbitrary, and we respectfully beg to differ with our executives, as to the present form of organization filling the bill. Something is wrong somewhere that requires a little more lucid explanation than the mere statement that we are all right as we are. We have had an overdose of defeats during the past few years, and there is no question but that these defeats are due to the want of solidarity on part of the workers. The feelings of solidarity are there but the present form of organization does not allow, or rather hinders its proper development, and the experiences gained through these setbacks are directly responsible for the present agitation for amalgamation. Have we learned anything from the Harriman, I. C. R. and Pere Marquette strikes, etc.? If so, what is it? We think that it has taught us the necessity of complete amalgamation quicker, and more unity of action—in other words industrial class solidarity. If that is not so, then what does it teach us?

The resolutions finishes up with the appeal not to encourage new and untried forms and thereby retard our progress. We cannot reconcile this statement with the first part of the resolution. "Past experiences have taught us that such an organization cannot be made a success," so we leave those who made the statement to do the reconciling.

Summing up the resolutions it consists of three statements, whose implications are:

(1). That amalgamation in the past has not yet been successful.

(2). That the present form of organization has not yet been properly tried out.

(3). That to encourage amalgamation, is to encourage new and untried forms whose only results would be to retard our progress. The first we have tried to show is a misstatement of facts and will not successfully bear investigation. Second, we contend has been thoroughly tried out and found wanting, and is in fact really the forerunner of amalgamation. The third and last state-

ment is hardly worth considering as it is contradicted by the first statement. Besides System Federation was new and untried forms a few years back. Then came Federation of Federations, etc., and now comes amalgamation. It is only through the adoption of new, the changing from one form to another, that makes it possible for the workers to keep abreast of the times. We have got to adopt ourselves to the ever-changing industrial conditions. The craft form of organization has served its purpose as far as the metal trades are concerned. The forming of the System Federation is an acknowledgement of that fact, that form being a great deal stronger than the individual craft, still through bitter experience we are finding out that even Federation is too weak to successfully combat the well-developed, thoroughly organized industrial masters, hence the demand for greater solidarity which we think can be accomplished through amalgamation. We do not think that the resolution issued by our executive council express the sentiments of the rank and file of our Brotherhood. Therefore we ask other lodges for their opinion of this important question, through the pages of the Journal.

Respectfully submitted,
C. DAVIS, President.
A. B. PAGE, C. S. Lodge No. 126.

KANSAS CITY, KAS

To the Officers and Members of all Subordinate Lodges:

Greeting:—I feel that it is hardly necessary to reply to the statement contained in the foregoing article from Winnipeg, Canada, upon the question of amalgamation, as I am fully convinced that the sane and sound judgment of the membership of our Brotherhood has long since passed judgment upon this question and that "Trades Unionism Versus Amalgamation or One Big Union" needs no defense at my hands. There are, however, some statements contained in this article that ought not to be permitted to pass without some correction.

In the first paragraph they claim that the resolution drafted by the Executive Council stating their reasons for disapproving of the proposition submitted by the International Association of Machinists was "childish and seems to have been drawn by the committee while in a thoughtless attitude." Now, I regret that it is not possible for our entire membership to place the authors of this article side by side with the members of the Executive Board and from the comparison between the two, draw their own conclusions. It might be well to add at this time, that there are members of the Executive Council who were affiliated with the labor movement, giving the very best that was in them in the interest of our movement when the authors of this article were in swaddling clothes. If such statements were not disgusting to men of sober thought they might be considered funny.

Now, in their comment upon the resolution, in the third paragraph, they state as follows:

"First: 'Past experiences have taught us that such an organization cannot be made a success.' Past experiences where? Certainly not in the Metal Trades."

They then admit that this is true, at least as far as their knowledge serves them. Well, this may be true; we will not question that fact, and I have very little doubt but that they have spoken the truth, but because of their knowledge being limited in matters of this kind, it does not signify that the statement of the Executive Council is incorrect.

As a matter of suggestion, and in order that they may become more familiar with the history of our movement, let me suggest that they go back to the earliest days and ascertain for themselves what form of organization we first had in this country, of the metal trades, what it consisted of, what degree of success it attained and whether it is not a fact that real success only began to come to the different trades when they organized in their craft unions. Then all down through the history of our movement in this country, as well as in others, we find that every movement that has sprung up, gathered into its folds a conglomeration of trades and started out to revolutionize the industrial conditions of the country has gone on the rocks and been torn to pieces. Then, if amalgamation is the proper solution will our friends please advise us why it has not proved a success in the past? It is a wonderful thing to dream dreams and to see visions. They remind us of the boy with the clay pipe and the pan of soap suds, blowing bubbles in the air and watching them soar for a while, only to burst and scatter to the winds.

Now, let us deal for a moment with the organizations to which they have called attention, as an evidence that their contention is correct: They call your attention to the United Mine Workers of America, the Western Federation of Miners, the Brewery Workers and the Timbers Workers. Now, we desire it understood that we haven't one word to say in opposition to any of these organizations; we glory in the success they have made and in the fight they are making for industrial freedom; but let us see to what extent these organizations are amalgamated, as pointed out by the authors of the foregoing article: It is true that the United Mine Workers control all men in and around the mine. Now let us see to what extent they have amalgamated with other trades: We will take for instance a mine employing from four to five hundred men and we will find, outside of the miners, the men employed in the mine, and the laborers around the top, possibly two or three blacksmiths, an engineer, one or two firemen and not more than two carpenters, and we ask that a comparison be made between the number of men who might be eligible to other trades, with those who would not be eligible to any other organization except the

Miners. The same is practically true of the Western Federation of Miners as well as the Brewery Workers.

Another point that must be considered is that in most instances these men, who would be eligible to other trades are so isolated that it would be almost impossible for them to maintain a local union. Now, we leave it to any fair-minded man to judge as to whether or not the argument advanced by citing the four above named organizations has any bearing whatever upon the proposition of amalgamating the metal trades into one organization.

We claim today that we have amalgamated to as great a degree as have any of the four above named organizations because of the fact that we have in our organization, the boiler maker, the ship builder, the tank builder, the helper, in other words all the men employed in the industry in which we are engaged.

The point is made that still further amalgamation is contemplated by bringing together the two organizations of Mine Workers and I am agreed that this is the only logical conclusion for the men engaged in the mining industry to arrive at, if the membership of those two organizations decide that it is the desirable thing, for the reason that those men are all engaged in mining and we see no reason why there should not be consolidation or amalgamation, that can only take place when the majority of the membership of both organizations are agreeable, and believe that their best interests can be conserved by uniting the two organizations.

The question is asked as to whether or not these two organizations have been a failure, and we agree fully with the writers that a great work has been performed by all of these organizations, but we disagree with them in the contention that they can be properly considered amalgamated organizations.

With reference to that part of the resolution which states "that the present form of organization, not having been thoroughly tried out, we are opposed to any movement whatever that will interfere in any way, with a fair trial of these organizations" and maintain now, that that statement is absolutely correct. We have the Metal Trades Department, which is, in every sense of the word, in its infancy and provides every opportunity for co-operation to the very fullest extent. The same is true of the Railroad Department and our System Federations. If it is impossible to secure co-operation and support, one for the other, through these departments it would undoubtedly prove a total failure to attempt to amalgamate or place all of these craft unions in one organization. It has been demonstrated (and we challenge contradiction of this fact), that there are some of these trades that are advocating amalgamation of craft unions into one organization, that have found it impossible to consolidate locals of their own individual organizations—and I refer to locals that are composed of men em-

ployed exclusively in contract shops with those composed of men employed in the railroad industry, and if it is impossible to consolidate locals of one trade, we contend it would be impossible to consolidate locals of all the different trades under one charter.

It is our experience that those who are finding the most fault with our present form of organization are those who either fail to co-operate with or to put into effect branches of the Metal Trades or System Federations, as they should be organized and handled in order to bring success to the membership of the different crafts involved.

We are told by those who advocate amalgamation and one big union, that in the event we were organized in accordance with their ideas we would still have to maintain separate branches or locals of the men employed at different trades, but that they would all be under one head; then we hear the advocates of this form of organization criticising and claiming that every one is inconsistent and insincere who differs in opinion and who still maintains that the trade union movement in its present form, with the different departments we have at this time, providing means for co-operation and unity of action, is the most scientific form of organization that the world has ever known.

The foregoing article winds up with the statement, "We do not think that the resolution issued by our Executive Council expresses the sentiment of the rank and file of our Brotherhood." We are perfectly agreeable that the membership shall decide this question for themselves, but we do not agree that one here and there, who happens to make considerable noise about this question is voicing the sentiment of what they term the rank and file, and we believe that we have been in as close touch with the membership and know possibly as much about their sentiments and views on this subject, as those who claim to voice the sentiment of the rank and file.

Much more might be said with reference to this attempt to criticise and condemn the organization that has proven itself to be the greatest factor in the emancipation of the workers from the industrial evils of any agency that has been known up to the present time, but we are content to leave it to your judgment to decide for yourself.

Assuring you, one and all, of our best wishes and kindest regards, I am,

Yours fraternally,

J. A. FRANKLIN,
International President.

HUNTINGTON, W. VA.

Dear Sir and Brother:

I hereby trust that you will allow a short space in the Journal for these few lines.

Local No. 249 held a banquet on January 13, 1915, which proved to be a booming success, and from the appearance of things all brothers seemed to be very well satisfied.

An interesting address of welcome was delivered by our president, John Myers. We had with us on this occasion our shop superintendent, Mr. Brown, who gave a very fine address on the progress of today and the drawback and hardships in time of war, which the inhabitants are now enduring in the European countries. Our general foreman, S. M. Carroll, also attended and talked very interestingly on the latest improvement of mechanical education; that is, the advantage the apprentice boys obtain over the older heads, by means of the mechanical school which has recently been established.

Now comes our assistant foreman, Brother Buffington, whom it seems had partaken of a little too much supper to give much of a speech, and the boys were somewhat disappointed, as he is very talkative while at work; however, they were much pleased to know that he had his fill of a good, square meal, at least on one occasion.

Several other well formed addresses were delivered, including that of Buck Waugh, who proved to be a better dancer than spokesman.

With the last year Local No. 249 has had some hard ups and down, but with the opening of the new year the boys have all gotten their heads together once more, and prospects look more promising.

Help! is the cry of the thirsty in West Virginia. How can we get it home from the depot? That is the question now troubling the thirsty ones.

At present we are working only seven hours a day; a great number of us are striving to keep out of the poorhouse, while others are striving to get in.

All the brothers are extremely sorry to learn of the death of Brother Wm. J. Gilthorpe, our former I. S. T., and extend our most heartfelt sympathy to the bereaved family; nevertheless we realize that it was the will of God to take him from among us.

With kindest regards and with best wishes, I am,

Yours fraternally,
EUGENE BRENNAN,
Secretary No. 249.

EAST BOSTON, MASS.

Dear Sir and Brother:

Lodge No. 585, in common with the rest of the Brotherhood, heard with great regret of the passing away of the former International Secretary-Treasurer, Brother Wm. J. Gilthorpe, whose career was actuated by the loftiest principles of truth and honesty, and who, although retired from active participation in the workings of the organization, never lost his interest for the welfare of the members of his craft, and was always willing to lend his voice and efforts in their behalf.

On February 4 Miss Margaret Foley, one of the most eloquent and convincing leaders of the Massachusetts Women's Suffrage Association, addressed the members of Lodge No. 585. She said in part:

"We are grateful for the opportunity to talk to the voters of Massachusetts, for, on November, 1915, the male voters of this state will decide on the question of the constitutional amendment to grant the right of voting to women, and we are confident that when the men hear our arguments, they will vote to grant the right of suffrage to women, which has already been granted in Australia, New Zealand, Finland, Isle of Man, Denmark, the British Isles, Canada, Wyoming, Utah, Colorado, Idaho, Washington, Arizona, Oregon, Kansas, Illinois, Montana and Alaska.

The solid West with us proves that equal suffrage must have worked well, for those great states copy each others success, not their failure. Women in the Western states have been voting from two to 46 years back, which ought to prove to every fair-minded man that they have been given a square deal. The trade unions of the country have brought our cause to the front, and we have started here in Massachusetts, where begins the battle for the abolition of human slavery, the crusade for the emancipation of women from the chains of political slavery, which now binds her! This is an opportunity for any working man to stand by the working women. Here in Massachusetts the right to vote was first given to men of a certain religion, then men of all religious beliefs were allowed to vote, then the taxpaying qualification was struck out, and finally all mentally qualified white and "black" men were allowed to vote. We want the word "male" stricken out from our constitution as a qualification for voting! The cry went up when suffrage was granted to male wage earners of Massachusetts—if we (the aristocrats) give the working men the right to vote, they will corrupt the government, but the political history of our country proves that it has been the rich and mighty, and not the poor working men, who have tried to corrupt the government, and so we are told if women are allowed to vote in Massachusetts, what will become of their homes and their children? Let me tell you men, in reply to that query, that I am a trustee of the Children's Institutions of the city of Boston, and I have under my care hundreds of innocent children who have been neglected by their fathers. We are human beings, and we believe every white woman in Massachusetts is as good as any black man! We want a chance to frame legislation for the adequate protection of women and children in our factories and shops, which is woefully deficient at present.

"We have 24 health inspectors here for about 50,000 establishments! We do not agree with those that tell us that voting is a man's business. Wherever a man earns his bread, that is his business. One hundred years ago woman's place was the home, for she left it hardly more than three times—to be christened, to be married and to be buried! Today women are engaged in every industry, except the army

and navy, telegraph, etc., construction and about nine other industries.

"We have in Massachusetts today 379,775 women wage earners, of whom 91,000 are married, and three-quarters of these mothers who are feeding and educating their sons to be respectful citizens, have an average of four children apiece, and they have a right to participate in the system of government. We must face the situation as it is. Women are in industrial life to stay. We must use Twentieth Century tools to do Twentieth Century tasks! Every fair-minded man must see that 'the government' is us, we, the people; not men alone, but men and women together. By men and working women together, we shall have a just and true democracy, and as Abraham Lincoln says: 'One that does not exclude women.' We are pleased to see that you have followed the example of the Massachusetts State Branch of the American Federation of Labor, in supporting our cause, and we thank you for the same."

Miss Foley received an ovation on ending.

President Wm. E. McNabb reported that the annual ball of Lodge No. 585 would be held on the night of April 9, at Sumner-Lyceum Hall, East Boston, and the committee in charge, which is striving hard to make the dance a big success, consists of Brother W. E. McNabb, Thos. Farmer, F. Gardis, D. B. McInnes, J. Vincent, Dan Higgins, Chas. Smith, Bernard McDonnell, Chas. Jenkins, Ed Scorvin, John Cartright, Wm. Clouter, Robert Mills, John Warnock, James Brogan and Generson.

Several new members due to the persistent hustling of our business agent, Brother Generson, were added to our list, and we are glad to note Brother Generson is working in perfect harmony and in accord with the sensible ideas of Sixth International Vice-President John J. Dowd, in promoting the cause of trade unionism in our craft in this part of the country.

One of our old members, Brother John Welsh, died the early part of this month after two days' illness of pneumonia. He left a wife and small children in hard circumstances, and President McNabb, in behalf of poor Jack's widow, wishes to thank all those who, by their sympathy and financial assistance to her in the day of tribulation, proved themselves friends in need, which was only proper, because big hearted, good natured Jack Welsh was always responsive himself to such a worthy cause.

Fraternally,

DANIETL B. MCINNES,
Lodge No. 595.

WINNIPEG, CANADA.

Dear Sir and Brother:

At our last regular meeting the following motion was made and carried, namely:

Whereas, Trade has had a decided slump through the effects of the European war and has caused unprecedented unemployment and short working hours for many of our brothers, we desire that the pages of

the Journal be used to discuss the advisability of lowering the Grand Lodge per capita tax, during this period of depression only.

While asking this, we do not believe in low dues, and the resultant assessments, but from our present experience the high dues are making previously good members fall behind.

Trusting this will be in order, and hoping to see this in our Journal next month, I beg to remain,

Yours fraternally,

FRANK SNARE,
Cor. Secretary Lodge No. 451.

MILWAUKEE, WIS.

Dear Sir and Brother:

Yours of the 6th inst., in regards to the strike, and will say that everything is going on nicely. The brothers are all on the job and tending to their duties. We still have hope of coming to some agreement as soon as work picks up.

Our Business Agent, Brother Sonnberg, has been following up the outside work and also notifying all the engineers about Milwaukee Boiler Co. We also had it brought up at the Federated Trades Council and are going to bring it up at the Building Trades Thursday night, when we will be installed, which I think will go a long way.

At present the Milwaukee Boiler Co. are only orking eight hours a day, and five days a week. They have only about seven men employed. Some of the men that went back scabbing are also laid off.

Trusting this will be satisfactory, I beg to remain,

Yours fraternally,

R. DALE, F. S.

THOMAS—HIS BROTHER.

Anyone knowing the whereabouts of James G. Thomas, (last heard of was in Salt Lake City, Utah, and expected to go to Oklahoma) will please notify the undersigned, his brother.

J. R. THOMAS,
Burneyville, Okla.

A REPLY FROM PRESIDENT FRANKLIN.

Kansas City, Kas., Feb. 16, 1915.

To the Officers and Members of all Subordinate Lodges:

Greeting:—The foregoing letter from Lodge No. 220, in reference to the I. C. and Harriman lines strike, contains statements that necessitate a full explanation in order that our membership may have the facts in regard to this controversy.

In the first place, our Executive Board, in their October meeting, decided that they were not justified in continuing the picket benefits to men supposed to be doing picket duty on the I. C. and Harriman lines. The Executive Board of some of the other organizations had already taken action along this same line, and inasmuch as this was a Federation proposition, it was finally decided that 30 days' notice would be given to all lodges before the picket benefits were

discontinued, and consequently the notice was issued to all lodges that on December 1, 1914, benefits that the several organizations had been paying for the past three years would be discontinued, as they were all of the opinion that they were not justified in continuing these benefits under the circumstances.

At the time this was done a proposition was put up to the membership—the men who came out on strike on the I. C. and Harriman lines to decide for themselves as to whether or not they desired to continue the strike. This action was taken particularly because of the fact that large numbers of requests had been received asking that steps be taken to have the strike declared off, and one of these requests came from Lodge No. 220.

You will note this letter states they are of the opinion that these benefits should continue as long as the strike continues, on account of its having been sanctioned by the Grand Lodge and until the Grand Lodge officers call it off.

The fact that the Executive Council has power or authority to discontinue the payment of benefits whenever in their judgment an action of that kind is necessary, and for the best interests of the organization, cannot be questioned, as the Constitution is clear on that point.

Again, the writer of this letter from Lodge No. 220 states that they do not see where the railroad department of the Federation of Labor has a right or power to dictate to our grand officers, to violate our Constitution and take benefits away from the strikers. Now, it is just such misleading statement as this that cause a great deal of dissatisfaction unless the facts are placed before the membership. Section 3 of Article VI, reads as follows: "The International Executive Council shall have power, by a two-thirds vote, to withdraw any financial assistance from any lodge on strike for such reasonable length of time as careful investigation and consideration reveals the fact beyond a reasonable doubt that the men cannot be sustained." This answers in full the charge that the Executive Council violated the Constitution and I wish to state, most emphatically, that the railroad department did not dictate to our Executive Board, nor did they have any influence whatever, over them in the action taken. as the Board had decided upon taking this action prior to the meeting of the Executive Council of the railroad department.

In another paragraph of this letter it states that they are familiar with the conditions under which this strike was called, but state further that since the calling of the strike, there have been some changes made, one by which a certain amount of the per capita tax was set aside in order to pay strikers who were called out by the Grand Lodge or the strikes sanctioned by them, and that as long as there are sufficient funds they should be used for the purpose

for which they were meant, and let me state that the strike fund is used solely and exclusively for the payment of strike benefits and for no other purpose.

As to the statement that there have been some changes made in the Constitution with reference to the setting aside of a certain per cent of the per capita tax, this is incorrect and misleading. This was not done since the strike was called except insofar as the law was amended. The provision setting aside a certain percentage for payment of strike benefits was made at the St. Paul convention in 1908, and has no bearing whatever on the question at issue.

Inasmuch as this letter states that they are familiar with the conditions under which the strike was called, I am furnishing herewith copy of a letter sent to all lodges in District No. 20, which was signed by the President and Secretary of the District, also by Vice-President Hinzman, advising the members in advance of their taking a vote that they were only granted moral support, and after reading this letter our membership can be the judge as to whether or not these men were, under our laws, legally entitled at any time to regular strike benefits. This same information was conveyed to all of the men on the Illinois Central and Harriman lines prior to the strike being called. The letter containing instructions to District No. 20 is contained in the following letter:

Waterloo, Ia., Sept. 15, 1915.

To All Lodges Comprising District No. 20,
Greeting:

Inclosed you will find copy of letter drafted by the International Officers representing all of the organizations affiliated with the System Federation on the I. C. Railroad. The letter explains, in a measure, why action has not been taken by the International Officers towards calling the men out. Believing that our members voted on a strike with the understanding that all organizations would act as a unit in this matter, we have insisted that the whole matter be referred back to the rank and file for further consideration. We also wish to inform you, so that each and every member may know, before he casts his ballot, that our organization is not in a position to pay strike benefits, our executive council have voted to sanction the strike and calling out our members, granting them moral support, if they wish to stand by the Federation. By moral support you will understand that the International organization will lend all possible assistance, but is positively unable to pay strike benefits, owing to the large amounts of money expended for this purpose.

We are also forwarding to you, under separate cover, blank ballots to be filled out by our members. In voting upon these propositions your attention is called to Article XII, Section 4, page 45, Subordinate Lodge Constitution. We hope that all locals and members will carry out the provisions of our constitution to the letter, that there

may be no complaint after the ballot is taken.

As soon as the ballot is cast your secretary should forward ballots, with tally sheet, to E. G. Pullen, secretary District No. 20, 503 Columbia Street, Waterloo, Iowa. You will also place the result of the vote for and against upon the minute book of your lodge. You must understand that this is to be strictly a secret ballot. Fill out the blanks on the ballot and make an X in the square under yes or no for each proposition on the ballot, but do not write your name on the ballot. All ballots must be in the hands of the Grand Lodge officers by October 1, and in order to do so, it will be necessary for all ballots to be in the possession of the District Secretary not later than September 25. All lodges should act as promptly as possible on this, so as to avoid any further delay.

Each and every member should vote according to his own dictation and not allow anyone to influence him one way or the other, and no attention should be paid to any rumor or statement of any kind, and act only upon official information and in accordance with the constitution of our organization.

With best wishes and regards, we remain,
Fraternally yours,

A. HINZMAN,
First International Vice-President.
K. H. EICKER,
President District No. 20.
E. G. PULLEN,
Secretary District No. 20.

At our last convention, held in San Francisco, June, 1914, the benefits were discontinued to our membership on the New York Central Lines, and the same action was contemplated with reference to the Illinois Central and Harriman Lines, and the writer had possibly as much to do with preventing this action being taken as any other member, not because he failed to appreciate the fact that the convention had the authority, but because of the fact that the Illinois Central and Harriman Lines was a Federation proposition, and for that reason he did not deem it advisable that any action of that kind be taken at that time.

Every possible effort was made for three years to finance the men on strike on the Illinois Central and Harriman Lines by making donations, as we could not pay regular strike benefits, because of the fact that these strikes were sanctioned with moral support only, and at this time some would have you believe that a great crime has been committed by the executive officers because they have discontinued the payment of further benefits after they were convinced that they were not justified in continuing benefits after December 1, 1914.

Trusting this will give you the facts in connection with this matter, and with best wishes to all, I am,

Yours fraternally,

International President.

BROOKLYN, N. Y.

Dear Sir and Brother:

I, as the Correspondence Secretary of Lodge No. 21 of New York City, do wish you would insert this little item in the next month's Journal. It is as follows:

Whereas, It has pleased the Almighty God in His divine wisdom to remove from this world the little son, three years old, of our worthy brother, Geo. Boylan; therefore, be it

Resolved, That we, the members of Empire City Lodge No. 21, extend to our brother and family our heartfelt sympathy in this their hour of sorrow, and pray that the Almighty God comfort and console them, that they may bear their trial with fortitude; and be it further

Resolved, That a copy of these resolutions be spread on the minutes of our meetings, a copy forwarded to our bereaved brother and family and a copy sent to our official Journal for publication.

PETER SHIPTON,
J. SULLIVAN,
JOHN BYRNES,
JAS. MCGENEY,
Committee.

REPORT OF INTERNATIONAL DEPUTY ORGANIZER SCOTT.

Pottsville, Pa., Feb. 15, 1915.

Dear Sir and Brother:

My last report for the Journal was written in Albany in December, having been ordered there to take up some matters with Lodge No. 73 at Troy. On arriving there I proceeded at once to get in touch with the officers of Lodge No. 73, and was informed by Brother Boyd that the out-laying points on the D. and H. system were in bad condition and sadly in need of attention; that there were thirty-two men working at three different points between Watervliet and Plattsburg, N. Y., and only four of them were carrying cards in our organization. After securing all the information possible, I started out for Saratoga Springs, Whitehall and Plattsburg, the points mentioned by Brother Boyd, and am pleased to state that on my return to Watervliet a few weeks later, when I made my report to Lodge No. 73, I was able to report that we had almost a hundred per cent organization at these points, having secured twenty-seven of the twenty-eight men complained of. We have had Shop Committees selected to look after the men employed at these places, and it is safe to say that the interest of the men, as well as of the Organization, will be taken care of in the future far better than they have been in the past.

From Watervliet I went to Oneonta, by instructions from President Franklin, to take up some work for Lodge No. 414. On arriving there I went down to the shop and met Secretary Lowery, and was informed by him that there were a few men working in the shop who were not members of the Organization, and were determined not to become members. I visited some of these

men at their homes and talked with others in the shop during noon hours, and succeeded in getting one of them to fill out an application. The others promised in the presence of Brother Lowery that they would get into the Organization as soon as possible, but had all kinds of excuses for not going in at that particular time. I attended a meeting of Lodge No. 414 while in Oneonta and found that the members were not taking the interest in the Organization that they should. I have been informed that it is a very hard job to get some of the members to attend a meeting; they are satisfied to allow two or three men to do all the work and imagine they are doing their full duty when they pay their dues—but some of these days something will happen there that will wake those fellows up, and then they will realize, when it is too late, the mistake they have been making. Before leaving Oneonta I went with the shop committee to interview Mr. Halter in reference to a grievance that has existed for some time in Binghamton. We secured a promise from Mr. Halter that the matter would be adjusted at once. Having finished in Oneonta I left for home to spend the holidays with my family.

During the time that I was at home I visited Pen Argyl and Pottsville. The Lodges in both these towns are in bad shape, due to the depression in business that seem to have hit both these localities hard. I did everything I could to help them, but it was impossible to render much assistance at that time. Later on we will be able to get both these Lodges in shape again.

While in Pen Argyl I received instructions from President Franklin to proceed to Middletown, N. Y., and take up some work on the O. and W. system. I attended the O. W. system Federation meeting in Carbondale, Jan. 16 to 18, and then came back to Middletown to take up the work where I had left off. I attended two meetings of Lodge No. 400, and I want to say that they have a good, progressive, fighting Organization in Middletown.

I went from Middletown to Kingston and spent some time trying to organize the men employed by the Ulster & Delaware. There are about six or seven boiler makers, a few helpers, and a few apprentices employed in this shop. The majority of the boiler makers are suspended members, who have been out of the Organization for some years, and it was impossible to do much with them. That \$15.00 looked too big to those fellows. I did, however, succeed in getting one boiler maker's application and reinstated another. Both of them went into Lodge No. 400. We have all kinds of promises from some of the apprentice boys, and I believe that we will get a few of them later on.

From Kingston I went over to Warwick. Among the men on the Lehigh and Hudson I found about twenty-one employed there, and only two of them carrying cards. Through the efforts of Brother Pat Rooney a meeting was arranged and we succeeded

in getting sixteen out of a possible nineteen to make out applications. Chances are good of getting two more in a short time. These men were also put into Lodge No. 400 at Middletown, and a committee from that Lodge consisting of Brothers Springer, Apple, Pollock and Smith attended a meeting at Warwick and assisted in the Initiation Ceremonies. I believe these men will make good. They are all aggressive young fellows, and with a little coaching from Brothers Rooney and Cooney, the two old guards there, the time will come shortly when it will be a case of no card, no work, at Warwick.

I went from Warwick to Maybrook, N. Y., to try and straighten out the men employed at the C. N. E. roundhouse. There are five boiler makers here, and only one with a card. This is a point on the New York, New Haven & Hartford System. I had a little meeting in the roundhouse Sunday afternoon, and I don't think it will be any trouble to get these men, as they are anxious to straighten out. I didn't have time to wait over until they got paid, so I wrote Brother Apple at Middletown to look after them.

Before leaving Middletown I attended a conference arranged by the O. and W. Federation Officers between Superintendent Flory, Brother Harvey Brown of the Machinists, myself, and a Federation Committee, for the purpose of taking up a grievance regarding a violation of our Agreement by Master Mechanic Barry, at Mayfield, Pa. Mr. Barry is a new man on the job, and like all new men, he has a lot of new ideas, one being that he was going to do away with all overtime and cut down the expense. He was going to take advantage of some loopholes he thought he saw in our agreement, and posted a notice Jan. 17, or 18, assigning a machinist, a boiler maker and a blacksmith, together with their helpers, to a ten-hour a day basis. This we claimed to be a violation of the Agreement, as there had been a notice posted previous to that stating that the shop time would be five eight-hour days. It was decided by our committee to allow Brother Brown to handle the case, as he was more familiar with it than the rest of us, and I am glad to be able to report that he succeeded in convincing Mr. Flory that it was a direct violation of the Agreement. We not only had the practice stopped, but also succeeded in getting five hours overtime (according to the Agreement) for every hour and thirty minutes these men worked over eight hours since the time Mr. Barry hung up his second notice.

From Maybrook I came to Pottsville, under instructions from President Franklin, and am now working on the toughest proposition I have had to handle in many moons, but hope to be able in my next report to show a good healthy gain here.

This concludes my report to date, but before closing I would like to extend my sincere thanks to Brothers Rooney and Grant for the assistance they gave me at Warwick and Kingston. Our success in Warwick was due to the efforts put forth by Brother Pat

Rooney more than to anything else. His time and his money were spent without stint in an effort to assist in organizing this shop, and it was no fault of Brother Grant's that we did not succeed in Kingston.

Respectfully submitted,

CHAS. F. SCOTT,
International Deputy Organizer.

Winnipeg, Man., Can.

Dear Sir and Bro.:

At the regular convention of District No. 30, held in Winnipeg last week, the following resolutions were unanimously passed:

Resolved, That the delegates present representing District No. 30, in due session, go on record as desiring a free discussion in the pages of the Journal, whether it be re-amalgamation of the Metal Trades or any other question relating to the welfare of the Brotherhood, without undue interference from International Officers with the freedom of the discussion, and that this resolution be forwarded for publication in the pages of the Journal.

I may say this resolution was prompted by the report of delegates of Lodge No. 126 that a resolution of their lodge had been unduly shelved by you, on the grounds that President Franklin must be given an opportunity to reply to it, (before it has appeared in the Journal) and it was felt very strongly that President Franklin should reply to it after it has appeared, and not unduly prejudice the consideration of it by its initial appearance being accompanied by a counter blast by President Franklin. This is the liberty of the press as understood on this side of the line.

With best wishes, I am

Yours Fraternally,

GEO. F. CHADBURN,
Secretary-Treasurer Dist. No. 30.

A Note from the Editor.

In answer to the above resolution, the Editor desires to say our constitution contains laws for his guidance and regulating the policy of the Journal, which must govern in this matter, regardless of the wish of any of our members, and those laws places a limitation upon discussions and specifically prescribes certain subjects that may not be brought up for discussion. We believe this limitation is wise and in consonance with the very form of our organization, for the trade union movement is based upon a neutral and limited platform of principles upon which all who desire to join in an economic movement for their betterment may stand, regardless of their political or religious affiliations or beliefs. One of the first requisites for its success is unity, and anything that would tend to cause dissensions should be avoided. To allow an unlimited discussion of any and every subject in the Journal, many of which would be at variance with the trade union movement, would soon cause dissensions and therefore should be avoided.

In reference to the communication from Lodge No. 126, it consisted of a criticism of

the Executive Council of our Organization, and in the opinion of the Editor, common courtesy to the men selected to guide our organization as well as loyalty to same, demanded that a representative of the Executive Council be given an opportunity to reply to the article in the same issue in which it appeared. The article and President Franklin's reply to same appears in this issue.—The Editor.

Livingston, Mont.

Dear Sir and Bro.:

I write this for publication in our Journal to explain why Lodge No. 123 started the referendum, published in this issue, to put the Grand President's salary where it was before the San Francisco Convention.

Now I shall endeavor to be fair and just, and abuse no one, but I insist on my right as a member to the use of our Journal to expose what hundreds of our members are dissatisfied with, and it must be rectified if this organization is to endure. The conditions under which the salary was raised is well understood by all who watched the proceedings of that Convention. To begin with, the Convention did not have delegates from over one-half of the Locals in good standing, and several Locals were represented by Grand Lodge Officers who drew their regular pay from the Grand Treasury and was no expense to the Locals they represented.

At this time hundreds of men were out of work, working short time, or on strike. At this time our General fund was nearly exhausted, even after the Grand President had laid off the Deputy Organizers and all but one of the Grand Vice-Presidents for three months because he had used the transportation fund to pay salaries and expenses and had to get the money back, hence no organizers at work when they were badly needed. Yet, in the face of these facts, our Grand President, on the eighth day of the Convention made a speech favoring the increase, and he a candidate for reelection. Well, I should call it immodest at least; we all know that times are worse now than then, strike benefits have been stopped on struck roads and new strikes called with at least 20 per cent of the members idle and over 50 per cent of the rest on short time.

Now, as to the increase being unwarranted, I think the above facts prove that, if it does not compare the earnings of the average Brother with it. I believe we should pay our Grand President as much as we can afford and I believe we were doing so before the raise when you consider his expenses are paid while away from Kansas City, and note also that his hotel bills are not kept to the three dollars per day (\$3.00) but he often charged \$3.50. His own statements of expenses will prove that and it is illegal, as he is not entitled to any more than our Vice-Presidents, and it looks bad to the Boomer riding the side door, or the striker whose benefits are stopped or the striker working short hours and trying to keep his

family from actual want and keeps up his dues, to see our officials so swelled up with false pride, that they think they must imitate the example of representatives of billion dollar corporations in order to do the work they are elected to do. This is wholly wrong and the billion dollar men do not expect it and know we cannot afford it, but what do they care, the more we spend that way the less we have to fight them with.

This vote will show if the membership would have granted that raise by referendum.

Now the unpleasant part, unpleasant to me you may be sure, but some diseases require bitter medicine; the machine controlled Convention read the minutes of that convention, notice the personality of many of the delegates, harken to the voice of First Vice-President Hinzman, "The idea of one man appointing a committee and so forming a machine is ridiculous." How else is a machine made and maintained but by one man power and subservant helpers? Again harken to Bro. Hinzman, "The rank and file are not competent to elect committees to act on these matters." Is that not Machine Politics? I contend the members of the Brotherhood are competent to intelligently handle any question that pertains to their welfare. We hear too much of this bombastic mouthing, on par with Kaiser Wilhelm's "Me and God." We common dubs may be a little off sometimes, but the Divinely appointed also makes mistakes. Now, if the members want this amendment to pass, see that it is endorsed by your local at your next meeting. Don't vote for it if you think the raise honestly obtained and the wish of the majority. Now, you will hear the beneficiaries of the Machine rule howl about this, and we may expect to hear these Deputy Grand Organizers, Business Agents and Vice-Presidents making very plausible arguments against it, saying we are setting a bad example by cutting pay, also the cost of the referendum will be more than the money saved for years, and the facts that some other organizations are paying more than we are to their Executive heads. This, I hold is a poor argument. If a man who cannot afford it wishes an automobile, and sees fit to mortgage his home to get one, I am not compelled to do the same to be in style. We are paying higher dues than most of the Brotherhoods who pay the fancy salaries, but we are not banded together to see who can pay the highest salary, but to better our conditions and pay the Brother who does our business for us a fair wage. There is one thing sure, this petty graft must be cut out. I see that the officials, some of them, must take a Pullman to ride 15 or 25 miles, and we pay it, the small sum of 45 cents, 50 cents, 75 cents. I say Brothers, take a day coach on those short hauls and remember the men who pay the fare for you are freezing and hungry, riding box cars and hoping there is a pie card at the next Terminal.

Now, I trust this will be received in the same spirit it is written, and vote your convictions; if we are defeated, well and good, but we are determined to have a try for what we consider justice, equal rights for all, special privileges for none.

Fraternally yours,

C. J. MAES,
Of Lodge No. 123.

CARD OF THANKS.

Oswego, N. Y.

Dear Sir:

I, Mrs. Mary Anna Ryan, wish to give my heartfelt thanks to the Brotherhood of Boilermakers, Iron Shipbuilders and Helpers, especially to International President Franklin and Secretary-Treasurer Reine-meyer, for their kindness in settling the death benefit of my deceased husband, the late John L. Ryan.

Wishing the best of success for your Organization and all its members, I am

Respectfully yours,

MRS. MARY ANNA RYAN,
East 8th St.

A WASTE BASKET OF STUFF.

Pawhuska, Okla.

Dear Sir:

Incompetent Boiler Inspectors of Federal Boiler Law. I note under head of our gray-headed second vice-president Billy Nolan's report, February Journal—give it to Billy for coming out with just as he thinks and writes. Since this law has been in effect, I have had experience with these paper Boiler Inspectors from Foremanship to box car riding. Now, the question is, how can experienced men of 25 to 30 years at the Boiler making business tell conditions of boilers the way the Paper Federal Inspectors inspect boilers. Example of paper inspectors I have come in contact with are, they see locomotives standing on side track ready for call, steam, fire, coal, oil and all egt. for road, this paper inspector will walk over like a king, pull out a big \$1.50 electric auto trouble lamp, look at all tel-tale bolts, then the blow-off cock springs up in cab, try water glass, left injector, then right side, try gauge cocks (one leaks) lubricator (no shield) right injector (packing nut leaks) crawls down, stands off, see if any holes in stack, also if number plate is on straight, ties engine up until work is done—(that's No. 1). Never look in fire-box—forgets it; now he goes to another engine (fooled by a coat of good black paint) same as No. 1, but ties Eng. up account of cylinder head leaks and machinist has to put in 4 7/8-in.x3-in. standard thread, studs; at same time this engine has a crack from bottom flue-hole to 1—stay bolt of mudring and flues are in very bad condition, still boiler is O. K. Now, he has inspected two engines in twenty-five minutes, almost before an experienced boiler maker can find his inspecting hammer and light. Now, he comes to back shop, just ready to test pair 1/2 side sheets—pressure is up, he sticks his head in door, also that

\$1.50 auto trouble light, looks down left back corner, says to boilermaker what is leaking, (Boilermaker wise) says nothing, is that not water leaking out some place. If he had been boilermaker, not out of paper, why not dart under mudring instead of crawling upon deck to look in fire-door? Well, when this pressure was on 30 old bolts break by the local inspector's hammer and this paper boilermaker was not competent enough to find them after pressure and water was out of boiler; same time he makes out report on Government form, Boiler O. K., with 30 broken bolts found later by local inspector. Now, this paper Boiler Inspector just has to be done away with; we want practical men that cannot inspect 15 to 50 boilers in one day of 8 hours.

Now, this road did not, (when I was working there) have enough boiler makers on system to do running repair and fire boxes and engines were in such condition they could not handle the tonnage they were classed in, but all were in fine shape by the paper Federal Boiler Inspector's report, and of course his knowledge, I have seen cracks in crown sheet from 3 to 8 inches long, he never even found them; at the same time I am writing this, just as well give local Inspectors a rap.

Local inspector is as much to blame for conditions of working in shops as any—panic has hit this, supposed free country—now some will say "Why are we to blame?" You local Inspectors with knowledge, experience and gray hairs—put your name under others right in cab that the boiler is O. K., and so many bolts renewed, at same time, you don't condemn that engine for a crack 1 to 24 inches long or mudring corners eaten completely away, cracked all over fire-box, also cracks in back head

flange that blows to the coal; no you calk them up, laugh and say let the other fellow do it, afraid of your job. Now, the only way we are going to be able to get you one of these Federal Inspector's jobs is for all to visit your senator, get his personal interview, if he does not bring it up to get those paper inspectors out, let us, after this paper guy gets done, inspect this boiler, prefer charges against him for incompetent inspection for this certain engine or boiler; tha tis our only relief from present, as I had a personal interview with one of the leading senators regarding these Paper Inspectors, and he outright told me it would have to come fro man appointed committee, from senators, before he would even mention it on the floor.

Now, I have laid down the boilermaker's hammer, but not my card; am in automobile business, and if I ever pick up another hammer in boiler shop I expect to try my motto if I do get tied up with our supposed free government laws, but I cannot get in any worse than some of the committees I have been on; also I am well known by Grand Lodge officers as well as west of Mississippi. Our past President Wm. Taft could not appoint some shoemaker for Chief Inspector, also senators could not of had chief to appoint his republican friend, as the examination that was taken did not amount to the paper it was written on.

Hoping this will be in Journal and all my old-time Boilermaker friends will see and read same, also your local inspectors try and take a whack at me; I am open for all argument on same.

Wishing the Grand Lodge success, I remain

Yours fraternally,

J. F. WRIGHTMAN.

A Compilation of Labor News.

BY THE A. F. OF L. NEWS SERVICE.

HATTERS PETITION CONGRESS FOR RELIEF.

Washington.—On Wednesday the five United States Representatives from Connecticut each presented a petition to Congress asking for an appropriation to relieve the petitioners from the award of damages made by the court in the case of D. E. Loewe, hat manufacturer of Danbury, against them. The petition recites the history of the controversy and the suit, in all its phases through the courts, and also recounts the general understanding that the Sherman Anti-Trust Law should not have been held to apply to the voluntary organizations of the working people, and that the courts did so hold, and that under the interpretation of the Sherman Anti-Trust Law the hatters of Danbury were mulcted in damages to the sum of \$252,000, with interests and costs, amounting to nearly \$300,000. The petition sets

forth that either the United States Congress in enacting the Sherman Anti-Trust Law erred in failing to make its meaning clear, insofar as that the act was not to be applied to the normal activities of the organizations of labor, or that the courts erred in interpreting the law that it did so apply. And that in either event Congress should make an appropriation to meet the award made by the court and relieve the 161 petitioners who otherwise would have their small savings and investment in humble homes confiscated to satisfy the judgment. The petitioners are the survivors of the 243 who were originally sued, and all of them are of far advanced age.

The United States of America.

To the Honorable Senators and Representatives of the States comprising the United States, in Congress Assembled:

We, the subscribers, residents and citi-

zens of the state and district of Connecticut, respectfully represent:

That we are journeymen hatters and for many years have been members of local associations of hatters; associations formed not for profit, but for mutual protection and advancement; associations of which the membership are justly proud for the reason, among other, that their existence in this country dates back to the period of the Revolution, at which time they were known as "Hatters' Guilds," and by virtue of membership in such associations we have become members of the United Hatters of North America. That your petitioners, the subscribers thereto, are not officers of the United Hatters' Association, or of the local unions of which we are members. Indeed, many of us, by reason of advanced age, are exempt from attending meetings and payment of dues. Nor have anyone of us taken any part, either directly or indirectly, in the doing of the several acts for which we have been cast in judgment in the sum of over a quarter of a million of dollars and under which the judgment-creditor will now take the little savings resulting from a lifetime of work and frugality, a large part consisting of the humble homes in which we have hoped to pass our declining years. The statute upon which has been rested the claim of right to a judgment against us is the so-called Sherman Act, passed by your honorable body and approved on the 2d day of July, 1890, and entitled: "An Act to Protect Trade and Commerce Against Unlawful Restraint and Monopolies."

We are informed that said act was not designed or intended to apply to or affect labor organizations or combinations of working men, and this was stated repeatedly in the discussion of the measure in and by your honorable body prior to its enactment into law, and neither the subscribers nor any other persons had any knowledge that the law could be held to apply to the normal acts of labor organizations until the question had been submitted to and decided by the Supreme Court of the United States, the matter coming to said supreme court from the decision of the trial judge by whom, as a question of law, it was decided that the law did not apply to associations of working men.

Nevertheless, in an action brought by D. E. Loewe and another in September, 1903, against your petitioners, and a number of others, many of whom have since deceased, the plaintiffs have recovered judgment, not only for the full amount of damages sustained, but for a sum which, in the aggregate, is three times the amount of the damages actually sustained by the plaintiffs. The theory of the action is that the defendants conspired together to restrain the interstate trade and commerce of the plaintiffs. The methods employed to that end, it is charged, were (1) a strike by which the union employes of plaintiffs quit work. It is not pretended that the strike was not fully authorized by the law of Connecticut,

or that a single act was committed by any one of the strikers which was not lawful under the law of that state. Indeed, the strikers never sought to even discourage anyone from entering the employ of the plaintiffs. On the contrary, they advised non-union workmen to continue the work. All the strikers did was to go away, never to return. Moreover, not one of your petitioners was an employe of the plaintiffs.

(2) It is further alleged in the complaint and proved that for a number of years prior to the acts complained of the United Hatters' Association had agents upon the road urging the purchase of hats bearing the union label. But this was not illegal. Indeed, sound public policy not only encouraged, but authorized its use, as is shown by the fact that the statutes of forty-one states permit the use of the union label, and the courts protect it from the frauds perpetrated by those who would advantage themselves by the popularity of the label. The theory of the plaintiffs is that, notwithstanding the sanction of the law, the union label can be, and is made an effective instrument of boycott. As it happens in the case a jury has been encouraged by the courts to find that a strike lawfully conducted under the laws of the state of Connecticut, and the use of the union label, and of agents in other states where it is perfectly lawful to do so, together constitute a restraint of the plaintiffs' interstate trade and commerce. Assuming, as we must, now that the court has spoken, that these perfectly lawful acts constituted an unlawful conspiracy to restrain the interstate trade and commerce of the plaintiffs within the intent and meaning of the Sherman Anti-Trust Law, nevertheless, we humbly invite your attention to the fact that we, your petitioners, had no lot or part whatsoever in the doing of any of these things to which reference has been briefly made. We repeat, no one of us was in the employ of Loewe & Co., but were employed by other hat manufacturers, some in other towns than Danbury; no one of us was consulted about it by anyone, officer or employe; no one of us, by word or deed, sought to bring about or encourage the strike; no one of us was an agent on the road urging the use of the hatters' label; nor did he have aught to do with the sending of agents upon the road, nor were we familiar with the work of the agents, and if there were any illegal acts performed, we had no knowledge of it.

Indeed, we were hardworking employes who had been frugal in preserving as much as possible of our earnings for the closing days of our lives. Those savings have been invested, from time to time, in our humble homes.

When the action above referred to was brought, it was commenced against each one of us by the attachment of our several homes, and in the instance where a little savings bank account had been created, in addition to the home, such account was attached. In other words, the selection of

the defendants in this action, which was determined by the counsel for the American Anti-Boycott Society, who were also counsel for the plaintiffs, was based on the ownership of property and not on conduct from which the plaintiffs claim to have suffered injury. Each and everyone of the 9,000 members of the Hatters' Association, wherever over the United States they were residing and having property, could have been selected as defendants upon precisely the same grounds as your petitioners;

That said Sherman Act was not designed or intended to apply to or affect labor organizations or combinations of working men, and this was stated repeatedly in the discussion of the measure in and by your honorable body prior to its enactment into law, and neither the subscribers nor any other person had any knowledge that the law could be held to apply to the normal acts of labor organizations until the question had been submitted to and decided by the Supreme Court of the United States, the matter coming to said supreme court from the decision of the trial judge by whom, as a question of law, it was decided that the law did not apply to associations of working men;

That through the construction and interpretation given to said law by said supreme court a condition has been created and now exists which was not contemplated or intended when said law was framed and enacted, in that labor organizations have been held amenable thereto and the individual members thereof have been subjected to the penalty of triple damages thereby provided;

That the condition above mentioned has grown out of a certain action brought by D. E. Loewe and another, in September, 1903, under the said act, against the subscribers, and a number of others who have since deceased, in which action, the homes and bank accounts of the defendants were attached and held to respond to any possible judgment recovered in said action;

That the homes and bank accounts so attached were the results of work and savings and accumulations of many years spent by the defendants in their occupations as journeymen hatters before the act referred to had been conceived or enacted, and the efforts and accomplishments of their entire lives were affected by such attachment and possible judgment;

That at the time said suit was commenced and said attachments made, the defendants, in many instances, were already old men who had exhausted their earning capacity, and since that time, which is almost twelve years ago, many others of the defendants have ceased to have earning capacity or powers, and of the original defendants, numbering 243, to the number of 82 have passed away, leaving widows and children, whose only inheritance is the little estate of the deceased defendants, incumbered by the burden of said attachment;

That during the period mentioned in the complaint in said action the defendants

were engaged in earning the means of providing for themselves and their families, and had no knowledge that they or the organization of which they were members, or the officers thereof, had done or were doing any act or acts in violation of the Sherman Anti-Trust Law, or of any other law;

That by reason of the decision of the supreme court that the act referred to covered the actions of labor organizations and their members, a judgment has been entered against the subscribers in the action above mentioned and in favor of said D. E. Loewe and another for the recovery of two hundred and fifty-two thousand dollars (\$252,000) and interest and costs, and said judgment and costs, if satisfied by the defendants, must be satisfied through the loss of their homes and bank accounts, and the reducing of many of them and possibly the widows and children of deceased defendants to the position practically of paupers, with the probable consequence of throwing upon the state the burden of their support;

That this situation is due to the construction of the aforesaid Sherman Anti-Trust Law by the supreme court, in giving to it the not intended effect of applying to labor organizations and in not limiting its application to combinations and monopolies by capital and capitalists, as was intended by your honorable body.

That such construction was made possible through unfortunate phraseology in drafting said act, and by the misconception of its scope and breadth; and hardship has thereby been brought upon the subscribers;

That your honorable body enacted a law, approved by the President, October 15, 1914, known as "An Act to Supplement Existing Laws Against Unlawful Restraints and Monopolies, and for Other Purposes," and commonly known as the Clayton Anti-Trust Law, and by the provisions of which labor organizations are exempted from the operation and effect of all anti-trust laws, and such organizations are now permitted to do the things for which, under the act hereinbefore referred to, the supreme court held them and their members to be liable; and said Clayton law now provides specifically for that which was thought and intended to have been provided, though indirectly, in the Sherman Anti-Trust Law, and inferentially vindicates the belief of the defendants, and of the members of the labor organizations generally, that they were intended to be and were exempt from the effect of said act;

That from the hardship brought upon the subscribers through the construction placed on said Sherman Anti-Trust Law by the supreme court, and the loss of their homes and bank accounts through the satisfaction of said judgments, and the evil consequences resulting therefrom, the subscribers have no recourse, no source to which they can look for relief, other than your honorable body;

Wherefore, the subscribers humbly petition your honorable body to take such action

as may be necessary and proper to appropriate from the funds and revenues of the government such a sum of such sums of money as may be required to liquidate and satisfy said judgment, and to relieve the subscribers from the unintended and unjust effect of said Sherman Anti-Trust Law and the unexpected construction given thereto;

We respectfully urge that for obvious reasons your honorable body take immediate action, if in your judgment the subscribers should be relieved, as prayed for in this petition, and as in duty bound, your petitioners will ever pray.

(Signed)

Thomas A. Evans, Henry C. Jude, Mrs. William Ochs, Charles H. Greene, Charles H. Frost, Mrs. Levi Short, William F. Ohler, Mrs. Frederick E. Benedict, Owen Murray, Byron B. Morgan, John L. Keane, Reuben Johnson, Frederick S. Blackburn, William Deakin, Martin McGetrick, John Crotty, Thomas Boyd, John J. Calpin, William E. Geartner, John Hassett, Byron Brooks, Christisen Reinhold, Peter O. Boy, Theodore Bright, Adolph Hordeishel, Andrew Aitken, Frank Rohde, John Prilcher, Michael Hurd, Emil Flosky, Fred Q. Stuhe, Nelson H. Booth, Martin Keating, Patrick J. Marthy, Michel Corbet, Achille Canale, George M. Herrick, Giuseppe Tosi, Byron W. Crane, Theophilus Abierriste, Frank K. Wildman, Nicholas W. Barzin, Patrick Troy, Daniel Murphy, Thomas H. Allan, Barney Murphy, George T. Oakley, Clemens Beschle, Chr. G. Garni, Thomas McGauley, Wright Hampson, Myern J. Ironside, D. H. Barney, Henry C. Michael, Samuel S. Willson, Frank Krebs, Michael Hennessey, D. V. Dibble, David J. Hardy, Edward D. Lees, Patrick T. McCarthy, William V. Nowlan, Patrick McGrath, Timothy H. Farrell, James P. Callahan, Michael P. Kenny, William S. Dutcher, James Crotty, Alphonse Bresson, Herman Bohman, Jeremiah McCarthy, Thomas E. Waters, John Harkness, Charles Shaffer, Frank Kornhaas, Patrick Feeley, G. J. Miller, Thomas Leonard, George F. Denton, Eugene L. Mulkin, Thomas McHugh, Thomas Foley (X—his mark), Nicholas W. Allen, Patrick Hart, Charles A. Hodge, John J. Callahan, Mrs. James L. Costello, Daniel Kearns, Abrah S. Pearce, William Humphries, George Shuckey (X—his mark), John Keogh, William Clary, James Dillon (X—his mark), J. H. Craft, John Leonard, Charles F. McHan, J. M. Blake, Martin McCue, John McGlone, James McGlone, Peter J. Brennan, James N. Boughay, Michael F. Lynch, Elmer R. Clark, Lewy W. Comes, Alex. Harkness, Frank Seaman, Patrick Jeffrey, Timothy Murray, O. B. Nowlan, Stephen Haveran, John Elhigett, Daniel McInerney, Thomas Keenan, Patrick Fisher, Charles W. Hurd, Martin Lauf, Andrew G. Brown, Chauncey H. Butler, John H. Collins, George A. Davis, Patrick Keating, John E. Rooney, John E. Paul, Fanton W. Beers, John Redway, Peter J. Ward, James Kinnaw, Edward

Cunningham, Frederick H. Taylor, Thomas M. Saunders, Thomas Tayhe, Owen A. Riley, Additon F. Hathaway, Albert Berg, Max Singewald, Charles J. Flynn, William J. Weiselt, James S. Whitney, W. H. Brennan, Charles Smith.

LIABILITY LAW TO STAND.

Columbus, Ohio.—Insurance interests in this state, working through the Ohio Equity Association, have been defeated in their first attempt to have the legislature change the present compensation and liability law by allowing liability insurance companies to operate in the state. The amendment was virtually killed when the house of representatives, by a vote of 74 to 25, accepted the report of its labor committee to postpone the bill indefinitely. The present law does not permit the employer to insure with a private insurance company against liability for accidents to employes. Manufacturers and trade unionists are acting jointly to repel the effort to modify the present law. It is agreed that the present system should be permitted to work experimentally for at least two years.

HOLDS LIFE CHEAP.

Royalton, Ill.—It is stated that the coal company at this place, where fifty-two miners' lives were recently lost by an explosion, has offered \$25,000 for a settlement in full. This is less than \$500 for each of the lives lost. Officers of the State Federation of Labor make this comment on the company's offer:

"This demonstrates most clearly the need for a compulsory compensation law in Illinois. Even under our present unsatisfactory law, if the company had been operating under its provisions, the widows and orphans would have received \$1,500 each, immediately, at the time when they needed it most. The chances are if the women and children collect more under the liability law than the company now offers, it will be years before they get it."

TUBERCULOSIS DECREASES.

Washington.—Deaths from tuberculosis are decreasing, while those from cancer are increasing, says the United States census bureau, in a report just issued. The state of Washington has the lowest death rate from all causes, and New Hampshire has the highest. Suicides decreased in 1913, as compared with 1912. The death rate from tuberculosis declined from 149.5 per 100,000 population in 1912 to 147.6 in 1913. Deaths from cancer rose from 63 per 100,000 in 1910 to 78.9 in 1913.

Automobile accidents for the year caused 2,488 deaths, while 2,921 were killed by horses and in accidents caused by other vehicles, principally those horse drawn.

WOULD RAISE WAGES.

Boston.—Prof. Fisher, of Yale University, told an arbitration board that is considering wage demands of the Bay Street Railway

Company employes that even if a street railway company was suffering under financial stress, and it was necessary to discontinue certain trips, the company should not hesitate to increase the wages of its employes to meet the new conditions because of the increased cost of living. He also said that the working day is too long, both from the standpoint of the employer and the employe, and, in the case of a railroad, from the standpoint of the public as well.

VOTE FOR SUFFRAGE.

Harrisburg, Pa.—By a vote of 130 to 71 the house of representatives passed the resolution proposing an amendment to the Pennsylvania constitution to give women the ballot. If the senate concurs, it will be submitted to the voters next November.

UNIONISTS STATE POSITION.

Jefferson City, Mo.—For the purpose of refuting claims made by defenders of the convict leasing system in this state, that unionists are not a unit on the question, officers of the organized workers have issued the following statement for the benefit of legislators:

"We are, first of all, unalterably opposed to the use of the state prisoners by private contractors for their personal gain. We favor the use of the convicts by the state manufacturing such things as are used by the institutions and political subdivisions. The state has a perfect right to pass a law compelling its municipalities to buy their equipment from the state. If the products of the state prison must be sold in the open market, we would a thousand times rather that the state should manufacture and sell the products and apply a part of the profits to the upkeep of the innocent dependents of the unfortunate prisoner.

"Believing that the intent and purpose of the state prison should be to reform its delinquent subjects, we are strongly in favor of classifying the prisoners, which would prevent those who have committed their first offense coming into contact with the hardened criminals.

"As a beginning of the final abolition of the leasing system, we would respectfully suggest that provision be made for the establishment of a broom factory, a brick plant, shoe and clothing factory, also a factory for the manufacture of school and other furniture used by the state, counties and municipalities. We also heartily indorse the governor's recommendation regarding the purchase of a 1,000-acre farm and the enlarging of the binding twine factory."

PROTEST POSTOFFICE CUTS.

Washington.—In protest against salary reductions of postal clerks and letter carriers, Representative Buchanan, member of the House labor group, has introduced a resolution asking the Postmaster General to inform Congress why the economy plan of the

department is directed against the low-salaried men in the ranks, while the officials with large salaries are unmolested.

The resolution has the indorsement of the National Federation of Postoffice Clerks, affiliated to the American Federation of Labor. In explanation of the need of a congressional investigation into the postal department's method of reducing expenses, Thos. F. Flaherty, legislative representative of the postoffice clerks, said:

"The clerks and carriers are as loyal and as self-sacrificing as any body of men. If the needs of the service demand retrenchment, we will stand our proportionate share, but we object to having the efficient men in the ranks, the hard-working, plodding clerk and carrier, suffer a 20 per cent wage reduction on the plea of economy, while no effort is made to shave the princely salaries of the departmental and service political favorites. If salary reductions are necessary, let them be more equally distributed.

"The situation in Chicago is typical of the entire service. Four hundred clerks and carriers were reduced \$100 and \$200 because of falling revenues, caused largely by placing the catalogues of the mail order concerns into the parcel post classification, which means a \$4,000,000 annual loss to the Postoffice Department. The already sorely tried employes must now suffer wage reductions to make up the \$4,000,000 gift to the mail order houses."

LOW WAGE ADVOCATES SCORED.

Phoenix, Ariz.—In his message to the state legislature, Governor Hunt makes this reference to opponents of the initiative law providing for the employment of only 20 per cent of aliens, which has been annulled by a federal court:

"Perhaps, in view of what has transpired, as a result of the justifiable perturbation of Arizona's workingmen over a denial of their right to legitimate employment, the few individuals who have been so unworthily eager to debase the state's citizenship by the introduction of such foreign labor elements, under conditions of employment which would not be tolerated by an intelligent workman, will draw such observations as may be the precursor of a more upright policy of hiring workers, and of keeping down the costs of mine and railroad operation. At least, it is logical to conclude that such employers as continue to fly in the face of public sentiment will reap the highest calumny and general condemnation which they have merited so completely."

ARE APPLYING CO-OP. THEORY.

Gillespie, Ill.—The Co-operative Society of this place has just issued its seventh quarterly report. The society has declared a 10 per cent dividend on the basis of the purchases of the members. This is about its average quarterly dividend, and means that in the year and nine months of its existence each member of the society has been

paid back 70 per cent of his average three months' grocery and coal bills, equivalent to supplies for over two full months, besides, of course, getting full weight and measure and the best quality of goods.

Odin, Ill.—The local union of mine workers has started a co-operative movement and equipped a grocery and supply store in the best possible manner. It is stated these workers have succeeded in bringing about a very substantial reduction in the cost of living.

Harrisburg, Ill.—The co-operative store has issued a report in which the assets exceed the liabilities to the amount of \$2,778.45. It is announced that a uniform rate of 5 per cent interest will be paid on all paid-up shares.

Farmington, Ill.—The local co-operative society reports substantial progress, and all affairs are in a satisfactory condition.

VOTE INVESTIGATION OF JUDGE DAYTON.

Washington.—The House has unanimously adopted a resolution from its judiciary committee providing for an investigation by the committee of charges against Federal Judge Dayton, of the northern district of West Virginia.

The charges were filed several months ago by Representative Neely, of that state, and provided that the committee inquire whether Judge Dayton, among other things, "had shown marked favoritism to certain corporations having extensive litigation in his court," and "whether he had lent his services as judge to the coal operators of West Virginia by improperly issuing injunctions; whether he has shown hatred and bitterness toward miners on trial in his court; whether he has used his office as judge to discourage and prevent said miners from exercising their lawful right to organize and peaceably assemble under the laws of the United States and the state of West Virginia."

After investigating the charges, the committee reported an investigation was warranted, and in this the House has concurred.

Judge Dayton has attracted nation-wide attention because of labor injunctions which have been issued from his court.

STATE POLICE BILL CERTAIN.

Troy, N. Y.—Says the Legislature Labor News of this city:

"Governor Whitman has agreed to the terms of a bill to create a mounted state police force, to consist for the first year of two troops of 119 officers and men each, to be raised to four troops by 1916. These officers are to patrol the state, and may make arrests with or without warrants. Four hundred and fifty thousand dollars is provided to establish the department.

"The Pennsylvania state police only number 225.

"According to the plan, the members of the constabulary will patrol the highways of the state. They will act in small groups, one always being near a telephone, so the force can be reached immediately in any part of the state should need for them arise.

"The State Federation of Labor is on record in opposition to a state police force, and the local unions of the state are sending in strong letters of opposition."

"PHOSSY JAW" OUTLAWED.

"Phossy jaw," the occupational match-workers' disease, has been outlawed now in every part of America, due primarily to the efforts of the American Federation of Labor in championing the Esch bill, which passed the Sixty-second Congress. Shortly after Mexico issued an administrative order against it; and recently the Canadian parliament wiped the continent clean.

ACCIDENT TOLL GREATEST.

Washington.—That death's toll in war is less than the number of persons killed in preventable accidents in the United States each year, and that a Washington child runs a greater chance of being killed on the streets by a vehicle than he does of dying of diphtheria, scarlet fever or smallpox were two of the points emphasized by William F. Peabody, president of the Washington Safety First Association, in an address in this city.

"As many people were killed in New York during the last three years in street accidents as were killed during the entire seven years of the revolutionary war," said Mr. Peabody. "In the United States in one year two-thirds as many people have been killed in accidents, that could have been averted through the application of 'safety first' principles, as were killed in the entire Civil War."

Among Our Exchanges.

THE COMMUNITY'S DUTY TO THE POOR.

From a Private Letter by Frederick C. Howe, Commissioner of Immigration.

I am very glad to amplify what I said in Cleveland in reference to private organized charity. I do not believe in it; do not be-

lieve that organized society has any right to turn this most sacred of all functions over to any private agency. Even though it might have been justified fifty or a hundred years ago, it is no longer justified when industrial conditions make it impossible for the individual to control his work, own his tools, or create opportunity of any

kind. Charity is a social, not an individual burden, and society itself should maintain all of its relief agencies. Certainly it should maintain the most sacred of all, the investigation, care and maintenance of those least able to care for themselves. It should substitute municipal relief for private relief.

Further than that, I think it is an arrogant assumption for the rich to pass upon the worthiness or unworthiness of the poor. If anyone is to perform this function it ought to be the poor themselves. Christ was very loath to judge; and the judgments registered by organized charity through paid employes do as much to destroy the self-respect of the poor and make them feel that they are charity patients as anything I know.

I am speaking just as strongly as I can about this, because I feel just as strongly as a man could on this subject. I believe in a public police and health department, but I believe far more in a public relief department.

Further than this, we are, so far as I know, the only civilized people who sanction the idea that one class should be endowed officially with the right to look after another class. Foreign autocratic countries perform all their relief through public agencies.

I will even go farther. In my opinion private organized charity is an obstacle in the way of justice. If we had no such organizations men would think of fundamental reforms; they would think of ways and means to abolish the causes of poverty, rather than the consequences of it. I know of many instances where organized charity opposed practical movements, like motherhood pensions, minimum wages and housing reforms. Why? It seems rather hard to say it, but I believe it was because the class which administers charity is the class responsible for poverty. It is responsible through the unjust economic conditions which this class perpetuates. And it is the very halo which organized charity throws around itself that makes it doubly difficult for us to penetrate to the real cause of industrial injustice and put an end to it.

There is nothing radical in what I am saying. Practically all of the poor feel this way; they all feel that their self-respect is undermined every time they have to go to a charity organization society, and they only go to them as a last resort. And we have no right to require this of them. You, I, or anyone else maimed, injured and distressed by the injustice of present-day conditions have a right to go to our fellows, to the city, to the community, and demand that the community itself shall bear the costs of the community's own wrongs or of industry's wrongs, for the wreckage of society today is social; it is no longer personal.

In speaking thus directly, it is with no criticism of any individuals, or any lack of respect for individual men who are engaged in organized charity. It is the sys-

tem that I protest against, just as I protest against the system which permits bankers whom I respect to organize monopolies, or individual railroad men to exploit the community. As individuals I have respect for them, but I do not believe in the institutions which they, in an impersonal way, use for the exploitation of society.—The Public.

FIRST WEEK OF BOILER MAKERS' STRIKE ENDS WITH VERY FEW IMPORTANT DEVELOPMENTS NOTED.

Port Arthur, Jan. 28.—The past week of the strike, being also the first week, brings out only a very few changes of importance. The Petroleum Iron Works Company who have the contract for building stills and water boxes for the Texas Company, have again in Texas, as previously done in Oklahoma, hired scabs to take the places of union men now on strike. Only a few are available here, but the company is using every effort to secure them from other places. Several who went to work after the first few days of the strike came off the job when informed by our pickets that the job was on strike and they were scabbing on our members. While these men are employed by the company, there are none of them who are mechanics, and know nothing of the trade and they will be an expense to the company rather than a benefit, and what work they do will be of such inferior quality that this company will find that scabs doing mechanics' work under a scab foreman is very costly, indeed.

The Reeves Company up to this date have made no effort to cover the job here with scabs, and the job is still as it was left by our members. Regular strikers' meetings are being held every day and pickets are keeping both jobs covered at all times, and no man that goes to work on either job can say that he was not informed that the job was a scab job.

The situation in Oklahoma remains about the same, with the exception that the COMBINE have hired twenty-five more deputy sheriffs to guard their scabby jobs. The outlook for the second week of the strike is very bright, indeed, as the producers want the tanks built, and are willing to give a living wage and conditions and our members have informed these producers that we will build the work for them or anyone else that will pay the wages and give the conditions that we are asking of the combine.

It will only be a matter of time until the producer will get tired of waiting on these companies to build this work, and having what they are doing done in such a poor manner and they will take the work over themselves and give it to men who know how and will build this work in a satisfactory manner and get the work done in time so valuable or that is now going to waste will be saved.

Work on the cutting down job at the tank farm at Nederland pump station for the

Texas Company was declared unfair to our members by local No. 305, as this company is not employing any of our members, and is not giving the wages asked by our members for this class of work, and men are being worked nine hours a day, while the union hours are eight hours per day. Wages on this job as paid by the company at this time is \$3.50 and \$3.00 per day, while the scale asked by the union men for this work is \$4.50 flat for all men on the job with the exception of the foreman and second foreman.

Several men have already quit this job and the local members feel sure that others will be off the job before the week is out.

Government Lock Gates Being Built With Non-Union Labor.

The lock gates on the Sabine-Neches canal, being erected by the Chicago Bridge and Iron Works, is being done with non-union labor and at wages far below the wages paid union men. This scab company has a past record that is as corrupt in regard to wages as any coal mine operator. They were never known to run a union job or pay the prevailing scale of wages.

When this company was first known to have this contract, the secretary of Local No. 305, under instructions from the local, wrote several letters to the head office of this company with the endeavor to get this work for our members, and were informed that the work would be done by men shipped in here from Chicago, and at wages they were already being paid regardless of what the wages were here. Mr. T. F. Manley, who is the erector for this company, arrived in Port Arthur and this matter was taken up with him through a committee of the local and international vice-president, Joseph P. Ryan, and he informed the members that he was willing to pay the scale of wages asked by our members, and was also willing to give this work to our members, and that the work was not ready for erection, as the government did not have all of the concreting done on the supports for the gates, but that when the work did start that he would inform the representatives of the organization and place our members on the job. DID HE KEEP HIS WORD? NO. When this work was ready for erection he placed men on the job he had imported in here from Chicago, who he knew were not members of our organization and who would work under the scale of wages that were asked by our members. Every effort that could be brought to bear on this Mr. T. F. Hanley to have this work done with members of our organization was done, but he informed the committee to the effect that the company had sent him word to continue the work with the men he now has in his employ. He informed the members of No. 305 that he had full power over this job and then after promising them the work he deliberately turned and sent to Chicago for men to do this work for less wages than the members requested. Messages have been sent to our United States senator and

representatives to the effect that the government is giving government work to contracting companies who will not pay the prevailing scale of wages for work performed. When the government tax the American people for money to pay these bills SHOULD NOT THE AMERICAN CITIZENS receive the benefit of the work and receive white man's wages therefor?

It is a disgrace to the great American government that such contractors are allowed to have government work and work under such low conditions.

Our members are being advised everywhere of the action taken by this contracting company and its foreman, Mr. T. F. Hanley. These men coming from Chicago are taking the food from the mouths of our families and doing it for less wages than this work is being done for any place in the south. We ask you in all fairness to stay away from this job and to let it be known all over the United States that the United States government is giving government work to scab contractors. Such actions as these adopted by this company leaves a scar across the faces of the parties who gave the contract to them that will be remembered by every organized worker when they again apply for positions, and the Sabine-Neches lock gates will forever stand as a hideous vulture, and every ship that will in the future pass through its gates will know that it was the work of scabs.

We earnestly request our members and others to stay away from Port Arthur during this trouble. Lend us your support to defeat these firms who would lower wages and lengthen hours, and make peons out of American citizens.

(Signed) EXECUTIVE COMMITTEE,

Boiler Makers' and Helpers' Local No. 305.
—The Labor Dispatch, Galveston, Texas.

EMPLOYMENT BUREAU SHARKS.

Private employment bureaus in themselves offer the best reason for the establishment of the governmentally conducted bureau. The private bureaus have been charged with most every crime save murder—and in effect some of them have been guilty even of that, but about the meanest offense against humanity and decency is that known as "fee-splitting."

The private employment agency man enters into an agreement (tacit) with the foreman of a big plant employment hundreds of men. Under this agreement the employment agent provides a given number of men each month and then splits the fee that he takes from each man so provided, with the foreman of the plant. If the foreman has no positions open he promptly discharges enough men to make room for the new comers.

This process is repeated from month to month and the employment bureau man and the crooked foreman reap an handsome profit monthly.

If there could be a more devilish scheme

for preying upon the unfortunate than this scheme, we have yet to hear of it.

It is gratifying to know that many of the larger cities of the country have organized municipally controlled free employment bureaus. It is more than gratifying to know that it is now proposed to organize state and national employment bureaus.

The Labor Advocate does not hesitate to say that El Paso should have a free employment bureau and that it would be well for some of the candidates now in the field for local office to make known their views upon the subject.

We take it that the widespread establishment of governmentally controlled employment bureaus will go far toward solving the question of unemployment. It will undoubtedly help.—Labor Advocate, El Paso, Tex.

TIMBER FOR SMALL ARTICLES.

It is astonishing what an amount of timber is consumed in the making of such insignificant trifles as dowels, shuttles, etc. More than 800,000 board feet of lumber were used in New York State last year for wooden dowels alone, also more than 900,000 feet of hardwoods for shuttles, spools and bobbins; brushes and brooms consumed 1,500,000 feet; toys used nearly 3,000,000 board feet and handles of all kinds used up more than 6,000,000 board feet. Boxes and crating, for which low grade stock and short lengths are chiefly used, consumed 370,000,000 board feet, equal to about three-fifths of the total annual lumber cut in the state.—The Carpenters' Trade Journal.

THE ADVANTAGES OF HIGH DUES.

Power is necessary to influence. Power depends upon resources. This is true of the trade union as well as of every other organization. The labor organizations that have the greatest power to protect their members and the greatest influence in furthering the needs and the demands of their members are the labor organizations provided with ample, substantial financial resources.

There is only one way to accumulate organization funds—payment of adequate union dues. Organizations have found it a wise policy to increase low dues as rapidly as possible, because increased financial resources at their command give them increased prestige, increased ability to secure better wages and working conditions and increased ability to provide against threatened dangers. There is no investment a wage-earner can make that will bring him greater returns than his union dues. If dues to the union are increased proportionally as the union increases wages, the power of the union to promote and safeguard the interests of its members becomes increasingly effective.

The financial organization of a trade union must be based on sound business principles. Wildcat finances in trade unions will be no more reliable than wildcat banking invest-

ments. Money will not get into the union treasury by miracle or by the wishing process. The protection of a well-filled treasury is possible only for those who are willing to pay the price in dues, management, and foresight. The very existence of a sound financial organization constitutes a defense of its members. Power does not always have to be aggressively used in order to be effective—reserve power is often the most potent. Consciousness that they possess power puts moral courage and confidence into the workers, and it puts fear into the hearts of those who would wrong them. When power exists there is hesitancy to deny the possessors their rights or fair demands. The existence of the power of self-defense prevents many industrial struggles while the weak and the helpless are wronged with impunity.

As union dues are increased it is possible to extend the system of union benefits. These benefits supplement the wages earned and enable unionists to live better and more comfortably.

The views which we advance here have been repeatedly proved correct by the experiences of the different trade organizations. An article by John F. Tobin, President of the Boot and Shoe Workers' Union, published elsewhere in this issue, tells how the boot and shoe workers learned that they could not afford to remain a low-dues-paying organization, and of the cumulative effect of establishing a better financial system.

Labor organizations are constantly preaching the gospel of higher wages. What wages are to the individual, dues are to the organization. The ideal of the American Federation of Labor is to have each organization strong, competent to manage its affairs and to solve its own difficulties. While there is whole-souled sympathy and willingness to help fellow workers in their time of need, yet the best results for all workers can be obtained when each organization is free to protect and promote the rights and interests of its own members and to organize the yet unorganized.

But high dues should not be accompanied by high initiation fee. Indeed the initiation fee should be small, thereby inviting and making it possible for the yet unorganized to join the union and to make common cause with their fellow workers to secure the common welfare of all. High dues regularly paid will inevitably lead to greater self-reliance, mutual interdependence, unity, solidarity, fraternity and federation.—The American Federationist.

MIGHT BE EITHER.

He—Is that new place just opened on your street a tailor's shop or a public spooning parlor?

She—A spooning parlor? What do you mean?

He—Why, I noticed a sign in the window: "Hand Pressing Done Here."

News of General Interest.



HANDLING MERCHANDISE WITH SPIRAL CHUTES.

By Frank C. Perkins.

Gravity is now being utilized in large manufacturing plants to a remarkable extent for conveying products about the factories very largely without necessitating the uses of electric or other power. There is a combined installation of chutes and belts

utilized in a plant at Brooklyn, N. Y., which includes a gravity roller conveyor. While the gravity roller conveyor and power driven conveyors are largely used to advantage, the present article particularly deals with spiral chutes.

The value of a chute is largely dependent upon being built so as to control the speed of packages of various weights. The fol-

lowing memorandum of tests made by Butler Brothers, Jersey City, may be of interest, a 4-foot chute used, 12 feet in diameter:

Size of case, 45x17x16; weight, in pounds, 300; traveled the distance in 29 seconds.

Size of case, 34x11x16; weight, in pounds, 118; traveled the distance in 32 seconds.

Size of case, 26x24x15; weight, in pounds, 115; traveled the distance in 36 seconds.

and Fig. 2, show two forms of these spiral chutes and their simplicity of operation, and indicate the ease with which merchandise can be handled in this manner.

Another form of spiral chute has been installed at the plant of Noyes Bros. & Cutler, wholesale druggists, equipped with ball bearing gravity carriers of the Mathews type, for lowering boxes and barrels from

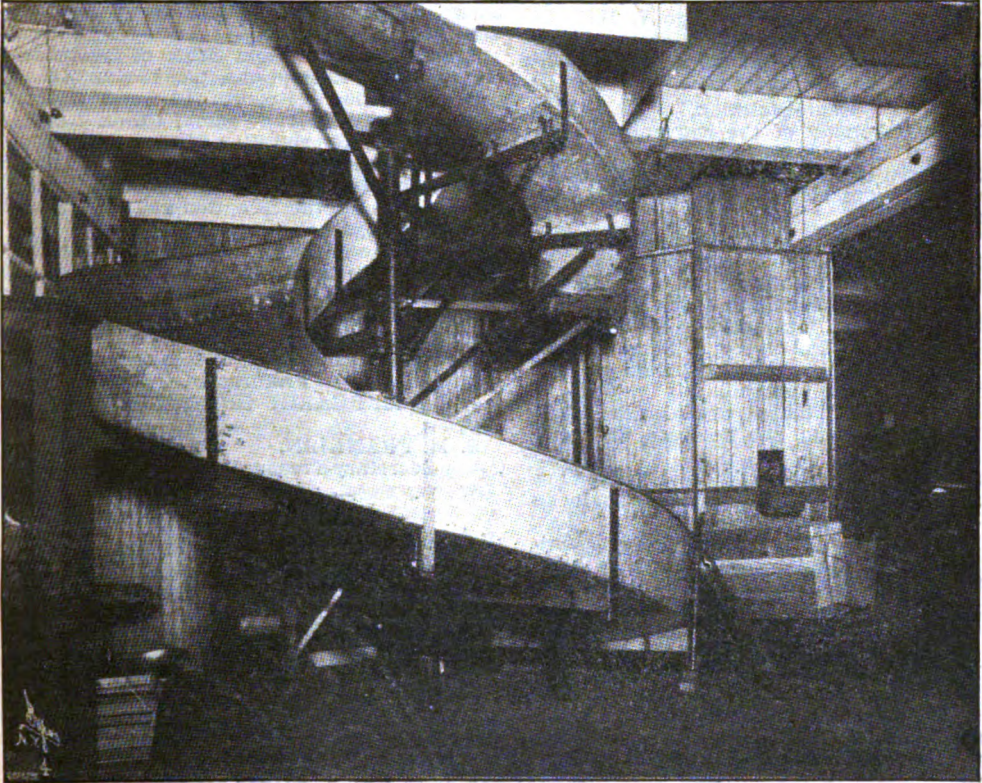

Same case, iron strapped, traveled the distance in 32 seconds.

Size of case, 28x24x20; weight, in pounds, 110; traveled the distance in 29 seconds.

Size of case, 37x20x4; weight, in pounds, 80; traveled the distance in 30 seconds.

Same case, iron strapped, traveled the distance in 30 seconds.

Size of case, 15x10x9; weight in pounds, 10; traveled the distance in 29 seconds.

Same case, iron strapped, traveled the distance in 30 seconds.

This spiral chute was of the concave bottom type, of galvanized steel, outside diameter, 12 feet, the width of trough being 48 inches, and the pitch 12 feet 9 inches, with a total perpendicular distance of test of 91 feet 9½ inches. The speed control is secured by the concave bed construction of the Haslett type, designed at Philadelphia, Pa.

The accompanying illustrations, Fig. 1

fourth and intervening floors to shipping room, as developed at St. Paul, Minn.

A novel gravity lumber carrier has also been developed. This carrier is designed to convey loose boards of any length, from eighteen inches upward, or two or more boards piled on top of each other. Constructed of solid steel, with center bar and two rows of ball bearing rollers, also of steel. Outer ends of rollers are set slightly ahead of inner ends, thus preventing boards from falling off.

Boards, loose or tied in bundles, cross arms, box shooks, wagon stock and dimension stuff can be handled quickly, effecting a great saving over old methods. It is the only device ever made which will handle these commodities satisfactorily. From three to five per cent fall is required and curves are reversible. It is made of 8-foot lengths and provided with steel adjustable supports.

WOMAN'S TRADE UNION LEAGUE CONVENTION CALL.

Chicago, Ill.

To All Affiliated Leagues, Affiliated Trade Union Organizations and Members—Greeting:

You are hereby advised that, in accordance with the vote of the fourth biennial convention of the National Women's Trade Union League of America, the first biennial convention will be held in New York City, N. Y., beginning Monday, June 7, 1915, at 10 A. M., and will continue in session from day to day until the business of the convention has been completed.

Representation.

The membership of the convention shall consist of the following:

The three officers and the other six members of the executive board, with one vote each.

Each local league shall be entitled to send one delegate with one vote for every 25 members or fraction thereof, up to 500 members, and after that one to every 50.

Each affiliated international union, trade union local, central labor body and state federation of labor shall be entitled to send one delegate with one vote.

Every other affiliated organization shall be entitled to send one delegate with one vote.

In order to encourage interest in forming local leagues, members at large shall be given voice, but with no vote.

Only those leagues and affiliated organizations whose annual dues shall have been fully paid up sixty days in advance of the national convention shall be entitled to vote at the convention.

Credentials.

Credentials in duplicate are inclosed. The original credentials must be given to the delegate-elect and the duplicate forwarded to the secretary, room 1644, 127 North Dearborn Street, Chicago, Ill., not later than April 7.

Purpose.—The facts of women in industry have everywhere to be met with increasing knowledge if we are to achieve an efficient industrial democracy in the United States.

The calamitous effects of the terrible European war are being felt in more or less degree in every civilized country. The United States is already suffering, through the dislocation of industry following upon the partial suspension of the world markets. The problem of unemployment is flinging us a sterner challenge, and this condition of workers idle brings into bold outline the effects of unorganized women in industry. The danger of women being used as underbidders in an increasing number of trades must be squarely faced. There is only one woman among the hundreds of thousands forced to earn a living by grim economic pressure who will refuse to take the place of a man for lower wages. This is the organized woman, who recognizes the fundamental necessity of standing with men in

the demand for equal pay for equal work.

And so the duty of the hour urgently demands that every affiliated organization be represented by its most experienced, thoughtful and faithful members, who will bring to this pressing question of the trade union organization of women a rallying spirit of courage, faith in the future and common sense.

Business.—The president will appoint the following committees from the delegates to assist in transacting the business of the convention:

Credentials, Rules and Order of Business, Organization, Resolutions, Legislation, Committee on Officers' Reports, Life and Labor, Education, Votes for Women, Union Label, Constitution, Special Committee on Training School for Women Organizers.

Accommodations.—The New York League will arrange for the reception and entertainment of delegates.

Note.—The place of meeting will be 43 East Twenty-second Street, headquarters of the New York League, and any further information regarding the convention or traveling arrangements for out-of-town delegates will be communicated in a later circular.

Fraternally,

MARGARET DRIUR ROBINS,
President.

S. M. FRANKLIN,
Secretary-Treasurer.

VALLEY OF WARS.

Washington.—The valley of the Meuse, extending through France, Belgium and Holland, up and down whose course 2,000 years of intermittent warfare has been waged, forms the subject of a statement given out by the National Geographic society.

Above every other valley, that of the Meuse has become a battlefield. At Liege, on the Meuse, the first great battle of the war broke forth, and the struggle blazed and seared all along the picturesque splendor of this wild, rugged-banked stream, directly southward through Belgium into France. According to the day by day dispatches, some of the most fierce efforts are still raging on its banks. Liege, Namur, Dinant, Givet, Sedan, Stenay, Verdun and St. Mihiel—each name recently become familiar to Americans—all lie along its course.

Channel for Flow of Armies.

Three countries share the Meuse. It rises in France, flows northward through Belgium, crosses the Dutch frontier, sweeps westward through Holland, and empties into the North sea. Its journey to the sea is one of 580 miles, of which 460 are navigable.

The valley of the Meuse for ages has been a channel for the ebb and flow of armies. It might be said to drain one vast, historic battlefield. Caesar pursued its path into the unknown, barbaric north. The wild Teutonic tribes pressed down between its banks toward the wealth of Rome. Christian Europe has been settling its differences

along the valley of the Meuse by force of arms down to the present day.

In the forest of the Ardennes, the Meuse flows through a country rich in romances of Charlemagne. Vinelands and hop-gardens lie further along its banks, and then it washes great industrial cities, gathering to itself the ashes, rust and acids of factory and furnace waste. Just before reaching the sea, the Meuse, here the Mass, divides, one branch flowing west, and the other mingling with the Rhine to empty past Rotterdam at the Hook of Holland.

Caused 800 People to Drown.

The camp of the Aduatucl described by Caesar is marked by a citadel on a hill between the Meuse and the Sambre, its largest tributary. At Dinant, Phillip the Good, Duke of Burgundy, is said to have caused 800 people to be drowned in its waters. But the river has long since forgotten the good duke's sprightly slaughter in a present time more stirring, more titanic and far more costly in human life.—The Milwaukee Journal.

WHO DUG THIS CANAL?

Arabistan lies at the head of the Persian gulf, its western boundary being the Shatel-Arab, the great river formed by the combined waters of the Tigris and Euphrates, the right bank of which is in Persian territory, while the left is in Turkish Arabia. Forty miles above where it flows into the Persian gulf the Shatel-Arab is joined by the Karun, and the town of Mohammerah stands at the junction of the two rivers, the former a clear, green stream, the latter thick and red. In ancient times the Karun flowed into the gulf and part of the river still runs along the old channel, but the main stream has been diverted, three miles above Mohammerah, into an artificial channel known geographically as the Haffar canal. It is impossible even to make a guess at the date of this wonderful work, not even a tradition remaining of the ruler whose near-sightedness realized the enormous advantage of joining up the two waterways. Alexander the Great has been suggested, but apparently for no other reason than that he is a convenient and likely person to credit with any ambitious enterprise, and that one of his many Alexandrias was built on the site of the present Mohammerah.—Wide World Magazine.

TERRIBLE OATH FOR PLUMBERS.

Torments Sworn for Violators of Alleged Trust's Secrets.

Des Moines.—An oath of the National Association of Master Plumbers of America containing the sentence, "May all the horrors of the damned be my portion when I retire at night," was declared by Joseph Hagen, Sioux City, to have received his signature, in his testimony at the trial of thirty-six master plumbers charged with violation of the Sherman law.

He was to suffer the "horrors of the

damned" in case he violated the rules of the organization, the witness said.

C. L. Piper, Morningside, Ia., for the government, testified that he had been put out of the association because he refused to go into "certain pools." He admitted on cross-examination that the protection of the association did not amount to a snap of the fingers.—The Milwaukee Journal.

THE CONDITIONS OF INDUSTRIAL ACCIDENTS.

The enactment of laws in various states on workmen's compensation for injuries has aroused increased interest in the statistics and physical and psychic conditions of industrial accidents. The total number of these accidents is almost appalling. The lowest estimate places the fatal accidents to adult workers in the United States at 35,000 a year, with an additional 1,250,000 non-fatal accidents. The Massachusetts Industrial Accident Board, on the other hand, placed the number of workers killed by accident yearly at 75,000, which apparently includes not only adults, but also workers of all ages, while the number of injured of the same classes was placed by this Massachusetts authority at 3,000,000 or over. An earthquake in a foreign country that kills half this number of persons and maims one-fifth of those injured in our United States industries is spoken of as catastrophic.

A greater proportion of accidents occur on Monday than on any other day of the week. Accidents are said to be due often to fatigue. As, after the day of rest on Sunday, workmen should be less fatigued than on other days, some other factor must be sought to explain this feature of the statistics. It has been suggested that the "blue Monday" accidents are really due to the fact that workmen take more liquor on Sunday and thus become unnerved and more liable to accidents during the following twenty-four hours. There is, perhaps, something in this contention, though it has been disputed. In the Massachusetts Industrial Accident Board Reports, in which the official figures are given, there is scarcely more than one-twentieth more accidents on Monday than on Tuesday, while Tuesday is not much above the average in the number of accidents reported for other days. Saturday, of course, shows a noteworthy reduction, because of the half holiday in some trades.

By far the larger number of accidents occur at about 10 a. m. and 3 p. m. This fact is confirmed by the reports of two state boards, Washington and Massachusetts. The tendency to speed up employment has been incriminated, as the predisposing condition for the occurrence of accidents. This desire comes over the workman when he is not yet fatigued, but has been employed for several hours. He starts the morning's work "cold," and as he warms to his work, the danger of mischance because of haste becomes greater. Just when the speeding up reaches a climax in the morning hours, most accidents happen. The same thing is true in

the afternoon. Workmen feel sluggish after their lunch, but after an hour of work warm up again, and by 3 o'clock they are doing their most rapid work, and are at the same time more subject to accident.

With regard to accidents among children, however, there is no hour of maximum. Accidents occur at all times, and they are comparatively much more frequent among children than adults. The United States Bureau of Labor reported that "there is clear evidence of great liability to accident on the part of children. Though employed in the less hazardous work, their rates steadily exceed those of the older co-workers, even when in that group are included the occupations of relatively high liability." This was said with regard to the Southern cotton mills, but the same thing is true of practically all industries in which children are employed.—American Medical Association Journal.

TUBERCULOSIS AND THE WORKING-MAN.

When one single disease, tuberculosis or consumption, causes one-third of all deaths among workmen between 15 and 45, and in certain dusty trades as high as one-half, it seems time that organized labor aroused itself from its apathy and proceeded to do something to down this plague.

The original purpose of the labor union and its predecessor, the trade guild, was protection from outside oppression and an endeavor through collective bargaining to lessen the grip of the employer upon the workingman. While a few unions, here and there, have recognized that there were deadly enemies within as well as without the union, most of the 2,000,000 and more men and women in the ranks of organized labor have never recognized tuberculosis as such a foe.

It is true that increased wages and improved working conditions have a vital effect upon the home-life and thus react favorably in the control of tuberculosis. It is also true that within the unions themselves, education and adequate care for every man or woman threatened with or attacked by this disease is needed. Eight-hour days, maximum wages and sanitary shops will not of themselves control the spread of tuberculosis. Until the individual workingman is taught such lessons as not to spit promiscuously about the shop, to sleep with his windows open, and to guard himself and his children by care of his body against the entrance of infection, consumption will continue to be unduly prevalent in the ranks of labor. Until opportunity is afforded for every man who thinks he has tuberculosis to get an examination free or at a price within reach of his means; and until hospital and sanatorium facilities are adequate to care for every afflicted case, the death rate from this disease will continue to be abnormally high.

Right here, the labor unions can fight the enemy within their ranks. This article and succeeding ones will offer some suggestion

as to methods. The first suggestion is to study the problem in your own ranks. Find out about tuberculosis in your trade and in your individual shop. For example, ask these three questions of yourself or your fellow workers and see what answers you get: (1) How many deaths from tuberculosis and from all other causes were there in your shop during this past year 1914? (2) How many members of your union are now on the sick list as a result of tuberculosis? (3) What peculiar trade or shop conditions, so far as you know, tend to predispose members of your union to tuberculosis? Note such things as dust, gases, fumes, dark rooms, bad ventilation, etc.

These questions will readily suggest others. By answering them you will get some appreciation of the tuberculosis problem as it relates to you.—From a circular issued by the National Association for the Study and Prevention of Tuberculosis.

AMONG OUR EXCHANGES.

The year of 1914 was a most trying one for every trade union, the I. M. U. of N. A. being no exception. Trade conditions were unfavorable when the year began, and there came no improvement as time passed. The year 1913 had not been a favorable one, for the record shows that 57,215 out-of-work stamps were issued, but last year the number increased to 143,337, which indicated that many weeks of idleness by individual members, and more than that number, as out-of-work stamps are not issued until after the first week of idleness, and some members, after receiving thirteen out-of-work stamps were still idle. This number of out-of-work stamps issued during 1914 represents a loss in revenue to the organization of \$57,334.80, and as Finance Metcalf points out, in his quarterly report, with this must be considered the sick and death benefits, which are paid out to members whose good was maintained through the use of out-of-work stamps. In view of this reduction of income, and the payment of \$248,331.60 during the past year in sick, disability and death benefits, and the expenditures of an even larger amount in strike benefits, it speaks well for the organization's financial resources.

Such a record would have been impossible except for a loyal membership and the wise legislation it has adopted for its protection.—International Molders' Journal.

A COMMUNICATION FROM THE A. F. OF L.

Washington, D. C., Jan. 25, 1915.

To A. F. of L. Organizers:

Dear Sir and Brother: With the new year new responsibilities rest upon the working people of America. With new opportunities for the toiling masses comes the necessity of utilizing them to the best possible advantage. With new freedom comes the necessity of its appreciation and exercise.

The enactment of the labor provisions of the Clayton Anti-trust law, October 15, 1914.

by statute law declared that the labor of a human being is not a commodity or an article of commerce; that the normal, natural activities of workmen for the protection and promotion of their rights and interests are lawful, and that the interpretation of the Sherman Anti-trust law, by which its terms were applied to the associated effort of the working people, no longer holds good in law. Thus, I repeat, the opportunities which are presented must be utilized by every honorable effort to organize the yet unorganized workers in every field of honorable human endeavor, and particularly of the working people.

At the Philadelphia convention of the American Federation of Labor a number of resolutions were introduced with the above object in view. These were referred to the Executive Council of the A. F. of L. and in turn by the E. C. referred to the undersigned, with the direction that the organizers, aye, all earnest, active men and women in the labor movement of America, be urged, and I do urge them, to give their earnest, active co-operation in the work of organizing the yet unorganized toilers; to bring about unity, solidarity, and federation among the organized; to do everything within the power of each and all of us to make the lives of the workers more worth the living, and to aid in the abolition of all forms of wrong and the attainment of every right thus far denied.

The particular instructions were to organize stenographers, typewriters, bookkeepers and office assistants;

To organize the elevator operators, porters and janitors;

To organize the unskilled workers in every field of labor as well as skilled wage-earners;

To organize working women employed in homes and known as domestic or household workers;

To organize local label leagues to be part of the Women's International Label League.

While special attention is called to the class of workers above enumerated, the instructions hold good with reference to all workers, regardless of the character of work performed. Organization is the thing, and to that especial attention is called with the earnest hope that the year and its opportunities may land us much nearer the three million mark. This call is for renewed energy, perseverance and persistence in the great organizing work of the American trade union movement, and to attain greater advantages for the wealth-producers of America.

When organizing new unions or when called upon for advice or assistance by unions already organized, you should not fail to keep in mind the amendments to the constitution of the A. F. of L. as adopted by the Philadelphia convention. I refer particularly to the amendments affecting directly affiliated local or federal labor unions. For convenience they are quoted as follows:

Local unions must charge their members not less than 60 cents per month dues.

Each local union must bond its financial secretary and treasurer in such sum as shall be adequate to protect its funds.

The initiation fees shall not be less than \$1.00 or more than \$5.00 and one-fourth of each initiation fee received by directly affiliated local unions shall be forwarded to the A. F. of L. together with the per capita tax, accompanied by a monthly report giving the names of members paid for on blanks to be furnished by the Secretary of the Federation.

Travelling cards issued to members of local trade or federal labor unions shall admit members presenting the same to membership in local, trade or federal labor unions directly affiliated to the American Federation of Labor.

Local trade and federal labor unions directly affiliated shall be prohibited from assessing their members or appropriating their funds for any purpose other than union or A. F. of L. purposes. Each directly affiliated union shall forward monthly to the Secretary of the A. F. of L. a complete statement of all funds received and expended.

No local trade or federal labor union shall disband so long as seven members desire to retain the charter. Upon the dissolution of any local trade or federal labor union all funds and property of any character shall revert to the A. F. of L.

Do not fail to explain the above fully and make it perfectly clear to the newly organized unions, and also, whenever the opportunity is presented, to visit directly affiliated local unions already in existence and instruct them as to the amendments above quoted.

Please report at least once each month any progress made, any success achieved, and, indeed, upon any matter of interest to labor coming under your observation.

With best wishes, I am

Fraternally yours,

SAMUEL GOMPERS,

President American Federation of Labor.

U. S. DEPARTMENT OF LABOR.

(Children's Bureau, Washington.)

The Children's Bureau of the Department of Labor issues today the first report in its study of infant mortality in the United States.

The report emphasizes the fact that this is only the first item in a proposed extended inquiry. While it carefully avoids conclusions, certain conditions are pointed out as coincident with a high infant death rate in the one city under consideration.

It finds that the infant death rate varied in different parts of the same city. In the poorest section, where sanitary conditions were at their worst, the rate was 271 per thousand babies, or more than five times that of the choice residential section of the city.

The deaths of the babies investigated were in inverse proportion to the earnings

of their fathers. Babies whose fathers earned less than ten dollars a week died at the rate of 256 per thousand. Those whose fathers earned twenty-five or more dollars a week died at the rate of 84 per thousand.

The report shows that artificially-fed babies died at a much more rapid rate than breast-fed babies. In the earliest months of the baby's life exclusive breast-feeding appears to be the only safe method. Only 46.6 babies per thousand died under one year of age when breast fed for at least three months, as against 165.8 per thousand who died when fed exclusively on artificial food up to the age of three months.

Where mothers were employed a large part of the time in heavy work babies died at a much more rapid rate. In one group of 19 mothers whose babies all died, 15 had been keeping lodgers, an arduous occupation among the foreign women, where the wife without extra charge often washes and irons for the lodgers and buys and prepares their food.

The city bears its share of responsibility for infant deaths. A high rate of infant deaths was found in coincidence with neglected streets and insanitary housing. The report shows for 135 miles of streets and alley only 41 miles of sewers and 36 outlets, only 64 per cent of the streets paved, and but .11 per cent of the alleys. In houses where water had to be carried in from outdoors, the infant death rate was 198 per thousand, as against 118 per thousand where water was piped into the house.

These findings are based on a report as to infant mortality conditions in Johnstown, Pa. Other cities now being studied are Manchester, N. H., Brockton, Mass, and Saginaw, Mich.

The city of Johnstown was chosen as the first town to be studied because of its interest as a type of town in which there are no large industries employing women, and because its side and its good birth registration permitted a study with the limited staff which the Bureau could at first assign to the work.

In her letter submitting the Johnstown report to the Secretary of Labor, Miss Julia C. Lathrop, Chief of the Children's Bureau, states that the subject of infant mortality was chosen for the first field inquiry because of its profound importance in our national life. According to an estimate of the U. S. Census Bureau, at least 300,000 babies die annually in this country, which means approximately one baby out of every eight under one year of age. Leading sanitarians say that if proper measures of hygiene and sanitation were observed this number could be indefinitely reduced. The Children's Bureau is trying to learn the conditions of life most favorable for American babies.

Every mother of a Johnstown baby born in 1911 was visited by women agents of the Children's Bureau and information obtained about the family surroundings of the baby, how his father earns the money necessary for his care, and how much he earns,

whether his mother works outside the home and how heavy her work is within the home, whether the city streets are safe, the water pure, the milk clean. The subjects considered in this first report: City and street environment, housing, nationality, mother's age, literacy and married history, the feeding of the baby, the occupations of the mothers, the family earnings, etc., show some of the lines along which the Children's Bureau expects to find information leading to a reduction of the high rates of infant mortality in the United States.

The report of infant mortality conditions in Johnstown was written by Miss Emma Duke, one of the women investigators of the Bureau. This report, like the other publications of the Bureau, may be obtained free of charge upon application to the Children's Bureau, Department of Labor, Washington, D. C.

ENTRIES IN LOS ANGELES LABOR TEMPLE CONTEST.

On June last a committee representing the American Federation of Labor, consisting of W. D. Mahon, International President of the Amalgamated Association of Street and Electric Railway Employees, and L. D. Bland, editor of the Street Railwaymen's Official Journal, visited Europe to make an investigation of conditions of street railway workers of that continent and covered the following countries: Germany, France, Switzerland, Italy and the British Isles.

Upon arrival in each country the committee immediately called at the labor headquarters and was taken in charge and supplied with interpreters and guides and given introduction to all parties they wished to meet. A few words of the introductory to the report of Messrs. Mahon and Bland, published in the December number of the American Federationist, which describes the opening up of negotiations in Germany, will give an idea of their reception in all the other countries mentioned. The report begins:

"We sailed from New York on the 16th day of June, 1914, reaching Hamburg, Germany, June 23. We spent two days in Hamburg, investigating the general conditions of the street railway workers in Germany. The headquarters of the trade union movement of Germany is located in Berlin. On arriving in this city we first visited the office of Mr. Herman Jochade, Secretary of the International Transportation Workers, and through him we were introduced to Mr. Baumeister, Secretary of the German Trade Union movement, who cordially received us and pledged us all possible assistance in our work. He tendered us the services of one of his clerks to act as interpreter. We were then introduced to the officers of the Transportation Workers of Germany. Through Mr. H. Rathmann, the tramway representative of the Transportation Workers, we were placed in touch with the conditions of the occupation in their entirety throughout Germany."

From the foregoing it will readily be seen that the representatives of the Los Angeles Union Labor Temple Association will experience no difficulty on the language score when they reach Europe. The Labor Movement of the Old World will see to that.

The Contest Committee continues to receive many letters of inquiry, which proves conclusively that Organized Labor is alive to the situation that will confront it on the

James M. Lynch, Commissioner of Labor of the State of New York, and ex-President of the International Typographical Union, in a recent letter to a member of the Committee, gives his endorsement of the plan. Mr. Lynch says:

"I sincerely trust that you will be entirely successful in the venture you now have in hand. It should meet with favorable consideration by Organized Labor on account of its double purpose—clearing the Los Angeles Labor Temple of all indebtedness, and the selection of two people to canvass the Continent of Europe in Organized Labor's behalf."

The following organizations have endorsed the Los Angeles Union Labor Temple plan and are arranging to place men of international reputation in the field: Local No. 234, Hotel and Restaurant Employes International Alliance and Bartenders International League of America; Local Union No. 311, International Association of Machinists; Local Union No. 72, International Union of Steam and Operating Engineers; Local Union No. 81, Journeymen Tailors Union of America; Local Union No. 47, American Federation of Musicians; Local No. 37, International Union of Bakery and Confectionery Workers of America; Plumbers Local Union No. 78, United Association of Plumbers and Steam Fitters; Painters Local Union No. 267, Brotherhood of Painters, Decorators and Paperhangers of America, and Typographical Union No. 174, International Typographical Union.

Address all communications with reference to the contest to Contest Committee, Room 203, Union Labor Temple, Los Angeles, Cal.

HOW LABOR UNIONS HAVE FOUGHT TUBERCULOSIS.

Organized Labor has not been entirely unmindful of the fight against tuberculosis, although many of the largest unions have paid little or no attention to the plague which is decimating their membership.

The Typographical and Cigar Makers' Unions have been among the pioneers in their appreciation of the problem of tuberculosis in their ranks. As early as 1898, the International Typographical Union opened an annex of 80 beds in their home at Colorado Springs for tuberculous printers. This work, accompanied for years by an educational campaign, has helped to control the spread of tuberculosis in the craft. The Cigar Makers, while they have not opened any institution of their own, have for more

than 10 years preached and practised in many ways the prevention of tuberculosis.

Following the success of the Typographical Union, the International Printing Pressmen and Assistants Union in 1911 opened a home with special provision for tuberculous brothers at Rogersville, Tenn. The International Photo-Engravers Union has for five years given the subject of tuberculosis careful consideration and has devised and enforced many helpful regulations for improving the working conditions in this craft. Tuberculous members of this union are cared for in private and public tuberculosis sanatoria in various parts of the country. In 1909, the International Boot & Shoe Workers' Union recommended that their members ally themselves with the organized anti-tuberculosis campaign in various parts of the country. This action has since been followed up in various ways. The National Brotherhood of Operative Potters, following a careful study of tuberculosis in their industry, has set aside a fund for the care of their consumptive members.

The American Federation of Labor for the last six or seven years, has also repeatedly, by special resolution, indorsed the general anti-tuberculosis campaign or special phases of it. A number of other national and international unions and several locals and federations have also co-operated in special ways with the anti-tuberculosis movement.

LOAN PLAN FOR SMALL BORROWERS.

The Morris Plan of industrial loans, which has just been put into operation in this city with great success, has been tried with good results in a dozen states. It is a credit scheme for the small man, who cannot maintain banking facilities and has as assets only his character and his work. Heretofore he has had to go to a pawn shop or a loan shark if he needed money and could not borrow it as a favor from some friend, or, at best, he has turned to the Provident Loan Society, where he could borrow on goods, receiving honest treatment.

Under the Morris Plan he may make a note, indorsed by two persons of character, and after investigation and approval his note will be discounted. He pays it by depositing weekly for fifty weeks one-fiftieth part of the sum borrowed. Thus he has the privilege of borrowing money at the legal rate of interest, instead of at pawnbrokers' rates, and of paying back the principal in installments.

This is a straight business venture. It is not philanthropy on the part of the stockholders of the company, nor charity to the borrowers. Nevertheless, it is one of the best and surest ways yet discovered to rid any community of the loan shark. It is bound to be a convenience to the person of small means at any time. Just now it might be a veritable blessing to many a hard-pressed father of a family to be able to borrow money in this way to meet a crisis.—New York Tribune.

LABOR REPRESENTATIVES DEMAND COMPENSATION COMMISSION.

The contention of the American Association for Labor Legislation that the interests of the workers can only be served by the creation of a board or commission to administer compensation laws has just received strong endorsement in New Jersey through the filing of a minority report with the governor on this question by the labor representatives on the Employers' Liability Commission. This commission is appointed under the law by the governor to report on the working of the New Jersey Compensation Act of 1911, the first state law of its kind in the country, and to make recommendations for its amendment.

The labor representatives report "While agreeing most heartily with the other members of our Commission as to the desirability of recommending legislation (1) for the adoption of a constitutional amendment authorizing the legislature to pass a compulsory compensation law; (2) for the security of payment of awards through a compulsory insurance system; (3) for the creation of a State Insurance Fund; (4) for the regulation of certain protective clauses in policies of liability insurance; (5) for investigation looking toward the extension of the compensation principle to embrace occupational diseases; and (6) for the purpose of making more nearly adequate the compensation scale—we nevertheless feel that we would be untrue to our responsibility to the legislature and to the people of the whole state if we did not register an emphatic protest against the continuance of the court system of administration and recommend instead the creation of an administrative board with summary powers. As direct representatives upon the Commission of the great body of industrial workers for whose protection the compensation law was enacted, we have perhaps been in a position to observe more intimately than our four esteemed colleagues the points at which our present compensation

system has failed satisfactorily to fulfil its purpose. And our personal observation and our study of the subject lead us to believe that the most serious weakness of the present law is this unfortunate provision for its administration through the courts. We have made as diligent inquiry as opportunity afforded and we have given special attention to this problem of law enforcement."

In a review of their reasons for taking this stand the labor representatives point out that "No state has abandoned the commission form for the court system, while two states which at first followed the New Jersey court plan have already abandoned it as unsatisfactory and have created administrative boards instead."

Reference is made by the labor representatives to the joint report of last year of the National Civic Federation and the American Federation of Labor on the working of compensation laws. As a result of their inquiries on this topic these organizations strongly urged the creation of a commission to administer compensation laws, a view also endorsed by the Chairman of the Workmen's Compensation and Accident Prevention Committee of the National Association of Manufacturers.

Arguments equally emphatic are quoted from the report of the American Association for Labor Legislation on the working of the New Jersey law and from resolutions passed at the Annual Convention of the American Federation of Labor.

The Hon. Wallace D. Yable, Chairman of the Industrial Commission of Ohio, Hon. Joseph A. Parks of the Massachusetts Accident Board, and the Hon. John Mitchell of the Workmen's Compensation Commission of New York are also quoted as authorities who urge the creation of an administrative board.

Mrs. Beat—Tell the gentleman I'm not receiving today, Nora.

New Maid—But he ain't deliverin', mum, he's collectin'!—Puck.

THE DECLARATION OF AMERICA.

We, the citizens of the American Continent, embracing peoples of every race and tongue, affording a true demonstration of the brotherhood of man, being about to commemorate the one hundredth year of unbroken peace along three thousand miles of unfortified boundary, do hereby solemnly publish and declare that the time has come for the peace-loving powers of the world to unite in a League of Nations, founded on such principles, and organized in such form, as shall conduce to the preservation of life, liberty and happiness throughout every quarter of the world.

We hold these truths to be self-evident:

1st.—That "this is assuredly the opportunity for which a people and a government like ours were raised up, the opportunity not only to speak, but actually to embody and exemplify the counsel of peace and amity."—(President Woodrow Wilson in his latest message to Congress).

2nd.—That the great masses of citizens of one nation have no real hatred for the people of any other nation.

3rd.—That there is no dispute that can arise between nations which cannot be sat-

isfactorily settled by arbitration or by the Hague Court of Arbitral Justice.

4th.—That while it should be our constant policy to make provision for national peace and safety, it is essential, in so far as possible, to secure the co-operation of all other nations.

5th.—That the foremost efforts of the American people should now be directed to the task of preventing the recurrence of war rather than to preparations for war.

6th.—That the union of the peace-loving

Smiles.

SOME (K)NEEDS.

An editor of a northern North Dakota newspaper takes notice of this item: "It is reported that one of T—ville's fastidious paper needs bread with his shoes on. The editor makes the following comment: "This incident may seem somewhat peculiar, but there are others. The editor of this paper needs bread with his shoes on. He needs bread with his shirt on. He needs bread with his pants on; and unless some of the delinquent subscribers of this banner of freedom pay up before long he will need bread without a thing on—and old North Dakota isn't any Garden of Eden in the winter time, either."—Exchange.

A MATTER OF CHOICE.

The suburban car was waiting at a turnout for the car going in the opposite direction to come along. "It's shameful," complained an impatient woman passenger, "to have to be stopped here like this."
"Well, ma'am," said the conductor, calmly, "if you want to finish your trip in an ambulance, we can go on and collide with the other car."—Boston Transcript.

LIKELY.

Judge—Officer, what's the matter with the prisoner—tell her to stop that crying—she's been at it fifteen minutes (more sobs).
Officer—Please, sir, I'm a-thinking she wants to be bailed out.—Nebraska Awgwan.

MIRRED.

"And how is Rogers getting on? He always declared that he would leave footprints in the sands of time."
"Yes, but unfortunately he got stuck in the mud."—Boston Transcript.

The cultured young woman from Girton was trying to make conversation:

"Do you care for Crabbe's Tales?" she asked.

"I never ate any," replied her partner at the fancy dress ball; "but I'm just dead struck on lobsters' claws."—Sacred Heart Review.

"John, I simply cannot stand these algebra exercises you bring in," said the teacher. "They are horrible; just full of mistakes. I shall have to write your father about them."

"Papa will be awful angry," said Johnny.

"I suppose he will, but it is my duty to write."

"Better not," insisted Johnny. "Father does all my algebra for me."

"Why, what in the world has become of your watch? The one you used to have had a handsome gold case."

"I know it did, but circumstances alter cases."—Philadelphia Telegraph.

NO HESITATION.

Magistrate (severely)—Horsewhipping is the only suitable punishment for you and your kind. The idea of a man of your size beating a poor, weak woman like that!

Prisoner—But, your worship, she keeps irritating me all the time.

Magistrate—How does she irritate you?

Prisoner—Why, she keeps saying: "Hit me! Beat me! I dare you to hit me! Just hit me once and I'll have you hauled up before that baldheaded old reprobate of a judge and see what he'll do with you!"

Magistrate (chokingly)—Discharged!—London Mail.

A FREQUENT CALLER.

"Have you ever been to this court before, sir?"

"Yes, sir; I have been here often."

"Ha, ha! Been here often, have you? Now tell the court what for."

"Well, I have been here at least a half dozen times to try and collect that tailor's bill you owe me."

FATHER'S ULTIMATUM.

"I think two can live as cheaply as one, sir."

"You can't edge into my family on that theory, young man. I'm willing to keep on supporting my daughter, but you'll have to pay board."—Louisville Courier-Journal.

HAD MORE SENSE.

A country lad found a lost horse in an amazingly short time. Asked how he did it, he replied, "I jes set down and thought w're I'd go if I was a hoss. Then I went there, and there he was!"

"Why, Willie," said the teacher, in a pained voice, "have you been fighting again? Didn't you learn that when you are struck on one cheek you ought to turn the other one to the striker?"

"Yes'm," agreed Willie, "but he hit me on the nose and I've only got one."—Sacred Heart Review.

"A burglar got into my house about 3 o'clock this morning, when I was on my way home from the club," said Jones.

"Did he get anything?" asked Brown.

"I should say he did get something," replied Jones. "The poor devil is in the hospital. My wife thought it was me."—Cincinnati Enquirer.

"Please, sir," said the maid to the head of the house, "there's a gentleman here to see you on business."

"Tell him to take a chair."

"Oh, he's already taken them all, and now he's after the table. He's from the installment house."

Poetical Selections.

THE KICKER.

I am the mutt,
I am the prize jay
Of the universe,
Or worse,
If you can imagine
Such a thing,
By jing!
I am the rube,
The verdant boob,
The empty pated,
Rattle brained galoot
And more
To boot,
Who kicks
And shies the bricks
And mud
With sickening thud
At everyone.
Mud by the ton
I heave when things
Political do not go right.
I fight,
I bite,
I cuss, I swear,
I tear my hair,
When poll returns I read
And they don't suit my need,
I paw, I claw,
The rag I chaw,
I have a grouch—
Ouch!
I criticise,
Call men unwise
For voting as they do.
It makes me sick,
Right quick,
And anger surges
Through my dome
When others vote,
I am the rube,
I am the boob
Who stays at home.
—Electrical Workers' Journal.

AROUND, TROUBLE.

When trouble knocks hard on my shop door,
I don't get up and answer no more.
I set right still until his hands get sore.
Years ago, when I was young and thin,
I used to get up and ask him in,
And listen to all the yarns he'd spin.
And I'd think all day and I'd dream all
night,
Till I didn't have no appetite,
And I couldn't work and I couldn't fight.
Then I woke one day, with an awful start,
With a change of head and a change of
heart,
And I laid for trouble, to play my part.
When he came along and saw my eye,
He turned away out to pass me by.
And I held my head up bold and high.
So when he knocks at my shop door,
I get my hammer, I cross the floor,
But trouble don't hang around no more.
—Selected.

THE SONG THAT REACHED MY HEART

"I sat 'midst a mighty throng
Within a palace grand,
In a city far beyond the sea,
In a distant foreign land.
I listened to the grandest strain
My ear had ever heard—
Enraptured, charmed, amazed I was,
My inmost soul was stirred.

I looked on the singer fair,
My heart was at her feet.
She sang of love—the old, old theme—
In accents low and sweet.
And then she sang a song,
That made the teardrops start;
She sang a song, a song of home,
A song that reached my heart.

"That night I shall never forget;
That night, with pleasure and pain.
I think of the singer—I think of the song
And wish I could live it o'er again.
In fancy again I recall
The scene with its splendor bright;
The mighty throng, the palace grand;
Oh, the mem'ry of that night.

My fancy it may have been,
But never had I heard
A song that thrilled me o'er like this,
Like this, so strangely stirred.
The mem'ries of that night of bliss
Will never from me part—
She sang a song of "Home, Sweet Home,"
The song that reached my heart.

CHORUS.

"Home, home, sweet, sweet home;
She sang a song of 'Home, Sweet Home,'
The Song that reached my heart."
—Julian Jordan.

THE MULE.

The mule, he is a funny sight,
He's made of ears and dynamite;
His heels are full of bricks and springs,
Tornadoes, battering rams and things.
He's fat as any poisoned pup;
It's jest his meanness swells him up;
He's always scheming 'round to do
The things you most don't want him to.
The mule, he lives on anything,
He's got a lovely voice to sing,
And when he lets it loose at noon,
It sounds like buzz saws out of tune.
He stands around with sleepy eye
And looks as if he'd like to die.
But when there's any dying done
It ain't the mule, I'll bet a bun.
Some folks don't treat mules with respect;
They say they ain't got no intellect;
That may be so, but if you've got
To go to heaven on the spot,
And want a way that doesn't fail,
Jest pull the tassel on his tail.
The mule, he tends to his own biz;
He don't look loaded, but he is.

—Exchange.

THE FACTORY CHILD.

By J. J. Galvin.

"O Father in Heaven, be good to me;
Sweet Mother of God, I trust in thee."

Thus prayed the Child of the Factory Town,
A girl of ten, yet broken down
By toll and fear, and a life so sad
The Recording Angel, in pity, had
Written these words, with severest look,
In letters of flame, in the Lost Soul Book:
"The brute who tortures a child will be
Punished in hell through eternity."

"My father was good, and kind, and true,
And mother loved me, as mothers do;
They passed away in the factory's grind,
And left an orphaned girl behind.
I do no wrong, and I do not shirk
The hardest kind of factory work;
But they pile it on me, oh, so high,
That I sometimes wish I, too, could die.

"I hear them talk of the land of the free,
Where each child has the same opportunity;
Yet I never played, like the master's girls,
Or had a doll with clustering curls,
Or a piece of cake, or a candy bear—
But maybe some day, when people care,
They'll change the laws, so ones like me
Will have a chance, as it ought to be."

She lived awhile, in youthful hope—
Like the flower of devotion, the hellotrope.
With childish faith in the heart of man,
Believed, as only children can;
And died with the prayer her mother
taught—

When men forget, God must be sought:

"O Father in Heaven, be good to me;
Sweet Mother of God, I trust in thee."

KEEP THE FURROW STRAIGHT.

Editor Journal:

When a plowin' in de stubbles,
Earnin' ob you dally bread,
Keep a watchin' out foh trouble,
Always lookin' straight ahead.

Life's de fiel' where you am workin',
Massa's watchin' at de gate;
He will punish you foh shirkin'—
Try to keep de furrow straight.

Smilin' gals may call you "Honey,"
But you hab dis work to do;
Doesn't pay to get too funny—
Keep de furrow straight and true.

You may whistle an' be jolly,
As you urge de mules along;
Only shun de ways ob folly,
As you sing your merry song.

Eb'ry day you're gettin' oldeh—
Soon you laheh will be through;
An' de plow may strike a bouldeh—
Knock de stuffin' out of you.

Massa knows de task am dreary,
An' de way am full ob ca'ah—
Dat de mules get worn and weary,
An' will wabble heah an' deah.

He will not expect perfection—
Only do de bes' yo' can;
Try to keep de right direction,
Try to be an hones' man.

All aroun' temptations beckon—
Fix yo' eye upon dat gate;
Massa's watchin' you, I reckon—
Try to keep de furrow straight.

GEORGE W. WOODWORTH.

In Memoriam

MEMBERS.

William Sloan, Reg. No. 5186, age 47, of
Lodge No. 281, Boston, Mass. Was born in
Scotland, February 11, 1868. Died 2:30 P.
M., Friday, February 12, from hemorrhage.
Married, leaving one boy. Charter member
of Local No. 197.

Charles J. Rogillio, member Local No. 305.
Died from attack of appendicitis, at New
Orleans, La., January 9, 1915; age 22; single.

RELATIVES OF MEMBERS.

Mabel Stovall, age 35 years, wife of Brother
Leonard Stovall, was born at Leneoke,
Tex., September 10, 1879. Died November
13, 1914, from pleagelegry.

Mrs. Hennessy, mother of Brother Thos.
Hennessy, died February 8, 1915.

James Ceurry, Jr., age 32, son of Brother
James Ceurry, of Lodge No. 37. Born at
New Orleans, La., in 1883. Died January
17, 1915, at 5:30; Brights disease.

Fred Lutchgens, age 45, brother of Brother
Henry Lutchgens, was born in New Or-
leans, La. Died December 18, 1914; caused
from accident.

Fred Kull, age 78 years, father of Brother
Frank Kull, died Monday, February 8, 1915.

Grelley Pedicord, age 41, brother of Brother
Harry Pedicord, was born in Springfield,
Ill., January 3, 1873; died January 22, 1915,
from enlargement of the heart.

Anna Mae Ray, age 18 days, daughter of
Roy Ray, was born in Decatur, Ill.; died
January 17, 1915, from lung fever.

LIST OF MEMBERS PREVIOUSLY ADVERTISED

J. D. Landault, Reg. No. 87363, left Teague, Tex., owing a grocery bill of thirty-nine dollars and ninety-five cents (\$39.95). He is wanted by Mrs. John Cure, Teague, Tex., who stood good for the amount.

T. D. Swain, Reg. No. 38826, by Lodge No. 567, for non-payment of a note of seventy-five dollars (\$75.00).

R. L. WHITE,
Cor. Secretary Lodge No. 567.

H. E. or Earnest Robertson is wanted by Lodge No. 173, for failing to make good some money he borrowed.

J. P. TAYLOR,
Lodge No. 173.

Stewart et al—Lodge No. 66.

Any secretary taking up the card of Edgar Stewart, Reg. No. 21232, or Noble C. Townsend, Reg. No. 62038, will please correspond with the secretary of No. 66, Little Rock, Ark., as these brothers misrepresented facts and secured transportation out of Little Rock, and Lodge No. 66 had to pay for same.

E. WORTHSMITH,
Corresponding Secretary No. 66.

C. W. Higgins—Mrs. R. J. Williams.

Anyone knowing the whereabouts of Brother C. W. Higgins, last heard from at Drumright, Okla., will confer a great favor by writing to Mrs. R. J. Williams, 227 Pierce Street, San Francisco Calif.

W. B. BOWSER, B. A.

Lodge Notices

Anderson—Disbrow.

Any secretary taking up the card of Brother E. A. Anderson, Reg. No. 73599, will do him a great favor by telling him to write to F. E. Disbrow, secretary of Lodge No. 72.

F. E. DISBROW.

Lost and Found

Lost—Duebook and Card.

The duebook and card of Brother George Tannehill was lost or stolen from him at Cushing, Oklahoma. Anyone finding or hearing of either will please correspond with the undersigned.

GEO. TANNEHILL,
Care Lilly Hotel, Cushing, Okla.

Auditor's Report for 1914

INTERNATIONAL BROTHERHOOD OF BOILER MAKERS, IRON SHIP BUILDERS AND HELPERS OF AMERICA. REPORT ON EXAMINATION OF ACCOUNTS FOR THE PERIOD FROM JULY 17, 1914, TO DECEMBER 31, 1914.

EDWARD J. DILLON & COMPANY,
Certified Public Accountants.
1102-3 Republic Bldg.
Kansas City, Mo., Feb. 3, 1915.

Mr. J. A. Franklin, President International Brotherhood of Boiler Makers, Iron Ship Builders and Helpers of America, Kansas City, Kansas.

Dear Sir: We have examined the accounts of the International Secretary-Treasurer, Mr. F. P. Reinemeyer, and the Editor and Manager of the Journal, Mr. J. B. Casey, of the International Brotherhood of Boiler Makers, Iron Ship Builders and Helpers of America, for the period from July 17th, 1914, to December 31st, 1914, and herewith submit our report.

The following is a summary of the transactions in the various fund accounts for the period:

	Total.	FUND					
		Strike Benefit.	General.	Death and Disability.	Journal.	Transportation.	Fidelity.
Balance as at July 17, 1914	\$ 58,555.10	\$36,430.76	\$ 2,316.43	\$17,413.15	\$1,211.18	\$1,171.58	\$12.00
Cash Receipts	84,263.15	33,273.45	34,302.56	7,481.87	5,819.20	3,325.07	61.00
Total	\$142,818.25	\$69,704.21	\$36,618.99	\$24,895.02	\$7,030.38	\$4,496.65	\$73.00
Deduct: Disbursements	69,083.10	23,462.94	35,940.23	4,500.00	5,136.83	43.10
Balance as at December 31, 1914..	\$ 73,735.15	\$46,241.27	\$ 678.76	\$20,395.02	\$1,893.55	\$4,453.55	\$73.00

The general fund was credited direct with the amount of the raffle, \$1,049.50, and charged with the same amount when disbursement was made. \$21.00 was properly credited direct to the strike fund, and 61c to the general fund. This accounts for the difference in receipts of these funds.

CASH ACCOUNT.
In Exhibit "A," we submit a detailed statement of cash receipts and disbursements, which may be summarized as follows:
Receipts.....\$84,446.44
Disbursements..... 69,266.39

Excess of Receipts over Disbursements.....\$15,180.05
Balance on Hand July 17, 1914..... 58,555.10
Balance as at December 31, 1914....\$73,735.15

Statement of Funds. The cash receipts during the period under review, after deducting the receipts of premiums in respect of bonds, were apportioned to the various funds in the following percentages:
Strike Benefit Fund..... 40%
General Fund..... 40%
Death and Disability Fund..... 9%
Journal Fund..... 7%
Transportation Fund..... 4%
..... 100%

We checked the cash received from members and verified its distribution to the proper lodges.

The receipts from advertising, subscriptions, etc., as shown by the records of the Journal Editor, were compared with the records of the International Secretary-Treasurer and found correct.

The interest received on bank balances was verified with the bank passbook. We verified that all receipts were deposited in bank. Check No. 431, amounting to \$4.25, covering a deduction for an amount due from a business agent, was not put through the bank but used as a cash receipt. We verified this item and found it correct.

We verified the disbursements with the cancelled checks, receipts and vouchers. In Schedule "I," we submit a statement of payments to the officers of the Brotherhood analyzed according to salaries, expenses and cash advances for which no reports of expenditures had been received at the date of our examination.

Cash Balance as at December 31, 1914—\$73,735.15. This amount was on deposit with the Commercial National Bank of Kansas City, Kansas, in two funds as follows:

Checking Account	\$23,735.15
Time Deposit	50,000.00
	<hr/>
	\$73,735.15

We have reconciled this balance with the balance certified by the bank.

GENERAL.

Balance of Lodge Accounts. In Appendix "I," we submit a detailed list of debit and credit balances of the lodges as at December

31, 1914, of which the following is a summary:

	Due by Lodges.	Due to Lodges.
Boiler Makers' Lodges.....	\$4,066.95	\$14.95
District Lodges	234.85	4.82
Ladies' Auxiliary Lodges..	6.20	3.20
Total	\$4,308.00	\$22.97

The foregoing debit balances, \$4,308.00, are old balances and were all contracted prior to July 17, 1914. With the exception of \$40.65 all stamps and supplies sent out during the period under review have been paid for.

The balances due to all the lodges, July 17, 1914, amounting to \$121.65, were carried forward to the new ledger, and, with the exception of \$22.97 shown in Appendix "I," were absorbed during this period. We have checked all the entries where absorbed credits were allowed and found them correct.

The old net balance due from lapsed lodges, July 17, 1914, amounting to \$783.16, and the old net balance due from Helpers' Lodges, July 17, 1914, amounting to \$1,888.26, were both charged off.

Combined Cash Account. We submit in Exhibit "B" a combined cash account for the period from January 1, 1914, to December 31, 1914. This report was made by combining the cash account for the current period under review with the one furnished us from a prior audit for the period from January 1, 1914, to July 16, 1914.

With many thanks for the courtesies extended to us during the course of our examination, we remain,

Yours truly,
EDWARD J. DILLON & CO.,
Certified Public Accountants.

INDEX.

- Exhibit "A"—Cash Receipts and Disbursements for the Period from July 17, 1914, to December 31, 1914.
- Schedule "I"—General Fund, Salaries and Expenses of Officers for the Period from July 17, 1914, to December 31, 1914.
- Exhibit "B"—Cash Account for the Period from January 1, 1914, to December 31, 1914.
- Appendix "I"—Balances of Lodge Accounts, as at December 31, 1914.

CASH RECEIPTS AND DISBURSEMENTS.

Exhibit "A"

For the Period from July 17, 1914, to December 31, 1914.

RECEIPTS:

Due Stamps:	
Boiler Makers	\$53,742.35
Helpers and Apprentices.....	17,452.20
Initiation	1,191.00
Out of Work	538.50
Reinstatement.....	781.00
Supplies	2,460.53
Raffle	1,049.50
Bonds	61.00
Old Accounts	4,943.26
Interest	637.91
Lapsed Lodges	109.80
Charters	75.00
J. Callahan, St. Louis Reorganization.....	286.00
Lodge 27, St. Louis Reorganization.....	174.90
Lodge 353, Reorganization	10.00
Lodge 259, Reorganization	41.95
Balance in Treasury, Lodge 338.....	30.39
Lodge 4, Payment Protested Check and Fees, contra.....	183.29
Sundry Items	117.03
Journal:	
Commission on Book Sales.....	82.50
Subscriptions	3.00
Advertisements.....	475.53

Total Receipts **\$84,446.44**

DISBURSEMENTS:

General Fund:	
Salaries and Expenses:	
Officers	\$15,302.33
International Deputy Organizers.....	3,370.69
Special Deputy Organizers.....	946.24

Business Agents	3,025.00
Clerks	2,837.75
Freight on Proceedings	42.10
Printing Convention Proceedings	797.65
A. F. of L. Proceedings	7.50
Printing and Stationery	3,041.65
Office Supplies and Repairs	39.43
Laundry	1.93
Postage	456.50
Telegraph	507.18
Telephone	74.70
Express	332.49
Office Rent	292.50
Electric Light	9.84
Auditing	215.00
Bookkeeping System	125.00
Card Index System	288.70
Typewriter	106.59
W. J. Gilthorpe Annuity	500.00
Taxes	9.44
Attorney Fees	285.00
Bonds for the International Secretary-Treasurer	125.00
Ice and Water	38.55
J. B. Casey, Notary Bond	5.50
Meals and Lodging, J. Thompson	93.60
Badges and Buttons	138.33
Exchange on Checks	5.75
Jeweler, Alex Fuhrman	36.50
Seals	33.15
Capita Tax and Assessment:	
American Federation of Labor	330.46
Metal Trades Dept., A. F. of L.	210.87
Canadian Congress	13.40
Railway Dept., A. F. of L.	56.20
Bldg. Trades Dept., Application Fee	100.00
Delegates to A. F. of L. Bldg. Trades Dept.	1,163.30
Refund of Reinstatement Fee	5.00
Raffle, Benefit Mrs. H. C. Wagner	971.50
Total General Fund	\$35,940.23

Journal Fund:	
Editor's Salary	\$ 650.00
Articles for Journal	14.00
Commission for Advertising	30.00
Editor's Expense to St. Louis	19.60
Editor's Expense to Topeka	6.30
Stenographer's Salary	288.00
Rent	107.50
Attorney Fee	150.00
Postage	374.49
Miscellaneous	37.10
Printing, Cuts, etc.	3,459.84
Total Journal Fund	5,136.33
Strike Benefit Fund:	
Paid to Members	23,462.94
Death Benefit Fund:	
Paid to Beneficiaries of Members	4,500.00
Transportation Fund:	
Pullman Fare to Convention	43.10
Returned Check and Protest Fee as per contra	183.29

Total Disbursements 69,266.39

Excess of Receipts over Disbursements \$15,180.05

Add: Cash Balance as at July 16, 1914. 58,555.10

Balance as at December 31, 1914. \$73,735.15

Deposited with the Commercial National Bank of Kansas City, Kansas:	
Checking Account	\$23,735.15
Time Deposit	50,000.00
	<u>\$73,735.15</u>

GENERAL FUND.
Schedule "P"
SALARIES AND EXPENSES OF OFFICERS
For the Period from July 17, 1914, to December 31, 1914.

	Total	Salaries Paid	Expenses.	Cash Advances and Expenditures Not Reported.
J. A. Franklin, Int. Pres.	\$ 1,815.00	\$1,200.00	\$ 615.00
F. P. Reinemeyer, Int. S.-T.	1,002.35	900.00	102.35
A. Hinzman, 1st Int. V.-Pres.	1,332.62	687.50	460.24	\$ 184.88
Thos. Nolan, 2nd Int. V.-Pres.	1,475.29	687.50	787.79
J. P. Merrigan, 3rd Int. V.-Pres.	1,182.92	687.50	406.58	88.84
Lewis Weyand, 4th Int. V.-Pres.	1,289.12	687.50	516.82	84.80
Wm. Atkinson, 5th Int. V.-Pres.	1,558.29	687.50	770.79	100.00

Jno. J. Dowd, 6th Int. V.-Pres.....	1,351.62	687.50	564.12	100.00
M. A. Maher, 7th Int. V.-Pres.....	1,329.78	687.50	567.28	75.00
J. P. Ryan, 8th Int. V.-Pres.....	1,445.00	687.50	549.39	208.11
J. F. Schmitt, 9th Int. V.-Pres.....	1,335.64	687.50	448.14	200.00
Wm. J. Gilthorpe, Retired Int. S.-T.....	150.00	150.00
Jas. B. Casey, Editor and Mgr. Journal..	34.70	34.70
Total	\$15,302.33	\$8,437.50	\$5,823.20	\$1,041.63

CASH ACCOUNT.
Exhibit "B"

January 1, 1914. to December 31, 1914.

RECEIPTS:

Capita Tax and Assessments from Members.....	\$176,590.12
Interest on Bank Balances.....	1,249.55
Journal, Advertising, etc.....	1,661.95

Total Receipts **\$179,501.62**

DISBURSEMENTS:

General Fund:

Salaries and Expenses:

Officers.....	\$30,622.02
International Deputy Organizers.....	4,333.25
Special Deputy Organizers.....	946.24
Business Agents.....	3,525.00
Special Commissioner.....	50.00
Clerks.....	6,413.54
Bookkeeping System.....	125.00
Card Index System.....	288.70
W. J. Gilthorpe Annuity.....	500.00
Printing and Stationery.....	4,439.55
Postage.....	967.50
Telegraph.....	1,169.96
Telephone.....	223.65
Express.....	559.19
Rent.....	702.00
Auditing.....	465.00
Legal Expenses.....	320.00
Insurance.....	39.50
Office Supplies.....	297.73
Gavels, Ballot Boxes, etc.....	44.25
Gold Buttons, Seals, etc.....	74.07
Hotel Tickets.....	209.40
Electric Lights.....	32.25
Ice and Water.....	78.35
Bank Charges.....	12.96
Typewriters.....	141.50
Norfolk and Western Federation Meeting Exp.....	95.00
St. Louis Dispute Expenses.....	25.00
Bound Volumes of President's Message.....	79.50
Capita Tax and Assessments:	
Railway Dept. of A. F. of L.....	565.79
Metal Trades Dept. of A. F. of L.....	462.39
Canadian Congress.....	188.10
American Federation of Labor.....	1,161.28
Bldg. Trades Dept., Application Fee.....	100.00
Delegates to A. F. of L. Bldg. Trades Dept.....	1,163.30
San Francisco Convention Expense:	
Rent of Hall.....	430.00
Stenographers' Services Reporting Proceedings, etc.....	637.95
Printing Daily Proceedings.....	1,121.00
Delegates' Services on Law Credential Committees.....	887.30
Ladies' Auxiliary—Salary of Delegate.....	51.00
Sergeant-at-Arms.....	60.00
Printing Convention Proceedings.....	797.65
Freight on Proceedings.....	42.10
A. F. of L. Proceedings.....	7.50
Miscellaneous Expenses.....	38.75
Taxes.....	9.44
Bonds for the Int. Secretary-Treasurer.....	125.00
J. B. Casey, Notary Bond.....	5.50
Badges and Buttons.....	136.33
Jeweler, Alex Fuhrman.....	36.50
Refund of Reinstatement Fee.....	5.00
Raffle, Benefit Mrs. H. C. Wagner.....	971.50

Total General Fund..... **\$65,783.49**

Journal Fund:

Editor's Salary.....	\$1,400.00
Editor's Expense to Topeka.....	6.30
Editor's Expenses Attending Convention.....	162.50
Editor's Expense to St. Louis.....	19.60
Articles for Journal.....	37.00
Printing, Cuts, etc.....	8,156.72
Postage.....	880.65
Supplies.....	113.18
Rent.....	258.00
Stenographer's Salary.....	621.00
Commissions on Advertisements.....	76.30
Insurance.....	54.64

Attorney Fee	150.00	
Miscellaneous	55.26	
Total Journal Fund.....		11,991.15
Strike Benefit Fund:		
Paid to Members.....		66,772.38
Death Benefit Fund:		
Paid to Beneficiaries of Members.....		7,450.00
Transportation Fund:		
Railroad and Pullman Convention Delegates.....	4,767.34	
Returned Check and Protest Fees, see Contra.....	183.29	
Total Disbursements		\$156,947.65
Excess of Receipts over Disbursements.....		\$ 22,553.97
Add: Cash Balance as at January 1, 1914.....		51,181.18
Balance as at December 31, 1914.....		\$ 73,735.15
Deposited with the Commercial National Bank of Kansas City, Kansas:		
Checking Account	\$23,735.15	
Time Deposit	50,000.00	
		\$73,735.15

BALANCES OF LODGE ACCOUNTS.

Appendix "P"

As at December 31, 1914.

No.	Address.	Due from Lodges.	Due to Lodges.	No.	Address.	Due from Lodges.	Due to Lodges.
1	Chicago, Ill.	\$ 322.65		510	Cedartown, Ga.		.25
5	Cleveland, O.	172.94		511	Whistler, Ala.		15.37
7	Buffalo, N. Y.	150.10		515	Cambridge, Mass.		3.80
12	Macon, Ga.	58.60		520	Miles City, Mont.		64.00
16	Jersey City, N. J.	5.45		529	Rivers, Man., Can.		42.20
19	Philadelphia, Pa.		\$ 0.20	530	Springfield, Mo.		3.85
42	Nashville, Tenn.	42.25		547	Carbondale, Pa.		48.50
45	Greenpoint, Brooklyn	526.08		551	Princeton, W. Va.		15.39
47	Des Moines, Ia.	9.30		568	Tacoma, Wash.		1.40
50	Charleston, S. C.		.25	570	High Springs, Fla.		.25
51	St. Louis, Mo.	407.40		577	Cumberland, Md.		7.45
54	Ft. Wayne, Ind.	166.65		582	Baton Rouge, La.		3.75
54	Ft. Wayne, Ind.	166.65		585	Boston, Mass.		371.35
72	Portland, Ore.	104.30		587	Beaumont, Tex.		14.25
74	Houston, Tex.	20.50		592	Tulsa, Okla.		.60
88	Jackson, Tenn.	14.20		596	Casper, Wyo.		.10
112	Mobile, Ala.	39.31		600	Akron, O.		21.90
116	Brainard, Minn.	.30		604	Jollette, Que., Can.		28.55
118	No. Platte, Neb.	3.23		606	Mobridge, S. D.		.75
125	Dunkirk, N. Y.	7.30			E. Duffy		.50
130	So. Butte, Mont.	1.90		Total Boiler Makers.....		\$4,066.95	\$14.95
135	Chillicothe, O.	28.10		District:			
137	Paducah, Ky.	28.35		2	New York, N. Y.	\$ 79.36	
142	Knoxville, Tenn.		.70	3	Baltimore, Md.	3.60	
163	Hoboken, N. J.	333.54		4	Omaha, Neb.	1.75	
173	Raleigh, N. C.		.25	6	Oakland, Cal.		.50
175	Oswego, N. Y.	18.10		7	Boston, Mass.	2.75	
205	San Francisco, Cal.		.75	8	Meadville, Pa.	21.63	
218	Springfield, Mass.	18.24		9	Philadelphia, Pa.	33.01	
220	Chicago, Ill.	89.75		11	Sayre, Pa.	16.45	
223	Utica, N. Y.	48.50		14	San Bernardino, Cal.		2.50
241	Washington, Ind.		.75	19	Roanoke, Va.		.02
254	Chicago Heights, Ill.	4.79		20	Memphis, Tenn.	5.25	
267	Moberly, Mo.	4.70		21	Bellefontaine, O.	1.70	
286	Ft. Scott, Kans.		.20	24	Springfield, Ill.	.95	
318	Pittsburgh, Pa.	166.01		25	St. Paul, Minn.	14.00	
320	Meridian, Miss.	14.55		26	Savannah, Ga.	13.90	
328	Shreveport, La.	12.46		27	Chattanooga, Tenn.		1.55
341	Philadelphia, Pa.	164.41		28	St. Joseph, Mo.	1.75	
350	Gulfport, Miss.	32.85		30	Winnipeg, Man., Can.	2.85	
369	Alexandria, Va.	63.60		31	Grafton, W. Va.	10.40	
371	Keene, N. H.	125.04		33	Saginaw, Mich.	1.50	
379	Macadam, N. B., Can.	3.75		34	Boston, Mass.	3.25	
381	Amarillo, Tex.	.82		36	Schnectady, N. Y.	11.25	
393	Good Land, Kans.	20.42		39	Columbus, Ga.		.25
408	Ennis, Tex.	18.20		40	Hamlet, N. C.	4.25	
410	San Francisco, Cal.	42.75		1	Hamlet, N. C.	5.25	
415	Jacksonville, Ill.	64.65		Total Districts		\$ 234.85	\$ 4.82
418	Neodesha, Kans.	3.00		Ladies' Auxillary:			
422	Sanford, Fla.		1.50	4	Kansas City, Mo.	\$.20	
434	Chicago, Ill.	23.05		5	Salt Lake City, Utah	1.00	
436	Columbus, O.	10.00		7	Parsons, Kans.		1.55
451	Winnipeg, Man., Can.		.75	8	McComb, Neb.	5.00	
469	Terrell, Tex.		.40	9	Grand Junction, Colo.		1.65
481	Lyndonville, Vt.		.40	Total Ladies' Auxillary....		\$ 6.20	\$ 3.20
489	Seattle, Wash.	38.75		Total Boiler Makers, Dis-			
492	New Castle, Pa.	.45		trict, Ladies' Auxillary..		\$4,308.00	\$22.97
509	Jackson, O.	.25					

OFFICIAL ROSTER--International Officers

J. A. FRANKLIN.....International President
Room 15, Law Bldg., 721 Minnesota Ave., Kansas City, Kas.

F. P. REINEMEYER.....Int. Secretary-Treasurer
Rooms 10 to 12 Law Bldg., 721 Minnesota Ave., Kansas City, Kas.

JAMES B. CASEY.....Editor-Manager of Journal
Room 9, Law Bldg., Kansas City, Kas.

A. HINZMAN.....First Int. Vice-President
Room 15, Law Bldg., 721 Minnesota Ave., Kansas City, Kas.

MISSOURI AND MISSISSIPPI DISTRICT.
States of Iowa, Missouri, Kansas, Nebraska, Arkansas, Mississippi, Alabama (other than Mobile), Tennessee, North and South Dakota, Oklahoma and Minnesota.

THOS. NOLAN.....Second Int. Vice-President
700 Court St., Portsmouth, Va.

GULF AND SOUTH ATLANTIC DISTRICT.
States of Texas, Louisiana, Florida, Georgia, North and South Carolina, Virginia, Maryland and Delaware, and Mobile, Ala.

J. P. MERRIGAN.....Third Int. Vice-President
91 Manufacturer St., Montreal, Que., Can.
CANADIAN DISTRICT.
The Dominion of Canada.

LOUIS WEYAND.....Fourth Int. Vice-President
6201 Fir Avenue, N. W., Cleveland, Ohio.
GREAT LAKES AND TERRITORY DISTRICT.
States of Wisconsin, Michigan, Cities of Chicago, Toledo, Cleveland and Lorain, O., Erie, Pa., State of New York (other than the City of New York).

WM. ATKINSON.....Fifth Int. Vice-President
212 South Pittsburg St., Spokane, Wash.
ROCKY MOUNTAIN AND PACIFIC COAST DISTRICT.

Honolulu, States of California, Oregon, Washington, Idaho, Utah, Nevada, Montana, Wyoming, Colorado, Arizona, Old Mexico, New Mexico and Canal Zone, Panama.

JOHN J. DOWD.....Sixth Int. Vice-President
Home address, 168 Wilkinson Ave., Jersey City, N. J.

EASTERN SEABOARD DISTRICT.
States of Maine, New Hampshire, Vermont, Massachusetts, Rhode Island, Connecticut, New Jersey and New York City.

M. A. MAHER.....Seventh Int. Vice-President
1401 Center St., Portsmouth, Ohio.

OHIO VALLEY AND TERRITORY DISTRICT.
States of Pennsylvania (other than the city of Erie), Ohio, West Virginia, Kentucky, Indiana and Illinois (other than the City of Chicago).

JOS. P. RYAN.....Eighth Int. Vice-President
5830 Wentworth Ave., Chicago, Ill.
Phone Wentworth 8739.

HELPERS' VICE-PRESIDENT OF WESTERN DIVISION.
All states west of dividing line between Indiana and Ohio.

JOHN F. SCHMITT.....Ninth Int. Vice-President
1489 N. Fourth St., Columbus, Ohio.

HELPERS' VICE-PRESIDENT OF EASTERN DIVISION.
All states east of dividing line between Indiana and Ohio.

District Lodges and Officers

DISTRICT No. 2—New York, N. Y. Meets 1st and 3rd Wed. Patrick T. Keneally, President, 9 Magnolia Ave., Jersey City, N. J.

Wm. Brown, Vice-Pres., Elizabeth Ave., Elizabeth, N. J.
Gerald A. Daly, Sec.-Treas., 676 60th St., Brooklyn, N. Y.

DISTRICT No. 5—St. Louis, Mo. Mo. Pac. and Iron Mountain R. Lodges represented: 32, 38, 44, 66, 82, 106, 113, 117, 286, 322, 403, 507, 521, 542, 543, 565, 583 and 599.

John C. Morrow, Pres., 613 W. 4th St., Coffeyville, Kans.

Hal. Stack, Vice-Pres., Van Buren, Ark.

John J. Murphy, Secy., 3404 Eads Ave., St. Louis, Mo.

J. N. Shirley, Treas., Box 495, Holington, Kans.

A. E. Stewart, Member Ex. Board, 2533 Myrtle Ave., Kansas City, Mo.

A. J. Radford, Member Ex. Board, 624 Oak St., Little Rock, Ark.
Chas. A. McDonald, B. A., 4414 Winsor St., Kansas City, Mo.

DISTRICT No. 6—Southern Pacific R.R. Lodges represented: 32, 33, 46, 48, 52, 74, 92, 49, 98, 101, 113, 179, 193, 206, 216, 223, 239, 252, 309, 345, 339, 535, 553, 169.

J. J. Jones, Pres. and C. S., 1630 New Hampshire Ave., Los Angeles, Cal.

J. C. Carroll, V.-P., North Platte, Neb.
S. T. Feazelle, Sec.-Treas., Gate City Hotel, Pocatello, Idaho.

DISTRICT No. 10—Davenport, Ia. Rock Island System. Lodges represented: 377, 144, 346, 199, 340, 293, 323, 434, 439, 491, 96, 32, 66, 476, 522, 523.

Geo. W. Pring, Pres. & B. A., 677 38th St., Des Moines, Ia.

John Mitchell, V.-P., 1502 McGowan St., Little Rock, Ark.
S. T. Sample, C. & F. S., 515 N. Jackson St., Pratt, Kas.
J. J. Lynch, Treas., Box 655, Herington, Kas.

DISTRICT No. 12—New York, New York Central System. Lodges represented: 5, 7, 10, 64, 67, 85, 150, 167, 169, 175, 197, 218, 223, 229, 321, 413, 492.

A. M. Anderson, Pres., 2208 Francis St., Jackson, Mich.

G. H. Gates, Vice-Pres., 148 N. Orchard St., Watertown, N. Y.
J. J. Leamy, Sec.-Treas., 68 Livingston Ave., Albany, N. Y.

Trustees—Wm. Weber, E. J. McNamara and Thomas Ranger.

DISTRICT No. 13—Birmingham, Ala. Southern R. R. System. Organized Feb. 23, 1904. Lodges represented: 2, 4, 12, 14, 40, 50, 28, 105, 143, 170, 226, 235, 312, 320, 334, 344, 369, 419, 511, 524; H. D., 27, 111, 175, 240.

Thos. J. Garvey, Pres., 414 E. Byrd St., Richmond, Va.

A. E. Barksdale, V.-P., 543 E. Lafayette St., Jackson, Tenn.

P. E. Berney, Sec.-Treas., R. F. D. 12, Knoxville, Tenn.

DISTRICT No. 15—Chicago, Ill. C. & N. W. R. R. Lodges represented: 38, 60, 129, 145, 161, 201, 227, 311, 395, 440, 485, 496, 539, 597.

W. F. Scholes, Pres., 1929 Ave. E., Council Bluffs, Ia.

J. W. Francis, V.-P., 534 Springfield Ave., Chicago, Ill.
T. E. Burdette, Sec.-Treas., 428 North Chesnut Ave., Green Bay, Wis.

DISTRICT No. 19—Roanoke, Va. Norfolk & Western System. Lodges represented: 28, 402, 30, 405, 557. Meets Union Labor Hall.

C. D. Craft, Pres., 1402 Center St., Portsmouth, O.

M. F. Glenn, V.-P., 1414 McConnell Ave., Portsmouth, Ohio.
J. B. O'Brien, Treas., Roanoke, Va.

E. J. Horgan, C. & F. S., 404 7th Ave., S. E., Roanoke, Va.

DISTRICT No. 20—Ill. Cent. R. R. Headquarters, Chicago, Ill. Lodges represented: 56, 88, 132, 137, 40, 224, 426, 180, 220, 234, 300, 315, 363, 399, 95; H. D., 97, 106, 116, 102, 230, 174, 232, 223.

K. H. Eicker, Pres., 315 Dane St., Waterloo, Ia.

W. T. McCoid, V. P., 412 Madison St., Clinton, Ill.

E. G. Pullen, C. S. & Treas., 303 Columbia St., Waterloo, Ia.

DISTRICT No. 22—D. R. G. System, Colorado and Utah. Meeting place, Denver, Colorado; Date meeting: 2d Monday in July, 1915; Lodges represented: 44, 103, 179, 335, 427, 446, 473.

Geo. S. Warden, Pres. & B. A. 1507 E. 7th St., Pueblo, Colo.

H. F. Jones, Vice-Pres., 135 Sackett Ave., Salida, Colo.

A. A. Duncan, Sec.-Treas., Box 611, Alamosa, Colo.

DISTRICT No. 23—Meets at St. Louis, Mo., 2d Monday in October, 1914. Lodges represented: 4, 22, 27, 70, 95, 96, 180, 286, 418, 449, 458, 530, 531, 543, 546, 565, 575.

A. F. Bingham, Pres. and B. A., 701 Lombart St., Springfield, Mo.

L. W. Lawson, V.-P., 821 N. Maxey St., Sherman, Texas.

J. W. Reddick, Financial and Recording Secretary, 817 Lincoln St., Springfield, Mo.

A. A. Denton, Cor. Sec. and Treas., 1044 W. Mt. Vernon St., Springfield, Mo.

DISTRICT No. 24—Springfield, Ill. Advisory Board Wabash System. Lodges represented: 54, 81, 267, 384, 447, 581.

E. R. Lee, Pres., 324 Taylor St., Moberly, Mo.

James Gray, V.-P., L. No. 447, Gus L. Kloes, Sec., Box 213, Moberly, Ohio.

DISTRICT No. 25—Livingston, Mont. Northern Pac. R. R. J. G. Brown, Pres., 610 N. 9th St., Brainerd, Minn.

Frank Depender, V.-P., 735 E. Nora Ave., Spokane, Wash., Theo. W. Everett, Sec.-Treas., P. O. Box 554, Livingston, Mont.

Trustees—A. H. Shanks, 221 N. 2nd St., Missoula, Mont.; Hugh Roberts, Gen. Del., Glendive, Mont.; G. M. Owens, 212 So. E. St., Livingston, Mont.
DISTRICT No. 26—Aberden, S. D.
 C. M. & St. P. and Puget Sound R. R. Lodges represented: 11, 15, 22, 28, 41, 104, 244, 302, 485, 520, 528, 568, 588, 596, 603, 606.
 G. H. Hawksworth, Pres., Box 817, Deer Lodge, Mont.
 F. J. O'Brien, Vice-Pres., Avery, Idaho.
 Ed. McSperritt, Secy., Gen. Del., Miles City, Mont.
 P. W. Gunn, Treas., 3316-30 Ave. South, Minneapolis, Minn.
 J. L. Callahan, B. A., 3406 Clifton St., Milwaukee, Wis.
DISTRICT No. 27—Int. G. N. R.
 R. W. O. Faulk, Pres., Palestine, Tex.
 W. K. Saddler, Vice-Pres., Mart, Texas.
 E. H. Frick, Sec.-Treas., San Antonio, Tex.
 W. B. Graham, B. A., Palestine, Tex.
DISTRICT No. 29—Cincinnati, O.
 C. H. & D. R. R.
 W. J. Redmond, Pres., 204 N. Wash. St., Indianapolis, Ind.
 A. R. Griesheimer, Vice-Pres., 329 N. Elizabeth, Lima, O.
 Wm. J. McGee, Jr., Sec.-Treas., 1255 Richmond St., Cincinnati, O.
DISTRICT No. 30—Canadian Pacific. District Headquarters, Winnipeg, Man. Lodges in affiliation: 126, 184, 194, 379, 392, 451, 466, 478, 505, 529, 548, 417.
 Geo. F. Chadburn, Pres. and Acting Sec.-Treas., 1585 Alexander St., Winnipeg, Man.
 J. E. Smith, V.-P., 162 Annette St., Toronto, Ont.
 R. Carswell, V.-P., 684 Home St., Winnipeg, Man.
DISTRICT No. 31—Cincinnati, O.
 B. & O. System. Lodges represented: 5, 10, 79, 99, 105, 135, 241, 259, 318, 326, 332, 444, 493, 498, 514, 579, 578.

J. C. Smith, Pres., Box 292, Garrett, Ind.
 J. R. Cline, Vice-Pres., Cleveland, O.
 M. W. Luke, Sec.-Treas., 1007 W. Main, Washington, Ind.
DISTRICT No. 32—Grand Rapids, Mich., Pere Marquette System.
 Lodges represented: 34, 124, 413.
DISTRICT No. 34—Boston, Mass. Boston & Maine System. Lodges represented: 245, 371, 388, 481, 515, 517. Meets at Boston, Mass., 1st Monday in August and 2d Monday in February.
 W. H. Wells, Pres., 108 Westford St., Lowell, Mass.
 P. J. Kelley, Vice-Pres., 3 Devon St., Greenfield, Mass.
 T. J. Donahue, Sec.-Treas., 5 Fernald St., Lowell, Mass.
DISTRICT No. 35—Parsons, Kas.
 M. K. & T. R. R. System. Lodges represented: 292, 209, 501, 576 and 265.
 Fred Alsdorf, Pres. & B. A., 515 W. Owings St., Denison, Tex.
 C. Dudding, V.-Pres., 2229 Crawford St., Parsons, Kas.
 Robt. Rosbottom, Sec.-Treas., 600 W. Texas St., Denison, Tex.
 C. A. Denton, Rec. Sec., Parsons, Kas.
 Wm. Dickerson, Chairman Trustees, 810 Cleveland St., Waco, Tex.
DISTRICT No. 37—Texarkana, Tex. Cotton Belt R. R. System.
 Meets 3d Saturdays in January and July.
 R. M. Cummins, Pres. & B. A., 308 E. Valentine St., Tyler, Tex.
 John A. Smith, V.-P., 1908 E. 8th St., Pine Bluff, Ark.
 E. E. Shields, Sec.-Treas., 1503 E. 7th Ave., Pine Bluff, Ark.
DISTRICT No. 38—Atlantic Coast Line. Lodges represented: 20, 26, 239, 422, 425, 448, 570.
 A. J. Dixon, Pres., Rocky Mount, N. C.
 W. A. Cahill, Vice-Pres., Montgomery, Ala.

E. S. Ryan, Sec.-Treas., 508 Lackawana Ave., Jacksonville, Fla.
DISTRICT No. 39—Central of Georgia System. Meets 1st Friday after Thanksgiving each year at Columbus, Ga. Lodges represented: 4, 12, 26, 436, 510.
 R. J. Black, Pres., 913 2nd St., Macon, Ga.
 J. J. Dean, Vice-Pres., 226 Taylor St., Savannah, Ga.
 Chas. A. Buchnell, Sec.-Treas., 103 Gordon W., Savannah, Ga.
 E. M. Kendrick, Rec. Sec., Route 5, Cedartown, Ga.
 R. S. Barry, Cor. and Fin. Sec., 1109 5th Ave., Columbus, Ga.
DISTRICT No. 40—Hamlet, N. C. Seaboard Airline and leased lines. Lodges represented: 2, 20, 26, 298.
 B. M. Jewell, Pres., 421½ Forest St., Jacksonville, Fla.
 E. C. Howie, Sec.-Treas., 1119 E. 32d St., Savannah, Ga.
DISTRICT No. 41—Hinton, W. Va. Chesapeake & Ohio System. Lodges represented: 170, 238, 249, 364, 384, 525.
 David W. Morris, Pres., Forest Park, Peru, Ind.
 R. L. King, V.-Pres., 807 N. 24th St., Richmond, Va.
 C. L. Barnett, Sec.-Treas., 207 2d Ave., Hinton, W. Va.
 Trustees—M. L. Steinbuck, Box 338, Clifton Forge, Va. D. C. Dowdy, 2048 7th Ave., Huntington, W. Va. John J. Fielding, 1389 Scott St., Covington, Ky.
DISTRICT No. 42—Danville, Ill. Chicago & Eastern Illinois R. R. Meets 1st Tues. in Feb., 1916. Lodges represented: 22, 95, 575.
 G. D. Davis, Pres. and B. A., 18 N. Hazel St., Danville, Ill.
 James B. Keenan, V.-P., 1006 E. Madison St., Danville, Ill.
 Office Henthorn, R. & F. S., 102 Iowa St., Danville, Ill.
 A. Welch, Cor. Sec. & Treas., Villa Grove, Ill.

Subordinate Lodges and Officers

1—CHICAGO, ILL. 2d-4th Wed. Bricklayers' Hall, Monroe and Peoria Sts.
 James McKiernan, Pres.
 John E. Burke, C. & F. S., 3009 Archer Ave.
 John Dohney, 8123 So. Peoria.
 Frank Condon, B. A., 912 Monroe.
 2—ATLANTA, GA. 2d-4th Thurs
 A. D. Lundbon, Pres., 224 E. Fair.
 John Fitcher, C. S., 406 Pულიan.
 3—ST. PAUL MINN. 1st-3d Fri. Odd Fellows' Hall, 5th and Wabash Sts.
 Geo. Cox, Pres., 1746 Logan.
 W. Parranto, C. S., 400 Jenks St.
 4—BIRMINGHAM, ALA. 1st-3d Tues., K. of C. Hall.
 Fred Baker, Pres., 2021½ 3d Ave.
 A. L. Carmack, F. S. & B. A., Office: 335 Hood Bldg.
 5—CLEVELAND, OHIO. 1st-3d Thurs., Room 3, Federation Hall, 310 Prospect.
 Chas. Tongreen, Pres., Superior.
 G. H. Brady, C. S. & B. A., 310 Prospect.
 6—COLUMBUS, O. Meets 2d-4th Thurs., F. of L. Hall.
 Chas. L. Nicklaus, Pres., 473 Poplar Ave.
 Adam Ruckel, C. S., 267 Liebert.
 10—INDIANAPOLIS, IND. 2d-4th Thurs., 114 N. Delaware.
 E. P. Leopard, Pres., 206 N. Tremont Ave.
 Wm. Frohlinger, C. S., 542 East Louisiana St.
 L. E. Hinach, F. S., 851 Ashland Ave.

11—MINNEAPOLIS, MINN. 2d-4th Mon., Richmond Hall, 223 5th St.
 H. P. Farly, Pres., 1356 Vine Place.
 E. A. Conlin, C. S., 2404 Bloomington Ave.
 12—MACON, GA. 2d-4th Friday.
 Morgan's Hall, cor. Elm and Broadway.
 J. T. Fenlon, Pres., 1974 Third St.
 R. J. Black, C. & F. S., 913 2d.
 14—CHATTANOOGA, TENN. Central Labor Hall, 8th and Cherrie Sts., 2d-4th Mon.
 Sam Hartman, Pres., North Chattanooga, Tenn.
 J. F. Anderson, Secy-Treas., 505 Read Ave.
 15—DUBUQUE, IOWA. 1st-3d Tues., Union Hall, 19th and White Sts.
 E. Keck, Pres., 1272 Lincoln Ave.
 R. Ruof, C. & F. S., 975 Clay St.
 16—JERSEY CITY, N. J. 1st-3d Mon., Fischer's Hall, Newark Ave. cor. Erie St.
 Patrick J. Kenneally, Pres., 209 Magnolia Ave.
 Hugh Fitzpatrick, C. S., 244 York.
 Ed. McCarthy, B. A.
 19—PHILADELPHIA, PA. 2d-4th Fridays, Bricklayers' Hall, Broad and Fairmount Ave.
 Frank Goodfellow, Pres., 159 W. Palmer St.
 R. S. Hoppins, C. S., 2426 S. Clarion.

20—JACKSONVILLE, FLA. Meets every Monday, Central Labor Hall, 46½ W. Bay.
 E. A. Clarke, Pres.
 C. S. Ryan, C. & F. S., 508 Lackawana Ave.
 21—NEW YORK, N. Y. 2d-4th Tuesdays.
 John H. Sullivan, Pres., 607 W. 46th St.
 James McGeney, C. S., 352 Schermerhorn St., Brooklyn, N. Y.
 Thomas Broadley, F. S., 519 W. 42d St.
 22—DANVILLE, ILL. 1st-3d Mon., Trades and Labor Hall.
 Ray Schenk, Pres., California St.
 Wm. J. Irwin, C. S., 7 Illinois.
 Frank Jergens, F. S., 418 N. Bowman Ave.
 G. D. Davis, B. A., 18 N. Hazel.
 25—SAN FRANCISCO, CALIF. Roesch Hall, 15th and Mission Sts., 2d-4th Thurs.
 John Kane, Pres., 41 Collingwood.
 Thos. J. Sheridan, C. S. & Treas., 2312 24th St.
 Wm. P. Bowser, B. A., 314 14th.
 26—SAVANNAH, GA. 2d-4th Tues., Board of Trade Bldg.
 J. P. Masey, Pres.
 C. A. Buchheit, C. S., 103 Garden.
 27—ST. LOUIS, MO. 2d-4th Thurs., 10th and Carr.
 Larry Kickham, Pres. & B. A., 5322 Vernon Ave.
 James Callahan, C. S., 3408 Laclede Ave.
 Henry Selkman, F. S., 1942 Benton.

- 29—ROANOKE, VA.** 2d-4th Wed., Labor Home Hall, Commerce and Salem Ave.
G. N. Lucas, Pres., 1121 2d Ave. N. W.
- 30—ROANOKE, VA.** 2d-4th Mon., Labor Hall, cor. Commerce St. and Salem Ave.
C. E. Eades, Pres., 318 7th Ave. N. E.
B. I. Wade, C. S., 811 Jamison Ave.
- 31—ST. JOSEPH, MO.** 2d-4th Mon., Joucker Hall.
B. E. Stitts, Pres., 2228 So. 6th.
Edward Knight, C. S., 2119 So. 9th St.
- 32—KANSAS CITY, MO.** 2d-4th Fri., Labor Temple, 14th and Woodland.
Thomas Mulvihill, Pres., 3715 Springfield St., Rosedale, Kas.
W. E. Dwyer, C. & F. S., 4402 Windsor.
Chas. McDonald, B. A., 4416 Norledge, Kansas City, Mo.
- 37—NEW ORLEANS LA.** 2d-4th Wed., Martin's Hall, Iberville & Exchange Place.
Wm. J. Smith, Pres., 228 Morgan St., Algiers, La.
Lewis J. Costella, C. S. & B. A., 636 N. Olympia.
Victor Escousse, F. S., 617 Alix St., Algiers, La.
- 38—OMAHA, NEB.** 1st-3d Wed., Bairight Hall., 19th & Farnum.
M. J. McGovern, Pres., 1617 Burt.
L. G. Rankin, C. S., 2825 Cass.
J. H. Massman, F. C., 1511 Locust.
- 39—SOUTH CHICAGO, ILL.** 2d-4th Tues., Union Headquarters, 92d St. and Erie Ave., South Chicago.
Frank Bacton, Pres., 10149 Ave. J.
John Coglan, C. S. & B. A., 9944 Ave. H.
Jas. Manners, F. S., 1023 Ave. L.
- 40—LOUISVILLE, KY.** 2d-4th Wed., in Beck's Union Hall, 1st and Jefferson Sts.
Thomas Mitchell, Pres., 1422A Broadway.
R. Terrell, C. S., 308 N. 19th St.
- 41—HARLOWTON, MONT.** 2d-4th Thurs., Winer Hall.
John Dennis, Pres.
Harry Schultz, C. & F. S.
- 42—NASHVILLE, TENN.** 2d-4th Thurs., Carpenters' Hall, 342½ 4th Ave. N.
James B. Keenan, 1006 E. Madison St., Danville, Ill.
H. R. Brown, Pres., 611½ Church.
W. T. Pentecost, C. S., 2143 Oakland Ave.
- 44—PUEBLO, COL.** Every Thurs., Carpenters' Hall, 117½ S. Union Ave.
Walter M. Pitts, Pres., 653 E. 5th St.
Geo. S. Warden, C. & F. S., 1507 E. 7th St.
- 45—BROOKLYN, N. Y.** Greenpoint and Manhattan Aves., 2d-4th Thurs.
Gerald A. Daly, Pres. & C. S., 676 60th St.
M. J. Callahan, F. S., 204 Nassau Ave.
- 46—CHEYENNE, WYO.** Union Hall, 2d-4th Wed.
Geo. R. Wallace, Pres., P. O. Box 151.
E. Cole, C. S., 215 E. 9th St.
- 47—DES MOINES, IA.** 1st-3d Thurs., Trades Assembly Hall.
James Gillespie, Pres., 1113 Columbus Ave.
Fritz Johnson, C. & F. S., 922 W. 1st St.
- 48—LARAMIE, WYO.** 1st-3d Tues., Moose Hall.
Jacob Claus, Pres., 114 Cedar St.
Frank M. Lepper, C. S., 360 N. 3d St.
- 50—CHARLESTON, S. C.** 1st-3d Tues., Y. M. C. A. Hall, George St.
H. J. Hartnett, Pres., 18 Anson St.
John J. Clair, C. & F. S., 196A Spring St.
- 51—ST. LOUIS, MO.** 2d-4th Wed., Lafayette Hall, 17th and Cass Ave.
Frank H. Johannimgmire, Pres., 1923 Sullivan Ave.
Mike Whalen, C. S., 1715 N. 11th St.
Geo. Wheaton, F. S., 4159 Lee Ave.
- 54—FORT WAYNE, IND.** Last Wed., West Berry St.
Edward F. Siebold, Pres. & C. S., 1130 St. Mary's Ave.
O. P. Ewald, F. S., 1419 S. Calhoun.
- 55—NEWPORT NEWS, VA.** Every Wed., 8 p. m. C. L. U. Hall, 32d and Wash. Ave.
Wm. H. Healy, Pres., 3711 Huntington Ave.
D. M. McArthur, C. S., 211 37th.
W. Hannah, F. S., P. O. Box 430.
- 56—VICKSBURG, MISS.** 1st-3d Tues., K. of P. Hall, N. Washington St.
Ed. Snelling, Pres., 3127 Washington St.
W. C. Hughes, C. & F. S., 2812 Mulberry.
- 57—PORTSMOUTH, VA.** 1st-3d Thurs., C. L. U. Hall.
O. C. Hartung, Pres., 1248 Park Ave.
J. H. Parrish, F. S., 622 Clifford.
Geo. Thomas, C. S., 204 Lincoln.
- 60—PEORIA, ILL.** 1st-3d Mon., 411 Cedar St.
Andy Yates, Pres., 1709 S. Adams.
F. Hierspiel, C. S., 410 Warner Ave.
- 61—NEW HAVEN, CONN.** 1st-3d Thurs., Boardman Bldg., cor. State and Chapel Sts.
Wm. Hefferman, Pres., 95 Carlyle.
M. J. Whalen, C. & F. S., 138 Carlyle.
- 64—JACKSON, MICH.** Every Tues., Labor Hall, Main and Jackson Sts.
Geo. Jones, Pres., 140 Bates.
Ed. McNamara, C. S., 619 South Pleasant St.
- 65—VICTORIA, VA.** 2d-4th Sundays, Lunenburg Hall.
J. H. Jones, Pres., Gen. Del.
W. H. Slayton, C. S., Gen. Del.
- 66—LITTLE ROCK, ARK.** 1st-3d Thurs., Brannon Hall., Markham and Cross Sts.
W. J. Flynn, Pres., 908 Denison.
E. Wortsmitth, C. & F. S., 300 W. 11th St., Argenta, Ark.
C. A. McDonald, B. A., 4416 Norledge, Kansas City, Mo.
- 67—BAY CITY, MICH.** 1st-3d Thurs., Central Trades Council Hall.
Wm. H. Benedict, Pres., 703 E. Winona Ave., W. S.
Joe Malton, V. P., 317 E. Jackson.
Nelson Heglung, C. & F. S., 514 Adams St.
- 68—PINE BLUFF, ARK.**—2d-4th Wed., Labor Temple.
A. J. Barton, Pres., 1701 W. 6th.
B. E. Shields, F. S., 1503 E. 7th.
J. A. Smith, C. S., 1908 E. 8th.
- 70—SPRINGFIELD, MO.** 2d-4th Wed., Eagles' Hall, E. Commercial St.
R. A. Lines, Pres., 816 W. Atlantic St.
Scott Daffer, C. & F. S., 987 Broad St.
A. F. Bingham, B. A., 701 Lombard St.
- 72—PORTLAND, ORE.** 2d-4th Thurs., 230½ Yamhill St.
Arthur Gallon, Pres., 649 Milwaukie.
F. E. Disbrow, C. & F. S., 810 E. 11th.
Joe Reed, B. A., 507 Bl^hmark.
- 73—TROY, N. Y.** 2d-4th Mon., Swan and Georgia Sts., Mechanicians' Hall, Huntington Ave.
James Keating, Pres.
A. C. Lacy, C. S., 552 27th St.
- 74—HOUSTON, TEXAS.** 1st-3d Wed., Woodman Hall, 1823 Washington St.
D. C. Bryan, Pres., 4607 Washington.
F. C. Jackson, C. & F. S., 2118 Lublick St.
- 79—GARRETT, IND.** 1st-3d Tues., K. of P. Hall, Randolph.
Geo. Richmond, Pres., 214 E. Keyser.
J. C. Smith, C. & F. S., Box 282.
- 80—ANACONDA, MONT.** 2d-4th Wed., M. & M. Hall, Lodge Box 372.
J. C. Smith, Pres., 510 Cherry St.
James W. Hogan, C. S., 800 Birch.
- 81—SPRINGFIELD, ILL.** 2d-4th Tues., Fortunes Hall.
Ed Sellers, Pres., 130 E. Edwards.
Louis L. Mutter, C. & F. S., 1621 S. 8th.
- 82—OSAWATOMIE, KAS.** 1st-3d Mon., K. & L. Sec. Hall.
Hurb Fader, Pres.
C. A. McDonald, B. A., 4416 Norledge, Kansas City, Mo.
J. E. Sturgess, C. & F. S., Box 64.
- 83—KANSAS CITY, KAS.** 2d-4th Tues., K. P. Hall, 624 Minn. Av.
Thomas Knowles, Pres., 760 Shawnee.
Frank Stover, C. & F. S., 323 Nebraska Ave.
- 84—GRAND RAPIDS, MICH.** 1st-2d Mon., Trade & Labor Hall, 67 Monroe Ave.
Frank C. Lemke, Pres., 551 Shamrock St.
Nelson M. Warren, C. S., 127 E. Delaware St.
- 85—TOLEDO, OHIO.** 2d-4th Tues., Mitchell's Hall, cor. Walnut and Summit Sts.
J. S. Durst, Pres., 153 Gibbons St.
Ellsworth Richardson, C. S., 117 Western St.
- 86—DALLAS, TEX.** 1st-3d Mon., Broadnax Hall.
W. H. Riley, Pres., 1408 Corinth.
C. B. Stout, C. S., R. R. 10, Box 64.
- 88—JACKSON TENN.** 2d-4th Fri., Labor Hall.
B. B. Seward, Pres.
A. E. Barkdale, C. S., 119 E. Orleans St.
- 90—SUGAR CREEK, MO.** 2d-4th Thurs., Woodman's Hall.
L. Novak, Pres.
C. R. Snider, C. & F. S., 1222 W. Electric St., Independence, Mo.
- 91—ELMWOOD PLACE O.** 1st-3d Mon., Kellers Hall.
Geo. Urban, Pres., St. Bernard, O.
John Cullen, C. S., 39 Prosser Ave.
- 92—LOS ANGELES, CAL.** 2d-4th Wed., Union Labor Temple, 540 Maple Ave.
Charles Clarke, Pres., 206 S. Workman St.
H. E. Herman, C. & F. S., 520 S. Griffin Ave.
- 93—JOLIET, ILL.** 2d-4th Tues., Conners' Hall.
John Buckley, Pres., 111 Wiflard Ave.
Richard Farrell F. S., 503 London Ave.
Charles Mork, C. S., 424 Landen Ave.
- 94—SACRAMENTO, CAL.** 1st-3d Thurs., Labor Temple.
J. Grabfelder, Pres., 3001 G St.
J. S. Heller, Acting C. S., 1317 19th St.
- 95—EVANSVILLE, IND.** 2d-4th Mon., Ruhli's Hall.
Chas. T. Mooney, Pres., 1802 Michigan.
Herman H. Grundman, C. & F. S., 307 Mary St.

96—FORT WORTH, TEX. E. of L. F. & E. Hall, 1st-3d Thurs. J. J. Dempsey, Pres., 504 Calhoun. L. A. Freeman, C. & F. S., 2260 Jennings St.

99—NEWARK, OHIO. Druid's Hall, S. 3d St., 1st-3d Sun. Emil Indlekofer, Pres., 68 Curtis Ave. Cecil Roberts, C. & F. S., 45 1/2 S. Third St.

100—MARSHALL, TEX. 1st-3d Tues. I. O. O. F. Hall. Smith Hayden, Pres., 514 Greenwood Ave. J. P. O'Neil, C. & F. S., 708 E. Rusk.

103—SALT LAKE CITY, UTAH. Labor Temple, 3d East, bet. 1st and 2d S. St., 1st-3d Wed. Wm. H. Garrick, Pres., 1446 Edith Ave. B. S. R. Harrison, C. & F. S., 862 Ouray Ave.

104—SEATTLE, WASH. 1st-3d Thurs., Labor Temple, 6th and University St. Fred Counter, Pres., 2360 15th Ave., So. Bud Nash, C. & F. S., 3438 16th Ave., W.

106—CINCINNATI, OHIO. 2d-4th Tues., Workman's Hall, Mercer and Walnut Sts. Chas. Granger, Pres., 329 Union St., Bellevue, Ky. D. L. O'Brien, C. S. & B. A., 23 Forest Ave., Ludlow, Ky. Frank Barrows, F. S., 1028 5th Ave., Dayton, Ky.

106—MCGHEE, ARK. 2d-4th Wed., K. of P. Hall. Wm. E. Crupper, Pres., Box 215. Chas. A. Stewart, C. & F. S., Box 422.

107—MILWAUKEE, WIS. 1st-3d Tues., Speers Hall, Cor. National & 3d Ave. J. Hoppens, Pres., 1302 Frattney. R. Dale, Fin. Sec., 219 4th Ave. P. Sonnenberg, C. S. & B. A., 623 Greenbush.

108—AUGUSTA, GA. 2d-4th Tues., Machinists' Hall, Broad. Patrick Rice, Pres., 1342 Walton Way. E. E. Bennett, C. S., 310 9th St.

109—CHADRON, NEB. J. W. Boyd, Pres. John Paulson, C. & F. S.

111—MISSOULA, MONT. 2d-4th Tues., Eagles' Hall. H. A. Chase, Pres., Box 1304. E. H. Shanks, C. & F. S., 221 N. 2nd.

113—SEDALIA, MO. 1st-3d Tues., Labor Temple. Chas. Hall, Pres., Gen. Del. C. A. McDonald, B. A., 4416 Norledge, Kansas City, Mo. W. H. Sims, C. S., 1306 E. 7th St.

116—BRAINERD, MINN. 2d-4th Fri., Trades and Labor Hall. Henry Voight, Pres., E. Oak. Wm. B. Good, C. S., Imperial Block.

117—DE SOTO, MO. 1st-3d Mon., Federation Hall. R. B. Parks, Pres. S. L. Johnson, C. & F. S., Box 248.

118—NORTH PLATTE, NEB. 4th Sat., K. of P. Hall. John Seth, Pres. Peter McGovern, C. S., 511 Locust.

123—LIVINGSTON, MONT. 1st-3d Thurs., Trades and Labor Hall. C. D. Cain, Pres., 204 S. K St. Theo. W. Evert, C. & F. S., P. O. Box 554.

124—SAGINAW, MICH. 1st-3d Fri., Petre & Meek's Hall, Genesee Ave. John Doyle, C. & F. S., R. F. D. No. 1.

126—WINNIPEG, MAN. 1st Wed. and 2d Sun., 2:30 o'clock, Labor Temple. Charles Davies, Pres., 514 Atlantic Ave.

A. B. Page, C. & F. S., 1380 Elgin Ave.

129—CLINTON, IOWA. H. Quailman, C. S., 231 14th Ave.

130—BUTTE, MONT. 1st-3d Tues., Carpenters' Hall, cor. Granite and Montana Sts. T. F. Shultz, Pres. Harry Goodland, C. & F. S., 177 E. Center.

132—GALVESTON, TEX. 2d Mon., Cooks and Waiters' Hall, 33d St. S. Nawdascher, Pres., 3228 Ave. H. E. T. Chester, C. & F. S., 3209 Ave. I.

133—WATERLOO, IOWA. Central Labor Hall, 2d-4th Wed. E. G. Pullen, Pres., 502 Columbia St. Geo. A. McMillan, C. S., 702 Barclay St.

134—MONTREAL, QUE., CAN. 1st-3d Fri., Monument National. St. Lawrence and Main Sts. Stephen Craig, Pres., 1251 Mosser. R. Chorlton, C. S., 1184 Deirmier Ave.

135—CHILlicothe, O. 1st-3d Mon., Flaecker Hall. L. J. Medert, Pres., 516 E. Water St. James Hunsinger, C. & F. S., 390 E. 4th St.

136—COLORADO CITY, COLO. Red Men's Hall, 1st-3d Fri. H. J. Norton, Pres., care National Hotel. R. D. Wing, C. S., 12 So. 12th, Colorado Springs, Colo. J. H. Cook, F. S., 216 N. 12th.

137—PADUCAH, KY. 2d-4th Sun., Central Labor Hall, 122 1/2 N. 4th. B. C. Beadles, Pres., 1029 Madison.

Wm. Black, C. & F. S., 315 N. 3d St.

138—HARRISON, ARK. H. C. Heppard, Pres. T. T. Chubb, C. S.

140—PEN ARGYL, PA. 2d-4th Mon., Steinmiz's Hall, Bangor, Pa. Joseph Wenninger, Pres. & C. S., care Realty. J. A. Morgan, Fin. Sec., care Alblon House.

143—KNOXVILLE, TENN. 319 N. Gay St., 1st-3d Tues. J. D. Krause, Pres., R. F. D. No. 1. J. C. Wells, C. S., 508 E. 4th Ave. W. D. Amames, F. S., R. F. D. No. 12, Lincoln Park.

144—CEDAR RAPIDS, IOWA. 1st-3d Wed., I. O. O. F. Hall, cor. 1st St. and 2nd Ave. W. Chas. T. Bowman, Pres., 816 Ellis Blvd. Frank C. Schwarz, C. & F. S., 830 G Ave., W.

145—MISSOURI VALLEY, IOWA. 1st-3d Thurs., Walker's Hall. Hans Witt, Pres., Box 181. Harvey Nichols, C. S.

148—VALLEJO, CALIF. 1st-3d Tues., Vallejo Temple Hall. Harry Duthie, C. & F. S., 638 Capitol.

149—MARSHALLTOWN, IOWA. 1st-3d Tues., Trades and Labor Assembly Hall, Main St. Chas. Vvsokial, Pres., 9 E. Boone. W. E. Pouley, C. S., 1110 W. Cole.

150—CHAMPAIGN, ILL. 1st-3d Sun., 2:30 p. m., I. C. System Fed. Hall. Thos. H. Monahan, Pres., 511 W. Washington St. A. E. Strode, C. S., 325 Hickory.

153—GASSAWAY, W. VA. J. E. Perkins, Pres., Gen. Del. R. Lee Boone, C. & F. S., Gen. Del.

154—PITTSBURGH, PA. 1st-3d Fri., Labor Temple, cor. Washington and Webster Ave.

Frank Bann, Pres., 804 South Ave. N. S. Henry J. Thumel, C. & F. S., 1218 Itin St., N. S. James P. Carr, B. A., Labor Temple, Wash. and Webster Ave.

155—BLOOMINGTON, ILL. 2-4 Thurs., Machinists' Hall, West Chestnut St. H. F. Lambrecht, Pres., 1004 N. Livingston St. L. J. Metzner, C. & F. S., 1207 N. Mason.

157—SYRACUSE, N. Y. 1st-3d Wed., Bartenders' Hall, Clinton & W. Genesee St. J. J. Hardny, Pres., 214 Hartson. Thomas Ranger, C. S., 120 Lydell.

161—BOONE, IOWA. 1st-3d Mon., at Electrical Workers' Hall. Frank Whitman, Pres., 1603 Benton.

H. W. Martens, C. & F. S., 1329 Meridan St.

163—HOBOKEN, N. J. 2d-4th Fri., 500 Bloomfield St. Edwin L. Norwood, Pres., 933 Garden St. P. L. Growney, C. S., 1019 Willow Ave.

165—DULUTH, MINN. 2d-4th Sat., Irwin-Sloan Block, 20th Ave. and Superior St. James A. Graham, Pres., 5705 Grand Ave., W. Duluth, Minn. Alfred S. Nelson, C. & F. S., 5705 Grand Ave., W. Duluth, Minn.

169—DETROIT, MICH. 2d-4th Fri., 235 Gardlot Ave. Charles Komes, Pres., 31 Celaren. Chas. F. Aderholdt, C. & F. S., 9 Sylvan St.

170—RICHMOND, VA. 1st-3d Wed., Labor Temple, 5th and Marshall Sts. R. L. King, Pres., 822 N. 26th St. F. C. Blount, F. S., 1101 N. 23d. E. M. Daywalt, C. S., 2208 Venable St.

173—RALEIGH, N. C. B. F. Long, Pres., 218 N. McDowell.

J. P. Taylor, C. & F. S., 615 W. North.

175—OSWEGO, N. Y. 2d-4th Mon., 8 p. m., Forester Hall, E. Bridge St. Wm. Perau, Pres., 90 Hart St. James Gorman, C. S., 54 Murray.

176—ELIZABETH, N. J. 2d-4th Wed., Dahmen Hall, 4th and E. Jersey St. John H. Reynolds, Pres., 33 Delaware St. Samuel M. Rankin, Secy., 64 Florida. E. J. McCarthy, B. A., 67 St. Mark's Place, New York City.

179—DENVER, COLO. 2d-4th Wed., Room 301 McPhee Bldg., 17th and Glenarm. Geo. Gauss, Pres., 3869 Newton. H. Shaffroth, C. & F. S., 3749 Wynkoop St.

180—MEMPHIS, TENN. Italian Hall, 1st-3d Fri. W. T. Funston, Pres., 889 Webster Ave. C. F. Gillenwater, C. S., 140 W. Iowa Ave.

187—MIAMI, ARIZ. Every Tues., Miami Hall. J. W. Landers, Pres. Roy Drummond, C. & F. S., Box 1121.

191—VICTORIA, B. C. 2d-4th Tues., 1424 Government St. A. Clyde, Pres. Sub. P. O. No. 2. A. Stewart, C. S., Box 48, Beaumont, P. O. Esquimalt, B. C.

193—BALTIMORE, MD. Every Tues., Patterson Bldg., Baltimore and Gay Sts. John Shanley, Pres. James Chaney, F. S., 1419 Patapsica St. Philip Wingling, C. S., 410 E. 27th St.

- 194—VANCOUVER, B. C. CANADA.** 1st-3d Mon., at Labor Temple.
F. W. Jurett, Pres., 2140 Bernard St.
A. Fraser, C. S., 1151 Howe St.
- 195—KEWANEE, ILL.** 1st-3d Fri., O'Donnell's Hall, 3d St.
M. J. Carney, C. S., 411 N. 1st St.
- 197—ALBANY, N. Y.** 31 Green St., 2d-4th Sat.
J. H. Sullivan, Pres. & B. A., 173 2d St.
Jno. J. Leamy, C. S., 68 Livingston Ave.
- 198—OGDEN, UTAH.** 2d-3d Tues., Union Labor Hall on 24th St., bet. Washington and Grant.
F. S. Dunn, C. & F. S., 116 23d St.
- 199—HORTON, KAS.** 1st-3d Thurs., Carmen's Hall.
Barney Drew, Pres.
E. S. McGinnis, C. & F. S., Box 622.
- 200—STATEN ISLAND, N. Y.** I. O. G. T. Hall, W. Brighton, S. L. N. Y., 1st-3d Mon.
Richard Hough, Pres., 55 Bay Ave., Pt. Richmond, S. I.
Ethan A. Johnson, C. S., 208 Broadway, W. Brighton S. I., N. Y.
E. McCarty, B. A., 67 St. Mark's Place, N. Y. City.
- 201—WINONA, MINN.** Labor Temple, 1st-3d Tues.
Frank Rice, Pres., 574 W. 7th St.
W. Kukowski, C. S., 176 Mankato Ave.
J. H. Buchholts, F. S., 251 E. King.
- 204—HONOLULU, H. I.** Waverly Hall, 2d-4th Thurs.
Wm. Brown, Pres., Honolulu Iron Works.
Thos. Murrey, C. S., 1541 King.
- 205—SAN FRANCISCO, CALIF.** 2d-4th Tues., Rosch Hall, 15th and Mission.
Wm. P. Bowser, Pres., 507 20th.
J. M. Enright, C. S., 1431 Delores.
Walter Anderson, F. S., 607 Anderson.
Wm. P. Bowser, B. A., 314 14th.
- 206—ALGIERS, LA.** 2d-4th Fri., RENEKY Hall.
Jos. Koenig, Pres. & C. S., 325 Elmira Ave.
C. A. Reynolds, F. S., McDonoghville, La.
- 209—DENISON, TEXAS.** 2d-4th Mon., over State Nat. Bank.
A. McDowell, Pres., 504 W. Owings St.
S. E. Harris, C. & F. S., 923 W. Morgan St.
- 216—EL PASO, TEXAS.** 2d-4th Thurs., Union Labor Hall.
Wm. Beeson, Pres., Gen. Del.
Frank H. Balt, C. S., 114 S. Stanton St.
- 218—SPRINGFIELD, MASS.** 2d-4th Wed., Winkler's Hall, Bridges and Water St.
Michael Fitzgerald, Pres. 843 Caren St.
Wm. E. Donovan B. A., 9 Arbor. Jerb C. Driscoll, C. S., 141 Patton.
- 220—CHICAGO, ILL.** 2d-4th Tues., Pusey's Hall, 901 E. 75th.
M. Casey, Pres., 6351 Drexel Ave.
A. G. Smith, C. & F. S., 7036 Harper Ave.
- 221—PITTSBURG, KAS.** 1st-3d Tues., Red Men's Hall, W. 3d St.
E. E. Hiett, Pres., 1803 N. Grand Ave.
P. J. Hiett, C. S., 1801 N. Grand.
- 222—MART, TEXAS.** W. O. W. Hall.
E. J. Blount, Pres.
G. W. Coates, C. & F. S.
- 223—UTICA, N. Y.** Labor Temple, 2d Fri.
Louis Wengert, Pres., 8 Wiley St.
Edward Wengert, C. S., 43 Fass Ave.
- 225—ELMIRA, N. Y.** 2d-4th Sun., Trades & Labor Hall, 200 E. Water St.
A. E. Stevenson, Pres., 964 McGeo.
N. P. Durmin, R. & C. S., 519 Penn Ave.
- 226—SALISBURY, N. C.** W. O. W. Hall, Innes and Main Sts., 2d-4th Fri.
J. J. Garvey, Pres., E. Spencer, N. C.
P. F. Surratt, C. & F. S., Box 278, Spencer, N. C.
- 227—CHICAGO, ILL.** Garfield Park Hall, 4039 W. Madison St., 2d-4th Sat.
John Seidon, Pres., 1107 Keeler Ave.
Thomas Dean, F. & C. S., 2214 W. 13th St.
- 229—ROCHESTER, N. Y.** 2d-4th Wed., 14 N. Water St.
W. Weston, Pres., 17 Coffrey Place.
Robt. Little, C. S., 211 Garfield.
- 232—OAKLAND, CAL.** 2d-4th Mon., cor. 7th and Peralta Sts.
H. Brown, Pres., 1003 Pine St.
Geo. Young, C. S., 1788 9th St.
- 235—COLUMBIA, S. C.** 2d-4th Tues., Plumbers' Hall, 1623 Main St.
E. R. Fenell, Pres., 1712 Blanding.
J. W. Bankhead, C. & F. S., 1705 Thompson Ave.
- 236—MARQUETTE, MICH.** 4th Thurs., E. Seigle's Hall.
Albert Bastien, Pres., 347 West Washington.
Arthur Bourgois, C. S., 817 North 3d St.
- 237—HARTFORD, CONN.** 2d-4th Wed., at C. L. U. Hall, Central Row.
James Thornton, Pres., 52 Green.
John J. Reilly, C. S., 46 Pliny.
- 238—CLIFTON FORGE, VA.** 1st-3d Fri., Junior Hall.
A. J. Hauer, Pres., 34 Alleghany.
M. L. Steinbuck, C. & R. S., Box 336.
D. G. Clark, F. S., 192 Ridge-way.
- 239—ROCKY MOUNT, N. C.** 1st-3d Mon., Machinist Hall, cor. Sunset and Main Sts.
A. J. Dixon, Pres., 208 Atlantic Ave.
H. M. Myers, C. S., 313 Maderason.
- 241—WASHINGTON, IND.** Zinck's Hall, 3d and Vantrees Sts., 1st-3d Tues.
J. C. Mooney, Pres., East George.
M. W. Luke, C. & F. S., 1097 W. Main.
- 242—SPOKANE, WASH.** 2d-4th Wed., Carpenters' Hall, No. 9 Madison St.
Frank Depender, Pres., 611 E. Indiana Ave.
R. L. Mason, C. S., 218 S. Pittsburg St.
- 244—SIOUX CITY, IOWA.** Labor Temple, 5th St., near Pierce, 3d Wed.
John Ewing, Pres., 103 Alice St.
Robt. O'Hern, C. S., No. 5 14th.
- 245—CONCORD, N. H.** 2d-4th Mon., Central Labor Union Hall.
Geo. Tanner, Pres., Hall St.
J. Berryman, C. S., 143 S. Main.
J. R. New, F. S., 120 Broadway.
- 246—TERRE HAUTE, IND.** Cor. 8th and Wabash Ave., 1st-3d Tues.
H. M. Showalter, Pres., 1410 S. 17th.
Jesse Dukes, C. S., 1561 S. 18th.
F. Wittke, F. S., 1709 N. 12th.
- 247—TACOMA, WASH.** 1st-3d Mon., Odd Fellows' Hall, S. Tacoma.
Andrew Hansen, Pres., 5406 So. Paks St.
Wm. Polzin, C. & F. S., 5814 S. Lawrence St., So. Tacoma, Wash.
- 249—HUNTINGTON, W. VA.** Every Wed., Thompson Bldg., cor. 20th St. and 3d Ave.
J. S. Myers, Pres., 2720 Collis Ave.
Eugene Brennan, C. & F. S., 930 20th St.
D. C. Dowdy, B. A., 2048 7th Ave.
- 250—BOSTON, MASS.** Hollis Hall, 724 Washington St., 1st-3d Fri.
Joseph F. Gilchrist, Pres., 194 W. Brookline.
Jeremiah Murphy, C. S. & B. A., 107 Union Park St.
- 254—CHICAGO HEIGHTS, ILL.** 1st-3d Mon., at Trades & Labor Assembly Hall, West End Ave.
Thomas Hines, Pres., 1656 West End Ave.
Thomas Brooks, C. & F. S., 306 W. 15th Place.
- 256—POTTSVILLE PA.** Wm. Greaff, Pres., 542 E. Market.
W. Smith, C. S., 215 Front, Minersville, Pa.
- 259—LIMA, OHIO.** 2d-4th Thurs., 334 No. Main.
A. C. Thompson, Pres., East Finley.
A. K. Griesheimer, C. S., 329 N. Elizabeth.
Harry Gunn, F. S., 723 West Wayne.
- 265—SMITHVILLE, TEXAS.** 1st-4th Mon.
E. C. Rovillo, Pres.
G. L. Payton, C. S., Box 344.
- 267—MOBERLY, MO.** 2nd and 4th Thurs., Painters' Hall.
J. J. Cadagin, Pres.
F. R. Lee, C. S., 601 Monroe Ave.
- 276—ST. LOUIS, MO.** 2d-4th Fri., N. E. Cor. 11th and Locust.
Herbert Abbey, Pres., 2618 Ann Ave.
Henry Waeckerle, C. S., 2919A Miami.
- Clyde Stevens, F. S., 1914 N. 21st, E. St. Louis, Ill.
- 278—ELKINS, W. VA.** 2d-4th Thurs., Kendall Hall.
Geo. Cade, Pres., 620 Yokem.
C. H. Godwin, C. & F. S., 312 Center St.
- 279—EDMONTON, ALB. CAN.** 1st Mon., Calder, Edmonton.
Wm. J. Fitzmaurice, Pres., Box 2100, of E. D. & B. C. Ry.
James McLean, C. & F. S., 10236 113th St.
- 281—NORWOOD, MASS.** 2d-4th Fri., 724 Washington St., Boston.
Amos Bennett, Pres., 135 Appleton St., Boston, Mass.
Robert Henderson, C. S., 274 Metropolitan Ave., Roslindale, Mass.
- 284—FREEPORT, ILL.** Every 3d Wed. at Blust Hall.
J. W. Daniels, Pres. and C. S., 27 Shawnee St.
- 286—FORT SCOTT, KAS.** 1st-3d Mon., Redmen's Hall, 111 E. Wall St.
J. W. McNow, Pres., 816 Marion Ave.
J. C. Bonestell, C. S., 739 Croford.
- 287—KINGSVILLE, TEXAS.** W. B. Poor, Pres.
E. C. Martin, C. S., Box 162.
- 290—BREMERTON, WASH.** Sam Reardon, Pres.
John Hornby, C. S., Gen. Del.
- 292—PARSONS, KAS.** 2d-4th Tues., Moose Hall.
C. Dudding, Pres., 2229 Crawford St.
E. F. Butler, C. S., 1723 Gabriel.
- 293—SHAWNEE, OKLA.** 2d-4th Mon., Moose Hall.
Ed. S. Pine, Pres., 711 N. Tucker.
A. D. Ross, C. & F. S., 429 N. Park Ave.
- 298—PORTSMOUTH, VA.** C. L. U. Hall, 2d-4th Thur.
M. A. Garris, Pres., 2226 King.
H. W. Jarrett, F. S., 1822 County.
Robt. T. Howe, C. S., 826 4th St.
- 300—WATER VALLEY, MISS. I.** O. O. F. Hall, 1st-3d Thur.
C. H. Baker, Pres. and Treas.

301—CANTON, OHIO. 1st-3d Mon. Switzer Hall, Cherry and 8th Sts.
 Joe Petch, Pres., 1119 5th St., N. E.
 E. J. Gussett, C. & F. S., 1202 McKinley Ave., S. W.
302—MILWAUKEE, WIS. 1st-3d Sat., Lipp's Hall, 3d and Prairie.
 Henry J. Murray, Pres., 113 29th St.
 Hugh Fuller, C. S., 500 34th St.
 John DuBrucy, F. S., 317 1/2 4th Ave.
305—PORT ARTHUR, TEXAS. 2d-4th Tues., Labor Hall.
 C. L. Bragg, Pres., Gen. Del.
 T. O. Riley, C. S. & B. A., Box 833.
 James Rose, F. S., Box 8.
306—EVANSTON, WYO. I. O. O. F. Hall, 1st-3d Wed.
 John T. Whittle, Pres., County Road.
 J. H. Willoughby, C. S., Box 419.
311—SOUTH KAUKAUNA, WIS. 2d-4th Mon., Odd Fellows' Hall.
 Louis Crevler, Pres.
 Chas. Robedeau, C. & R. S., P. O. Box 279.
312—SELMA, ALA. 1st-3d Wed., at R. R. Y. M. C. A.
 J. F. Ryals, Pres.
 W. P. Fawcett, C. S., 1509 Selma.
315—McCOMB, MISS. Central Trade and Labor Hall, 1st-3d Wed., at 7:30.
 R. O. Bean, Pres. & C. S., Box 684.
317—RICHMOND, CALIF. 2d-4th Fri., Barnman's Hall, 19th St.
 Frank Mallinson, Pres., care Randall Hotel.
 Wm. Jones, C. & F. S., Box 634.
318—PITTSBURGH, PA. 1st-3d Mon., Hazlewood Bank Bldg., cor. 2d and Hazlewood.
 W. Mertz, Pres., Path Alley.
 T. A. Hudson, F. S., 310 Johnston Ave.
320—MERIDAN, MISS. B. L. E. Hall, 5th St. and 40th Ave., 1st-3d Thurs.
 J. A. Smitheren, Pres., 511 40th Ave.
 J. E. Alexander, C. & F. S., 3817 7th St.
322—ST. LOUIS, MO. 1st-3d Tues., Reddy Hall, 3100 Chautau.
 John Coots, Pres., 2726 Washington Ave.
 M. Rench, C. S., 4537 Michigan Ave.
323—CHICKASHA, OKLA. 2d-4th Fri., Labor Hall, 4th and Choctaw.
 C. A. Chincholl, Pres., P. O. Box 502.
 W. L. Harkins, C. & F. S., 528 S. 15th.
325—SHREVEPORT, LA. K. of P. Hall, over West End Drug Store, 2d-4th Thurs.
 H. Abbot, Pres., 1542 Luchina Ave.
 H. W. Huff, C. S., 1863 Texas Ave.
332—CUMBERLAND, MD. 1st-3d Wed., Chapel Hill House.
 G. H. Little, Pres., 401 1st St.
 C. J. Deal, C. S., 48 Penn Ave.
334—PRINCETON, IND. 2d-4th Tues., Redmen's Hall.
 Joe Myers, Pres., 1101 S. Race.
 J. E. Clark, C. & F. S., 702 S. Prince.
335—GRAND JUNCTION, COLO. 2d-4th Fri., Eagles' Hall.
 G. R. Stoll, Pres., 337 White.
 E. H. Friend, C. & F. S., 308 Pitkin Ave.
339—SPAWKS, NEV. 2d-4th Wed., Engineers' Hall.
 Wm. Daseler, Pres., P. O. Box 214.
 C. E. Crouch, C. S., P. O. Box 204.

340—HERINGTON, KAS. 1st-3d Sat., I. O. O. F. Hall.
 John Olson, Pres.
 J. E. Anderson, C. S., 303 N. 8th.
341—PHILADELPHIA, PA. 2d-4th Tues., 8 p. m., Labor Headquarters, 232 N. 9th St.
 Wm. J. Boyle, Pres., 208 N. 58th St.
 Chas. Heberly, C. S., 3084 Aramingo Ave.
344—SHEFFIELD, ALA. 1st-3d Wed., at I. O. O. F. Hall, Montgomery Ave.
 W. H. Wilson, Pres., Tuscumbia, Ala.
 Joseph Meyers, C. S., Tuscumbia, Ala.
345—SAN ANTONIO, TEXAS. Trades Council Hall, 3d Thurs.
 P. G. Sunmany, Pres., 221 Josephine.
 E. H. Frick, C. & F. S., 1223 W. Traves Ave.
 Delrympel, B. A., 410 River Ave.
346—TRENTON, MO. 1st-3d Tues., at Cutlip's Hall.
 Walter Mason, Pres., 1728 Lula Ave.
 Geo. W. Singer, C. & F. S., 1801 Maine St.
353—HANNIBAL, MO. Wm. James, Pres., 300 Rock.
 J. J. Sughnee, C. & F. S., 836 Grand Ave.
354—BROOKFIELD, MO. 1st-3d Tues., 212 N. Main St.
 Martin Murphy, Pres., 291 Elm St.
 J. K. Burnham, C. S., 212 W. John St.
355—CONNEAUT, OHIO. 2d-4th Fri., Stationary Eng. Hall, Main St.
 Chas. Ward, Pres., 685 Lakeview Ave.
 E. J. Dickson, F. S., 815 Main.
356—HAMMOND, IND. 3d Wed., Long's Hall, State St.
 Wm. J. Davis, Pres.
 Albert Gragedo, C. S., 647 Calumet Ave.
360—LAFAYETTE, IND. 1st-3d Thurs., Bartenders' Hall, 3d and Ferry Pt.
 Fred R. Amp, Pres., 1601 N. 12th.
 Wm. Peterson, C. S., 426 Tingle Ave.
 James Goldsberry, F. S.
363—EAST ST. LOUIS, ILL. 1st-3d Fri., Barry's Hall, cor. Coll and Ohio.
 John Roach, Pres., 614 Ohio.
 C. Stevens, C. S., 1914 N. 21st.
364—COVINGTON, KY. 1st-3d Mon., Heidels' Hall, N. W. cor. 21st and Russell Sts.
 Herman Dedden, Pres., 19th and Euclid Ave.
 R. F. Powers, C. S., 2011 Pearl St.
367—HAVRE, MONT. 3d Sat., Oxford Hall.
 Kyle Cope, Pres., 1428 3rd St.
 Elmer Burns, C. S., 1037 2nd St.
369—ALEXANDRIA, VA. 1st Thur. in month during summer months, 108 N. Patrick St.
 James Moran, Pres., 1219 Duke.
 M. Gemeny, R. & F. S., 1514 King.
371—LOWELL, MASS. 1st-3d Sat.
 James Lanigan, Pres.
 J. J. Cunningham, C. S., 656 Gornham.
377—MOLINE, ILL. 1st-3d Fri., Moline Industrial Home, cor. 14th St. and 5th Ave.
 Carl Robison, Pres., 7th St., Silvis, Ill.
 John Fulton, F. S., 7th St., Silvis, Ill.
 Charles McGowan, B. A., 7th St., Silvis, Ill.
 C. R. Kizer, C. S., Box 581, Silvis, Ill.
 Walter S. Schneider, B. A., 1317 25th St., Rock Island, Ill.

378—MONCTON, N. B., CAN. 2d-4th Fri., Sons of Temperance Hall.
 Alex McDougall, Pres., 143 High St.
 R. D. Donnelly, C. S., 69 Downing St.
379—McADAM JUNCTION, N. B., CAN. 2d-4th Fri., Orange Hall.
 Geo. Guest, Pres.
 A. J. McLaggan, C. S.
381—AMARILLO, TEXAS. 1007 Buchanan.
 M. L. Parker, Pres., Box 407.
 Joe Wilson, C. S., 1007 Buchanan.
382—CHILDRESS, TEXAS. 2d-4th Fri., at 7:30 p. m., in Labor Temple.
 Mack Leopold, Pres., P. O. Box 825.
 J. M. Neal, C. S.
384—PEBU, IND. 2d-4th Tues., Labor Trades Hall.
 Floyd W. Seitz, Pres., 164 N. Lafayette.
 W. H. Hawkins, F. & C. S., 404 W. 12th St.
 Frank Sullivan, B. A., 133 W. 3d.
388—MECHANICVILLE, N. Y. 2d and last Tues., A. O. H. Hall, North Main St.
 James S. Kennedy, Pres., S. Second Ave.
 W. A. Saunders, C. S., Saratoga St.
 Chas. Chapman, F. S., Broadway.
390—TRINIDAD, COLO. 2d-4th Wed., Labor Union Hall, East Main St.
 W. T. Flynn, Pres., Arizona Ave.
 A. A. Loftus, F. & C. S., 107 Goddard St.
391—DAVENPORT, IOWA. 2d-4th Fri., Danish Hall.
 John Schach, Pres., 516 1/2 W. 3d.
 R. F. Stewart, C. S., 616 Tremont Ave.
 W. C. Richards, F. S., 1938 Bridge Ave.
392—CALGARY, ALBERTA, CAN. 3d Sat., 2:30 p. m., Labor Temple.
 J. Chambers, Pres., Ogden, P. O. F. Adams, C. S., Ogden, P. O. Alb.
392—GOODLAND, KAS. 1st-3d Tues., Calvert & Sparks' Law Office.
 John McPeak, Pres.
 John Maher, C. & F. S.
393—NORTH FOND DU LAC, WIS. 1st-3d Fri., Trades and Labor Hall, cor. 3d and Main.
 Elmer Shields, Pres., 109 Wible St.
 Wm. Ford, C. S., 536 Main Ave.
396—NORWICH, N. Y. 4th Wed. in Cook Block.
 James E. Callahan, Pres., 1 Columbia St.
 Julius Schraft, C. & F. S., 13 Davis.
398—RIVIERE DU LOUP, QUEBEC, CANADA. Rioux Hall.
 Pierre Loperriere, Pres., Blais Ville.
 Ludger Oullet, C. & F. S., Blais Ville.
400—MIDDLETON, N. Y. 1st-3d Fri., Odd Fellows' Hall.
 Wm. Springer, Pres., 55 Beattie Ave.
 Wm. E. Appel, F. S., 378 North.
 W. S. Seeley, 7 1/2 Sprout St.
402—PORTSMOUTH, OHIO. 2d-4th Fri., C. L. U. Hall.
 Fred Miller, Pres., cor. Robinson and Summit St.
 Edward Snyder, C. S., 2113 17th St.
403—HOISINGTON, KAS. I. O. O. F. Hall, 1st-3d Mon.
 Ray Bowler, Pres., P. O. Box 72.
 C. W. Cramer, C. & F. S., Box 494.
405—BLUEFIELD, W. VA. 1st-3d Fri., Masonic Temple.
 E. K. Collins, Pres., Princeton Ave. E.
 W. F. Dupree, C. & F. S., Gen. Del.

- 400—VAN WERT, OHIO. 3d Thurs., Suite 226 Home Guard Bldg.
E. K. Murlin, Pres., 208 N. Race.
- 410—SAN FRANCISCO, CAL. 2d-4th Wed., Polita Hall, 3265 16th St.
Ed Hanny, Pres., 2217 Howard.
- 413—ST. THOMAS, ONTARIO, CAN. 2d-4th Tues., Machinists' Hall, Talbot St.
Frederick Brooks, Pres., 5 Maama St.
- Frank Roberts, C. S., 61 Wilson Ave.
- 414—ONEONTA, N. Y. 1st Wed. and 3rd Sun., 2:30 p. m., Redmen's Hall.
James Walsh, Pres., 51 Church.
David Lawrie, C. & F. S., 73 W. Broadway.
- 415—JACKSONVILLE, ILL. F. McKenna, C. S., 475 E. State.
- 417—NORTH BAY, ONT., CAN. 2d-4th Mon., L. O. L. Hall
A. E. Lye, Pres., Box 799.
Frank Crotcher, C. S., Box 1773.
- 418—NEODESHA, KAS. 1st-3d Sat., Baldwin Hall.
Chas. Brown, Pres.
E. F. Reddick, C. S., Box 775.
A. F. Bingham, B. A.
- 419—SOMERSET, KY. 1st-3d Tues., at Owen's Hall.
Peter Letter, Pres., Sta. A.
J. A. Schofield, C. & F. S., Sta. A.
- 421—HAMILTON, ONT. 1st-3d Fri., Labor Hall, John St. So.
L. Lawton, Pres., No. 21 Tuckett.
F. Honison, C. & F. S., 6 Bristol.
- 422—SANFORD, FLA. 2d-4th Wed., Eagles' Hall.
H. B. Purden, Pres.
J. H. Shuman, C. S., 115 W. 9th.
- 423—BIG SPRINGS, TEX. 2d-4th Tues., I. O. O. F. Hall.
D. D. Crawford, Pres., cor. Gregg and 3d.
W. P. Warren, C. & F. S., 201 W. 1st.
- 424—FLORENCE, S. C. 2d Thurs., Y. M. C. A.
L. H. Mims, Pres., 222 Covington St.
A. H. Dickman, C. & F. S., 609 Day St.
- 425—WAYCROSS, GA. 1st-3d Thurs., Loot Hitch Bldg.
C. M. Schultz, Pres., 37 Stephens Ave.
L. J. Flohr, C. & F. S., Box 236.
- 427—SALIDA, COLO. 2d-4th Thurs., Adilas Hall.
H. F. Jones, Pres., 135 E. Sacket Ave.
Wm. Dargavel, C. S., 821 E. St.
- 428—NORFOLK, VA. 2d-4th Wed., Pythian Castle Hall.
W. M. Wood, Pres., 617 Liberty St., Berkely, Va.
Thos. Callahan, C. & F. S., 116 Middleton St., Berkeley, Va.
- 430—CAPE GIRARDEAU, MO. 1st-3d Tues., Haas' Hall.
Geo. Stanley, Pres., 223 Frederick St.
Oscar O. Berry, F. S., 415 S. Frederick St.
- 431—BOSTON, MASS. 2d Thurs., Naomi Hall, 724 Washington.
Thos. R. Keenan, C. S., 80 W. 5th St., So. Boston.
- 434—CHICAGO, ILL. 2d-4th Wed., Boulevard Hall, 55th and Halstead Sts.
H. Fischer, Pres., 6507 Sangamon.
L. M. Craft, C. S., 715 E. 48th.
- 435—BRISTOL, TENN. 2d-4th Fri., Sixth and Shelby Sts.
M. C. Cooper, Pres., V. & S. W. Ry. Shops.
J. B. Wood, C. & F. S., 27 Lancaster St., Bristol, Va.
- 436—COLUMBUS, GA. 1st-3d Fri., Trades and Labor Assembly Hall.
R. S. Barry, Pres., 911 4th Ave.
- E. W. McMichael, C. & F. S., 411 10th St.
- 437—TWO HARBORS, MINN. 2d and last Thurs., Iron Dock Grove Hall.
Christ. Anderson, Pres.
Charles Larson, C. & F. S., Box 298.
- 438—GALETON, PA. 2d-4th Tues., Eagles' Hall.
Daniel B. Shine, C. S., 20 First St.
- 439—FAIRBURY, NEB. 4th Wed., K. of L. S. Hall.
B. Z. Milliken, C. & F. S., P. O. Box 167.
Fred Kurst, B. A.
- 440—BELLE PLAINE, IOWA. 2d-4th Mon., Fireman's Hall.
Charles Corns, Pres., 10th St.
Warren Wheeler, C. S., P. O. Box 605.
- 442—NEW ORLEANS, LA. 3d Tues., 1112 Drayder St.
James Miller, Pres., 1204 Franklin.
John Mocklin, C. & R. S., 606 S. Telemachus St.
- 444—CONNELSVILLE, PA. J. W. Easley, C. S., 517 N. Pgh.
- 446—ALAMOSA, COLO. 2d-4th Wed., Trades Assembly Hall.
Albert Jacobson, Pres.
Chas. F. Darling, C. S., Box 64.
- 447—DECATUR, ILL. 1st-3d Tues., Ashley Hall, Mason Temple.
Jas. Gray, Pres., 817 N. Broadway.
Chas. J. Younger, C. & F. S., 432 E. King St.
- 448—MONTGOMERY, ALA. 1st-3d Wed., Young's Hall.
J. E. Johnson, Pres., 89 Morgan Ave.
- E. J. Ford, C. S., 75 Morgan Ave.
- 449—SAPULPA, OKLA. 2d-4th Mon., Moose Hall.
M. E. Lange, Pres., 913 E. Hobson.
F. I. Shipman, C. & F. S., Gen. Del.
- 450—WASHINGTON, D. C. 2d-4th Wed., Weiler's Hall, 8th & I St., S. E.
S. Kelchner, Pres., 1020 B. St., S. E.
- W. F. Kilroy, C. S., 11 I St., N. E.
- 451—WINNIPEG, MAN., CAN. 2d-4th Fri., Labor Temple.
D. Nelson, Pres., 322 Morley Ave.
F. Snare, C. & F. S., 263 Bradford St., St. James.
- 453—COPPERHILL, TENN. 1st-3d Tues., I. O. O. F. Hall.
Chas. Frenz, Pres., Box 711.
E. N. Hall, C. S., Box 382.
- 454—CHICAGO, ILL. 2d-4th Thurs., Persey Hall.
Walter Love, Pres., 752 E. 69th St.
E. R. Dettmer, C. S., 9245 Stoney Island Ave.
- 458—SHERMAN, TEXAS. 2d-4th Thurs., Fulton Hall.
C. S. Hanshey, Pres., Old Phone 893.
John W. Plexco, C. S., 424 S. Gribble.
- 463—BALBOA, CANAL ZONE, PANAMA. Empire Lodge Hall, 2d-4th Fri.
Alex McKenzie, Pres.
W. H. Keenan, C. & F. S., Box 26, Culebra, C. Z.
- 464—PALESTINE, TEXAS. Labor Temple, 2d-4th Wed.
Phil Lyser, Pres., 111 Irwin.
J. D. Mallette, C. & F. S., 503 La.
- 466—REVELSTOKE, B. C. 3rd Sat., Selkirk Hall.
M. M. Keller, Pres., Box 138.
A. Harris, C. & F. S., Box 138.
- 467—PORTSMOUTH, N. H. 2d John Quinn, Pres., Court St.
Alfred Olson, C. S., Box 37, Kittery, Me.
- 469—TERRELL, TEXAS. 2d-4th Fri., Trades and Labor Hall, 202 E. Moore Ave.
J. R. Poston, Pres., 608 E. College St.
R. E. O'Reilly, C. S., 906 E. Moore Ave.
- 471—CRISTOBAL, C. Z. 2d-4th Thurs., New Lodge Hall.
J. Z. Knapp, Pres.
V. Z. McMullen, C. & F. S.
- 473—HELPER, UTAH. 1st-3d Wed., K. of P. Hall.
Wm. R. Welsh, Pres.
R. W. Smith, C. & F. S., Box 411.
- 475—GRAND ISLAND, NEB. 1st-3d Mon., City Hall, 2d St.
H. W. Hunt, Pres.
Sherman Aldrich, F. S., 1014 E. 4th St.
- 476—DALHART, TEXAS. 1st-3d Sat., each month.
A. W. Williams, Pres.
- 478—MOOSE JAW, SASKATCHEW. Wm. Gilles, Pres., 47 Home, W. Geo. Walters, C. S., 30 Duffield.
- EWAN, CANADA. 2d-4th Mon. Trades and Labor Hall, Main St.
- 479—DEVIL'S LAKE, N. DAK. 1st Fri., Opera House Hall.
J. A. Thompson, Pres., Box 324.
Andrew Ruthford, C. & F. S., 714 Fillet Ave.
- 481—LYNDONVILLE, VT. 1st-3d Wed., Eaton's Hall.
B. A. Hinds, Pres.
E. A. Phillips, C. & R. S., Box 121, Lyndon Center, Vt.
J. M. Breason, B. A.
- 483—ALTON, ILL. Schwartzbeck Hall, 3d and Ridge. 1st-3d Tues.
Fred Emmel, Pres., 1410 E. 3rd St.
Robt. Dale, C. S., 3008 Edwards.
- 485—GREEN BAY, WIS. 1st-3d Thurs.
John Christianson, Pres., 822 S. Maple Ave.
John Slater, C. & F. S., 425 5th St.
J. L. Callahan, B. A., 3606 Clifton Ave., Milwaukee, Wis.
- 486—TYLER, TEXAS. 1st-3d Wed., K. O. T. M. Hall.
J. A. Fuller, Pres., 1116 Irvin.
J. M. McCarty, C. & F. S., 221 Center St.
C. R. Welch, B. A., 1428 N. Fannie Ave.
- 489—SEATTLE, WASH. 3d Wed. J. R. Martin, C. S., The Broadway, Yeslerway.
- 491—VALLEY JUNCTION, IOWA. 1st-3d Tues., I. O. O. F. Hall.
Frank S. Hoppe, Pres.
J. C. Carroll, C. S., Box 165.
Geo. W. Pring, B. A., Treas.
- 492—WORCESTER, MASS. 1st-3d Thur., Foresters' Hall.
Patrick I. Curran, Pres., 4 Wilson.
John Casey, C. S., 61 E. Central.
- 493—NEW CASTLE, PA. Jan. 13, 1915, and every other Wed., Trades Assembly Hall.
D. E. Sturdevant, Pres., 516 Waldo.
E. A. Horchler, C. & F. S., 906 E. Washington.
- 495—HATTIESBURG, MISS. 1st-3d Tues., 500 Boule St.
C. W. LeBlanc, Pres., 107 Evans.
A. H. Waddell, C. & F. S., 500 Boule.
- 496—HURON, SOUTH DAKOTA. 2d Sun. and 4th Fri., Labor Hall.
Peter Paluszak, Pres.
C. Storkson, C. & F. S., 228 Beach St.

- 500—EVERETT, WASH. 2d-4th Tues., Labor Temple, 3506 Everett Ave.
Wm. Faulke, Pres., 3506½ Everett Ave.
Bert Bloomington, C. S., 3523 Smith Ave.
- 501—WACO, TEXAS. 2d-4th Fri., Labor Hall.
Chas. Bullock, Pres., R. F. D. No. 2.
Wm. Dickerson, C. & F. S., 810 Cleveland St.
- 502—TEAGUE, TEXAS. 1st-3d Mon., Davis Hall.
Thos. McGrath, Pres., Box 244.
A. B. Campbell, C. S.
- 503—FITZGERALD, GA. 1st-3d Wed., I. O. O. F. Hall.
M. J. Mauns, Pres., P. O. Box 486.
A. B. Campbell, C. S.
- 504—MUSKOGEE, OKLA. 1st-3d Wed., Carpenters' Hall.
Thos. Graham, Pres., 233 S. C. Wm. Sohner, C. S., 616 N. F. St.
- 505—FORT WILLIAM, ONTARIO, CAN. 1st-3d Fri., Electricians' Hall, Murphy Block, Simpson Ave.
Isaac Hunter, Pres., 213 Frederica St.
A. Cruickshank, C. S., 1007 Minn. Ave.
- 507—ATCHISON, KAS. 1st-3d Mon., Fireman's Hall, 1521 Main St.
J. F. Coyle, Pres., 1418 Kansas Ave.
John J. Freibott, C. & F. S., 1420 Kansas Ave.
- 509—JACKSON, OHIO. 2d-4th Mon., Hibernian Hall.
O. B. Reynolds, Pres., 77 High St.
Albert Edmonds, C. S., 77 Hunt St.
J. B. Fillinger, B. A. and Journal Cor., 53 Main St.
- 510—CEDARTOWN, GA. E. M. Kendricks, Pres.
I. C. Smith, C. S.
- 511—WHISTLER, ALA. 1st-3d Mon., I. O. O. F. Hall.
J. L. Scholls, Pres.
C. C. Crona, C. S.
- 515—EAST CAMBRIDGE, MASS. Engineers' Hall, 164 Canal St., Boston, Mass. 1st-3d Fri.
Geo. A. Mitchell, Pres., 39 S. Russell St., Boston, Mass.
Joseph Irwin, C. & F. S., 36 Glendale St., Everett, Mass.
- 517—GREENFIELD, MASS. 2d-4th Sat., Forester Hall.
Patrick Kelley, Pres., 3 Devens.
Tirm Scannell, C. & F. S., 6 Russell St.
- 518—WICHITA, KAS. 1st-3d Thurs., 216 N. Main St.
Roy Connors, Pres., 1440 S. Market St.
Oscar Mase, C. S., 1933 W. Lincoln.
- 520—MILES CITY, MONT. 2d-4th Mon., I. O. O. F. Hall.
P. J. Gallagher, Pres., 302 N. Lake St.
Chas. E. Cook, C. & F. S., 725 Phillips St.
- 521—VAN BUREN, ARK. 1st-3d Thurs., W. O. W. Hall.
Charles Puthast, Pres.
C. A. McDonald, B. A., 4416 Norledge, Kansas City, Mo.
Otto Pyles, C. S., Box 343.
- 522—EL RENO, OKLA. 1st-3d Tues., Redmen's Hall.
H. E. Hart, Pres., Box 624.
H. A. Mathews, C. & F. S., Box 12.
- 523—PRATT, KAS. 2d-4th Tues., at S. T. Sample's residence.
Frank Stephens, Pres., 624 N. Nimescale.
Lox Logan, C. S., 607 N. Jackson.
- 524—MURPHYSBORO, ILL. 2d-4th Wed., Machinists' Hall, 107 S. 10th.
A. R. McFarland, Pres., 638 N. 8th.
E. P. Herin, C. & F. S., 2107 Wall.
- 525—HINTON, W. VA. 1st-3d Mon., Big Four Bldg.
W. L. Taylor, Pres., 108 Grace St.
C. L. Barnette, C. & F. S. & B. A., 419 Summer Ave.
- 528—DEER LODGE, MONT. 2d-4th Fri., I. O. O. F. Hall.
T. J. Messing, Pres.
J. H. Thomas, C. & F. S., P. O. Box 877.
- 529—TRANSCONA, MAN., CAN. 1st Sun., Campbell Hall, Transcona, 3rd Sun., Labor Temple, Winnipeg, 3 P. M.
A. Orr, Pres., 3 Gallagher Ave., Brooklands, Man., Can.
Robt. Clark, C. & F. S., Box 282.
- 530—SPRINGFIELD, MO. 3d Mon., Dengeldem's Hall.
J. W. Reddick, Pres., 817 Lincoln.
John Cain, C. & F. S., 507 Fort.
A. F. Bingham, B. A., 701 Lombard St.
- 531—CHAFFEE, MO. 1st-3d Thurs., City Hall.
T. C. Davis, Pres.
C. E. Bourion, C. & F. S., Box 365.
- 537—COVINGTON, KY. 2d-4th Fri., Workman Hall, 123 Pike St.
John J. Fielding, Pres., 1389 Scott St.
J. J. Fielding, B. A., 1389 Scott.
- 541—BEDFORD, IND. 2d-4th Thurs., Labor Union Hall.
Dan J. Kane, Pres., 511 N. I St.
Chas. J. Bordenet, C. S., 623 N. I St.
- 542—COFFEYVILLE, KAS. Labor Temple, 2d-4th Wed.
R. M. Jones, Pres., 307 W. 14th.
J. C. Morrow, C. & F. S., 613 W. 4th St.
- 543—WICHITA, KAS. 316 N. Main St., 2d-4th Mon.
E. C. Hadler, Pres., 358 Lulu Ave.
C. E. Grove, C. & F. S., 701 W. Central.
- 546—MONETT, MO. 1st-3d Tues., K. C. Hall.
David Elder, Pres., 406 9th St.
John Linebarger, C. & F. S., 214 Pearl St.
- 547—CARBONDALE, PA. Pugh-anas Hall, 2d-4th Fri.
E. T. Dickenson, Pres., 142 Wyoming.
James A. Flannery, C. & F. S., Box 185.
Wilkes Barre Representative, T. J. Cavan, 60 Chester St., Wilkes Barre, Pa.
- 548—TORONTO, CAN. 2d-4th Wed., Labor Temple, Church Jas. Dobson, Pres., 280 Perth Ave.
W. H. Watson, C. S., 162 Annette St.
- 549—MIDDLEPORT, O. 1st-3d Tues., Firemen's Hall.
Lester Cunningham, Pres.
Perry Cooper, C. & F. S.
- 551—PRINCETON, W. VA. Castle Hall, 1st-3d Thurs.
J. J. Bower, Pres., 576 Bluefield.
J. H. Blackwell, C. S., Box 312.
- 553—LA GRANGE, ORE. Wm. Andis, Pres., 1506 V Ave.
Jas. H. Gutridge, C. S., Box 197.
- 556—OKLAHOMA CITY, OKLA. C. S. Cochran, Pres., 406 W. Frisco.
E. F. Ryan, C. & F. S., 400 West Frisco.
- 557—WILLIAMSON, W. VA. 2d-3d Tues., 3d Ave.
Bert Williams, Pres.
H. W. Bias, C. & F. S., 124 Oak.
- 565—FALLS CITY, NEB. 1st-3d Thurs., W. O. W. Hall.
C. W. Jonas, Pres.
E. Woodington, C. & F. S., 710 E. 16th St.
- 567—SAN ANGELO, TEX. 1st-3d Wed., Eagles' Hall.
O. M. Seay, Pres., 821 W. Ave. I.
R. L. Wright, C. S., 27 West Ave. I.
- 568—TACOMA, WASH. Maccabee Hall, 1109½ C St., 2d-4th Thurs.
Chas. Manning, Pres., 5808 S. Lawrence St.
A. W. Rickett, C. & F. S., 920 So. 9th.
- 570—HIGH SPRINGS, FLA. H. A. Smith, Pres., P. O. Box 273.
F. C. Magerstaadt, C. S.
- 571—DE PERE, WIS. De Both Hall, 1st Sun.-3d Wed.
T. J. McDonald, Pres., Lock Box 4, W. De Pere, Wis.
A. E. Steinfeldt, R. S., P. O. Box 207.
- 573—LANSFORD, PA. Wm. J. Williams, C. S., 843 East Ridge St.
- 575—VILLA GROVE, ILL. 1st-3d Fri., Red Men's Hall.
Geo. W. Burnett, Pres.
A. Welch, C. & F. S., Box 152.
H. A. Downes, F. S.
- 576—WICHITA FALLS, TEX. 2d-4th Thurs., Labor Hall.
J. H. Gibson, Pres., 309 Lee St.
C. K. Matthews, C. & F. S., Box 760.
C. H. Shoemaker, B. A., Box 18, Healdton, Okla.
- 577—CUMBERLAND, MD. 1st-3d Thurs., Trades Council Hall.
E. H. Steahley, Pres., 403 Mechanic.
C. E. Dowlan, C. & F. S., 15 Emily.
- 578—HAGERSTOWN, MD. Moose Hall, 2d-4th Thurs.
L. J. Murray, Pres., 25 Vine St.
Fred H. Stouffer, C. S., 817 Summit Ave.
- 579—KEYSER, W. VA. 1st-3d Tues., City Building.
W. H. Wolf, Pres., Gilmore St.
P. R. Dougan, F. S., Gilmore St.
Joseph F. Hines, C. S., Piedmont, W. Va.
- 581—MONTPELIER, O. 1st-3d Wed., Ry. Trainmen's Hall.
S. Brown, Pres.
J. Bermingham, C. S.
- 582—EATON ROUGE, LA. 2d-4th Thurs., Odd Fellows' Hall, 3d St.
W. P. Kidd, Pres., 302 St. Phillip St.
S. V. Acosta, C. & F. S., 318 St. Ferdinand St.
- 583—NEVADA, MO. Socialist Hall, Hall, So. Main St., 1st-3d Thurs.
A. C. LeQuellec, Pres., 520 E. Cherry.
L. E. Whitehead, C. & F. S., R. F. D. No. 1.
C. A. McDonald, B. A., 4416 Norledge, K. C., Mo.
- 584—LUDLOW, KY. 1st-3d Thurs. Morley Hall.
Thos. Jackson, Pres., 17 Pherry.
H. J. Stroer, C. S., 333 Main, Covington, Ky.
- 585—BOSTON, MASS. 1st Thurs., 3 p. m., and 3d Sun., 2:30, Hemstead Hall, 724 Washington St.
Wm. E. McNabb, Pres., 263 Chelsea, E. Boston, Mass.
Daniel B. McInnes, C. S., 288 Marginal Ave., E. Boston, Mass.
Daniel N. Generson, B. A., 17 Bul-lard, Dorchester, Mass.
James Vincent, F. S., 615 E. 6th, So. Boston, Mass.

- 586—SLATER, MO.** 2d-4th Mon., I. O. O. F. Hall.
Chas. Crawford, Pres.
Andy Phelps, C. & F. S.
- 587—BEAUMONT, TEX.** 2d-4th Thurs., Trades Assembly Hall,
O. H. Greer, Pres., Box 149.
T. C. Maddy, F. & C. S., 229 Ful-ton.
M. J. Ickles, B. A., 249 College.
- 588—CHICAGO, ILL.** 2d-4th Tues., Koop's Hall, California & North Ave.
Thomas Godfrey, Pres., 930 E. 44th St.
John McNaney, C. & F. S., 2613 Iowa St.
- 589—MILWAUKEE, WIS.** 2d-4th Thurs., 923 E. Water St.
Frank Thinnex, Pres., 729 5th.
M. J. Gleason, C. & F. S., 202 Michigan St.
- 590—MONROE, LA.** 1st Fri., 615 A St.
J. W. Grant, Pres., 501 Wood St.
J. J. Devereux, C. & F. S., 615 Calypso St.
- 591—GLENDDIVE, MONT.** 2d-4th Fri., Noderhoff Hall.
V. E. O'Connor, Pres. & C. S., 317 Valentine St.
J. J. Shinault, F. S., Gen. Del.
- 592—TULSA, OKLA.** 2d-4th Sat. 214½ S. Main.
- John Ingram, Pres., Gen. Del., Sand Springs, Okla.
Wm. Carey, C. & F. S., Reeder Bldg.
- 594—STANBURY, MO.** 2d-4th Tues., K. of P. Hall.
John Inman, Pres.
E. W. McNew, C. S.
- 595—AVERY, IDAHO.** 2d-4th Mon., Godfrey's Home, West Avery.
A. Anderson, C. & F. S., Gen. Del.
- 596—CASPER, WYO.** 2d-4th Mon. E. F. Holliday, Pres.
A. Doornbos, C. & F. S., Box 272.
- 597—ESCANABA, MICH.** 1st-3d Thurs., Lemmer Hall, Ludington St.
Jos. Vickers, Pres., 506 Wells Ave.
Wm. Grosnich, C. & F. S., 714 Wells Ave.
- 598—SALAMANCA, N. Y.** 1st-3d Mon., 3 Maple St.
A. G. Frey, Pres., 165 E. State St.
D. J. Carpenter, C. & F. S., 3 Maple St.
- 599—PARAGOULD, ARK.** 1st-3d Thurs., Carpenters' Hall.
J. W. Frey, Pres., 321 S. 2d St.
P. L. Houston, C. & F. S., 759 N. 2nd.
C. A. McDonald, B. A., 4416 Nor-ledge, Kansas City, Mo.
- 600—AKRON, OHIO.** Walsh Bldg.
Jas. Shaughnessy, Pres., 876 Sa Main St.
R. C. Price, C. & F. S., 150 Ad-ams St.
- 601—QUEBEC, CAN.**
J. Thompson, Pres., 130 3d St., Simolion.
G. Dery, C. S., 153 4th St., Li-morlow, Can.
- 602—GREAT FALLS, MONT.** 1st-3d Tues., Judge Safford's Court Room.
Frank Yelocan, Pres., 1500 8th Ave. N.
Roy J. Preston, C. & F. S., 706 8th Ave. So.
- 603—OTHELLO, WASH.** 1st-3d Mon., I. O. O. F. Hall.
O. W. Bohusock, Pres.
W. O. Clark, C. S., Box 137.
- 604—JOLIETTE, QUE., CAN.**
H. Fournier, Pres., Gen. Del.
W. C. Williams, C. & F. S., Box 238.
- 605—TOOELE, UTAH.** 2d-4th Thurs., Fraternal Hall.
W. B. Sullivan, Pres.
C. E. Meyers, C. & F. S., P. O. Box 124.
- 606—MOORBRIDGE, S. D.** 1st-3d Thurs., Moose Hall.
J. P. Schmickrath, Pres., Box 721.
H. L. Adams, C. & F. S., Box 166.

International Officers of the Ladies' Auxiliary

- MRS. J. W. EDWARDS**.....President
1234 S. 9th East St., Salt Lake City, Utah.
- MRS. F. R. REINEMEYER**....1st Vice-President
Tauroomee Ave., Kansas City, Kans.
- MRS. MOLLIE GEARY**.....2nd Vice-President
6428 S. Albany St., Chicago, Ill.
- MRS. A. F. BINGHAM**.....Secretary-Treasurer
701 Lombard St., Springfield, Mo.

L. A. 5—SALT LAKE CITY, UTAH.

- Mrs. J. W. Edwards, Pres. & C. S., 928 W. South Temple St.
Mrs. Lydia Smithen, V.-Pres., 360 West 1 South St.
Mrs. J. C. Walton, F. S.
Mrs. Jane Foreman, Treas.
Mrs. Morton, R. S., 116 Markham.

L. A. 7—SUNFLOWER, Parsons, Kas. 2d-4th Tues. aft., Kennedy Hall.

- Mrs. Lillian Dudding, Pres., 2229 Crawford Ave.
Mrs. Alice Leach, Vice-Pres.
Mrs. Zita Rever, Treas.
Mrs. Lula VanVleck, C. & R. S., 2701 Clark Ave.
Mrs. Ethel Smith, Fin. Sec., 2227 Wash. Ave.
Mrs. Mary Carver, Chaplain.
Mrs. Marlon Butler, Marshall.
Mrs. Ida Cornany, Conductress.
Mrs. Kate McMullen, In. Guard.
Mrs. Emma Pilkington, O. Guard.

L. A. 8—FRANKLIN, McComb, Miss., Ladies' Aux. Hall, Ave. F. East McComb, 2d-4th Thurs.

- Miss Lula Hassfield, Pres., R. F. D. No. 1.
Mrs. E. Sullivan, V.-P. & Treas., 725 Ave. F.
Miss Emma Sullivan, C. S., 725 Ave. F.
Miss Lulu Hassfield, R. S.

L. A. 9—GRAND JUNCTION, COLO.

- Mrs. W. H. Holeman, Past Pres., 914 S. 5th St.
Mrs. F. N. Davies, Pres. & Treas., 538 Ute Ave.
Mrs. J. W. Cox, C. & F. S. & V.-P., 925 S. 5th St.
Mrs. L. A. Turner, R. & S. T.

L. A. 10—SPRINGFIELD, MO.

- Mrs. A. F. Bingham, Pres., 701 Lombard St.
Mrs. J. Gestring, Vice-Pres.
Mrs. C. S. Gilliland, C. & R. S., 1914 Johnson St.
Mrs. Wm. Specht, F. S. & T., Route 6.
Mrs. Rheaden, Chaplain.
Mrs. J. East, Conductress and Marshall.
Mrs. J. Ritterhouse, Inside Guard.
Mrs. Gestring, Mrs. Gilliland and Mrs. East, Trustees.

L. A. 11—LONE STAR, Palestine, Texas, Labor Temple, 2d-4th Tues. afternoons.

- Mrs. Frances Brunson, Pres., 15 Cottage Ave.
Mrs. Helen Redus, V.-P., 106 Queen St.
Mrs. Florence Payne, R. S. & Treas., 212 Palmer Ave.
Mrs. Willie Welch, C. & F. S., 511 Green St.

L. A. 12—GARFIELD PARK, Chi-cago, Ill., 1st-3d Sat., 3 p. m., Garfield Park Hall, 4029 W. Madison.

- Mrs. Maud Reinmeyer, Past Pres.
Mrs. Mollie Geary, Pres., 6428 S. Albany Ave.
Mrs. E. Farrell, V.-P., 4118 Car-rell Ave.
Mrs. Helen Hughes, Cor. & Rec. Sec., 716 N. Avers Ave.
Mrs. Mary Driscoll, Fla., Sec. & Treas., 4135 Carroll Ave.

L. A. 14—TOLEDO, O.

- Mrs. E. Richardson, Pres.
Mrs. Allen Thomson, V.-Pres.
Mrs. C. F. Haga, R. S.
Mrs. C. J. Sugrue, C. & F. S.
Mrs. Carrie Stephan, Treas.
Mrs. Louise Brown, Conductress.
Mrs. Lena Kern, Inspectress.

L. A. 15—SAPULPA, OKLA.

- Mrs. Cora Johnson, Pres.
Mrs. Myrtle Clifton, V.-Pres.
Mrs. Addie Allen, R. S.
Mrs. Beesie Lewis, C. S.
Mrs. Hester Chapman, F. S.
Mrs. Ethel Edwards, Treas.
Mrs. Hettie Rondon, Chaplain.
Mrs. Ferrel Wells, Conductress.
Mrs. Emma Davis, Inside Guard.
Mrs. Katie Hoover, Marshall.
Trustees—Laura Cargill, Mrs. Em-ma Davis, Mrs. Addie Allen.

Boilermakers' Lodges by States.

Alabama.
 Birmingham . . . 4
 Montgomery . . . 443
 Selma . . . 312
 Sheffield . . . 344
 Whistler . . . 511

Arizona.
 Miami . . . 187

Arkansas.
 Harrison . . . 138
 Little Rock . . . 66
 McGhee . . . 106
 Paragould . . . 599
 Pine Bluff . . . 68
 Van Buren . . . 521

Canada.
 Calgary, Alberta . . . 392
 Ft. William, Ont. . . . 505
 Hamilton, Ont. . . . 421
 Joliette, Que. . . . 604
 McAdam Jct. . . . 379
 Moncton, N.B. . . . 378
 Montreal . . . 134
 Moose Jaw, Sask. . . . 478
 North Bay, Ont. . . . 417
 Quebec . . . 601
 Revelstoke . . . 466
 Riviere du Loup, Que. . . . 398
 St. Thomas, Ont. . . . 413
 Toronto, Ont. . . . 548
 Transcona, Man. . . . 529
 Winnipeg, M. 12C
 Winnipeg, M. 46E

British Columbia.
 Vancouver . . . 194
 Victoria . . . 191

California.
 Los Angeles . . . 92
 Oakland . . . 233
 Pt. Richmond . . . 317
 Sacramento . . . 94
 S. Francisco . . . 25
 S. Francisco . . . 205
 S. Francisco . . . 410
 Vallejo . . . 148

Colorado.
 Alamosa . . . 446
 Colorado . . . 136
 Denver . . . 179
 Grand Jct. . . . 335
 Pueblo . . . 44
 Balda . . . 427
 Trinidad . . . 390

Connecticut.
 Hartford . . . 237
 New Haven . . . 61

Delaware.
 Dist. of Columbia
 Washington . . . 450

Florida.
 High Springs . . . 570
 Jacksonville . . . 20
 St. Augustine . . . 230
 Sanford . . . 573
 Sanford . . . 422

Georgia.
 Atlanta . . . 2
 Augusta . . . 108
 Cedartown . . . 510
 Columbus . . . 426
 Fitzgerald . . . 503

Macon . . . 12
 Savannah . . . 26
 Waycross . . . 426

Idaho.
 Avery . . . 595

Illinois.
 Alton . . . 483
 Bloomington . . . 156
 Chicago . . . 1
 Chicago . . . 39
 Chicago . . . 220
 Chicago . . . 227
 Chicago . . . 454
 Chicago . . . 434
 Chicago Hts. . . . 254
 Chicago . . . 688
 Danville . . . 22
 Decatur . . . 447
 Freeport . . . 284
 Joliet . . . 92
 Kewanee . . . 195
 Mattoon . . . 224
 Moline . . . 377
 Peoria . . . 60
 Murphysboro . . . 524
 Springfield . . . 81
 E. St. Louis . . . 363
 Urbana . . . 150
 Villa Grove . . . 575

Indiana.
 Bedford . . . 541
 Evansville . . . 95
 Ft. Wayne . . . 54
 Garrett . . . 79
 Hammond . . . 358
 Indianapolis . . . 10
 Lafayette . . . 360
 Peru . . . 384
 Princeton . . . 334
 Terre Haute . . . 246
 Washington . . . 241
 Wabash . . . 324

Iowa.
 Belle Plaine . . . 440
 Boone . . . 161
 Cedar Rapids . . . 144
 Des Moines . . . 47
 Dubuque . . . 15
 Marshalltown . . . 149
 Mo. Valley . . . 145
 Sioux City . . . 244
 Valley Jct. . . . 491
 Waterloo . . . 133

Kansas.
 Atchison . . . 507
 Coffeyville . . . 542
 Ft. Scott . . . 286
 Goodland . . . 393
 Herington . . . 340
 Holington . . . 408
 Horton . . . 199
 Kansas City . . . 83
 Neodesha . . . 418
 Osawatomie . . . 82
 Parsons . . . 292
 Pittsburg . . . 221
 Pratt . . . 523
 Wichita . . . 543
 Wichita . . . 518

Kentucky.
 Covington . . . 537
 Covington . . . 364
 Louisville . . . 40
 Ludlow . . . 584
 Paducah . . . 137
 Somerset . . . 419

Louisiana.
 Baton Rouge . . . 532
 New Orleans . . . 37
 New Orleans . . . 442
 Shreveport . . . 328
 Algiers . . . 208
 Monroe . . . 590

Maryland.
 Cumberland . . . 332
 Cumberland . . . 577
 Baltimore . . . 193
 Hagerstown . . . 578

Massachusetts.
 Boston . . . 250
 Boston . . . 431
 Boston . . . 585
 Cambridge . . . 515
 Dorchester . . . 574
 Greenfield . . . 517
 Lowell . . . 371
 Norwood . . . 281
 Springfield . . . 218
 Worcester . . . 492

Michigan.
 Bay City . . . 67
 Detroit . . . 169
 Escanaba . . . 597
 Grand Rapids . . . 84
 Jackson . . . 64
 Marquette . . . 236
 Saginaw . . . 124

Minnesota.
 Brainerd . . . 116
 Duluth . . . 165
 Minneapolis . . . 11
 St. Paul . . . 3
 Two Harbors . . . 437
 Winona . . . 201

Mississippi.
 McComb City . . . 315
 Meridan . . . 320
 Vicksburg . . . 56
 Water Valley . . . 300

Missouri.
 Brookfield . . . 354
 Cape Girardeau . . . 430
 Chaffee . . . 531
 De Soto . . . 117
 Hannibal . . . 353
 Kansas City . . . 32
 Moberly . . . 267
 Monett . . . 546
 Nevada . . . 583
 Sedalia . . . 113
 Springfield . . . 70
 Springfield . . . 530
 Slater . . . 588
 St. Louis . . . 27
 St. Louis . . . 51
 St. Louis . . . 276
 St. Louis . . . 322
 St. Joseph . . . 31
 Stanbury . . . 594
 Sugar Creek . . . 90
 Trenton . . . 346

Montana.
 Anaconda . . . 80
 Deer Lodge . . . 528
 Glendive . . . 591
 Great Falls . . . 602
 Harlowton . . . 41
 Havre . . . 367
 Livingston . . . 123
 Miles City . . . 520
 Missoula . . . 111
 Butte . . . 130

Nevada.
 Sparks . . . 339

Nebraska.
 Chadron . . . 109
 Fairbury . . . 439
 Falls City . . . 565
 Grand Island . . . 475
 North Platte . . . 118
 Omaha . . . 38

New Hampshire.
 Concord . . . 245
 Portsmouth . . . 467

New Jersey.
 Elizabeth . . . 176
 Hoboken . . . 163
 Jersey City . . . 16

New York.
 Albany . . . 197
 Brooklyn . . . 45
 Elmira . . . 225
 Mechanicalville . . . 388
 Middletown . . . 400
 Norwich . . . 396
 Oneonta . . . 414
 Oswego . . . 175
 Rochester . . . 229
 Salamanca . . . 598
 Staten Island . . . 200
 Syracuse . . . 157
 Troy . . . 73
 Utica . . . 223
 N. Y. City . . . 21

North Carolina.
 Raleigh . . . 173
 Rocky Mount . . . 239
 Salisbury . . . 226

North Dakota.
 Devils Lake . . . 479

Oklahoma.
 Muskogee . . . 504
 Okla. City . . . 556
 Sapulpa . . . 449
 Shawnee . . . 293
 Chickasha . . . 323
 El Reno . . . 522

Ohio.
 Akron . . . 600
 Canton . . . 301
 Chillicothe . . . 135
 Cincinnati . . . 105
 Cleveland . . . 5
 Columbus . . . 8
 Conneaut . . . 355
 Elmwood Place . . . 91
 Jackson . . . 509
 Lima . . . 259
 Middleport . . . 549
 Montpelier . . . 581
 Newark . . . 92
 Niles . . . 275
 Portsmouth . . . 402
 Springfield . . . 18
 Toledo . . . 85
 Van Wert . . . 409

Oregon.
 La Grand . . . 553
 Portland . . . 72

Panama.
 Empire, C. Z. 463
 Cristobal . . . 471

Pennsylvania.
 Carbondale . . . 547
 Connellsville . . . 444
 Galeston . . . 438
 Lansford . . . 573
 New Castle . . . 493
 Philadelphia . . . 341
 Pen Argyl . . . 140
 Pittsburgh . . . 154
 Pittsburgh . . . 318
 Philadelphia . . . 19
 Pottsville . . . 256

South Carolina.
 Charleston . . . 50
 Columbia . . . 235
 Florence . . . 424

South Dakota.
 Huron . . . 496
 Mobridge . . . 606

Tennessee.
 Bristol . . . 435
 Copperhill . . . 453
 Jackson . . . 88
 Knoxville . . . 143
 Memphis . . . 189
 Nashville . . . 42
 Chattanooga . . . 14

Texas.
 Amarillo . . . 321
 Beaumont . . . 587
 Big Spring . . . 423
 Childress . . . 382
 Dalhart . . . 476
 Dallas . . . 86
 Denison . . . 209
 El Paso . . . 216
 Ft. Worth . . . 96
 Galveston . . . 132
 Houston . . . 74
 Kingsville . . . 287
 Marshall . . . 100
 Mart . . . 222
 Palestine . . . 464
 Sherman . . . 458
 Port Arthur . . . 305
 Smithville . . . 265
 San Antonio . . . 345
 Teague . . . 502
 Terrell . . . 459
 Tyler . . . 486
 Waco . . . 501

Utah.
 Helper . . . 473
 Ogden . . . 198
 Salt Lake City . . . 103
 Tooele . . . 605

Vermont.
 Lyndonville . . . 481

Virginia.
 Alexandria . . . 369
 Clifton Forge . . . 238
 Newport News . . . 55
 Norfolk . . . 428
 Portsmouth . . . 298
 Portsmouth . . . 57
 Richmond . . . 170
 Roanoke . . . 30
 Roanoke . . . 29
 Virginia . . . 65

Washington.
 Bremerton . . . 290
 Everett . . . 500
 Othello . . . 603
 Spokane . . . 242
 Seattle . . . 104
 Seattle . . . 489
 Tacoma . . . 247
 Tacoma . . . 568

West Virginia.
 Bluefield . . . 405
 Elkins . . . 278
 Gassaway . . . 152
 Hinton . . . 525
 Huntington . . . 249
 Keyser . . . 579
 Princeton . . . 551
 Williamson . . . 557

Wisconsin.
 Butler . . . 589
 De Pere . . . 571
 Green Bay . . . 485
 Milwaukee . . . 107
 Milwaukee . . . 302
 N. Fond du Lac . . . 395
 S. Kaukauna . . . 311

Wyoming.
 Casper . . . 596
 Cheyenne . . . 48
 Evanston . . . 309
 Laramie . . . 48

By Insisting Upon Purchasing Union Stamp Shoes



You help better shoemaking conditions.
You get better shoes for the money.
You help your own labor position.
You abolish child labor.

Do not be misled by retailers who say: "This shoe does not bear the union stamp, but is made under union conditions." This is false—no shoe is union made unless it bears the union stamp.

Boot and Shoe Workers' Union

246 SUMMER STREET, BOSTON, MASS.

JOHN F. TOBIN, President.

CHAS. L. BAINE, Sec.-Treas.

THE COMMERCIAL NATIONAL BANK

of KANSAS CITY, KANSAS.

CAPITAL AND SURPLUS, \$550,000.00. DEPOSITS.....\$5,000,000.00

We cordially invite the Boiler Makers and Ship Builders of the United States who desire to transact banking business with us (which can be done readily by mail), to write to any of their officers and ask any questions they may desire to ask about our reliability and standing.

P. W. GOEBEL, President.
A. C. FASENMYER, Vice-President.

C. L. BROKAW, Cashier.
G. J. BISHOP, Asst. Cashier.

When Writing Advertisers

PLEASE MENTION

The Boiler Makers' Journal

Notice to Subscribers of the Journal

When members change their address, or do not receive Journal promptly, fill out the following blank and forward to the editor:

Name Reg. No.Lodge.....

Old Address, Street.....CityState.....

New Address, Street.....CityState.....

I have not received Journal for month of.....

KANSAS CITY, KAS., APRIL, 1915.

THE BOILERMAKERS JOURNAL

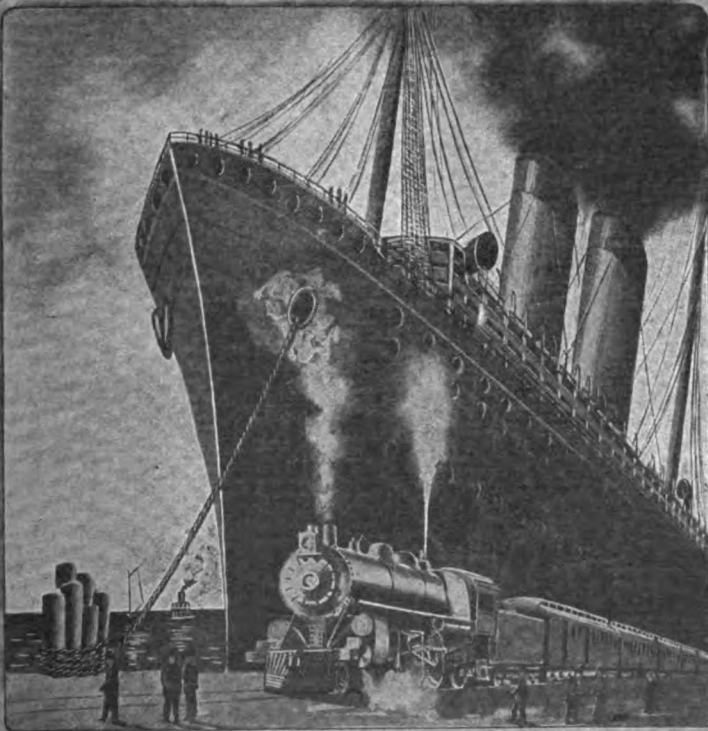

OFFICIAL ORGAN OF THE
INTERNATIONAL BROTHERHOOD
OF BOILERMAKERS, IRON SHIP BUILDERS
AND HELPERS OF AMERICA

"The goods did not rip at all - glad to say I escaped unhurt." *E. A. Tillery*

A Remarkable Proof of the Strength of Headlight Overall Materials

JACKSON, GA. Jan 27 1915
 Messrs Larned Carter & Co
 Detroit Mich.
 Gentlemen - Enclosing here with a Cold Roll Steel Pulley Key that I had driven in a key-way on a shaft to hold a large gear in position after completing the job and putting the machine in motion an accident happened. I had left a portion of the key extending beyond the end of shaft. I was wearing a pair of Headlight Overalls and by accident the key caught the overalls of my left leg just below the knee. The enclosed key will show you what happened.

Could not refrain from writing and sending you the steel key
 Yours Very truly
 E. A. Tillery
 Jackson, Ga.

JACKSON, GA. Jan. 27th, 1915.
 Messrs. Larned, Carter & Co.
 Detroit, Mich.
 Gentlemen:-

I am enclosing herewith a Cold Roll Steel Pulley Key, that I had driven in a key-way on a shaft to hold a large gear in position. After completing the job and putting the machine in motion an accident happened. I had left a portion of the key extending beyond the end of shaft. I was wearing a pair of Headlight Overalls and by accident the key caught the overalls of my left leg just below the knee. The enclosed key will show you what happened.

The shaft running at a rapid rate of speed twisted the key in the oscillating shape that it is now in, tearing the cloth of my overalls and twisting them up into a knot. The goods did not rip at all and the key will give you an idea of the strength of the goods. Glad to say I escaped unhurt.

Noting the strength and durability of your Headlight Overalls, I could not refrain from writing and sending you the steel key.

Yours very truly,
 E. A. TILLERY

ACTUAL SIZE OF STEEL PULLEY KEY



This Steel Bar Pulley Key Twisted Like a Corkscrew Before Headlight Overalls Tore

"A Smile of Satisfaction with every Pair"

HEADLIGHT OVERALLS

(UNION MADE)

Larned Carter & Co.
 Detroit Mich.

World's Greatest Overall Makers

Factories Detroit, Port Huron, Mich., St. Louis, Mo., Sarnia, Ont.



SECURITY SECTIONAL ARCH

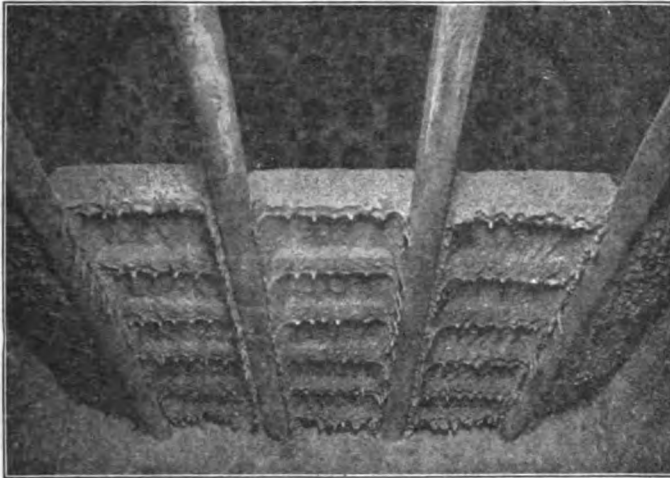

This arch is of light weight
It is built up of small sections
So made as to cool off quickly
It is easily removed for work
Made so to help the boilermaker

AMERICAN ARCH COMPANY

30 CHURCH STREET, NEW YORK

MCCORMICK BUILDING, CHICAGO

You know OVERALLS,
Uniforms, Shirts, etc., are



OK
if they have
this  mark
on the back of
the material on
the inside of the
garment.

*It's the cloth in the
garment that gives the
wear.*

Stifel's Indigo Cloth

Standard for over 75 years.

Its continuous use by three generations of the "men of the road," factory and field is certain proof of extraordinary quality. Stifel Indigo wears like leather. Every washing makes it like new.



This little mark is put on the back of the cloth on the inside of the garments for your protection.

Look for it before you buy.

Cloth manufactured by
J. L. STIFEL & SONS
Indigo Dyers and Printers
WHEELING, W. VA.

SALES OFFICES

NEW YORK.....260-262 Church Street
CHICAGO.....223 W. Jackson Boulevard
SAN FRANCISCO.....Postal Telegraph Building
ST. JOSEPH, MO.....Saxton Bank Building
ST. PAUL.....238 Endicott Building
TORONTO.....14 Manchester Building

Price List of Supplies

B. M. and I. S. B. monthly due stamps, each.....	\$1.00
Helpers' monthly due stamps, each.....	.50
Apprentices' monthly due stamps, each.....	.50
B. M. and Ship Builders' initiation stamps, each.....	1.00
Helpers' initiation stamps, each.....	.50
Apprentices' initiation stamps, each.....	.50
B. M. or Iron Ship Builders' out of work stamps, each.....	.20
Helpers' out of work stamps, each.....	.10
Apprentices' out of work stamps, each.....	.10
Universal reinstatement stamps, each.....	.50
Local assessment stamps, per 100.....	.25
Subordinate Lodge or District Charters, each.....	2.00
Seals, each.....	2.75
Punch, each.....	1.00
Ledger, 400 page, each.....	2.50
Minute Books, 400 page, each.....	1.50
Journal or Day Book, 400 page, each.....	1.50
Monthly report books, each.....	1.00
Receipt book, Treasurer, each.....	.35
Warrant book, R. S., each.....	.35
Receipt book, members B. A. or F. S., each.....	.35
Rituals, each.....	.30
Duplicate due books, B. M. or H., each.....	.25
Due books, B. M. or I. S. B., each.....	.10
Due books, Helpers, each.....	.10
Constitutions, each 5c, or per dozen.....	.50
Letter heads, ruled, per 100.....	.70
Letter heads, unruled, per 100.....	.70
Envelopes, per 100.....	.60
Application blanks, B. M. or H., per doz.....	.10
Delinquent notices, B. M. or H., per doz.....	.10
Withdrawal cards, B. M. or H., each.....	.10
Clearance cards, B. M. or H., each.....	.02
Ballot boxes, each.....	1.25
Gavels, each.....	.25
Ballot balls, white or black, per doz.....	.10
Rolled gold charms, each.....	1.75
Solid gold charms, each.....	8.00
Official Emblem buttons, small size, ea.....	1.00
Official Emblem buttons, large size, ea.....	1.50
Official Ribbon Badges:	
1 badge.....	1.50
2 or more, each net.....	1.25
6 or more, each net.....	1.00
12 or more, each net.....	.75

Free.

- Labels.
- Supply Blanks.
- Grievance Blanks.
- Pedigree Blanks.
- Affidavit Blanks.
- Blank Bonds.
- Strike Rolls.
- Roster Blanks.
- Trial Blanks.
- Application for Bonds.

District Lodge.

100 Letterheads..	\$1.50	100 Envelopes..	\$1.00
200 Letterheads..	2.25	200 Envelopes..	1.50
300 Letterheads..	2.50	300 Envelopes..	1.75
400 Letterheads..	2.75	400 Envelopes..	2.00
500 Letterheads..	3.00	500 Envelopes..	2.25
600 Letterheads..	3.25	600 Envelopes..	2.50
District due stamps, per 100.....	.25		
District assessment stamps, per 100....	.25		

Secretaries must keep a duplicate of all orders on file in their Lodges.
Secretaries shall give full name and correct address and number of articles wanted in the left hand margin.

**No Supplies Sent Unless Cash
Accompanies the Order**

The Boilermakers' Journal

Official Organ of the
**International Brotherhood of Boilermakers
Iron Ship Builders and Helpers of America**

Vol. XXVII.

KANSAS CITY, KAS., APRIL, 1915.

No. 4.

TRADE UNIONISM, PROGRESS AND LIBERTY.

By Samuel Gompers.

A very serious misconception is presented by Mr. Harris Weinstock in an article entitled "Justifying the Minimum Wage," recently published in *The Industrial Outlook*. In discussing the brief by Rome G. Brown in the Oregon minimum wage case, Mr. Weinstock said:

"Mr. Brown points out that organized labor is opposed to the principle of establishing the rate of wages by legislation. I know that to be true but organized labor takes this position, not because it is opposed to the minimum wage, since organized labor itself wherever possible establishes a minimum wage, but it is opposed to such wage being fixed by legislation for the reason that it wants labor to be obligated to unionism for bettering wages rather than to the state. Union leaders have pointed out that if the state is to shorten hours and increase wages, there would be no need for workers to join unions, and therefore union leaders are opposed to the state's robbing unionism of its claim for membership."

This assertion is one of those partial truths that have done so much injustice to the purposes and motives of organized labor. It is intended to create the impression that members of organized labor are actuated by wholly selfish motives when they warn workers against giving control over their working lives into the hands of "public functionaries."

It is quite true that organized labor holds unionism of supreme importance in securing the betterment of the workers. Trade unionists do not underestimate the value of humanitarian legislation, but they hold that things inseparably associated with liberty or properly the subject for voluntary control by those concerned and not state action which represents the collective power of society.

Those things which are a concern and an obligation to society as a whole are properly matters for action by the state. So far as the people are concerned laws should secure them freedom to seek their own welfare and opportunity for initiative.

For workers, the working time constitutes and determines the conditions of their real existence. The prime of their life's vigor,

the fullness of their strength and their creative ability are given to the shop, the factory, and the mine. The hours of labor, the conditions of work, and the pay for work are the keys to controlling the lot of these who toil, for these are the important elements in working contracts.

Under the present organization of industry, individuals have found that singly they are unable to make contracts that secure them protection and fair wages, but that collectively they approach economic equality with employers and therefore secure fairer contracts.

Therefore workers have voluntarily associated themselves in unions. They have worked out demands for justice and have succeeded in having many of these included in work contracts. This they have done by their own economic power without outside assistance. And the doing has not been easy.

In the early days to be a union man was to be a marked man, was to be blacklisted by employers and hounded from place to place. Often it meant being a social outcast, the butt of ridicule and buffoonery. It took courage, red blood, determination, conviction, and consecration to be a unionist in those days.

The unions have been the schools of the workers where they learned the lessons of democracy and independence.

In the unions workers have learned their rights and how to get them.

The workers have learned that betterment comes only through their own efforts and diligence and that to work directly for securing desired purposes is economy of labor.

The power of the unions and the success of their activities have been due to their voluntary character.

What unionism has done for wage-workers is open history. A summary of its achievements during 1913 is found in report to the International Federation of Trade Unions, published in this and last month's issues; a review of the progress of 1914 may be found in the Executive Council report to the Philadelphia American Federation of Labor Convention, and for previous years in former convention reports. The Amalgamated Association of Street and Electric Railway Employes recently published a pamphlet en-

titled, Wage History, showing what unionism has gained for those workers. The September, 1914, issue of the American Federationist contains a symposium of achievements of workers through organization. Other organizations have similar data.

But in addition to results there is another test of unionism—its influence upon manhood and womanhood. There are no more aggressive, resourceful, progressive men and women in the world than those who belong to the American trade union movement. The trade union movement of the United States is the most militant, virile labor movement in the world. The unionists are the embodiment of self-reliant independence, they infuse democracy into all relations of life. They are making sacrifices in the endeavor to induce other workers to join them in the voluntary movement for the betterment of industrial conditions.

Now certain political actionists and benevolent outsiders present to trade unionists the proposition that regulation of hours of work and wages be placed in the hands of political agents—minimum wage and universal eight-hour laws for private industries have been persistently advocated and trade unionists have been denounced because they have not favored them without reservation. Yet the surrender to outside authority of power to determine hours of work and wages means also to place in governmental authority either the enforcement of such determinations or the punishment of those who refuse to yield their freedom.

This change means that agreements and adjustments to meet changing conditions will cease to be voluntary. It means that unionists will lose the right of initiative, hence their fine independent spirit. It means that unionists will lose the right of initiative, hence their fine independent spirit. It means that trade unionists will cease to be an aggressive, determining force in industry, but will become an auxiliary to a bureaucracy under commissions, wages boards, etc. It means that trade unionism will lose its virility and the power to protect the workers.

Can the workers agree to any proposition that will weaken or embarrass unionism?

Can the toilers afford to trust the determination of the terms of their contracts to work to agencies over which they can at the best have only indirect control?

Is human nature so constituted that the workers can trust matters affecting their real liberty in the hands of "disinterested" outsiders?

If the workers surrender their right to determine the terms of contract, are they not endangering also their right to reject terms? If that be true, what becomes of their industrial freedom, the right to control or withhold their labor?

When contracts are determined by governmental agents they take on the character of official state pronouncements, and

a strike against conditions of work becomes a strike against state authority. In order to maintain state authority fines and prison sentences for strikes are the inevitable next stage of development, as is amply manifested in Australasia where such agencies have been most fully tested. Whatever name this may be called, it results in industrial slavery for workers.

Rather than to take one step in that direction, trade unionists maintain that it is far better to endure the ills we have at present, and to continue to work out industrial betterment upon principles that are true and tried.

Labor's progress has not been spectacular, but it has been sure. It has made for wholesome development.

The trade union movement has always accepted the assistance of outside agencies which could advise, educate and make easier the work of industrial betterment, but it has emphatically demanded that determination of personal relations must be held by the workers in their own hands.

The trade union movement has secured the enactment of laws that assure to the workers freedom for working out their own welfare, and has asserted claims to legislation to promote life, health and safety, objects that are outside the province of collective economic action.

Trade unionism has been the great revolutionizing force for industrial betterment and progress. It has been the one protection in which the workers could put their trust. That is why trade unionists oppose a plan to subordinate it to other agencies—the trade union movement is the hope of the workers. Don't you see, Mr. Weinstock?

MR. HILL'S LOGIC.

Louisville Post: Mr. J. J. Hill, in an address calling for ship subsidy, made the following statement the base of his argument:

"Vessels built in the United States cost from 50 to 100 per cent more than the same vessels built abroad; therefore the American merchant marine cannot compete with the foreign merchantmen."

Mr. Hill is the chief of those spokesmen that declare again and again that the American railroads, manned by American laborers, paid higher than any other laborers in the world, are able to carry passengers and freight cheaper than any other nation in the world.

It costs from 50 to 100 per cent more to build the American locomotives and American cars than it does foreign locomotives and foreign cars; therefore, according to Mr. Hill's logic when he is talking about ship subsidies, we ought to be charging from 50 to 100 per cent more for freight and passengers in America than they get abroad.

THE BOILER MAKERS' JOURNAL

Official Organ of the International Brotherhood of Boiler Makers, Iron Ship Builders and Helpers of America.

A Monthly Publication Issued the First of Each Month from Room 8, Law Building, Kansas City, Kansas.

JAMES B. CASEY, Editor and Manager.

Subscription Price.....\$1.00 Per Year in Advance

ADVERTISEMENTS.

Advertising Rates Will be Furnished Upon Application to the Editor-Manager. No Reading Space Will be Sold for Advertising Purposes Under Any Circumstances.

All New Members Must Have Their Name and Address Sent in Through the Secretary of Their Lodge. After That They May Have Changes Made in Their Address by Filling Out Blank Form in Back of Book and Forwarding to the Editor.

All Copy Must be Received by the Editor by the 18th of the Month to Insure Publication in the Following Issue.

All Contributions and Correspondence Relating to the Journal Should be Addressed to J. B. Casey, Editor, Room 8, Law Building, Kansas City, Kansas.

Entered at Postoffice, Kansas City, Kansas, as Second Class Mail Matter.

LEGAL NOTICE REQUIRED BY LAW.

Statement of the ownership, management, circulation, etc., of the Boiler Makers' Journal, published monthly at Kansas City, Kas., required by the Act of August 24, 1912.

Names of Stockholders: None.

Name of editor, James B. Casey. Postoffice address, Kansas City, Kas. Business manager, James B. Casey, Kansas City, Kas. Publisher, International Brotherhood of Boiler Makers, Iron Ship Builders and Helpers of America. Names of owners, The International Brotherhood of Boiler Makers, Iron Ship Builders and Helpers of America.

(Signed)

JAMES B. CASEY,
Editor and Business Manager.

Sworn and subscribed before me this 20th day of March, 1915.

H. E. BRIDGENS,
Notary Public.

(Seal)

(My commission expires March 18, 1916.)

PANAMA-PACIFIC INTERNATIONAL EXPOSITION OPENS.

The daily press informs us that the Panama-Pacific Exposition at San Francisco opened on schedule time, February 20, under very favorable auspices and a large crowd. The gates will remain open until the 4th day of December, and notwithstanding the disturbed condition of Europe and the depression in industry everywhere the exposition bids fair to make a record for attendance.

The editor desires to acknowledge receipt of a cordial and gracious invitation from the president and board of directors to attend the exposition and to make our headquarters in the building erected for the convenience of the representatives of the press. While we may not be able to avail ourselves of this invitation, we nevertheless appreciate its being tendered, as well as the complimentary tickets of admission which accompanied it.

All those who can should by all means see this exposition, as it is, we believe, a very complete one, and the opportunity to see another first class exposition may not appear again soon.

In connection with this, we desire to remind our members that the strikes are still in effect on the Illinois Central and Harriman Lines and that it is not only our duty not to buy a ticket over any of the lines composing this group of roads, but if we know of others who contemplate going to the exposition, we should ask them to buy their tickets over the roads which are fair and have agreements with our organization, and in doing so we will not only help ourselves but be doing a favor to those we speak to about the matter, as the superior roadbeds, equipment and motive power of these fair roads insure safer travel and more prompt arrival at their destination.

FAKE EMPLOYMENT AGENCIES.

Some time ago a communication was received by President Franklin from a member in Minneapolis, asking information in reference to an advertisement for railroad mechanics for work in Mexico, and offering large salaries. The matter was referred to Lodge 216 at El Paso and from information received from there it seems a man named Taylor was operating a fake employment agency at Juarez, Mexico, and inserted ads in papers in the Middle West, stating that large numbers of all kinds of railroad mechanics were wanted in Old Mexico, and offering positions at large salaries to those applying. The conditions were that one dollar had to accompany the application and it seems those who sent on their money are still waiting for a reply. However, the Mexican authorities have at last convicted this man of using the mails to defraud and he will likely get a good round term in jail.

No doubt other schemes of a like nature will appear and our members should investigate fully before responding, as it may turn out to be another fake ad. Just at the present it seems to us Old Mexico, with its 57 varieties of revolutions, is a good place to stay away from. Neither life or property in this strife ridden country is safe and most of the people can hardly get enough to eat, much less find steady work at big salaries. It is a good policy to take time to investigate advertisements for men at any time, for if they are not a fake just like the one referred to, they are liable to be for work as strike breakers.

FEDERAL INDUSTRIAL COMMISSION TO INVESTIGATE STRIKES.

Notice has been received that the Federal Industrial Commission would give a public hearing at Chicago, commencing April 5, in reference to the strikes on the Harriman Lines and Illinois Central System, at which time all parties in interest will be heard.

Just what it is proposed to bring out at this hearing, or the possible results, we are unable to say. The attorney for the railway department, Mr. Comerford, of Chicago, will likely look after the interests of the men on strike.

Possibly a frank and full discussion on the part of both sides might bring out the fact that no great or fundamental differences exist as a bar to a peaceable settlement. If so, and a settlement was the result later on, it would be a distinct and important achievement of the commission.

NEWPORT NEWS STRIKE SETTLED.

Word was received recently at headquarters, announcing that the strike, which has been on for a long time in the boiler shop of the Newport News Ship Building and Dry Dock Company's plant, was settled.

We have not learned the full particulars, but we believe the terms of settlement was the reinstatement of the men to their former position and no discriminations to be used.

This strike, it seems, was long drawn out, because the other trades failed to respond when they were called on. Had they done so, it would have been settled long since and no doubt the result would have been much more satisfactory.

THE FEDERAL LOCOMOTIVE BOILER INSPECTION LAW AMENDED.

The expected has happened, and the federal locomotive boiler inspection law has been changed, by adding the Goeke amendment to the former law. During the last daily session of the last Congress, at the still small hours of the night (about 5 a. m. on March 4, to be more exact) Senator Robinson of Arkansas asked leave to submit a report from the committee on interstate commerce, and also asked unanimous consent for the immediate consideration of this amendment, and as there was no one to offer objection it was acted upon thus in the last dying hours of Congress, amid confusion and exhaustion of the members. This hasty and illadvised change concerning the inspection of locomotive boilers was passed by the Senate, and as the House had previously approved the bill, and the President soon after approved it, the measure became a law.

The effect of this law is to extend the duties of the boiler inspectors to cover all parts of the locomotive, and all the different classes of inspection covered is to be done by the same inspector. Thus in order to be a competent inspector, one should be a first class boiler maker, machinist, blacksmith and car worker, and fully versed in safety appliances of all kinds. The inspection of all parts of the locomotive, if properly provided for, is all right, but this extension of inspection should have come under the safety appliance law instead of the boiler inspection law, as it was more applicable.

We have no hesitation in expressing our belief that Congress made a mistake in this hasty action amending the locomotive boiler inspection law; furthermore, we believe it will rectify this mistake when the effect of this change is more fully explained to them.

It looks as if Senator Robinson was not dealing frankly with our representatives, when a short time before this he told them there was little likelihood of the interstate commerce committee making any report during the recent session of Congress. Nor was he stating correctly the facts in the case when in answer to Senator Jones of Washington, whether in his opinion the change improved the existing law he (Senator Robinson) replied: "Certainly. I will state that the representatives of a great majority of the labor organizations were heard regarding the bill, and they approved the bill in this form." Senator Robinson was a member of a sub-committee which heard the objections raised by our representatives as well as the representatives of the railway department and others to this measure; furthermore, our objections were unanimously indorsed by the last convention of the American Federation of Labor, all of which were made known to this committee. This does not coincide with the statement contained in the above quotation.

EXPRESS COMPANIES STILL LOSING BUSINESS AND PROFITS.

According to a recent report of the Interstate Commerce Commission, in reference to the business of the principal express companies of the United States for the month of November, 1914, there was a loss of \$182,745, as compared with a large profit in November, 1913.

For the five months ending with November, 1914, the companies' net profit was \$72,951, as compared with a profit of \$1,722,000 in November, 1913.

Evidently the Parcel Post has put an awful dent in the business of these companies and bids fair to put them out of business in a short period of time.

In years gone by, these companies would declare large dividends and pay enormous salaries and still have so much left over that they would have to "slice a melon" of millions of dollars among their stockholders every now and then, but evidently these "melons" have stopped growing and it is not likely any more will be ripe enough in a long time for these companies to "cut."

These huge profits were made by unmercifully gouging and overcharging the shipping public. We can get along very well without the service of these companies—the postoffice will give more satisfaction and at a much less cost. There was no real need for these companies. The railroads should have performed this service and the profits realized go towards maintaining the road rather than the making rich of a few people. In our opinion the next special service on railroads to put out of commission should

be the Pullman and other sleeping car companies. The roads should furnish this service themselves, and the large profits that now go to a few rich owners of these companies could go to help maintain the road. This would be much better than boosting freight rates or passenger fares.

THE TAYLOR SYSTEM FAD ON THE WANE.

For the past two or three years every possible influence has been exerted by interested parties—contractors and others—to have the United States government put in force in its navy yards, arsenals, etc., the Taylor system of so-called scientific management. No doubt for the purpose of boosting this nefarious system among private employers of labor. A number of officers of the army and navy, strange to say, have made themselves very officious in trying to force this system on the men employed in the navy yards and arsenals, but without success in the navy yards. There is no good reason why the government should adopt such an inhuman system in order to drive its employes at a higher speed and squeeze from them a larger task for a day's work. The last convention of the A. F. of L. coincided with this opinion and instructed its executive council "to continue its efforts to have a law enacted which will prevent the introduction of any system of shop management which includes the use of stop watches in connection with workmen's labor, or the application of any system of payment of wages adopted for the purpose of speeding up workmen, and the elimination of such system wherever it exists." In conformity with this action an amendment was placed in the army and navy appropriation bills, which provided that no part of the money therein appropriated should be used for installing or maintaining the Taylor or any other such system of so-called scientific management. This amendment was overwhelmingly adopted by the House, but in the Senate it met with opposition and was rejected; however, in a conference between committees from the House and Senate, it was agreed to allow the amendment to stand, and although some of the members of the Senate objected to the amendment and lauded the Taylor system, they dared not reject the conference report for fear of the appropriations for the maintenance of the army and navy would fail to pass, and the amendment prevailed in both bills. However, Senator Oliver of Pennsylvania seemed to take much consolation in his statement that no such provision hampered the expenditure of the money appropriated for fortifications and therefore the Watertown (N. Y.) arsenal could work the Taylor system. This is splitting hairs and would be a clear violation of the spirit of the law concerning this matter and if any Taylorized system is maintained by money appropriated for fortifications an emphatic protest should be made to the Secretary of the War Department, as this matter comes under his charge as well as the expenditure of the money appropriated for the maintenance of the army.

Senator Root of New York, who is a lawyer and possibly never worked a day in his life at manual labor, made a lengthy talk in behalf of the Taylor system, and among other things, said it was a system with which the

workmen, equally with officers are satisfied, on the demand of AN OUTSIDE LABOR ORGANIZATION, we deliberately interfere with our officers in the expenditure of the public moneys, and in the discharge of the trust which we equally with them rest under. On the demand of AN OUTSIDE LABOR ORGANIZATION because we are afraid of them, because they have votes, we prohibit our officers from conducting the business which we put into their hands on the principles that every well conducted private enterprise in the country applies. Now sir, for my own part, I repudiate any such method of controlling the expenditure of the public funds and the conduct of public business. I am against it and am going to vote against it.

Senators Lippitt of Rhode Island, Weeks of Massachusetts and others voiced their praise of the Taylor system and their opposition to the amendment.

Now, this does not settle the matter, and the fight will have to be continued in future sessions of Congress, if we would prevent the adoption of this nefarious system in our navy yards and arsenals.

The trouble with this matter seems to us to be that our law makers have not given sufficient thought to this matter or the underlying motive and tendencies of it, nor of the ultimate result that would ensue. We should keep up a campaign of education on this matter and endeavor to especially bring it to the attention of the members of Congress and that, too, while that body is not in session, as they will be able thus to give it more attention and thought. We can't believe a majority of the members of either House of Congress would deliberately favor a system that would harass, debase and destroy the manhood of the toilers of our nation, as we believe the Taylor system would eventually do; therefore, we should act upon this assumption and do all we can to bring them to see the ultimate results of the adoption of such a system as we see it.

STATE LAWS CANNOT PREVENT SHIPMENT OF BEER.

The United States Supreme Court recently rendered a decision to the effect that state laws cannot prevent the delivery of beer from another state to within its borders. The court lays down the following doctrine: "Beer is a recognized article of commerce. The right to send it from one state to another and the act of doing so are interstate commerce, the regulation whereof has been committed to Congress, and a state law which denies such right or substantially interferes with or hampers the same is in conflict with the constitution of the United States. Transportation is not complete until delivery to the consignee, or expiration of a reasonable time therefor and prior thereto; the provisions of the Wilson act of 1890 have no application."

We believe this decision is in line with the spirit of our country and its constitution. States may refuse to legalize the sale of beer and whiskey

within its borders, but it should not attempt to say to even a minority of its people: "You shall not drink this or that beverage or liquors." If the state can prevent me from drinking what I want, it can prevent me from eating what I want, and it can prevent me from dressing as I want. This would interfere with our inalienable right to life, liberty and the pursuit of happiness, guaranteed us by the constitution.

PRESIDENT WILSON SAYS THE WORLD COULD DISPENSE WITH "HIGH SOCIETY" AND NOT MISS IT.

"High society" was given a severe jolt by President Wilson at a recent meeting in behalf of a college founded for the purpose of educating the mountaineers of the Southern states. He praised the simple straightforwardness of these people and criticised the airs which "high society" gives itself. Here is an extract from his speech:

"What America has vindicated above all things else," said the president, "is that native ability has nothing to do with social origin. It is very amusing sometimes to see the airs that high society give itself. The world could dispense with high society and never miss it. High society is for those who have stopped working and no longer have anything important to do.

Trees Develop from Roots.

"A tree does not derive its strength from its flower nor from its fruit. It derives all its strength from its roots. It derives all its vital sources of its life from the soil. And so with a nation.

"The nation is not fed from the top. It is not fed from the conspicuous people down. It is fed from the inconspicuous people up, and those institutions which, like Berea, go in to the unexhausted soils and tap their virgin resources are the best feeders of democracy."

This would indicate that Mr. Wilson is not very much impressed with our snobs or their importance. He stated the case very accurately when he said: "High society is for those who have stopped working and no longer have anything important to do." We can see no good purpose this element of our people accomplish, and we believe a large majority of the people heartily concur in the sentiment expressed by President Wilson.

A TALK WITH OUR SECRETARIES.

As a large majority of the secretaries have sent in complete lists of the names and addresses of their members either voluntarily or since we called upon them for these lists, we desire to express our appreciation for their promptness. In this way all of their members are assured of receiving their Journal each month.

There are some secretaries, however, to whom we have written two or more letters and still no complete list has been received from them. We desire to impress upon these the importance of sending in revised lists fre-

quently, for unless they do so we cannot keep the mailing list revised in accordance with the changes that take place in the membership of their lodge. In most lodges changes in membership are constantly taking place. Those who for any reason cease to be members of a lodge, their name should be taken from our mailing list for that lodge, and when their card is deposited in another lodge, the secretary of that lodge should send in their name and new address, and it is the duty of the member so depositing his card to furnish the secretary with their new address and request them to send same in for the Journal. Instead of doing so many write to the editor to send them the Journal. They should realize we are dependent upon the secretaries for a list of those entitled to the Journal, and as it would materially lessen the work here we hope all will follow these instructions. However, if for any reason they do not get the Journal after so doing, let us know and we will endeavor to get the matter straightened out.

Another matter I would like to call the secretaries' attention to is in reference to promptly reporting any changes in the roster for their lodge, as it is essential for the speedy transaction of the affairs of our organization that the roster be kept up to date. Under the present plan of caring for the Journal, we are only making corrections every other month, as we are having electrotypes made of the roster and use these in place of the regular type, thus avoiding the necessity of having to have the roster reset at frequent intervals and considerable cost. We can use these electros two issues, which lessens the cost of keeping roster; however, to make new plates every issue would be rather expensive and if changes are reported promptly we can keep the roster in very good shape. Owing to it being the first part of the year and having a very large number of changes, we did have new plates made for January, February and March Journals. Our next changes will be in May Journal and every other month thereafter. We hope the officers of the lodges will bear this in mind and promptly report such changes as may be necessary, so that they may be made as early as possible.

DEATH OF BROTHER A. E. STRODE'S FATHER.

Word was received at headquarters recently of the death of Mr. George Strode, father of Brother A. E. Strode, at Champaign, Ill., where he lived and was engaged in business. Old age and a general breakdown was the cause of his death, we believe.

We desire to extend to Brother Strode our sincere condolence and sympathy in his affliction.

A NEW ILLUSTRATED CATALOG.

"Faessler Boiler Makers' Tools" is the name of the new catalog just issued by the J. Faessler Manufacturing Company, Moberly, Mo., specialists in boiler tool manufacture. This catalog fully illustrates and describes many types and sizes of boiler tube and superheater flue expanders—sectional and

roller—for hand or power operation. It also shows Faessler's flue cutting tools and machines, countersinking tools, etc.

CHANGES SHOULD BE WELL CONSIDERED BEFORE BEING ENDORSED.

As there seems to be an extensive propaganda campaign being inaugurated in behalf of the proposition to amalgamate some of the metal trades, it might be well to suggest that our members should not indorse propositions of this kind until they have maturely considered the matter from every angle and calculated the ultimate result, because of the far reaching effect it would have upon the future of organized labor and especially our own trade, for if such a proposition was adopted and amalgamation took place, the charters and positions these organizations now hold in the family of trades unions would be surrendered and a new charter taken out which would cover the jurisdiction embraced in the charters of the organizations effected.

Should the effects of this amalgamation later on prove to be disappointing and a failure, no matter how irksome it might become to our members, there could be no escape except by a total disintegration and dissolution of the amalgamated organization, there could be no return to our present positions as independent organizations for we would have surrendered these and accepted membership in the new organization and which would then hold jurisdiction, whether for weal or woe, and this would prevent any other organization being recognized as a bonafide labor organization of our trades. Therefore we should study all the probable results before we indorse the proposition, if we would escape the possible result suggested above, and there is more than a possibility of such a result suggested above, as we have the experience of former promiscuously formed organizations of labor to guide us, they proved a failure in the past because of the inherent weaknesses of this plan of organization, and we may well ask ourselves if history would not again repeat itself if the present proposition was consummated.

Some of these advocating the proposition have tried to arouse the prejudice of our members in favor of the measure and a feeling of antagonism and resentment against the International officers by asserting that they would oppose the matter for no other reason than self interest, this is the methods usually used by those having no argument to back up their advocacy of a proposition and are afraid of the effects of arguments they know can be made against it, and we believe its use in this instance will have no better effect than in all such cases in the past where it proved to be a boomerang instead of a boost.

It seems to us it does not require much argument to prove that Grand Lodge officers who help handle and adjust the business affairs of our organization, who goes from section to section adjusting the grievances and misunderstandings that arise between the different organizations as well as employes and employed, who with representatives of other organizations help to solve the tangled problems that are constantly arising and who hears .he

sentiments and opinions of our members are in a better position to see the result of the adoption of such a proposition than the average member, therefore if such is the case, we should, if we would be honest with ourselves, seek the benefit of this experience rather than denounce it. We hold no brief for the defense of the officers of our organization. However, in justice to them, we will say we believe none of them would allow their personal interests to stand in the way of the real progress of our members and that if it can be shown to them that the abolition of their positions was for the good of our members, they will make the necessary sacrifice. As for the editor, he has always insisted, as a journeyman, on the right to quit his employment whenever he felt disposed to do so and always accorded to his employer the right to dispense with his services at any time, nor would he continue to work for any employer if he had reason to believe his work was not satisfactory, and he feels the same way as an employe of the organized men of our trades.

We regret we cannot discuss at length the merits, if any, of this plan, but space will not permit. However, we may discuss this matter again in a future issue.

We cannot close, however, without pointing to our members that this is not a clear-cut proposition of amalgamation of the metal trades as presented by the machinists, but only a portion of them, and we cannot understand why they should want to amalgamate with the tinner and the sheet iron worker and not seek to amalgamate with the moulders, who are more closely connected with them in their work than probably any other trade. Furthermore, we cannot understand why they should want some of the men employed around the wood working machinery of planing mills and not seek to have the pattern makers also, who have to make the patterns for the moulder to cast before the machine can be put to work. The pattern makers and moulders were not included in this proposition and the others were, so we wonder why.

QUOTATIONS.

Actions that promote society and mutual fellowship seems reducible to a proness to do good to others and a ready sense of any good done by others.—South.

Many men there are than whom nothing is more commendable when they are singled; and yet, in society with others, none less fit to answer the duties which are looked for at their hands.—Hooker.

I respect the man who knows distinctly what he wishes. The greater part of all this mischief in the world arises from the fact that men do not sufficiently understand their own aims. They have undertaken to build a tower, and spend no more labour on the foundation than would be necessary to erect a hut.—Goethe.

The measure that God marks out to thy charity are these: Thy superfluities must give place to thy neighbor's great conveniences; thy conveniences must yield to thy neighbor's necessity, and lastly, thy very necessities must yield to thy neighbor's extremity.—South.

He that does good to another man does also good to himself; not only in the consequence, but in the very act of doing it; for the conscience of well doing is an ample reward.—Seneca.

Just thoughts and modest expectations are easily satisfied. If we don't over-rate our pretensions all will be well.—Jeremy Collier.

What can be a more pitiable object than decrepitude sinking under the accumulated load of years and of penury? Arrived at that period when the most fortunate confess they have no pleasure, how forlorn is his situation who, destitute of the means of subsistence, has survived his last child or his last friend! Solitary and neglected, without comfort and without hope, depending for everything on a kindness he has no means of conciliating, he finds himself left alone in a world to which he has ceased to belong, and is only felt in society as a burden it is impatient to shake off.—Robert Hall.

STRIKES NOW IN FORCE.

- Spokane, Wash., Union Iron Works. (Metal Trades strike on.)
- Farrer Traft Contract Shops, Buffalo, N. Y. (Strike on.)
- Illinois Central R. R. (Federated Trades strike on.)
- Harriman Lines. (Federated Trades strike on.)
- Pere Marquette R. R., Grand Rapids and Saginaw, Mich. (System Federation strike.)
- Contract shops, Mobile, Ala. (Metal Trades strike.)
- Atlantic Basin Iron Works (Shields & Moran, New York). (Strike on.)
- Hibbon & Co., contract shop, South Chicago, Ill. (Unfair.)
- Milwaukee Boiler Co., Milwaukee, Wis. (Strike on.)
- Stockton, Calif. (Metal Trades strike.)
- Warren City Boiler & Tank Co., Warren, Ohio. (Strike on.)
- Standard Boiler & Plate Iron Co., Niles, Ohio. (Strike on.)
- Reeves Bros., Alliance, Ohio. (Strike on.)
- Hammond Iron Works, Warren, Pa. (Strike on.)
- The Petroleum Iron Works, Sharon, Pa. (Strike on.)
- The Treadwell Construction Co., Midland, Pa. Strike on.)
- Riter-Conley Construction Co., Pittsburgh, Pa. (Strike on.)

Mechanical Department.

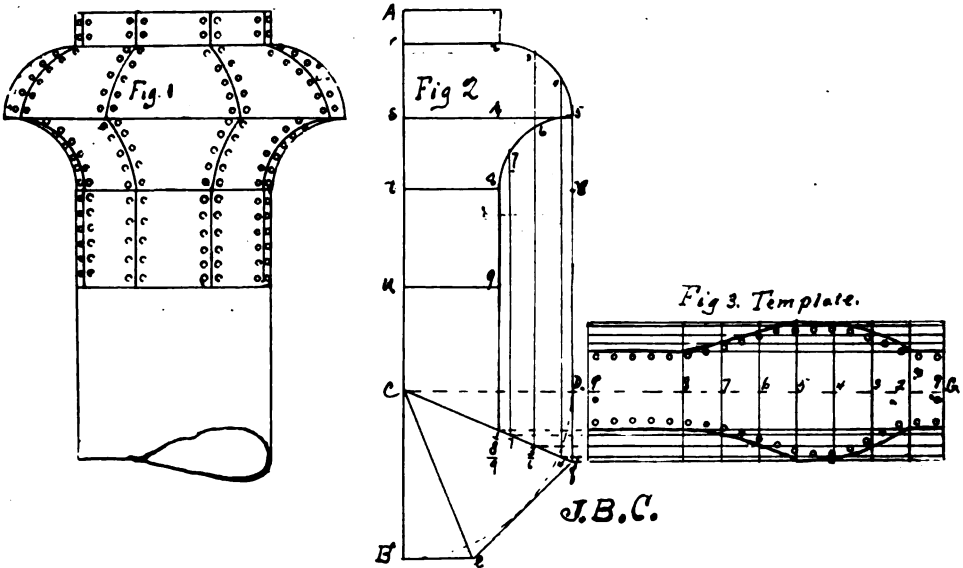

TO LAY OUT A MOLDED STACK CAP.

Fig. 1 shows a molded stack cap with is made of several sections, the larger the stack, usually the greater the number. Fig. 2, shows the side elevation for a stack to be made in eight pieces; mark this off the desired size, using mean diameters, that is the distance from the center of iron on one side to the center of material on the opposite side, it will be noticed that the circular parts of this figure are the same, that is the radius for the top half is the same as the other half just below.

Divide these into six equal parts as shown and through the points of division, strike lines down and parallel with the center line A-B, next take trams and with one point at S and the other at 5, Fig. 2, thus secure the radius of the largest part of the stack, place one point of trams at C on line A-B and strike quarter circle from D to B, divide this into four equal parts and strike divisional lines from the first and third points of division A to C extending these lines beyond circle, extend vertical line from D to F where it cuts divisional line, place one end of straight edge at F and just touch circular line at the middle of same, and strike a line from F to E, then strike line from E to B. The triangle

F-C-D-F represents one-half of a section of the cap. Extend line C-D to G, this will be the center line for Fig. 3 which is the template for a section. Take distance from U to T, Fig. 2, and mark it on line C-D-G from 9 to 8, next take the length of quarter circles 8 to 5 and from 5 to 2, Fig. 2, and mark them from 8 to 2, Fig. 3. Divide this length into six equal parts and strike lines through these points at right angles to line C-D-G. Next take points on line C-F, Fig. 2, where vertical lines cut this line and strike lines parallel with C-D-G. Place the same number of lines on opposite side of center line and at the same distance from center line. Where these lines cross each other, is a point in developing template. Take a pencil and trace line through as shown, give the holes for rivets the desired pitch and size, use this as a template and mark off seven more, to complete the circle. A cap made in 16 sections is laid out in similar manner, however, instead of dividing quarter circle D-B into four parts it would be divided into eight and line C-F would be placed midway between F and D and of course the template would only be one-half the width as in the first example, any other number of sections may be used in the same manner as shown.

International Officers' Reports.

A COMMUNICATION FROM THE INTERNATIONAL SECRETARY-TREASURER.

Kansas City, Kans.

To the Officers and Members of All Subordinate Lodges, Greeting:

It has come to my notice that the clearance cards accepted by local lodges to be forwarded to the International Secretary-Treasurer, to be recorded and to make the necessary changes in the card index system, in order to keep track of our traveling membership, are not being filled out by a great many of our secretaries according to the laws of our organization.

We have received a great many clearance cards with probably just the member's name and registered number thereon. The law requires that the card be filled out completely, giving the name and registered number of the brother very plainly, date of initiation and lodge number in which he was initiated, lodge number sending in the card and the signature of the financial secretary upon the face of the card. On the back each item should also be filled out, giving the brother's qualifications, whether he be boilermaker, helper, riveter, apprentice, or whatever he may be, also the identification.

I have before me seven cards received from one lodge and I only find three that are anywhere near correctly filled out.

Now, Brother Secretaries, I trust that you will take the necessary precautions in filling out these cards completely as the law of our organization requires, as it has caused a number of our local secretaries inconvenience in reference to getting the necessary information that should be on this card, especially the date of initiation and the correct registered number.

We have received a great many complaints from the various shop committees who must vouch for a traveling brother in order that he may receive transportation from one place to another, by identifying the brother who presents the card, and if the identification was placed upon the back of the clearance card, it would be much easier for our shop committees to secure transportation for our traveling brothers.

I trust that all secretaries will give us their hearty co-operation in filling out these cards in the manner required by the Constitution of this Brotherhood.

With best wishes, and kindest regards to all, I beg to remain,

Fraternally yours,
F. P. REINEMEYER,
I. S. T.

REPORT OF INTERNATIONAL VICE PRESIDENT MERRIGAN.

Edmonton, Alta., March 16, 1915.

Dear Sir and Brother:—

Conciliation Board About to Reach Basis of Finding, But E. D. & B. C. Objects.

The conciliation board, dealing with the

wage dispute between the shop employes of the Edmonton, Dunvegan and British Columbia Railway; the Alberta and Great Waterways Railway, and the Canada Central Railway, have had several meetings since February 15, and on Saturday morning, Mar. 13, after having failed to reach a satisfactory settlement, decided, with the consent of both parties, to the disputes, to transform the board into one of arbitration.

The board will now hold public meetings, collect evidence and present a verdict.

On November 1, 1914, the J. D. McArthur road put through wage cuts of from 25 to 33 1-3 per cent. The rates prior to November 1, were as follows: Boiler Makers, 48½c; Machinists, 47¼c; Blacksmiths, 47c; Tinsmiths, 30c; Painters, 38c; Carpenters, 30c; Pipe Fitters, 38c; Car Repairers 27c; Boiler Maker Helper, 30c; Machinists' Helper, 25c; Blacksmiths' Helper, 30c; Pipe Fitters' Helper, 20c per hour.

After cut as follows: Boiler Makers, 35c; Machinists, 35c; Blacksmiths, 35c; Tinsmiths, 25c; Painters, 30c; Carpenters, 22½c; Pipe Fitters, 25c; Car Repairers, 20c; Boiler Makers' Helpers, 22½c; Machinists' Helpers, 17c; Blacksmiths' Helpers, 20c; Pipe Fitters' Helpers, 17c per hour.

Upon protests from the men a board of conciliation was appointed, W. MacAdams representing the men; O. M. Biggar the company, and Mr. Justice Hyndman as chairman.

On Saturday, March 13, after several meetings had been held and the board had reached what was thought to be a basis for an agreement, the general manager of the McArthur Construction Company was asked if the company would consent to the changes dating back to November 1, and he refused. The board then asked if it altered its work from that of conciliation to arbitration, would both parties agree. A reply was received in the affirmative and consequently the board will hold public sessions to receive further representation. The first meeting will be held March 18th, Thursday night at eight o'clock. J. W. Hefferman is representing the men and S. B. Woods, Kansas City, the company.

The running trades are also in dispute with this company, and the employes of the Hudson Bay Railway caused the reduction of wages.

We had expected to meet last night and hold our first hearing but I believe for reasons better known by our attorney the hearing was postponed until Thursday night. The Provincial Legislature is sitting, and we expect to have some of the opposition air the matter in the House for our benefit. There is no doubt but what this company is trying every effort to take advantage of the men, claiming that they are short of money, but

that is all rot. The Government has financed them plenty.

With best wishes and kindest regards, I am,
Yours fraternally,
J. P. MERRIGAN, I. V. P.

REPORT OF SECOND INTERNATIONAL VICE-PRESIDENT NOLAN.

Editor Journal:

The following is my report from January 1 to February 28, 1915:

On several matters of much interest to the members of the Brotherhood; one of which will cause, I have no doubt, considerable indignation among the members of our craft, as well as the members of other railroad shops organizations, that is, the passage of the Geoke Amendment to the Boiler Inspection Law, which was enacted February 17, 1911; passed the United States Senate on the morning of March 4, 1915.

The advocates of this peculiar legislation could have only one object in view in securing this passage, and that was: To get absolute control of the Bureau of Boiler Inspection, notwithstanding the fact that the primary object in having federal inspection of locomotive boilers enacted into law was to safeguard life and property on American railroads, in having practical mechanics as inspectors, in order to comply with the law as enacted February 17, 1911.

Therefore, I deem it my duty as a representative of the Brotherhood of Boiler Makers, Iron Ship Builders and Helpers of America, to give absolute facts in connection with Geoke Amendment to the Boiler Inspection Law, since it was introduced in the House and Senate of the United States, until its final enactment into law, March 4, 1915.

I do so with a certain feeling of responsibility, in the general welfare of our membership, who are affiliated, and part of the American labor movement, so they may know their position and whom to depend on when vital questions or labor legislation confront them in the future.

After our late convention adjourned in San Francisco, Calif., President Franklin notified the writer that an amendment to the Boiler Inspection Law had been introduced in the House of Representatives by Congressman Geoke of Ohio, and referred to the Committee on Interstate and Foreign Commerce, of which Congressman Adamson of Georgia was chairman.

The representatives of the four transportation Brotherhoods appeared before the above committee, indorsing the Geoke legislation, which requires that each inspector shall be qualified to pass upon the condition of a locomotive boiler, as well as the engine and tender. Under the old law, there were fifty district inspectors of locomotive boilers, seventeen of which were boiler makers, also a few machinists, while the balance of the inspectors were locomotive engineers and others.

Why don't England, France and Germany have paper inspectors in their Bureaus of

Locomotive Inspection: Oh, no, for the law as enacted is generally enforced, as every applicant for the position of inspector must be a practical mechanic of railroad shop experience in order to qualify for such positions, as no civil service government commission can change law when once enacted from the practical to the theoretical, which was the primary object of the boiler inspection law in order to protect life in having practical men and inspectors.

But I am very sorry to have to admit that the beneficial object of locomotive inspection seems to have been lost sight of altogether by the legislative representatives of the four Brotherhoods, in an insane desire to place men in position as inspectors who knew nothing whatever about the construction, repairing and testing of locomotive boilers or engines or tenders.

Circular letters had been mailed broadcast throughout the country by and signed by the legislative committee of the four Brotherhoods, requesting that the organized labor movement indorse the Geoke legislation, that would place inspectors in positions of responsibility without the necessary railroad shop experience, and several officers of the American Federation of Labor fell for the misrepresentation contained in their appeal, even to the extent of indorsing by letter and otherwise the amendment to the boiler inspection law, so much so that the majority of the members of the House of Representatives had the idea that the entire American labor movement was in favor of the Geoke bill. Machinists also indorsed the bill, which appeared in their official Journal, June, 1914, without even consulting the officers of the Brotherhood of Boiler Makers, Iron Ship Builders and Helpers of America. This may not have been done intentionally, and trust that in the future that the officers of the legitimate American labor movement will consult with one another before any hasty action is taken by individual organizations on legislation of a national character.

The late convention of the American Federation of Labor held in Philadelphia, Pa., November, 1914, at that convention President Franklin had a resolution unanimously adopted in opposition to the Geoke Amendment, which pledged the American Federation of Labor and its officers to defeat such legislation in the Senate of the United States.

April, 1914, during a convention of the Railroad Employees' Department held at Kansas City, Mo., a resolution was introduced to amend the boiler inspection act of 1911, but after much discussion on the part of many of the delegates, the resolution was defeated through the efforts of Vice-President Heinzman, after a thorough explanation of the fallacy of such legislation; but later on an article appeared in one of the labor journals appealing to their membership in the support of the Geoke legislation, regardless of action

taken at Kansas City, Mo., April, 1914.

On January 12, President Franklin, Brother Wharton, president of the Railway Employees' Department of the American Federation of Labor; President Ryan of the Brotherhood of Railway Carmen, and others appeared before the Executive Council of the American Federation of Labor, Washington, D. C., on matters of general interest to the movement, and during the above meeting the resolution adopted at the Philadelphia convention against the Geoke Amendment was fully and freely discussed by several members of the Executive Council, as well as most of the officers of the Railway Department of the A. F. of L., after which a motion was made that the resident members of the Executive Council located in Washington, D. C., do everything possible to defeat the Geoke Amendment to the Boiler Inspection Law, which was carried unanimously.

January 14th the legal adviser of the International Association of Machinists (Mr. Frank Mulholland) drafted a new bill extending the inspection of locomotive boilers to the inspection of locomotive engines and tenders, which was satisfactory to the officers of the Railroad Department who were present on that occasion, a copy of which was given to the Executive Council while in session.

January 26, Senator Robinson, chairman of sub-committee of the Senate on Interstate Commerce, issued the following notice for hearings before his committee on the Geoke Amendment to the Boiler Inspection Law.

Mr. Thos. Nolan,
Portsmouth, Va.

Dear Sir:

You are informed that the sub-committee on Interstate Commerce will meet in the Capitol in the committee room on Tuesday, February 2, at 2 p. m., for the purpose of having hearings on H. R. 1789, amending the boiler inspection act, at which time you may present your views regarding this subject if you desire.

Very truly yours,

JOE T. ROBINSON,
Chairman Sub-Committee.

On receiving the above notice, I wired President Franklin immediately in order to have a representative from the International office in Washington, D. C., February 2, and later on received answer that Vice-President Heinzman would be present; also President Franklin instructed me to call on President Gompers in order to have the legislative representative of the A. F. of L. present at hearing February 2, and after a conference as per instructions, he advised that I inform President Franklin that a representative of the A. F. of L. would be present, and so instructed his secretary to notify Mr. Holder.

On February 1, Brother Heinzman arrived in Washington, also Brother Wharton of the Railroad Department, Brother Joseph T. Shea, foreman boiler maker New Orleans

Terminal Railroad Company; James H. Noonan, foreman boiler maker, Southern Shops, Knoxville, Tenn.; Joseph E. Holder, boiler inspector, Seaboard Air Line Railroad—all of whom were opposing the amendment of the Geoke Bill, but in favor of extending the inspection to the engine and tender, with practical mechanics as inspectors, having practical shop experience.

On February 2 hearing before the sub-committee of the Senate was held as arranged; Senators Robinson, Cummings and Myers, committee; Senator Robinson, chairman. After the writer had explained to the Senate committee why the boiler makers and others were opposed to the part of the man. After the writer had explained to the Geoke Amendment which made no provision for practical men as inspectors. The first witness introduced was Brother Wharton, president of the Railroad Department of the A. F. of L., who made a strong and forcible argument in favor of practical men as the inspectors of locomotive boilers, as well as the extension of the boiler inspection law to include the engine and tender, advising the sub-committee in the interest of the government, as well as the protection of life and property on American railways and the enforcement of law as enacted in having practical mechanics with railroad shop experience as inspectors.

The writer next called on Brother Holder, the legislative representative of the American Federation of Labor, but his answer was, "I am not prepared."

The next witness before the sub-committee was Vice-President Heinzman, who made a complete detailed explanation of many vital questions of justice, as well as law, and the necessity in bringing about the results intended when the boiler inspection law was enacted February 17, 1911. Brother Heinzman proved from the printed proceedings that H. E. Wills in 1910 and 1911 advocated competent boiler makers when the boiler inspection bill was pending before Congress, as well as Warren E. Stone, chief of the B. of L. E.

On February 4 the hearings on the Geoke bill were continued before the Senate sub-committee, with the following advocates of honest legislation present: Brother Berres, secretary-treasurer of the Metal Trades Department of the A. F. of L.; Vice-President Heinzman; President Wharton of the Railroad Department; Brother Holder, representative of the A. F. of L.; Brother Shea, foreman boiler maker, New Orleans Terminal Railroad Shops; Mr. James H. Noonan, foreman boiler maker, Southern Railroad Company, Knoxville, Tenn.

At the appointed hour, 2. p. m., February 4, Senator Robinson announced in the committee room that the hearing would be deferred one hour on account of important legislation pending in the Senate.

At 3:30 the hearings on the Geoke bill were resumed, with Senator Robinson in the chair. The first advocate of practical

legislation of locomotive inspection was James H. Noonan, who read a very able statement on the question of boiler inspection, why practical men were an absolute necessity in such work, giving his reasons from knowledge gained from years of experience as a mechanic in railroad shops, as well as holding the position of foreman boiler maker in the employ of the Southern Railroad Company.

Next was Brother Joseph T. Shea, foreman boiler maker of the New Orleans Terminal Railroad Company, who also made a detailed explanation of the duties required as well as the necessary qualifications for inspector of locomotive boilers, from the viewpoint of a practical railroad mechanic, and in closing his argument made a strong appeal to the Senate committee for legislation that would safeguard life and property on American railroads.

When Senator Robinson announced a recess just before the convening of the Senate committee, Brother Holder, who was there representing the American Federation of Labor, left the committee room, stating that he would return later to take part in the proceedings, but failed to show up for certain reasons that have not as yet been explained to the writer.

February 7, a meeting was held at the American Federation of Labor headquarters for the purpose of outlining a plan of campaign to defeat the pending Geoke legislation in the Senate, with the following A. F. of L. officers and others present: President Gompers, Secretary Morrison, James O'Connor, Executive Council member of the A. F. of L.; Vice-President Heinzman; Brother Evans, an active member of Lodge No. 450, Washington, D. C.; also Brother Holder, the legislative representative of the A. F. of L. Many suggestions were made during a general discussion of the Geoke bill, but Brother Heinzman insisted on an amendment to Section 2 of the Geoke bill, which provided for inspectors with paractical shop experience in the construction, repairing and testing of locomotive boilers, as well as the construction and repairing of locomotive tenders and engines, which was agreed to, and, further, the representative of the A. F. of L. was instructed to notify each United States Senator of the action taken by the resident members of the American Federation of Labor.

February 10, in company with Vice-President Heinzman, left for Portsmouth and Newport News, Va., for the purpose of attending an open meeting of Lodges 57, 298 and 428, also to meet the management of the Newport News Dry Dock and Ship Building Company, as requested by the members of Lodge No. 55.

On the night of February 11, Brother Heinzman addressed an open meeting of boiler makers and ship builders in the C. L. U. Hall, Portsmouth, Va., with a large attendance present, after which he attended

a special closed meeting of the above lodges:

The joint meeting was called to order by the president of Lodge No. 298 announcing the object of it, etc., which was to give the members of the three lodges an opportunity of hearing Vice-President Heinzman speak on the Brotherhood and other important matters pending at present in many parts of the country, also Washington, D. C. He was given close attention during his remarks and further received a rising vote of thanks as well as an invitation to return to old Virginia.

On February 12, in company with Brother Berres, secretary-treasurer of the Metal Trades Department of the A. F. of L., Brother Heinzman, and the writer called on Mr. Ferguson, general manager of the Newport News Shipbuilding and Dry Dock Company, to talk matters over in connection with the strike of the members of Lodge No. 55, in the boiler department; after quite a prolonged conference we arranged for a committee to meet Mr. Ferguson on Monday, February 15, to talk over the strike situation.

After leaving the office with Mr. Ferguson, Brother Berres, Brother Heinzman and the writer left for Washington, D. C., same evening, February 12, for the purpose of attending to legislation then pending in the United States Senate, arriving there on the morning of February 13.

On the night of February 26, Lodge No. 450 of Washington, D. C., held a reception and banquet to celebrate the ninth anniversary as a lodge of the Brotherhood of Boiler Makers, Iron Ship Builders and Helpers of America; invitations had been extended to the Assistant Secretary of the Navy, Congressman Keating of Colorado, Secretary Morrison of the American Federation of Labor, Secretary-Treasurer Berres of the Metal Trades Department of the A. F. of L.; Mr. Bernard P. Donnelly, chief gunner, United States Navy; Mr. C. T. Clayton, clerk, Labor Committee of the House of Representatives; also several boiler shop proprietors, viz., Messrs. Biscoe, Weber & Thomas, Hurley, Frosbery and Boswell, most all of whom responded to invitation of Lodge No. 450.

The Assistant Secretary of the Navy (Mr. Roosevelt) sent his regrets in not being able to attend, owing to official business in Connecticut with the Department.

The President of Lodge No. 450 and his committee promptly at 9 o'clock conducted the officers and members and their invited guests to the banquet hall; before being seated a flashlight picture was taken by a prominent photographer of Washington, D. C., and after which the good things of the season, furnished by the ladies in charge, were fully enjoyed by all present, and hopes are entertained by the officers and members of Lodge No. 450 that in the near future a ladies' auxiliary of the Brotherhood of Boiler Makers, Iron Ship Builders and Helpers of America will be organized in the

Capitol City of America. Music was rendered by a select union band, which was appreciated by all present, reminding a few of the oldtimers of the good old days long ago.

The banquet hall was decorated with flags and bunting in a manner which none but ladies could do; cut flowers were in abundance, which gave a beautiful effect to the surroundings as well as a pleasure to look upon.

When the inner man was satisfied and happy and enjoying union made cigars, the speakers who were many, gifted as well as champions in the cause of organized labor, responded to the toastmaster in the order named: Congressman Keating of Colorado, Secretary Morrison of the American Federation of Labor, Secretary-Treasurer Berres of the Metal Trades Department of the American Federation of Labor, Mr. B. P. Donnelly, chief gunner United States Navy, Mr. C. T. Clayton, clerk Labor Committee of the House of Representatives; a representative of the Machinists and Pattern Makers from the Washington Navy Yard, also Messrs. Briscoe, Webber and Boswell, boiler shop proprietors of Washington, D. C.

The addresses made were an able explanation of the past achievements of organized labor of America for the benefit of the men of labor. Congressman Keating, many times during his remarks, gave practical illustrations of what can be done in the future, and especially urged that organized labor educate themselves and get posted on the great economic problems that confront the toilers of America.

In fact, all of the speakers, as well as the proprietors, express the hope that the banquet of Lodge No. 450 would be the means of bringing about the desired results and a better understanding among all concerned in the Capitol City. At the hour of twelve the band rendered America, all joining and leaving for their respective homes well pleased after an evening of genuine pleasure.

A vote of thanks was tendered to the following ladies for their untiring efforts to make the banquet a success: Mrs. H. Le Laurine, Mrs. W. E. Webbers, Mrs. A. Sherrier, Mrs. Geo. P. Smith, Mrs. M. W. Kemmerling and Mrs. J. W. Kemmerling. The committee on banquet, composed of Bros. Webber, Le Laurine and Kemmerling, as well as the committee on speakers and music, Bros. Evans and Mean, did some active hustling in order to make the occasion one of pleasure to their invited guests, and I must say they accomplished their purpose, for a good time is essential once in a while, as it brings the members and their families, as well as their friends in the labor movement, closer together, which has a tendency to promote and foster a better and more mutual understanding for their general advancement. May the good work continue in hopes that the day is not far distant when selfish methods, either in industrial controversies or general legislation

for the uplift of labor will not be tolerated by the rank and file of the American labor movement, for if we desire to be successful in the cause of human rights there must be a spirit of unquestioned co-operation in the interests of all who are affiliated with the legitimate labor movement. Men and women, that is why Lodge No. 450 expects, when Feb. 26, 1916, rolls around, to have a ladies' auxiliary of the Brotherhood in the city of Washington, D. C., to counsel and encourage their fathers, brothers and husbands to stand loyal in interest of another when necessary.

During the closing days of the Sixty-third Congress my efforts were entirely taken up in an effort to have an amendment to Section No. 2, of the Geoke bill, approved by the sub-committee on interstate commerce, which was drafted by Vice-President Hinzman and Bro. Wharton, president of the Railway Employes Department of the American Federation of Labor, and approved by President Gompers, Secretary Morrison and James O'Connell, the executive board member of the American Federation of Labor, after which Bro. Holder, legislative representative of the A. F. of L., was instructed to draw up a circular letter, mailing a copy to each United States Senator, explaining the action taken at the Philadelphia convention of the A. F. of L., as well as the approval of the executive council to carry out the resolution, as adopted at the Philadelphia Convention of the A. F. of L., opposing the Geoke amendment to the Boiler Inspection Law, and indorsing a new bill, which provided for practical mechanics as inspectors of locomotive boilers, also locomotive engines and tenders. Explanatory letters to congressmen and senators serving this purpose as a medium of information and are all right. When the advocates of any particular legislation are notified by a congressman or senator over their signature of their approval and support, otherwise nothing doing, which shows the opposition are on their jobs.

In conclusion, let me say that up to and including March 3 I had every hope that the sub-committee on interstate commerce would not report the Goeke amendment out because of the able arguments made in opposition to it before the subcommittee by Bros. Hinzman, Wharton and Shea, as well as James N. Noonan and others, pointing out to the committee why practical mechanics of railroad shop experience were an absolute necessity as inspectors of locomotive boilers as well as locomotives and tenders, in order to conform the law as enacted, which had for its purpose the protection of human life.

I shall never forget the closing hours of the Sixty-third Congress, remaining in the gallery of the United States Senate until 2:10 on the morning of March 4, with a senator who had hardly ever left the senate chamber up to that time, and thinking on account of so much important legislation then pending before the senate, which was in continuous session for almost two days

and nights, that no action would be taken. I left to get a couple of hours' sleep, but before leaving I looked around the senate gallery in hopes to get some friend in favor of honest legislation in the interest of the railroad shop men of America, and prevent such a grave injustice against them, some one to co-operate with and counsel in getting their senator of their state to object when the bill was reported out; but none was there.

I returned at 8:30 A. M. to the senate gallery, remaining there until 9:30. Was anxious to know if any action was taken on bill, called on the clerk of the senate, who informed me that the Geoke bill had passed the senate about 5 A. M. on the morning of March 4, 1915. And further desire to say that if we had a legislative committee of three active workers on the job, the Geoke amendment to the Boiler Inspection Act would have died the death with the Sixty-third Congress.

Bros. Hinzman and Wharton did good, effective work while in Washington, and if they were in a position to remain, the result would have been different, but were compelled to leave to attend to business that required their prompt attention, leaving the writer to contract the gum-shoe work of a committee of four (as well as help when required), representing the four brotherhoods. Let us profit by our defeat, for the Railroad Department is going to be a power in the future in the adjustment of labor disputes, with a membership of 350,000 railroad shop men at present, and when industrial conditions become normal again there will be many thousands more, and in order to get the necessary legislation, either state or national, we are compelled to have one legislative representative from each craft affiliated with the Railroad Employees Department of the A. F. of L. in order to cope with an organized opposition here in Washington, and which the officers of the Railroad Department are aware of, and intend to apply a remedy in the near future.

With best wishes for future success, and greater co-operation in the American labor movement, when the vital interests of any or all international labor organizations are at stake, is the sincere desire of

Yours fraternally,

THOS. NOLAN.

REPORT OF EIGHTH INTERNATIONAL VICE-PRESIDENT, JOS. P. RYAN.

Editor Journal:

As I have not reported for some time owing to the fact that I have been busily engaged, assisting Lodge No. 592 in their strike in the oil fields of Oklahoma. With the exception of a few days at Van Buren and a short visit at home at Christmas time, I have been continuously engaged here at Cushing, Drumright and Tulsa, Okla., since December 4, 1914, to the present date, March 11, 1915.

The strike in the oil field districts of Oklahoma, Louisiana and Texas came about,

owing to the action of seven of the large tank building firms, namely, Petroleum Iron Works, of Sharon, Pa.; Standard Boiler Plate & Iron Co. of Niles, O.; Warren City Tank & Boiler Co. of Warren, O.; Reeves Bros. of Alliance, O.; Hammond Iron Works of Warren, Pa.; Treadwell Construction Co. of Midland, Pa.; and the Riter-Conley Co. of Pittsburgh, Pa., uniting into an association and declaring for the open shop on all their new contracts beginning January 1, 1915.

The Petroleum Iron Works Co. was the first firm to put the open shop policy into effect. On Saturday morning, January 2, 1915, our members were notified on a P. I. W. job at Dropright, Okla., that they could return to work as new men, but that no organization would be recognized. No job stewards would be allowed, no permit men would be bumped to make room for members of our organization and that the job would be an open shop job from that date on. Business agents, Bros. Wm. H. Dwyer and Jack Thomas, also the job stewards and myself, interviewed the foreman, Mr. Harry English, and failing to adjust the matter in any way, we instructed our members to go to Drumright, and placed three pickets on the job. Several of the non-union men who were on the job, came off and joined our members.

Visiting the next job at Drumright at 4:00 P. M. we learned from the president of the lodge and the other stewards, that they had been notified that morning, that they were working on an open shop job. As the strike vote had been taken and sanction granted, we called out the men on the P. I. W. job at Drumright. Sunday, January 3rd, Business Agent Dwyer and myself drove out to Norfolk to Mr. Van Dyke's P. I. W. job and after discussing the matter with him and learning that his job was to start on the open shop plan on Monday, January 4th. We called the men off the job and advised them to return to Cushing, Okla., as all these jobs were camp jobs and as a strike had been called, they had to leave the company camps.

Prior to the locking out of our members at Dropright on January 2nd, a committee and myself had met with Mr. A. Tabor, superintendent in the field of the Petroleum Iron Works and he informed us that all the seven firms had united for the purpose of forcing the open shop in the oil fields and that the matter was out of his hands. We arranged to take the matter up with Mr. C. G. Todd at Sharon, Pa. Vice-President Dowd was sent to Sharon by International President Franklin. He met Mr. Todd but could not get him to take any action other than a reply that he would be willing to attend a conference to discuss the controversy with representatives of our organization providing the others were also agreeable. From Mr. Todd we learned that Mr. A. G. Reeves was the chairman and secretary of the association and that he was the proper party to see as to a conference.

President Franklin sent Vice-President Louis Weyand to Alliance, Ohio, to interview Mr. A. G. Reeves as to securing a conference to take up the trouble. He advised Brother Weyand to have President Franklin address a formal written request to him and that same would be placed before the various heads of the seven companies. This was done. I also went to Tulsa with a committee of Lodge No. 592 and had a conference with Mr. J. J. Keim of the Standard Boiler Plate & Iron Co. He suggested that we try to get in touch with Mr. Gilbert at Miles, Ohio. We also took the matter up with Mr. Wm. Edwards, Vice-President of the Warren City Tank & Boiler Co. at the Tulsa Hotel, Tulsa, Okla. He advised us of the position all the firms had taken, but promised to wire Mr. Hughes, president of his company at Warren, Ohio, as to his position on meeting our representatives in a general conference. I next had President Franklin wire both Mr. Hughes of the Warren City Co. and Mr. Gilbert of the Standard Boiler Plate & Iron Co. President Franklin having business in Washington, D. C., arranged to have them advise him there as to their attitude in granting a conference.

From January 1st up to Monday, January 18th, our members remained at work on all jobs of the Warren City, Riter-Conley, Treadwell, Hammond Iron Works and the Standard Boiler Plate & Iron Co., pending a reply from the said firms as to a meeting. On the Standard Boiler Plate & Iron Co. jobs at Cushing and Drumright, our members worked with non-union men, under protest, in the hope that trouble might be avoided. The strike vote which I took in person, resulted in a vote of yes—571, No. 2—Total Vote—573. On Monday morning, January 18th, all efforts failing to secure a meeting and as non-union men were being placed to work on the various jobs, a general strike order was issued from headquarters by Vice-Presidents Hinzman, Weyand and myself, a committee of Lodge No. 592 being present at the time. All our members were ordered on strike on Monday, January 18th, on all jobs of the six remaining firms. Every lodge in the Brotherhood was notified either by mail or wire, to the effect that the strike had been called. Six hundred members of our organization responded to the Oklahoma fields. Later our members were ordered on strike against these seven firms at Whiting, Indiana; Dallas, Tex.; Ft. Worth, Tex.; Lynchburg, Texas, and Port Arthur, Texas.

For the benefit of our Brothers throughout the country, let me state that this strike was forced upon our members in the various oil fields. There was no question of wages involved, no working conditions in dispute and no trouble on any of the jobs in course of erection. The seven companies have selected the present time, as a most opportune one, to annihilate our organization, and to take from us the conditions and wages we have built up in the oil fields

in the past years. As a means of forcing the open shop, an organization was incorporated under the laws of Oklahoma at Oklahoma City in November, 1914, and known as the Independent Steel Tank Builders of America. Permit men who have derived the benefit of our conditions during the summer months were organized by representatives of the firms now on strike and when the strike was called these men were pressed into service as strike breakers. They were promised contracts but to date none are forthcoming. Now the Independent Steel Tank Builders of America are going to strike, so we are told, because promises have not been kept by the firms on strike.

So that our membership at large may know, to date, our members on strike in the oil fields, have received in regular strike benefits, the sum of eighteen thousand five hundred dollars (\$18,500.00).

As we have a large number of permit men and members who are not entitled to strike benefits, on strike with us, Lodge No. 592 has issued circular letters of appeal to all lodges in the Brotherhood, same being approved by the International President. The returns from this appeal will be used in caring for permit men on strike, also our members who are unable to receive benefits under our laws.

Since the strike has been on, we have been successful in forcing one of the large companies to return several men to Kansas City, Mo., and pay them wages and transportation to the extent of \$30.50 per man. We had the Labor Commissioner take testimony from these men and rather than stand prosecution under the State Labor Laws, they paid them for five days and transportation back to Kansas City, Mo. The labor commissioner had also endeavored to bring about a conference, but without avail.

At the present time we have in the field some fair firms for whom our members are working, enjoying union conditions, wages and hours. These jobs are all closed shop jobs, and are working under the new agreement. The following firms are now erecting work in the Oklahoma fields and we welcome them, as heretofore they have not entered the oil fields, as the larger firms against whom we are on strike have controlled all of the work. Kennicott Co. of Chicago Heights, Ill.; Wm. Graver Co. of East Chicago, Ind.; United Iron Works of Iola, Kas.; Kansas City Construction Co. of Kansas City, Mo., and the Kaw Boiler Works of Kansas City, Kas. These firms are all fair and are employing our members who have been on strike since January 1st and 18th, respectively.

For the benefit of our membership at large, I wish to state that numerous articles have appeared in the papers throughout this section, that the strike has been settled and that all the strikers had returned to work. I take this opportunity of advising our members that the strike is in full force

and effect; contrary to all newspaper reports. The strike is being advertised in our Journal, also several labor papers and when any settlement is reached, all our members will be notified officially.

Lodge No. 592 is not accepting any clearance cards, pending a settlement of the present trouble and all our members are requested to remain away from the oil fields of Oklahoma, Louisiana and Texas, until further notice.

President Franklin at the present time is trying to bring about a conference for the purpose of settling the present strike. To date all offers upon the part of our organization to meet with the firms against whom we are on strike have been futile. The seven companies on strike have deputy sheriffs on all their jobs but the strike-breakers are being paid according to what they do.

Since my last report, I have collected the following amounts, of which I am submitting an itemized statement. To Reinstatement, \$7.50, I. S. T., and to thirty-one official emblem buttons and one charm, \$32.75.

My correspondence has been neglected owing to the fact that my duties here in the strike zone have taken up most of my time. However, I trust that my correspondents will be lenient with me, until such time as I can resume communication with them.

Since the strike has been on we have mourned the loss of two worthy members of our Organization, Brother J. B. Farrell, Reg. No. 58634, and Brother P. J. McBride, Reg. No. 9938, of Lodge No. 592. Both brothers succumbed to pneumonia after a short period. Lodge No. 592 mourns the loss of two staunch union men and our charter is draped in memory of the departed brothers.

Trusting that my report will prove interesting to the rank and file and that all members will be guided by the above information as to the strike in the oil fields, I remain,

Fraternally,
 JOS. P. RYAN,
 8th I. V. P.

**STATEMENT OF OFFICIAL EMBLEM
 BUTTONS AND CHARMS, SOLD BY
 JOS. P. RYAN, 8TH INT. VICE-
 PRESIDENT, JANUARY 1ST
 TO MARCH 1ST, 1915.**

Wm. H. Dwyer, \$1.00; Jack Thomas, \$1.00; Fred Herford, \$1.00; Harry Smith, \$1.00; Richard Rutherford, \$1.00; C. D. Huckaby, \$1.00; Manuel Navarro, \$1.00; G. L. Baker, \$1.00; Peter Gittere, \$1.00; William Carey, \$1.00; Edward Hood, \$1.00; Bert Lemaster, \$1.00; J. T. Bain, \$1.00; J. P. Kane, \$1.00; Edward Sheehan, \$1.00; Harry Moody, \$1.00; Chas. Bouthwell, \$1.00; J. E. Dixon, \$1.00; W. B. Maxwell, \$1.00; Frank Callopy, \$1.00; M. S. Brown, \$1.00; Wm. F. Lambie, \$1.00; W. T. Rogers, \$1.00; J. L. Heath,

\$1.00; A. J. Shindledecker, \$1.00; Edwin Pease, \$1.00; N. Snively, \$1.00; Chas. E. Houghton, \$1.00; George Gardner, \$1.00; Frank McMullen, \$1.00; Jack Thomas, \$1.75; Jos. P. Ryan, \$1.00. Total, \$32.75.

To one reinstatement fee, Brother C. H. Jacobs, Reg. No. 44796, of Lapsed Lodge No. 91, H. D. to I. S. T., \$7.50. Total collection \$40.25.

Respectfully Submitted,
 JOSEPH P. RYAN,
 8th I. V. P.

Cushing, Okla., March 11, 1915.

**REPORT OF NINTH INTERNATIONAL
 VICE-PRESIDENT SCHMITT.**

To the Officers and Members of the Brotherhood, Greeting:

At the conclusion of my last report I was in Indianapolis, Ind., November 12. On the morning of the 13th endeavored to locate Brother Frohlinger and learned he was out of the city; I then met Brother Geyer and with him went to the headquarters of the Structural Iron Workers, to take up with them the question of a tank being built by their members on the Ford Building. We met their International Secretary-Treasurer and he agreed that the work rightfully belonged to the boiler makers, and further informed us that their men had been ordered off of the work, but refused to obey the orders, and that charges would be preferred against the lodge for insubordination. Brother Frohlinger and I went up on the building, but were unable to accomplish anything. I later went to the work again and the men refused to relinquish the work, and then learned of another tank job in an office building, with Brother Frohlinger and the B. A. of the Steam Fitters went to look after this, but getting to where the job was, learned that it had been completed. I then went to the C. H. & D. shops and arranged a meeting of all crafts for the purpose of taking up the question with them of forming a system federation on this road; the next day held this meeting, and the sentiment of the men was for forming the federation. In the afternoon, with the shop committee, met the boiler shop foreman in regard to the discharge of Brother Burke. We were unable to get much satisfaction from him, and then arranged a meeting with the master mechanic, which meeting took place the next day and we were assured that an investigation of the case would be made and would inform the committee of his findings.

On the 20th left for Cincinnati; the 21st went to the Ivorydale shops of the C. H. & D. and arranged a meeting of a committee of each craft for Sunday afternoon. At this meeting the question of forming a system federation was thoroughly discussed, and each craft decided to take up this question at their next regular meeting.

On the 23rd left for Lima, O.; on arriving here, arranged a meeting for that evening of all crafts, and explained to the brothers the object of forming a system federation,

which met with favor of those present, having visited Toledo in October in reference to this, concluded all the points on the system; then wrote letters to all the lodges of the various crafts on the system, notifying them of a meeting to be held in Cincinnati, November 29, and to have delegates at this meeting.

On the 24th I returned to Cincinnati to attend a meeting of the General Labor Council, being informed by Brother O'Brien that at this meeting it was expected that the question of placing the Casey-Hedges Company of Chattanooga, Tenn., on the unfair list would be brought up by the Metal Trades, this company having had a contract to build four boilers for a Cincinnati brewery, and because of their not being made by union boiler makers were compelled to cancel the order after having two completed. I endeavored to organize this plant at the time but the company positively refused to consider this, and their not being able to place these boilers was largely due to the activity of the members of Lodge No. 105. The company, because of being unable to place these boilers discharged what few union machinists they employed.

On the 25th I went to my home where I remained until the 27th, when I returned to Cincinnati to prepare for the federation meeting of the crafts on the C. H. & D. Ry. on the 29th. This meeting was a success as all crafts were represented from all points on the system, a temporary organization was formed and constitution and by-laws were adopted, and another meeting arranged for on the 19th of January.

On the 30th and December 1st, Vice-President Nolte of the Railway Carmen and myself got out copies of the minutes of the meeting and the constitutions and by-laws for each lodge of the crafts on the system, also for each of five International Offices and the Railway Employees Department, 24 copies in all of 11 pages each. Evening of December 1st I left for Louisville, Ky., to meet with the president of the Kentucky and Indiana Terminal Railway Co., to complete the negotiations for a new agreement and an increase in wages, which we were unable to secure in our negotiations with the superintendent early in November.

On the 2nd, I, with the committee met the president of the Company and were successful in getting with some slight improvements the old agreement and an increase of one cent per hour for the boiler makers and helpers, who at the time were only working seven hours per day.

On the 4th, Brother Nolte of the Carmen and I left for Princeton, W. Va., arriving there the next morning where we met Brother Davison, general organizer of the machinists. In the evening we met several of the committeemen of the various crafts and arranged for meetings with the federated committee to learn of the grievances, these meetings were held each eve-

ning until the 10th, when Brother Nolte of the carmen and Brother Davison of the machinists and I left for Norfolk, Va., to meet the general manager of the Virginian Railway. We had a conference on the 11th with the general manager, and superintendent, of the motive power and superintendent shops. At this meeting the grievances were gone over, we having numbers of them in writing and finally a meeting was arranged for on the 16th, in Princeton, W. Va., of all officials from the superintendent motive power down and the federated committee, at which we were to lay down a policy to be carried out by the officials and employes. On the 12th we left for Washington where I met Brother Nolan and we called upon the congressman from my home district and Senator Pomerene, in reference to the proposed amendment to the boiler inspection law.

On the 15th we left for Princeton, W. Va., arriving there on the morning of the 16th. In the afternoon the meeting as arranged by the general manager was held, some 15 officials and 18 committeemen being present, and superintendent motive power stated the object of the meeting and turned over the same to us. A stenographic report of the meeting was taken and each foreman and lodge on the system was furnished a copy. We took up all grievances of both sides and placed the responsibility of the existing conditions on the foreman as well as on the employes. We then defined a policy by which the officials and the men were to work and abide by in the future, failure to carry out this policy by either the officials or the men would be subject to dismissal from the service of the company. We then held a federation meeting and explained to the brothers what had been done, and up to the 21st held craft meetings instructing them in reference to handling grievances in the future. Before leaving the city one of the carmen was caught violating the rules laid down for carrying tales to the foreman and was discharged immediately, this being one of the features that was causing most of the trouble in the shops.

On the 21st I left for my home for Christmas, arriving there on the 22nd. On the 26th I left for Keyser, W. Va., to straighten out the financial affairs of Lodge 579, on my arrival notified Secretary Dougherty and requested him to call at the hotel in the evening which he failed to do. The next day at noon I met the president of the lodge and he informed me where the books were and the trouble they were having. I got the books that afternoon and in the evening went to Piedmont and met several of the brothers. On the 30th and 31st and January 1st and 2nd, I worked on the books which had not been audited for over two years and were very badly kept, and on evening of the 2nd held a meeting in Piedmont and on Sunday held another meeting in Piedmont. At this meeting two helpers were obligated, also reported the condition

of the books and finances. On Monday, consulted a lawyer and showed him the books. He was of the opinion that it would be doubtful if a case could be made in court and advised that an effort be made to get a settlement otherwise, so I sent for the financial secretary to call at the hotel and he failed to call. I then sent him a notice to meet me the next morning by 11 o'clock. Failing to do so would prosecute him. The next morning he came and I went over the books and the report I had made out showing him to be short in his accounts \$115.80 as I had worked it out. He did not deny the statement. I finally made a settlement with him allowing his monthly dues for his services for 29 months, amounting to \$43.50 and \$50.00 in cash, giving him a receipt for same. In the evening held a meeting and made a report of the settlement made and the brothers were very much pleased at the outcome as it was more than they expected. As several of the brothers had paid their dues, an order was drawn for \$64.70 for stamps and supplies, bringing all the brothers in good standing January 1st.

On the 7th I left for Cumberland, Md., to take up the work of reorganizing Lodges Nos. 332 and 577. On Sunday evening held a meeting in South Cumberland which was well attended for the first meeting of B. & O. men, at this meeting 33 signed up to affiliate and pay their fee on the 29th which was their pay day. On the 11th met a committee of the brothers from the Western Maryland shops and arranged a meeting for the evening of the 12th. At this meeting, 7 boiler makers and 2 helpers paid their reinstatement fee and forwarded same to the I. S. T. for supplies.

On the 13th met committee of the B. & O. shops.

On the 14th I went to Keyser to attend meeting of Lodge No. 579 and initiated two helpers at this meeting. On the 15th left for Cincinnati to attend meeting of the C. H. & D. Railway System Federation which was to meet on the 19th and the various district organizations were to meet the day previous to draft their special rules. The federation was in session the 19th and 20th, at which good business was done adopting general and special rules, electing officers and affiliating with the railway employes department. Brothers Garvey and McGillivray of the southeastern federation were present at this meeting and spoke in behalf of system federation and explained the workings of the federation and what it had done for the railway employes of the southeast. Also attended meeting of Lodge No. 91 on the 19th.

On the 21st, with other international officers I left for Lima, O., for some organization work. On the 24th we went to Peru, Indiana, to attend the C. & O. System Federation meeting which was in session on the 25th, 26th and 27th, and was a very good meeting and a great deal of good work done. Brother Garvey also attended this

meeting. On the evening of the 26th, Brother Garvey and I attended the meeting of Lodge No. 384, which was well attended and doing good business. At 10 p. m. I was compelled to leave for Lima, having had arrangements made for a conference with the general foreman the next day concerning the question of seniority which he agreed to adjust. Lodge No. 259 has a wide-awake shop committee and are always looking after the interest of the lodge and its members and deserve the undivided support of all the members.

That evening I left for Cumberland, Md., arriving there on morning of the 28th. In the evening I reorganized Lodge No. 577. At this meeting two more boiler makers reinstated and two helpers were initiated. On the 29th held a meeting in South Cumberland at which 16 boiler makers, 1 apprentice and 1 helper paid their reinstatement fee and 8 new applications of helpers were received and forwarded to the I. S. T., \$94.80 for supplies.

On the 2nd of February went to Keyser made out the new due books and opened out the ledger, attended meeting in the evening and instructed officers in their work; much interest was displayed in this meeting and it is to be hoped that the same spirit will continue and the lodge will prosper. On the afternoon of the 3rd I held a meeting for the night men of the B. & O. shops at which 9 were present who signified their willingness to affiliate and agreed to pay their fee the following day. On the 5th attended a meeting of Lodge No. 577. While this is not a large lodge I am of the opinion that it will be a very good business lodge and will profit by the error made in the past which caused its suspension. On the 8th I held a meeting of Lodge No. 332 and reorganized same, electing a good set of officers who I believe have the interest of the movement at heart and will make a success of the lodge. On the evening of the 9th met the financial secretary at his home and instructed him in his work.

On the 10th I went to Hagerstown, in the evening met several of the committeemen and arranged for a federation meeting. On the 11th attended the meeting of Lodge No. 578, which was well attended and meeting conducted on business lines. On the evening of the 12th addressed federation meeting. On the 13th returned to Cumberland to attend the Western Maryland Railway System Federation called for the 13th and 14th. At this meeting a new schedule was drawn up and considerable other business transacted. On the 15th held another meeting of Lodge No. 332. Up to this time 11 additional members being added to the list, making a total of 39 members, leaving about 15 that have as yet not affiliated. On the afternoon held a meeting for the night men. Those present assured me that all the night men would soon be in line.

On the 17th I left for my home arriving

there on the 18th, where I got out copies of the new schedule for each of the five international offices, railway department and the secretary-treasurer of the system federation, and forwarded \$28.40 to the I. S. T. for additional supplies for Lodge No. 332.

On the 22nd I left for Lima, O., to try and get the men in the Lima Locomotive Works interested in organization. On the 23rd attended meeting of the Central Trades Council. On the 25th attended meeting of Lodge No. 259, at which many matters of vital importance to the lodge were brought up and a special meeting was arranged for Sunday, March 7th. The lodge gave a dance at the auditorium on the 24th which was a success in every way, and the committee in charge is to be complimented in the way they conducted the affair.

On the 26th I left for Louisville, Ky., to attend a hearing held by the Executive Board of the Central Trades Council on the 27th, in regards to the actions of the business agent of the council and the business agents of the Building Trades advising a brewer that it would be all right for him to let the contract for two boilers to the Henry Vogt Machine Co., one of the most unfair firms in the country against organized labor. Last November I secured an affidavit from this brewer to the above facts. About four hours' time was consumed in the hearing and about 12 witnesses were heard. The executive board is to report its finding at the next meeting of the council, March 9th.

March 1st I returned to Lima, O., to take up my work there again. This concludes my report to March 1st.

With best wishes and regards, I am,

Faternally yours,
J. F. SCHMITT.

A COMMUNICATION FROM THE SECRETARY OF THE AUSTRALIAN SOCIETY OF BOILER MAKERS.

Note.—The following interesting communications from Mr. John O'Toole, secretary of the Federal Council of the Federated Society of Boiler Makers and Iron Ship Builders, were received by the Editor and are reproduced for the benefit of our members. The work mentioned in the last communication refers to a blast furnace gotten out here and being erected in Australia.—The Editor.

Office, 81 Darby St.
Newcastle, Jan. 26, 1915.

To James B. Casey, Esq.,
Editor-Manager Boiler Makers and Iron Ship Builders, etc., of America.

Dear Sir and Brother:

I have to acknowledge receipt of your letter dated December 2, 1914, also of your three Journals and the copy of your Constitution, all of which I have read with considerable interest, and for which I desire to express my sincere thanks.

I also have to thank you for your intention to put me on your mailing list, a compliment which I shall not forget.

I think I mentioned in my last letter that we were having our rules revised to bring them up to date, and I am now in a position to forward you a copy of the draft which is being placed before the members for adoption.

The photographs of the various Labor Day celebrations of your members is interesting. In this country instead of having one day set apart, each of the important centers have a celebration of their own, held on different dates, the day being known here as Eight Hour Day. The usual procedure is to have a large procession of the workers all marching behind their respective trade banners, with artistic and working displays incidental to the trade or occupation that the respective members follow. Then follow a sports program, at which everyone can have a good day's fun, Political speeches are also an order of the day. A committee of all the trade unions in the district where the celebration is to be held arrange all matters in connection with these demonstrations.

Prizes are given for the best displays and to the unions having the largest number of members in the procession, and for having the greatest proportion of members present, this latter arrangement gives a small union the same chance of securing a prize as the large ones. I am pleased to say that my branch at Newcastle secured the prize last demonstration for having the largest number of members in the procession, this being an item which is keenly contested each year.

There is one peculiar thing in connection with these celebrations and that is, that we have not had an Eight Hour Act placed on our statute books yet, although the majority of us have an eight hour working day, or rather a 48-hour week.

I believe that four or five eight hour bills have been through our State Parliament and have been thrown out by the upper house.

There is another one ready now to run the gauntlet. I see no account of the membership of your organization in any of the Journals; it must be very large, judging from the great number of locals you have.

The ladies' auxiliary lodges seem to me to be a great idea, with their winning ways they should be able to assist the organization considerably.

Up to the present we have not had any control over our helpers, they having a powerful organization of their own, but we intend to take the feeling of our members on the question of amending our Constitution so as to take them in.

I inclose the back portion of the envelope covering your last letter, with an inscription placed thereon by the postoffice officials, the postage to Australia being 2½d per ½ ounce; this would be equivalent to your 5c stamp.

Trade is a bit easy in Australia just at present, although we have nothing much to complain of in that respect, a great number of laborers are, of course, unemployed and some hardship exists among them.

I shall be glad to correspond with you regularly and to afford any information regarding local conditions which might interest you.

With fraternal greetings from Australia,
I am, Yours faithfully,
JNO. O'TOOLE,
Council Secretary.

Office, 81 Darby St.
Newcastle, Feb. 8, 1915.

To James B. Casey, Esq.,
Editor-Manager Boiler Makers' Journal,
Kansas City, U. S. A.

Dear Sir and Brother:

Under separate cover I am forwarding you some copies of the balance sheet and annual report of my society for the year 1914.

I am further pleased to report that trade continues good with us and no hardship consequent upon unemployment has been reported so far.

I think I mentioned in my last letter that we had a large iron and steel works under construction in this district, and in this connection I am forwarding you portion of one of our newspapers containing some illustrations of it, which may be of interest, seeing that the whole, or practically the whole, of this work was made in the United States of America and imported here for erection.

There are at the present time about 1,100 men engaged on the works, so that you will see that it means a good deal to a place like this. My men were receiving 16/- per day up to the war condition setting in; they now receive 12/4, the previous wage being the highest recorded in N. S. Wales. They expect to be running metal next month; the finished plant represents four furnaces, so there is plenty of construction work ahead of us yet.

With best wishes to yourself and brethren.
Yours fraternally,

JNO. O'TOOLE.

PROPOSED AMENDMENT TO THE CONSTITUTION.

Livingston, Mont., Jan. 22, 1915.

Mr. J. A. Franklin,
International President,
Kansas City, Kas.

Dear Sir and Brother:

The following is a "Resolution," unanimously adopted at last regular meeting, and whereby I was instructed to send you a copy of same, requesting that you have it printed in our official Journal in the proper manner, so that the rank and file may vote their sentiment on the question embodied therein:

RESOLUTION.

An act to amend Article V, Section 3, of the Grand Lodge Constitution.

PREAMBLE.

Whereas, The San Francisco Convention increased the salary of the Grand President at a time when conditions of the trade, country and Grand Treasury did not justify it, and

Whereas, Conditions of the country and trade are growing steadily worse; and

Whereas, We believe the increase unwarranted, and excessive, as compared to the earnings of the average boiler maker or ship builder; and

Whereas, We believe the membership as a whole are not satisfied or would not have granted this increase, but that it was granted by a "machine controlled convention," with the majority of the members not represented; and

Whereas, The next convention will not meet until 1917, that this great wrong may be righted, and honesty and justice to all may prevail, we, the members of Subordinate Lodge No. 123, in regular meeting assembled, do hereby demand that the Grand President order a referendum vote on the question to strike out the words "twenty-four hundred dollars," in Article V, Section 3, lines 10 and 11, of our Grand Lodge Constitution, and insert the words "eighteen hundred dollars" in lieu thereof.

Fraternally submitted by

LODGE No. 123,
Theo. W. Evert, C. and F. S.

Kansas City, Kas., Feb. 19, 1915.

To the Officers and Members of All Subordinate Lodges, Greeting:

Gentlemen and Brothers:

In reference to the foregoing letter and resolution from Lodge No. 123, of Livingston, Mont., proposing an amendment to Article V, Section 3, of the Grand Lodge Constitution, you will be governed by Article III, Section 1, in considering this proposition.

Inasmuch as the law requires that a proposition for legislative enactment shall be published in the official Journal for two months, which notice must expire at the end of the month in which it was published, and in accordance with this provision all votes must be in the hands of the International Secretary-Treasurer not later than the tenth (10th) day of May. In the event the resolution shall be 20 per cent indorsement, the proposition will then be submitted for a referendum vote.

In voting on this, remember this is a lodge vote and requires majority of the lodge, either for an indorsement or rejection of the proposition. The vote is to be returned to the International Secretary-Treasurer in accordance with Article III, Section 1.

I regret very much that the fourth "whereas" in the foregoing resolution contains such a glaring misstatement of facts, and it becomes my duty to challenge the statement that the action of the San Francisco Convention was controlled by a machine.

No more bare-faced falsehood or misrepresentation of facts could be made by anyone.

I refrained from placing International officers who were regularly elected delegates upon any committee as far as possible, and to my knowledge no undue influence was used or attempted with any committee. I did not personally appear before any committee at any time except when requested to do so by the committee themselves.

It appears that there are those among our members who, when unable to secure favorable action upon propositions favored by them personally, or to defeat matters proposed by others, immediately become disgruntled and, through a lack of any logical reason resort to slander and a misrepresentation of facts.

I feel that as a matter of justice and in order that those of our members who may not have read the proceedings of our convention, with reference to the action taken in amending Article V, Section 3, that after the amendment was carried by practically a unanimous *vive voce* vote, and hearing some objections on the part of a few of the delegates, I voluntarily threw the matter open for reconsideration on the floor of the convention, and, after a free and unlimited discussion, a roll call was taken, which resulted in a vote of 167 in favor and 87 opposed.

I desire to further call attention to the fact that the question had been disposed of and could not be reopened under parliamentary law, and that my action in placing it again before the convention was purely voluntary.

I regret that it becomes necessary to mention these facts, but in the face of the gross misrepresentation made in this resolution, also in other articles from the same source, these statements could not consistently be permitted to go unchallenged. The records of the convention will bear out every statement contained herein.

Assuring you, one and all, of my kindest regards, I am,

Fraternally yours,

J. A. FRANKLIN,
International President.

PROPOSED AMENDMENT TO THE CONSTITUTION.

Winnipeg, Man., Can.

Mr. J. A. Franklin,
Kansas City, Kas.
Dear Sir and Brother:

Please find inclosed resolutions drawn up by Lodge No. 126, which I hope you will give your kindest attention.

With best wishes and kindest regards, I beg to remain,

Yours fraternally,

A. B. PAGE,
Cor. Sec'y. Lodge No. 126.

Whereas, The Constitution of this Brotherhood does not make ample provisions for

the removal of Grand Lodge officers unless charges are preferred against them, and

Whereas, Causes sufficient for the removal of an officer, does not necessary provide grounds for charges being made, N. B., incompetency, etc., and

Whereas, The time set for holding conventions having been extended from two to three years, we think that provisions should be made whereby the rank and file will have some control over Grand Lodge officers between conventions; therefore, be it

Resolved, That Perseverance Lodge No. 126, place before the Brotherhood the following recall provisions as an amendment to the constitution for their approval.

Recall Provision.

(a) Any subordinate lodge in good standing in this Brotherhood shall have the privilege of proposing the recall of one or more Grand Lodge officers through the referendum, by submitting to the International President a proposition naming the officer, or officers, whose recall is desired, giving specific reasons for the issuance of such recall, who, on the receipt of same, shall at once order it published in the official journal for two (2) months, which notice must expire at the end of the month in which it was published. Lodges may vote up to the end of that period.

(b) All lodges voting must make return of their vote in ten (10) days after the close of the voting limit, and if twenty (20) per cent of the lodges in good standing and voting at the time to indorse it, the International President shall immediately notify the officer, or officers, whose recall is proposed, said officer or officers, shall have the privilege within ten (10) days of receipt of such notice, to submit to the International President a written statement in his own defense, such statement shall not exceed three hundred (300) words, who shall order it published in the Journal at the same time as he issues the ballots for the recall of said officer, or officers, to all the subordinate lodges in good standing for their suffrage.

(c) If the proposed recall receives a majority of all valid votes cast and returned within sixty (60) days, providing that the total vote cast shall be equal to at least fifty (50) per cent of the members in good standing as shown by the proceeding quarterly report of the International Secretary-Treasurer. The services of the officer, or officers, whose recall has been decided on, shall immediately terminate, and his or their successors shall be appointed as per Article V, Section 5.

Reasons Why We Should Have the Recall.

In view of the fact that it is only recently that this Brotherhood held its convention, a short explanation as to why Lodge No. 126 desires a constitutional amendment at this time, will not be amiss.

According to our constitution and the verdict handed down by the executive council at their annual meeting held in Kansas City, October, 1914, to Lodges No. 126, No. 451

and No. 529, an officer cannot be removed unless convicted of certain charges, inefficiency does not constitute a charge, so it does not matter how incompetent an officer may be, unless charge of dishonesty, etc., can be brought against him, the organization is compelled to carry him on the pay roll, until he can be legally removed at the next regular convention, which does not take place until September, 1917, or by the calling of a special convention, which would be too costly a procedure for the removal of probably a single officer.

When conventions are held at such long intervals as ours, it is essential that provisions should be made for the removal of officers when deemed necessary.

The extension of the time between conventions were considered after the referendum had been disposed of, the recall was not even discussed, or probably it might have been inserted in the constitution at that time. Be as it may conditions have arisen in this part of the country that evidently can only be removed by inserting a recall provision in the constitution, or by waiting another three years and once again attempting to get the desired change, and we do not feel inclined to wait that length of time. The growth of the organization is being retarded, and it is imperative that something should be done.

Let us consider the question from the viewpoint of democracy; we are supposed to live in a democratic country, and we gradually see a determined desire on the part of the people to gain more and more control over public officials, and the means to that end is through direct legislation, referendum and recall, etc. Very, very few workers, especially members of organized labor, are opposed to the recall of public officials, and due to that fact we have provisions for the recall of public officials on the statute books of many cities, counties, states, etc., and many of the trade unions have followed suit; it had proved a success in cases too numerous to mention, that we see no reason why it cannot be successfully worked out in our Brotherhood.

Then again through the referendum and recall you have a far better representation of the intelligence of the members in the organization, which in the last analysis is the real intelligence of any organization.

The oft repeated argument against the recall, is that only a small percentage of the membership take advantage of it. While it is true to some extent, that although every member is entitled to vote, they never do so, we must remember that any proposition enacted by referendum requires a voting power of at least fifty per cent of the total members in good standing before it can become law. So it does not matter how low the voting figures in favor of a certain proposition go, there is a limit beyond which it can't go and become law, and the lowest possible figure is higher than that required at conventions for the enactment of laws.

Let us see what percentage of representatives we have at conventions, taking the last convention as a criterion. We had three hundred and forty-two (342) lodges in good standing according to the September report; out of that number eighty (80) lodges were represented at the convention, roughly figuring, one hundred and twenty (120) delegates represented the eighty lodges. We have somewhere around sixteen thousand (16,000) members, which gives us the following percentage: Eighty (80) lodges out of three hundred and forty-two (342), twenty-two (22) per cent, one hundred and twenty (120) delegates out of a total membership of sixteen thousand (16,000), less than one per cent. So it can readily be seen where the correct expression of the organization lies.

This is not a kick from a few disgruntled members, but is the unanimous verdict of all the lodges in this city, and we are prone to believe that if the grievances turned down by the executive council, as being not based on facts without any investigation on their part, were placed before all the affected lodges in Canada, that they could substantiate all the claims that we have made and properly add a great deal more to them.

We ask you to give this amendment every consideration, if the recall is not the proper method for the removal of an officer when deemed necessary between conventions, then please enlighten us as to the proper method. We have tried every other means within our knowledge and failed. Hence the reason for this resolution and proposed amendment to our Constitution.

Respectfully submitted,

C. DAVIS, President.

A. B. PAGE, Cor. Sec'y.

KANSAS CITY, KAS.

To the Officers and Members of All Subordinate Lodges:

Greeting:—The foregoing letter and resolution received from Lodge No. 126, contains a proposition to amend Article III, Section 1, and is published in accordance with Article III, Section 1. In considering this matter you will be governed entirely by Article III, Section 1, and all votes from subordinate lodges must be in the hands of the International Secretary-Treasurer not later than the 10th day of May. Any votes received after that date will not be counted. You will remember, when voting on this proposition that it requires a majority vote of your local to indorse or reject and if the result should be a twenty per cent indorsement of all lodges in good standing, the proposition will then be submitted for referendum vote. With very best wishes, I beg to remain,

Yours fraternally,

J. A. FRANKLIN,
International President.

Correspondence.

FROM THE RAILWAY DEPARTMENT. St. Louis, Mo.

The question of formulating a plan of organization that would insure united action among the railway employes has been under discussion for many years, several experiments were in a manner tried out and while not wholly successful, each in its turn contributed to the upbuilding of the present day organization.

In the early eighties the plan of organization as exemplified by the Knights of Labor and applied to railroad employes was given a thorough trial, but for reasons with which all students of the labor movement are now quite familiar, this plan failed of success. Then for a brief period early in the nineties two plans were tried out, the first, resulting in a compact being entered into by the machinists, boiler makers and blacksmiths, three of the craft organizations which again came into existence as a result of the K. of L. failure. These crafts perfected a federated plan of organization on two of the largest western railways and as a result of their efforts to improve the conditions of employment, became involved in strikes in May of 1893, both of which were successfully conducted, resulting in substantial concessions being obtained; about this time the second plan commenced to gain headway in the form of an industrial organization under the name of the American Railway Union, and for a short period flourished, only to meet the fate of the K. of L. in the great railway strike of 1894. This movement had gained such headway that its collapse almost resulted in the complete disintegration of the craft organizations of the shopmen, as well as seriously affecting the transportation organizations, the result being that the adherents to the plan of craft organization were again in the ascendancy, and from that time on have grown steadily; for a number of years they have continued to prove their value, as evidence of which we point to the many concessions obtained in the form of improved working conditions and rates of pay for their respective members, but at no time were these organizations free from agitation within their ranks for closer affiliation. The success of the joint craft action of 1893 had not been forgotten, early in 1905 these organizations began to form what were termed voluntary system federations, under the sanction of the General Officers, during this period the railroad officials were also getting closer together and finally organized under the name of the American Railway Association.

The transportation Brotherhoods also formed a federation, but neither the engineers, firemen or trainmen's organizations became affiliated to the American Federation of Labor, while just the reverse was

true of practically all the other organizations.

In 1908 the sentiment for closer affiliation among the railway men had grown to such an intent that it resulted in the question being discussed by the general officers of the following organizations: International Association of Machinists; International Brotherhood of Boiler Makers; International Brotherhood of Blacksmiths; Switchmen's Union of North America; Brotherhood of Railway Clerks; Order of Railroad Telegraphers; Brotherhood of Freight Handlers; Brotherhood of Maintenance of Way Employes, and several others who were in attendance at the A. F. of L. Convention, held in Denver, Colo., Nov. 1908, which resulted in the tentative formation of the Railroad Employes Department.

The aims and objects of the Department as set forth in the resolution presented to the Twenty Eighth Annual Convention of the A. F. of L. and indorsed by the presidents of the above organizations, was for the purpose of enhancing the welfare of all railroad employes, and to seek to affiliate the unaffiliated with the American Federation of Labor; to further the interests of the employes by means of legislation, and to take such action as might be necessary to protect their interests. The resolution was carried by unanimous vote of the convention.

The first convention of the Department was held in Denver, immediately after the close of the American Federation of Labor Convention, and as the preliminaries could not be finished there, an adjournment was taken to meet in Chicago, January, 1909. A constitution was framed and adopted and the following officers elected: H. B. Perham, chairman; A. B. Lowe, vice-president; D. W. Roderick, secretary-treasurer.

For several years the officers devoted their spare time to disseminating literature describing the Department and its aims, and creating sentiment in favor of organization and federation.

While the Department had so far performed its functions in a way proportionate with the limited time and attention the officers were able to devote to its advancement, inasmuch as their services were gratuitous, it had failed to meet the growing demand of the memberships for a more militant form of organization in keeping with the requirements and to conserve the best interests of a majority of the affiliated crafts, the best evidence of which was found in the increasing number of voluntary system federations organized outside and independent of, and declining to affiliate with the Department. This could be accounted for in no other manner than that the policy of the Department up to this time had not fulfilled the desires of the rank and file

who were evidently determined to bring about the formation of an organization, which in addition to its educational and legislative functions, should extend its scope to include joint action in all its offensive and defensive activities, at the same time recognizing craft autonomy.

In the southeastern states, the members of the railway shopmen's organizations were particularly active and the idea of forming system federations reached a point that led to the formation of an organization known as the Southeastern Consolidated Federation of Railway Shop Employes, which embraced practically every railway system in the southeastern states and was the first of its kind ever organized by the railway shopmen.

The sentiment for this change had grown so strong that it culminated in a meeting being arranged and held in Milwaukee, Wisconsin, May, 1911, by a number of representative men from one craft, on the lines running west of Chicago. A resolution was drafted and sent out to all local lodges of the Machinists, Boiler Makers, Blacksmiths, Brotherhood of Railway Carmen and Sheet Metal Workers, requesting that they instruct the delegates to their next International Convention to vote and work for the indorsement of a plan to call a convention for the purpose of forming a federation that would meet the insistent demands of the members. This plan was maturing as rapidly as the International Conventions were being held, and by September 1911, the three organizations holding conventions had approved the proposition.

In the meantime a very serious situation had arisen on what was known as the Harriman and Illinois Central Systems comprising some eleven roads. The shop crafts on these systems had recently formed one of the many voluntary federations, then in existence, and on presenting a proposed joint agreement had been met with a flat refusal by the officials who declined to either meet or treat with a joint committee. This resulted in what has been termed as a lock-out of some twenty-eight thousand men. The term lock-out is used because the officials had taken the position that they would not meet a committee selected by the men, and if this position had been accepted, the question would revert to what kind of a committee the officials would meet and if the employer was conceded the right to dictate the personnel of the employes committee, the usefulness of the employes' organization as a means of protection had passed. This resulted in the men being forced to fight for the right to maintain the form of organization they deemed necessary to their success.

As a result of this unlooked for situation affecting so many thousands of the members and primarily for the purpose of rendering all possible assistance to the locked-out men on the Harriman and Illinois Central Lines, a conference of craft

representatives of all Western Lines was called by the general officers of the interested crafts to meet in Kansas City, Mo., in April, 1912. This conference was composed of representatives from System Federations, and craft district organizations, some forty systems of railroads being represented. The conference remained in session almost two weeks and among the many important matters acted upon was the adoption of a constitution and by-laws for an organization to be known as the Federation Federations.

This plan of organization was entirely different from that adopted by the Railroad Employes Department, in that it provided for a delegate convention composed of representatives elected by the respective members, salaried officers who should devote their entire time to the Federation of Federations, and a complete change in defensive and offensive tactics; whereas the Railroad Department, as organized at the Denver Convention of the A. F. of L. suggested only voluntary joint action of the affiliated crafts and provided for educational and legislative propaganda.

This meeting being brought about as before stated, together with the fact that the merging process that developed later was unforeseen was responsible for the failure to at that time extend a general invitation to all lines to participate.

The following officers were elected: A. O. Wharton, president; G. W. Pring, vice-president; John Scott, secretary-treasurer.

The delegates instructed the officers, including the Executive Council Members, to meet with the Executive Council of the A. F. of L. at the earliest opportunity for the purpose of securing a charter; the desired result was obtained in November, 1912, at the regular convention of the R. E. Department in Rochester, N. Y., by adoption of the laws drafted at Kansas City, with but few changes. The officers elected by the Federation of Federations were again elected by the reorganized department to avoid any technicalities.

With the adoption of new laws and acting in conformity with the rulings of the American Federation of Labor, the Department was confronted with many problems; First, to acquaint the

To be continued in next month's Journal).

SAPULPA, OKLA.

At our last regular meeting February 22, 1915, Creek Lodge No. 449, of Sapulpa, Oklahoma, the following resolutions were adopted:

Whereas, It has pleased our Heavenly Father to take unto Himself the beloved mother of our esteemed brother, F. R. Vest, be it

Resolved, That we, the members of Creek Lodge No. 449, extend to Brother Vest and family our most sincere sympathy, and may the memory of her faithful Christian life and loving mother care comfort and console

them in this sad hour of bereavement And be it further

Resolved, That a copy of these resolutions be sent to our bereaved brother, a copy spread upon our minutes and a copy forwarded to our official Journal for publication, and our charter draped for thirty days.

D. A. CLIFTON,
IRVIN SHIPMAN,
Committee.

CUSHING, OKLA.

To the Officers and Members of All Subordinate Lodges, Greeting:

At a special meeting held in Cushing, Oklahoma, March 3, a motion was made as follows:

Moved and seconded that on and after March 2, 1915, no more clearance cards will be accepted by this lodge until the end of the strike and conditions are again normal. Grand Lodge to be notified accordingly, so that they can advertise through the next issue of the Journal and otherwise keep members on the outside away from here. (Carried.)

This does not include traveling brothers who want to pay us dues and leave here again.

Trusting this is satisfactory and with best wishes, I am,

Yours fraternally,
WALTER CARRIGAN,
Recording Secy., Lodge No. 592.

Pittsburgh, Pa.

To the Editor:

Brother C. J. Maes, who is the author of an article in the March Journal favoring a reduction in salary of our President prefaces his article by using the following:

"Now I shall endeavor to be fair and just," therefore, my deduction of this paragraph would leave the inference that the writer is deviating from his former practice, also that he will only endeavor to be fair and just. He is not positive that he can be. The undersigned quite agrees, after a careful perusal of his article, that he would have to use great efforts in order to adhere to the lines of fairness and justice, for the following reasons.

First. He attempts to voice the sentiments of the rank and file prior to giving the rank and file an opportunity to voice their own sentiments. Our referendum laws will permit the membership to voice their sentiments, and then, and then only, will we be able to ascertain their sentiments relative to the reduction in wages.

Second. In order to bolster up his sentimental arguments he attempts to voice the sentiments of the unfortunate tourist who sometimes uses the side door palace car and who invariably is classified as a boomer. Does the writer speak authoritatively when he includes the boomer as being dissatisfied with the salary and expenses of our President? If so, he has very little conception of the principles of the boomer.

The boomer is always found booming and boosting, and never knocking. He realizes what a national officer has to contend with. He knows the amount of money he has to spend from time to time, which cannot be put in his expense account, but must be taken from his own pocket. He is also not unmindful of the fact that a President of a National Organization, who has the ability to meet in conference the officials of large corporations, who receive \$20,000 a year as salary, and plead the case of the boiler makers in an honest and intelligent manner, is entitled to far more than he is receiving at the present time.

In looking over the expense account of our National President, together with his salary, I find that it is less than 25 cents per member per year. Will Brother Maes, whose heart bleeds so for the poor boomer and the men on the picket line, petition by referendum a reduction that would mean 3½ cents a year less for the membership?

Our organization is known as the cheapest organization in the country when it comes to pay salaries to its employees, as very nearly every International President is receiving from \$2,400 to \$10,000 a year, except our President. They are also allowed liberal incidental expenses.

It would be real nice to see our President riding all night in a day coach, striking a bean wagon in the morning for his breakfast, washing his face in the station and then proceed to the office of large corporations and pitting his brains against those receiving \$20,000 a year, in his efforts to defend our interests.

Why doesn't Brother Maes present a resolution asking for a referendum vote to amend our constitution so that instead of electing officers we can advertise for the lowest bidder who would be willing to serve in that capacity at the lowest possible cost, but in so doing, let him voice his own sentiments, not the sentiments of the men at the picket line, boomer or the rank and file, because the rank and file believe there is nothing too good for our organization. They do not believe in second-hand goods nor second-hand officers. Cheap officers, cheap organizations, result in poor conditions.

With best wishes, I beg to remain

Yours fraternally,
T. H. FLYNN,
Member of Local Union No. 154.

Brainerd, Minn.

Dear Sir and Brother:

It is obvious that the action of our executive council in disposing of the question of amalgamation without serious consideration has resulted in the very situation evidently sought to be avoided—study and free discussion of this much mooted question.

Now, brothers, whether amalgamation would be beneficial or harmful is something that experience alone can prove. But nothing but good can be derived from careful

study and free discussion of this and all other topics that are within the sphere of the labor movement. Sarcastic and contemptuous statements do not enlighten us and they should be strictly avoided by the officials and members. I regret that our President should ridicule the position of members on this question. It is of no benefit to us to hear that so and so was in the movement when somebody else was in swaddling clothes. What we want is sane and revelant argument.

Now, brothers, if our organization is not subject to the laws of evolution, if it is steadfastly anchored for all time to the "pure and simple" individual craft organization, then it is a waste of time to discuss progress, but we all know that this would be utterly absurd, for nothing stands still. We must either advance or retreat. This being an axiom, it is very proper for us to map out a plan of advancement along proper channels and to keep pace with the developments of industry.

One fact, my brothers, has been sufficiently demonstrated to us, and that is, as an individual craft we cannot force any railroad company to grant our demands. Is that not so? It is, for we have been compelled to federate in order to accomplish anything. Now by system federation, we take a step in the direction of amalgamation, but it is not enough. We must go on.

Under federation a number of crafts agree to act together for a common purpose, but the unity of action is very limited, for it only applies to numbers, the important factor is overlooked, FINANCE. This is fully demonstrated in the federated strikes now on. The organization with strong finances back of it is better equipped for the struggle. Now in these strikes we combine numerically, which leads to final amalgamation. Why? Because if it is expedient to combine or unite in part, the same principle extended means greater power and larger benefits to be derived. Why should we strike together for a common end and still persist in wasting the greatest factor in determining the result of the struggle.

Take our "Metal Trades Crafts" alone. Say ten crafts go out on a federated strike. They maintain a set of federation officers and all the necessary equipment and at the same time they maintain ten international lodges with innumerable officers and all the necessary equipment, all totaling up an enormous, wasteful expenditure. I think \$100,000 per year would be a conservative estimate of grand lodge office salaries, not to speak of the numerous organizers, and it probably costs us considerably over \$500,000 a year to pay all officers, rent, Journals, etc.

I suggest these figures to illustrate. Now this is all duplication and a serious waste. We are crippled so financially by this system of organization that we have never been able to properly finance a strike. Is

this necessary? Cannot one set of grand lodge officers, offices and other necessary accessories perform the same amount of work more efficiently and at a greatly reduced expenditure? I fail to see why not.

This is the day of concentration and efficiency. If the same duplicating system were used in any of the great manufacturing plants it would mean chaos and bankruptcy. I care not what trade a man has, his interests are identical with his brother craftsman, and, therefore, the difference of trade lines are superficial and are not the insurmountable obstacles that we have been led to believe. Why, brothers, we fight our brother craftsmen and they fight us in the A. F. of L. and "Metal Trades Department" much more bitterly than we do the common enemy.

The "pure and simple" trades union of the past does not meet the requirements of today and those who insist that we perpetuate it are either blind to the changes that are taking place or else they act from selfish motives. So long as we remain split up into several parts so long will we be wasting our energies in jurisdictional disputes, dissension, strife and will end in ultimate defeat. Capitalists waste nothing on such foolishness as this.

There are a plentiful supply of sophists in our organization and they will attempt to check this tendency towards solidarity. Let every brother just think it over for himself. You have all had the experience and that is the best teacher of all. We all have an instinct that outreaches our intelligence or that of our teaching class, the instinct that we, as workers, are bound together in one common destiny, that the struggle for the future is one, and that there is no possible hope for us, save in our banding together into a solid phalanx. Solidarity of the workers. Therein lies our hope. Amalgamation is the next step. Shall we move up or keep slipping down grade? Which?

Faternally yours,
J. G. BROWN.

Parsons, Kaa.

At a regular meeting of Sunflower Lodge No. 7, Auxillary to the I. B. of B. M., I. S. B. and H., the following resolutions were adopted:

Whereas, God, Supreme Ruler of the Universe, has deemed best to call home the father of Sister Kate McMullen, be it

Resolved, That we extend to our sister our sincere sympathy for the loss of her beloved father, and we bow our heads in humble submission to the will of God, who knoweth all things best, and pray that he will comfort and console her; be it further

Resolved, That a copy of these resolutions be sent to Sister McMullen, one to the official Journal, and a copy filed among our records.

MRS. SMITH,
MRS. HOWELL,
MRS. WILLISIE,
Committee.

Cushing, Okla.

Dear Sir and Brother: I am mailing you three pictures Lodge No. 592 and myself would like to see reproduced in the April issue of the Journal.

We are desirous of letting the Brother-

hood know that while we are fighting seven of the largest tank building companies in the country against their open shop ideas, that we also have some fair jobs, strictly union and with bonafide members employed on same.

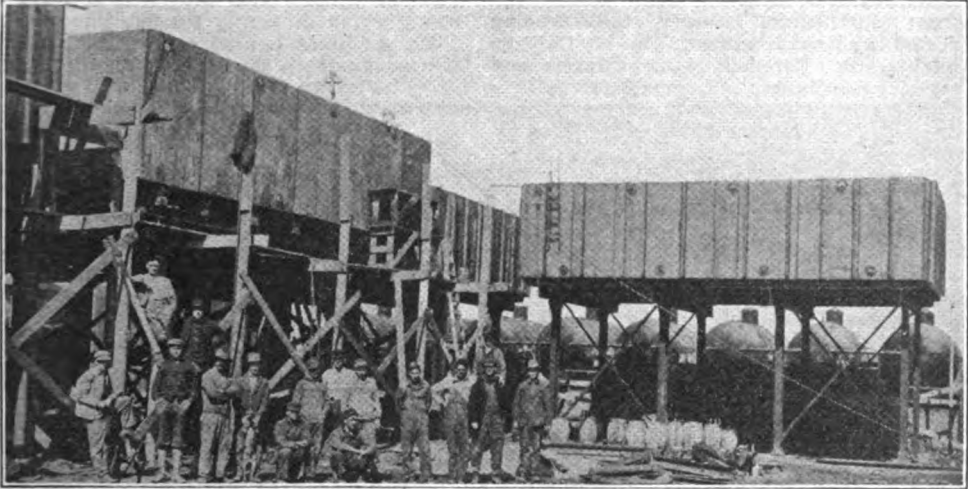

MEMBERS OSAGE LODGE No. 592, CUSHING REFINERY, FAIR JOB.



KENNICOTT'S CREW, MEMBERS OSAGE LODGE No. 592, CUSHING, OKLA., STRICTLY UNION JOB.



MEMBERS OF LODGE No. 592, ON STRIKE AT CUSHING, OKLA.

One of the pictures marked No. 1 shows a group of the members of Lodge No. 592 who are on strike against the seven large firms now employed at the Cushing refinery, Mr. McCabe, superintendent. The picture shows four large condenser boxes and a battery of stilles.

Pictures Nos. 2 and 3 show one of the large 55,000-barrel storage tanks being erected by the Kennicott Co. of Chicago Heights, Ill. Foreman, James Martin and

day, March 1st, we initiated three new members and balloted favorably upon three candidates, and in view of the fact that we have not lost one member through suspension during all those hard times, which shows very conclusively that the members of Lodge 318 are built of the right material and our officers from President Mertz down are working diligently for our interests.

To celebrate our success in maintaining our membership the entertainment commit-

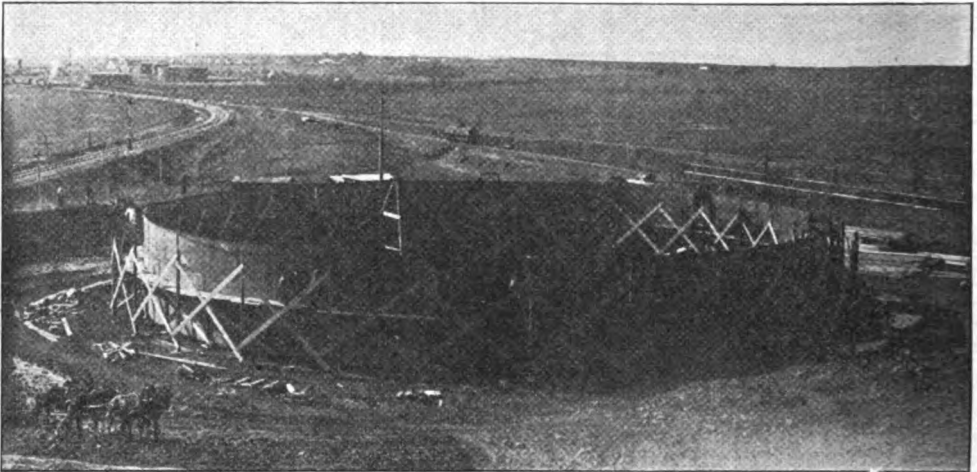

KENNICOTT'S JOB, CUSHING, OKLA., ONE OF THE FAIR FIRMS.

Bro. Mike Conroy. This tank was all hot riveted.

The group in No. 2 picture are all members of Lodge No. 592, also including President J. E. Dixon. This job is now complete but Kennicott has considerable more work here now waiting on rivets.

Trusting you will give us space in April issue for same I am

Faternally yours,

JOS. P. RYAN,
Eighth I. V. P.

Pittsburgh, Pa.

Editor of Journal: Perhaps the most conspicuous characteristic of Lodge 318 is our modest and retiring disposition, as in the past we have been content to do the very best we could to better working conditions on the B. & O. system, and in our own lugging way try to keep up with the procession, without the aid of a brass band.

We have decided to get away from the blushing debutante attitude of the past, bust into print occasionally, and let the Brotherhood at large know that we are on the union labor map, and not only holding our own but we are building up our local, despite the business depressions and the fact that we are idle three or four days a week.

Our organization committee is working the way an organization committee ought to work and at our last meeting held Mon-

tee arranged an enjoyable luncheon and smoker to take place after our regular meeting last Monday night. Practically our entire membership was in attendance and in addition a committee from Smokey City Lodge 154 was invited. Our International Vice President, Bro. Mike Maher, was unable to attend owing to pressing business elsewhere and his absence was a keen disappointment to our members, who hold Bro. Maher in the highest esteem and greatly appreciate his fatherly advice upon matters pertaining to our organization. Addresses were made, however, by Bro. Jas. P. Carr, business agent of Lodge 154, and Bro. Joseph Flynn, Joe Noble and James G. Sause, representing Lodge 154, and as a result it is believed a more fraternal feeling will exist between the two Pittsburgh lodges.

Pres. W. F. Mertz presided at the meeting and acted as chairman of the smoker in which dual capacity he acquitted himself in a manner highly appreciated by the members and visitors. The headliner on the program of entertainment, however, was our old friend, J. H. Scott, whose comical portrayal of Irish and German characters contributed greatly to the success of the entertainment and won round after round of applause.

It is our intention to give these entertainments occasionally as we feel that they enable the members to become better ac-

quainted and create a greater interest in our local among the non-union boiler makers and helpers in this vicinity.

In conclusion, we would advise all boiler makers and helpers to stay away from Pittsburgh, as 75 per cent of the card men in this vicinity are idle at the present time with no immediate prospects of better times coming.

The many friends of Bro. T. H. Flynn, general organizer for the A. F. of L., who has been seriously ill with pneumonia, will be glad to hear that he is slowly recovering.

Yours fraternally,
PRESS CORRESPONDENT.

Denver, Colo.

A condition has arisen in the metal industry which compels attention.

Labor saving machinery, together with system, is everywhere displacing skilled labor and substituting therefor the machine operator or specialist.

Specialization, made possible by the machine, increases the efficiency of labor many fold. Ten men, working as specialists and under systematic conditions, will take the place of several times as many men, working as craftsmen, each completing his own work. This means fewer men employed and a correspondingly larger number of unemployed, a condition very gratifying to the employer, hence his tendency to compel specialization and adopt systematic methods.

The result of these three industrial forces: machinery, specialization and system, is that craft lines are fast being obliterated. In place of machinists we have lathe men, boring mill men, drill press men, etc. In the place of boiler makers we have flangers, patchers, flue setters and so on. All the other metal crafts face the same conditions.

The most striking case is that of the acetylene and electric welders. They can not be classed in any craft group though they do the work of many. Another case is the flue welder—is he a boiler maker or a blacksmith?

Before the advent of the machine, when industry was carried on by the small individual capitalist, the individual workman was of comparative importance to his employer. They were personally acquainted with one another, often working side by side in the shop. His skill was a necessary part of his employer's business and he himself was, to a certain extent, independent, but when machinery was introduced and industry grew, the individual employer was succeeded by the stock company and corporation. The individual worker became relatively of less and less importance. The result was, that the individual worker was forced to unite with his fellow workers in the craft union in order to successfully combat the increased power of the employer. He was no longer working for a man, a human being like himself who knew and

liked him, or at least respected him, he was working for a company.

Again industry took a step forward. The modern ~~that~~ took the place of the company, the crude machine became the modern labor saving device and the skilled worker is steadily being displaced by the specialist who must speed up to keep pace with the machine he operates.

The workers' form of organization alone remains stationary.

The employers are organized as employers to protect their interests as employers and it behooves the workers to organize as employes and cease to allow themselves to be split up in craft unions, supporting as many headquarters in as many different cities as there are craft organizations.

For these reasons the following resolution was adopted by No. 179 I. B. of B. M. I. S. B. and H. of A.:

Whereas, The interests of the workers in the metal trades demand a closer affiliation of the metal trades, and

Whereas, The I. A. of M. has, by referendum vote of the membership, indorsed the proposition of amalgamating the metal trades; therefore, be it

Resolved, That we, Local No. 179 I. B. of B. M. I. S. B. and H. of A., go on record as indorsing the movement and render whatever aid we can in bringing about such amalgamation. And be it further

Resolved, That a copy of these resolutions together with our reasons therefor be forwarded to the executive council and to Local No. 47 I. A. of M. and published in our Journal.

GEO. GAUSS,
President.
H. SHAFFROTH,
Secretary.

Cincinnati, Ohio.

Dear Sir and Brother: To the members of the Brotherhood, greeting:

In reading the March issue of our Journal I took particular notice of the communication from Local 123 inserted therein. Regarding their resolutions to the proposed amendment of Article V, Section 3, lines 10 and 11, of our Grand Lodge Constitution:

Now such matters as this ought to be of great interest to every brother who is affiliated with our organization, inasmuch as it refers to our Grand President whom we should at all times give our earnest cooperation not alone in such matters as this, but in every way we possibly can.

I have never had the honor or the pleasure of attending one of our international conventions, but I feel certain that they are always well conducted and I also feel sure that everything that was done at our last convention in San Francisco was performed in a legitimate manner, and it strikes me that Local 123 is making a very broad statement when they say that it was a "machine controlled convention," which if not true,

may cause no end of trouble, because such assertions as this only tend to retard our progress by causing internal troubles. And in Bro. Franklin's reply, he states that under the parliamentary rules, he was not compelled to do so, but he did "voluntarily" open up the matter for reconsideration, and I think that this action alone on the part of Bro. Franklin, regardless of anything said to the contrary, ought to convince the rank and file of our organization very conclusively that this matter was open and above board, and could not have had the slightest tinge of deception attached to it. Personally, I can't see where Bro. Franklin is receiving one cent too much for his salary. We should place our organization in the light of a business proposition, and pay our executives in proportion to the work attached to their positions. Just stop and try to think for a minute the amount of work that must naturally devolve itself upon the Grand President and also think of the number of things he must have on his mind, one trying to crowd the other out, I dare say they are very seldom of a pleasing nature, they are more apt to cause loss of sleep and gray hairs. Now in my estimation, the number of our Vice-Presidents is too great, and I would suggest if it would be orderly for me to do so, that while times are so hard, as they are at present, that we cut down the number of our Vice-Presidents to five, and in that way we would be able to reduce the expenses of our Grand Lodge treasury to quite an extent, and if the occasion should present itself that we need a man in the capacity of a Vice-President why then our Grand President could appoint a man for that purpose until the matter was completed.

Now the matter of reducing our Grand President's salary is to be taken up by all the subordinate lodges, and every brother should vote according to his own convictions. Brothers, I am not writing this article in defense of our Grand President, as I don't think that Bro. Franklin needs any defense at my hands, nor do I wish to start a lengthy discussion of this matter through our Journal as a medium. I am only stating my personal views on this all important subject, and earnestly hope it shall not be the cause of any ill feeling among the Brotherhood, so hoping this letter will be received in the same spirit which prevails while I am writing it, I wish to submit same to our valuable Journal.

With best wishes and kindest regards to all, I am
Yours fraternally,

W. J. McGEE, JR.,
S. T. Dist. 29.

Valley Junction, Iowa.

Dear Sir and Brother: Local 491 would like to have the following brothers communicate with it:

John Crawford, Reg. No. 62321; John Peters, Reg. No. 80223; Jas. Regan, Reg. No. 95180; A. J. Wagner, Reg. No. 67150, and J. M. Morgan, Reg. No. 91068.

The following ones have left bills unpaid and should be shunned by desirable citizens: W. J. Mills, No. 98504 H. D. with ~~withdrawal~~ card out of Local 145, Missouri Valley, \$6.40, unpaid; C. A. Riley, no card H. D., paid \$2.00 for first payment for initiation. About 32 or 35 years old, 5 ft. 6 in., weighs 160 or 170 lbs., smallpox marks, talks rather fast. Keep your hands on your pocketbook should you see such lurking around. Think he is in the oil fields. Bill \$4.25. Geo. B. Lewis, No. 99351, H. D. from Harrison, Ark.; come clean, George. Bro. C. E. C. Bruks who was in Boone, Ia., last heard of and left here about Sept. 17th. Please raise your feet. A. J. Connelly, number unknown, here in July, 1914, please write.

Local 491 fully expects the return of courtesy when she so liberally shows same, so kindly communicate before we have to advertise you again.

Fraternally yours,
JAS. J. CARROLL,
F. S. L. 491.

RESOLUTIONS.

Whereas, a communication has been addressed to the International Brotherhood of Boiler Makers, Iron Ship Builders and Helpers of America by the International Association of Machinists advocating the amalgamation of the various metal trade crafts of America, and

Whereas, this idea has been approved by a referendum vote of the machinists' organization, and their officers have been instructed to make known their sentiments to the different crafts of the metal trades, and

Whereas, said communication has not been submitted to our organization as a body, nor has it been published in our official Journal as requested, but our executive council has taken it upon themselves to decide this important question without the knowledge of the rank and file, and

Whereas, an editorial appeared in our Journal in the December issue ridiculing this suggestion of amalgamation, and showing gross discourtesy and ill-will to our brother craftsmen, also insidiously attempting to poison the minds of our members against our fellow workers, therefore

Be it resolved that we, the members of Lodge No. 116, hereby strenuously denounce the methods adopted by our officers in disposing of this important suggestion of amalgamation. We deny them the power to finally determine the policy or the future steps of advancement of the boiler makers' organization. We feel that their action is an usurpation of the power fundamentally vested in the whole membership, namely, power to determine our future.

Be it further resolved, that we strongly protest against the suppression of said communication as an injustice to the intelligence of our members and especially do we condemn the attitude taken by the managing editor of our Journal as being inimical to the good feeling existing between boiler makers and machinists and tending to pre-

vent harmonious co-operation between the two crafts. We repudiate the reflection cast upon our brother union men and deprecate the bigoted views officially expressed in our Journal regarding this question, and

Be it further resolved, that we hereby call upon our international president to have said communication published in our Journal in full so that our members may intelligently comprehend its object. We also feel that an apology should be made by our Journal for the unjust reflections cast upon our brother union men.

Be it further resolved, that a copy of these resolutions be submitted to all lodges comprising the Northern Pacific system for their consideration and that they be published in our official Journal.

J. G. BROWN
J. W. GABION
J. B. WILMAR
Committee.

NOTE FROM THE EDITOR.

In reply to the above, the editor would like to suggest that our members should first endeavor to ascertain the authenticity of the statements they make before rushing into print, they owe it to themselves as well as our members, so that no injustice shall be done any one.

The first preamble starts out with the statement that "a communication has been addressed to the International Brotherhood of Boiler Makers, etc., by the International Association of Machinists" advocating amalgamation, etc., when as a matter of fact this communication was addressed to J. A. Franklin, J. W. Kline, John A. Haynes, J. E. McClory, Jas. Kirby, T. Daly, J. F. McNulty and John Alpine.

These were requested to give an expression of their opinion concerning the matter, however, instead Brother Franklin referred the matter to our executive council for action, we believe this is in line with the laws of our organization. Our delegates meet in convention and adopt policies and laws for the guidance of our officers and members, and our laws confer upon the executive council the judicial and executive authority of the organization between conventions. Their passing upon this communication from the machinists did not alter our policies or laws in the least, these were passed by our convention at San Francisco only a few months before. If the conclusions reached by the executive council does not meet the views of all members, those entertaining different views have the privilege of having the matter further considered by the next convention.

Now in reference to apologizing for the editorial complained of, will say it is not the desire or intention of the editor to wantonly wound the feelings of anyone, and if it can be shown that we did anyone an injustice in this instance, demands for an apology will not be necessary, for we will willingly make the "amend honorable,"

however, if the statements contained in the article were true, then we see no reason why we should apologize for telling the truth, which in this case was for the purpose of warning our members against some of the dangers liable to arise from the adoption of the amalgamation proposition, and not for the purpose of "poisoning the minds of our members against our fellow workers" as these resolutions state. In this editorial in December Journal we stated among other things that the amalgamation proposition originated at a conference of machinists' officials held last spring at St. Louis and that at this same conference, plans were laid to try to secure the positions of boiler inspectors under the Federal Locomotive Inspection Law instead of boiler makers, by having the law amended; no denial of this matter has been brought to our attention so far, although we spoke of the matter more extensively in the August issue. If any of our members doubt the accuracy of our statements in this matter let them secure a copy of the Machinists' Journal for June, 1914, and they will find the matter set forth on page 603.

We disclaim any desire to disturb the harmonious relations between the different organizations, on the contrary we are anxious to maintain such and believe our past record will show that we have been consistently friendly and conciliatory and especially so with the members of the machinists, hundreds of whom we know personally and have worked with in the general labor movement of the past. However, we do not believe our friendships for others should interfere with our duty to our own organization and when we feel anyone is trying to put something over on it, we are sure to let it be known. We believe the writers of these resolutions were hasty in drawing conclusions because of their not being fully informed and that they will agree with us in this conclusion after they have investigated the matter more fully. Furthermore in their haste to condemn a seeming discourtesy on the part of the editor they to a still greater extent employed that which they condemned in by hurling envenomed of condemnation and repudiation at him. We believe they could with profit, take a liberal dose of the harmonious unity medicine they prescribe for the editor, and thus help to cultivate more harmonious unity in our own ranks.—The Editor.

East Boston, Mass.

Dear Sir and Brother:

At our last regular meeting it was voted to give a rising vote of thanks to Brother Edward Scrivin who has brought a large number of new members into Lodge No. 585, thereby ably co-operating with our resourceful and persevering Sixth International Vice-President John J. Dowd, and our enterprising deputy organizer and business agent, Brother Daniel N. Generson in the

skillful campaign those gentlemen are conducting in this section of the country, in the interests of the International Brotherhood of Boiler Makers, Iron Ship Builders and Helpers of America! Brother Generson's progress in the difficult task of unionizing the craft in this vicinity has been given a decided impetus by our worthy International President Joseph A. Franklin and the grand lodge by bestowing on Brother Generson the official credentials designating him as a real bonafide organizer in our branch of the greatest trade union body in the world today—the American Federation of Labor.

Our hustling president, Brother Wm. E. McNabb states that the widow of the late Brother John Welch expresses her gratitude to all those who responded to the subscription lists circulated in her behalf by Brothers John Warnock, John Farrell and Wm. E. McNabb, the sum of \$82.00 being realized.

The third annual ball to be held April 9th at Lyceum Hall, East Boston, promises to be a great success, as the officers and the committee in charge are working hard in that direction and many of the old time boiler makers of Greater Boston are expected to be present.

Yours fraternally,

DANIEL B. McINNES,
C. SL. 585.

Denison, Texas.

To the Officers and Members of all Subordinate Lodges "Greeting":

We, the officers and members of subordinate Lodge No. 209 of Denison, Texas, in regular session unanimously voted to reject the amendment proposed by local No. 123, also the one proposed by local No. 126, they being proposed amendments to our G. L. Constitution as published in March, and will again appear in April Journals.

And we hereby take the pleasure to give our reasons for rejecting them and discuss the propositions with you.

First, we will take the one offered by Local No. 123 which provides (if it should become law) the very thing that we are organized to combat, namely low wages or in this case which is still worse the reduction of wages. Now just a word to the brothers of Local No. 123: We will suppose that you had just signed up an agreement with your employer, we will say on the first of this year for three years and you had received an increase of pay and now they should post a notice that they would have to reduce your wages 25 per cent, would you willingly submit to it or would you ask for one of the international officers?

Again, suppose this amendment should carry and become a law, how would you like to act on a committee that was to go before the management asking for more money and have them to tell you about cutting the pay of your own officers?

Now, Brothers, how many of you would object to an increase of pay just now or at any other time, well if you like it yourself, why object to the other fellow getting it, is it simply because you don't happen to be the "other fellow?" Now, if No. 209 ever needs the assistance of one of the international officers we want one that will make a good impression both mentally and financially, that is, we don't want him to smoke any "three-fers" while in the presence of our superintendent of M. P. or M. M., neither do we want him to have on a pair of trousers that have been reinforced where it can not be noticed while he is sitting down.

And when we think that he should be in town we will look over the register of the two best hotels but if he should happen to be stopping at a cheap rooming house he will have to look us up.

Therefore, we are going to do our utmost to uphold their wages or salary in order that we can get the kind of "dignity" that we think will have some influence with our officials.

And now just a word to the brother (whoever you may be) that first introduced this resolution into Local No. 123, you that accuse the Eleventh Consolidated Convention of being a "machine controlled convention" I personally must say that you seem to be a pretty good "machine man" yourself. Just keep it up Brother and I am sure you will be at the next convention if you keep in good health, and if you can operate your machine as good there as you have with No. 123, in getting them to indorse a resolution like yours and put it before the Brotherhood. "Well," you may be the next president so now let us quit chewing the rag about the president's salary because you know you would want it raised again as soon as you were elected.

And now just a few words in regard to why we object to the amendment offered by Local No. 126. We think the recall is a good thing and if properly gotten up so as to give everybody a fair and impartial hearing would be a good thing to make our international officers be good and do their best, but we do not think that No. 126 has the proper thing yet.

Note paragraph "B" they only want the accused officer or officers to have ten (10) days in which to prepare his or their defense and that defense to be limited to 300 words. Now Brother, you know there is no justice to that.

It seems that No. 126 has an officer in view that they wish to recall on the grounds of inefficiency, as they themselves admit that is the only thing they cannot prefer charges for, then who else could it be except their own representative, Brother J. P. Merrigan who has been on the job about four or five years. Now Brother, it has taken you a long time to discover his inefficiency and if he has fooled you this long I believe you should let him go until

the next "machine" controlled convention is called to order in 1917.

Yours for the good of the Order,
S. E. HARRIS,
Cor. and Fin'l. Sec'y.

Livingston, Mont.

Dear Sir and Brother:

I write this for insertion in the April Journal in reply to Grand President Franklin's comments on the referendum called for by Lodge No. 123. He takes exception to the fourth "Whereas" and challenges the statement therein, also proceeds to call us a lot of liars, only in polite terms. Now calling names is no argument and tends only to weaken a case in the minds of serious-thinking men, no matter how flowery is the language used.

Now we are the accusers, and consequently the burden of the proof is on us, so let us look and investigate and see if we have made a "glaring misstatement of facts," or "bare faced falsehoods," as accused by President Franklin. Now I will endeavor to do so, with no abuse or calling of names, as that is only resorted to by a person who has no good argument and tries to bury his opponents in a flood of invective and abuse.

Let us get a few figures from that convention in regard to the vote cast. We find that out of a total vote of that convention that 52 votes are cast by Grand Lodge Vice-Presidents, Deputy Grand Organizers and Business Agents, receiving their salary in whole or part from the grand treasury, and this out of a total of 254 votes. Some of these men hold their jobs by virtue of their obedience to the Grand President and every one of them voted for the increase. And I contend that those salaried officers who represented locals and at no expense to the local, but drew their regular salaries as officials, were not really representing the local, but were representing the wish of the Executive Council, and the Grand President is the head of the Council. Locals were represented thus, that would not have had a delegate otherwise. I know of one Grand Vice-President who transferred his card to such a local in order to represent it and be a delegate at no cost to them. Now Lodge No. 123 pays its own delegates and expects them to obey the instruction of this lodge, but it seems we are helping to pay Vice-Presidents to represent other lodges and vote against our interests and the interests of the lodge which gave them credentials and are responsible to no one but the Executive Council.

Read page 336 of the minutes of the convention and see how that raise was railroaded through; but the President after more thought saw he had gone too far, and hearing the strenuous objections of more than a "few" delegates, again brought up the question the next day for roll call, knowing he had sufficient strength to put it over, with the 52 solid Grand Lodge votes behind him.

Now as to President Franklin appearing personally before any committee, that is not necessary as we know of political machines that the head of which is seldom seen. It was openly charged on the floor of the convention that it was machine ruled and that laws were being made to help machine rule. Now we are not "disgruntled" as we have no axe to grind, although we did try to get laws passed that we believed would benefit all. That convention did another thing that looks queer to me; by changing the 10 per cent from the strike fund to the general fund, in spite of the overwhelming vote cast against it shortly before the convention. Although that referendum did not get a sufficient number of votes to make it legal, a convention with less than 22 per cent representation changed it even against the protests of several delegates not in the ring. These are cold facts and no amount of hot-house air can change them. It appears we have brains enough to earn the money to run the union but not enough to dictate what shall be done with it. As to its being necessary to have so many Grand Vice-Presidents to make agreements and prevent strikes, I believe it works the other way. The writer had the honor of being on the first two committees to make an agreement with the Great Northern Railway, and we were accorded good schedules, the best in the Northwest at that time, without any trouble or any Grand Lodge officers to assist us, and we had no trouble on the road til Grand Lodge officers mixed in.

Now we do not consider we are cutting pay, but we are trying to get back what has been wrongfully taken from us, by a convention that did not represent the rank and file. This resolution is no insult to the independent delegates of the convention who voted their honest convictions on any question as the ratio of voting power held by Grand Lodge officers could throw the result either way as their interest lay, on any question, and honest delegates do not always agree. To these we need make no apology, to the others we have none to offer, and the rank and file may judge by their vote. We are willing to trust them if our Grand Lodge officers are not.

It was asserted on the floor of Lodge No. 123 by one of our helpers that a Vice-President told him if he would get elected as delegate to the convention he would have him elected as a Grand Vice-President, and yet they have the nerve to tell us there is no machine and that the delegates controlled the convention. Why should we raise salaries when our finances do not justify it and when so many members are out of work and on strike? The only argument advanced is because some other unions pay more; if they are able—well and good; that is their affair, this is ours. We have to work alongside of men who receive more than we do, also some who receive less. Do we respect them any more, or any less, because of that? Can the Grand President

give us better efforts because of more pay? If so, I have so far failed to see them, and we are entitled to his best efforts as long as he holds the job, regardless of the salary. Now let us see why we should raise the salary. A raise is most generally given for increased efforts or greater efficiency. Has that been the case with our Grand President? Our order is weaker than four years ago, and yet we are spending a great deal more money now than then, through our Grand office. There is carelessness or incompetency somewhere. What business had the Executive Council to give fifty dollars to the Liberator from our strike fund? I believe the Liberator O. K., but the money should come from the general fund, as the Grand President, Executive Council or no one else has a right to take from the strike fund except for strike benefits. It is their thin entering wedge to get at that fund on one excuse or other, and if no protest is made, the next will be \$500 and the next \$5,000, till all is spent for some plausible purpose, and then when we strike we will find our fund exhausted and we will be informed we can receive moral support only. Now you supporters of machine rule, fire your heaviest guns, let loose your invective and see if you can fool the brothers this time. We believe we will receive the largest majority ever cast on a referendum vote of this union.

Fraternally yours,
C. J. MAES, of Lodge No. 123.

Danville, Ill.

Dear Sir and Brother: At our regular meeting of Lodge 22, the following resolutions were adopted:

Whereas, It has pleased the Almighty God in His Divine wisdom to remove from our midst our esteemed and worthy brother, Samuel Davis, therefore be it

Resolved, That we, his fellow brothers, extend to his bereaved wife and family our most heartfelt sympathy, and pray that the Almighty God may comfort and console them in their hour of bereavement and sorrow, and be it further

Resolved, That a copy of these resolutions be sent to the Journal for publication, a copy spread on the minutes and a copy sent to the bereaved family.

H. ROGGENDORF,
F. JARGENS,
Committee.

Danville, Ill.

Dear Sir and Brother: I was instructed to write you in regard to brothers coming to Danville, Ill., looking for work. We would like to get this in the Journal for next month if there is any chance at all, notifying all brothers looking for work to see the business agent or shop committee before they sign up for work.

WM. J. IRWIN,
C. S. L. 22.

Ludlow, Ky.

Dear Sir and Brother:

No doubt you have heard of the terrible accident that occurred to Brother Rebstock of Lodge No. 80 of Anaconda, Mont. After receiving a letter and telegram from Brother James W. Hogan, C. S. L. 80, Local No. 105 took charge of the remains and a considerable number of them laid off on the day of the burial. Four of the members acted as pallbearers, all wore their mourning badges and his brother was very well pleased with the way we conducted the funeral. Lodge No. 80 sent a sum of money which we expended for a beautiful floral piece.

With best wishes, I am

Yours fraternally,

D. L. O'BRIEN,

Note: In connection with the above brother mentioned as having met with an accident. The particulars in the case are, we believe Brother O. Rebstock was employed at Anaconda, Mont., and was killed while at work, by a car getting loose in the yards and running over him while passing through the shop.

The body was prepared for burial and shipped to Cincinnati by Lodge No. 80 of which the deceased brother was a member.—The Editor.

Elkins, W. Va.

At a regular meeting of Lone Tree Lodge No. 278, the following resolutions were adopted:

Whereas, It has pleased the Almighty God in His Divine Wisdom, to take from this world of trials and sorrow, the beloved son of our worthy brother, C. H. Godwin, therefore be it

Resolved, that we his fellow brothers extend to him and family our heartfelt sympathy in this hour of sorrow, and be it further,

Resolved, that these resolutions be inserted in our official Journal, recorded and transmitted to the family of the deceased.

A. R. POE,
C. L. CASKEY,
F. G. MAYBURY,
Committee.

San Francisco, Calif.

Dear Sir and Brother:

At the last regular meeting of Lodge No. 410 the following members were suspended and their names ordered published in the Journal:

S. I. Mears, Reg. No. 39295; Michael Carr; Thomas Coulthurst, Reg. No. 40816; Charles Strain, Reg. No. 13628; William Williams, Reg. No. 14006; Charles Gardener, Reg. No. 13620.

Hoping you will give this notice special attention, I am

Yours fraternally,

L. KEVIE,
Lodge No. 410.

Dear Sir and Brother: In answer to your letter in the March Journal in regard to pipe-line job at Preston, Idaho, will state that there are three helpers on the job that are not card men, and do not think that your letter gives the men on the job or Mr. Chas. Seaburg justice, as Mr. Sea-

Now, we do not see where the job is unfair and do not think that the men on the job or Mr. Seaburg are at fault, as he, Mr. Seaburg, is paying above the scale for these men, \$4.00 for holding on, \$4.50 for heating, provided they stay until the job is done, and \$4.00 if they quit before; \$5.50 for boilermakers for 9-hour day, and will state that there has not been a card man who came out to the job that was turned down without being given a chance to make good.

Inclosed you will find pictures of the pipe and men. We wish these published in the April Journal, together with this letter to correct the error in March Journal on page 184. Yours fraternally,

(Signed)

JOHN MULLIGAN, Reg. No. 100077.
 A. H. DOHERTY, Reg. No. 96127.
 J. L. CARDONA, Reg. No. 50849.
 H. WEAVER, Reg. No. 87318.
 R. M. COLLINS, Reg. No. 95762.
 H. E. KARR, Reg. No. 41191.
 CHAS. MATTI, Reg. No. 58052.
 WM. C. SEABURG, Reg. No. 61107.
 GEO. A. SEABURG, Reg. No. 93561.
 TOM O'NEIL, Reg. No. 102223.
 C. J. KARR, Reg. No. 60818.
 M. BAIRD.
 R. W. FIFE.



PIPE LINE AT PRESTON, IDAHO.

burg has sent out calls for union helpers and could not get them. Also has his correspondence from Brother Harrison, Lodge 103, and from Brother Dunn, Lodge 198, stating that they could not furnish helpers.



A GROUP OF MEN WORKING ON PIPE LINE AT PRESTON, IDAHO.

Possibly Brother Dunn does not know the conditions on the job, as there has been only one representative on the job. That was Brother Kuentz and he was only here a short time, and there has been no one else since.



WORK FOR PIPE LINE AT PRESTON, IDAHO.

Richmond, Va.

Dear Sir and Brother:

I wish to express my approval of your editorial in the last issue concerning the need of establishing a sick benefit fund. I believe it would do lots of good and help to build up our organization and bind our members more closely to it.

Now in reference to suggestions concerning the sick benefits, I believe when a brother is sick or unable to work, he should receive four dollars per week sick benefits, provided he furnishes a doctor's certificate and the approval of the lodge of which he is a member.

Second, whenever a brother becomes delinquent in his dues he shall not be debarred from his death benefits, but shall be debarred from his sick benefits for thirty days after paying up in full.

I hope that all brothers will make some suggestions along this line for the benefit of our brothers who become sick and are unable to work; however, we have a long time before us until our next convention meets.

Respectfully,

R. L. KING,
 President Lodge No. 170.

Kansas City, Kas.

Dear Sir and Brother:

It is not very often that I take up the valuable space of your Journal and my only reason for doing so at this time is in self-defense.

In looking over the March issue of the Journal I find, on pages 201 and 202 an article written by C. J. Maes of Lodge No. 123. Livingston, Mont., in which an attempt

is made to convey the impression to the rank and file of our Brotherhood that our organization is controlled by machine politics. In his attempt to produce an argument against the increase in salary granted the president of our Brotherhood at our last convention, he seeks principally to poison the minds of our members and to prejudice them especially against those who have been selected as officers and organizers to carry into effect the laws laid down by the members of our Brotherhood and to promote the best interests of our organization. To say the least, I consider his attempt not only misleading but malicious.

It would seem that the writer of the article would favor disfranchising members of this Brotherhood who are elected officers and because of the fact that a member did accept an office that he should be deprived of the rights that are guaranteed to each and every member. Citizens of the United States are elected as members of congress and state legislatures but their right to vote upon all questions as citizens of our country is not questioned. They are elected as representatives of the people and yet retain their rights as American citizens. Then why should anyone seek to disfranchise those who are selected as officers to represent the lodges and members of our Brotherhood, or to prevent them from representing the members of their locals in conventions? It is my judgment that if the intelligence of the man who is elected justifies his election by a convention of the Brotherhood he should retain the same rights and privileges of membership as belonged to him before his election.

He states that "Our Grand President, on the eighth day of the convention, made a speech favoring the increase and he a candidate for re-election." Oh, what a terrible crime! And further states, "Well, I should call it immodest at least." I don't suppose the dear brother would term it immodest to make a request or a demand upon his employer for an increase in salary if he felt that he was not receiving ample compensation for services rendered. My experience for many years has been that increases in salary are few and far apart that are not asked for. The members of our Brotherhood, throughout the length and breadth of our entire country have been making requests and demands for increased wages for several years past and yet, the dear brother would lead the rank and file to believe that the mere fact that the president of our Brotherhood made a speech in favor of an increase in the president's salary, that it was immodest. "Oh, consistency, thou art a jewel!"

On page 202, the seventh paragraph of the article referred to begins: "Now, the unpleasant part; unpleasant to me you may be sure." And the eighth paragraph winds up the article by saying, "I trust this will be received in the same spirit it is written." I want to say that as far as I am personally

concerned, it was received in the same spirit in which I believe it was written and I am attempting to reply in that same spirit. He says, "The machine controlled convention; read the minutes of that convention; notice the personnel of many of the delegates; harken to the voice of First Vice-President Hinzman." And then comes what I consider a rank injustice, for he supposedly quotes my remarks at the San Francisco convention, but instead of quoting my qualifying statements, he simply quotes about two lines of what I said and then proceeds to comment upon same and endeavors to use this as proof of a machine controlled convention. If the brother wanted to be fair (inasmuch as he saw fit to charge me directly, with machine politics) and if the task of writing such an article was so unpleasant to him, why did he not quote me fully from the proceedings of our late convention and not quote only two lines, leaving the rank and file to guess at the rest? Even the printed proceedings of the San Francisco convention does not give fully the qualifications of those statements as made at that convention, yet had he seen fit to quote that part which was printed in the proceedings, no doubt he would have thrown a different light upon the subject.

I am satisfied that the qualifications of my statements at that convention met with the approval of ninety per cent of the delegates in convention, as the vote upon the question before the house, at that time is conclusive proof of same. So that the rank and file may know, as near as possible what I did say, instead of quoting one or two lines from the proceedings, as quoted by Brother Maes, I herewith submit an exact excerpt from the proceedings of the afternoon session, June 16th:

Brother Hinzman interposes that the adoption of such an amendment would be a reflection upon the intelligence of the delegates assembled in this convention. The idea of one man appointing a committee and so forming a machine that is going to take away the intelligence of the delegates to the extent that they will not vote their honest opinion, is ridiculous.

Discussion again resumed by Hinzman to the effect that this Brotherhood would go backward with the adoption of such a resolution. The rank and file is not competent to elect committees to act on these matters. "Select a commission if you desire to appoint them; if you want to take the power away from the president, but I do not want to see it left wide open so that anyone can be selected to pass upon the most important matters to be acted upon by this Organization.

The convention had under discussion at that time, a resolution providing for the election of the law committee and credential committee by referendum vote, which contemplated taking from the president of our Brotherhood the appointive power of

these very important committees. While I made the statement that the rank and file was not competent to elect these committees, I gave a detailed explanation of my views upon this subject which does not appear in the printed proceedings, which were, in effect, that the members of our Brotherhood being so widely separated and not being closely acquainted and familiar with the qualifications of the members in different sections of the country, and that through a lack of knowledge of the qualifications of all members, to act upon matters of this kind, they were unable to do justice to such a matter by a referendum voting system, and I felt that if it was the desire of the delegates assembled in convention, to relieve the president of those appointive powers, it would be better to select a commission, composed of several members who are well acquainted throughout the country with the membership and know the qualifications of the different members to act on matters of this kind, rather than to leave it in a position where practically nobody would be responsible for the selection of those committees.

I invite honest criticism at all times, but resent misrepresentation and untruthful statements. I may be termed a machine politician by some who desire to criticize unjustly, but as long as I am able, I shall speak the courage of my convictions regardless of time or place as an officer of this Brotherhood or as an individual member. I believe that honest criticism of officers and members is good for any organization; but dishonest criticism, misrepresentation and untruthful statements will destroy a good organization quicker than anything else.

It would seem that the brother is ready and willing to jump at conclusions; to ridicule and vilify the officers of our Brotherhood. To accomplish his purpose, he even goes so far as to endeavor to close the doors behind him after making the untruthful charges which he has made. He speaks of the "bombastic mouthing on par with Kaiser Wilhelm's "Me and God" and says we hear too much of it. I am satisfied that the rank and file, after reading his article will be in a position to readily decide where the "bombastic mouthing" is coming from. He warns the readers of his article that "You will hear the beneficiaries of the machine rule howl about this" and I presume that his object was to lead the readers to believe that any one who might dare to reply to his scurrilous statements was a party to the machine rule, and in his lambasting, he does not seem to be content with his attack upon the officers of the International Brotherhood, but extends its scope to practically all men in our Brotherhood, who have ever taken an active interest in its affairs, going so far as to include deputy organizers and business agents. I am surprised that he did not include the officers of all subordinate lodges.

The following is taken from a letter to President Franklin, under date of February 8, 1915, over the signature of the Secretary of Lodge No. 123 and the seal of the lodge:

"I meant to state before that as for the officers voting for the increase for your salary, as shown on the minutes is where the machine controlled convention is taken from."

I am content to leave this question entirely with the rank and file to decide as to whether or not the officers of an organization, voting for or against any proposition, is proof of a machine controlled convention. It appears the inference is made that because of the fact that those delegates, representing subordinate lodges, who happened to be holding office, were benefited by voting for the increase in salary for the president, or that they would not honestly and conscientiously vote their sentiments and convictions the same as any other delegate in the convention, I feel this is a very unjust position to take. The officers of our Brotherhood, at the San Francisco Convention, who voted upon this and all other subjects, were regularly elected and accredited delegates from the subordinate lodges in which they hold membership; and if the members of those lodges were not satisfied with the actions of their delegates it was their duty to complain and not the affair of any one not directly connected with those lodges.

Another article will appear in this month's issue of the Journal, over the signature of the same brother, in which he states that President Franklin, in commenting on the referendum called for by Lodge No. 123, takes exception to the fourth "Whereas" and proceeds to call them a lot of liars only in polite terms and then states that calling names is no argument and tends only to weaken a case in the minds of serious thinking men. I presume that the brother must have changed his opinion since writing his article for the March issue of our Journal, so let us apply this same reasoning to his article in the March Journal, as he now desires to apply to President Franklin's comment and criticism upon the resolution from Lodge No. 123. Take the third paragraph of his article, in which he says: "Now, I will endeavor to do so with no abuse or calling of names, as that is only resorted to by a person who has no good argument and tries to bury his opponents in a flood of invective and abuse." Let us apply this same paragraph to his entire article in the March Journal.

Then note, particularly the fourth paragraph of his article in this issue of the Journal in which he states, "We find that out of a total vote of that convention, 52 votes are cast by grand vice-presidents, deputy grand organizers and business agents, receiving their salary in whole or part from the Grand Treasury." If the brother is not familiar with the facts, then I

don't believe that he should attempt to prove anything by a mis-statement of facts. The records of this Brotherhood will show that all organizers' services had been dispensed with at least three months prior to the convening of the convention in San Francisco, and were not on the pay roll of the grand lodge in whole or in part. The further fact is that those delegates at the convention who were formerly organizers, were regularly accredited delegates from their lodges and their expenses to the convention were borne by their lodges. The records of this Brotherhood will also show that no business agents received any part of their salary from the grand lodge for at least eight months prior to the convening of the San Francisco convention and those business agents who were delegates at the convention were regularly accredited delegates from their subordinate lodges and their expenses were borne by the subordinate lodges.

The further statement that some of these men hold their jobs by virtue of their obedience to the grand president and that everyone of them voted for the increase, certainly is proven to be an untruthful statement by the facts just given and the further fact that none of the organizers or business agents were receiving any financial assistance from the grand lodge, nor had they been receiving any for some time prior to the convention and were independent to vote and do as they pleased, which I honestly believe they did and would do the same thing again had they an opportunity to do so.

The brother states that the grand vice-presidents, deputy grand organizers and business agents, who were receiving their salary in whole or in part from the grand treasury had 52 votes and then proceeds to point out how these 52 votes behind the president controlled the convention. I feel that the facts given above, in reference to the organizers and business agents not receiving salary or financial assistance in any manner from the Grand Lodge should eliminate them entirely from this comparison. The ten officers of the grand lodge were regularly accredited delegates to that convention; but when we investigate the records of our Brotherhood, we will find that eight of the vice-presidents had been off the pay roll of the grand lodge for at least two months prior to the convening of the convention in San Francisco, but for the sake of argument let us count up the total vote of the grand lodge officers in the San Francisco convention, and we will find that it amounted to 19½ votes. Had all the grand lodge officers voted against the increase in salary for the president, the vote would have stood 147½ for and 106½ against, still leaving a majority of 41 votes in favor of the increase. The total vote by roll call, as shown by the Proceedings of that convention was 167 for and 87 against. It appears that the brother, in order to bol-

ter his argument and to support his contentions of a machine controlled convention must necessarily include organizers and business agents who had absolutely no connection with the Grand Lodge whatever. Judging from the vote cast by the delegates in convention, I am satisfied that those delegates knew what they wanted. This is clearly proven when we find that by eliminating the entire vote of the Grand Lodge Officers, and placing it to the credit of the opposition to the increase there would still have been a majority of 41 votes in favor of the increase.

In the fourth paragraph of this article in this month's issue, he states, "It was openly charged on the floor of the convention that it was machine ruled and that laws were being made to help machine rule, yet he does not attempt, in a single way, to show where any such charges were proven. To make such a statement and to furnish evidence in proof of same are two different propositions; the one referred to as being made on the floor of the Convention at San Francisco is exactly in line with the one made in the article referred to in the March, as well as this issue of the Journal, no proof whatever being submitted, yet because somebody else said so and so, he considers it as proof.

Reference is made in his article in this issue to the small percentage of members represented at our last convention. I feel sure that every member of our organization fully realizes why there was not a larger representation. We all know that owing to the convention's being held in a city situated at such a great distance from the location of many lodges, which would necessarily create a very large expense, the attendance was not as large as it should have been. However, I feel, inasmuch as our laws now provide that future conventions shall be held in the headquarters city, which is centrally located, and further provide that the expenses of at least one delegate from each lodge shall be borne by the Grand Lodge, will insure a full representation at our future conventions, and the percentage of attendance has nothing whatever to do with what it will be in the future. I would especially invite the brother to compare the percentage of attendance at our last three or four conventions with the percentage of our membership voting upon all matters under the referendum system which was in effect in this Brotherhood for ten years, from the year 1896 to the year 1906, and, after he has done so, please advise the readers as to how the percentages compare.

And while the brother accuses me of manipulating machine politics, I just have this to say: Were I seeking a political mentor, or an instructor in political ethics, I should call upon the dear brother from Livingston, as a man, in my opinion, who claims to champion the cause of all discordant and disgruntled elements and is capable of inducing seventy-five members of

his own lodge who are obligated to uphold the fundamental principles of organized labor, to indorse a resolution to reduce wages is possessed of eminent qualifications for a machine politician and should be an expert instructor in political ethics.

Even though he holds it is a poor argument to advise against reducing wages, he does not, for one moment, advance a single argument that is logical and sensible; in his mere opinion, this argument is a poor one. The fact that our San Francisco convention saw fit, by an overwhelming vote, to grant the President of our Brotherhood an increase in salary, has not increased the dues one penny on the members of this Brotherhood and it has not, up to this time, in the least, affected our Brotherhood in any way.

Possibly he has forgotten his argument before the Railroad Department of the A. F. of L. at the convention held in Kansas City, Mo., from April 13 to 23, 1914, at the time when he was advocating "One Big Union," or, in other words, the "Amalgamation of Kindred Trades," and speaking in favor of a resolution to submit the question to the rank and file of all organizations affiliated with the Department for a referendum vote. He said, in part, as follows:

"I believe the rank and file would settle this question and if this organization (meaning the Railroad Department of the A. F. of L.) took hold of the matter in proper form it would insure LOGICAL AND EXPERIENCED MEN TO HANDLE THIS CHANGE IN THE FORM OF ORGANIZATION, and be done in a way that would create no hardship to the present organizations; but if we refuse to go to the rank and file on this question, it would EVENTUALLY END IN REBELLION AND DISRUPTION OF THE ORGANIZATIONS, AND INCAPABLE MEN WOULD GET HOLD OF THE REBELLING ORGANIZATION AND EVENTUALLY bring things into a chaotic condition."

It would appear, from the article referred to that some one is endeavoring to bring about the threatened rebellion and disruption and further to place the officers of our Brotherhood in disrepute, and, by so doing, permit the incapable men referred to to take advantage of affairs and "bring things into a chaotic condition." Just note the argument here, and the admission that if the officers of the several organizations, composing the Railroad Department of the A. F. of L. adopted his plan and his views that everything would be lovely; and, then note the veiled threat that if they did not adopt his views and his ideas, rebellion and disruption of our organizations would take place and that incapable men would get hold of the rebelling organizations. Then talk about the "bombastic mouthings, on par with Kaiser Wilhelm's "Me and God."

Now, brother, my advice to you is to lay that little hammer of yours aside and if you cannot boost a little for a stronger and better organization, don't do so much knocking. There are many matters of interest to

the members of our organization which can be taken up in lodge rooms, discussed and action taken which will result very beneficially to our members. The matter of agreements with employers, boiler inspection and the perfection of our organizations are subjects which would bring a great deal more good to the rank and file of our members than to be applying our time trying to reduce the salary of our officers and lambasting and abusing, writing and re-writing mis-statements, misleading a number of our members. I am indeed sorry that it becomes my painful duty to reply to the article referred to, but the readers may rest assured that when I, as an officer of this Brotherhood, or as an individual member of our organization, am unjustly accused, I shall endeavor to set forth plain, cold facts, not with a desire to abuse or criticise any one, but in defense of myself.

With very best wishes to one and all, I am
Yours fraternally,

A. HINZMAN,
First International Vice-President.

Springfield, Mo.

Dear Sir and Brother:

The March issue of our Journal was to my thinking one of the most interesting ones that we have had for some time and the correspondence from the various lodges shows an awakening of the membership that is gratifying. The article from the pen of Brother McGowan from Silvis, Ill., asking for a fair-minded discussion on the question of amalgamation through the columns of the Journal is at this time the proper thing and the writer of this hopes to see a response from all quarters. To my mind the amalgamation of kindred crafts is proper and would be a big step in economy to the dues-paying membership. However, it is a step that must be approached very carefully, and after much thought and deliberation. I am free to admit that at this time the consensus of opinion is overwhelmingly against it and am not sure that after an exhaustive discussion of the question its adoption will be any too popular. Now I take it, this amalgamation means the joining of forces under one head of all kindred crafts, but that each craft retain their individual work, of course it could be no other way because it would be foolish to expect a machinist to undertake to do our work, or us theirs because of the inability of each to perform the required tasks with anything like present skill displayed by the practiced artisan in each line today. Even if such a thing is contemplated, I prefer to believe that we would each stand on neutral ground as a craft and it would not mean any lessening of jobs.

The employing class would, however, find such a deterrent in this sort of a plan that they would be (and justly so), very much opposed to it. Of course if the movement was approached gradually, that is by train-

ing the boys to become all around mechanics they would accept the scheme readily enough. However, the main point is that each organization is at present maintaining a corps of officers whose duties are to attend to the business of their respective crafts, each are actuated by the same motives, i. e., the acquiring of better working conditions and a greater share of the wealth created. Now why could we not eliminate the waste and expense and energy and have one corps of officers to attend to all the business, surely I as a boiler maker, could have no complaint if a machinist secured better conditions and wages for me while acting as officer of my labor organization or vice versa with the machinist. Under such a plan the inquiry to one would in fact become the concern of all because of the diversified personal of not only the grand officers but shop committees business agents, etc.

This plan will only come by education of the great rank and file and after a dying out of the present petty jealousy and suspicion existing between the various crafts today. However, let us have this discussion without insults or personalities and talk to the other craftsmen when the opportunity presents itself and maybe we will begin to see ourselves in our true light, that of brother, each striving for a common goal.

R. A. LINES.

Ft. Worth, Texas.

Editor of Journal:

The official Journal for March is of more than usual interest from the fact that it brings to our attention several matters that are of the most vital interest to this organization.

Brother McGowan has dwelt very reasonably on a question that is going to be one of the most important, that we, as a craft have to consider. This is a matter that can not be dealt with in a slip shod manner but requires the most serious thought and careful study. Whether we are ready for it in the face of the fact that we have the system federation and have only recently adopted the railway department, is a matter to which all should give the most careful thought in order that, in our haste to do something we should not destroy that which we have been years building.

The system federation has brought about results that a few years ago seemed impossible of attainment. Yet there is much to accomplish through this medium that has not even been tried.

What the railway department will accomplish remains to be seen as it has never been given an opportunity to demonstrate what is lying dormant in that line.

However, it does not seem to me that the evidence in favor of amalgamation is strong enough at this time to tempt us to take it up. One of the reasons we are not ready for it is not on account of international jealousies, but local differences that

we must learn to overcome before we are able to cope with a question as large and as far reaching as this.

There are many points in connection with this question that we have got to eradicate as locals before we can hope to work in harmony.

In this connection I might cite you to a controversy that arose on a railroad in this vicinity, where there exists a system federation.

The machinists had formerly held all round house foremanships. The federated agreement provided that any man, regardless of craft, whose seniority entitled him to the job might have same when it became vacant. A boiler maker bid for and was assigned to one of them. The machinists held meeting at several places along the line and threatened to make a grievance of same and if necessary take the matter to the general manager, because they had always held these jobs.

Such work and some others could be cited that tend to show that we must first become educated to the things we now have and learn to work along harmoniously with our brother crafts, before we try to go too strong on this line.

However, I believe that the time will come when the order of the day will be industrial unionism, but I do not think that the time is now.

As for abusing our grand lodge officers and accusing them of every crime under the sun that is only one more way of causing discord and discontent among the half-hearted members, which makes the work harder*for those who will work and try to do something. The sooner this kind of business is done away with and discouraged, the sooner we quit knocking and go to work, the sooner we will be able to accomplish something worth while.

In regard to the resolution offered by Lodge No. 126, I think that if they had offered the resolution and left out the fourth clause they might possibly have had some chance of having it indorsed. As it now reads the resolution as a whole is an insult to every man who attended the last convention, whether or not he supported the resolution in favor of an increase in salary. However, the question does not need my defense because President Franklin has stated the proceedings exactly as they occurred.

If more of the lodges would try to have delegates present and not try to tear down by their subsequent actions what was done in a conscientious sense of duty by their accredited delegates, then possibly we could attain more.

In regard to the salary proposition, personally, I was, am, and will be in favor of the law as it now reads. We cannot hope to have nor expect to get educated men to hold these responsible positions unless we can pay them what they are worth to us.

A man to be president of this organization must be able to cope with men of the brightest minds who are educated along these lines. If we want to put them on a salary that some of us are now making it will not be long until everyone of us are working for a very small wage, because the educated men will eventually drift into something where they can do better for themselves and loved ones. So I say give them a good salary and keep them with us and not be trying to educate a new set every time we have a grievance. The men that we are going against are old timers in this business and every time we send a new one against them we are only losing ground so it is very necessary that we keep men in our ranks who can deliver the goods for us, and the only way we can do it is to pay them good first class salaries.

I do not think we made a mistake and I believe the majority of the thinking members of the organization will bear me out in this. While the salary we are now paying seems to be a lot of money to some of us, I believe that in the course of time it will be shown that it was one of the wisest moves made at this last or any preceding conventions.

Trusting that the membership at large will thoroughly discuss this matter and all other things of this Brotherhood in order that we may all be benefited in the long run, I remain,

Yours fraternally,
L. A. FREEMAN.

Springfield, Mo.

Editor-Manager Journal:

I am sending a few lines for the April issue of our Journal and I hope you may find space for same. It is not often that I take up the space, being content to leave it to the other members of our organization, but when I read the March issue, I felt it was time that some of our members who have worked hard and faithfully for several years to build up an organization, took a hand and had something to say.

I have read with much interest the resolution from Lodge No. 123, in which they offer an amendment to our constitution wherein our International President's salary shall be reduced from \$2,400 per year to \$1,800 per year, giving as their reasons for same that the increase was granted by our last convention at a time when our treasury and conditions of the country and trade did not warrant it. Also stating that they believe our membership as a whole are not satisfied and that the increase was granted by a "machine-controlled convention," and offer a comparison of our president's salary with the average earnings of boiler-makers and shipbuilders. What has prompted our brothers in Montana to start a move of this kind I do not know, but in my opinion, some one has made a serious mistake. In the first place I cannot agree with their argument as to the conditions of the country and trade not warranting

the increase, for the face of the matter is that our auditor's report shows \$58,555.10 in our treasury July 17, 1914, the month in which the increase took effect; and the fourth quarterly report of the I. S. T. shows in our treasury \$73,735.15 on January 1, 1915, an increase of \$15,180.05 for the six months after all liabilities and expenses had been paid, including the president's salary at \$200 per month for six months. These results were accomplished without increasing the dues or cost of membership to our members, hence, my claim that their argument is not a good one.

As for the membership as a whole not being satisfied, will say I believe the great majority of the membership are satisfied and believe in the best of wages and conditions. It is to be expected that some are not satisfied as some men are never satisfied with anything, and especially those who take an obligation to abide by the laws and rules of our organization and after they have had their voice and vote are not content with the action taken unless they can be the dictators, then proceed to try to undo what a large majority of those who had interest enough in the welfare of an organization to be represented in regular convention in conformity with the laws, had done. Furthermore, I feel sure if the entire membership of our organization were familiar with the proposition, they would by an overwhelming vote, sustain the action of the San Francisco convention.

As a member of this brotherhood for a good many years, I have always had a great deal of pride concerning same, and as our earnings and conditions generally compare favorably with any of the other metal trades or railroad shop trades, I feel that our officers are entitled to the same consideration as that given by our sister organizations. Are we going to be known as a lot of cheap skates and compel our president to give his time and brains in our behalf for \$600 per year less than the presidents of the other crafts with which we are affiliated receives? I will venture the answer will be "No," as I have a great deal of confidence in the men of our craft and feel that their final decision will be "Do unto others as you would have them do unto you." If we wish to place our organization on an equal basis with our sister organizations, let us treat our officers the same as other organizations do theirs. If we wish to command the respect of the labor movement, as well as our employers and the public, let us at least be as fair with our own employes as we expect our employers to be with us. My experiences in the past have shown me that considerable is expected of our president. The nature of his business naturally compels him to meet and do business with government, municipal and corporation officials, as well as business men in general. He is our representative and we in many instances are judged by his ability and appearance. Let me ask how many of our readers de-

sire to be represented by a man inferior in ability and appearance to those representatives of other organizations? I will venture to say none. Then let us respect our own representative and treat him as others treat theirs, and by so doing, uphold the dignity of our brotherhood and offer him some inducement to give us the best that is in him.

To adopt the amendment offered by Lodge No. 123 simply means a reduction in salary to our president after he has received the increase for nine months, a violation of all principles of unionism. How many of our brothers would stand for a 25 per cent reduction in wages? Not one.

Now for the "machine-controlled" convention we hear so much about: The writer happened to be a delegate to that convention and served as chairman of the law committee, and must say if the convention was controlled by a machine, the machine was invisible and I think the real machine got a few cogs knocked out of it and finally died. I am sure it missed fire on several occasions during the convention, as the loyal members of our brotherhood who attended the convention refused to be handed a lemon by a bunch of politicians. Every member on my committee acted as his conscience dictated and not in accord with the wishes of anybody, and I resent the statements that have been made and denounce them as unwarranted as well as untruthful. I have been serving my district as business agent for the past ten years, receiving my salary and expenses direct from lodges comprising my district, and at no time prior to the San Francisco convention did I or my district receive any financial assistance whatever from the grand lodge. Neither was my salary paid whole or in part by the grand lodge. Consequently I was free and independent to vote as my conscience dictated and not obligated to anyone.

The reference made in the article by Bro. C. J. Maes to the beneficiaries of the machine rule and openly charging that the vice presidents, organizers and business agents are beneficiaries of the machine, in my opinion, is an insult to the intelligence of our brotherhood, and just so long as such narrow, selfish views are countenanced, just that much longer will we as an organization be in placing ourselves in the foremost ranks of the labor movement. The laws of our brotherhood provide specific methods for dealing with dishonest officers, which gives to each and every member an opportunity of preferring charges against any officer for any wrong doing or for any violation of the laws of our order, and there is no excuse for anyone going around crying "Crook!" "Thief!" etc. In my estimation, a man who claims to have knowledge of the dishonesty of our paid representatives and does not come forth with his charges and proof of same, is worse than those he accuses, and should be dealt with accordingly.

Bro. Maes says he sees that some of the officials must take a Pullman to ride fifteen or twenty-five miles and that this petty graft must be cut out. Why doesn't he say which ones and state specific instances and not deal in generalities, so that we all may wise up a bit? I do not think it is fair to make such broad statements, as no doubt some of the representatives are at least half way decent and honest, and when generalities are dealt in all of them must be spattered a little at least. I further believe that our officers should be given the same consideration that all members are given, and believe them innocent until proven guilty after a fair and impartial trial under the laws of our brotherhood.

Bro. Maes lays great stress upon the depression of business throughout the country, and offers to compare our president's salary with the earnings of the average members. He then proceeds to use the little hammer as to the expenses, etc. I don't believe I ever heard of such comparison before. The members of my district favor a man with qualifications to transact our business along business lines, and they know that the duties and requirements of the president of our brotherhood are considerably more than that expected of a journeyman in the shop, and is a position that commands a much higher salary. Consequently there can be no comparison whatever. If all our members entertained the same ideas as those expressed by our brother from No. 123, I would not give much for the future of our brotherhood. Now, as to the hotel bills of our international president: I have not had an opportunity to inspect the quarterly report as closely as I would like to, but from past observations of them, I am willing to wager that they are within the law of our brotherhood. I just wonder how many thousand miles our brother from Montana has traveled in a box car as the representative of our members, and I wonder if he was our international president if he would stop at a cheap rooming house. I suppose he would go to a soup house for his meals or hit a free lunch. Again I wonder what the business world would think of us to have our leader pulling off such stunts. If our brother ever represented a body of men in such manner, I just wonder what kind of men they were. While traveling over my district and transacting the business for my constituents, I have found that nobody has anything to give away, and if a man lives respectably or half as well as he would at home, it costs money. The cost of living has increased wonderfully, the last few years and the hotels and restaurants have not forgotten to raise their prices either. This applies all over the country, and generally where a man could live on two dollars per day a few years ago, he cannot live on three now.

I represent a district comprising seventeen lodges, who are now and have been for some time enjoying a very good agree-

ment and conditions which compare favorably with the best in the country. We believe these conditions were established by selecting our very best men to represent us, and have always paid them the best of wages and did not ask them to ride in box cars or eat at soup houses. We want our representatives to live respectably and pay them accordingly. We expect our grand lodge officers to do the same, and when we get so poverty stricken that we can't treat them like other men in similar positions are treated, we had better dispense with their services and go back in the old rut where we were ten or twelve years ago. I am sure many of our older members will remember those times.

I hope our membership will give these matters due consideration and investigate some of the statements made before taking action. Let our motto be "Onward and Forward," not "Backward." Don't let us establish a precedent for every employer in the country to take advantage of by saying the conditions in the country forced us to reduce our own officers' salaries, and the same conditions will compel them to reduce the wages of the men.

Trusting this will meet with the approval of one and all, and with best wishes, I am

Yours for good wages,

A. F. BINGHAM,

Pres. and B. A. Dist. No. 23.

Neodesha, Kan.

Dear Sir and Brother: Please insert in Journal the following poetry:

Is there any heart discouraged as it journeys on its way?

When thou passeth through the waters,
Does there seem to be more darkness than there is of sunny day?

Oh! It's hard to learn the lesson, as we pass beneath the sod,
That the sunshine and the shadows serve alike the will of God.

But there comes the word of promise like the promise in the bow,
That however deep the waters they shall never overflow.

When the flesh is worn and weary, and the spirit is depressed,

And the temptations sweep upon it like a storm upon ocean's breast,

There's a Heaven ever open for the tempt-driven bird,

There's a shelter for the tempted in the promise of the Word;

For the standard of the spirit shall be raised against the foe,

And however deep the waters they shall never overflow.

When a sorrow comes upon you that no other soul can share

And the burden seems too heavy for the human heart to bear

There is one whose grace can comfort if you will give Him abode;

There is a burden bearer ready if you'll trust Him with your load,
For the precious promise reaches to the death of human woe,
That however deep the waters, they shall never overflow.

When the sands of life are ebbing and I near the Jordan shore,
When I see its billows rising and I hear its waters roar,
I will reach my hand to Jesus in His bosom I shall hide,
And 'twill be only a moment till I reach the other side.

It is then the fullest rising of the promise I shall know
When thou passest through the waters, they shall never overflow.

—E. P. Reddick, C. S. L. 418.

Tulsa, Okla.

Dear Sir and Brother: We would like to see this in the next issue of the Boiler-makers' Journal if you have space:

THE FUTURE.

The route to life's hope, great success,
Is like all roads that prong
The right road to travel by,
And the other way that's wrong.

But the menace of this very day
For success try to grab,
Is the future of the Union Man,
And the future of the Scab.

The Union Man with conscience clear,
With no onthought to discard,
While the scab with uneasiness,
While the scaley with uneasiness,
Is always on his guard.

And thus it goes on day by day
No matter what you choose,
You have to profit all your gain
With no conscience, then you loose.

For an unclean conscience brings you wrath,
You belong to lower grades,
You can't live in Eternity,
They won't have you in Hades.

But the Union Man with conscience bright
Knows nothing else but love,
Will dwell in the land of happiness,
With a great chance for above.

But the poor, weak minded, radical
Guys with minds like frogs,
Will have no place at all to go,
They'll have to dwell with dogs.

So let us take the only way,
And from that way don't part,
And we will live forever
With the Unions in our heart.

—R. E. Lannon, Local 592.

Chicago, Ill.

Dear Sir and Brother:

At a regular meeting of Stoney Island Lodge No. 454, B. M. & I. B. & H. of A., the following resolutions were adopted:

Whereas, it has pleased the Almighty God, in his infinite wisdom and power to take to his reward our esteemed and beloved brother, Henry R. Cooper, therefore be it,

Resolved, that while we bow to Him above, we deeply lament the death of our worthy brother. We, his fellow brethren, extend to his bereaved parents and members of his family our most profound sympathy and may the Divine Ruler of the universe who giveth and taketh away, give to them the strength and Christian fortitude, to bear up under this their great sorrow in the loss of their deceased son and brother. And be it further

Resolved, that a copy of these resolutions be sent to the bereaved parents and family, a copy be sent to the official Journal for publication, also a copy be spread on the minutes at our next regular meeting and our charter draped for thirty days.

WM. KELBY
EMIL R. DETTMER,
CHAS. LEAHY,
Committee.

East St. Louis, Ill.

At a regular meeting of Lodge 363 the following resolutions were adopted:

Whereas, It has pleased the Almighty God in His infinite wisdom to remove from our midst the beloved mother of our esteemed brother, Charles McCarthy, therefore be it

Resolved, That we, the members of Lodge No. 363, extend to our worthy brother and family our heartfelt sympathy and condolence in this their sad hour of bereavement softened only by the confiding hope that her spirit has departed to a better and brighter sphere where sorrow is unknown and, be it further

Resolved, That a copy of these resolutions be sent to our bereaved brother and a copy to our Journal for publication and a copy be spread upon the minutes of our meeting.

JAMES ROSE,
JOHN ROCHE,
FRANK HOAG,
Committee.

Richmond, Va.

Whereas, it has pleased the Almighty God, in his infinite wisdom to remove from our midst the beloved sister of our worthy and esteemed brother, J. C. Tyler, therefore be it,

Resolved, that we his fellow brothers extend to our brother our heartfelt sympathies in this sad hour of bereavement, and as we bow in humble submission, to the will of Him who doeth all things well, we pray that the Almighty God may comfort and console him that he may bear his trial with fortitude, be it further

Resolved, that a copy of these resolutions be spread upon our minutes and a copy be sent to our bereaved brother, and a copy sent to the Journal for publication.

Fraternally in sympathy,
E. M. DAYWALT,
S. P. CRITZER,
GEO. A. YORK,
F. C. BLOUNT,
Committee.

Memphis, Tenn.

Dear Sir and Brother: Local 180 is sending a vote of thanks to the Grand Lodge for the prompt payment of Bro. Jas. Robt. Copeland, Reg. No. 17117, disability claim for the amount of \$200 for the loss of said brother's left eye.

This is the first claim that Local 180 has ever asked for and same was appreciated by all of Local 180.

Yours fraternally,
C. F. GULLENWATER,
C. S. L. 180.

A Compilation of Labor News.

BY THE A. F. OF L. NEWS SERVICE.

WAGES-BY-LAW DISASTROUS.

Sydney, New South Wales.—Protests by trade unionists over the manner in which their wages have been juggled by government-established boards reached a climax in this city when the wages of hotel and restaurant employes were reduced from 20 to 25 per cent. Chief cooks in the higher class hotels have been reduced \$5 a week, while waitresses have been cut \$1 a week. The Australian Worker, published in this city, declares it to be "the most astounding award that has yet been delivered by any wages board in New South Wales." The paper also says: "Not only did the board reduce wages from about 20 to 25 per cent

in hotels and restaurants, but it went beyond the requests of the employers' association and reduced the wages of employes in tea rooms, for which the employers' association made no request whatever."

The unions will protest against the new award by conducting a campaign of publicity against the wages they are now forced to accept. It is announced that a "fair list" will be issued, containing the names of those establishments which will not reduce wages to the level of the board's award.

In an address to the Sydney Labor Council, W. O'Neill, the new president, said that unions are throwing the responsibility

of securing better working conditions on the chairmen of wages boards. He was cheered when he stated that if the organizations federated they would then not need to trouble about arbitration courts, as they would possess the power to protect themselves.

In his half-yearly report, Secretary Kavanaugh, of the New South Wales Labor Council, protests against the manner in which wages boards are debarred, by court order, from considering wage increases. He says:

"If the employer happens to be dealing in the necessaries of life he may go to the Necessary Commodities' Commission, and if he can justify his claim to increase the price of his commodity, he may do so. The employes, on the other hand, no matter what the reason may be, must not get an increase in wages, because the country is at war. We are not even allowed to submit our claims to an increase to the arbitration court. Prices may be increased and our purchasing power thereby reduced, but wages must remain stationary until the war is over."

Since the above was written, Judge Heydon, of the industrial arbitration court, has modified his decision that wages boards cannot consider increases. The court acknowledged this action was taken because of agitation by the trade union movement, whose members have been aroused by this unexpected show of power over them by the courts.

MILLIONS OF ILLITERATES.

Washington.—There are 5,500,000 men, women and children over ten years of age in this country who cannot read or write, is the startling statement contained in a report issued by the House committee on education, which favored a bill to appropriate \$15,000 to enable the federal commissioner of education "to devise methods and promote plans for the elimination of adult illiteracy in the United States." This bill failed to pass the last Congress, although it was urged that the millions of illiterates would be reduced to one per cent of the population within ten years.

In favoring this appropriation the committee on education says:

"Fully half of these illiterates are young men and women with many years of life yet before them to be lived out with the handicap of total illiteracy, unless they are encouraged and assisted to throw off the burden. With proper encouragement and help most or all of these would learn to read or write and to do simple practical problems in arithmetic. Many of them would do much more. They would then be better citizens and more profitable to themselves, to society, and to the industrial world."

In addition to the more than 5,000,000 illiterates, it is shown by figures prepared by

government experts that there are in the United States 15,000,000 or 20,000,000 men and women who can barely read or write.

ROLL CALL VOTE ON BURNETT IMMIGRATION BILL.

Those Voting "Nay" Voted in Favor of Having Two Men for Every Job.

Alabama.

Aye—Abercrombie, Blackmon, Burnett, Dent, Harris, Hefflin, Hobson, Underwood. Nay—Mulkey, Taylor.

Arizona.

Aye—Hayden.

Arkansas.

Aye—Caraway, Floyd, Goodwin, Jacoway, Oldfield, Taylor, Wingo.

California.

Aye—Bell, Church, Curry, Hayes, Kettner, Kent, Knowland, Nolan, Baker, Stephens.

Kahn answered "present." He was paired against the bill with Roberts of Nevada, who was paired for the bill.

Colorado.

Aye—Seldomridge, Taylor. Nay—Keating, Kindel.

Connecticut.

Nay—Donovan, Kennedy, Lonergan, Mahan, Reilly.

Delaware.

Aye—Brockson.

Florida.

Aye—Clark, Sparkman. Not Voting—*L'Engle, *Wilson.

*L'Engle and Wilson were paired for the bill, with Vare of Pennsylvania against.

Georgia.

Aye—Adamson, Bell, Crisp, Edwards, Howards, Hughes, Lee, Tribble, Vinson, Walker. Nay—Bartlett, Park.

Idaho.

Aye—French, Smith.

ILLINOIS.

Aye—Baltz, Buchanan, Borchers, Fitz Henry, Foster, Fowler, Hill, Hinebaugh, McKenzie, O'Hair, Rainey, Tavener, Thomson. Nay—Britten, Copley, Gorman, Gallagher, Graham, Madden, Mann, McAndrews, Sabath, Stone, Stringer, Williams. Not Voting—Hoxworth.

Indiana.

Aye—Adair, Cox, Cullop, Dixon, Gray, Morrison, Moss, Rauch. Nay—Barnhart, Korbly, Lieb, Peterson. Not Voting—Cline.

Iowa.

Aye—Good, Green, Haugen, Kennedy, Kirkpatrick, Scott. Nay—Connolly, Towner, Vollmer, Woods. Not Voting—Prouty.

Kansas.

Aye—Anthony, Campbell, Connelly, Doolittle, Helvering, Murdock, Neeley. Nay—Taggart.

Kentucky.

Aye—Barkley, Cantrell, Fields, Helm, Johnson, Langley, Powers, Rouse, Stanley, Thomas. Nay—Sherley.

Louisiana.

Aye—Aswell, Watkins. Nay—Broussard, Dupre, Estopinal, Lazaro. Not Voting—*Elder, Morgan.

*Elder was paired for the bill with Metz of New York against.

Maine.

Aye—Guernsey, Hinds, Peters. Nay—McGillicuddy.

Maryland.

Aye—Lewis, Linthicum, Price, Talbott. Nay—Coady, Smith.

Massachusetts.

Aye—Gardner, Gillett. Nay—Deltrick, Gallivan, Gilmore, Greene, Mitchell, Paige, Phelan, Roberts, Rogers, Thacher, Treadway, Winslow.

Michigan.

Aye—Hamilton, Kelley, McLaughlin, MacDonald, Mapes, Smith, J. M. C., Smith, Samuel W., Woodruff. Nay—Beakes, Cramton, Doremus, Fordney. Not Voting—*Lindquist.

*Lindquist was paired for the bill with Graham of Pennsylvania against.

Minnesota.

Aye—Anderson, Davis, Lindberg, Volstead. Nay—Manahan, Miller, Stevens. Not Voting—*Smith.

Steenerson answered "present." He was paired against the bill with Faison of North Carolina for the bill.

*Smith wished to vote "no," or against the bill, but not being in the hall when his name was called was not permitted by the Speaker to vote.

The Vote Explained.

The 261 Representatives voting "AYE" voted to protect American workers; voted for American standards of life, and voted for industrial, political and social welfare.

The 136 Representatives voting "NAY" voted to insure the steel and coal barons an unlimited supply of cheap labor; voted to increase illiteracy and voted to retard industrial, social and political betterment.

A two-thirds vote was necessary to pass the immigration bill over the President's veto.

If any four of the 136 voting against labor had voted for labor, the bill would have passed.

Mississippi.

Aye—Candler, Collier, Harrison, Humphreys, Quin, Sisson, Stephens, Witherspoon.

Missouri.

Aye—Alexander, Decker, Dickinson, Hamlin, Hensley, Lloyd, Rubey, Rucker, Russell, Shackelford. Nay—Barthold, Booher, Borland, Gill, Igoe.

Montana.

Aye—Evans, Stout.

Nebraska.

Aye—Barton, Kinkaid, Stephens. Nay—Lobeck, Maguire, Sloan.

Nevada.

Not Voting—*Roberts.

*Roberts was paired for the bill with Kohn of California against.

New Hampshire.

Nay—Reed, Stevens.

New Jersey.

Aye—Baker, Browning, Drukker, Hart, Parker. Nay—Eagan, Hamill, Scully, Townsend, Tuttle, Walsh.

New Mexico.

Nay—Fergusson.

North Carolina.

Aye—Doughton, Godwin, Gudger, Kitchin, Page, Pou, Small, Stedman, Webb. Not Voting—*Faison.

*Faison was paired for the bill with Steenerson of Minnesota against.

New York.

Aye—Danforth, Hamilton, Mott, Parker, Platt, Underhill. Nay—Brown, Bruckner, Calder, Cantor, Carew, Chandler, Clancy, Conry, Dale, Dooling, Driscoll, Fairchild, Fitzgerald, George, Gittins, Goldfogle, Goulden, Griffin, Levy, Loft, Maher, O'Brien, Patten, Riordan, Smith, Talcott, Taylor, Ten Eyck, Wallin. Not Voting—*Dunn, McClellan, *Metz, Oglesby, Wilson.

*Dunn was paired for the bill with Metz of New York against.

North Dakota.

Aye—Helgesen, Young. Nay—Norton.

Ohio.

Aye—Allen, Ashbrook, Bathrick, Bowdle, Claypool, Fess, Francis, Gard, Key, Post, Switzer, White. Nay—Brumbaugh, Bulkley, Crosser, Goeke, Gordon, Sherwood. Not Voting—Whitacre.

Oklahoma.

Aye—Carter, Davenport, Ferris, McGuire, Morgan, Murray, Thompson, Weaver.

Oregon.

Aye—Hawley, Lafferty, Sinnott.

Pennsylvania.

Aye—Ainey, Brodbeck, Butler, Carr, Dershem, Difenderfer, Farr, Grist, Hulings, Keister, Kiess, Kelly, Kreider, Leshner, Lewis, Palmer, Patton, Porter, Rothermel, Rupley, Temple, Walters. Nay—Bailey, Barchfeld, Burke, Casey, Donohoe, Edmonds, Lee, Logue, Moore, Morin, Shreve. Not Voting—*Graham, *Langham, *Vare.

*Langham was paired for the bill with Graham of Pennsylvania against.

*Vare was paired against the bill with Wilson of Florida for the bill.

Rhode Island.

Nay—Gerry. Not Voting—Kennedy, O'Shaunessy.

South Carolina.

Aye—Aiken, Byrnes, Finley, Johnson, Lever, Ragsdale. Nay—Whaley.

South Dakota.

Aye—Burke, Dillon, Martin.

Tennessee.

Aye—Austin, Byrns, Garrett, Houston, Hull, McKellar, Moon, Padgett, Sells, Sims.

Texas.

Aye—Beall, Callaway, Dies, Eagle, Garrett, Gregg, Henry, Rayburn, Slayden, Smith, Stephens, Sumners, Vaughan, Young. Nay—Buchanan, Burgess, Garner, Hardy.

Utah.

Aye—Johnson. Nay—Howell.

Vermont.

Aye—Greene, Pumley.

Virginia.

Aye—Carlin, Flood, Glass, Hay, Holland, Jones, Montague, Saunders, Slemp, Watson.

Washington.

Aye—Bryan, Falconer, Humphrey, Johnson, LaFollette.

West Virginia.

Aye—Avis, Brown, Hughes, Moss, Neely, Sutherland.

Wisconsin.

Aye—Cooper, Frear, Lenroot. Nay—Browne, Burke, Each, Konop, Reilly, Stafford. Not Voting—Cary, *Nelson.

*Nelson was paired for the bill with Kahn of California against.

Wyoming.

Aye—Mondell.

DISCUSSES RESTRICTION.

~~Oklahoma~~ **Oklahoma City, Okla.**—In a leading editorial on the question of restricting immigration in this country. Editor Fields, of the Oklahoma City Evening Times says, in part:

"It is plainly time to put aside sentimentalism and study this question in a cold-blooded, dispassionate way. Stand at the gateway of one of the great factories of Pennsylvania, New Jersey, New York, or Massachusetts, when the evening whistle blows; watch five and six thousand men check out by number and crowd through the gate; then go and inspect the hovels and rookeries in which they swarm to exist between dusk and dawn; note the sanitary conditions, food, bedding, and other requirements—then ask yourself seriously and candidly whether you think an American laboring man, well born, decently reared and fairly well schooled, should or could bring himself to accept wages that will lower his standard to such a level? Frankly, now, do you blame the average young American, who is capable of taking a thought ahead, if he hesitates about assuming the duties and responsibilities of a husband and a father when he knows that in its last analysis the wage scale is limited and fixed by a practically unlimited supply of labor imported from lands where the lowest standards of living prevail?"

PROTEST WAGE RULE OF JUDGE.

Sydney, New South Wales.—In his annual address before the conference of the railway workers and general laborers' union, held in this city, President Rosser called attention to Judge Heydon's unfair judgment recently in which he notified workers that they must not look for wage increases in these troublesome times.

"Despite this," continued the unionist, "we can't help noticing that the employers, both the merchants and the middlemen, who deal in the necessary commodities, have raised the prices with the consequent effect of decreasing the wages of the workers by at least 25 per cent during the last five months."

The decision complained of was made by Judge Heydon, of the court of industrial arbitration, who notified wages board, several weeks ago, that because of the

European war conditions were such that increases were out of the question. The decision, it is declared in some quarters, has practically suspended the sittings of these boards, which are created by law to adjust wages and other questions that arise in the various industries.

SUSTAIN RIGHT TO PICKET.

Phoenix, Ariz.—In the case of a unionist charged with "disturbing the peace," in connection with a strike of cooks and waiters, Judge Stanford of the Maricopa county superior court charged the jury as follows regarding the right of workers' to picket:

"Employees, individually, or acting through a union, have a right to attend at or near the house or place where the business of the employer is carried on, for the purpose of peacefully persuading any person to cease to patronize such place where such employees have ceased to work and have the right to recommend, advise or persuade the public at large by peaceful means to cease to patronize such place and have the right to peaceably assemble in any place in a lawful manner for a lawful purpose."

The jury decided that picketing was not a disturbance of the peace and discharged the defendant.

OPERATORS EVADE DAMAGES.

Harrisburg, Pa.—In an effort to secure the benefits of the proposed state compensation law, Attorney Devere, representing the United Mine Workers, told the senate committee on mines and mining that the companies evade liability by advancing the argument that the men in charge of the mines—the foremen—hold certificates issued by the state, hence are agents of the commonwealth and that, therefore, their employers cannot be made to pay damages. The miners want the mine foreman certificate law repealed. As a substitute they urge that to qualify for foreman, a man must have spent five years in the actual work of mining and blasting coal in a chamber.

REFUSE A RE-HEARING.

Louisville, Ky.—The Kentucky court of appeals has refused to grant a rehearing on the workmen's compensation act, which it recently decided, in a divided opinion, to be unconstitutional. The court also refused to modify its decision so the law could be made effective, pending an amendment by the legislature, which convenes the first of next year.

The majority opinion expressed a belief that the legislature could draw up a constitutional law, but objection was raised to the present act because of the limit of amount specified for various damages, the claim being made that the placing of a limit is against the state constitution.

Compensation advocates are now conducting an educational campaign preparatory to the convening of the next legislature.

"PERSONAL SAFETY" URGED.

Harrisburg, Pa.—To urge individual workmen to realize their personal responsibility, is one of the methods recommended to reduce accidents by officials of the state department of labor and industry, in a report just issued. It is shown that accidents to the number of 38,126 occurred in the various industrial plants of the state during the year. The loss in wages from these accidents amounted to \$1,048,503.96. According to the report the total number of days lost by workmen on account of accidents was 426,824. This gives an average loss to each workman of twelve days.

"When we consider the far-reaching injury to the social well-being of the people of the Commonwealth," continues the report, "the need of remedy grows imperative. It has been found that depending upon these injured workmen are 64,016 other persons. This means a total of more than 100,000 persons affected by these accidents."

UNIONISTS FIGHT REACTION.

Washington.—Secretary Morrison, of the American Federation of Labor, has received the following information from President Marsh, of the Washington State Federation of Labor:

"We are having the legislative fight of our lives this winter to retain upon the statute books legislation achieved during the past years. Probably not in twenty years has such a reactionary body sat in our state capitol. Bills are introduced to repeal our eight-hour law on public works, eight-hour law for women, full crew bill and mothers' pension law. We are holding public hearings on all these bills and arousing public sentiment throughout the state. You may rest assured that trade unionists in this state will fight as best they know to hold that which they have gained through many years of struggle."

WOULD NULLIFY LABOR LAW.

Boston, Mass.—Efforts are being made to nullify the anti-injunction law, passed last year by the legislature, and a bill to this effect has been introduced in the state law-making body. This bill is serving as a model for federation of labor in other states, which are urging its adoption by their respective legislatures. The law provides that no judge can issue an injunction in industrial disputes except where irreparable injury is threatened, and then only in cases where there is no adequate remedy at law.

The law also contains this clear-cut declaration: "In construing this act, the right to enter into the relation of employer and employe and to assume and create a new relation for employer and employe, and to perform and carry on business in such relation with any person in any place, or to do work and labor as an employe, shall be held and construed to be a personal and not a property right."

REAL EFFICIENCY FAVORED.

Columbus, O.—At an open meeting of unionists in this city, President Wilson of the Pattern Makers' League, said:

"We are accused of opposing modern efficiency methods, but we are opposing only such so-called efficiency methods as tend to drive men to work beyond human endurance. We favor good efficiency methods.

"There is not a large employer who dares to say any more that he is opposed to organized labor. Rockefeller recently declared publicly that he is not opposed to organized labor. No matter what capitalists really think, organized labor has reached the point where employers recognize the force of public opinion back of it.

"By the abolition of child labor alone labor unions have done enough to justify their existence. In addition, we have secured legislation for safer mines, better sanitation and shop regulations."

MINES KILL 2,451 IN YEAR.

Washington.—Coal mining in 1914 cost the lives of 3.3 men in every 1,000 employed, while in the year 1913 the death rate was 3.73. This reduction means a saving of more than 300 lives, reports the United States bureau of miners. The number of miners killed for every 1,000,000 tons of coal mined in 1914 was 4.81. In the year 1913 there were 4.89 miners killed for every 1,000,000 tons mined.

"Shocking as is the violent death of 2,451 men in a year's time in a peaceful industry," said Van H. Manning, acting director of the bureau, "the men of the bureau who are engaged in the campaign to reduce this casualty list find, in comparison with other years, some indications that the improvement noted in the saving of life will be further accentuated as the years pass."

"SIXTY-HOUR" LAW A FARCE.

Charleston, S. C.—The sixty-hour law of this state is a farce, reports commissioner Watson of the department of agriculture, commerce and industries to the state legislature. The law, while providing for only sixty hours' labor in any one week, permits of the making up of lost time, and this has been so construed that enforcement of the law is absolutely impossible. The commissioner reports that state officials "have been almost overwhelmed with complaints from operatives in textile plants." He recommends that this proviso be repealed and such regulations substituted as can be enforced.

OPPOSE QUALIFICATION.

Toronto, Ontario.—Trade unionists in the Ontario province are asking that the property qualification for holding any municipal office be abolished. The injustice of this law is apparent when it is recalled that no property qualification is necessary for a candidate for the provincial legislature or the federal parliament.

FAVORS STATE COMPENSATION.

Astoria, Ore.—In an editorial on the subject of state compensation, the Morning Astorian says:

"Private interests should never be permitted to come between the employer and the injured employe, conducting a business that depends on accident and injury of human beings for its profit. Such an enterprise is no more legitimate than it would be considered a legitimate business for a private corporation to engage in policing our cities and making prosecutions for law violations. The administration of a compensation law by which the injuries of employes of our state are cared for is as much a function of government as in the maintenance of public schools, the policing of our cities and the administration of justice."

PUBLIC PAYS TRANSPORTATION.

Washington.—At least forty-three states authorize the transportation of pupils to public schools at the expense of school districts, according to a bulletin issued by the United States bureau of education. In certain states transportation at public expense is permissible only, in others obligatory. Ohio, for example, requires transportation for children two miles or more from the school, while other states require transportation when the distance is one and one-half miles or more.

In the several states the school authorities may pay parents or guardians a fixed amount per day for transportation, while Maine, Vermont, Minnesota, South Dakota and Oregon permit payment for room and board for pupils in homes convenient to the schools where the cost of so doing does not exceed the cost of transportation.

INSIST ON UNION LABEL.

San Francisco.—The board of supervisors of this city has declined to consider bids for printing from non-union firms, and has approved a proposed charter amendment making compulsory the use of the union label on all city printing. This amendment will be voted on at the special election next month, and is intended to make legal a former resolution of city officials which has been declared void by the supreme court on the ground that a union label reso-

lution is in conflict with the competitive bidding clause of the city charter.

LABOR LAW CASES ADVANCED.

Washington.—Cases involving the constitutionality of the New York alien labor law, which provided that only citizens should be employed on public works, has been advanced for argument by the United States Supreme Court to October 12. The court has already enjoined the enforcement of the law, which was upheld by the New York state court of appeals.

As a result of this decision the New York legislature modified the law by providing that citizens should be given the preference for employment on this work.

VICTIMS OF GUNMEN SUE.

New Brunswick, N. J.—Damage suits to the amount of \$120,000 have been filed here on behalf of workers who were shot by armed detectives in the employ of the American Agricultural Chemical Company, at Chrome, on January 19. The actions, for \$10,000 apiece, are similar in the twelve cases. All of the complainants were shot in the back. Attorneys for the strikers declare the case presents no new problems in law, as it will be easy to prove the liability of the company.

WILL TEST RELIEF FUND.

Cincinnati, O.—Judge Cushing has decided against the Baltimore & Ohio Southwestern railroad in its bill of demurrer against the suit of Joseph Bailey, former switchman, to recover damages. He contributed to the company's relief fund for six years, and states that when a worker leaves the service he is not reimbursed. It is further stated that 3,000 employes are compelled to be parties to this fund. The railroad asked that the case be dismissed, but this the court refused and ordered a trial.

ATTEMPT TO ADJUST STRIKE.

Oklahoma City, Okla.—Officials connected with the state labor commissioner's office are attempting to adjust the strike of oil tank builders. Nearly 2,000 men are involved. State Labor Commissioner Ashton reports that the conditions which caused the strike are "very bad."

Among Our Exchanges.

LABOR'S WORST ENEMIES.

It is reported in a press dispatch from Chicago that three labor officials were arrested on indictments charging them with conspiracy in restraint of trade. It is further reported in the dispatch that one of the number is guilty of blackmail. If the charge of blackmail, is founded on facts then such a labor official should find no room in the ranks of organized labor. The labor official who through blackmail se-

cures tribute from an employer brings a labor organization into disrepute and is a far worse criminal than the highwayman.

No labor journal can afford to defend the blackmailer, and the sooner such a "mooching" parasite is branded as undesirable and expelled from the labor union, the better it will be for the standing of the labor movement.

The labor organization cannot be held responsible for the acts of an official who

prostitutes his official position for personal aggrandizement, providing such labor organization makes it known in no uncertain language that officials who use the organization to secure dishonest revenue are unworthy of the confidence of the working class.

The blackmailer in the labor organization is labor's worst enemy and should be treated as a pariah. The labor movement should not be condemned for the disreputable acts of an official, no more than any other organization or association that has elected or appointed officials who have outraged the trust reposed within them. Christ selected twelve men to propagate the doctrines of Christianity, and yet, one among the number committed treason to the "Prince of Peace," whose religion has covered the earth and aided in the expulsion of the brute from man. Men with ulterior motives will crawl into the labor organization just the same as they crawl into the church, but neither of these institutions should be condemned, simply because some member or official has debauched himself for the price of dishonor.—John M. O'Neal in Trinidad "Free Press."

WATCH YOUR STEP.

"Look before you leap" is an old adage but should be carried under the hat band of every union man.

It is not the purpose nor the duty of a labor organization to declare a firm unfair or call a strike every time an employer of labor looks cross-eyed.

The constitutions of the several labor organizations and the American Federation of Labor contain provisions which if carefully adhered to by union members would prevent unnecessary and fruitless strife between employers and employees.

When the Creator made man He supplied him with a head and endowed him with the powers of thought. That head was placed there to use not as an ornament nor as a battering ram but as an aid to keep men out of troubles and to blaze paths toward brotherhood.

If the head was intended to be used as a battering ram it would undoubtedly have been made solid without having space for any substance such as we call the brain.

Trickery, deceit and intolerance for the opinions of others has no place in the labor movement.

The Labor World would caution union men to be careful in their proceedings, to guard against hasty action. The labor movement cannot afford to act injudiciously on any grievance that may come before them, particularly at this time. To be contrary and dogmatic will be utter folly; to be calm and precise in judgment; to consider all elements involved in any question will be the greatest of wisdom.

Watch your step, step carefully and look before you leap.—The Labor World (Duluth, Minn.)

WHAT CHINA MIGHT DO IF SHE WERE AROUSED.

Spread China on top of the United States and it would hang over Alaska and Mexico. In population it beats us better than four to one.

In the Pennsylvania anthracite region a seven-foot, free-running coal vein is now a rarity. In China's 13,500 square miles of first-class anthracite coal land, the seams average fifteen feet in thickness and often reach forty.

Thus far, no diamonds have come from China; but nature has endowed her with most everything else—coal enough to heat the world for ages; vast ore beds of iron, copper, tin, lead and zinc; gold, silver, salt and valley soils of incredible fertility.

China's coal, iron and limestone lie near together. She can supply the world with steel, and, when taught scientific agriculture, she can feed mankind.

The native Chinaman is honest, capable, industrious, quick to learn. Let him be organized for industry or war with modern methods and there are enough of him to make a mark.

Think of what Japan has done in fifty years on a group of islands not as large as Texas and you gather a hint of the tremendous stake for which she is playing in the endeavor to capture control of China.

China, vitalized as Japan has been, could, yes would, rule the world!—Milwaukee Journal.

HOW DO YOU PLAY?

It comes a bit hard to admit that the real question of life is not so much what our condition is as how we meet that condition. With repining? That brings melancholy and despair. If conditions aren't just right, the more we think and ponder over what is unfavorable, the worse they seem. The darkness looms large and so close to the mental vision that it shuts out whatever faint ray of hope may be trying to shine through. Cheerfulness lets in the light; it adds to both mental and physical power. Hope in an inspiration. By keeping the mind open hardships may be lessened, if not done away with.

It is good for us that there are some hard things to endure. It is in meeting storms and beating down obstacles that we increase our strength and mount the heights. Were all the way easy, we should never develop the muscle to climb higher. Were there no temptations, no thorns, we should lack understanding of others and sympathy. Our characters would become weakened like the unused muscles of the dervish, which in time become paralyzed and cannot be moved. However hard we have to struggle, there is someone not far away who has just as hard a time. We need sometimes to get our mind off the prize and remember that the really important thing is how we play the game.—Milwaukee Journal.

News of General Interest.

UNITED STATES COMMISSION ON INDUSTRIAL RELATIONS.

In a report to the United States Commissioner on Industrial Relations, William O. Thompson, Counsel for the Commission, announces the inauguration of machinery for collective bargaining between the government and its employes at the important Government Arsenal at Watertown, Massachusetts.

Under an order issued by Brigadier General William Crozier, Chief of Ordnance of the United States Army, grievances of the machinists and other workmen employed at the arsenal are to be adjusted by joint boards, composed of representatives of the arsenal and of the employes.

This innovation is particularly interesting because it puts collective bargaining into effect under conditions that are often said by critics of unionism to be incompatible with trade agreements. These conditions are the existence in the arsenal of a system of scientific management devised by Frederick Taylor of Philadelphia, and the fact that public necessity forbids any interference with the operations of the arsenal, as an important part of the national defense. General Crozier's action in issuing this bulletin sets a precedent and constitutes an experiment that will be watched with interest both by public and private employers. If the experiment succeeds it will prove that a democratic shop organization can be maintained side by side with so-called scientific management and in an industry where safeguards against interruption are of prime importance.

Mr. Thompson was detailed by the Commission last summer to aid in an effort to adjust the differences that threatened to arise at Watertown because of the objections of the men to the Taylor system of scientific management. He had the full cooperation and numerous conferences with General Crozier, N. P. Alifas, of the Machinists' Union, and John R. O'Leary of the Molders' Union, as well as with Colonel Wheeler, Commanding Officer of the Arsenal. The plan devised by Mr. Thompson is incorporated in General Crozier's order.

This order provides a shop board, consisting of a representative of the arsenal and of the employes in the shop where the grievance arises. In case the shop board fails to adjust the grievance it shall then be taken up by the arsenal board, consisting of an officer of the arsenal, to be selected by the commanding officer, and a representative of the employes of the whole arsenal, to be selected by the employes. In case the members of the arsenal board cannot agree they shall submit a statement of the subject in controversy to the mediation board, consisting of five members appointed as follows:

The commanding officer shall appoint from his staff an officer, who, if practicable, shall act continuously; the commanding officer shall also appoint an additional member, who may be an officer or an employe, not from the rank and file of the employes, and who must not be a party to the grievance. The employes on their part may also appoint two representatives from among themselves, the first to act as continuously as practicable; the second shall, if possible, be a representative of the craft which has the complaint before the board, but he must not be personally involved in the question for adjudication. The commanding officer and employes shall select a fifth man, who shall act as chairman of the board.

Appeal may be taken from the decision of the mediation board to a supreme mediation board, which shall consist of three members, one to be appointed by the Chief of Ordnance, once to be appointed by the crafts representing all the employes of the arsenal, and these two to choose a third member who shall act as chairman. The findings of the supreme mediation board are not to be final, but are to be subject to the approval of the Chief of Ordnance, with an appeal from him to the Secretary of War.

General Crozier's order specifically states that the "employes are understood as not waiving any objections which they may have to any method or manner of work which may be in force in the said arsenal, such, for instance, as the stop-watch elemental time studies, or the premium system of payment to employes."

In a letter from General Crozier to the commanding officer of the Watertown arsenal, incorporated in Mr. Thompson's report, General Crozier states:

"The enlargement of the privileges now existing and in practice with reference to this subject is offered with the object of giving employes as full participation in dealing with matters with which they are closely concerned as is consistent with the interest of the government and the responsibility which is devolved upon the department."

It is understood that if the experiment at Watertown proves successful the system will be extended to other arsenals.

EX-PRESIDENT TAFT DISCUSSES PROHIBITION.

New Haven, Conn. (Special News Dispatch):

"Ex-President Taft, whose recent expression of opposition to national prohibition before the Boston Bar Association aroused much comment, has taken occasion to discuss the matter more fully in a letter which he has written to Mrs. Tilton, of Cambridge, Mass. While Mr. Taft states that he was

not accurately quoted in his speech before the Bar Association, he expresses sharp criticism of prohibition laws. His letter follows."

January 3, 1915.

My Dear Mrs. Tilton:

What I said in respect to National Prohibition was misunderstood and not correctly reported. The subject of my remarks was, "The Evil of Multiplicity of Laws." I called attention to the fact that there had been passed by Congress and State Legislatures 65,000 laws in the last four years, and that such a mass of legislation was an evil of burdensome proportions, as we were rapidly finding out.

This excess of legislation I attributed to two causes. The first was the erroneous belief that any reform could be accomplished merely by legislation, and the second was that legislators were prone to enact laws, not because they believed their enforcement would do any good, or because they had their enforcement in mind, but only because their votes would profit them politically. Due to this last cause, whenever a part of the electorate in a Congressional District, not a majority, but supposed to hold the balance of power, threatened to plump their votes for or against a Congressional candidate on a particular issue, and without regard to their usual party affiliation, they were able to frighten legislators into the legislation which they, as a minority group, demanded. In this wise the amendment for National prohibition secured a majority of the members of the House of Representatives. Many members voted for it who were not really in favor of it, nor did a majority of their constituents demand it. Such members voted for it merely to secure the approval and support of a comparatively small element in the electorate whose votes they feared might defeat them if they voted their own convictions.

I then pointed out the evils of an amendment to the Constitution of the character proposed. I said that it would destroy the balance of power between the central government and the state government; that it was a direct blow at local self-government, and at the integrity of our Federal system depended on preserving the control by the states of parochial and local matters; that the regulation or prohibition of the liquor traffic was essentially a local matter, because opinions with reference to how it should be treated varied with every community. Secondly, it was dangerous because the exercise of jurisdiction to prohibit the liquor traffic would call for a horde of Federal officials in addition to the hundreds of thousands now representing the United States Government, and would give to an unscrupulous manipulator in National politics, with Federal authority, a power that would be dangerous to the republic whenever candidates were to be selected by his party, or whenever an election was to be had.

I said that the lack of sincerity in the vote for the amendment by a majority of the House, when it required two-thirds to pass, was shown by the fact that those who voted for the amendment had not attempted to exercise all the Federal authority there now was within the present Constitution. I pointed out that this majority could pass a law which would be valid, under the present Constitutional division of powers between the Federal Government and the states, declaring that intoxicating liquor should not be a legitimate subject of commerce between the states, or between this country and foreign nations. In that way Congress could hedge each state about and permit it to regulate within its own borders the manufacture, sale or use of intoxicating liquor without the receipt of liquor from the outside.

I did not say I favored such a bill, because I do not favor it. My personal view is that as long as a great majority of the states do not prohibit the manufacture and sale of liquor within their borders, it would be very unwise on the part of Congress to attempt to restrict the interstate commerce in intoxicating liquor. It may be that we shall come to the time when National public opinion will demand such legislation, but certainly we have not arrived at it now. In the matter of lottery tickets, lotteries were regarded at the beginning of the last century as a legitimate means of raising money for many purposes. In a century, the attitude of the public changed toward lotteries, so that there was only one state in the Union that permitted them—Louisiana—and there grew up to be a very strong sentiment in that state against their continuance. Thereupon Congress rightly passed a law making the sale of lottery tickets across state lines illegal. But we certainly have not reached such a condition with respect to the manufacture and sale of intoxicating liquors.

I vetoed the Webb law making illegal the transportation of liquor into states which forbade its manufacture and sale, because it was not uniform in its application to all parts of the United States, and was an attempt to delegate to individual states the power to regulate Interstate Commerce in violation of the Constitution. The question is now pending in the courts.

In my remarks I said also that this appeal to Congress for an amendment to the Constitution by the people of the states where prohibition laws were now in force, was a humiliating confession of the ineffectiveness of those laws in such states in their local communities in which a majority of the people do not sympathize with the officers of the laws in enforcing them.

I think the solution of the liquor question is in local option, by which the sale of liquor is forbidden in communities that by the expression of a majority of the voters show that public opinion will sustain the enforcement of such a law. To pass laws forbidding the manufacture and sale of liquor and then have large parts of a state

where liquor is sold freely and in defiance of the law is a demoralization of all law that is most detrimental to the interest of the whole community.

These shortly stated are my views with respect to the prohibition question. Of course they could be elaborated, but I think I have answered your queries as to my position, and I hope I have corrected the erroneous impression that was given by the report of my remarks at the Bar Association.

Sincerely yours,

WM. H. TAFT.

Mrs. Elizabeth Hewes Tilton, 11 Mason Street, Cambridge, Massachusetts.

AN ITALIAN FOUR-CYLINDER PRAIRIE LOCOMOTIVE.

By Frank C. Perkins.

A four-cylinder compound prairie locomotive shown in the accompanying illustration was constructed at Milan, Italy, at

the American Association for Labor Legislation. The report attacks the New Jersey system for having fixed the basis for compensation too low. Under the act the injured worker is entitled to only two weeks' medical attendance with a \$50 maximum and to 50 per cent of his wages. This, remarks the report, is one of the lowest scales in the country.

Recent laws tend to fix compensation on a more liberal scale. New York and Ohio started with a 66 2-3 per cent scale. Massachusetts, after two years experience with 50 per cent, recognized its inadequacy and raised it to 66 2-3 per cent, at the same time very greatly extending the period of payments. In a dozen states this year active legislative campaigns to establish compensation on a basis of 66 2-3 per cent are in progress.

Family life cannot be maintained on \$5 or \$6 a week and this is all that numbers of New Jersey families are entitled to have

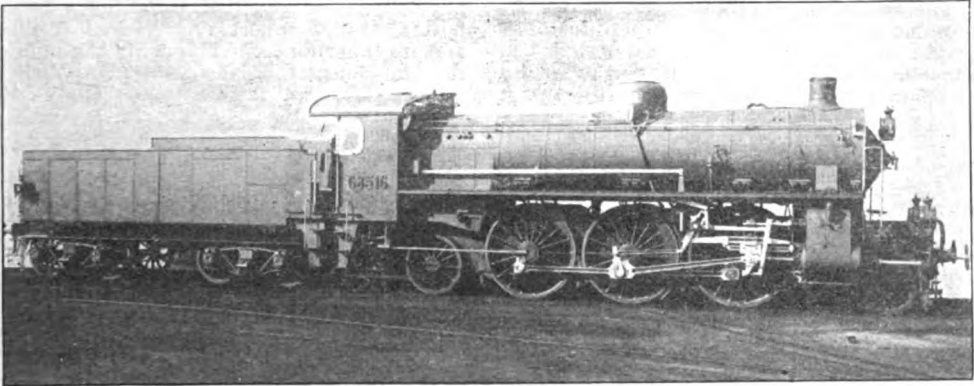

the works of the Societa Italiana Ernesto Breda, and is in use by the Chemins de fer de l'etat italien.

This engine has four cylinders, 420 mm. in diameter, with a stroke of 650 mm. The diameter of the driving wheel is 1.85 meters and the fixed wheel base measures 1.95 meters, while the total is 3.45 meters.

The boiler has a total heating surface of 242.8 square meters, of which 178.2 square meters represent the heating surface of the tubes and 52.4 square meters the steam super-heated surface, while the area of the grate is 3.5 square meters. The amount utilized being 12 kilograms. This engine develops 1,300 horsepower and has a maximum traction effort of 10,580 kilograms.

The total weight of the engine and tender combined is 120,400 kilograms. The weight of the tender in service is 49,600 kilograms, and of the locomotive, 70,800.

HALF OF WORKERS' WAGES INSUFFICIENT COMPENSATION.

Half of the workers' wages is an inadequate proportion for compensation, according to a report on the New Jersey Compensation law which has just been issued by

during disablement under the existing law, since, according to a report of the New Jersey Bureau of Labor Statistics of 1912, 48 per cent of all employes engaged in manufacturing receive \$10 or less per week in wages. In consequence of the low scale of payment many injured workers were found whose wives and children had been compelled to seek poorly paid work or to beg for charity.

Compensation at a rate which does not allow for the continuance of the family life of the worker defeats its own ends, the worker suffering deprivation and hardship while the community is left to support the family through one channel or another.

Medical Treatment Important.

Medical aid, it is urged, should be determined solely by what is necessary for the injured worker in order that he may return to his work as soon as possible. The limits set by the Jersey laws are illogical and indefensible. If the worker should lose the medical attendance needs at the end of a fortnight, his prolonged disablement is not only to his own injury, but is contrary to the interests of his employer.

Strong objection is raised to the New

Jersey system by which a workman is compelled to accept the services of the doctor selected by his employer or to pay all his own medical expenses. The existence of a Board for the administration of the law which would make impartial provision for necessary medical aid would greatly improve the existing system.

Insurance for Compensation Necessary.

The report strongly urges the policy of compulsory insurance for compensation. Compensation breaks down completely when firms which have not insured their workers against accident become bankrupt. In a number of cases in New Jersey, after favorable settlement in the courts had been obtained injured workers or their dependents have not received any compensation owing to the failure of the firm from which payments were due.

THE LARGEST LOCOMOTIVE CRANE IN THE UNITED STATES.

By Frank C. Perkins.

The accompanying illustration shows the new mammoth locomotive crane installed at the New York navy yard, as designed at Cleveland, O., and believed to be the largest locomotive crane in the world, although it

boom, which adds 38 feet, and from which the auxiliary hoist is suspended, was particularly designed for handling the basket masts which are peculiar to the new dreadnaughts. Hitherto there has been no crane of sufficient radius to handle these masts as a unit.

THE PROCEEDINGS OF THE NATIONAL ACADEMY OF SCIENCES.

Beginning with January, 1915, the National Academy of Sciences has instituted the issue of a monthly journal, the Proceedings, which, in addition to being the official organ of publication of the Academy, will serve as a medium for the prompt presentation of brief original papers by members and other American investigators. Its aim will be thus to furnish a comprehensive survey of some of the more important results of the scientific research of this country, and it is intended to supplement, not replace, the papers appearing in special journals. The first number of the Proceedings contains, among others, papers on physiology and genetics, including a contribution by Davenport on "Violent Temper and Its Inheritance." This is, in the opinion of The Journal of the American Medical Association, an attempt to study the

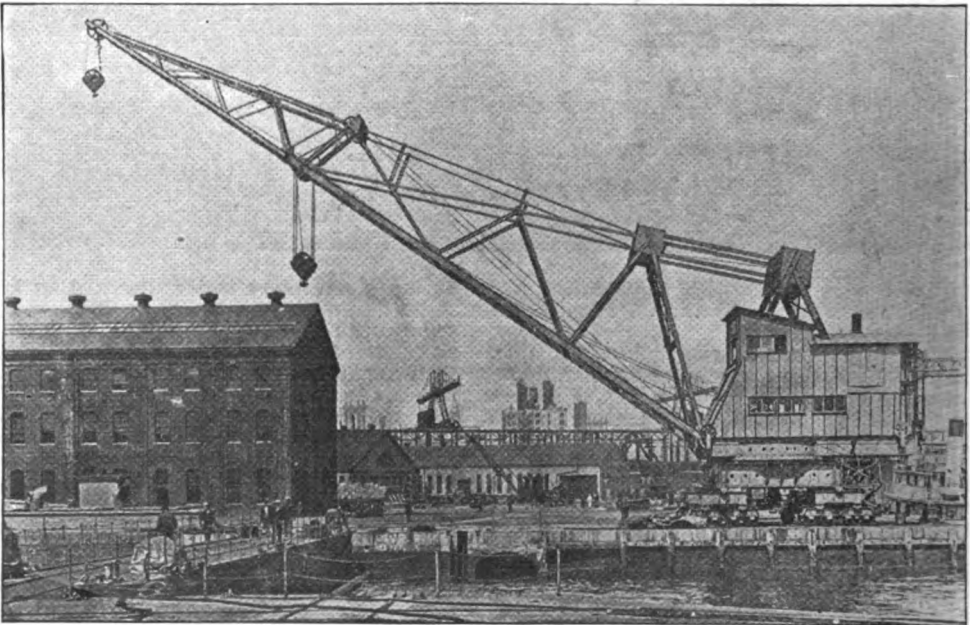

is pointed out that the upset state of affairs in Europe makes it extremely difficult to fully corroborate this, but the assertion that it is the largest in the United States is beyond question. The main boom is 75 feet in length and has capacity of 50 tons at the full radius.

The main hoist is placed at the end of this and is used for conveying boilers, armor plates, big guns and engines, which are used in the large warships. The auxiliary

hereditary behavior of some of the elements of moral action—to analyze, by the methods of the Eugenics Record Office, the family history of persons who have marked emotional traits. Violent and more or less periodic outbursts of temper occur in families which are characterized by prevalence of epileptic attacks; also in those exhibiting cases of mania, and in others in which "hysterical" attacks are common. The special form of the attacks differs somewhat

in these classes of families, but the method of inheritance of the tendency is the same in all, and it seems probable that in each class the simple symptoms of the emotional outburst are modified by the differences in these three classes of the nervous condition. The fact that the tendency to outbursts of temper does not skip a generation, according to the report of 165 family histories of wayward girls in state institutions, indicates that it is a positive or dominant trait. This tends to emphasize that such features have a typical hereditary basis, a statement which many sociologists who hold differences in the "conditions of life" responsible for the differences in men, are quite likely to dispute.

A ONE-PIECE STEEL END FREIGHT CAR.

By Frank C. Perkins.

The accompanying illustration shows a one-piece steel end freight car of great strength. It is maintained that the concentric corrugated one-piece end, pressed as shown, insures every inch in the entire end being of equal strength.

There are no posts, braces or rivets required in the entire end and it is held that no built-up end could compare with it for

amount of claims to be paid. The steel ends strengthen as well as prevent damage to the car bodies, reducing loss of earning capacity as well as repair costs.

A CO-OPERATIVE MAIL ORDER HOUSE.

The prevailing conception of a labor union is that its only function is to instigate strikes for the purpose of increasing wages, shortening hours and creating a monopoly of employment for its members. Correct information as to the educational and beneficial work the unions are doing is available only to those who are readers of the labor press.

Whenever organized labor breaks into the columns of other newspapers it is because of some strike, some judicial decision, some law suit, or to give publicity to a tirade by some union hater. Then organized labor is depicted as a dictator, a criminal, a thug, an un-American institution that should not be tolerated in a free country.

Very seldom is mention made of the beneficial activities connected with the general scheme of organization, such features as sick and death benefits, out-of-work relief, old age pensions, homes for the aged, schools for apprentices, correspondence



strength. It keeps the car in perfect alignment and allows a foot more space inside the car. It is said to give better protection to the contents of the car and it is said these ends assure that a car will be continuously in service.

The ends are flanged to fit any class of car, old or new, and the method of flanging at the edges gives great strength at the corners. It is claimed that the one-piece steel end triples the life of the car, reducing the amount of depreciation per year and prevents damage to lading, thereby reducing

courses for journeymen, and the legislative work in congress and state legislatures, where laws are urged for the abolition of child labor, the protection of women in industry and the safeguarding of the health and lives of all who work. These are matters with which organized labor is occupied continuously.

Hostile organizations of employers are abandoning the idea that the American labor movement can be destroyed or even curbed. They see the membership of the A. F. of L. increasing each year; they see labor enlarg

ing its influence among the law makers of the land; there is recognition of its power and aggressiveness, new plans for widening its sphere of usefulness are constantly being advocated and inaugurated.

Whenever labor break new ground, when it reaches out into hitherto untried fields of endeavor, the experiment is eagerly followed by all who are in sympathy with the movement, who give time and thought to the progress of the workers. The latest attempt to draw the hosts of labor more solidly together is to concentrate their purchasing power for the benefit of union label products of all kinds.

About a year ago there was organized in New York City a co-operative association of union men and women, known as the Union Label Products Trading Association, which has in view the finding of a larger market for the sale of union label goods. The general plan is to establish in all large cities retail stores where only union label goods will be sold. Also to sell goods by the mail order method, made possible by the introduction of the parcels post.

On September 12, 1914, an office and sales-room was opened in the World Building, New York City. A large stock of men's furnishings, cigars and cigarettes, pocket knives, household articles and many special lines of women's wear has been assembled. An illustrated mail order catalog has been issued, and sent to trades unionists and sympathizers whose names could be secured. The results thus far have been very satisfactory, enough orders have been received to encourage the Association to enlarge its lines and increase its stock of goods. The goods handled are the best that can be obtained from the most reliable union manufacturers. No attempt is made to have customers pay extra for the union label, the prices being no higher than are paid for non-label goods.

The enterprise has the endorsement of the leaders of the American labor movement, men prominent in its councils being members of the Association. Official recognition was given to the Association by permitting Mr. George Stein, its vice-president, to address the last A. F. of L. convention in Philadelphia, and by being listed in the Official Directory of the Union Label Trades Department of the A. F. of L.

The Association is organized under the laws of the state of New York, with a capital stock of \$50,000. Shares are sold at \$10.00 each, and no one can own more than fifteen shares. There are at present 275 shareholders and the list is increasing rapidly. It is the intention to secure members in all parts of the country. These members becoming active boosters, salesmen and customers. Members of all crafts are welcome.

The certificate of organization provides that the association has the right to sell at retail, to become wholesalers and jobbers, and to engage in manufacture. A plan that comprises all the features of the large and successful co-operative enterprises which

have for so many years been profitably conducted by the workers of Europe.

Literature, details and catalog can be secured by writing to Union Label Products Trading Association, 527 World Bldg., New York City.

WAGES AND HOURS OF LABOR IN THE BUILDING AND REPAIRING OF STEAM RAILROAD CARS, 1907 TO 1913.

The Bureau of Labor Statistics of the United States Department of Labor has just published as Bulletin No. 163 a report on wages and hours of labor in the building and repairing of steam railroad cars. The report is based on information obtained from the principal representative establishments in the industry. Figures are presented in this Bulletin for rates of wages per hour and full-time hours of labor per week for the years 1907 to 1913 and for full-time weekly earnings for 1910 to 1913.

Full-time weekly earnings of the employes in the principal occupations in this industry in 1913 were 5.5 per cent higher than in 1912, 6.0 per cent higher than in 1911, and 8.9 per cent higher than in 1910; average rates of wages per hour for 1913 were 6.3 per cent higher than in 1912, 6.4 per cent higher than in 1911, and 9.9 per cent higher than in 1910; the full-time working hours per week in 1913 were 0.7 per cent lower than in 1912, 0.4 per cent lower than in 1911, and 1.1 per cent lower than in 1910.

The data for 1913 were obtained from 73 representative establishments and covered over 42,000 employes. The average full-time weekly earnings in 1913 in the principal occupations in these representative establishments were as follows:

Cabinetmakers	\$19.03
Carpenters and car builders, wood	17.11
Car repairers	15.15
Fitters	15.99
Laborers	10.58
Machine woodworkers	16.26
Machinists	17.81
Painters	17.77
Pipe fitters	18.56
Riveters and buckers	19.41
Tinners	19.23
Truck builders	15.31
Upholsterers	19.50

In 1913 the full-time hours of labor per week were under 54 in quite a number of the establishments visited and over 60 in but very few. The predominating full-time hours per week were 54 and the average about 56.

NONE EVER REALLY LOST.

(From the Kansas City Star.)

The ferryman, while plying over a water which was only slightly agitated, was asked by a third woman in his boat whether any persons were ever lost in that river.

"Oh, no," said he. "We always finds 'em again the next day."

Smiles.

THE LORD'S WAY.

When James A. Garfield was president of Oberlin College a man brought for entrance as a student his son, for whom he wished a shorter course than the regular one.

"The boy can never take all that in," said the father. "He wants to get through quicker. Can you arrange it for him?"

"Oh, yes," said Mr. Garfield. "He can take a short course; it all depends on what you want to make of him. When God wants to make an oak he takes a hundred years, but He only takes two months to make a squash."—Ladies' Home Journal.

WHAT IS THE ANSWER?

"Mother," she began, "what does trans-Atlantic mean?" "Across the ocean," replied her mother. Then, "Does 'trans' always mean across?" "Yes, it does, always," and the mother added sternly, "If you ask me another question tonight I shall send you to bed!" The second silence lasted quite three seconds. It was broken at last by a plaintive, small voice, which commented, "Then I suppose transparent means a cross parent!"

ONLY JOKING.

A negro was lying down during the noon hour, sleeping in the hot sun. The clock struck one, the time to pick up his hod again. He rose, stretched and grumbled: "I wish I wuz daid. 'Tain' nothin' but wuk, wuk from mornin' till night."

Another man, a story above, heard the complaint and dropped a brick on the grumbler's head.

Dazed, he looked up and said:

"Da Lawd can stan' no jokes. He jes' takes ev'rything in yearnist."—Kansas City Star.

DISTINGUISHED.

"Who is that haughty looking woman on the right?"

"That is Signora Juarez-Torreon-Varanza-Quilla of Mexico."

"And what are those badges, buttons and medals with which she is almost covered?"

"Why, she's a daughter of 329 revolutions."—Judge.

"Why, Willie," said the teacher in a pained voice, "have you been fighting again? Didn't you learn that when you are struck on one cheek you ought to turn the other one to the striker?"

"Yes'm," agreed Willie, "but he hit me on the nose and I've only got one."—Sacred Heart Review.

NEVER SAW A BUN DANCE.

It was the grammar lesson, and the teacher was explaining the difference between a common and abstract noun.

"An example of a common noun is dog," she said, "for you can see it, while you cannot see anything that is an abstract noun. For instance, have any of you seen abundance?"

There was silence for about a minute. Then a little boy got up and said:

"Please, ma'am, I have never seen a bun dance, but I have seen a cake walk."—Hamilton, Can., Labor News.

EARLY SIGNS.

"What makes you think the baby is going to be a great politician?" asked the young mother, anxiously.

"I'll tell you," answered the young father, confidently, "he can say more things that sound well and mean nothing at all than any kid I ever saw."

ENCOURAGING.

Catcalls and groans, vegetables and eggs are directed at the stage, but still the well-meaning performer, who is in the midst of a long monologue, continues to recite his lines.

Finally a despairing spectator hurls a boot on the stage, and the actor starts to retreat behind the scenes.

"Keep on playing!" cries the manager in the wings. "Keep on till we get the second boot!"

THOUGHTFUL OF HIM.

Houseman—If I'd known you were going to drop in on us so unexpectedly, we would have had a better dinner.

Horton—Don't mention it, old man; but next time I'll be sure to let you know.—Boston Transcript.

DIDN'T NOTICE HER.

"Did you notice that lovely girl in the pretty brown dress, waiting in the lobby?" he asked his wife as they took their seats in the theater.

"What! That frowsy thing with the false puffs, enameled face, gold teeth, made-over dress, imitation mink furs, and torn gloves? No, I didn't notice her. Why?"—Puck.

"What have you there, son?"

"Ten beans."

"Beans? Do you mean dollars?"

"Yep."

"Why don't you call money by its right name?"

"Ain't beans a good enough name for money?"

"Not for you. You never plant any."—Atlanta Constitution.

VICTRESS.

"Madam," said the man in the street car, "I know I ought to get up and give you my seat, but unfortunately I've joined the Sit Still Club."

"That's all right sir," replied the woman. "And you must excuse me for staring at you so hard; I am a member of the Stand and Stare Club."

She proved herself so active and conscientious a member that the man began to feel uncomfortable under her gaze. Finally he rose and said: "Take my seat, madam; I guess I'll resign from my club and join yours."—Boston Transcript.

AT PUBLIC EXPENSE.

Visitor (sampling stout with evident appreciation)—Really, this is splendid stuff. They say that it is both meat and drink.

Workman (interrupting)—Shure, it's roight ye are, sor; an' if ye take plenty av it it'll foind ye lodgings."—Strauss Program Magazine.

In a country store a young boy was under discussion by the cracker-barrel committee. Jones had just remarked, "That boy's a regular fool. He don't know nothing; he don't know enough to come in when it rains." Then he discovered the boy's father, who had overheard the remark, and, wishing to appease him, he said: "Well, Sam, 'tain't all your fault. You learned him all you knew."—Exchange.

HE UNDERSTOOD.

A teacher was trying to find from a tiny child the name of his father. He seemed quite unable to think of it, so, to help him, she asked:

"What do you call him?"

"I call him father," was the reply.

"Well, what does your mother call him?"

The response was eloquent of the manners of the neighborhood. "She doesn't call him anything—she likes him."—Ex.

SOME HINT.

"Hello, Blank! Where are you going in such a hurry?"

"To the postoffice to put up a kick about the wretched delivery service."

"What's the trouble?"

"Why, that check you promised to send me ten days ago hasn't reached me yet."

"I've seen better days, mum," said the tramp at the door. "I once did business in Wall street."

"You surprise me," said the sympathetic housewife. "Did you deal in stocks and bonds?"

"No, mum. Pencils wuz me line."—Birmingham Age-Herald.

Small Boy—"Good fishin'? Yessir; ye go down that private road till ye come to th' sign 'Trespassers Will Be Prosecuted,' cross the field with th' bull in it an' you'll see a sign 'No Fishing Allowed'—that's it."—Life.

Poetical Selections.

CLING TO THOSE WHO CLING TO YOU.

There are many friends of summer,

Who are kind when flowers bloom;

But when winter chills the blossoms,

They depart with the perfume.

On the broad highway of action,

Friends of worth are far and few;

So when one has proved his friendship,

Cling to him who clings to you.

Do not harshly judge your neighbor,

Do not deem his lift untrue

If he makes no great pretensions—

Deeds are great, though words are few.

Those who stand amid the tempest,

Firm as when the skies are blue,

Will be friends while life endureth—

Cling to those who cling to you.

When you see a worthy brother

Buffeting the stormy main,

Send a helping hand fraternal

Till he reach the shore again.

Don't desert the old and tried friend

When misfortunes come anew,

For then he needs friendship's comforts—

Cling to those who cling to you.

—Harold C. Keyes.

HEART STRINGS.

The strings of my heart are slender,

But so many they form a strand,

And the ties they bind, though tender

Are as strong as an iron band.

Loyal the ties of Friendship,

Precious the faith and trust,

That a friend who will help us in trouble

From a sympathy—not that he must.

Sweet are the ties of Duty

When conscience they obey;

To others bearing blessings—

"Well done" their reward away.

Vibrant the ties of Love are

To the music of Love's command,

Though sacrifice be their portion

Hearts are happy that understand.

The strings of the heart are slender,

But so many they form a strand,

And the ties they bind though tender

Are strong as an iron band.

—Amelia Day Campbell, in the Union Leader.

THE FARMER.

My hands are gnarled and horny,
 My face is seamed with sun,
 My path is sometimes thorny,
 My living grimly won
 By labor unremitting
 And hard and bitter toll;
 Forever I am pitting
 My strength against the soil.

The city's lights and glamor
 Are not for me to know,
 But neither is its clamor,
 Its squalor and its woe,
 Not mine its pleasure places,
 But mine the good brown lome
 The air, the open spaces,
 The quiet peace of Home!

And, though by all my labor,
 I win no mighty prize,
 I still can face my neighbor
 And look him in the eyes;
 I am no speculator
 Within the wheat-pit hurled;
 I am the wealth-creator
 Who helps to feed the world.

One with the Empire-makers
 Who bring a better day,
 I till my thrifty acres
 And bow to no man's sway;
 My gold might heap up faster
 Were I to crook the knee,
 But no man is my master
 And I am strong—and free!
 —Selected.

WILL THE LIGHT BE WHITE?

"Oft, when I feel my engine swerve,
 As o'er strange rails we fare,
 I strain my eyes around the curve
 For what awaits us there.
 When swift and free she carries me,
 Through yards unknown at night,
 I look along the line to see
 That all the lamps are white.

"The blue light marks the cripple car,
 The green light signals slow;
 The red light is a danger light,
 The white light, 'let her go.'
 Again the open fields we roam,
 And when the night is fair,
 I look up in the starry dome
 And wonder what is there.

"For who can speak of those who dwell
 Behind the curving sky?
 No man has ever lived to tell
 Just what it means to die.
 Swift toward life's terminal I tread,
 The run seems short tonight.
 God only knows what's at the end—
 I hope the lamps are white!"
 —Cy Warman.

DISARMAMENT.

"Put up thy sword!" The voice of Christ
 once more
 Speaks in the pauses of the cannon's roar.
 Oh, men and brothers! Let that voice be
 heard.

War fails; try peace; put up the useless
 sword!

Fear not the end. There is a story told
 In eastern tents, when autumns night grow
 And round the fire the Mongol shepherds sit
 With grave responses listening unto it.
 Once, on the errands of his mercy bent,
 Buddha, the holy and benvolent
 Met a fell monster, huge and fierce of look,
 Whose awful voice the hills and forests
 shook.

"Oh, son of peace!" the giant cried,

"Thy fate
 Is sealed at last, and love shall yield to
 hate."

The unarmed Buddha looking, with no trace
 Of fear or anger, in the monster's face
 In pity said, "Poor fiend, even thee I love."
 Lo, as he spake the sky tall terror sank
 To hand breadth size; the huge abhorrence
 shrank

Into the form and fashion of a dove,
 And where the thunder of its rage was
 heard

Circling above him sweetly sang the bird,
 "Hate hath no harm for love," so rang the
 song.

"And peace unweaponed conquers every
 wrong."
 —Whittier.

THE STAY-AT-HOME.

Who shirks his duty year by year,
 And thinks he's paying rather dear,
 And at fraternity sneer?
 The Stay-at-Home.

Who first is sure his teeth to gnash,
 And swear the lodge has gone to smash,
 When called upon to pay his cash?
 The Stay-at-Home.

Who wiggles like an angle worm
 If asked to serve a single term,
 And pleads his health is now infirm?
 The Stay-at-Home.

Who chews the rag with great delight,
 And says some folks ain't doing right,
 And remains away each meeting night?
 The Stay-at-Home.

THE CHEERFUL SPIRIT.

If you will sing a song as you go along,
 In the face of a real or fancied wrong,
 In spite of the doubt, if you'll fight it out,
 And show a heart that is brave and stout;
 If you'll laugh at the jeers and refuse the
 tears,

You'll force the ever-reluctant cheers
 That the world denies when a coward cries,
 To give to the man who bravely tries,
 And you'll win success with a little song
 If you'll sing the song as you go along.

—B. McCain Fields.

HIS DAUGHTER'S VOICE.

Patrick sat in the kitchen watching his wife peel potatoes. Mary Ann, their daughter, was in the front room playing the piano and singing at the top of her voice.

"Patrick," said his wife, "phwat does the singing tacher mane when he says, 'Mary Ann's voice is mellow?'"

"Oh," said Patrick, "that's jest a nice name for rotten. These music fellers they do be so polite."

MATTER OF TASTE.

Herlock Sholmes, the detective, had just made another great deduction.

"Our baby," he remarked, "has a natural taste for music."

"But how do you know that when he isn't two years old yet?" queried Doctor Squatsom.

"He has got nearly all the polish gnawed off the lower half of the piano," explained the peerless sleuth.

In Memoriam

Members.

Ole Isaackson, Reg. No. 34707, age 41, of Lodge No. 165, Duluth, Minn.; born Norway, died Feb. 21, 1915, from blood vessel bursting in head. Married, leaving two children. Member two years and five months.

Ottmar Rebstock, Reg. No. 89087; age 50 years; of Lodge No. 80, Anaconda, Mont.; born in Germany, 1865; died Feb. 17, 1915; killed by car at shop; single. Member three years the 15th of April.

M. Mosley, Reg. No. 47006; charter member of Local No. 196, Helpers' division, Port Arthur, Tex.; initiated 9-17-1905, died Feb. 18, 1915, in Houston, Tex., of pneumonia; age 30 years; buried Port Arthur, Tex.

E. A. Merton, Reg. No. 102000; initiated 8-11-14, Lodge No. 305, Port Arthur, Tex.; died March 3, 1915, of pneumonia at Port Arthur, Tex.; buried in Port Arthur. Age 47.

MALLEY.

E. K. Malley, Reg. No. 73974, of Lodge No. 30, Roanoke, Va., was born in Richmond, Va.; died December 11, 1914; married; member four years and six months. Age 34 years.

Lodge Notices

E. L. Chafin—Lodge No. 587.

We have suspended Brother E. L. Chafin for not paying dues or honest debts. I, myself, loaned this brother some money to bury his little child, and he will not pay it back. He also owes several bills that he won't pay.

C. C. MADDY, C. S. L. 587.

J. E. Welch—Lodge No. 568.

Any secretary taking up the card of Brother J. E. Welch, Reg. No. 42294, will confer a great favor by notifying the undersigned. Or if Brother Welch reads this it will be to his interest to write to the secretary of Lodge No. 568.

A. W. RICKETT.

W. M. Horstmeyer—Lodge No. 381.

Any secretary taking up the card of

Relatives.

Mrs. Lena Martin, mother of Brother John Martin of Lodge No. 227, Chicago, Ill., died at her home, Lemont, Ill., Feb. 17, 1915; age 62 years.

Mrs. Wm. Powers age 37, wife of Brother Wm. Powers of Lodge No. 206; born New Orleans; died Feb. 15, 1915.

Patrick Shea, 80 years, father of Joseph T. Shea of Lodge No. 442; born County Kerry, Ireland; died Feb. 18, 1915.

Master Ethan Allen Johnson, age 3; son of Brother and Mrs. E. A. Johnson of Lodge No. 200, died February 17, 1915.

Alex Kruinski, age 42, brother of Philip Kruinski of Lodge No. 227, born in Germany, Feb. 24, 1873, died Feb. 26, 1915; dropsy.

Daniel Joseph Collins, member Lodge No. 515, Everett, Mass., age 56, born in Ireland, died February 20, 1915. He leaves a wife and five children. Cause of death, from accident to head about five years ago.

Brother W. M. Horstmeyer, Reg. No. 9735, please hold same and correspond with Joe Wilson, secretary Lodge No. 381, Amarillo, Tex., as this brother borrowed some money from this lodge which he has forgot to return.
JOE WILSON, L. 381.

LIST OF MEMBERS PREVIOUSLY ADVERTISED

L. D. Landuall, Reg. No. 87263, left Teague, Tex., owing a grocery bill of thirty-nine dollars and ninety-five cents (\$39.95). He is wanted by Mrs. John Cure, Teague, Tex., who stood good for the amount.

T. D. Swain, Reg. No. 38826, by Lodge No. 567, for non-payment of a note of seventy-five dollars (\$75.00).

R. L. WHITE,
Cor. Secretary Lodge No. 567.

H. E. or Earnest Robertson is wanted by Lodge No. 173, for failing to make good some money he borrowed.

J. P. TAYLOR, Lodge No. 173.

Stewart et al—Lodge No. 66.

Any secretary taking up the card of Edgar Stewart, Reg. No. 21232, or Noble C. Townsen, Reg. No. 62088, will please correspond with the secretary of No. 66, Little Rock, Ark., as these brothers misrepresented facts and secured transportation out of Little Rock and Lodge No. 66 had to pay for same.

E. WORTHSMITH,
Corresponding Secretary No. 66.

Trials, Fines, Etc.

Diedrich—Lodge No. 305.

This is to certify that Walter G. Diedrich, Reg. No. 103300, was tried by Lodge No. 305, and found guilty of violating the laws of our Brotherhood by returning to work on the Reeves Bros. contract job after strike had been declared, and was fined \$1,000 and suspended for 99 years. He is not entitled to recognition in any way from the officers or members of this Brotherhood until such judgments are satisfied.

C. L. BRAGG, Pres.
T. O. RILEY, Sec'y.



Boiler Makers' Tools

We make a specialty of boiler tools and have a complete line of the following:

- Roller Flue Expanders
- Sectional Flue Expanders
- Pneumatic Flue Expanders
- Arch Flue Expanders
- Tube Cutting Machines for Locomotive Tubes
- Safety Sectional Expanders with Quick-Acting Knockout
- Beading Tools
- Superheater Flue Expanders

If you want special tools, submit blue-print or templates and we will furnish estimates.

J. Foessler Mfg. Co.

Moberly, Mo.

Railway Exchange Bldg.
ST. LOUIS, MO.



Can you Spare 2 Cents a week ?

That is all it will cost you to obtain the best, most interesting and timely information about the Boiler Making Industry.

THE BOILER MAKER, a monthly magazine devoted exclusively to your interests, prints everything worth knowing about Boiler Designing, Building and Repairing. This magazine would be a big help to you in your work and would keep you in touch with all modern methods and improvements.

The yearly subscription price of **THE BOILER MAKER** is only \$1.00—an average cost of less than 2 cents a week.

Clip the coupon below, fill it in and mail it to us with \$1.00. You will find that your investment of 2 cents a week will bring you immense returns.

The Boiler Maker

17 Battery Place New York City

COUPON

The Boiler Maker,
17 Battery Place, New York City.

Gentlemen:

For the attached \$1.00 enter my subscription to **THE BOILER MAKER** for one year to begin with the next issue.

Name

Address

Occupation

OFFICIAL ROSTER—International Officers

J. A. FRANKLIN.....International President
Room 15, Law Bldg., 721 Minnesota Ave., Kansas City, Kas.

F. P. REINEMEYER.....Int. Secretary-Treasurer
Rooms 10 to 12 Law Bldg., 721 Minnesota Ave., Kansas City, Kas.

JAMES B. CASEY.....Editor-Manager of Journal
Room 9, Law Bldg., Kansas City, Kas.

A. HINZMAN.....First Int. Vice-President
Room 15, Law Bldg., 721 Minnesota Ave., Kansas City, Kas.

MISSOURI AND MISSISSIPPI DISTRICT.
States of Iowa, Missouri, Kansas, Nebraska, Arkansas, Mississippi, Alabama (other than Mobile), Tennessee, North and South Dakota, Oklahoma and Minnesota.

THOS. NOLAN.....Second Int. Vice-President
700 Court St., Portsmouth, Va.

GULF AND SOUTH ATLANTIC DISTRICT.
States of Texas, Louisiana, Florida, Georgia, North and South Carolina, Virginia, Maryland and Delaware, and Mobile, Ala.

J. P. MERRIGAN.....Third Int. Vice-President
91 Manufacturer St., Montreal, Que., Can.
CANADIAN DISTRICT.
The Dominion of Canada.

LOUIS WEYAND.....Fourth Int. Vice-President
6201 Fir Avenue, N. W., Cleveland, Ohio.
GREAT LAKES AND TERRITORY DISTRICT.
States of Wisconsin, Michigan, Cities of Chicago, Toledo, Cleveland and Lorain, O., Erie, Pa., State of New York (other than the City of New York).

WM. ATKINSON.....Fifth Int. Vice-President
213 South Pittsburg St., Spokane, Wash.
ROCKY MOUNTAIN AND PACIFIC COAST DISTRICT.

Honolulu, States of California, Oregon, Washington, Idaho, Utah, Nevada, Montana, Wyoming, Colorado, Arizona, Old Mexico, New Mexico and Canal Zone, Panama.

JOHN J. DOWD.....Sixth Int. Vice-President
Home address, 168 Wilkinson Ave., Jersey City, N. J.

EASTERN SEABOARD DISTRICT.
States of Maine, New Hampshire, Vermont, Massachusetts, Rhode Island, Connecticut, New Jersey and New York City.

M. A. MAHER.....Seventh Int. Vice-President
1401 Center St., Portsmouth, Ohio.

OHIO VALLEY AND TERRITORY DISTRICT.
States of Pennsylvania (other than the city of Erie), Ohio, West Virginia, Kentucky, Indiana and Illinois (other than the City of Chicago).

JOS. P. RYAN.....Eighth Int. Vice-President
5830 Wentworth Ave., Chicago, Ill.
Phone Wentworth 8739.

HELPERS' VICE-PRESIDENT OF WESTERN DIVISION.
All states west of dividing line between Indiana and Ohio.

JOHN F. SCHMITT.....Ninth Int. Vice-President
1489 N. Fourth St., Columbus, Ohio.

HELPERS' VICE-PRESIDENT OF EASTERN DIVISION.
All states east of dividing line between Indiana and Ohio.

District Lodges and Officers

DISTRICT No. 2—New York.
N. Y. Meets 1st and 3rd Wed.
Patrick T. Kenneally, President, 9 Magnolia Ave., Jersey City, N. J.

Wm. Brown, Vice-Pres., Elizabeth Ave., Elizabeth, N. J.

Gerald A. Daly, Sec.-Treas., 676 60th St., Brooklyn, N. Y.

DISTRICT No. 5—St. Louis, Mo.
Mo. Pac. and Iron Mountain R. R. Lodges represented: 32, 38, 44, 68, 82, 106, 113, 117, 286, 322, 403, 507, 521, 542, 543, 565, 583 and 599.

John C. Morrow, Pres., 613 W. 4th St., Coffeyville, Kans.

Hal. Stack, Vice-Pres., Van Buren, Ark.

John J. Murphy, Secy., 3404 Eads Ave., St. Louis, Mo.

J. N. Shirley, Treas., Box 495, Holington, Kans.

A. E. Stewart, Member Ex. Board, 2533 Myrtle Ave., Kansas City, Mo.

A. J. Radford, Member Ex. Board, 624 Oak St., Little Rock, Ark.

Chas. A. McDonald, B. A., 4414 Winsor St., Kansas City, Mo.

DISTRICT No. 6—Southern Pacific R.R. Lodges represented: 32, 33, 46, 48, 52, 74, 92, 49, 98, 101, 113, 179, 193, 206, 216, 223, 239, 252, 309, 345, 339, 538, 553, 169.

J. J. Jones, Pres. and C. S., 1630 New Hampshire Ave., Los Angeles, Cal.

J. C. Carroll, V.-P., North Platte, Neb.

S. T. Feazelle, Sec.-Treas., Gate City Hotel, Pocatello, Idaho.

DISTRICT No. 10—Davenport, Ia.
Rock Island System. Lodges represented: 377, 144, 346, 199, 340, 293, 323, 434, 439, 491, 96, 32, 66, 476, 522, 523.

Geo. W. Pring, Pres. & B. A., 677 38th St., Des Moines, Ia.

John Mitchell, V.-P., 1502 McGowan St., Little Rock, Ark.

S. T. Sample, C. & F. S., 515 N. Jackson St., Pratt, Kas.

J. J. Lynch, Treas., Box 655, Herington, Kas.

DISTRICT No. 12—New York.
New York Central System. Lodges represented: 5, 7, 10, 64, 67, 85, 150, 157, 169, 175, 197, 218, 228, 229, 321, 413, 492.

A. M. Anderson, Pres., 2208 Francis St., Jackson, Mich.

G. H. Gates, Vice-Pres., 148 N. Orchard St., Watertown, N. Y.

J. J. Leamy, Sec.-Treas., 68 Livingston Ave., Albany, N. Y.

Trustees—Wm. Weber, E. J. McNamara and Thomas Ranger.

DISTRICT No. 13—Birmingham, Ala.
Southern R. R. System. Organized Feb. 23, 1904. Lodges represented: 2, 4, 12, 14, 40, 50, 28, 105, 143, 170, 226, 235, 312, 320, 334, 344, 369, 419, 511, 524; H. D., 27, 111, 176, 240.

Thos. J. Garvey, Pres., 414 E. Byrd St., Richmond, Va.

A. E. Barksdale, V.-P., 543 E. Lafayette St., Jackson, Tenn.

P. E. Berney, Sec.-Treas., R. F. D. 12, Knoxville, Tenn.

DISTRICT No. 15—Chicago, Ill.
C. & N. W. R. R. Lodges represented: 38, 60, 129, 145, 161, 201, 227, 311, 395, 440, 485, 496, 539, 597.

W. F. Scholes, Pres., 1929 Ave. B., Council Bluffs, Ia.

J. W. Francis, V.-P., 534 Springfield Ave., Chicago, Ill.

T. E. Burdette, Sec.-Treas., 428 North Chesnut Ave., Green Bay, Wis.

DISTRICT No. 19—Roanoke, Va.
Norfolk & Western Virginia. Lodges represented: 28, 402, 30, 405, 557. Meets Union Labor Hall.

C. D. Craft, Pres., 1402 Center St., Portsmouth, O.

M. F. Glenn, V.-P., 1414 McConnell Ave., Portsmouth, Ohio.

J. B. O'Brien, Treas., Roanoke, Va.

E. J. Horgan, C. & F. S., 404 7th Ave., S. E., Roanoke, Va.

DISTRICT No. 20—Ill. Cent. R.
R. Headquarters, Chicago, Ill. Lodges represented: 56, 88, 133, 137, 40, 224, 428, 180, 220, 34, 300, 315, 363, 398, 95; H. D., 97, 106, 116, 102, 230, 174, 232, 223.

K. H. Ecker, Pres., 315 Dane St., Waterloo, Ia.

W. T. McCoid, V. P., 412 Madison St., Clinton, Ill.

E. G. Pullen, C. S. & Treas., 303 Columbia St., Waterloo, Ia.

DISTRICT No. 22—D. R. G. System.
Colorado and Utah. Meeting place, Denver, Colorado; Date meeting, 2d Monday in July, 1915; Lodges represented: 44, 103, 179, 335, 427, 446, 478.

Geo. S. Warden, Pres., B. A. 1507 E. 7th St., Pueblo, Colo.

H. F. Jones, Vice-Pres., 13 Sackett Ave., Salida, Colo.

A. A. Duncan, Sec.-Treas., Box 611, Alamosa, Colo.

DISTRICT No. 23—Meets at St. Louis, Mo., 2d Monday in October, 1914.
Lodges represented: 4, 22, 27, 70, 95, 96, 180, 286, 418, 449, 458, 530, 531, 543, 546, 585, 575.

A. F. Bingham, Pres. and B. A., 701 Lombard St., Springfield, Mo.

L. W. Lawson, V.-P., 821 N. Maxey St., Sherman, Texas.

J. W. Reddick, Financial and Recording Secretary, 817 Lincoln St., Springfield, Mo.

A. A. Denton, Cor. Sec. and Treas., 1044 W. Mt. Vernon St., Springfield, Mo.

DISTRICT No. 24—Springfield, Ill.
Advisory Board Wabash System. Lodges represented: 54, 81, 267, 384, 447, 581.

E. R. Lee, Pres., 324 Taylor St., Moberly, Mo.

James Gray, V.-P., L. No. 447.

Gus L. Kloes, Sec., Box 213, Montpelier, Ohio.

DISTRICT No. 25—Livingston, Mont.
Northern Pac. R. R. St. J. G. Brown, Pres., 610 N. 9th St., Brainerd, Minn.

Frank Depender, V.-P., 735 E. Nora Ave., Spokane, Wash.

Theo. W. Everett, Sec.-Treas., P. O. Box 554, Livingston, Mont.

Trustees—A. H. Shanks, 221 N. 2nd St., Missoula, Mont.; Hugh Roberts, Gen. Del., Glendive, Mont.; G. M. Owens, 312 So. E. St., Livingston, Mont.

DISTRICT No. 26—Aberden, S. D.
C. M. & St. P. and Puget Sound R. Rs. Lodges represented: 11, 15, 32, 33, 41, 104, 244, 302, 455, 520, 523, 563, 583, 595, 603, 606.
G. H. Hawksworth, Pres., Box 817, Deer Lodge, Mont.

F. J. O'Brien, Vice-Pres., Avery, Idaho.

Ed. McSperritt, Secy., Gen. Del., Miles City, Mont.

P. W. Gunn, Treas., 3316-30 Ave., South, Minneapolis, Minn.

J. L. Callahan, B. A., 3606 Clifton St., Milwaukee, Wis.

DISTRICT No. 27—Int. G. N. R.
R. W. O. Faulk, Pres., Palestine, Tex.

W. K. Saddler, Vice-Pres., Mart, Texas.

E. H. Frick, Sec.-Treas., San Antonio, Tex.

W. B. Graham, B. A., Palestine, Tex.

DISTRICT No. 29—Cincinnati, O.
C. H. & D. R. R.

W. J. Redmond, Pres., 204 N. Wash. St., Indianapolis, Ind.

A. R. Griesheimer, Vice-Pres., 329 N. Elizabeth, Lima, O.

Wm. J. McGee, Jr., Sec.-Treas., 1255 Richmond St., Cincinnati, O.

DISTRICT No. 30—Canadian Pacific. District Headquarters, Winnipeg, Man. Lodges in affiliation: 126, 134, 194, 379, 392, 451, 466, 478, 505, 529, 543, 417.

Geo. F. Chadburn, Pres. and Act. ing Sec.-Treas., 1585 Alexander St., Winnipeg, Man.

J. E. Smith, V.-P., 162 Annette St., Toronto, Ont.

R. Carswell, V.-P., 684 Home St., Winnipeg, Man.

DISTRICT No. 31—Cincinnati, O.
B. & O. System. Lodges represented: 5, 10, 79, 99, 105, 135, 241, 259, 318, 326, 332, 444, 493, 498, 514, 579, 578.

J. C. Smith, Pres., Box 292, Garrett, Ind.

J. R. Cline, Vice-Pres., Cleveland, O.

M. W. Luke, Sec.-Treas., 1007 W. Main., Washington, Ind.

DISTRICT No. 33—Grand Rapids, Mich. Pere Marquette System. Lodges represented: 24, 124, 413.

DISTRICT No. 34—Boston, Mass.
Boston & Maine System. Lodges represented: 245, 371, 383, 431, 515, 517. Meets at Boston, Mass., 1st Monday in August and 2d Monday in February.

W. H. Wells, Pres., 108 Westford St., Lowell, Mass.

P. J. Kelley, Vice-Pres., 3 Devon St., Greenfield, Mass.

T. J. Donahue, Sec.-Treas., 5 Fernald St., Lowell, Mass.

DISTRICT No. 35—Parsons, Kas.
M. K. & T. R. R. System. Lodges represented: 292, 209, 501, 576 and 265.

Fred Aisdorf, Pres. & B. A., 515 W. Owings St., Denison, Tex.

C. Dudding, V.-Pres., 2229 Crawford St., Parsons, Kas.

Robt. Rosbottom, Sec.-Treas., 600 W. Texas St., Denison, Tex.

C. A. Denton, Rec. Sec., Parsons, Kas.

Wm. Dickerson, Chairman Trustees, 810 Cleveland St., Waco, Tex.

DISTRICT No. 37—Texarkana, Tex. Cotton Belt R. R. System. Meets 3d Saturdays in January and July.

R. M. Cummins, Pres. & B. A., 303 E. Valentine St., Tyler, Tex.

John A. Smith, V.-P., 1908 E. 8th St., Pine Bluff, Ark.

B. E. Shields, Sec.-Treas., 1503 E. 7th Ave., Pine Bluff, Ark.

DISTRICT No. 38—Atlantic Coast Line. Lodges represented: '20, 26, 239, 422, 425, 448, 570.

A. J. Dixon, Pres., Rocky Mount, N. C.

W. A. Cahill, Vice-Pres., Montgomery, Ala.

E. S. Ryan, Sec.-Treas., 508 Lackawana Ave., Jacksonville, Fla.

DISTRICT No. 39—Central of Georgia System. Meets 1st Friday after Thanksgiving each year at Columbus, Ga. Lodges represented: 4, 12, 26, 436, 510.

R. J. Black, Pres., 913 2nd St., Macon, Ga.

J. J. Dean, Vice-Pres., 226 Taylor St., Savannah, Ga.

Chas. A. Buchheit, Sec.-Treas., 103 Gordon W., Savannah, Ga.

E. M. Kendrick, Rec. Sec., Route 5, Cedartown, Ga.

R. S. Barry, Cor. and Fin. Sec., 1109 5th Ave., Columbus, Ga.

DISTRICT No. 40—Hamlet, N. C. Seaboard Airline and leased lines. Lodges represented: 2, 20, 26, 298.

B. M. Jewell, Pres., 421½ Forest St., Jacksonville, Fla.

E. C. Howle, Sec.-Treas., 1119 E. 32d St., Savannah, Ga.

DISTRICT No. 41—Hinton, W. Va. Chesapeake & Ohio System. Lodges represented: 170, 233, 249, 364, 384, 525.

David W. Morris, Pres., Forest Park, W. Va.

R. L. King, V.-Pres., 807 N. 24th St., Richmond, Va.

C. L. Barnett, Sec.-Treas., 207 2d Ave., Hinton, W. Va.

Trustees—M. L. Steinbuck, Box 336, Clifton Forge, Va. D. C. Dowdy, 2048 7th Ave., Huntington, W. Va. John J. Fielding, 1389 Scott St., Covington, Ky.

DISTRICT No. 42—Danville, Ill. Chicago & Eastern Illinois R. R. Meets 1st Tues. in Feb., 1916. Lodges represented: 22, 95, 575.

G. D. Davis, Pres. and B. A., 18 N. Hazel St., Danville, Ill.

James B. Keenan, V.-P., 1006 E. Madison St., Danville, Ill.

Oliver Henthorn, R. & F. S., 102 Iowa St., Danville, Ill.

A. Welch, Cor. Sec. & Treas., Villa Grove, Ill.

Subordinate Lodges and Officers

1—CHICAGO, ILL. 2d-4th Wed., Bricklayers' Hall, Monroe and Peoria Sts.
James McKiernan, Pres.
John E. Burke, C. & F. S., 3009 Archer Ave.
John Dohney, 8123 So. Peoria.
Frank Condon, B. A., 912 Monroe.

2—ATLANTA, GA. 2d-4th Thurs
A. D. Lundbon, Pres., 224 E. Fair.
John Fitcher, C. S., 406 Pullian.

3—ST. PAUL MINN. 1st-3d Fri., Odd Fellows' Hall, 5th and Wabash Sts.
Geo. Cox, Pres., 1746 Logan.
W. Parranto, C. S., 400 Jenks St.

4—BIRMINGHAM, ALA. 1st-3d Tues., K. of C. Hall.
Fred Baker, Pres., 2021½ 3d Ave.
A. L. Carmack, F. S. & B. A., Office: 335 Hood Bldg.

5—CLEVELAND, OHIO. 1st-3d Thurs., Room 3, Federation Hall, 310 Prospect.
Chas. Tongreen, Pres., Superior.
G. H. Brady, C. S. & B. A., 310 Prospect.

6—COLUMBUS, O. Meets 2d-4th Thurs., F. of L. Hall.
Chas. L. Nicklaus, Pres., 473 Poplar Ave.
Adam Ruckel, C. S., 267 Liebert.

10—INDIANAPOLIS, IND. 2d-4th Thurs., 114 N. Delaware.
E. P. Leopard, Pres., 206 N. Tremont Ave.
Wm. Frohlinger, C. S., 542 East Louisiana St.
L. E. Hinsch, F. S., 851 Ashland Ave.

11—MINNEAPOLIS, MINN. 2d-4th Mon., Richmond Hall, 223 5th St.
H. P. Farly, Pres., 1356 Vine Place.
E. A. Conlin, C. S., 2404 Bloomington Ave.

12—MACON, GA. 2d-4th Friday, Morgan's Hall, cor. Elm and Broadway.
J. T. Fenlon, Pres., 1974 Third St.
R. J. Black, C. & F. S., 913 2d.

14—CHATTANOOGA, TENN. Central Labor Hall, 8th and Cherry Sts., 2d-4th Mon.
Sam Hartman, Pres., North Chattanooga, Tenn.
J. F. Anderson, Secy-Treas., 505 Read Ave.

15—DUBUQUE, IOWA. 1st-3d Tues., Union Hall, 19th and White Sts.
E. Keck, Pres., 1272 Lincoln Ave.
R. Ruof, C. & F. S., 975 Clay St.

16—JERSEY CITY, N. J. 1st-3d Mon., Fischer's Hall, Newark Ave., cor. Erie St.
Patrick J. Kennally, Pres., 209 Magnolia Ave.
Hugh Fitzpatrick, C. S., 244 York.
Ed. McCarthy, B. A.

19—PHILADELPHIA, PA. 2d-4th Fridays, Bricklayers' Hall, Broad and Fairmount Ave.
Frank Goodfellow, Pres., 159 W. Palmer St.
R. S. Hoppins, C. S., 2426 S. Clarion.

20—JACKSONVILLE, FLA. Meets every Monday, Central Labor Hall, 46½ W. Bay.
C. A. Clarke, Pres.
E. S. Ryan, C. & F. S., 508 Lackawana Ave.

21—NEW YORK, N. Y. 2d-4th Tuesdays.
John H. Sullivan, Pres., 607 W. 46th St.
James McGeney, C. S., 352 Schermerhorn St., Brooklyn, N. Y.
Thomas Broadley, F. S., 519 W. 42d St.

22—DANVILLE, ILL. 1st-3d Mon., Trades and Labor Hall.
Ray Schenk, Pres., California St.
Wm. J. Irwin, C. S., 7 Illinois.
Frank Jergens, F. S., 413 N. Bowman Ave.
G. D. Davis, B. A., 18 N. Hazel.

25—SAN FRANCISCO, CALIF. Roesch Hall, 15th and Mission Sts., 2d-4th Thurs.
John Kane, Pres., 41 Collingwood.
Thos. J. Sheridan, C. S. & Treas., 2312 24th St.
Wm. P. Bowser, B. A., 314 14th.

26—SAVANNAH, GA. 2d-4th Tues., Board of Trade Bldg.
J. P. Masey, Pres.
C. A. Buchheit, C. S., 103 Garden.

27—ST. LOUIS, MO. 2d-4th Thurs., 10th and Carr.
Larry Kickham, Pres. & B. A., 5322 Vernon Ave.
James Callahan, C. S., 3408 Laclede Ave.
Henry Selkman, F. S., 1942 Benton.

- 20—**ROANOKE, VA.** 2d-4th Wed., Labor Home Hall, Commerce and Salem Ave.
G. J. Lucas, Pres., 1121 2d Ave. N. W.
J. F. Murray, C. S., 1023 3d Ave. N. W.
- 30—**ROANOKE, VA.** 2d-4th Mon., Labor Hall, cor. Commerce St. and Salem Ave.
C. E. Hades, Pres., 318 7th Ave. N. E.
B. L. Wade, C. S., 811 Jamison Ave.
- 31—**ST. JOSEPH, MO.** 2d-4th Mon., Joucker Hall.
E. E. Stitz, Pres., 2228 So. 6th.
Edward Knight, C. S., 2119 So. 9th St.
- 32—**KANSAS CITY, MO.** 2d-4th Fri., Labor Temple, 14th and Woodland
Thomas Mulvihill, Pres., 3715 Springfield St., Rosedale, Kas.
W. E. Dwyer, C. & F. S., 4402 Windsor.
Chas. McDonald, B. A., 4416 Norledge, Kansas City, Mo.
- 37—**NEW ORLEANS LA.** 2d-4th Wed., Martin's Hall, Iberville and Exchange Place.
Wm. J. Smith, Pres., 228 Morgan St., Algiers, La.
Lewis J. Costella, C. S. & B. A., 636 N. Olympia.
Victor Escousse, F. S., 617 Alik St., Algiers, La.
- 38—**OMAHA, NEB.** 1st-3d Wed., Bairright Hall, 19th & Farnum.
M. J. McGovern, Pres., 1617 Burt.
L. G. Rankin, C. S., 2825 Cass.
J. H. Massman, F. C., 1511 Locust.
- 39—**SOUTH CHICAGO, ILL.** 2d-4th Tues., Union Headquarters, 92d St. and Erie Ave., South Chicago.
Frank Bacon, Pres., 10149 Ave. J.
John Cogan, C. S. & B. A., 9944 Ave. H.
Jos. Manners, F. S., 10213 Ave. L.
- 40—**LOUISVILLE, KY.** 2d-4th Wed., in Beck's Union Hall, 1st and Jefferson Sts.
Thomas Mitchell, Pres., 1422A Broadway.
R. Terrell, C. S., 308 N. 19th St.
- 41—**HARLOWTON, MONT.** 2d-4th Thurs., Winer Hall.
John Dennis, Pres.
Harry Schultz, C. & F. S.
- 42—**NASHVILLE, TENN.** 2d-4th Thurs., Carpenters' Hall, 343½ 4th Ave. N.
James B. Keenan, 1006 E. Madison St., Danville, Ill.
H. R. Brown, Pres., 611½ Church.
W. T. Pentecost, C. S., 2143 Oakland Ave.
- 44—**PUEBLO, COL.** Every Thurs., Carpenters' Hall, 117½ S. Union Ave.
Walter M. Pitts, Pres., 653 E. 5th St.
Geo. S. Warden, C. & F. S., 1507 E. 7th St.
- 45—**BROOKLYN, N. Y.** Greenpoint and Manhattan Aves., 2d-4th Thurs., Pres.
Gerald A. Daly, Pres. & C. S., 676 60th St.
M. J. Callahan, F. S., 204 Nassau Ave.
- 46—**CHEYENNE, WYO.** Union Hall, 2d-4th Wed.
Geo. R. Wallace, Pres., P. O. Box 151.
E. Cole, C. S., 215 E. 9th St.
- 47—**DES MOINES, IA.** 1st-3d Thurs., Trades Assembly Hall.
James Gillespie, Pres., 1113 Columbus Ave.
Fritz Johnson, C. & F. S., 922 W. 1st St.
- 48—**LARAMIE, WYO.** 1st-3d Tues., Moosa Hall.
Jacob Claus, Pres., 114 Cedar St.
Frank M. Lepper, C. S., 380 N. 3d St.
- 50—**CHARLESTON, S. C.** 1st-3d Tues., Y. M. C. A. Hall, George St.
H. J. Hartnett, Pres., 18 Anson St.
John J. Clair, C. & F. S., 186A Spring St.
- 51—**ST. LOUIS, MO.** 2d-4th Wed., Lafayette Hall, 17th and Cass Ave.
Frank H. Johannsmire, Pres., 1223 Sullivan Ave.
Mike Whalen, C. S., 1715 N. 11th St.
Geo. Wheaton, F. S., 4159 Lee Ave.
- 54—**FORT WAYNE, IND.** Last Wed., West Berry St.
Edward F. Siebold, Pres. & C. S., 1130 St. Mary's Ave.
O. P. Ewald, F. S., 1419 S. Calhoun.
- 55—**NEWPORT NEWS, VA.** Every Wed., 8 p. m., C. L. U. Hall, 32d and Wash. Ave.
Wm. H. Healy, Pres., 3711 Huntington Ave.
D. McArthur, C. S., 211 27th.
W. Hannah, F. S., P. O. Box 430.
- 56—**VICKSBURG, MISS.** 1st-3d Tues., K. of P. Hall, N. Washington St.
Ed. Snelling, Pres., 8127 Washington St.
W. C. Hughes, C. & F. S., 2312 Mulberry.
- 57—**PORTSMOUTH, VA.** 1st-3d Thurs., C. L. U. Hall.
O. C. Hartung, Pres., 1248 Park O. Ave.
J. H. Parrish, F. S., 622 Clifford.
Geo. Thomas, C. S., 204 Lincoln.
- 60—**PEORIA, ILL.** 1st-3d Mon., 411 Cedar St.
Andy Yates, Pres., 1709 S. Adams.
F. Hierspiel, C. S., 410 Warner Ave.
- 61—**NEW HAVEN, CONN.** 1st-3d Thurs., Boardman Bldg., cor. State and Chapel Sts.
Wm. Hefferman, Pres., 95 Carlyle.
M. J. Whalen, C. & F. S., 138 Carlyle.
- 64—**JACKSON, MICH.** Every Tues., Labor Hall, Main and Jackson Sts.
Geo. Bonas, Pres., 140 Bates.
Ed. McNamara, C. S., 619 South Pleasant St.
- 65—**VICTORIA, VA.** 2d-4th Sundays, Lunenburg Hall.
J. H. Jones, Pres., Gen. Del.
W. H. Slayton, C. S., Gen. Del.
- 66—**LITTLE ROCK, ARK.** 1st-3d Thurs., Brannon Hall., Markham and Cross Sts.
W. J. Flynn, Pres., 908 Denison.
E. Wortsmith, C. & F. S., 300 W. 11th St., Argenta, Ark.
C. A. McDonald, B. A., 4416 Norledge, Kansas City, Mo.
- 67—**BAY CITY, MICH.** 1st-3d Thurs., Central Trades Council Hall.
Wm. H. Benedict, Pres., 703 E. Winona Ave., W. S.
Joe Malton, V.-P., 317 S. Jackson.
Nelson Heglung, C. & F. S., 814 Adams St.
- 68—**PINE BLUFF, ARK.**—2d-4th Wed., Labor Temple.
A. J. Barton, Pres., 1701 W. 6th.
B. E. Shields, F. S., 1503 E. 7th.
J. A. Smith, C. S., 1908 E. 8th.
- 70—**SPRINGFIELD, MO.** 2d-4th Wed., Eagles' Hall, E. Commercial St.
R. A. Lines, Pres., 816 W. Atlantic St.
Scott Daffer, C. & F. S., 987 Broad St.
A. F. Bingham, B. A., 701 Lombard St.
- 72—**PORTLAND, ORE.** 2d-4th Thurs., 230½ Yamhill St.
Arthur Gallon, Pres., 649 Milwaukee.
F. E. Disbrow, C. & F. S., 810 E. 11th St.
Joe Reed, B. A., 507 Bismark.
- 73—**TROY, N. Y.** 2d-4th Mon., Swan and Georgia Sts., Mechanics' Hall.
Huntington Ave.
James Keating, Pres.
David Boyd, C. & F. S., 319 9th St., Waterlot, N. Y.
- 74—**HOUSTON, TEXAS.** 1st-3d Wed., Woodman Hall, 1823 Washington St.
D. C. Bryan, Pres., 4607 Washington.
F. C. Jackson, C. & F. S., 2118 Lubbock St.
- 79—**GARETT, IND.** 1st-3d Tues., K. of P. Hall, Randolph.
Geo. Richmond, Pres., 214 E. Keyser.
J. C. Smith, C. & F. S., Box 282.
- 80—**ANACONDA, MONT.** 2d-4th Wed., M. & M. Hall, Lodge Box 372.
J. C. Smith, Pres., 510 Cherry St.
James W. Hogan, C. S., 800 Birch.
- 81—**SPRINGFIELD, ILL.** 2d-4th Tues., Fortunes Hall.
Ed Sellers, Pres., 130 E. Edwards.
Louis L. Mutter, C. & F. S., 1621 S. 8th.
- 82—**OSAWATOMIE, KAS.** 1st-3d Mon., K. & L. Sec. Hall.
Hurb Fader, Pres.
C. A. McDonald, B. A., 4416 Norledge, Kansas City, Mo.
J. E. Sturgess, C. & F. S., Box 64.
- 83—**KANSAS CITY, KAS.** 2d-4th Tues., K. P. Hall, 624 Minn. Av.
Thomas Knowles, Pres., 760 Shawnee.
Frank Stover, C. & F. S., 322 Nebraska Ave.
- 84—**GRAND RAPIDS, MICH.** 1st-3d Mon., Trade & Labor Hall, 67 Monroe Ave.
Frank C. Lemke, Pres., 551 Shamrock St.
Nelson M. Warren, C. S., 127 E. Delaware St.
- 85—**TOLEDO, OHIO.** 2d-4th Tues., Mitchell's Hall, cor. Walnut and Summit Sts.
J. S. Durst, Pres., 153 Gibbons St.
Ellsworth Richardson, C. S., 137 Western St.
- 86—**DALLAS, TEX.** 1st-3d Mon., Broadnax Hall.
W. H. Riley, Pres., 1408 Corinth.
C. B. Stout, C. S., R. R. 10, Box 64.
- 88—**JACKSON TENN.** 2d-4th Fri., Labor Hall.
B. E. Seward, Pres.
A. E. Barkdale, C. S., 119 E. Orleans St.
- 90—**SUGAR CREEK, MO.** 2d-4th Thurs., Woodman's Hall.
L. Novak, Pres.
C. R. Snider, C. & F. S., 1223 W. Electric St., Independence, Mo.
- 91—**ELMWOOD PLACE O.** 1st-3d Mon., Kellers Hall.
Geo. Urban, Pres., St. Bernard, O.
John Cullen, C. S., 39 Prosser Ave.
- 92—**LOS ANGELES, CAL.** 2d-4th Wed., Union Labor Temple, 540 Maple Ave.
Charles Clarke, Pres., 206 S. Workman St.
H. E. Herman, C. & F. S., 520 S. Griffin Ave.
- 93—**JOLIET, ILL.** 2d-4th Tues., Conner's Hall.
John Buckley, Pres., 111 Willard Ave.
Richard Farrell, F. S., 503 London Ave.
Charles Mork, C. S., 424 Landon Ave.
- 94—**SACRAMENTO, CAL.** 1st-3d Thurs., Labor Temple.
J. Grabfelder, Pres., 3001 G St.
J. S. Heller, Acting C. S., 1317 19th St.
- 96—**EVANSVILLE, IND.** 2d-4th Mon., Ruhf's Hall.
Chas. T. Mooney, Pres., 1802 Michigan.
Herman H. Grundman, C. & F. S., 307 Mary St.

- 94—**FORT WORTH, TEX.** B. of L. F. & E. Hall, 1st-3d Thurs. J. J. Dempsey, Pres., 504 Calhoun. L. A. Freeman, C. & F. S., 2250 Jennings St.
- 95—**NEWARK, OHIO.** Druid's Hall, S. 3d St., 1st-3d Sun. Emil Indekofer, Pres., 68 Curtis Ave. Cecil Roberts, C. & F. S., 45½ S. Third St.
- 100—**MARSHALL, TEX.** 1st-3d Tues., I. O. O. F. Hall. Smith Hayden, Pres., 514 Greenwood Ave. J. P. O'Neill, C. & F. S., 703 E. Rusk.
- 103—**SALT LAKE CITY, UTAH.** Labor Temple, 3d East, bet. 1st and 2d S. St., 1st-3d Wed. Wm. H. Garrick, Pres., 446 Edith Ave. B. S. R. Harrison, C. & F. S., 862 Ouray Ave.
- 104—**SEATTLE, WASH.** 1st-3d Thurs., Labor Temple, 6th and University St. Fred Counter, Pres., 2360 15th Ave., So. Bud Nash, C. & F. S., 3438 16th Ave., W.
- 105—**CINCINNATI, OHIO.** 2d-4th Tues., Workman's Hall, Mercer and Walnut Sts. Chas. Granger, Pres., 329 Union St., Bellevue, Ky. D. L. O'Brien, C. S. & B. A., 23 Forest Ave., Ludlow, Ky. Frank Bareswilt, F. S., 1028 5th Ave., Dayton, Ky.
- 106—**McGHEE, ARK.** 3d-4th Wed., K. of P. Hall. Wm. E. Crupper, Pres., Box 215. Chas. A. Stewart, C. & F. S., Box 432.
- 107—**MILWAUKEE, WIS.** 1st-3d Tues., Speers Hall, Cor. National & 3d Ave. J. Hoppens, Pres., 1302 Fraternity. R. Dale, Fin. Sec., 319 4th Ave. P. Sonnenberg, C. S. & B. A., 622 Greenbush.
- 108—**AUGUSTA, GA.** 2d-4th Tues., Machinists' Hall, Broad. Patrick Rice, Pres., 1342 Walton Way. E. E. Bennett, C. S., 310 9th St.
- 109—**CHADRON, NEB.** J. W. Boyd, Pres. John Paulson, C. & F. S.
- 111—**MISSOULA, MONT.** 2d-4th Tues., Eagles' Hall. H. A. Chase, Pres., Box 1304. E. H. Shanks, C. & F. S., 221 N. 2nd.
- 112—**SEDALIA, MO.** 1st-3d Tues., Labor Temple. Chas. Hall, Pres., Gen. Del. C. A. McDonald, B. A., 4416 Norledge, Kansas City, Mo. W. H. Sims, C. S., 1306 E. 7th St.
- 116—**BRAINERD, MINN.** 2d-4th Fri., Trades and Labor Hall. Henry Voight, Pres., E. Oak. Wm. B. Good, C. S., Imperial Block.
- 117—**DE SOTO, MO.** 1st-3d Mon., Federation Hall. R. B. Parks, Pres. S. L. Johnson, C. & F. S., Box 248.
- 118—**NORTH PLATTE, NEB.** 4th Sat., K. of P. Hall. John Beth, Pres. Peter McGovern, C. S., 511 Locust.
- 122—**LIVINGSTON, MONT.** 1st-3d Thurs., Trades and Labor Hall. C. D. Cain, Pres., 304 S. K St. Theo. W. Evert, C. & F. S., P. O. Box 554.
- 124—**SAGINAW, MICH.** 1st-3d Fri., Petre & Meek's Hall, Genesee Ave. John Doyle, C. & F. S., R. F. D. No. 1.
- 128—**WINNIPEG, MAN.** 1st Wed. and 2d Sun., 2:30 o'clock, Labor Temple. Charles Davies, Pres., 514 Atlantic Ave.
- A. B. Page, C. & F. S., 1380 Elgin Ave.
- 129—**OLINTON, IOWA.** H. Quailman, C. S., 281 14th Ave.
- 130—**BUTTE, MONT.** 1st-3d Tues., Carpenters' Hall, cor. Granite and Montana Sts. T. F. Shulta, Pres. Harry Goodland, C. & F. S., 177 E. Center.
- 132—**GALVESTON, TEX.** 2d Mon., Cooks and Waiters' Hall, 23d St. S. Nawdascher, Pres., 8328 Ave. H. E. T. Chester, C. & F. S., 3209 Ave. I.
- 133—**WATERLOO, IOWA.** Central Labor Hall, 2d-4th Wed. E. G. Pullen, Pres., 502 Columbia St. Geo. A. McMillan, C. S., 702 Barclay St.
- 134—**MONTREAL, QUE., CAN.** 1st-3d Fri., Monument National, St. Lawrence and Main Sts. Stephen Craig, Pres., 1251 Mossier. R. Chorlton, C. S., 1184 Delormier Ave.
- 135—**CHILLICOTHE, O.** 1st-3d Mon., Flaecker Hall. L. J. Medert, Pres., 518 E. Water St. James Hunsinger, C. & F. S., 390 E. 4th St.
- 136—**COLORADO CITY, COLO.** Red Men's Hall, 1st-3d Fri. H. J. Norton, Pres., care National Hotel. R. D. Wing, C. S., 12 So. 12th, Colorado Springs, Colo. J. H. Cook, F. S., 216 N. 12th.
- 137—**PADUCAH, KY.** 2d-4th Sun., Central Labor Hall, 123½ N. 4th. B. C. Beadles, Pres., 1029 Madison. Wm. Black, C. & F. S., 215 N. 3d St.
- 138—**HARRISON, ARK.** H. C. Heppard, Pres. T. T. Chubb, C. S.
- 140—**PEN ARGYL, PA.** 2d-4th Mon., Steinmilt's Hall, Bangor, Pa. Joseph Wenninger, Pres. & C. S., care Realty. J. A. Morgan, Fin. Sec., care Albion House.
- 143—**KNOXVILLE, TENN.** 319 N. Gay St., 1st-3d Tues. J. D. Krause, Pres., R. F. D. No. 1. J. C. Wells, C. S., 508 E. 4th Ave. W. D. Amames, F. S., R. F. D. No. 12, Lincoln Park.
- 144—**CEDAR RAPIDS, IOWA.** 1st-3d Wed., I. O. O. F. Hall, cor. 1st St. and 2nd Ave. W. Chas. T. Bowman, Pres., 816 Ellis Blvd. Frank C. Schwarz, C. & F. S., 830 G Ave., W.
- 145—**MISSOURI VALLEY, IOWA.** 1st-3d Thurs., Walker's Hall. Hans Witt, Pres., Box 181. Harvey Nichols, C. S.
- 148—**VALLEJO, CALIF.** 1st-3d Tues., Vallejo Temple Hall. Wm. Fountain, Pres., 225A Penn. Harry Duthie, C. & F. S., 638 Capitol.
- 149—**MARSHALLTOWN, IOWA.** 1st-3d Tues., Trades and Labor Assembly Hall, Main St. Chas. Vyskocjal, Pres., 9 E. Boone. W. E. Pouley, C. S., 1110 W. Cole.
- 150—**CHAMPAIGN, ILL.** 1st-3d Sun., 2:30 p. m., I. C. System Fed. Hall. Thos. H. Monahan, Pres., 511 W. Washington St. A. E. Strode, C. S., 325 Hickory.
- 153—**GASSAWAY, W. VA.** J. E. Perkins, Pres., Gen. Del. R. Lee Boone, C. & F. S., Gen. Del.
- 154—**PITTSBURGH, PA.** 1st-3d Fri., Labor Temple, cor. Washington and Webster Ave.
- Frank Bann, Pres., 804 South Ave. N. S. Henry J. Thumel, C. & F. S., 1218 Iitin St. N. S. James P. Carr, B. A., Labor Temple, Wash. and Webster Ave.
- 155—**BLOOMINGTON, ILL.** 2-4 Thurs., Machinists' Hall, West Chestnut St. H. F. Lambrecht, Pres., 1004 N. Livingston St. L. J. Metzner, C. & F. S., 1207 N. Mason.
- 157—**SYRACUSE, N. Y.** 1st-3d Wed., Bartenders' Hall, Clinton & W. Genesee St. J. J. Hardeny, Pres., 214 Hartson. Thomas Ranger, C. S., 120 Lydell.
- 161—**BOONE, IOWA.** 1st-3d Mon., at Electrical Workers' Hall. Frank Whitman, Pres., 1603 Benton. H. W. Martens, C. & F. S., 1329 Meridan St.
- 163—**HOBOKEN, N. J.** 2d-4th Fri., 500 Bloomfield St. Edwin L. Norwood, Pres., 923 Garden St. P. L. Growney, C. S., 1019 Willow Ave.
- 165—**DULUTH, MINN.** 2d-4th Sat., Irwin-Sloan Block, 20th Ave. and Superior St. James A. Graham, Pres., 5705 Grand Ave., W. Duluth, Minn. Alfred S. Nelson, C. & F. S., 5705 Grand Ave., W. Duluth, Minn.
- 169—**DETROIT, MICH.** 2d-4th Fri., 235 Gardlot Ave. Charles Komes, Pres., 31 Celaren. Chas. F. Aderholdt, C. & F. S., 9 Swiven St.
- 170—**RICHMOND, VA.** 1st-3d Wed., Labor Temple, 5th and Marshall Sts. R. L. King, Pres., 322 N. 26th St. F. C. Blount, F. S., 1101 N. 23d. E. M. Daywait, C. S., 2203 Venable St.
- 172—**RALEIGH, N. C.** B. F. Long, Pres., 218 N. McDowell. J. P. Taylor, C. & F. S., 615 W. North.
- 175—**OSWEGO, N. Y.** 2d-4th Mon., 8 p. m., Forester Hall, E. Bridge St. Wm. Perau, Pres., 90 Hart St. James Gorman, C. S., 54 Murray.
- 176—**ELIZABETH, N. J.** 2d-4th Wed., Dahmen Hall, 4th and E. Jersey St. John H. Reynolds, Pres., 33 Delaware St. Samuel M. Rankin, Secy., 64 Florida. E. J. McCarthy, B. A., 67 St. Mark's Place, New York City.
- 179—**DENVER, COLO.** 2d-4th Wed., Room 301 McPhee Bldg., 17th and Glenarm. Geo. Gaus, Pres., 3869 Newton. H. Shaffroth, C. & F. S., 3749 Wynkoop St.
- 180—**MEMPHIS, TENN.** Italian Hall, 1st-3d Fri. W. T. Funston, Pres., 889 Webster Ave. C. F. Gillenwater, C. S., 140 W. Iowa Ave.
- 187—**MIAMI, ARIZ.** Every Tues., Miami Hall. J. W. Landers, Pres. Roy Drummond, C. & F. S., Box 1121.
- 191—**VICTORIA, B. C.** 2d-4th Tues., 1424 Government St. A. Clyde, Pres. Sub. P. O. No. 2. A. Stewart, C. S., Box 48, Beaumont, P. O. Esquimalt, B. C.
- 193—**BALTIMORE, MD.** Every Tues., Patterson Bldg., Baltimore and Gay Sts. John Shanley, Pres. James Chaney, F. S., 1419 Patapsica St. Philip Yingling, C. S., 410 N. 27th St.

- 194—VANCOUVER, B. C., CANADA. 1st-3d Mon., at Labor Temple.
F. W. Jureit, Pres., 2140 Bernard St.
A. Fraser, C. S., 1151 Howe St.
- 195—KEWANEE, ILL. 1st-3d Fri., O'Donnell's Hall, 3d St.
M. J. Carney, C. S., 411 N. 1st St.
- 197—ALBANY, N. Y. 31 Green St., 2d-4th Sat.
J. H. Sullivan, Pres. & B. A., 173 2d St.
Jno. J. Leamy, C. S., 68 Livingston Ave.
- 198—OGDEN, UTAH. 2d-3d Tues., Union Labor Hall on 24th St., bet. Washington and Grant.
F. S. Dunn, C. & F. S., 116 33d St.
- 199—HORTON, KAN. 1st-3d Thurs., Carman's Hall.
Barney Drew, Pres.
E. S. McGinnis, C. & F. S., Box 522.
- 200—STATEN ISLAND, N. Y. I. O. G. T. Hall, W. Brighton S. I., N. Y., 1st-3d Mon.
Richard Hough, Pres., 55 Bay Ave., Pt. Richmond, S. I.
Ethan A. Johnson, C. S., 208 Broadway, W. Brighton S. I., N. Y.
E. McCarty, B. A., 67 St. Mark's Place, N. Y. City.
- 201—WINONA, MINN. Labor Temple, 1st-3d Tues.
Frank Rice, Pres., 574 W. 7th St.
W. Kukowski, C. S., 176 Mankato Ave.
J. H. Buchholz, F. S., 251 E. King.
- 204—HONOLULU, H. I. Waverly Hall, 2d-4th Thurs.
Wm. Brown, Pres., Honolulu Iron Works.
Thos. Murrey, C. S., 1541 King.
- 205—SAN FRANCISCO, CALIF. 2d-4th Tues., Rosch Hall, 15th and Mission.
Wm. P. Bowser, Pres., 507 20th.
J. M. Enright, C. S., 1431 Delores.
Walter Anderson, F. S., 607 Anderson.
Wm. P. Bowser, B. A., 314 14th.
- 206—ALGIERS, LA. 2d-4th Fri., Rency Hall.
Jos. Koenig, Pres. & C. S., 825 Elmira Ave.
C. A. Reynolds, F. S., McDonoughville, La.
- 209—DENISON, TEXAS. 2d-4th Mon., over State Nat. Bank.
A. McDowell, Pres., 504 W. Owings St.
S. E. Harris, C. & F. S., 923 W. Morgan St.
- 216—EL PASO, TEXAS. 2d-4th Thurs., Union Labor Hall.
Wm. Beeson, Pres., Gen. Del.
Frank H. Balt, C. S., 114 S. Stanton St.
- 218—SPRINGFIELD, MASS. 2d-4th Wed., Winkler's Hall, Bridges and Water St.
Michael Fitzgerald, Pres. 843 Caren St.
Wm. E. Donovan B. A., 9 Arbor.
Jerb C. Driscoll, C. S., 141 Patton.
- 220—CHICAGO, ILL. 2d-4th Tues., Pusey's Hall, 901 E. 75th.
M. Casey, Pres., 6351 Drexel Ave.
A. G. Smith, C. & F. S., 7036 Harper Ave.
- 221—PITTSBURG, KAN. 1st-3d Tues., Red Men's Hall, W. 3d St.
E. E. Hiett, Pres., 1803 N. Grand Ave.
P. J. Hiett, C. S., 1801 N. Grand.
- 222—MART, TEXAS. W. O. W. Hall.
E. J. Blount, Pres.
G. W. Coates, C. & F. S.
- 223—UTICA, N. Y. Labor Temple, 2d Fri.
Louis Wengert, Pres., 8 Wiley St.
Edward Wengert, C. S., 43 Pass Ave.
- 225—ELMIRA, N. Y. 2d-4th Sun., Trades & Labor Hall, 200 E. Water St.
A. E. Stevenson, Pres., 964 McGeo.
N. P. Durnin, R. & C. S., 519 Penn Ave.
- 226—SALISBURY, N. C. W. O. W. Hall, Innes and Main Sts., 2d-4th Fri.
J. J. Garvey, Pres., E. Spencer, N. C.
P. F. Surratt, C. & F. S., Box 278, Spencer, N. C.
- 227—CHICAGO, ILL. Garfield Park Hall, 4039 W. Madison St. 2d-4th Sat.
John Seidon, Pres., 1107 Keeler Ave.
Thomas Dean, F. & C. S., 2214 W. 13th St.
- 229—ROCHESTER, N. Y. 2d-4th Wed., 14 N. Water St.
W. Weston, Pres., 17 Coffrey Place.
Robt. Little, C. S., 211 Garfield.
- 233—OAKLAND, CAL. 2d-4th Mon., cor. 7th and Peralta Sts.
H. Brown, Pres., 1003 Pine St.
Geo. Young, C. S., 1788 9th St.
- 235—COLUMBIA, S. C. 2d-4th Tues., Plumbers' Hall, 1623 Main St.
E. R. Fenell, Pres., 1712 Blanding.
J. W. Bankhead, C. & F. S., 1705 Thompson Ave.
- 236—MARQUETTE, MICH. 4th Thurs., E. Seigle's Hall.
Albert Bastien, Pres., 347 West Washington.
Arthur Bourgois, C. S., 817 North 3d St.
- 237—HARTFORD, CONN. 2d-4th Wed., at C. L. U. Hall, Central Row.
James Thornton, Pres., 52 Green.
John J. Reilly, C. S., 46 Pilny.
- 238—CLIFTON FORGE, VA. 1st-3d Fri., Junior Hall.
A. J. Hauer, Pres., 24 Alleghany.
M. L. Steinbuck, C. & R. S., Box 386.
D. G. Clark, F. S., 192 Ridgeway.
- 239—ROCKY MOUNT, N. C. 1st-3d Mon., Machinist Hall, cor. Sunset and Main Sts.
A. J. Dixon, Pres., 208 Atlantic Ave.
H. M. Myers, C. S., 313 Madison.
- 241—WASHINGTON, IND. Zinkin's Hall, 3d and Vantrees Sts., 1st-3d Tues.
J. C. Mooney, Pres., East George.
M. W. Luke, C. & F. S., 1097 W. Main.
- 242—SPOKANE, WASH. 2d-4th Wed., Carpenters' Hall, No. 9 Madison St.
Frank Depender, Pres., 611 E. Indiana Ave.
R. L. Mason, C. S., 218 S. Pittsburg St.
- 244—SIOUX CITY, IOWA. Labor Temple, 5th St., near Pierce, 3d Wed.
Jm Ewing, Pres., 103 Alice St.
Robt. O'Hern, C. S., No. 5 14th.
- 245—CONCORD, N. H. 2d-4th Mon., Central Labor Union Hall.
Geo. Tanner, Pres., Hall St.
J. Berryman, C. S., 143 S. Main.
J. R. New, F. S., 120 Broadway.
- 246—TERRE HAUTE, IND. Cor. 8th and Wabash Ave., 1st-3d Tues.
H. M. Showalter, Pres., 1410 S. 17th.
Jesse Dukes, C. S., 1561 S. 18th.
F. Wittke, F. S., 1709 N. 12th.
- 247—TACOMA, WASH. 1st-3d Mon., Odd Fellows' Hall, S. Tacoma.
Andrew Hansen, Pres., 5406 So. Paks St.
Wm. Polzin, C. & F. S., 5814 S. Lawrence St., So. Tacoma, Wash.
- 249—HUNTINGTON, W. VA. Every Wed., Thompson Bldg., cor. 20th St. and 3d Ave.
J. S. Myers, Pres., 2720 Collis Ave.
Eugene Brennan, C. & F. S., 930 20th St.
D. C. Dowdy, B. A., 2043 7th Ave.
- 250—BOSTON, MASS. Hollis Hall, 724 Washington St., 1st-3d Fri.
Joseph F. Gilchrist, Pres., 194 W. Brookline.
Jeremiah Murphy, C. S. & B. A., 107 Union Park St.
- 254—CHICAGO HEIGHTS, ILL. 1st-3d Mon. at Trades & Labor Assembly Hall, West End Ave.
Thomas Hines, Pres., 1656 West End Ave.
Thomas Brooks, C. & F. S., 306 W. 15th Place.
- 256—POTTSVILLE, PA. Wm. Greaff, Pres., 542 E. Market.
W. Smith, C. S., 215 Front, Minersville, Pa.
- 259—LIMA, OHIO. 2d-4th Thurs. 334 No. Main.
A. C. Thompson, Pres., East Finley.
A. K. Griesheimer, C. S., 329 N. Elizabeth.
Harry Gunn, F. S., 723 West Wayne.
- 265—SMITHVILLE, TEXAS. 1st-4th Mon.
E. C. Rovillo, Pres.
G. L. Fayton, C. S., Box 344.
- 267—MOBERLY, MO. 2nd and 4th Thurs., Painters' Hall.
J. J. Cadagin, Pres.
F. R. Lee, C. S., 601 Monroe Ave.
- 276—ST. LOUIS, MO. 2d-4th Fri., N. E. Cor. 11th and Locust.
Herbert Abbey, Pres., 2618 Ann Av.
Henry Waeckerle, C. S., 2919A Miami.
Clyde Stevens, F. S., 1914 N. 21st.
E. St. Louis, Ill.
- 278—ELKINS, W. VA. 2d-4th Thurs., Kendall Hall.
Geo. Cade, Pres., 620 Yokem.
C. H. Godwin, C. & F. S., 312 Center St.
- 279—EDMONTON, ALB. CAN. 1st Mon., Calder, Edmonton.
Wm. J. Fitzmaurice, Pres., Box 2100, of E. D. & B. C. Ry.
James McLean, C. & F. S., 10236 113th St.
- 281—NORWOOD, MASS. 2d-4th Fri., 724 Washington St., Boston.
Amos Bennett, Pres., 135 Appleton St., Boston, Mass.
Robert Henderson, C. S., 274 Metropolitan Ave., Roslindale, Mass.
- 284—FREEPORT, ILL. Every 3d Wed. at Blust Hall.
J. W. Daniels, Pres. and C. S., 27 Shawnee St.
- 286—FORT SCOTT, KAN. 1st-3d Mon., Redmen's Hall, 111 E. Wall St.
J. W. McNowen, Pres., 816 Marion Ave.
J. C. Bonestell, C. S., 739 Croxford.
- 287—KINGSVILLE, TEXAS. W. B. Poor, Pres.
E. C. Martin, C. S., Box 162.
- 290—BREMERTON, WASH. Sam Reardon, Pres.
John Hornby, C. S., Gen. Del.
- 292—PARSONS, KAN. 2d-4th Tues., Moose Hall.
C. Dudding, Pres., 2229 Crawford St.
E. P. Butler, C. S., 1723 Gabriel.
- 293—SHAWNEE, OKLA. 2d-4th Mon., Moose Hall.
Ed. S. Pine, Pres., 711 N. Tucker.
A. D. Ross, C. & F. S., 429 N. Park Ave.
- 298—PORTSMOUTH, VA. C. L. U. Hall, 2d-4th Thur.
M. A. Garris, Pres., 2226 King.
H. W. Jarrett, F. S., 1822 County.
Robt. T. Howe, C. S., 826 4th St.
- 300—WATER VALLEY, MISS. I. O. O. F. Hall, 1st-3d Thur.
C. H. Baker, Pres. and Treas.

301—CANTON, OHIO. 1st-3d Mon., Switzer Hall, Cherry and 8th Sts.
 Joe Petch, Pres., 1119 5th St., N. E.
 E. J. Gussett, C. & F. S., 1202 McKinley Ave., S. W.
302—MILWAUKEE, WIS. 1st-3d Sat., Lipp's Hall, 3d and Prairie.
 Henry J. Murray, Pres., 113 29th St.
 Hugh Fuller, C. S., 500 34th St.
 John DuBrucq, F. S., 217 1/2 4th Ave.
303—PORT ARTHUR, TEXAS. 2d-4th Tues., Labor Hall.
 C. L. Bragg, Pres., Gen. Del.
 T. O. Riley, C. S. & B. A., Box 682.
 James Rose, F. S., Box 8.
309—EVANSTON, WYO. I. O. O. F. Hall, 1st-3d Wed.
 John T. Whittle, Pres., County Road.
 J. H. Willoughby, C. S., Box 419.
311—SOUTH KAUKAUNA, WIS. 2d-4th Mon., Odd Fellows' Hall.
 Louis Crevier, Pres.
 Chas. Robedeau, C. & R. S., P. O. Box 279.
312—SELMA, ALA. 1st-3d Wed., at R. R. Y. M. C. A.
 J. F. Ryals, Pres.
 W. P. Fawcett, C. S., 1509 Selma.
315—McCOMB, MISS. Central Trade and Labor Hall, 1st-3d Wed. at 7:30.
 R. O. Bean, Pres. & C. S., Box 684.
317—RICHMOND, CALIF. 2d-4th Fri., Barnman's Hall, 19th St.
 Frank Mallinson, Pres., care Randall Hotel.
 Wm. Jones, C. & F. S., Box 634.
318—PITTSBURGH, PA. 1st-3d Mon., Haslewood Bank Bldg., cor. 2d and Haslewood.
 W. Mertz, Pres., Path Alley.
 T. A. Hudson, F. S., 210 Johnston Ave.
320—MERIDAN, MISS. B. L. E. Hall, 5th St. and 40th Ave., 1st-3d Thurs.
 J. A. Smitheron, Pres., 511 40th Ave.
 J. E. Alexander, C. & F. S., 2817 7th St.
322—ST. LOUIS, MO. 1st-3d Tues., Reddy Hall, 2100 Chautau.
 John Coats, Pres., 2726 Washington Ave.
 M. Renth, C. S., 4537 Michigan Ave.
323—CHICKASHA, OKLA. 2d-4th Fri., Labor Hall, 4th and Choctaw.
 C. A. Chincholl, Pres., P. O. Box 502.
 W. L. Harkins, C. & F. S., 528 S. 18th.
325—SHEVEPORT, LA. K. of P. Hall, over West End Drug Store, 2d-4th Thurs.
 H. Abbott, Pres., 1542 Luchina Ave.
 H. W. Huff, C. S., 1862 Texas Av.
326—CUMBERLAND, MD. 1st-3d Wed., Chapel Hill House.
 G. H. Little, Pres., 401 1st St.
 C. J. Deal, C. S., 48 Penn Ave.
334—PRINCETON, IND. 2d-4th Tues., Redmen's Hall.
 Joe Myers, Pres., 1101 S. Race.
 J. E. Clark, C. & F. S., 702 S. Prince.
335—GRAND JUNCTION, COLO. 2d-4th Fri., Eagles' Hall.
 G. R. Stoll, Pres., 327 White.
 E. H. Friend, C. & F. S., 308 Pitkin Ave.
339—SPARKS, NEV. 2d-4th Wed., Engineers' Hall.
 Wm. Dassel, Pres., P. O. Box 214.
 C. E. Crouch, C. S., P. O. Box 204.

340—HERINGTON, KAS. 1st-3d Sat., I. O. O. F. Hall.
 John Olson, Pres.
 J. E. Anderson, C. S., 303 N. 8th.
341—PHILADELPHIA, PA. 2d-4th Tues., 8 p. m., Labor Headquarters, 232 N. 9th St.
 Wm. J. Boyle, Pres., 208 N. 58th St.
 Chas. Heberly, C. S., 3084 Aramingo Ave.
344—SHEFFIELD, ALA. 1st-3d Wed. at I. O. O. F. Hall, Montgomery Ave.
 W. H. Wilson, Pres., Tuscumbia, Ala.
 Joseph Meyers, C. S., Tuscumbia, Ala.
345—SAN ANTONIO, TEXAS. Trades Council Hall, 3d Thura.
 F. G. Sunmany, Pres., 221 Josephine.
 E. H. Frick, C. & F. S., 1223 W. Traves Ave.
 Delirympe, E. A., 410 River Ave.
346—TRENTON, MO. 1st-3d Tues., at Cutlip's Hall.
 Walter Mason, Pres., 1726 Lula Ave.
 Geo. W. Singer, C. & F. S., 1801 Maine St.
353—HANNIBAL, MO. Wm. James, Pres., 300 Rock.
 J. J. Sughnee, C. & F. S., 826 Grand Ave.
354—BROOKFIELD, MO. 1st-3d Tues., 212 N. Main St.
 Martin Murphy, Pres., 291 Elm St.
 J. K. Burnham, C. S., 212 W. John St.
355—CONNEAUT, OHIO. 2d-4th Fri., Stationary Eng. Hall, Main St.
 Chas. Ward, Pres., 685 Lakeview Ave.
 E. J. Dickson, F. S., 215 Main.
356—HAMMOND, IND. 3d Wed., Long's Hall, State St.
 Wm. J. Davis, Pres.
 Albert Gragedo, C. S., 647 Calumet Ave.
360—LAFAYETTE, IND. 1st-3d Thurs., Bartenders' Hall, 3d and Ferry Pt.
 Fred R. Amp, Pres., 1601 N. 12th.
 Wm. Peterson, C. S., 426 Tingle Ave.
 James Goldsberry, F. S.
363—EAST ST. LOUIS, ILL. 1st-3d Fri., Barry's Hall, cor. Coll and Ohio.
 John Roach, Pres., 614 Ohio.
 C. Stevens, C. S., 1214 N. 21st.
364—COVINGTON, KY. 1st-3d Mon., Helders' Hall, N. W. cor. 21st and Russell Sts.
 Herman Dedden, Pres., 19th and Euclid Ave.
 R. F. Powers, C. S., 2011 Pearl St.
367—HAVRE, MONT. 3d Sat., Oxford Hall.
 Kyle Cope, Pres., 1428 3rd St.
 Elmer Burns, C. S., 1027 2nd St.
369—ALEXANDRIA, VA. 1st Thur. in month during summer months, 108 N. Patrick St.
 James Moran, Pres., 1219 Duke.
 M. Gemeny, R. & F. S., 1514 King.
371—LOWELL, MASS. 1st-3d Sat.
 James Lanigan, Pres.
 J. J. Cunningham, C. S., 656 Gorham.
377—MOLINE, ILL. 1st-3d Fri., Moline Industrial Home, cor. 14th St. and 5th Ave.
 Carl Robison, Pres., 7th St., Silvis, Ill.
 John Fulton, F. S., 7th St., Silvis, Ill.
 Charles McGowan, B. A., 7th St., Silvis, Ill.
 C. R. Kizer, C. S., Box 581, Silvis, Ill.
 Walter S. Schneider, B. A., 1217 26th St., Rock Island, Ill.

378—MONCTON, N. B., CAN. 2d-4th Fri., Sons of Temperance Hall.
 Alex McDougall, Pres., 143 High St.
 R. D. Donnelly, C. S., 69 Downing St.
379—McADAM JUNCTION, N. B., CAN. 2d-4th Fri., Orange Hall.
 Geo. Guest, Pres.
 A. J. McLaggan, C. S.
381—AMARILLO, TEXAS. 1007 Buchanan.
 M. L. Parker, Pres., Box 407.
 Joe Wilson, C. S., 1007 Buchanan.
382—CHILDRESS, TEXAS. 2d-4th Fri., at 7:30 p. m., in Labor Temple.
 Mack Leopold, Pres., P. O. Box 335.
 J. M. Neal, C. S.
384—PERU, IND. 2d-4th Tues., Labor Trades Hall.
 Floyd W. Seitz, Pres., 164 N. Lafayette.
 W. H. Hawkins, F. & C. S., 404 W. 12th St.
 Frank Sullivan, B. A., 133 W. 3d.
388—MECHANICSVILLE, N. Y. 2d and last Tues., A. O. H. Hall, North Main St.
 James S. Kennedy, Pres., S. Second Ave.
 W. A. Saunders, C. S., Saratoga St.
 Chas. Chapman, F. S., Broadway.
390—TRINIDAD, COLO. 2d-4th Wed., Labor Union Hall, East Main St.
 W. T. Flynn, Pres., Arizona Ave.
 A. A. Loftus, F. & C. S., 107 Goddard St.
391—DAVENPORT, IOWA. 2d-4th Fri., Danish Hall.
 John Schach, Pres., 516 1/2 W. 3d.
 R. F. Stewart, C. S., 618 Tremont Ave.
 W. C. Richards, F. S., 1928 Bridge Ave.
392—CALGARY, ALBERTA, CAN. 3d Sat., 2:30 p. m., Labor Temple.
 J. Chambers, Pres., Ogden, P. O. F. Adams, C. S., Ogden, P. O. Alb.
393—GOODLAND, KAS. 1st-3d Tues., Calvert & Sparks' Law Office.
 John McPeak, Pres.
 John Maher, C. & F. S.
395—NORTH FOND DU LAC, WIS. 1st-3d Fri., Trades and Labor Hall, cor. 3d and Main.
 Elmer Shields, Pres., 109 Wible St.
 Wm. Ford, C. S., 536 Main Ave.
396—NORWICH, N. Y. 4th Wed. in Cook Block.
 James E. Callahan, Pres., 1 Columbia St.
 Julius Schraft, C. & F. S., 13 Davis.
398—RIVIERE DU LOUP, QUEBEC, CANADA. Rioux Hall.
 Pierre Loperriere, Pres., Blais Ville.
 Ludger Oullet, C. & F. S., Blais Ville.
400—MIDDLETON, N. Y. 1st-3d Fri., Odd Fellows' Hall.
 Wm. Springer, Pres., 55 Beattie Ave.
 Wm. E. Appel, F. S., 378 North.
 W. S. Seeley, 7 1/4 Sproat St.
402—PORTSMOUTH, OHIO. 2d-4th Fri., C. L. U. Hall.
 Fred Miller, Pres., cor Robinson and Summit St.
 Edward Snyder, C. S., 2113 17th St.
403—HOISINGTON, KAS. I. O. O. F. Hall, 1st-3d Mon.
 Ray Bowler, Pres., P. O. Box 72.
 C. W. Cramer, C. & F. S., Box 494.
405—BLUEFIELD, W. VA. 1st-3d Fri., Masonic Temple.
 E. K. Collins, Pres., Princeton Ave. E.
 W. F. Dupree, C. & F. S., Gen. Del.

- 400—VAN WERT, OHIO. 3d Thurs. Suite 226 Home Guard Bldg.
E. K. Murlin, Pres., 208 N. Race.
410—SAN FRANCISCO, CAL. 3d-4th Wed., Polita Hall, 3365 16th St.
Ed Hanny, Pres., 2217 Howard.
L. Kevill, C. & F. S., 208 Springdale Ave.
413—ST. THOMAS, ONTARIO, CAN. 2d-4th Tues., Machinists' Hall, Talbot St.
Frederick Brooks, Pres., 5 Maama Frank Roberts, C. S., 61 Wilson
414—ONEONTA, N. Y. 1st Wed. and 3rd Sun., 2:30 p. m., Redmen's Hall.
James Walsh, Pres., 51 Church.
David Lawrie, C. & F. S., 73 W. Broadway.
415—JACKSONVILLE, ILL. F. McKenna, C. S., 475 E. State.
417—NORTH BAY, ONT., CAN. 2d-4th Mon., L. O. L. Hall.
A. E. Lye, Pres., Box 799.
Frank Crotcher, C. S., Box 1773.
418—NEODESHA, KAN. 1st-3d Sat., Baldwin Hall.
Chas. Brown, Pres.
E. P. Reddick, C. S., Box 775.
A. F. Bingham, B. A.
419—SOMERSET, KY. 1st-3d Tues., at Owen's Hall.
Peter Lefter, Pres., Sta. A.
J. A. Schofield, C. & F. S., Sta. A.
421—HAMILTON, ONT. 1st-3d Fri., Labor Hall, John St. So.
L. Lawton, Pres., No. 21 Tuckett.
F. Honison, C. & F. S., 6 Bristol.
422—SANFORD, FLA. 2d-4th Wed., Eagles' Hall.
H. B. Purden, Pres.
J. H. Shuman, C. S., 115 W. 9th.
423—BIG SPRINGS, TEX. 2d-4th Tues., I. O. O. F. Hall.
D. D. Crawford, Pres., cor. Greg and 3d.
W. P. Warrep, C. & F. S., 201 W. 1st.
424—FLORENCE, S. C. 2d Thurs., Y. M. C. A.
L. H. Mims, Pres., 222 Covington St.
A. H. Dickman, C. & F. S., 609 Day St.
425—WAYCROSS, GA. 1st-3d Thurs., Loot Hitch Bldg.
C. M. Schultz, Pres., 27 Stephens Ave.
L. J. Flohr, C. & F. S., Box 236.
427—SALIDA, COLO. 2d-4th Thurs., Adlras Hall.
H. F. Jones, Pres., 135 E. Sacket Ave.
Wm. Dargavel, C. S., 321 E. St.
428—NORFOLK, VA. 2d-4th Wed., Pythian Castle Hall.
W. M. Wood, Pres., 617 Liberty St., Berkeley, Va.
Thos. Callahan, C. & F. S., 116 Middleton St., Berkeley, Va.
430—CAPE GIRARDEAU, MO. 1st-3d Tues., Haas' Hall.
Geo. Stanley, Pres., 223 Frederick St.
Oscar O. Berry, F. S., 415 S. Frederick St.
431—BOSTON, MASS. 2d Thurs., Naomi Hall, 724 Washington.
Thos. R. Keenan, C. S., 80 W. 5th St., So. Boston.
434—CHICAGO, ILL. 2d-4th Wed., Boulevard Hall, 55th and Halstead Sts.
H. Fischer, Pres., 6507 Sangamon.
L. M. Craft, C. S., 715 E. 48th.
435—BRISTOL, TENN. 2d-4th Fri., Sixth and Shelby Sts.
M. C. Cooper, Pres., V. & S. W. Ry. Shop.
J. E. Wood, C. & F. S., 27 Lancaster St., Bristol, Va.
436—COLUMBUS, GA. 1st-3d Fri., Trades and Labor Assembly Hall.
R. S. Barry, Pres., 911 4th Ave.
E. W. McMichael, C. & F. S., 411 10th St.
437—TWO HARBORS, MINN. 3d and last Thurs., Iron Dock Grove Hall.
Christ. Anderson, Pres.
Charles Larson, C. & F. S., Box 298.
438—GALETON, PA. 3d-4th Tues., Eagles' Hall.
Daniel B. Shine, C. S., 20 First St.
439—FAIRBURY, NEB. 4th Wed., K. of L. S. Hall.
B. Z. Milliken, C. & F. S., P. O. Box 167.
Fred Kurst, B. A.
440—BELLE PLAINE, IOWA. 2d-4th Mon., Fireman's Hall.
Charles Corna, Pres., 10th St.
Warren Wheeler, C. S., P. O. Box 606.
443—NEW ORLEANS, LA. 3d Tues., 1112 Drayder St.
James Miller, Pres., 1204 Franklin.
John Mocklin, C. & R. S., 606 S. Telemachus St.
444—CONNELSVILLE, PA. J. W. Elsley, C. S., 517 N. Pgh.
446—ALAMOSA, COLO. 2d-4th Wed., Trades Assembly Hall.
Albert Jacobson, Pres.
Chas. F. Darling, C. S., Box 64.
447—DECATUR, ILL. 1st-3d Tues., Ashley Hall, Mason Templeway.
Jas. Gray, Pres., 817 N. Broadway.
Chas. J. Younger, C. & F. S., 422 E. King St.
448—MONTGOMERY, ALA. 1st-3d Wed., Young's Hall.
J. E. Johnson, Pres., 89 Morgan Ave.
E. J. Ford, C. S., 75 Morgan Ave.
449—SAPULPA, OKLA. 2d-4th Mon., Moose Hall.
M. E. Lange, Pres., 913 E. Hobson.
P. I. Shipman, C. & F. S., Gen. Del.
450—WASHINGTON, D. C. 2d-4th Wed., Weller's Hall, 8th & I. St., S. E.
S. E. Kelchner, Pres., 1020 B. St., S. E.
W. F. Kilroy, C. S., 11 I St., N. E.
451—WINNIPEG, MAN., CAN. 2d-4th Fri., Labor Temple.
D. Nelson, Pres., 222 Morley Ave.
F. Snare, C. & F. S., 263 Bradford St., St. James.
453—COPPERHILL, TENN. 1st-3d Tues., I. O. O. F. Hall.
Chas. Feens, Pres., Box 711.
E. N. Hall, C. S., Box 382.
454—CHICAGO, ILL. 2d-4th Thurs., Persey Hall.
Walter Love, Pres., 762 E. 69th St.
E. R. Dettmer, C. S., 9245 Stoney Island Ave.
455—SHERMAN, TEXAS. 2d-4th Thurs., Fulton Hall.
C. S. Hanshey, Pres., Old Phone 893.
John W. Plexco, C. S., 424 S. Gribble.
463—BALBOA, CANAL ZONE, PANAMA. Empire Lodge Hall, 2d-4th Fri.
Alex McKenzie, Pres.
W. H. Keenan, C. & F. S., Box 26, Culebra, C. Z.
464—PALESTINE, TEXAS. Labor Temple, 2d-4th Wed.
Phil Lyser, Pres., 111 Irwin.
J. D. Mallette, C. & F. S., 502 La.
466—REVELSTOKE, B. C. 3rd Sat., Seikirk Hall.
M. M. Keller, Pres., Box 138.
A. Harris, C. & F. S., Box 138.
467—PORTSMOUTH, N. H. 2d Wed., Eagles' Hall.
John Quinn, Pres., Court St.
Alfred Olson, C. S., Box 27, Kittery, Me.
469—TERRELL, TEXAS. 2d-4th Fri., Trades and Labor Hall, 202 E. Moore Ave.
J. R. Poston, Pres., 608 E. College St.
R. E. O'Reilly, C. S., 906 E. Moore Ave.
471—CRISTOBAL, C. Z. 2d-4th Thurs., New Lodge Hall.
J. Z. Knapp, Pres.
V. Z. McMullen, C. & F. S.
473—HELPER, UTAH. 1st-3d Wed., K. of P. Hall.
Wm. R. Welsh, Pres.
R. W. Smith, C. & F. S., Box 411.
476—GRAND ISLAND, NEB. 1st-3d Mon., City Hall, 2d St.
H. W. Hunt, Pres.
Sherman Aldrich, F. S., 1014 E. 4th St.
478—DALHART, TEXAS. 1st-3d Sat., each month.
A. W. Williams, Pres.
479—MOOSE JAW, SASKATCHEWAN, CANADA. 2d-4th Mon., Trades and Labor Hall, Main St.
Wm. Gillies, Pres., 47 Home, W. Geo. Walters, C. S., 356 Duffield.
479—DEVIL'S LAKE, N. DAK. 1st Fri., Opera House Hall.
J. A. Thompson, Pres., Box 324.
Andrew Rutford, C. & F. S., 714 Flint Ave.
481—LYNDONVILLE, VT. 1st-3d Wed., Eaton's Hall.
E. A. Hinda, Pres.
E. A. Phillips, C. & R. S., Box 121.
Lyndon Center, Vt.
J. M. Bresson, B. A.
483—ALTON, ILL. Schwartzbeck Hall, 3d and Ridge. 1st-3d Tues.
Fred Emmel, Pres., 1410 E. 3rd St.
Robt. Dale, C. S., 3008 Edwards.
485—GREEN BAY, WIS. 1st-3d Thurs.
John Christlanson, Pres., 322 E. Maple Ave.
John Slater, C. & F. S., 425 5th St.
J. L. Callahan, B. A., 2606 Clifton Ave., Milwaukee, Wis.
486—TYLER, TEXAS. 1st-3d Wed., E. C. T. M. Hall.
J. C. Fuller, Pres., 1118 Irvin.
J. M. McCarty, C. & F. S., 321 Center St.
C. R. Welch, B. A., 1428 N. Fannie Ave.
489—SEATTLE, WASH. 3d Wed. J. R. Martin, C. S., The Broadway, Yeslerway.
491—VALLEY JUNCTION, IOWA. 1st-3d Tues., I. O. O. F. Hall.
Frank S. Hoppe, Pres.
J. C. Carroll, C. S., Box 165.
Geo. W. Fring, B. A., Treas.
492—WORCESTER, MASS. 1st-3d Thur., Foresters' Hall.
Patrick I. Curran, Pres., 4 Willson.
John Casey, C. S., 61 E. Central.
493—NEW CASTLE, PA. Jan. 13, 1915, and every other Wed., Trades Assembly Hall.
D. E. Sturdevant, Pres., 516 Waldo.
E. A. Horcher, C. & F. S., 906 E. Washington.
496—HATTIESBURG, MISS. 1st-3d Tues., 500 Boule St.
C. W. LeBianco, Pres., 107 Evans.
A. H. Waddell, C. & F. S., 500 Boule.
496—HURON, SOUTH DAKOTA. 2d Sun. and 4th Fri., Labor Hall.
Peter Paluszak, Pres.
C. Storkson, C. & F. S., 228 Beach St.

- 500 — EVERETT, WASH. 2d-4th Tues., Labor Temple, 3506 Everett Ave.
Wm. Faulke, Pres., 3506½ Everett Ave.
Bert Bloomington, C. S., 3523 Smith Ave.
- 501—WACO, TEXAS. 2d-4th Fri., Labor Hall.
Chas. Bullock, Pres., R. F. D. No. 2.
Wm. Dickerson, C. & F. S., 810 Cleveland St.
- 502—TEAGUE, TEXAS. 1st-3d Mon., Davis Hall.
Thos. McGrath, Pres., Box 244.
A. B. Campbell, C. S.
- 503—FITZGERALD, GA. 1st-3d Wed., I. O. O. F. Hall.
M. J. Mauns, Pres., P. O. Box 436.
A. B. Campbell, C. S.
- 504—MUSKOGEE, OKLA. 1st-3d Wed., Carpenters' Hall.
Thos. Graham, Pres., 233 S. C. Wm. Sohner, C. S., 616 N. F. St.
- 505—FORT WILLIAM, ONTARIO, CAN. 1st-3d Fri., Electricians' Hall, Murphy Block, Simpson Ave.
Isaac Hunter, Pres., 218 Frederica St.
A. Cruickshank, C. S., 1007 Minn. Ave.
- 507—ATCHISON, KAS. 1st-3d Mon., Fireman's Hall, 1521 Main St.
J. F. Coyle, Pres., 1418 Kansas Ave.
John J. Freibott, C. & F. S., 1420 Kansas Ave.
- 509—JACKSON, OHIO. 2d-4th Mon., Hibernian Hall.
O. B. Reynolds, Pres., 77 High St.
Albert Edmonds, C. S., 77 Hunt St.
J. B. Fillinger, B. A. and Journal Cor., 53 Main St.
- 510—CEDARTOWN, GA. E. M. Kendricks, Pres.
I. C. Smith, C. S.
- 511—WHISTLER, ALA. 1st-3d Mon., I. O. O. F. Hall.
J. L. Scholls, Pres.
C. C. Croone, C. S.
- 515—EAST CAMBRIDGE, MASS. Engineers' Hall, 164 Canal St., Boston, Mass., 1st-3d Fri.
Geo. A. Mitchell, Pres., 39 S. Russell St., Boston, Mass.
Joseph Irwin, C. & F. S., 36 Glendale St., Everett, Mass.
- 517—GREENFIELD, MASS. 2d-4th Sat., Forester Hall.
Patrick Kelley, Pres., 3 Devens.
Tim Scannell, C. & F. S., 6 Russell St.
- 518 — WICHITA, KAS. 1st-3d Thurs., 216 N. Main St.
Roy Connors, Pres., 1440 S. Market St.
Oscar Maze, C. S., 1933 W. Lincoln.
- 520—MILES CITY, MONT. 2d-4th Mon., I. O. O. F. Hall.
P. J. Gallagher, Pres., 608 N. Lake St.
Chas. E. Cook, C. & F. S., 725 Phillips St.
- 521—VAN BUREN, ARK. 1st-3d Thurs., W. O. W. Hall.
Charles Patthast, Pres.
C. A. McDonald, B. A., 4416 Norledge, Kansas City, Mo.
Otto Pyles, C. S., Box 343.
- 523—EL BENO, OKLA. 1st-3d Tues., Redmen's Hall.
H. E. Hart, Pres., Box 624.
H. A. Mathews, C. & F. S., Box 12.
- 523—PRATT, KAS. 2d-4th Tues., at S. T. Sample's residence.
Frank Stephens, Pres., 624 N. Nimescale.
Lox Logan, C. S., 607 N. Jackson.
- 524—MURPHYSBORO, ILL. 2d-4th Wed., Machinists' Hall, 107 S. 10th.
A. R. McFarland, Pres., 638 N. 8th.
E. P. Herin, C. & F. S., 2107 Wall.
- 525—HINTON, W. VA. 1st-3d Mon., Big Four Bldg.
W. L. Taylor, Pres., 108 Grace St.
C. L. Barnette, C. & F. S. & B. A., 419 Summer Ave.
- 528—DEER LODGE, MONT. 2d-4th Fri., I. O. O. F. Hall.
T. J. Messing, Pres.
J. H. Thomas, C. & F. S., P. O. Box 377.
- 529—TRANSCONA, MAN., CAN. 1st Sun., Campbell Hall, Transcona, 3rd Sun., Labor Temple, Winnipeg, 3 p. m.
A. Orr, Pres., 3 Gallagher Ave., Brooklands, Man., Can.
Robt. Clark, C. & F. S., Box 282.
- 530—SPRINGFIELD, MO. 3d Mon., Dengeldem's Hall.
J. W. Reddick, Pres., 817 Lincoln.
John Cain, C. & F. S., 507 Fort.
A. F. Bingham, B. A., 701 Lombard St.
- 531—CHAFFEE, MO. 1st-3d Thurs., City Hall.
T. C. Davis, Pres.
C. P. Bourion, C. & F. S., Box 365.
- 537—COVINGTON, KY. 2d-4th Fri., Workman Hall, 123 Pike St.
John J. Fielding, Pres., 1389 Scott St.
J. J. Fielding, B. A., 1389 Scott.
- 541—BEDFORD, IND. 2d-4th Thurs., Labor Union Hall.
Dan J. Kane, Pres., 511 N. I St.
Chas. J. Bordenet, C. S., 628 N. I St.
- 542—COFFEYVILLE, KAS. Labor Temple, 2d-4th Wed.
R. M. Jones, Pres., 807 W. 14th.
J. C. Morrow, C. & F. S., 613 W. 4th St.
- 543—WICHITA, KAS. 216 N. Main St., 2d-4th Mon.
E. C. Hadler, Pres., 358 Lulu Ave.
C. E. Grove, C. & F. S., 701 W. Central.
- 544—MONETT, MO. 1st-3d Tues., K. C. Hall.
David Elder, Pres., 406 9th St.
John Linebarger, C. & F. S., 214 Pearl St.
- 547—CARBONDALE, PA. Pugh-ans Hall, 2d-4th Fri.
E. T. Dickenson, Pres., 142 Wyoming.
James A. Flannery, C. & F. S., Box 185.
Wilkes Barre Representative, T. J. Cavan, 60 Chester St., Wilkes Barre, Pa.
- 548—TORONTO, CAN. 2d-4th Wed., Labor Temple, Church Jas. Dobson, Pres., 280 Perth Ave.
W. H. Watson, C. S., 163 Annette St.
- 549—MIDDLEPORT, O. 1st-3d Tues., Firemen's Hall.
Lester Cunningham, Pres.
Perry Cooper, C. & F. S.
- 551—PRINCETON, W. VA. Castle Hall, 1st-3d Thurs.
J. J. Bower, Pres., 576 Bluefield.
J. H. Blackwell, C. S., Box 312.
- 553—LA GRANGE, ORE. Wm. Andis, Pres., 1506 V Ave.
Jas. H. Gutridge, C. S., Box 197.
- 556—OKLAHOMA CITY, OKLA. C. S. Cochran, Pres., 406 W. Frisco.
E. F. Ryan, C. & F. S., 400 West Frisco.
- 557—WILLIAMSON, W. VA. 2d-3d Tues., 3d Ave.
- Bert Williams, Pres.
H. W. Bias, C. & F. S., 124 Oak.
- 565—FALLS CITY, NEB. 1st-3d Thurs., W. O. W. Hall.
C. W. Jonas, Pres.
E. Woodington, C. & F. S., 710 E. 16th St.
- 567—SAN ANGELO, TEX. 1st-3d Wed., Eagles' Hall.
O. M. Seay, Pres., 821 W. Ave. I.
R. L. Wright, C. S., 27 West Ave. I.
- 568—TACOMA, WASH. Maccabee Hall, 1109½ C St., 2d-4th Thurs.
Chas. Manning, Pres., 5808 S. Lawrence St.
A. W. Rickett, C. & F. S., 920 So. 9th.
- 570—HIGH SPRINGS, FLA. H. A. Smith, Pres., P. O. Box 273.
F. C. Magerstaadt, C. S.
- 571—DE PERE, WIS. De Both Hall, 1st Sun.-3d Wed.
T. J. McDonald, Pres., Lock Box 44, W. De Pere, Wis.
A. B. Steinfeldt, R. S., P. O. Box 207.
- 573—LANSFORD, PA. Wm. J. Williams, C. S., 843 East Ridge St.
- 575—VILLA GROVE, ILL. 1st-3d Fri., Red Men's Hall.
Geo. W. Burnett, Pres.
A. Welch, C. & F. S., Box 152.
H. A. Downes, F. S.
- 576—WICHITA FALLS, TEX. 2d-4th Thurs., Labor Hall.
J. H. Gibson, Pres., 309 Lee St.
C. K. Matthews, C. & F. S., Box 760.
C. H. Shoemaker, B. A., Box 18, Healdton, Okla.
- 577—CUMBERLAND, MD. 1st-3d Thurs., Trades Council Hall.
E. H. Steahley, Pres., 403 Mechanic.
C. E. Dowlan, C. & F. S., 15 Emly.
- 578—HAGERSTOWN, MD. Moose Hall, 2d-4th Thurs.
L. J. Murray, Pres., 25 Vine St.
Fred H. Stouffer, C. S., 817 Summit Ave.
- 579—KEYSER, W. VA. 1st-3d Tues., City Building.
W. H. Wolf, Pres., Gilmore St.
P. R. Dougan, F. S., Gilmore St.
Joseph F. Hines, C. S., Piedmont, W. Va.
- 581—MONTPELLIER, O. 1st-3d Wed., Ry. Trainmen's Hall.
S. Brown, Pres.
J. Birmingham, C. S.
- 583—BATON ROUGE, LA. 2d-4th Thurs., Odd Fellows' Hall, 3d St.
W. P. Kidd, Pres., 302 St. Phillip St.
S. V. Acosta, C. & F. S., 918 St. Ferdinand St.
- 583—NEVADA, MO. Socialist Hall, So. Main St., 1st-3d Thurs.
A. C. LeQuellec, Pres., 520 E. Cherry.
L. E. Whitehead, C. & F. S., R. F. D. No. 1.
C. A. McDonald, B. A., 4416 Norledge, K. C., Mo.
- 584—LUDLOW, KY. 1st-3d Thurs. Morley Hall.
Thos. Jackson, Pres., 17 Pherry.
H. J. Stroer, C. S., 833 Main, Covington, Ky.
- 585—BOSTON, MASS. 1st Thurs., 8 p. m. and 3d Sun., 2:30, Hemstead Hall, 724 Washington St.
Wm. E. McNabb, Pres., 263 Chelsea, E. Boston, Mass.
Daniel E. McInnes, C. S., 288 Marginal Ave., E. Boston, Mass.
Daniel N. Gerson, B. A., 17 Bulard, Dorchester, Mass.
James Vincent, F. S., 615 E. 6th, So. Boston, Mass.

- 586—SLATER, MO. 2d-4th Mon., I. O. O. F. Hall. Chas. Crawford, Pres. Andy Phelps, C. & F. S.
- 587—BEAUMONT, TEX. 2d-4th Thurs., Trades Assembly Hall. O. H. Greer, Pres., Box 149. T. C. Maddy, F. & C. S., 229 Fulton. M. J. Ickles, B. A., 249 College.
- 588—CHICAGO, ILL. 2d-4th Tues., Koop's Hall, California & North Ave. Thomas Godfrey, Pres., 930 E. 44th St. John McNaney, C. & F. S., 2618 Iowa St.
- 589—MILWAUKEE, WIS. 2d-4th Thurs., 923 E. Water St. Frank Thines, Pres., 729 5th. M. J. Gleason, C. & F. S., 202 Michigan St.
- 590—MONROE, LA. 1st Fri., 615 A St. J. W. Grant, Pres., 501 Wood St. J. J. Devereux, C. & F. S., 615 Calypso St.
- 591—GLENDEVE, MONT. 2d-4th Fri., Noderhoff Hall. V. B. O'Connor, Pres. & C. S., 317 Valentine St. J. J. Shinault, F. S., Gen. Del.
- 592—TULSA, OKLA. 2d-4th Sat. 214½ S. Main.
- John Ingram, Pres., Gen. Del., Sand Springs, Okla. Wm. Carey, C. & F. S., Reeder Bldg.
- 594—STANBURY, MO. 2d-4th Tues., E. of F. Hall. John Inman, Pres. E. W. McNew, C. S.
- 595—AVERY, IDAHO. 2d-4th Mon., Godfrey's Home, West Avery. A. Anderson, C. & F. S., Gen. Del.
- 596—CASPER, WYO. 2d-4th Mon. E. F. Holliday, Pres. A. Doornbos, C. & F. S., Box 272.
- 597—ESCANABA, MICH. 1st-3d Thurs., Lemmer Hall, Ludington St. Jos. Vickers, Pres., 506 Wells Ave. Wm. Grosnich, C. & F. S., 714 Wells Ave.
- 598—SALAMANCA, N. Y. 1st-3d Mon., 3 Maple St. A. G. Frey, Pres., 165 E. State St. D. J. Carpenter, C. & F. S., 3 Maple St.
- 599—PARAGOULD, ARK. 1st-3d Thurs., Carpenters' Hall. J. W. Frey, Pres., 321 S. 2d St. P. L. Houston, C. & F. S., 759 N. 2nd. C. A. McDonald, B. A., 4416 Norledge, Kansas City, Mo.
- 600—AKRON, OHIO. Walsh Bldg. Jas. Shaughnessy, Pres., 376 So. Main St. R. C. Price, C. & F. S., 150 Adams St.
- 601—QUEBEC, CAN. J. Thompson, Pres., 130 3d St., Simolon. G. Dery, C. S., 153 4th St., Lismorlow, Can.
- 602—GREAT FALLS, MONT. 1st-3d Tues., Judge Safford's Court Room. Frank Yelocan, Pres., 1500 8th Ave. N. Roy J. Preston, C. & F. S., 706 8th Ave. So.
- 603—OTHELLO, WASH. 1st-3d Mon., I. O. O. F. Hall. O. W. Bohusock, Pres. W. O. Clark, C. S., Box 137.
- 604—JOLIETTE, QUE., CAN. H. Fournier, Pres., Gen. Del. W. C. Williams, C. & F. S., Box 223.
- 605—TOOELE, UTAH. 2d-4th Thurs., Fraternal Hall. D. B. Sullivan, Pres. C. E. Meyers, C. & F. S., P. O. Box 124.
- 606—MORBRIDGE, S. D. 1st-3d Thurs., Moose Hall. J. P. Schmickrath, Pres., Box 721. H. L. Adams, C. & F. S., Box 166.

International Officers of the Ladies' Auxiliary

- MRS. J. W. EDWARDS.....President
1234 S. 9th East St., Salt Lake City, Utah.
- MRS. F. R. REINEMEYER ...1st Vice-President
Tauromee Ave., Kansas City, Kans.
- MRS. MOLLIE GEARY.....2nd Vice-President
6428 S. Albany St., Chicago, Ill.
- MRS. A. F. BINGHAM.....Secretary-Treasurer
701 Lombard St., Springfield, Mo.
- L. A. 5—SALT LAKE CITY, UTAH.**
Mrs. J. W. Edwards, Pres. & C. S., 928 W. 5th Temple St.
Mrs. Lydia Smithen, V.-Pres., 360 West 1 South St.
Mrs. J. C. Walton, F. S.
Mrs. Jane Foreman, Treas.
Mrs. Morton, R. S., 116 Markham.
- L. A. 7—SUNFLOWER, Parsons, Kas.** 2d-4th Tues. aft., Kennedy Hall.
Mrs. Lillian Dudding, Pres., 2229 Crawford Ave.
Mrs. Alice Leach, Vice-Pres.
Mrs. Zita Rever, Treas.
Mrs. Lula VanVleck, C. & R. S., 2701 Clark Ave.
Mrs. Ethel Smith, Fin. Sec., 2227 Wash. Ave.
Mrs. Mary Carver, Chaplain.
Mrs. Marion Butler, Marshall.
Mrs. Ida Cormany, Conductress.
Mrs. Kate McMullen, In. Guard.
Mrs. Emma Pilkington, O. Guard.
- L. A. 8—FRANKLIN, McComb, Miss., Ladies' Aux. Hall, Ave. F. East** McComb, 2d-4th Thurs.
Miss Lulu Hassfield, Pres., R. F. D. No. 1.
Mrs. E. Sullivan, V.-P. & Treas., 725 Ave. F.
Miss Emma Sullivan, C. S., 725 Ave. F.
Miss Lulu Hassfield, R. S.
- L. A. 9—GRAND JUNCTION, COLO.**
Mrs. W. H. Holeman, Past Pres., 914 S. 5th St.
Mrs. F. N. Davies, Pres. & Treas., 538 Ute Ave.
Mrs. J. W. Cox, C. & F. S. & V.-P., 925 S. 5th St.
Mrs. L. A. Turner, R. & S. T.
- L. A. 10—SPRINGFIELD, MO.**
Mrs. A. F. Bingham, Pres., 701 Lombard St.
Mrs. J. Gestring, Vice-Pres.
Mrs. C. S. Gilliland, C. & R. S., 1914 Johnson St.
Mrs. Wm. Specht, F. S. & T., Route 6.
Mrs. Rheaden, Chaplain.
Mrs. J. East, Conductress and Marshall.
Mrs. J. Ritterhouse, Inside Guard.
Mrs. Gestring, Mrs. Gilliland and Mrs. East, Trustees.
- L. A. 11—LONE STAR, Palestine, Texas, Labor Temple, 2d-4th Tues. afternoons.**
Mrs. Frances Brunson, Pres., 15 Cottage Ave.
Mrs. Helen Redus, V.-P., 106 Queen St.
Mrs. Florence Payne, R. S. & Treas., 212 Palmer Ave.
Mrs. Willie Welch, C. & F. S., 541 Green St.
- L. A. 12—GARFIELD PARK, Chicago, Ill., 1st-3d Sat., 8 p. m., Garfield Park Hall, 4039 W. Madison.**
Mrs. Maud Reinemeyer, Past Pres.
Mrs. Mollie Geary, Pres., 6428 S. Albany Ave.
Mrs. E. Farrell, V.-P., 4118 Carroll Ave.
Mrs. Helen Hughes, Cor. & Rec. Sec., 716 N. Avers Ave.
Mrs. Mary Driscoll, Fla., Sec. & Treas., 4135 Carroll Ave.
- L. A. 14—TOLEDO, O.**
Mrs. E. Richardson, Pres.
Mrs. Allen Thomson, V.-Pres.
Mrs. C. F. Haga, R. S.
Mrs. C. J. Sugrue, C. & F. S.
Mrs. Carrie Stephan, Treas.
Mrs. Louise Brown, Conductress.
Mrs. Lena Kern, Inspectress.
- L. A. 15—SAPULPA, OKLA.**
Mrs. Cora Johnson, Pres.
Mrs. Myrtle Clifton, V.-Pres.
Mrs. Addie Allen, R. S.
Mrs. Beattie Lewis, C. S.
Mrs. Hester Chapman, F. S.
Mrs. Ethel Edwards, Treas.
Mrs. Hettie Rondon, Chaplain.
Mrs. Ferrel Wells, Conductress.
Mrs. Emma Davis, Inside Guard.
Mrs. Katie Hoover, Marshall.
Trustees—Laura Cargill, Mrs. Emma Davis, Mrs. Addie Allen.

Boilermakers' Lodges by States.

Alabama. Birmingham . . . 4 Montgomery . . . 443 Selma . . . 312 Sheffield . . . 344 Whistler . . . 511	Idaho. Avery595	Maryland. Cumberland . . . 332 Cumberland . . . 577 Baltimore . . . 193 Hagerstown . . . 578	New Jersey. Elizabeth . . . 176 Hoboken . . . 163 Jersey City . . . 18	Tennessee. Bristol435 Copperhill . . . 453 Jackson88 Knoxville . . . 143 Memphis . . . 189 Nashville . . . 42 Chattanooga . . 14
Arizona. Miami187	Illinois. Alton483 Bloomington . . 155 Chicago1 Chicago39 Chicago220 Chicago227 Chicago454 Chicago434 Chicago Hts. . . 254 Chicago588 Danville22 Decatur447 Freeport284 Joliet93 Kewanee195 Matttoon224 Moline377 Peoria60 Murphysboro . . 524 Springfield . . . 81 E. St. Louis . . . 83 Urbana150 Villa Grove . . . 575	Massachusetts. Boston250 Boston431 Boston585 Cambridge . . . 515 Dorchester . . . 574 Greenfield . . . 517 Lowell371 Norwood281 Springfield . . . 218 Worcester 492	New York. Albany197 Brooklyn 45 Elmira225 Mechanicsville388 Middletown . . . 400 Norwich396 Oneonta414 Oswego175 Rochester 229 Salamanca . . . 598 Staten Island . . 200 Syracuse157 Troy73 Utica223 N. Y. City 31	Texas. Amarillo328 Beaumont 587 Big Spring . . . 423 Childress 382 Dalhart476 Dallas86 Denison209 El Paso216 Ft. Worth 96 Galveston 132 Houston74 Kingsville 287 Marshall100 Mart222 Palestine464 Sherman458 Port Arthur . . . 305 Smithville 245 San Antonio . . . 469 Teague502 Terrell466 Tyler486 Waco501
Arkansas. Harrison138 Little Rock . . . 66 McGhee106 Paragould 599 Fine Bluff 63 Van Buren 521	Indiana. Bedford541 Evansville 95 Ft. Wayne 54 Garrett79 Hammond356 Indianapolis . . . 19 Lafayette360 Peru384 Princeton334 Terre Haute . . . 246 Washington . . . 241 Wabash324	Michigan. Bay City67 Detroit149 Escanaba597 Grand Rapids . . 84 Jackson64 Marquette 236 Saginaw124	North Carolina. Raleigh173 Rocky Mount . . . 289 Salisbury226	Texas. Amarillo328 Beaumont 587 Big Spring . . . 423 Childress 382 Dalhart476 Dallas86 Denison209 El Paso216 Ft. Worth 96 Galveston 132 Houston74 Kingsville 287 Marshall100 Mart222 Palestine464 Sherman458 Port Arthur . . . 305 Smithville 245 San Antonio . . . 469 Teague502 Terrell466 Tyler486 Waco501
Canada. Calgary Alberta392 Ft. William Ont.505 Hamilton Ont.421 Joliette, Que. . . . 604 McAdam Jct. 379 Moncton, N.B. . . . 373 Montreal134 Moose Jaw, Sask. 478 North Bay, Ont. 417 Quebec601 Revelstoke 466 Riviere du Loup, Que. . . 398 St. Thomas, Ont. 413 Toronto, Ont. . . . 548 Transcona, Man. 529 Winnipeg, M. 126 Winnipeg, M. . . . 451	Minnesota. Brainerd116 Duluth165 Minneapolis . . . 11 St. Paul3 Two Harbors . . . 437 Winona201	Mississippi. McComb City . . . 315 Meridan320 Vicksburg56 Water Valley . . . 300	North Dakota. Devils Lake . . . 479	Texas. Amarillo328 Beaumont 587 Big Spring . . . 423 Childress 382 Dalhart476 Dallas86 Denison209 El Paso216 Ft. Worth 96 Galveston 132 Houston74 Kingsville 287 Marshall100 Mart222 Palestine464 Sherman458 Port Arthur . . . 305 Smithville 245 San Antonio . . . 469 Teague502 Terrell466 Tyler486 Waco501
California. Los Angeles 92 Oakland233 Pt. Richmond . . . 317 Sacramento 94 S. Francisco . . . 25 S. Francisco . . . 205 S. Francisco . . . 410 Vallejo148	Iowa. Belle Plaine . . . 440 Boone161 Cedar Rapids . . . 144 Des Moines 47 Dubuque15 Marshalltown . . 149 Mo. Valley 145 Sioux City 244 Valley Jct. 491 Waterloo133	Missouri. Brookfield 354 Cape Girardeau . . . 430 Chaffee531 De Soto117 Hannibal353 Kansas City 32 Moberly267 Monett546 Nevada583 Bedalia113 Springfield 70 Springfield 530 Slaters586 St. Louis27 St. Louis51 St. Louis276 St. Louis322 St. Joseph 31 Stanbury594 Sugar Creek 90 Trenton346	Ohio. Akron600 Canton301 Chillicothe 135 Cincinnati 105 Cleveland5 Columbus8 Conneaut355 Elmwood Place91 Jackson509 Lima259 Middleport 549 Montpelier 581 Newark92 Niles275 Portsmouth 402 Springfield 18 Toledo85 Van Wert409	Oklahoma. Muskogee504 Okla. City 556 Sapulpa449 Shawnee293 Chickasha 323 El Reno522
British Columbia. Vancouver 194 Victoria191	Kansas. Atchison507 Coffeyville 542 Ft. Scott286 Goodland393 Herington340 Holsington 408 Horton199 Kansas City 83 Neodesha418 Osawatimie 82 Parsons292 Pittsburg221 Pratt523 Wichita543 Wichita518	Montana. Anaconda80 Deer Lodge 528 Glendive591 Great Falls 602 Harlowton41 Havre367 Livingston 123 Miles City 520 Missoula111 Butte130	Oregon. La Grand553 Portland72	Washington. Bremmerton . . . 290 Everett500 Othello603 Spokane242 Seattle104 Seattle489 Tacoma247 Tacoma568
Connecticut. Hartford237 New Haven61	Kentucky. Covington537 Covington364 Louisville40 Ludlow584 Paducah137 Somerset419	Nevada. Sparks339	Panama. Empire, C. Z. . . . 463 Cristobal471	Virginia. Alexandria 369 Clifton Forge . . . 238 Newp't News 55 Norfolk426 Portsmouth 298 Portsmouth 57 Richmond170 Roanoke30 Roanoke29 Victoria86
Colorado. Alamosa446 Colorado136 Denver179 Grand Jct.335 Pueblo44 Salida427 Trinidad390	Louisiana. Baton Rouge . . . 532 New Orleans . . . 37 New Orleans . . . 442 Shreveport 328 Algiers206 Monroe590	Nebraska. Chadron109 Fairbury439 Falls City565 Grand Island . . . 475 North Platte . . . 118 Omaha38	Pennsylvania. Carbondale 547 Connellsville . . . 444 Galeton438 Lansford573 New Castle 493 Philadelphia 341 Pen Argy140 Pittsburgh154 Pittsburgh 318 Philadelphia 19 Pottsville256	West Virginia. Bluefield405 Elkins278 Gassaway152 Hinton525 Huntington 249 Keyser579 Princeton551 Williamston 557
Delaware. Dist. of Columbia Washington 450	Florida. High Springs . . . 570 Jacksonville . . . 20 St. Augustine . . . 230 Sansford573 Sanford422	Nebraska. Chadron109 Fairbury439 Falls City565 Grand Island . . . 475 North Platte . . . 118 Omaha38	North Carolina. Raleigh173 Rocky Mount . . . 289 Salisbury226	Wisconsin. Butler589 De Pere571 Green Bay485 Milwaukee 107 Milwaukee 302 N. Fond du Lac395 S. Kaukauna 311
Georgia. Atlanta2 Augusta108 Cedartown510 Columbus428 Fitzgerald503	Georgia. Atlanta2 Augusta108 Cedartown510 Columbus428 Fitzgerald503	New Hampshire. Concord245 Portsmouth 467	North Dakota. Devils Lake . . . 479	Wyoming. Casper596 Cheyenne46 Evanston309 Laramie48

By Insisting Upon Purchasing Union Stamp Shoes



You help better shoemaking conditions.
 You get better shoes for the money.
 You help your own labor position.
 You abolish child labor.

Do not be misled by retailers who say: "This shoe does not bear the union stamp, but is made under union conditions." This is false—no shoe is union made unless it bears the union stamp.

Boot and Shoe Workers' Union

246 SUMMER STREET, BOSTON, MASS.

JOHN F. TOBIN, President.

CHAS. L. BAINE, Sec.-Treas.

THE COMMERCIAL NATIONAL BANK

of KANSAS CITY, KANSAS.

CAPITAL AND SURPLUS, \$550,000.00.

DEPOSITS.....\$5,000,000.00

We cordially invite the Boiler Makers and Ship Builders of the United States who desire to transact banking business with us (which can be done readily by mail), to write to any of their officers and ask any questions they may desire to ask about our reliability and standing.

P. W. GOEBEL, President.

C. L. BROKAW, Cashier.

A. C. FASENMYER, Vice-President.

G. J. BISHOP, Asst. Cashier.

When Writing Advertisers

PLEASE MENTION

The Boiler Makers' Journal

Notice to Subscribers of the Journal

When members change their address, or do not receive Journal promptly, fill out the following blank and forward to the editor:

Name Reg. No. Lodge.....

Old Address, Street.....CityState.....

New Address, Street.....CityState.....

I have not received Journal for month of.....

KANSAS CITY, KAS., MAY, 1915.

THE BOILERMAKERS JOURNAL

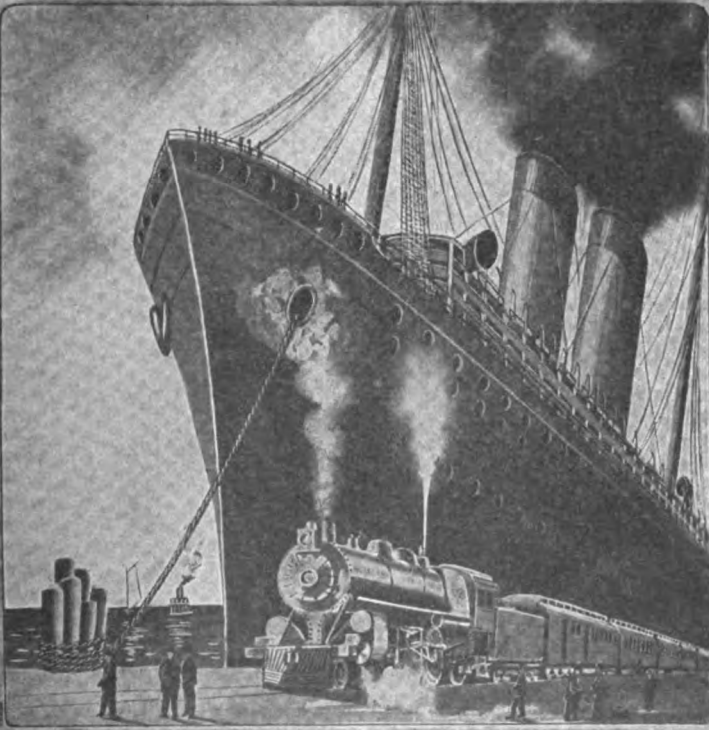

OFFICIAL ORGAN OF THE
INTERNATIONAL BROTHERHOOD
OF BOILERMAKERS, IRON SHIP BUILDERS
AND HELPERS OF AMERICA

HEADLIGHT UNION MADE OVERALLS

"A smile of satisfaction with every pair"



IT'S INEVITABLE—

Just as soon as a man steps into a pair of HEADLIGHTS, a smile ripples over his face. It's the result of complete satisfaction—that happy feeling of comfort and convenience that only the man who wears HEADLIGHT overalls knows.

Larned, Carter & Co. Detroit, Mich.

WORLD'S GREATEST OVERALL MAKERS
Factories:- Detroit, Pt. Huron, Mich., St. Louis, Mo., Sarnia, Ont.

SECURITY SECTIONAL ARCH

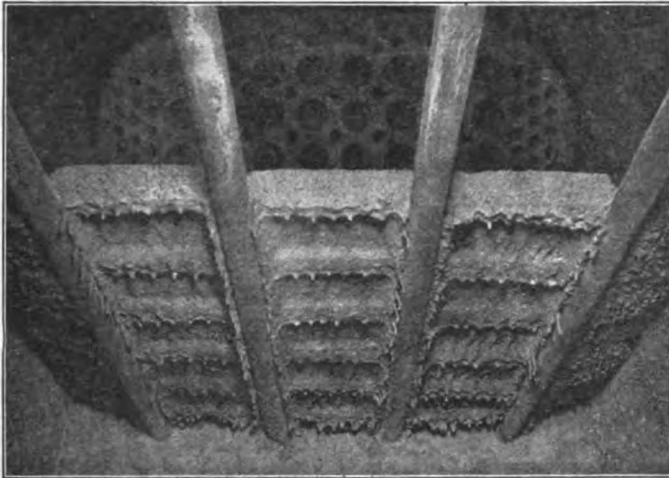

This arch is of light weight
It is built up of small sections
So made as to cool off quickly
It is easily removed for work
Made so to help the boilermaker

AMERICAN ARCH COMPANY

30 CHURCH STREET, NEW YORK

McCORMICK BUILDING, CHICAGO



Since the first railroads

Stifel's Indigo Cloth

Standard for over seventy-five years

has been the "old reliable" Over-all---Uniform---Shirt--- Jumper--- cloth for the "men of the road."

To three generations of railroaders it has demonstrated that *it's the cloth in the garments that gives the wear.* Stifel's Indigo wears like leather and looks good as long as it lasts.

Be sure you see this mark on the back of the cloth, inside the garments before you buy. It's your guarantee of the genuine Stifel Indigo.



Cloth manufactured by

J. L. STIFEL & SONS

Indigo Dyers and Printers. WHEELING, W. VA.

SALES OFFICES

NEW YORK.....	260-262 Church Street
BALTIMORE.....	114 W. Fayette Street
PHILADELPHIA.....	324 Market Street
BOSTON.....	31 Bedford Street
CHICAGO.....	223 West Jackson Boulevard
SAN FRANCISCO.....	Postal Telegraph Building
ST. JOSEPH, MO.....	Saxton Bank Building
ST. LOUIS.....	425 Victoria Building
ST. PAUL.....	238 Endicott Building
TORONTO.....	14 Manchester Building
WINNIPEG.....	400 Hammond Block
MONTREAL.....	100 Anderson Street



The Boilermakers' Journal

Official Organ of the

International Brotherhood of Boilermakers Iron Ship Builders and Helpers of America

Vol. XXVII.

KANSAS CITY, KAS., MAY, 1915.

No. 5.

AUSTRALASIAN LABOR REGULATING SCHEMES.

By Samuel Gompers, in the Federationist.

Historical Summary.

Serious efforts to colonize Australia began with the independence of the English colonies in America. England had need of outside lands for her superfluous people. "Superfluous" covered many classes. During the British civil wars it meant political prisoners and those who might stir up political opposition. At other times it meant criminals and those confined in jails. Then the poor and the paupers were the "superfluous." Transportation was the early method of dealing with these problems. Transportation in turn supplied colonists and labor for new territorial possessions.

English law of the eighteenth century provided numerous and lengthy jail sentences, consequently the jails were overcrowded. The beginnings of English Australia were an experiment with a convict settlement. The first boatloads landed in the swamps of Botany Bay. The convicts did not prove the best material for colonists. They knew little about farming and were determined to do as little work as possible.

The early colonial policy of New South Wales, which then comprised the eastern half of the continent, was dominated by convictism. The colonists were divided into two classes—criminals and warders. The distance of Australia from England was at that time a practically insurmountable barrier to attracting desirable colonists. But the theorists, the speculators and the unfortunate were free to do what they would with the land.

The warders, who were army officers together with the New South Wales Corps, maintained autocratic rule in Australia. There were two divisions of the period when convictism was the dominating policy—during the first division governmental attention was concentrated on the convicts and discipline during the second, upon ex-convicts (emancipists) and reformation. A rebellion forced the change to the second policy.

During these years, when the transportation of convicts was a governmental policy, there was an accompanying practice called assignment. Convicts were assigned to work on privately owned land, owners of which undertook to maintain the men.

Later it became the custom to assign men to any one who would agree to maintain them. Practically the whole laboring class were "assigned servants." The assignment practice was stimulated by the land grant system—one of the conditions of giving grants to free settlers in proportion to the number of assigned servants for whom they would become responsible.

Sometimes the men to whom convicts were assigned were ex-convicts hardened by the convict system. As a result of gross brutality many assigned men fled to the bush and became outlaw bushrangers. The influence of this convict slavery upon the colonists, who were the employers, can be readily imagined. The population of New South Wales in 1832 is suggestive; 32,000 freemen, 17,000 ex-convicts, and 28,000 convicts under sentence.

In 1840 the assignment system was replaced by assisted immigration. An Order-in-Council made Tasmania and Norfolk Island the only convict settlements in Australia. In 1852 the transportation of convicts was abolished except in West Australia. The constitution of 1842 established the foundations for self-government.

Meanwhile discontent, necessity for finding fertile fields, the grazing industry, the discovery of gold and other motives and causes had led to considerable exploration and the founding of colonies along the coast. These afterward developed into what are known as the states of Victoria, Queensland, South Australia, West Australia and Tasmania. The problems and conditions in all were practically identical.

The land laws of New South Wales provided the following regulations: At first, blocks were allotted for small quit-rents; later, to free settlers in sizes proportional to capital expended on the land and the number of assigned servants; land could be bought for a small price. In 1831 a new policy was inaugurated as a result of Edward G. Wakefield's propaganda against cheap land. There were to be no more land grants, but land was to be sold at public auction.

This Wakefield represents a class of colonists to whom Australia was a field for opportunity. He was a Whig philosopher whose theories were unhampered by practical experience. A pamphlet expounding his system of colonization was published in

1829. Wakefield thus analyzed the defects of New South Wales: It was no place for gentlemen, because the refinements of life did not exist there and because there was no leisure class. Wakefield's suggestions are thus described by an historian:

"A leisured class must have servants to do the work, and of free servants (for convicts were to be shunned) there were none. A laborer might work for you during the first year or two after his arrival from England, but he would be sure to save money out of his wages and buy land with it—for land was much too easily got in New South Wales—and then the refined master would find himself without a servant and must spend his leisure in working for his own living. These conditions produced a new kind of society, and not a good kind. A really valuable colony would be one in which the state of society in England was faithfully reproduced.

"How was this to be done? The letter had its remedy cut and dried. All the enumerated evils arose from the cheapness of the land—make land dear. Then the laborer could not afford to buy it and set up for himself; wherefore he would remain a laborer, happy and contented, earning his master's living as well as his own, and the master would have time to read and converse on intellectual matters with his equally leisured neighbors. Therefore, sell land at a high price, use the money thus obtained in bringing out emigrant laborers and take care only to bring just as many as would actually be wanted to cultivate the land sold. So everybody would be happy—the rich would hold all the land and the poor would never lack employment. The whole arrangement went like clock-work—in theory."

Wakefield's proposals had influence in Australia in abolishing land grants and in establishing Anglo-Saxon standards and a tradition of idealism in governmental affairs.

After several intercolonial conferences the Australian colonies agreed to an act establishing a federal government, and the Australian Commonwealth became a national state January 1, 1901.

Edward G. Wakefield had not exhausted his energy in Australia. In 1837 he was instrumental in the founding of the New Zealand Company to colonize New Zealand. The company encountered trouble in making the natives understand the English system of land ownership. Its intricacies did not appeal to their primitive sense of justice and they demonstrated the justice of their fame as fighters. In the end the natives learned to tolerate the system. New Zealand is a much more fertile, attractive land than Australia, with a more invigorating climate. In this more congenial region Wakefield's theories developed more satisfactory results.

Forces That Resulted in State Regulation of Industrial Relations.

In connection with convictism it must be remembered that prisoners of England were at that time political as well as criminal

and that the law of England provided imprisonment as the penalty for the unfortunate as well as the vicious. These convicts transported to Australia represented all kinds of people. Among those transported were the laborers of Dorchester who united to raise wages and were sentenced to imprisonment under the conspiracy laws.

All convicts were under the direct control of the government, which combined the functions of a warden, a labor employment bureau and an Italian padrone. The comparatively free settlers needed laborers; they looked to the government to supply that need and to maintain some sort of supervision over the workers. They were accustomed to regard the government as an employer if not an owner of laborers. The government with so many convicts at its disposal undertook extensive public improvements and public works and so established the traditions and customs of government employment and operation, and governmental regulation of relations of employers and employes.

The homogeneous nature of the colonial population was conducive to strengthening this characteristic. The colonists were almost wholly from Great Britain. Assisted immigration resulted in the selection of immigrants of a most desirable nature. As a result there was similarity in traditions, customs, ideals—characteristics that make for solidarity of the group and increase tendencies toward community or collective action.

Then, too, the idealism of Wakefield had left its impress upon community thought, it gave them a utopian vision, a sort of paternalistic ideal of what government may do for the people through regulation.

These are the conditions and tendencies that naturally resulted in the socialistic legislation of Australasia. The effects of this legislation can best be seen in concrete illustrations.

Economic organization of workers in Australasia was comparatively late because the services of skilled workers were so much in demand that the workers received good wages. Following upon the reaction of the rush to the gold fields the number of people seeking work greatly increased. Organization became necessary for self-protection and the labor movement began. After the fifties the movement steadily grew.

The official Bulletin published by the Australian Commonwealth classifies the labor organizations under four classes: (1) independent local unions; (2) those with a state organization; (3) organizations whose jurisdiction extends over two or more states; (4) Australasian or international organizations which include workers in merchant service or nomadic trades.

The census for 1912 gives the following figures: Total number of members of trade unions in the Commonwealth, 433,224; total number of employes over 20 years old in all professions, trades, and occupations, 944,559.

There is no federation of all the labor or-

ganizations of Australia, although efforts have been made in that direction. In 1879 when a world exposition was held at Sydney an intercolonial labor congress was held also. Other congresses were held afterwards at various intervals of three, four and five years, but no permanent organization was established. These congresses considered only matters of intercolonial or interstate nature. Each was called through the initiative of some trade especially interested. Some of the allied trades have organized trades councils—such as the building trades, the iron trades, the food producing and food distributing trades.

Method of Political Regulation.

In the Australasian states minimum wages have been established by means of governmental agencies in two ways; wages boards established for the purpose of fixing wages and industrial arbitration courts to prevent strikes. The first of these laws was the compulsory arbitration law of New Zealand following the seamen's strike. Arbitration courts have found that they must exercise the power to regulate wages as an incidental power necessary to the effort to maintain industrial peace.

The minimum wage is fixed by wages boards, government agents who have the right to compel employers to pay at least the wage fixed. Where the minimum wage is a by-product of industrial arbitration courts, workers have been fined and imprisoned for not conforming to the decrees of the judges of these courts.

Courts of Industrial Arbitration have been established by West Australia, New Zealand, and the Commonwealth for industrial disputes that affect more than one state. Victoria and Tasmania have wages boards and no state arbitration courts. New South Wales, South Australia and Queensland have industrial courts to which decisions of wages boards may be referred.

South Australia in 1900 amended its factories act to provide for the establishment of wages boards. Court decisions practically invalidated the legislation. Further legislation was enacted in 1906. Again the courts interfered with the result that the wages board system did not really become operative until 1908 when the law was revised and made to forbid strikes and lockouts. In 1912 a compulsory arbitration law was adopted which subordinated wages boards to an arbitration court and established the judicial system of wage regulation.

Queensland adopted the wages board system in 1908. Following the general strike which originated among the tram workers and tied up all industries in Brisbane, the compulsory arbitration system was adopted in 1912, accompanied of course by judicial regulation of wages.

New South Wales established an industrial arbitration system in 1901, which in 1908 was grafted upon a wages board system, so that the government undertook to regulate wages, hours and apprentices and to prohibit strikes and lockouts. The method of the New South Wales system is highly

judicial in character. It proceeds by taking testimony as the basis for reaching a judicial determination. Its wages boards have all the symptoms of courts. The arbitration act of 1912 did not modify the essentials of the system.

Tasmania enacted a wages boards act in 1910. It forbids strikes and lockouts in matters concerned with decisions of the state boards.

Victoria established the wages boards system in 1896 and has since extended the system and increased the powers of the various boards. The characteristic of the Victorian system is conciliation.

Even from this brief summary of legislation regulating wages this tendency is manifest. Wherever any degree of power to regulate wages is granted to state authority that authority with increased powers of enforcement is gradually extended.

Regulation in New South Wales.

New South Wales is the chief industrial state of Australia and contains the largest city. The workings of their system of governmental regulation of wages is very interesting in view of the fact that similar legislation is urged for American industrial centers.

The law regulating industrial relations now operative in New South Wales became law April 15, 1912. The title of the law indicates how complete is the control which the government exercises: "An act to provide for the regulation of the conditions of industries in certain particulars by means of industrial conciliation and arbitration, and for the repression of lockouts and strikes; to establish and define the powers, jurisdiction, and procedure of an industrial court and certain subsidiary tribunals; to preserve certain awards and industrial agreements."

The agencies and methods of exercising this control are of a judicial nature. This judicial characteristic is manifest in the fact that New South Wales has a Labor Attorney-General and in the details of the law and its operation given below.

The industrial arbitration legislation of New South Wales is intended to regulate employers as well as employes. It prescribes for them the minimum wages that can be paid, limits the hours of work and the proportion of apprentices. The state undertakes to police and enforce all awards through a professional prosecuting officer and a staff of industrial inspectors. Breaches of awards and industrial agreements are prosecuted in the arbitration and inferior courts of the state.

The whole system is under the supreme direction of the Court of Industrial Arbitration, which office is occupied by Judge Heydon.

The law of 1912 was intended to make various changes in the act of 1908. One purpose was to reduce the number of wages boards dealing with local wages and industrial conditions. In order to accomplish this the craft instead of the industry was made the basis for organization. The intention is to bring together allied industries under

one chairman so that there shall be twenty-eight subsidiary courts of arbitration.

The "advanced" step which New South Wales desires to establish is the "principle of craft unionism which involves the claim that all craftsmen such as carpenters, engine drivers, painters, engineers, and so on, shall belong to the same union."

To take advantage of the 1912 Industrial Arbitration Act employers and employes must register. The registrar, a state official appointed under the act, has considerable discretionary power. He may register as an industrial union of employers any person or association of persons, or any incorporated company or association of incorporated companies, who or which has in the aggregate throughout the six months next preceding the date of the application for registration employed on the average, taken per month, not less than fifty employes. Any trade union may register as an industrial union of employes. However, any such application may be refused by the registrar if he is of opinion that the organization applying is not a bona fide trade union, or if registered under the act would not be a bona fide industrial union, or if it appears that another trade union to which the members of the applicants' union might conveniently belong has already been registered as an industrial union.

Applications must be made in writing, approved by the majority of the governing bodies in case of employers and by the majority of the committees of management for trade unions.

The judge of the Arbitration Court has absolute control over registration by his power of cancellation. "For any reason which may appear to it good" the court may cancel the registration of any union. The court may also cancel registration upon the request of an industrial union. Cancellation however, affords no relief from existing awards and industrial agreements, except when the union or its members have aided or instituted a strike or lockout and then upon consent of all parties concerned.

Industrial agreements may be made between employers and employes, and if not for a longer term than five years may be filed with the registrar by either party. When filed these agreements become enforceable just as awards made through agencies of the arbitration act.

Control over industrial regulation is centralized in the Court of Industrial Arbitration, which is a superior court, a court of record and seal. The court consists of one judge, Judge Heydon. In case of a vacancy the Governor may appoint a Supreme Court judge, a District Court judge, or a barrister of five years' standing. An additional or a deputy judge may be appointed when necessary who must have these same qualifications.

Under the industrial court are the wages boards. At the recommendation of the court, boards shall be constituted for the industry or calling. The ideal is to group trades or industries under twenty-eight

heads, but numerous demarcation (jurisdictional) disputes have resulted in many more boards. This is another proof that industrial relations can not be arranged according to any theoretical plan—they have grown in certain shapes and forms and like all live organisms resent amputation and pruning.

The court recommends the chairman and the other members of all boards who are appointed by the Minister. Each board consists of a chairman who presides and two or four other members, half of whom represent employers and half employes. When the employers or employes are largely women or girls, and there is in the opinion of the court no one of them suitable to act upon the board, an outsider may be appointed. Since the court is to be the judge as to the qualifications of a woman or girl to defend the rights and interests of her associate workers, may not intensity and persistency in a woman or a girl be regarded and held as disqualifying characteristics?

The boards model themselves after the parent body and are petty courts. They usually meet in police courts, a custom which adds judicial atmosphere. Members are appointed for three years but may be removed by the Minister. They take an oath not to reveal evidence of a confidential nature before the board. The sessions of the board may be public or secret at its discretion. The board members receive fees. Charges have been made that the fees are sufficient to lead to dilatory methods. It is the custom to appoint lawyers as chairmen of the boards. Often these are young lawyers of the "briefless" type and sometimes they are men of established reputations. Employers have made objection to trade union officials acting upon boards. This objection has occasionally resulted in officials resigning office and working at their trades while serving upon the board. Employers even in Utopian Australia do not wish employes to have the advantage of the bargaining skill of trained men.

The boards examine witnesses and take evidence preparatory to reaching their judicial determinations. Their authority in making recommendations extends to the following:

(a) Fixing the lowest prices for work done by employes, and the lowest rate of wages payable to employes, other than aged, infirm, or slow workers.

(b) Fixing the number of hours and the times to be worked in order to entitle employes to the wages so fixed.

(c) Fixing the lowest rates for overtime and holidays and other special work, including allowances as compensation for overtime, holidays and other special work.

(d) Fixing the number of proportionate number of apprentices and improvers and the lowest prices and rates payable to them.

(e) Determining any industrial matter.

(f) Rescinding or varying any award made in respect of any of the industries or callings for which it has been constituted.

(g) Declaring that preference of employ-

ment shall be given to members of any industrial union of employes over other persons offering their labor at the same time, other things being equal: Provided that where any declaration giving such preference of employment has been made in favor of an industrial union of employes such declaration shall be cancelled by the Court of Arbitration if at any time such union or any substantial number of its members takes part in a strike or instigates or aids any other persons in a strike; such court may suspend such declaration for such period as to it may seem just.

An award is signed by the chairman and sent to the registrar, who publishes it in the New South Wales Industrial Gazette and notifies the parties concerned. Parties to the agreement, or any person, with the consent of the court, may apply for variations or amendments to the award.

New South Wales has suffered so much because of industrial dislocations (strikes or lockouts) in the mining district that the act of 1912 provided a special arrangement for such difficulties. These conciliation committees are not hampered by the judicial methods of the boards but endeavor to institute real conferences between the parties concerned in the industrial disagreement.

Since strikes and lockouts (dislocations) are forbidden by law, such illegal acts may be severely punished.

The court may fine industrial unions which instigate, take part in or aid strikes or lockouts a sum not to exceed one thousand pounds (\$5,000).

Any individual who participates in a strike may be made to pay a fine not more than fifty pounds.

Wages may be attached to pay such fines.

If the person is a member of a trade or industrial union the union may be fined in addition.

If any union of employes instigates or aids in an act for which any person can be fined the union may be ordered to pay a fine not to exceed one thousand pounds and its registration may be suspended or cancelled at the discretion of the court.

Uses of the injunction are legalized that out-Dayton our own Judge Dayton.

The courts may grant a writ of injunction to restrain any person from continuing to instigate or to aid in a strike or lockout. Such a writ may upon application be granted *ex parte* or on notice.

The dignity and majesty of the court are upheld by declaring violation of injunctive orders a misdemeanor punishable by imprisonment for not more than six months.

The conception that the labor power of human beings is a commodity or property is embedded in Australian law and is generally acquiesced in by the Australian laborers.

When an employer fails to pay the wages fixed by an award or industrial agreement the employe may apply to the registrar or an industrial magistrate for an order for payment, or may enter suit in any district court. Breach of award or industrial agree-

ment may be punished by a fine not in excess of fifty pounds. In case of wilful act to defraud an injunction may be granted to prevent further breaches.

Since organization is a part of the machinery of industrial regulation employers may not dismiss employes because of membership or activity in a trade union. Any employer who dismisses employes for such cause may be fined not more than twenty pounds for each worker dismissed. The burden of proof rests upon the employes to show that the dismissal was not for some other cause. However, no prosecution for an offense of this nature shall be commenced except by leave of the court.

Results of Industrial Arbitration.

Now as to the way this system of state regulation of industrial relations works out. That is best demonstrated by Australian comments. We will relate incidents published in Australian papers.

The Daily Telegraph made the statement that there had been an unusual number of strikes and lockouts in Australia during the past year, which was almost exactly in proportion to the strength of unionism in the various states, and concluded that unionism means strikes.

The Australian Worker, the official organ of the Australian Workers' Union, published in Sydney, made the following reply, which shows that the workers' idea of what constitutes the real protection of the workers does not differ fundamentally from that of trade unionists of the United States:

"Unionism does not necessarily mean strikes, but it does mean the bettering of wages and conditions of labor, because through unionism labor has the power to strike."

When the European war began, Judge Heydon refused to consider further applications for increases in wages and declared that the Australian workers must share the misfortunes of war with the other patriots. This important decision marked the collapse of the system regulating wages, perhaps temporarily but yet effectually. Judge Heydon found it necessary to modify his decision to apply only to government employes. This is the comment of the Australian Worker of January 14:

"The vetoing, ostensibly on account of the war, of any further applications by unions for increases in wages may say a good deal for the personal opinions of Mr. Justice Heydon, President of the N. S. W. Arbitration Court, but it doesn't say much for his logic.

"On every hand the prices of commodities are going up. Meat is 50 per cent dearer than it was a few months ago; bread is dearer, and house rents have not decreased, despite the fact that they were forced up in times of unparalleled prosperity.

"In fact, it is safe to say that living is at least 20 per cent more expensive in New South Wales than just before the outbreak of war.

"Now note the illogicalness of the position.

"If the Big Business man desires—and he seems to be always desiring—to increase the price of his goods he can, and does, approach the Necessary Commodities Commission. That Commission doesn't tell him that, for the sake of the Empire, all such applications are 'off,' and that the prices obtaining before the war and the imposition of the new tariff duties must continue to prevail.

"Instead it invites him to step inside, considers his application, hears all the evidence—indeed, goes to a lot of trouble to get evidence—and then gives a decision, usually in favor of an increase.

"Why should this illogical distinction be made between the man who has goods to sell and the man who has his labor to sell—especially as it is the latter's labor which produces the former's goods?

"If things are to be left as they were in the one case, why not in the other? What is the operating difference?

"Has labor organized, fought, suffered, and sacrificed to win elections and put its party in power only to give the exploiter all the advantages while it is brusquely requested to stay out on the doorstep?

"One of these days when Mr. Justice Heydon isn't too busy dilating on the political economy which he knows so little about he might answer these questions.

"In the meantime Organized Labor would do well to answer them itself."

The conclusions of these workers who have tried the system of state regulation of hours and wages which many theorists have been trying to fasten upon American workers is most noteworthy. "Organized labor would do well to answer this question itself." Whatever benefits organized labor establishes through its economic power and retains control in its own hands are the things alone upon which it can depend.

Jurisdiction of Industrial Court.

It will be remembered that the authority of the Court of Industrial Arbitration permits it to determine any industrial matter.

That authority was made to include control even over the labor press, as will be seen in the case of the cancellation of the registration of the New South Wales Amalgamated Railway and Tramway Service Association. This organization endeavored to enroll all unionists of every branch of the railroad industry into one union. When the 1912 act became operative the Railroad and Tramway Traffic Association, which was organized on the principle that each group or section of workers could be best protected by separate organizations, tried to secure its representatives upon the wages board, although it was not registered. The Traffic Association charged that the Amalgamated Association had delayed the work of a previous board and had deliberately impeded the last board because of hostility to its chairman. To substantiate the last charge the following was quoted from the official journal of the Amalgamated Association, the Co-operator:

"Just here let me say, in parenthesis, that the meeting of the Railway Traffic Board

has not been pushed on. The executives of the Association have been waiting for the new arbitration act to come into force in the hope that the millstone of Hamiltonism might be got rid of, and a big effort in this direction will be made."

Incensed by this plain statement, which the judge deemed contempt of court, the registration was cancelled. This gave the Traffic Association the opportunity to secure registration and to get its members on the board. The Royal Commission, authorized to report on this and other matters to be specially considered with reference to the legislation of 1912, which was under consideration, makes the following comment, which applies equally to all other workers who have not the right of registration:

"But although the same class of workers was represented on the new board, and although the Amalgamated Association could have submitted claims and have had their witnesses examined, though not by their own counsel, it was no doubt a serious loss to the Amalgamated Association, which so far as the Traffic Wages Staff is concerned far outnumbers its rival—the respective figures being 15,000 and 1,200. If a suitor has a claim to an estate and is entitled to bring that claim before a court in his own way and by counsel who instructs, it is no consolation to him to be told that his interests are being safeguarded by a distant and not too friendly cousin who is making a claim of a similar nature and on similar grounds to his own, which if granted will injure to his benefit."

That commission then makes this significant statement as to the power of the court:

"With regard to the power of cancellation, I suggest that this should be limited to specified cases, and no longer left to give rise to such surprises as that which the union has experienced in the present case. The power of initiation which the court possesses should, as I have already suggested, be left as it is; but it is a provision foreign to ordinary judicial system which casts upon a court so grave a responsibility, and arms it with so crushing a power, as that of expelling competent suitors forever from all rights of audience or remedy, and this for reasons undefined by Parliament and therefore, until a specific incident arises, undefinable by the court."

The New South Wales system of regulating industrial relations with all its authority and power makes provisions for all industrial problems except industrial freedom. The judicial despotism which rules over industry maintains many of the principles and practices which the workers of the United States of America have persistently denounced and opposed. Instead of being a workers' paradise, New South Wales is rather a paradise for lawyers.

There is nothing in the system of governmental regulation of industry as developed in New South Wales that is in conformity with the spirit or the genius of the people of the United States.

THE BOILER MAKERS' JOURNAL

Official Organ of the International Brotherhood of Boiler Makers, Iron Ship Builders and Helpers of America.

A Monthly Publication Issued the First of Each Month from Room 3, Law Building, Kansas City, Kansas.

JAMES B. CASEY, Editor and Manager.

Subscription Price.....\$1.00 Per Year in Advance

ADVERTISEMENTS.

Advertising Rates Will be Furnished Upon Application to the Editor-Manager. No Reading Space Will be Sold for Advertising Purposes Under Any Circumstances.

All New Members Must Have Their Name and Address Sent in Through the Secretary of Their Lodge. After That They May Have Changes Made in Their Address by Filling Out Blank Form in Back of Book and Forwarding to the Editor.

All Copy Must be Received by the Editor by the 18th of the Month to Insure Publication in the Following Issue.

All Contributions and Correspondence Relating to the Journal Should be Addressed to J. B. Casey, Editor, Room 3, Law Building, Kansas City, Kansas.

Entered at Postoffice, Kansas City, Kansas, as Second Class Mail Matter.

SPREADING FALSE NEWS.

A short time ago many newspapers announced that the strike in the oil fields was settled, possibly the Associated Press spread the news for all we know, at any rate this was an unauthorized statement and bears all of the ear marks of having been faked for the purpose of deceiving our members in particular, and the working people generally, so that large numbers of men might be induced to go there seeking work, thinking everything was settled and becoming stranded, be forced to join the strike breakers' ranks. According to a state law of Oklahoma these unfair firms dare not advertise for men without announcing that a strike is in progress, some did this at first and still have hanging over their heads the possibilities of an indictment.

While a large proportion of our members in the fields, we believe, are working for fair firms, who seem to be getting more and more of the work, still the firms whose names appear in the Journal are still trying to operate on open shop basis and our members should refrain from taking work in the fields until they become conversant with the particulars surrounding same. And by all means pay no attention to rumors or newspaper statements about settlements, when a settlement is reached ample notice will be given.

TIME TO CALL A HALT.

In the past couple of issues there have appeared certain articles which, no matter what the motive of the writers, are tending to arouse dissension and hard feelings in our ranks that bodes no good to our organization and in our opinion it is time to cut out all such articles and stuff of this kind. We have been slow to arrive at this conclusion, we wanted all of our members to feel that the Journal was not only theirs collectively, but that each were privileged to write articles of a helpful and instructive nature and have them published in the Journal, in short to make it a clearing house for the exchange of information and ideas among our members as how best to build up and manage our Brotherhood, we saw signs of an inclination of

some to violate this standard of helpfulness and good will and we appealed to our members in March Journal to refrain from writing articles of a personal or abusive nature, however, some did not give much heed to our appeal; some of the articles appearing in the past two issues not only made many unsubstantiated charges but indulged in personalities, these naturally elicited answers in the same strain. In this issue will be found more articles along the same line only becoming worse as they proceed; we have refrained from turning down any of these communications up to the present time although we are accused of doing so by one of the articles in this issue for no better reason than the correspondence from the other members did not favor their position; there is no foundation for this charge, we are always prompted to act in the way we believe is for the best interest of our organization and its members, regardless of how it effects us and we are going to do so in this case; therefore, becoming convinced that it is for the best interests of our organization that these mud slinging articles be cut out, we are going to assume the responsibility for refusing to publish any more of them from any body from this issue on, unless we are overruled by a higher authority, if any should feel aggrieved, they of course have a right to an appeal from this decision of the editor, however, we feel we are voicing the sentiments and desires of a large majority of the rank and file of our organization.

Our members are still invited to write for the Journal, their articles should be newsy, instructive or in some way helpful, and must be free from criminations, recriminations, personalities or abuse. We trust that all of our members will acquiesce in this decision, that all feeling will be allayed and the Journal resume the high standard it has been trying to follow in the past.

We have no desire or intention of editing a muck raking publication and the Journal will not deserve to bear that title if we can prevent it. We hope the foregoing will meet with the approval of all our members and that all will join with the editor in trying to make the Journal more efficient and valuable to our organization and all its members.

BIG BUSINESS DREADS AND FIGHTS UNIONS.

At the Chicago hearing of the Industrial Commission, several officers of big business were on the witness stand, and practically all of them admitted discriminating against union men and a hostility to organized labor. President Carlton and Vice-President Brooks of the Western Union admitted that commercial telegraphers were underpaid and at the same time also admitted that membership in a labor union was sufficient cause for their company to discharge any of its employes, that they would have nothing to do with the union. Vice-President Reynolds of the Postal Telegraph, shared the Western Union's hostility to organized labor, but admitted his company has organized a fake union among its employes which is absolutely controlled by the company. These two companies organized and entrenched in every possible way, deny to their employes the right to organ-

ize for their protection. This seems to be a characteristic attitude of the representatives of big business, they want nothing to stand in the way of their absolute power over the lives and fortunes of those in their employ, this intolerant attitude only hastens government ownership of these two companies, a thing that should have taken place long ago. We are the only great nation of the world that does not own and control all telegraph and telephone lines, the present war in Europe has greatly emphasized the importance and necessity of government ownership, and this is liable to be a live issue at an early date, however, it is not likely that the government will purchase them until the hundreds of millions of water is squeezed out of the stocks and bonds.

General Superintendent Bell of the Illinois Central Railroad, while on the stand gave it as the reason that his company refused to recognize the federation of shop employes and which resulted in a strike, that a "federation would be too hard for the company to handle." President Markham of the same road presented a voluminous statement in which he said if the System Federation was "allowed to grow it would threaten the life of every industry in the nation," these statements cannot be reconciled with the experience of other roads with the same kind of an organization, the roads in the southeastern states have agreements with the federation of shop trades, the management and the men live in harmony with each other and there has not been a strike there since these federations were formed. This shows pretty conclusively that the I. C. officials' fears were groundless and had they been better advised, this strike would not have taken place. Of course, these officials have got to have some excuse to try to justify their actions, and one thing is as good as another we suppose.

RAILROAD HIGH FINANCE.

A recent press dispatch informed us that the appellate division of the supreme court of New York had declared that bonds to the amount of \$5,133,000 issued in the name of the Wabash Railroad in 1913 was illegal and the board of directors headed by George Gould was held personally responsible and they would have to return the above amount together with interest since October 15, 1915. This gives a glimpse of railroad high financing and the facility and practice of railroads in issuing these bonds.

The issue of which the above mentioned sum was a part amounted to \$30,000,000. Certain stockholders entered suit against the directors claiming unlawful issue of stock and the lower court upheld this contention, however, an appeal was take by the directors and the appellate court passed all but the above mentioned \$5,133,000.

Most of the railroad systems of the country are today suffering from the effects of past reckless issues of stocks and bonds and they are called upon to pay interest and dividends on fabulous sums that represent nothing but water.

AMERICAN STANDARD OF WAGES TOO LOW SAYS A PROFESSOR.

Professor Scott Nearing of the University of Pennsylvania, writing in "The Survey" states that from two-thirds to three-fourths of the male wage earners in the northern and eastern parts of the United States, employed in the leading American industries, are not paid enough wages to keep a family of five in decency, and permit saving to avoid dependency in old age.

He asserts that the working man "should compare his methods of accounting with that of a modern business," he argues that the worker in the industrial field, represents an investment, a part of which is his bring up and education, and that when the industrial manager makes an investment in the shape of a new machine, he estimates the life of the machine and sets aside a certain portion of this amount each year, and charges it to depreciation so that at the end of the period he may replace the worn out machine by a new one. He argues that the workers should charge depreciation against their services, so that besides maintaining themselves and family during the period of their productive usefulness, they should have enough to provide against want in old age.

He claims to have investigated and found that in the northeastern states, from two-thirds to three-fourths of the males employed in the leading industries do not receive a sufficient wage to provide a decent living for a family of five, much less to provide for old age. He argues that business men start to making income after they have met running expenses and paid fixed charges and that the working man who only makes a bare living for himself and family has no income.

All of this is logical, equitable reasoning and it should be universally put into effect, men do not want charity but even handed justice, they should receive for their services to society, not only a sufficient amount to meet the ordinary living expenses and cost of raising and education of their children, but enough to purchase insurance against accidents and want in old age.

The case of maintaining and raising a family is a fixed charge against the industry, as is also insurance against sickness and industrial accidents and old age pensions.

U. S. TO BUILD ALASKAN ROAD AT ONCE.

A recent press dispatch announced that President Wilson had selected the route for the Alaska Railroad which this government will build and that work would commence at once. Congress left the selection of the route to the president, two or three different routes were considered and the one decided on will start from Seward, situated on Resurrection Bay and will be built to Fairbanks, which is situated on the Tanana River.

The Alaska Northern Railroad already built was purchased at a cost of \$1,150,000 and will be a part of the system. It is estimated that when the whole line is completed it will cost \$26,800,000. The work will begin in charge of a Commission consisting of W. C. Edes, Lieut. Frederick Mears

and Thomas Riggs, Jr. We are told that the Commission will proceed at once to Alaska to take charge. Chairman Edes will make his headquarters at Seward, Lieut. Mears will be stationed at Ship Creek and Riggs in the Broad Pass region, as soon as the route was selected and work ordered started, President Wilson issued the following order: "I charge the commission particularly with the preparation and maintenance of such arrangements as may be required for the health of the men engaged in the work of construction, and I instruct you to prepare and adopt a proper system of compensation for accidents which may occur on the work, in general on the lines of the system, now in force in the construction of the Isthmian Canal, but such system shall be so framed that its benefits shall be applicable not only to those who are directly in the service of the Commission upon salary, but also to those who may, by contract with the commission, be actually engaged in the work of construction in Alaska." Thus the victims of accidents will be given some compensation for same.

While this work will start at once, it seems there is but a limited chance of getting employment as a part of the construction force, and as we have had some inquiries already in reference to this job, we want to warn our members against going to Alaska with the expectations of getting a job, we are told that but few men will be employed by the commission and Secretary Lane of the Interior Department has issued a warning against a stampede there. If any of our members desire to go there they should write to Washington or members of the Commission and make application for employment, if they are engaged all well and good, but it is taking a big risk to go there on your own hook.

OUR LODGES SHOULD AFFILIATE WITH STATE FEDERATIONS.

We would like to impress upon our members everywhere, the importance and necessity of our lodges being affiliated with the State Federation of Labor in the state where they are located. They should not only be affiliated, but should be represented at all their annual conventions by their most experienced and able members, so that legislation and other matters affecting our members or our trades may be properly looked after, this can only be done by having able representatives present and in this way become a factor in the affairs of the general labor movement.

Too often our lodges neglect this duty and are content to remain isolated from the other members of the family of trades unions, and as a consequence when we need aid and assistance, we know not where to get them, as we neglected to cultivate the friendship and co-operation of other trades.

In no line of business is this co-operation of other organizations so essential for success, as in trying to secure the enactment of labor legislation. Those who have had experience in lobbying for labor measures, realize more fully than others the importance of this matter.

We need to have enacted in a large majority of the states, an effective boiler inspection law, and if we are going to make an effort to accomplish

this task, the sooner we start out to do so, the better it will be, for others are trying to get such a law enacted with men of other callings as inspectors and it seems that they have the passive, if not active assistance of certain insurance companies; therefore, if we would have efficient laws enacted and have justice given to our members, we must promptly take hold of this matter in an active and intelligent manner and secure the assistance and co-operation of organized labor, generally if possible. In no better way can we secure this co-operation than by affiliating with the central bodies and state federations.

A NOVEL EXPERIMENT IN MANAGING AN INDUSTRY.

The public press announces that the Dennison Manufacturing Company, a five million dollar corporation of Boston, Mass., would be turned over to a part of the employes to manage and all employes will share in the profits of the concern. The company now employs 2,400 persons; of this number about 200 will join in the management, this embraces all who have been earning \$1,200.00 or more a year.

It seems the plan is to issue management stock, and divide this among these 200 employes, the voting of this stock will control the policy of the concern. We are told all employes will share in the profits, through provision for annual or more frequent returns on their operating capacities," just how this will be determined it does not state. This experiment will be watched with interest, and if it proves successful it will no doubt encourage other concerns to follow suit. There is no reason either why it should not prove successful, for the men selected are no doubt practical experienced men and are practically running the plant at the present time, although without being recognized.

We mentioned the matter of having the men represented on the Boards of Directors of Corporations sometime ago and still believe it would be in the interest of all if one or two old experienced employes were added to the board of directors of each manufacturing industry, it would not only produce a keener interest in the welfare of the concern and establish a greater degree of confidence between employers and employed, but many good, practical, money saving suggestions would be received that would bring in good returns.

INDUSTRIAL UNIONISM, AMALGAMATION, ETC.

For a number of years there has been an agitation by some for industrial unionism, the one big union and consolidation of trade unions, evidently an effort on their part to find some short cut, quick action plan by which organized labor will be made perfect and achieve complete success without further trouble, these are worthy objects of course; but in our haste to reach this goal, we should be careful not to seize hold of something as a weapon, which instead of battering down the opposition will hurl us to destruction. Fable tells us that once upon a time a dog was crossing over a stream of water with a bone in his mouth and looking down saw another bone, in his greediness to possess this too, it let go the bone in his

mouth and made a dive for the other one, only to find it was the shadow of the one it held in its mouth only an instant before and of course the dog lost both bones. We can learn a lesson from this fable, learn that it is not wise to drop the substance in order to seize the shadow; organized labor is but in its infancy here and as we advance from one formative stage to another, and thus pass over the waters of agitation and desire for a change, we should not drop the substance, our present organization—in order to seize the shadow of some chimerical and impractical plan and in doing so not only lose what organizations we have, but set back the cause of labor for years.

It seems to us a great many have a very imperfect conception of the term, "industrial unionism," some seem to think the amalgamation proposition advanced by the machinists and industrial unionism is one and the same, in this they are seriously mistaken. If labor in this country was to be divided into strictly industrial groups, the members of our organization would be divided into several groups and amalgamated with the other workers of these several groups, for instance, those working for railroads would be grouped with all other employes of railroads; those working in locomotive plants would be grouped with all others employed in this industry; those working in ship yards would be consolidated with all other ship yard employes; the contract shop would be grouped with the others employed in the same industry; as would also the tank builders be grouped with all men employed in this industry. It will not take a lengthy argument to convince our members of the disadvantages arising from such a plan; in some cases our members in order to make sure, if possible, of steady work, would have to carry cards of two or three organizations, and a large proportion of our members would be like a shuttle-cock, running back and forth from one organization to another.

While the opinion is entertained by many that this plan would have a centrifugal effect, that is a drawing closer together, it would in fact have a centripetal effect, that is a throwing off, or in other words a regrouping more numerous than we now have in the trade unions, for after each trade, each calling, and those employed in manufacturing, selling and distributing of the various articles of commerce, were divided into these many groups, they would number many more than we have National or International Unions at the present time; all that would be accomplished would be to divide about all mechanical trades and changing the formation of the ranks without increasing the efficiency of organized labor. Some of our members are constantly reciting all the ills that mankind is heir to as evidence of the failure of organized labor, instead of offering encouragement and assistance in helping to fully organize our craft, and in other ways perfect our organization; they are trying to find some new and untried form of organization to substitute in its place; others there are who believe we are making no progress unless we are constantly changing from one thing to another, they too are ever ready to condemn the trade union movement, instead of examining closely our past actions and practices, so that profiting by this experience, we may avoid in the future, the mistakes of the past.

They entirely ignore these, ignore the immutable laws of cause and effect, and are ready to condemn some supposed inherent weakness of craft unionism, instead of examining closely the records of our past policies and practices, in order to find out the errors we have committed and by avoiding them in the future strengthen our organization and make sure its future success.

Too often in the past the radical has dominated the action of some of our locals and forced them into hasty and ill advised strikes without fully endeavoring to peaceably adjust their grievances, calculating the possibilities of success or making preparations for carrying on a contest. The failures produced by such ill advised actions should not be charged to organized labor's inefficiency but to the unwise actions and advice of those precipitating the trouble.

If we are wise we will study the efforts and experience of those who went before us, for experience is the chart of the sea of human efforts and marks the reefs and shoals upon which was wrecked the inexperienced and unwise efforts of those who proceeded us and the lessons derived from this experience, is the compass that points the way to the harbor of success. It seems to us the lessons taught by the past failures of promiscuously formed unions, plainly shows the inherent weakness of the plan; the Knights of Labor went to pieces because of friction, internal dissention and dissatisfaction, which finally brought about dissolution; the A. R. U. seemingly was run on a quick action, hair trigger basis that ran it into a life and death struggle in short order and it did not survive, the shock of the first battle; this is not intended as a criticism of that organization but to show the weakness of the form of organization. The I. W. W. was formed upon even a more quick action basis and it went to pieces with the same speed and without accomplishing any good for the workers.

The underlying policy of promiscuous organizations seems to be to depend upon numbers instead of organization, to overawe by size rather than efficiency of organization; however, in our opinion, this theory is wrong. No doubt many of our readers have seen large mobs of people handled by a few well trained policemen acting in concert with each other; systematic, efficient, organization and intelligent action counts for much more than mere numbers. Another fault is that large membership inspires so much confidence, it breeds contempt for caution or discretion and as a consequence it is easily stampeded, some member pleading the cause of a real or imaginary grievance, may use some little eloquence, the members' feelings are played upon and too often it results in a stampede, hasty action and trouble. While on the other hand if this hasty action is taken by a local in affiliation with a federation of all employes the latter will have to pass upon it and it will likely correct a mistake if it is made, and in this way a large part of the trouble and strife caused by hasty action will be avoided.

Our present organization is a consolidated one, we have boiler makers, ship builders, tank and gas meter builders, and helpers of all those previously mentioned. We are bound together by a similarity of trades, what concerns

one, concerns all; we may, yes, probably will consolidate with other trades in the future, however, in our opinion it will not be with the organizations mentioned by the present consolidation proposition, but with other trades, whose work is similar to our own such as the structural iron workers, and sheet metal workers. The last convention of our organization went on record as favoring this consolidation. The present is not an opportune time for the accomplishment of this task; however, it is quite likely that the future will bring about conditions which will not only make it possible but desirable. These trades are consolidated with the boiler makers and ship builders' organization of Great Britain and Australia and the plan evidently works alright in these countries.

Let us persevere in our efforts to build up our organization, better organize our trades, and meet the other problems that confront us, and these others will be met at a more opportune time.

QUOTATIONS.

It behooves us always to bear in mind, that while actions are always to be judged by the immutable standard of right and wrong, the judgments which we pass upon men must be qualified by consideration of age, country, station, and other accidental circumstances; and it will then be found that he who is most charitable in his judgment is generally the least unjust.—Southey.

There are a multitude of human actions which have so many complicated circumstances, aspects, and situations, with regard to time and place, persons and things, that it is impossible for anyone to pass a right judgment concerning them without entering into most of these circumstances.—Dr. I. Watts.

From the first record of human impatience down to the present time, it has been complained that the march of violence and oppression is rapid, but that the progress of remedial and vindicative justice, even the Divine, has almost always favored the appearance of being languid and sluggish. Something of this is owing to the very nature and constitution of human affairs, because, as justice is a circumspect, cautious, scrutinizing, balancing principle, full of doubt, even of itself, and fearful of doing wrong, even to the greatest wrong doers, in the nature of things its movements must be slow in comparison with the headlong rapidity with which avarice, ambition and revenge pounce down upon the devoted prey of those violent and destructive passions.—Burke.

The great duty of life is not to give pain; and the most acute reasoner cannot find an excuse for one who voluntarily wounds the heart of a fellow creature. Even for their own sakes, people should show kindness and regard to their dependents. They are often better served in trifles, in proportion as

they are rather feared than loved; but how small is this gain compared with the loss sustained in all of the weightier affairs of life! Then the faithful servant shows himself at once a friend, while one who serves from fear shows himself an enemy.—Frederika Bremer.

We found, or thought we found, an inconvenience in having every man the judge of his own cause. Therefore juddges were set up, at first, with discretionary powers. But it was soon found a miserable slavery to have our lives and properties precarious, and hanging upon the arbitrary determination of any one man, or set of men. We fled to laws as a remedy for this evil. By these we persuaded ourselves we might know with some certainty upon what ground we stood. But lo! Differences arose upon the sense of interpretation of these laws. Thus we are brought back to our old incertitude.—Burke.

STRIKES NOW IN FORCE.

- Farrer Traft Contract Shops, Buffalo, N. Y. (Strike on.)
- Illinois Central R. R. (Federated Trades strike on.)
- Harriman Lines. (Federated Trades strike on.)
- Pere Marquette R. R., Grand Rapids and Saginaw, Mich. (System Federation strike.)
- Contract shops, Mobile, Ala. (Metal Trades strike.)
- Atlantic Basin Iron Works (Shields & Moran, New York). (Strike on.)
- Hibbon & Co., contract shop, South Chicago, Ill. (Unfair.)
- Milwaukee Boiler Co., Milwaukee, Wis. (Strike on.)
- Stockton, Calif. (Metal Trades strike.)
- Warren City Boiler & Tank Co., Warren, Ohio. (Strike on.)
- Standard Boiler & Plate Iron Co., Niles, Ohio. (Strike on.)
- Reeves Bros., Alliance, Ohio. (Strike on.)
- Hammond Iron Works, Warren, Pa. (Strike on.)
- The Petroleum Iron Works, Sharon, Pa. (Strike on.)
- The Treadwell Construction Co., Midland, Pa. (Strike on.)
- Riter-Conley Construction Co., Pittsburgh, Pa. (Strike on.)
- Des Moines Bridge & Iron Works, Des Moines, Iowa. (Erecting work at Bremerton, Wash.)

Mechanical Department.

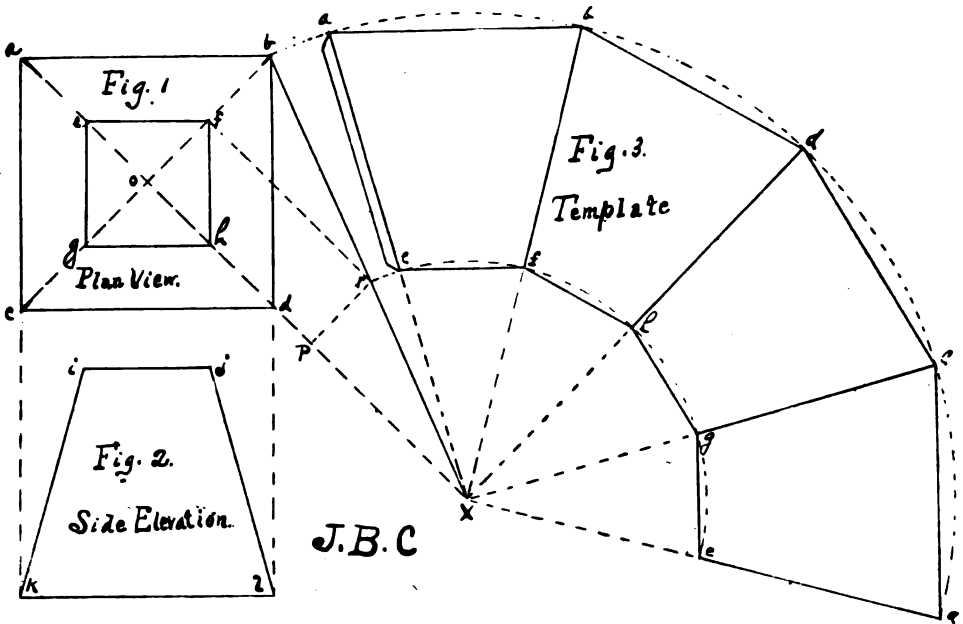

TO DEVELOP THE FRUSTRUM OF A SQUARE PYRAMID.

Figure 1 shows the plain view, a-b-d-c-a shows size and shape of bottom or larger end, and e-f-h-g-e that of top end. Fig. 2 shows the side elevation, i-j-l-k-i shows height and shape of one side.

To lay out template proceed as follows: Strike lines from b to c and a to d, continue the latter on indefinitely; next take the vertical height of pyramid as shown by Fig. 2, transfer this to line a-d Fig 1, from o to p; then take distance from o to f and transfer to line p-l which is parallel with o-f; next take distance from o to p and transfer it to line f-l, where lines p-l and f-l cross each

other is a center through which to strike line b-i-x. The lines p-o-b-l-p shows one-half the size and shape of the frustrum of a pyramid. Where the lines o-p and f-l cross each other at x is the apex of the pyramid. Next take trams and with one point at x and the other at i, strike the small circle e-f-h-g-e. Next extend trams from x to b and strike the larger circular line. Next take distance from a to b, Fig. 1, and transfer to a-b Fig. 3; from b strike line to x, continue to make these sides and strike lines to x, until all four sides are taken, then strike lines from e to f-h-g-e. If rivets are to be used ad for lap at a-e. Bend template at a-e, b-f, d-h, c-g.

J.B.C

International Officers' Reports.

REPORT OF FIFTH VICE-PRESIDENT ATKINSON.

Helena, Mont., April 14, 1915.

I left headquarters on January 6 for Seattle, Wash., to assist in bringing about a consolidation of Locals 104 and 489, and I am pleased to report that I was successful in getting the two locals to consolidate, as I am satisfied that much better results can be obtained both for the boiler makers and ship builders by all being in the one local. After the consolidation was brought about, the members decided to put a business agent in the field to look after their interest, as a great deal of work that right-

ly belonged to the boiler makers and ship builders was being done by other crafts. I am glad to report that Brother Dan McKillop was elected business agent and I am satisfied that Brother McKillop will make a good man on the job, if the members will only give him a little assistance. I am very sorry to report that work continues to keep very slack all along the coast, and a great many of our members are out of employment, and those that are working are working so short time that they are barely making enough to meet expenses. On January 19 I went to Olympia, Wash., to attend the State Federation Convention, also to assist

Brother Frank De Pender of Lodge No. 242, Spokane, Wash., in trying to have the boiler inspecting passed in the state of Washington, but I am very sorry to report that we were not successful in having our bill enacted into a law. Brother De Pender stayed in Olympia nearly all of the session of the legislature and did everything he possibly could to have our bill passed. I made several trips to Olympia and gave him all the assistance I possibly could, but it is the same old story, the big interest had too much of a pull. They had control of the majority of the representatives and senators, and whenever a bill was introduced that did not meet with their approval, all they had to do was to pass the word along the line and it was a cinch that the bill would not get very far. There was not a law on the statute books that was of any benefit to the working people but the big interest tried to have it repealed or amended in such a way as to kill all the benefits derived from such a law; they even tried to do away with the state labor commissioner's office, simply because Mr. Olson insists that the laws of the state be lived up to. If all labor commissioners were as honest and conscientious as Mr. Olson in seeing that the laws of the state were enforced, I am satisfied that there would not be as many accidents in the different states as there are at the present time.

I visited Lodges 247 and 568 in Tacoma, Wash., and found that the members of those two locals were working very short time, but are in hopes that business will pick up in the very near future. Business in Victoria and Vancouver, B. C., is also slack. I am sorry to report that I just received a letter from Brother Joe Reed in Vancouver informing me that he had been very sick, but was improving a little at the time he was writing the letter.

The Des Moines Bridge and Iron Co. has the contract to erect nine fifty-five-thousand-barrel oil tanks for the government; two of them are being erected at Bremerton, Wash., and two at Vallejo, and the other two at San Diego, Calif. I understand that the other three are to be erected on the east coast. This firm is very unfair to the members of our organization. Brother McKillop and myself made several trips to Bremerton, Wash., for the purpose of trying to get this firm to employ our men, but so far we have not been successful in getting very many of our men to work, but I am in hopes that Brother McKillop will be successful in getting the job straightened up.

The Seattle Dry Dock and Construction Co. has contracts to build three submarines for the government. This company is also a very unfair company to our members, and I am in hopes that the metal trades department will get busy and try to get the government to investigate the kind of work this company is doing. Also to investigate the class of mechanics they

employ, also the scale of wages they are paying.

I am inclosing some newspaper clippings to President Franklin that I cut out of newspapers in reference to Submarine F-4, which sank in Honolulu Harbor on March 25 and caused the death of Lieutenant Alfred L. Ede and twenty other members of the crew. This submarine was built by the Seattle Dry Dock and Construction Co. about a year ago and from all reports it has always leaked and never was seaworthy. This same company built two submarines about two years ago for the Chilean government, which they never accepted on account of the poor workmanship done on these boats. After these two boats were completed and tested, they cut out over seven thousand rivets and still the Chilean government would not accept them.

When the war broke out in Europe this company succeeded in selling these two boats to the English government and they were taken to Vancouver, B. C., and I understand one of them has been on the dry dock all of the time since it has been there, on account of its leaky condition, and the other one they are afraid to submerge for fear it will meet the same fate that F-4 did. There is a good deal of talk of the Canadian government demanding an investigation to find out who it is that is responsible for having the government buy such submarines. I believe it is about time our government was doing a little investigating and finding out what kind of work this company is doing.

I received a letter from Brother Bowser, business agent of San Francisco, requesting me to come to San Francisco as soon as possible; about the time I was ready to start for San Francisco, I received a letter from Vice-President Hinzman requesting me to go to Great Falls, Mont., also several other points in the Northwest. I left Seattle on April 3rd for Spokane, stopping over there on Sunday, leaving Monday morning for Thompson Falls, Montana, to investigate some work that was being done there. On my arrival in Thompson Falls I found that they were erecting a very big power plant. I also found that the structural iron workers were working on a pipe line, which is about finished and we all know according to the agreement we have with the structural iron workers that this class of work belongs to our members, and if the iron workers are going to continue to do our work I can't see any use in having an agreement when it is being violated. I have always understood that an agreement entered into and signed up by both parties was binding but it is different with the agreement we have with the iron workers. Another thing that I have found when a job of this kind is coming up, a great many of our members never notifies anyone about it and never pays any attention to it until the job is about finished and then they send in a complaint about someone doing our work. Just as soon as a job of this

kind shows up in the shop our members should get busy and find out where the job is going up and who has the contract, also find out who is going to do the erecting. I hope in the future that our members will take a little more interest in this kind of work and assist in getting this class of work for our members. I am very pleased to know that conditions are looking so favorable for our members in Oklahoma and I am in hopes that it will only be a short time until all our members will be back working, and all those unfair firms will be forced out of the oil fields. I also hope that the investigation of the Illinois Central and Harriman Lines strikes now being investigated in Chicago will result in bringing about a settlement of those strikes. While in Tacoma I had the pleasure of meeting Brother John Callahan, business agent of the Milwaukee and I can assure the members working for that system that Brother Callahan is a hustler and is sure to get results if our members on the Milwaukee will only give him a little assistance. This finishes my report for this time, which I hope will be satisfactory.

I will close with best wishes and kindest regards to all our members, I am

Yours fraternally,

WM. ATKINSON.

REPORT OF SIXTH INTERNATIONAL VICE-PRESIDENT DOWD.

New York, April 17, 1915.

To the Officers and Members of the Brotherhood:

The following is my report from Nov. 1 to April 15th.

November 1 to 11th.—In port of New York visiting the various shops in District No. 2. Also tank jobs being erected in this district, visited P. I. W. job, Kings County Oil Works, where our members were on strike. Had a conference with Brother McCarthy B. A., and committee of strikers regarding this situation. We also had conferences with Mr. Kultz, eastern superintendent of P. I. W. Co. He insisted we declare the strike off and have men return to work. This proposition District No. 2 would not consider as the members who were employed by this company have made numerous complaints in regard to the amount of work they were compelled to do in eight hours.

November 12th.—Brother Daly, Secretary of District No. 2, Brother McCarthy and myself had a conference with Mr. Kultz but it was impossible to reach any settlement of strike with the P. I. W. Co. After conference I went to Philadelphia, Pa., met President Franklin and got his advice on several matters pertaining to District No. 2. Also informed him of structural iron workers doing our work at the Equitable Life building. He took this matter up with President McClory who said he would wire his New York representative to remove their members. While at Philadelphia I had the pleasure of meeting our delegates to the A. F. of L. conventions, Brothers McGowan, Mc-

Guire Graham and Boyle, president of Lodge No. 341.

November 13th.—Returned to New York and in the evening left for Boston, Mass., arriving there on November 14th. Met Brother Wells and Brother Donohue, president and secretary of District No. 34.

November 15th.—Attended meeting of Boston and Maine R. R. Federation, delegates discussed at length proposition of getting an agreement with the above named railroad and they turned the whole proposition over to the International officers who were in attendance to open up negotiations with the B. & M. officials. Vice-President Boland of the blacksmiths, Vice-President Jennings of the machinists, the late vice-president of the carmen, Brother Gallagher, and myself, assured the federation that we would do our utmost in securing agreement.

November 16th to 30th.—At Boston with the above named vice-president. We instructed Brother Faunsworth, president of the B. & M. Federation, to write Mr. Bartlett, general superintendent of motor power, for a conference and while waiting for conference I visited several of the contract shops in Boston and vicinity in company with Brother Daniel Generson who is representing Lodge No. 585 as their B. A., and who is endeavoring to organize every contract shop in the city of Boston. We also visited the Bartlett and Haywood job at Lynn, Mass., where this company was going to erect a large gas holder. We also visited Hammond Iron Co. job at Cambridge, Mass., and job of Bartlett and Haywood at Salem, Mass. Also attended a regular meeting of Lodge No. 250 whose members are all employed in the New Haven R. R. and are only working eight hours a day and three days a week. I also made a trip to Lowell, Mass., November 23, and attended a meeting of Lodge No. 371 and informed the members that we were waiting for word from Mr. Bartlett as to what date we could meet him. November 24th I returned to Boston, visited the Readville shops and Roxbury shops and talked to the members of Lodges' No. 281 and 250. I was requested to make a trip to Hyannis, Mass., where machinists were supposed to be doing boiler maker's work. I also visited the Cambridge engine house on the B. & M. R. R. The vice-presidents of the organizations affiliated with the B. & M. federation and the president, Brother Faunsworth and myself, had several conferences during this time regarding the B. & M. agreement, and on November 30th, Brother Faunsworth informed us that Mr. Bartlett, superintendent of the B. & M., had agreed to meet Vice-President Jennings and myself to talk over the proposition of an agreement and after a conference between the vice-presidents they decided that Brother Jennings and myself meet Mr. Bartlett and learn from him, if possible, his attitude in regard to us negotiating with him for a federated agreement.

December 1 to 31st.—On December 2nd Vice-President Jennings and myself had a conference with Mr. Bartlett and after talk-

ing over agreement proposition at some length we finally got him to agree to meet the International officers of the organization affiliated with the system federation, and he further agreed to write me in a few days setting the date for conference. I also attended a regular meeting of Lodge No. 515 whose members are employed on the B. & M. R. R. and informed them of our meeting with Mr. Bartlett and inasmuch as there were some changes to be made in the proposed agreement we called the meeting of the Advisory Board of the B. & M. Federation after discussing the changes to be made. They then gave the international officers full power to sign up the agreement.

December 9th.—Committee and myself had conference with Mr. Bartlett and Mr. Wiggin and after going through the agreement with them for hours there were some articles that we could not agree upon and that Mr. Bartlett said he would have to confer with Mr. Hustus, president, before he would agree to same.

December 11th.—Attended a Federation meeting of the N. Y., N. H. & H. R. R. shop men and advised the delegates on several matters.

December 12th.—Left Boston for Greenfield, Mass., and attended an open meeting of Lodge No. 517 and talked to the members of the welfare of the organization and some of the members who had been suspended assured me that they would get reinstated in Lodge No. 517 again.

December 13th.—Left Greenfield for Boston and arriving in Boston I learned that the New Haven R. R. closed down their shops from Boston to New York until January 4th, and this certainly was a hard blow to our members and in fact all other shop men as they had been on short time for months. Brother Generson, B. A., of Lodge No. 585, and myself, visited the contract shops in East Boston. We also made a trip to Taunton, Mass., where the R. D. Wood Co. were erecting a gas tank. We arranged with some of these men to become members of Lodge No. 585. We also visited the New Haven shop and talked to men who promised they were going to become members of Lodge No. 250. They promised me they would go to Boston and attend the next meeting of Lodge No. 250. These men were not included in the closedown of the shops, as they do hot work.

December 17th.—Left Boston for New Haven, Conn., and attended a regular meeting of Lodge No. 61, as instructed by President Franklin. I informed the members of our negotiations with the B. & M. for a federated agreement.

December 18th.—Left New Haven for Boston and on arriving received word that Mr. Bartlett would meet our committee on December 21st.

December 19th. — Had conference at Quincy House with International officers and President Faunsworth.

December 20th.—Attended regular meeting of Lodge No. 585 and the members were

well pleased with the report of their B. A., Brother Generson.

December 21st.—Had conference with the officials of the B. & M. R. R.; opened up negotiations which continued until December 24th when we signed the first federated agreement on the B. & M. R. R. system.

December 26th.—Had conference with Brother Le Flam, president of Lodge No. 245, and Brother Wells, president of District No. 34, and advised them on several grievances that existed at the Concord shops.

December 27th.—Vice-President Jennings of the machinists and myself mapped out a trip to cover every point on the B. & M. R. R. and hold joint meeting and give the rank and file the full particulars and explain all matters pertaining to the new agreement, and decided to hold our first meeting at Lowell, Mass., January 6, 1915.

December 28th.—Went to Providence, R. I., and visited some of the shops there and talked to the men in regard to reorganizing Lodge No. 172, but I found there was very little work going on at that time and the men were not inclined to reorganize.

Dec. 29th.—Left Boston for Hyannis, Mass., and investigated case of machinist doing boiler maker's work as requested by Lodge No. 250. On arriving I learned that the man worked nights and I talked to his foreman, Mr. Shaw, and he said I would have to see Mr. Hallett, as he was the man who was doing the work. I had an interview with Mr. Hallett and he said he was classed as a general utility man and received 20½c an hour and that he did everything around, and inasmuch as there was very little boiler work and this being an isolated point he only did emergency work and I informed him that in the future he should not do any boiler maker's work. I also informed the foreman to this effect.

Dec. 30th.—Left Hyannis, Mass., for Boston.

Dec. 31st.—I answered considerable correspondence.

Jan. 1st to 31st, Jan. 1-2.—At Boston visited some of the contract shops.

Jan. 3rd.—Left Boston for Sharon, Pa., by orders of President Franklin to meet Mr. Todd, president of the P. I. W. Co.

Jan. 4th.—Arrived at Sharon, Pa., and met Mr. Todd regarding the action taken by his company and the six other tank building companies in declaring open shop on all their work in the Oklahoma Oil Fields, and after a two hours' conference Mr. Todd said that the seven tank building companies had decided to erect all their work in all sections of the country under open shop conditions. He also informed me that Mr. Geo. Reeves of the Reeves Bros. Co. was the secretary and chairman of their association and suggested that I write him requesting a conference to discuss this proposition. Having to attend the joint meeting of all the crafts on the B. & M. at Lowell, Mass., on January 6th, I sent full particulars of my conference with Mr. Todd to President Franklin.

Jan. 5th.—Left Sharon, Pa., for Boston, Mass., arriving there on January 6th. Met Vice-President Boland of the Blacksmiths; Vice-President Jennings of the Machinists; President Faunsworth of the B. & M. Federation. We then left Boston for Lowell, Mass., and held federated meetings. We gave the members full particulars of agreement signed December 24th and we also held similar meetings at Lyndonville, Vt., Concord, N. H., Greenfield, Mass., Mechanicsville, N. Y., Keene, N. H. and Boston, Mass., and I am glad to report that the members of the various crafts affiliated with the federation at the above mentioned points approved of the agreement and were well pleased with the success we made.

Jan. 16th.—Had conference with President Wells of District No. 34 and advised him on some grievances he was to take up with Mr. Bartlett, superintendent of Motor Power on the B. & M.

Jan. 18th.—Received wire from President Franklin to meet him in New York, arriving in New York on the 19th. While in New York in company with President Franklin we discussed the situation and conditions of our organization in District No. 2, Port of New York with Brother Kenneally, president of District No. 2, Brother McCarthy, B. A., Brother Daly, secretary and treasurer and arranged with the above committee to call a special meeting of District No. 2 to be held January 24th. We attended a regular meeting of Lodge No. 163 at Hoboken, N. J., and President Franklin and myself addressed the meeting.

Jan. 24th.—We attended special meeting of District No. 2 and President Franklin went over the situation of the Port of New York with the delegates and advised them on several matters and upon learning of the vast amount of money owed Brother McCarthy, B. A. of District No. 2 and upon request of the district for an organizer to be left in New York to help organize the unorganized men of our craft. President Franklin arranged to have me return to this city as soon as I could finish up my work in the New England states and this was satisfactory to District No. 2. After meeting I left New York for Boston, Mass., arriving there on January 25th. Had conference with committee of B. & M. Federation and arranged for a conference with Mr. Bartlett for January 28th. Also visited Bartlett and Haywood job at Lynn, Mass., and also visited some of the shops in company with Brother Generson, B. A. of Lodge No. 585 who has been successful in organizing several of the unorganized shops. Attended conference with Mr. Bartlett as arranged and had a clear understanding in regard to two articles in the agreement as to the interpretation of same. Also attended a meeting of District No. 34, January 30, and delegates elected Brother Wells, president; Brother Donohue, secretary and treasurer and Brother Kennedy of Mechanicsville, N. Y., vice-president. I advised the delegates on several matters pertaining to

working conditions on other railroads and when all business was transacted they adjourned to meet on February 20th.

February 1 to 28th. February 1.—Left Boston, Mass., for Portsmouth, N. H., in regard to organizing the men in the navy yard in that city. I took this matter up with Brother John Quinn, president of Lodge No. 467. He advised me that there were very few men working at that time and thought that later on there might be an opportunity to do some organizing. From there I went to Bath, Me., and located some of the former members of Lodge No. 168. I talked to them in regard to reorganizing this lodge and they informed me that they done very little work all winter. The ship yards being practically closed down and several of them were out of work at this time, but suggested that I come back in a few months and if conditions were better they would be willing to organize. From there I went to Portland, Me., visited the Portland Iron Co., talked with some of the men in regard to organizing and am sorry to say I was confronted with the same situation as I was at Bath, Me.; men out of work very nearly all winter.

February 6th.—Left Portland, Me., for Boston, Mass., visited some of the contract shops in the vicinity of Boston with B. A. of Lodge No. 585. Also went to Providence, R. I., and located big tank job being erected by the P. I. W. Co. at the Standard Oil Company's plant at Fort Hill. Foreman of the job, Mr. Hubble, ex-member of our organization. There were about ten or twelve men on this job and I had a personal talk with all of them and they all agreed to strike this job that night, which they did.

February 10th.—Left Boston for New York.

February 11th.—Attended conference with representatives of metal trades, department of the A. F. of L. and the United States Brewers Association in regarding to giving contracts for brewery supplies to shops that employ union men. The brewers committee agreed to do this as much as they possibly could and would give the preference to companies hiring union men.

February 12th-17th. Visiting shops in District No. 2, port of New York. Also attended meeting of Lodge No. 163 and No. 16, and talked to the members in regard to getting their assistance in reorganizing the men in this district and they promised to give every assistance they possibly can in helping to build up our organization. I also had conferences with Mr. Ackley, New York manager for the Edgemore Boiler Co., regarding four boilers his company had to erect in the New York steam heating power house at 59th street, but could not get him to place members of our organization on this job and the work was being erected by non-union men. I took this matter up with the New York Steam Heating Co., and they said that I would have to do business with the Edgemore people as they had nothing to do with the erection of the boilers.

February 18th.—Went to New Haven and attended a regular meeting of Lodge No. 61, by request of members of this lodge and

advised the members on several matters pertaining to our Brotherhood.

February 19th.—Left New Haven, Conn., for New York. On arriving went to 59th street power house job and called four of our members who were working for another company out on strike. We were also successful in getting men who were working for the Edgemore Co. to strike.

February 20th.—Had conference with Mr. Atley of the Edgemore Co., and after discussing the situation of the 59th street job and this work being tied up, Mr. Atley insisted he had nothing to do with the erection of the work.

February 21st.—Attended a regular meeting of district No. 2 and reported the situation of the 59th street power house job and pickets were placed to watch this job. Visited the office of District No. 2, made a trip to Shadyside, N. J., and Edgewater, N. J., to try and locate some tank work. Located four tanks that were to be erected by the Kellogg Oil Co. Brother Daly, secretary of District No. 2, and myself, attended a regular meeting of Lodge No. 176 of Elizabethport, N. J., which was a fine meeting. I also attended a regular meeting of Lodge No. 45 and they had a very fine meeting. Members of both these lodges assured me that they would give me every assistance possible in trying to organize the unorganized men of our craft. Also visited several of the shops and talked to several ex-members who promised me that when conditions were better they would be reinstated in their respective lodge as they are now only working very short time.

March 1-7th.—Attended a regular meeting of Lodge No. 21 and financial secretary was instructed to send reports to the I. S. T. as soon as possible as this lodge had not reported for some months. Visited the office of District No. 2 daily. Also visited several shops in the Port of New York and made several visits to Weehawken, N. J., where the Koehler Iron Co. tank job was being carried on. Had a talk with the foreman, Mr. Williams, and arranged with him to put all union men on this job and after the proposition was all settled an ex-member of Lodge No. 21, named James Campbell, who was assistant foreman, had a long talk with Mr. Williams; then I was informed by Williams that he was going to erect his job under open shop conditions and this he did do with Campbell as his foreman. And as the tanks were being erected on the Erie R. R. property this company assisted the Koehler Co. all they could to erect this work. Also visited some of the buildings where some tank work was being erected. Also attended a meeting of Lodge No. 163, Hoboken, N. J., and attended a regular meeting of District No. 2. After this meeting I left for Boston, Mass., arriving in Boston March 8th, as ordered by President Franklin, and attended a meeting of District No. 34 of the B. & M. R. R. committee. Was sent to Mr. Bartlett and requested him to meet myself and a committee to take up some grievances. He agreed to meet the

committee but would not consent to meet me at this time until they had made an effort to adjust the grievances with him first. After district meeting I went to Lowell, Mass., and addressed a meeting of Lodge No. 371. I talked to the members on the good and welfare of our organization and they surely had a fine meeting. After the meeting I returned to Boston and on the 9th left Boston for New York.

March 10th to April 15th.—During this time I had been representing District No. 2 because of the deplorable state of our organization in the Port of New York. Owing to the thousands of men who were out of employment practically all winter, it became necessary for District No. 2 to suspend Brother McCarthy, their B. A., temporarily, due to the above conditions and I have been visiting the shops and ship yards and meeting and talking to the members who have been suspended prevailing on them to become reinstated and I am satisfied that when work resumes and conditions are better we will be able to build up the lodge in District No. 2 and strengthen up our organization in the Port of New York. I have had conferences with Mr. Henry C. Hunter, representative of the metal trade association, and also representative of the boiler manufacturers of the Port of New York, in regard to bringing about an agreement between the above named associations and District No. 2. This proposition has been approved by the district, and Mr. Hunter advised me that he will submit this proposition of an agreement to his executive board and we are now waiting to hear from Mr. Hunter. I have also attended meetings of Lodges No. 16, 21, 45, 163 and 176. Visited the office of District No. 2 daily. Visited new buildings being erected, locating such work as belongs to our craft and placed the members of our organizations on same. I also made a trip to Albany, New York, by orders of Vice-President Hinzman, and protested to Governor Whitman, with other representatives of labor, against him signing an amendment to the Workmen's Compensation Law, and I am sorry to say that the governor a few days afterward signed the amendment. I also tied up three tank jobs being erected by the P. I. W. Co. in this district; one at West New York, N. J.; one at Hunter's Point, L. I., the other one at Warner, N. J., and we intend to tie up every job that is being done by the seven tank building companies in this district. The Reeves Brothers, of Alliance, Ohio, have started a big tank job with non-union men at Flatbush, Brooklyn. This job, from the information we received, will last for a period of six months. I am working at this time on this proposition and expect to make a clean sweep on this job within a short time, and I want to assure the brother members who are on strike in the Oklahoma oil fields that the members in the Port of New York are doing everything within their power and assisting me in every way to tie up the work that is being done by the open shop companies in this district. And inasmuch as

District No. 2 covers a radius of 25 miles from the New York City Hall, it keeps us on the alert at all times. And I am glad to say at this time that I have nearly all our members who follow up the tank building industry working for fair companies to our organization and we all hope that conditions will be better in the near future in the marine shops, as they have been practically closed all winter with the exception of a few men at work and the same conditions prevail at this time in the marine industry.

This concludes my report to April 15th and trust it will meet with the approval of all, and with best wishes and kindest regards to one and all, I remain,

Yours fraternally,

JOHN J. DOWD,

Sixth International Vice-President.

REPORT OF SEVENTH I. V. P. MAHER.

At the conclusion of my last report was in Newark, Ohio, organizing. While there I received orders from headquarters to go to Pittsburgh, Pa., and meet management of the firm of Riter and Connelly, which I did to try and settle controversy of our men at Roast, La., but after meeting general manager I was unable to reach any settlement of controversy. From Pittsburgh I went to Conneaut, Ohio, to attend mass meeting which was very well attended. Brother Weyand also attended this meeting as did Brother Knight of the Carmen, Brother Roy Horn of Blacksmiths and Brother Malloy of Machinists and as chances of forming a System Federation were very good we all agreed to return for another meeting. From Conneaut I returned to Pittsburgh to again meet the firm of Riter & Connelly which I did with no results. From Pittsburgh I went home to spend Christmas. From Portsmouth I went to Chicago where I met Brother Horn of Blacksmiths and Brother Malloy of Machinists, where we arranged several meetings of the men at Stoney Island with the intent of forming a System Federation at that point and were successful in getting committees appointed from all crafts to take the matter up.

While in Chicago, I attended a meeting of Lodge No. 39 and a very good meeting it was, also after the meeting refreshments were served and some very good talks made on the good of the order. Brother Cundiff attended meeting also and made a very good talk as did Brother Coghlan, B. A. L. No. 39. I also attended meeting of Lodge No. 1 and it was a very good meeting also. While in Chicago I received orders to go to Newark, Ohio, to take up grievance, Local 99, which I did, grievance settled.

From Newark, Ohio, I went to Cumberland, Md., to meet schedule committee, Western Maryland R. R. and assisted them in drawing up new schedule. From Cumberland, Md., I went to Conneaut, Ohio, to form System Federation where I again met Brother Horn and Malloy and we were suc-

cessful in forming System Federation at Conneaut and also successful in organizing Blacksmiths at that point.

From Conneaut, Ohio, I went to Huntington, Ind., on orders from headquarters to try and re-organize lapsed lodge at that point. At Huntington, Ind., I received orders to go to Chicago and take up grievance between Lodge No. 1 and Lodge No. 39. While in Chicago received a wire to go to Chicago Heights to take up grievance with Central Locomotive Works who had abrogated agreements of all crafts. Brother Tegtmeier of Blacksmiths and Brother Greenier of Machinists were assigned to this controversy also, after meeting management we were unable to adjust grievance and requested the Department of Labor to send commissioner of conciliation to try and adjust controversy. Mr. A. T. Faulkner of Cleveland, arrived and after several conferences we were able to settle controversy temporarily. Also, while in Chicago I attended several meetings of Lodge No. 356, Hammond, Ind., and at last meeting we had ten new applications for membership. From Chicago I went to Milwaukee, Wis., to investigate strike at the Milwaukee Boiler Works, and succeeded in getting two conferences with management, which I hope will result in settlement later on.

While in Milwaukee I attended meeting of Lodge No. 302, and a very good meeting it was, also. I also had the pleasure of meeting Brother DuBrocq and of having dinner with him and his family. From Milwaukee I returned to Chicago, to again take up grievance of Lodges No. 1 and 39, but as grievance was a very complicated one was unable to settle it. From Chicago I went to Bellefontaine, Ohio, where I reorganized lapsed Lodge No. 243 with 12 members. While at Bellefontaine, I made several trips to Springfield, Ohio, and Columbus, Ohio, where I expect to get good results from my trips, later on. From Bellefontaine I went to Portsmouth, Ohio, and attended meeting of Lodge No. 402 to take up some important matters. From Portsmouth I went to Washington, Ind., to take up grievance on B. & O. R. R. and attended a large mass meeting last night. Will report on this grievance in my next report.

This will conclude my report, and with best wishes and regards to all, I remain,

Yours fraternally,

M. A. MAHER,

Seventh I. V. P.

REPORT OF EIGHTH INTERNATIONAL VICE-PRESIDENT RYAN.

Since the conclusion of my last report in April Journal, conditions in the strike zone in the Oklahoma oil fields have progressed as favorably as can be expected, considering the conditions of the labor market throughout the country at this time.

Numerous newspapers have published articles to the effect that the strike has been settled and that labor troubles were at an

end. Brothers no settlement has been reached whatever. No conference has been granted to date, the members of Osage Lodge No. 592 have been on strike nearly three months now against the Open Shop inaugurated by the seven Eastern firms, namely, Petroleum Iron Works, Standard Boiler Plate Iron Co., Warren City Tank & Boiler Co., Reeves Bros., Hammond Iron Works, Treadwell Construction Co., and the Rites-Conley Co. Needless to say hundreds of strikebreakers have been employed from all over the country to force the Open Shop policy into effect in the old fields of Oklahoma, Louisiana and Texas. These same strikebreakers are now being paid for the actual amount of work performed, thereby making a graduated wage conditions, ranging from \$2.25 to the standard rate of \$4.50, \$4.75 and \$5.00.

While the unfair firms are endeavoring to break our organization and Open Shop all of their work, we are enjoying the union conditions we have built in recent years in the employ of five new fair firms, namely, the Kennicott Co., Wm. Garver Co., United Iron Works, Kansas City Construction Co., and the Kaw Boiler Works Co. The aforesaid firms are employing our members exclusively and are working union conditions, recognizing the organization and paying union wages at \$4.50, \$4.75 and \$5.00 per day on the best work basis. I am pleased to report that additional contracts are being let by the producers to the said fair firms, this being an unusual condition in a strike against the Open Shop, consequently it places a new light on our strike situation.

Strike Pay Roll.—In order that the rank and file may know that we had six hundred members in our first pay week strike rolls. In the past few weeks we have dropped to one hundred and seventy-five; we have received in regular strike benefits about twenty-seven thousand dollars (\$27,000.00) to date.

Donations from subordinate lodges in response to circular letters of appeal issued by Lodge No. 592 have brought returns to the extent of two hundred and fifty dollars and twenty-seven cents (\$250.27). I am attaching an itemized statement handed me by the recording secretary. We are publishing same so the rank and file may know the actual amount received from the appeal.

Of the 600 members who responded to the strike order three months ago I dare say 400 are now employed by fair firms. Concerning desertions from our ranks, foremen and all, 30 men will fully cover our losses out of a total of 600. Sorrow and sadness have also entered our midst and we mourn the loss of four more of our respected members since my last report. Brother John Corrigan (helper), Reg. No. 99176, of Lodge No. 542, was shot and instantly killed at Drumright, Okla. His assailant is out on \$5,000.00 bail. Brother Chas. P. Callopy, Reg. No. 42730 (boiler maker) passed away with pneumonia after a brief period. Brother Frank Hanivan (boiler maker), Reg. No. 77483, and Brother Alex. MacAvoy, Reg. No.

31223, succumbed to pneumonia after brief illness. We also have Brother Fred J. Altazin, Reg. No. 89092 (boiler maker), lying in Cushing hospital, the victim of a shooting affair, and while dangerously wounded he is now on the road to recovery for which we are all thankful. His assailant also being a brother member. We also have a brother, Stell Cole, recuperating at his home at Childress, Tex., the victim of a hold-up at Oilton, Okla., recently. Truly, our trials have been plentiful at a time when our united strength is being put to test. One for all and all for one has been our motto and we are meeting misfortunes trial's face to face as they appear. With summer near at hand we are fighting harder than ever and our prospects could not be brighter for victory. By way of demonstrating the spirit which exists in Lodge No. 592 a twenty weeks' assessment of one dollar per week for twenty weeks is now in effect as we believe in the adage of help comes to those who first helped themselves. We are endeavoring to keep in close touch with our brothers on strike at Houston and Port Arthur, Tex., and every way to have united action.

A spirited election has just been held in Lodge No. 592 for the office of corresponding and financial secretary, also for trustee, five candidates competing for secretaryship. Result of votes taken show Brother Richard Leahy victor with 167 votes, Brother C. E. Houghton with 125 votes, Brother Wm. J. Koller third with 85 votes, Brother I. L. Timmons fourth with 8 votes and Brother Mahan fifth with five votes, a total of 390 votes cast. Brother Edw. Sheehan was elected trustee over Brothers W. H. Clark and Frank Hawks.

Relative to traveling brothers, Lodge No. 592 has placed into effect a rule to prevent traveling brothers from depositing clearance cards and going to work. This action became imperative owing to the number of members who began to arrive in the field as soon as fair jobs started. Having about 200 members still on strike, this action has been taken to protect the brothers who have been fighting the strike during the past three months. We have also had delinquents and members who hold withdrawal cards for several years present themselves and desire to reinstate and deposit cards in order that they might go to work here on what fair jobs our striking members have preference upon. Should a traveling brother desire to pay dues to maintain his good standing, Lodge No. 592 will accept clearance cards, stamp his book and card him out, but he cannot go to work until such time as conditions become normal and our striking brothers become employed. Brothers, you can help win this strike by remaining out of the oil fields of Oklahoma, Louisiana and Texas until our difficulties are settled. Will you do it?

From March 10 to date, April 12, my time has been devoted in assisting Lodge No. 592 in our struggle against the open shop in the Oklahoma fields. I regret that my

correspondence has been neglected, but the district involved necessitates both time and personal attention. Situated 68 miles from our Tulsa headquarters, we must be on the job, so to speak, day and night. Will we win? Keep your eyes on Osage Lodge No. 592 and Oklahoma. My efforts in the sale of emblem buttons and charms have been somewhat curtailed, owing to the strike; however, we are still boosting our new slogan, "Buy and wear a button or a charm."

Trusting my report will prove interesting to the rank and file, I am

Yours fraternally,

JOS. P. RYAN,

Eighth International Vice-President.

LIST OF CONTRIBUTIONS FROM VARIOUS LODGES.

R. B. Allen, Local 26, Savannah, Ga. . . \$10.00
L. Fornoff, Local 605, Tooele, Utah. . . 5.00
Walter E. Dwyer, Local 32, K. C., Mo. . . 5.00
Cecil C. Roberts, Local 99, Newark, O. 2.00
J. A. Coghlan, Local 39, Chicago, Ill. . . 100.00

Wm. C. Frohlinger, Local 10, Indianapolis, Ind. 5.00
Frank C. Schwares, Local 144, Cedar Rapids, Ia. 5.00
John M. Slater, Local 485, Green Bay, Wis. 3.00
R. D. Wing, Local 136, Colorado Springs, Colo. 5.00
Wm. D. Warren, Local 423, Big Springs, Tex. 10.00
A. Anderson, Local 595, Avery, Ida. . . . 5.00
Dan'l B. McInnes, Local 585, East Boston, Mass. 10.00
M. S. Steinbeck, Local 238, Clifton Forge, Va. 5.00
Chas. F. Darling, Local 446, Alamoosa, Colo. 10.00
A. Fraser, Local 194, Vancouver, B. C. 10.00
E. T. Chester, Local 132, Galveston, Tex. 39.87
Walter Anderson, Local 205, San Francisco, Cal. 20.00
Total \$250.27

Correspondence.

MONTREAL, CANADA.

To the Officers and Members of all Subordinate Lodges Everywhere.

Dear Sirs and Brothers:

At this time I crave your attention to a matter which I am satisfied refers to the writer personally. It is the "Proposed Amendment to the Constitution," submitted by Lodge No. 126, Winnipeg, Man., and which appears in the columns of our official Journal, during the months of March and April.

Now, dear reader, this may be somewhat lengthy to read, but it will be and is to your benefit to know the facts. You will note on page 269 of the April issue of the Journal, under the heading of "Reasons Why We Should Have the Recall" (second paragraph) it reads: "According to our Constitution and the verdict handed down by the Executive Council at their annual meeting held in Kansas City, October, 1914, to Lodges No. 126, No. 451 and No. 529, an officer cannot be removed unless convicted of certain charges, inefficiency does not constitute a charge, etc.

Now, you all would like to know what your Executive Council, had before them at the last Council Meeting, in reference to this matter. The following is a copy of the original resolution, and below I will reply:

"Whereas the economic conditions of Canada necessitates the having of an energetic vice-president who has some ability as organizer, and who has the technical knowledge of the organization he represents, so as he will be able to advise and aid the various lodges that he may come in contact with; and

"Whereas Third Vice-President J. P. Merrigan, has been given a three years' trial,

and we have found him wanting in the necessary qualifications; Therefore be it resolved; that Perserverance Lodge No. 126, recommend that International President J. A. Franklin, immediately proceed to take a referendum vote for the recall of Third Vice-President J. P. Merrigan; and be it further resolved:

"That if this resolution be carried by a majority of the members thereof, that he immediately make arrangements for the election of a successor from amongst the brothers, recommended by the members in Canada."

The above resolution was unanimously adopted at the regular business meeting of Lodge No. 126, held in Winnipeg, August 16, 1914, and reaffirmed at the next regular business meeting held September 2nd. We have nothing against Brother Merrigan as far as honesty, morals, etc., are concerned, our only objection is that he has not the ability and cannot fill the office of a International Vice-President, and to keep him any longer is merely keeping up an unnecessary expense and hinders instead of aids any organizing work that might be done. It is common knowledge amongst boiler makers and helpers throughout this country, that as an organizer he is a failure. Speaking from our own personal experience of Brother Merrigan's inability in Winnipeg and vicinity, we will cite a few cases out of the many, that will suffice we think, for his recall, and the urgent necessity of placing a more energetic brother in his place. He has been three years on the job and it cannot be said that we were over hasty in reaching this decision. During that time he has never brought in a single application to the Winnipeg lodges, although he

has spent two or three months each year in this vicinity, what he has done during that time is a mystery to this lodge.

At the beginning of the trouble between the boiler makers and their helpers, he showed his ability as peacemaker by failing to appear before a meeting of the helpers (when asked to come and advise them and help to clear up the differences between them and the boiler makers) on the rather flimsy ground that the helpers were not in good standing to the Grand Lodge and he did not see why he should waste any time with them at all. The fact that the quarrel was disrupting the local lodge, and that it was the function of a grand lodge officer to try to the best of his ability to settle internal strife, seemed to bear no weight. The majority of the helpers are still outside of the fold, no question but what we will get them all in again, but a little advice given at the proper time, might have saved the time, money and energy that has and will be spent before that is accomplished.

His ability and results as an organizer in this district as far as Lodge No. 126 is concerned, has been nil. He tried to organize the G. T. P., some two years ago, and the lodges of this city were so disgusted with the results (some four or five applications) that they assessed themselves one-half day's pay per month for several months in order to help out the boys on the G. T. P. They elected Brother McGowan, as organizer and sent him out to see what he could do in the way of lining up the men up on the road. A more fertile field could not have been found as in the short space of two months he succeeded in practically organizing the entire system, with the results that the company has been forced to meet the men in committee, although all efforts so far has failed in the way of getting the company to sign a contract, the company evidently is trying to force a strike, the men are just as strenuously trying to avoid it, and Brother Merrigan is doing nothing seemingly but drawing his salary. A committee from Lodge No. 529, (G. T. P.) has repeatedly asked Brother Merrigan to come before their lodge and give them some advice as to what to do or how to act, he has not as yet done so, although he did appear at a joint meeting of boiler makers and machinists, almost everyone in the hall that night had something to say but Brother Merrigan, he never said a single word, notwithstanding that the results of the meeting might have been the calling of a strike.

The contract shops in this city are of the non-union variety. We have had union men working in them at various times and we are expecting Brother Merrigan to do something in regards to trying to get the closed shop, and we are willing and ready to give all the assistance within our power, we have brought the subject before him at various times, but nothing has been done. Our time has been taken up this last two

or three years with the troubles on the G. T. P. The strife between the helpers and boiler makers, and the various grievances that has cropped up along the C. P. R., from time to time. With the result that there is not a union man to our knowledge in any of the contract shops in the city at present time, which means that the work of organizing there has got to begun all over again.

What has been done in the way of organizing, settling disputes internal and external, has been done without the aid of Brother Merrigan although it has been many times solicited, and we are of the decided opinion that a change is necessary; as a boiler maker and a union man we have nothing against Brother Merrigan; as a Grand Officer we don't think that he reflects credit on the international, his very personality is against him, he cannot give advice, because he has not the necessary knowledge, he is more liable to widen a breach than close it. He came as a stranger amongst us, we have given him three years' trial, surely no man can ask for more and he has been found wanting. We want a change, we ask it from you the rank and file of the Brotherhood, hence this referendum."

Now, dear reader, you can read what I have to say in rebuttal. From the foregoing, one would be inclined to say to himself "is it not beastly exasperating to think that we have had such a dreadful man all these years in the capacity of vice-president of our organization." Lacking almost every qualification but that of being a boiler maker and a union man, I thank Heaven, that the latter qualifications were at least accorded your humble servant. Perhaps it was not intended, but was overlooked in the excitement. However, if the committee who drafted these resolutions were sincere in granting your humble servant the aforesaid qualifications, I am indebted to them very, very much indeed, and to the members who indorsed the report of the committee. For in my humble opinion—and I think you will agree with me, any person possessing such qualifications is not a dead one altogether. I am proud to be the former, because I was assigned to such work and made good. And also proud to be one of the latter, and never had to go outside of this berg to have any such honors bestowed upon me.

Now, to get at what you are all entitled to—my reply, and it is not going to be counted by myself to find out whether there will be three hundred or three thousand.

Last August, after having made a special visit over the Canadian Northern Railroad, from Winnipeg to Edmonton, and touching some points on the lines of the G. T. P., and C. P. R., I arrived back in Winnipeg, on the afternoon of September 2nd. That evening Lodge No. 126, held their regular meeting. I attended same. During the course of meeting while the recording secretary was reading the minutes of the

previous meeting, I heard my name mentioned. I didn't get the full contents of what had been read at the time, but did later, and later heard what the report of the committee was. The report was, the resolution which you have already read—that which appears above. The committee was appointed at the Sunday meeting August 16th, to draft up the resolution. The committee reported under the head of "Special Committees, and read the resolution. After it had been read the president, asked me if I had any reply to make? I told him that it was read off so continuous and so lengthy, that I was unable to grasp it all, and that I would naturally expect to be given some time to look over the charges or whatever they may be termed, so that I could answer them, and if the meeting would be kind enough to allow me to answer them I would do so with the time at my disposal, briefly for the time being. The privilege was granted, and I replied to it all.

Now, follow the resolution from the first word; "Whereas" to the word "Canada" second paragraph. The request could not be granted according to our Constitution, as this method was abolished at convention 1906. Article III, of the International Lodge Constitution, could have been studied. I will refrain from having anything to say regarding my qualifications, ability, technical knowledge, etc. "Leave George do it."

First. It reads: "That Perseverance Lodge No. 126, recommend that International President J. A. Franklin, immediately proceed to take a referendum vote for the recall of third vice-president J. P. Merrigan." Now, anybody that follows up the laws of our Brotherhood knows that President Franklin could not comply with the request. Again, the convention had hardly adjourned two months, and at the convention the following lodges from the Dominion, were represented: 126, 134, 191, 413 and 451. Why was all this not brought to the attention of the delegates at that time? The delegate from Lodge No. 126, placed himself before the delegates for the office of vice-president and was defeated. What better place could there be than at that convention to come out openly and inform the convention, that I was lacking in my qualifications, etc., to continue in the office of vice-president, for this brotherhood. No, nothing was said of this nature.

Second. "That if this resolution be carried by a majority of the members thereof, etc." The resolution could not be placed before the membership, and our constitution should have been consulted prior to the convention and after.

Third. "The above resolution was unanimously adopted at the regular business meeting of Lodge No. 126, held in Winnipeg, August 16, 1914, and reaffirmed at the next regular business meeting held September 2, 1914, etc." Now, I don't believe there was a regular summoned meeting to take up this matter on Sunday afternoon, August 16. I am satisfied that a few gossipers had

been discussing the outcome of the convention, after the return of the delegate from Lodge No. 126, and something that did not materialize at the convention, caused them some uneasiness until the regular meeting was held where they aired their sentiments. Then a committee was appointed to bring in a report. That report is the one you have before you. Now, it states that, it was (the resolution) adopted at the meeting of August 16th, and reaffirmed at the next meeting held September 2nd. Just think this over. The resolution was unanimously adopted before it was written (August 16th) and was written as it appears verbatim, before the lodge adopted any part of it. Now, what do you know about a piece of business of that nature? Before the lodge has anything to say in the matter the resolution is adopted? It was not adopted at the meeting of September 2nd. I was present, and know what was adopted. Why, when I got through making matters clear to those present, all of the foregoing resolution was stricken out, except the beginning, and then, if the members had been conversant with the idea at the time, that portion would not have been adopted. As it was (from what I saw at the meeting) I don't believe Lodge No. 126, properly speaking would in-dorse any part of the resolution.

Fourth. "It is common knowledge amongst boiler makers and helpers throughout this country, that as an organizer he is a failure." Now, I would like to know where this information was received? I know, and it was not from any of the lodges in the Dominion. The remainder is very nice, from the word "speaking" to "place." As far as bringing in applications to Lodge No. 126, is concerned, well, I must admit that the nature of my work does place me in a position very well to bring application to Lodge No. 126, or any other lodge. When the opportunity presents itself I do bring them before the lodges. If not, I mail them to the local secretaries. Bringing in application for membership can be accomplished, but getting the initiation fee and the application at the same time seems difficult, unless I happened to be in some town on pay day, where there was an applicant for membership, where there is no lodge, and if I had arranged to collect the fee and application I certainly would not overlook doing so. On the other hand, if I could not be in town on pay day, and received the assurance of a candidate, I would inform him to hand same over to one of the members employed along with him, and also advise the member working there that the candidate would expect him to collect his application and fee, and forward same to the lodge in which he was a member of. I know from experience that it is not an easy matter to collect initiation fees between pay days, and even on that day after being promised perhaps on several occasions very often there is some excuse given for not being in a position to pay. What they want to mention Lodges No. 451 and 529 for I don't

know. Evidently, somebody was busy making iniquities. There is a whole lot in the labor movement, that is a mystery to them, besides not knowing what I was doing during the time I spent in Winnipeg and vicinity.

Fifth. "At the beginning of the trouble between the boiler makers and helpers, he showed his ability as a piece-maker by failing to appear before a meeting of the helpers (when asked to come and advise them and help to clear up the differences between them and the boiler makers) on the rather flimsy ground that the helpers were not in good standing to the grand lodge and he did not see why he should waste any time with them at all, etc. In reply to the foregoing, I will say, that to the best of my knowledge there was no trouble between the boiler makers and helpers or vice versa at any time. I did everything that was fair and reasonable, while meeting with the helpers after I had returned to Winnipeg, from the Little Rock convention. If there was any differences or trouble between the helpers and boiler makers in Winnipeg, then it was because the convention decided or rather made it law, that the helpers divisions would be discontinued after December 31, 1912. The G. T. P. strike was still in effect after I returned from the convention, and naturally some of my time was spent on that road. I was not in Winnipeg, permanently to be meeting with Lodges Nos. 451 and 126, and Lodges Nos. 212 and 127 H. D.'s, at any time. But when the opportunity presented itself, I did go and attend the meetings of all four lodges, I did not shirk meeting the helpers at any time that I knew there was a meeting. If I did not attend any of their meetings after January 1, 1913, for a time, it was either because I was not in town or did not know they were holding a meeting. I admit that I did not attend any of their meetings after March, 1913. I was never asked to come and advise them. It was never necessary for any person or persons in Winnipeg, to have to come and request me to go and advise the helpers what to do. I took the initiative all of the time. I met with the helpers of Lodge No. 127, after I had returned from the convention. Not long after the convention, I met with the helpers of Lodge No. 127, on another occasion, and had six or seven members of Lodge No. 126 there also. I did not widen any breach that night. I also attended the meetings of 212 H. D., Brother D. Cook, was the delegate to the convention. He explained the changes when he returned. At a later meeting held by Lodge No. 212, arrangements were made to meet with a committee from Lodge No. 451, whereby they would co-operate regarding consolidation. It did not materialize. I can't be blamed for that. After being out over one of the roads, and returned to Winnipeg, I was given to understand indirectly that the helpers had change their views as to consolidation, and no committees of either of the four lodges

had met. Immediately, I called a special meeting of the presidents and secretaries of the four lodges, and had a thorough understanding in the matter as it existed at the time, and believed that that would be the settlement of the objectionable views on the part of the helpers and boiler makers, towards the consolidation.

I would like to know what lodge was being disrupted as a consequence of the helpers not abiding by the laws of our Brotherhood? None in Winnipeg, or vicinity that I know of. No such information has ever been brought to my attention directly or indirectly. I think it a very small statement to make that, the local lodge was being disrupted, as a consequence of the helpers not consolidating. Yes, a majority of the helpers employed in the C. P. R., local back-shop and roundhouse are not in the local lodge, but it is not for want of advice that they are not members of our Brotherhood, or the local lodge. Nor can it be said of anything that I did unlawfully that kept them from being members, unless, as is customary for someone to say to the contrary.

Advice! Well, I gave them both, boiler makers and helpers, all the advice in this matter that they could obtain from anybody, and without offending or injuring any person's feelings or character. Write I may say it myself: I have yet to hear some better arguments than those which I advanced in favor of consolidation of our forces. Some people try to make it appear as though it was simply a local affair, and not international.

Sixth. "His ability and results as an organizer in this district as far as Lodge No. 126, is concerned, has been nil, etc." Right here a lot of stress is placed on organizing the G. T. P. When I first went up there it was to handle the situation. It was September, 1911. October 10, 1911, our members came out on strike. The strike was in existence fourteen months. Was there any organizing to be done on that road during that time? Brother R. S. Ward and committee of machinists and myself, went to Montreal, to meet with the president of that road, and arrived at a basis of a settlement December 13, 1912. All of our members who applied within thirty days were given employment. I never went over the road to try to organize the unorganized, after the strike had been settled. No move had been made by either us or the machinists, until about April, 1913. The machinists decided to send a man over the G. T. P., to organize the unorganized. Brother Chas. MacGowan, of Lodge No. 529, at that time happened to be out of employment, and as the two crafts were co-operating towards bettering their conditions, undoubtedly the machinists were after some of the local officers to select some member as they were going to go over the road and organize the boiler makers and helpers. Because, the terms of the settlement of the strike, in part, read as follows: "I have

also agreed that next spring say May or June, if a majority of the men employed by the company in these crafts are not satisfied with their conditions of employment, you will meet a committee for the purpose of arranging the terms of an agreement, and failing to arrive at such an agreement, you will submit the question at issue to a board of conciliation appointed under the Industrial Disputes Act, and that the Company will agree to accept the decision of the Board, provided the men will also agree to accept such decision." A meeting of the lodges in Winnipeg, was held to appoint some member to act in conjunction with the machinists. Brother McGowan, being out of employment, naturally was selected. He went over the road and did get a number of new members. They admit that "a more fertile field could not be found, etc." Why, man alive these men (the majority of them) were wanting to know how they could obtain membership in either organization before either organization had decided what course they would pursue. Where most of the organizing was done, was done at Transcona shops. They all wanted to get into the Union, and be good fellows, after the strike was over. And, the fee that was offered to them was a cinch. They never considered the fee, it was the CARD they wanted. Why, it has not been unusual for the company to meet committees of our organization and machinists. They have been so doing since 1910. No, they were not successful in getting the company to abide by the late award of the board under the Industrial Disputes Act. Conditions throughout the continent did not warrant the employees of either craft giving the company another battle, after the award was made in their favor. The company was not trying to force the men to strike at all. I know who was talking strike. Why, the men could have taken that course if they wanted to, but they knew better, owing to trade conditions throughout the country.

No committee of Lodge No. 529, has ever asked me to come before their lodge and give them some advice as to how to act or what to do. Not necessary.

Yes, I was at the joint meeting, and joint meetings. I had all I wanted to say at Transcona meeting before we came in to Winnipeg, for the other meeting. The whole situation was explained by the chairman of the committees, and everything was clear to those present. They were to decide upon a proposition which was submitted to them by the company, through the committee. Brother R. S. Ward, of the machinists, and myself refrained from saying anything that might influence the meeting. The question of strike was not at issue at all.

Seventh. Well, I won't say that the men in the contract shops can't be organized. But, unless somebody is assigned solely to that work, I don't think it can be accomplished in short order. "Our time has been taken up this last two or three years with the trouble on the G. T. P. strike with the

helpers and boiler makers and grievances on the C. P. R., from time to time." Who are "our" who have been devoting all their time to such matters? Why, you would think that "our" whoever "our" is, had been doing some great work, prior to the G. T. P., strike, the consolidation and the local grievances, which arise everywhere, and laid blame on the above, because about two men that were members from the contract shops went in arrears.

Eighth. "What has been done in the way of organizing," etc. Well, if they settled any of their external and internal disputes, without my aid, I am glad to know it. But, to say that my aid has been solicited many times, is unwarranted. They are not of the decided opinion that change is necessary. Not Lodge No. 126, as yet anyway. For the balance of the resolution, I will have little or nothing to say.

Now, dear reader, I know that everybody is not my friend. The Good Book says: "Love your enemies." This I will endeavor to do. And while holding this position, I find that it is necessary for me to do so. But, I am not going to swallow them.

I am satisfied that I have the good wishes of our officers and members of this Brotherhood and other organizations, and wherever I have been I have been respected, and I intend to command such while I am your servant. I know how and who were the instigators of the foregoing resolution. I know how the approval of the other lodges was received, and many other matters of a scurrilous nature that has been done to try to injure my character, etc.

In conclusion, will say that I would have liked to have had this communication appear in the April issue of the Journal, but it was not convenient for me to get it in. However, I trust that it will appear in the May issue.

Thanking you in advance for your attention to this communication which I asked of you at the outset, I am,

Yours fraternally,

J. MERRIGAN,
Third I. V.-P.

FROM THE RAILWAY DEPARTMENT.

St. Louis, Mo.

(Continued from last month.)

With the adoption of new laws and acting in conformity with the rulings of the American Federation of Labor, the Department was confronted with many problems:

First. To acquaint the membership with the facts that the reorganized department represented very largely the form of organization desired.

Second. That all system federations must become affiliated to the department and recognize its laws and rules of procedure, for in no other manner could the plan of joint action be given a fair trial and the opportunity to prove its worth to the membership.

Third. That only members of organiza-

tions affiliated to the American Federation of Labor and the Railway Employees' Department were eligible to affiliation in a system federation.

Fourth. The necessity of prosecuting the work of organization on the unorganized roads and by so doing protect the interests of the organized.

Fifth. That the success of the department would be measured very largely by the support it received from the membership.

We want the membership at large, and particularly those who follow railroad work, to become thoroughly conversant with the aims and objects of the department. Section (1) of Article XV of the Laws of the American Federation of Labor reads:

"For the greater development of the labor movement, such departments subordinate to the American Federation of Labor are to be established from time to time as in the judgment of the American Federation of Labor, or of its Executive Council, may deem advisable. Each department is to manage and finance its own business."

The Railway Employees' Department is maintained at a cost of one-half of one cent per member, per month, paid direct to the secretary-treasurer of the department by the general officers of the international organizations affiliated to the department. Charters issued by the department to system federations cost ten dollars, for which they receive in return, a charter, seal, ledger, constitutions and one hundred letter heads; this represents the only cost of affiliation; system federations are given the greatest possible latitude in drafting their by-laws; practically the only requirement being that they must not conflict with or usurp the laws of their respective internationals, or those of the Railway Employees' Department; they must be submitted to and receive the approval of the president of the department to be in full force and effect.

The laws of this department were adopted in a convention held April, 1914, the delegates being composed of representative men elected by the members of their respective crafts working on the railroads of the United States and Canada, the grand lodge officers, with voice, but no vote, attended this convention, giving to the delegates the benefit of their wide experience and knowledge gained as a result of their many years of experience in upbuilding their respective organizations. The Railway Employees' Department is the only one of the five departments chartered by the American Federation of Labor which provides for this form of delegate representation; this may be largely attributed to the nature of the railway industry and the necessity of having delegates attend the department conventions who are thoroughly familiar and conversant with the conditions throughout their respective jurisdictions.

Conventions of the department are held biennially, the second Monday in the month of April, even numbered years.

Representation: "Each organization shall be entitled to one delegate from each system federation, who shall be elected at least thirty days previous to the convention, said delegate must be an employe of the railroad he represents or employed directly by the men on the system, and the names of such delegates shall be forwarded to the secretary-treasurer of this department immediately after election."

Notice to Membership: "Ninety days prior to convening the convention, the secretary-treasurer of this department shall notify the secretary-treasurer of the respective system federations of the date the convention will be held; also call attention to the manner of submitting resolutions, election of delegates, etcetera."

In order to meet the conditions prevailing throughout the United States and Canada, the convention subdivided the jurisdiction of the department into five divisions. To avoid detail we will simply state that Division No. 1 embraces all western roads, Division No. 2 all eastern and northeastern roads, Division No. 3 all southern and southeastern roads, division No. 4 all Canadian roads. Division No. 5 includes all locomotive and car manufacturing plants in the United States and Canada.

As rapidly as possible, it is the intention to organize each of these divisions, the system federations will be required to affiliate to their respective divisions and observe the laws and procedure adopted; all of which are subject to the approval of the department.

The specific object in view being to establish a condition that will facilitate negotiations for a joint agreement, embracing all roads and manufacturing plans within the jurisdictions of the respective divisions.

Divisions 1, 2 and 3 are divided into territories that in a general way conform to the different rate zones established by the rulings of the Interstate Commerce Commission. Each division will in a very great measure look after their own business, with the assistance and co-operation of the Executive Council and officers of the department; the laws of the department provide for the manner of procedure in all essential matters pertaining to the division, but are too lengthy to reproduce in an article of this kind. Copies of the constitution can be secured on application.

In explanation to the many inquiries received, the department laws provide for two distinct forms of system federation. One embraces the following organizations: Brotherhood of Boiler Makers and Helpers, Brotherhood Blacksmiths and Helpers, Brotherhood Railway Carmen, International Association of Machinists, International Brotherhood of Electrical Workers and the Sheet Metal Workers. These organizations comprise the Mechanical Section.

The Brotherhood of Railway Clerks, Switchmen's Union of North America and the International Brotherhood of Steam Shovel and Dredge Men represent the trans-

portation organizations, now affiliated to the department, and comprise the Transportation Section. The necessity for this action became apparent when the system federations opened negotiations for new agreements, and under present conditions it will be necessary to work along these lines. The plan represents the sentiment of the delegates attending the April, 1914, convention of the department, and will, no doubt, be continued until we are in a position to negotiate one general agreement for all organizations represented in the department. This must not in any manner be construed to mean that all affiliated organizations cannot or will not act jointly if the necessity arises. We have simply adjusted ourselves to meet a condition which we must and did recognize.

The Railway Employes' Department aims:

- (1) To bring within the organization all railway employes.
- (2) To shorten the hours of labor to eight hours per day.
- (3) To establish a minimum wage scale for all employes in all branches of railway service, said wage scale to conform to the recognized right that all who perform a useful or necessary work are entitled to earn a decent living for themselves and those dependent upon them.
- (4) To perfect the organization of its affiliated parts to a point where we can propose and make joint agreements, either for a specified territory or on a national basis.
- (5) To use all honorable means to prevent strikes or lock-outs, the department being pledged to a policy of conciliation and voluntary arbitration as a means of adjudication in all cases which cannot be otherwise settled.
- (6) To bring about uniform laws regarding per capita tax to internationals, and the inauguration of strikes and financing same.

These are some of the principal things which the department has been organized for, and if you will but stop and analyze the foregoing you must recognize that this department embraces all the features of an industrial organization, in addition to which we receive the financial and moral support of the members of the affiliated organizations irrespective of the industry in which they may be employed, we at the same time give our financial and moral support to them; under this plan and the laws of the American Federation of Labor, all of the great industries of this continent can be similarly organized and perfected. Those of our members who are prone to criticize the American Federation of Labor, its departments and the plans of craft organization, which have so often proven their worth and today stands pre-eminent in achievement, when compared with the labor organizations the world over, should, in justice to themselves and their fellow workers, bear in mind that the American Federation of Labor must, to a very great extent, reflect the sentiment of its affiliated

membership, and if the delegates elected to attend these conventions do not represent their respective workers, these members have the remedy in their own hands.

We have often found ourselves in disagreement with certain of the policies and some of the decisions of the American Federation of Labor, but this would not justify any action on the part of a minority that has for its purpose a division in the forces of labor; the man or organization that is not broad minded enough to recognize and abide by the decision arrived at by the majority, does not, in our opinion, represent an element that would be safe to

(To be continued in next month's Journal.)

Pratt, Kas.

To the Boiler Makers and Helpers of Kansas:

Having returned home from Topeka, disgusted, I will endeavor to give you a synopsis of the jitney legislature just adjourned:

The boiler inspection bill came to its death on the calendar as many other bills did. I had many promises from leaders in both houses that they would consider this bill before adjournment. However, I find that the promise of the average legislator is no more binding than that of a campaign promise. The amendment to the compensation law was agreed to by the employers, insurance people and representatives of labor, was passed by the house and messaged over to the senate, scrambled over for three and one-half hours and killed by striking out the enacting clause.

Four bills were introduced to re-create the State Society of Labor and Industry. At no time was there a shadow of a chance for its passage; just campaign buncombe handed out by Capper for the labor vote.

The full crew and train limit bills were both killed in committee and never came up for consideration on the floor of either house.

A bill was introduced requiring railroads to provide standard cabooses and met the same fate as the full crew bill.

A bill requiring electric headlights on switch-engines was introduced, and, as the railroads owned the committee, it was not recommended for passage.

The Barber Board Law was repealed. This law was self-sustaining and the board had turned over to the school fund over \$500, but Capper is opposed to giving a workingman a state job, no matter if it does not cost the state anything to maintain it.

Some kind of a mothers' pension law was passed, which is absolutely worthless so far as the common people are concerned.

A commission was created to determine the hours of service and wages for women and children; of course the governor will appoint the largest employer of labor and his political appointee as labor commissioner, who will tell us how many hours they shall work and under what conditions.

The semi-monthly pay became a law.

In the campaign of 1916 you will hear what great things were done for labor by the legislature (jitney) of 1915. Mr. Capper and his party have violated every promise made to labor, absolutely disregarding every pledge made and when he appointed Mr. McBride as labor commissioner he proved that political henchmen will be the only ones considered for appointment, and backed up on his offtime promise that he would be guided by labor's recommendation.

Brother John Craddick, president State Federation, Henry Hopkins of the Miners, C. H. Danner of the Conductors and R. V. Snyder of the Trainmen, I wish to thank for their efforts in promoting the boiler inspection bill.

Brother Casey deserves much credit for his efforts and if we had many of his ability and willingness to make a sacrifice for labor, we would accomplish much more. Few of us would be willing to put forth the efforts Brother Casey did at Topeka without any compensation, traveling to and from at night and working on the job during the day.

As for myself, I have no apology to offer. I did my best and any failure on my part was from inability and lack of judgment.

I thank you for your co-operation and sincerely hope two years hence that we will have a representation from each shop-craft at Topeka.

It would take too much space and cost considerable to give a detailed report as to how all the legislators voted on labor measures, but during the next campaign I hope to give account of them should they attempt to be re-elected.

With best wishes and kindest regards, I beg to remain

Fraternally yours,
S. T. SAMPLE.

Portsmouth, Va.

Dear Sir and Brother:

Herewith inclosed you will find a journal mailing list of twenty-eight names. which will show you that the boiler makers in the yards are waking up to the situation, and I tell you I felt much gratified to see them come into the organization. I think we have got all in except four or five, and I believe we will get them in, too, in a short time, as they now see they have to be closely allied to accomplish the things we go after. But it is not only the Boiler Makers alone that see the necessity of becoming organized; the other crafts are waking up to the fact, and the time is very near when we will have a Navy Yard Federation. They are working on it now. I am also looking forward to the time that the Boiler Makers of all navy yards will form a Naval District Lodge, and when that time comes and we can place a good man in Washington and keep him there, we will then get some recognition and good results.

Hoping this list is satisfactory, and with best wishes, I am,

Yours fraternally,
GEO. J. THOMAS,
Cor. Secy. Lodge No. 57.

St. Thomas, Ontario, Canada.

Dear Sir and Brother:

Please insert the following in the next issue of the Journal:
Mr. Alfred Jolliffe.

Dear Sir and Brother: The officers and members of Lodge No. 413 extend to you their deepest sympathy in this, your hour of Bereavement, occasioned by the death of your beloved mother. May God help you bear your burden.

Resolved, That while we lament with sorrow, we must submit to the will of our Heavenly Father, Who doeth all things well.

FRANK ROBERTS,
Cor. Secy. Lodge No. 413.

Tacoma, Wash.

As Lodge No. 568 has not used any space in our valuable Journal, thought I would like the brothers at large to know we are still on the map.

At our last regular meeting we held a little smoker in honor of V. P. Brother Atkinson, and Brother J. L. Callahan, B. A. of District No. 26; almost all the brothers were present, but I don't know if the V. P. and B. A. were the drawing cards or the refreshments. I hope it was the former. All respect and credit possible to give is certainly due Brother Callahan for the good work he is doing as Business Agent of District No. 26. So, brothers, let us all get together and help him in every way possible.

Brother Atkinson has also been a hard worker in this part of the country. We wish to extend him a vote of thanks for his endeavors. We are always glad to have Brother Atkinson present at our meetings.

Business is pretty quiet here. We all hope conditions will open up soon, but remember our policy is the same as ever—no card, no work.

With best wishes to all, I remain,
Yours fraternally,

A. W. RICKETT,
Fin. and Cor. Secy. Lodge No. 568.

Casper, Wyo.

Dear Sir and Bro:

At our last meeting here, which was April 5th, we decided to write to you and have you publish a notice in the Journal for May, to tell all brothers not to come up here, as there is only a little work here at present and we don't care to accept any more clearance cards. There may be some work open in the latter part of the summer but as it is now there is almost more men here than there is work, so if any more men come up here we won't be able to put them to work. So we would like to have you put this in the Journal.

Yours fraternally,
A. R. WITZ, S. L. 596.

Huntington, W. Va.

I am hereby sending a photograph of the boiler makers and helpers of Huntington shops, a part of them, they are not all here,

which I hope to see in the next issue of the Journal, and oblige,

Yours fraternally,

W. L. YOUNG.

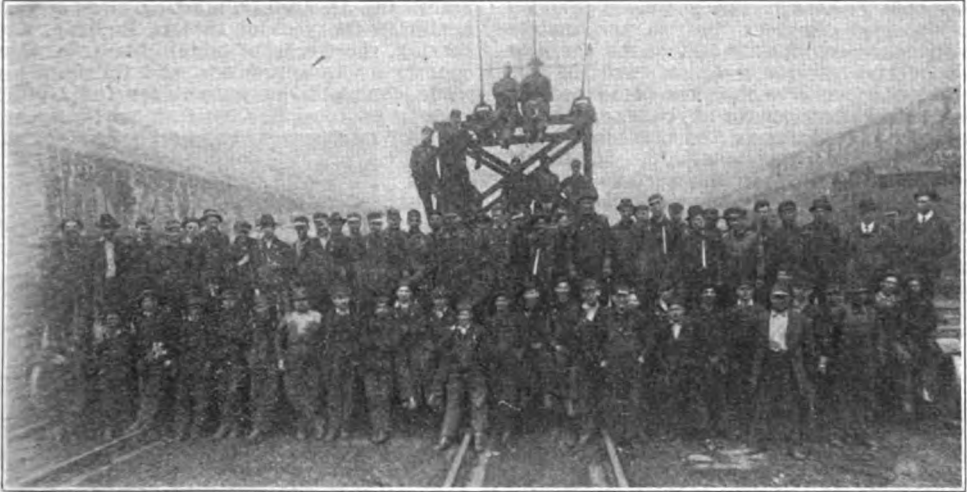

A GROUP OF SOME OF THE MEMBERS, LODGE 249, HUNTINGTON, W. VA.

RAILWAY EMPLOYES DEPARTMENT.

Office of President, St. Louis, Mo., March 30, 1915.

To all Officers and Members—Greeting:

We herewith submit a fac-simile copy of a circular (the original of which we have in our possession), being one of several of a similar character that have been sent broadcast by or through the instrumentality of Carl E. Person.

FEDERATION OF RAILWAY EMPLOYES
Now on Strike on the Illinois Central System
Strike Headquarters,

117 South Monroe, Rooms 2 and 3, Clinton, Ill., Phone 736. Carl E. Person, Strike Secretary, P. O. Box D.

Clinton, Ill., Feb. 26, 1915.

Dear Friend:—

We wrote you some time ago and asked you to subscribe for a bundle of Strike Bulletins. As yet we have not heard from you.

It is up to the labor movement to keep the public off the struck roads during the Frisco Fair, in doing this we need your assistance to carry on a campaign of publicity against the roads on strike.

We asked your lodge to purchase a bundle of 10 Strike Bulletins for one year, which will be ten dollars. If you can not do this, please give us an order for five papers for one year, which will be five dollars. Make it possible for us to advertise the strike in your city, won't you?

Please take this matter up at your next meeting, and let us hear from you.

I am fraternally yours,

(Seal)

F. D. COMERFORD,

Attorney for the men on strike.

Make all money orders and checks payable to Carl E. Person, Strike Secretary.

On March 25, 1915, Mr. Frank Comerford appeared before the Executive Council in St. Louis, Mo., in connection with the strike hearings to be held by the Commission on Industrial Relations. He was shown the above letter and declared the signature attached thereto as a forgery and that it was used without his knowledge or consent. Mr. Comerford was asked if he had ever issued or caused to be issued other similar circulars, bearing his signature. His answer was: "Never."

This letter bears the official seal of the Illinois Central System Federation, and while gotten out in Clinton, Ill., was inclosed in an envelope bearing the Chicago, Ill., postmark, showing that they had been transported to Chicago and mailed from the West Pullman Station.

The Strike Bulletin is not indorsed by the department, or any of the affiliated organizations, and the purpose of this circular is to acquaint you with this fact, together with the methods adopted by C. E. Person in an effort to secure financial support.

Issued by the authority of the Executive Council of the Railway Employers' Department of the A. F. of L.

(Seal)
A. O. WHARTON,
President.

JOHN SCOTT,
Sec'y.-Treas.

Elmwood Place, Ohio.

Dear Sir and Bro:

In reading the March and April issues of our Journal, I took particular notice of the communications therein from Brother Maes, of Lodge No. 123, Livingston, Mont., and hope that a few words from my pen will not be out of place. The articles I have in mind

are the proposed amendment to our G. L. Constitution, pertaining to a reduction in salary for our International President. I think that it is absolutely ridiculous, and I might further say it is laughable and if he wasn't so persistent I would be led to believe that he was trying to play a joke on our worthy president, but as the matter really is, I can't for the life of me see how a man who carries a union card in his pocket can conceive the idea of advocating a reduction in wages for anybody, especially so when it pertains to the organization to which he claims membership. It surely shows very plainly on the surface that he has not got a superfluous amount of common sense or diplomacy, or he would never have presented the matter to the rank and file in the manner he did. I'll venture to say that if he had the opportunity to obtain one of the positions in the official roster on our international organization he would very readily grasp it with both hands, and he would no doubt defy anybody to question his ability or anything else. I have been an active member of our worthy brotherhood for quite a number of years, and it has always been my impression that we ought to be brothers in every way that we possibly can, to always try to work in harmony with one another, and strike for better working conditions and increased wages. There is no doubt in the world, but that the officials in every line of business who employ boiler makers, know of every article contained in our Journal, and wouldn't it be a fine thing for the boiler makers of some contract shop or railroad line to go before the management to seek an increase in wages, and have them throw it in your face about your own organization reducing the salary of our international president. Why, they would simply turn you down cold, and consequently you would have a lot of disgruntled members, and they would be very apt to howl because the organization was of no assistance to them, so now you can readily see the fallacy of such an amendment and I sincerely hope it dies a sudden death. It is my honest opinion that Brother Franklin is not receiving one cent more than he deserves, and I feel sure that he is giving us the very best that he has in him and if we shall reduce his salary we are going to hurt his pride and feelings and no doubt he will want to resign from office, and who can but say that he would be missed very much, to our sorrow, so let us get together and kill this amendment.

Just a few remarks in regards to this part of the country; times have been rather hard all winter, but we are managing to pull through somehow and everybody seems to be happy, as prospects are beginning to look somewhat brighter and we all hope that spring will bring a revival of good business.

Hoping you will find space in the next issue of our Journal, and with best wishes and kindest regards, I am,

Yours fraternally,

JOHN CULLEN C. S. L. 91.

Dear Sir and Bro: Green Bay, Wis.

We, the officers and members of Lodge No. 485, Green Bay, Wis., wish you would find space in the next issue of the Journal for a few words concerning our Brother, Alfred Abbott, who has worked at our trade practically all his life, starting in as a rivet heater in the year of 1864 in England, and serving the term of eight years in that country as an apprentice, and finishing his trade complete, he started for the United



BROTHER ALFRED ABBOTT OF LODGE
485, GREEN BAY, WIS.

States the same year, finishing up his apprenticeship, settling down in Marquette, Mich., starting his career again as boiler maker for the D. S. S. & A. R. R. Co., and was shortly married after working there in 1872, or along that limited time. In 1874 returned to England on account of the panic and hard times in the United States and started to work for the same company that he previously had served his apprenticeship with, the London Northwestern R. R. Co., at the Cruve Locomotive works in Cheshire for 15 months, then was laid off on account of poor business.

Leaving there for Manchester he received a position as boiler maker with Galloway & Sons until 1878. On account of reduction in wages they went on strike for 26 weeks and lost out, and finally returned to the United States in June, 1879, landing back in the same old place, Marquette, Mich., and from there to Escanaba, Mich. March, 1880, working for the C. & N. W. for two years, quit and started again for the same company, in the year of 1885, working for them for five continuous years. He finally quit the road to come to Green Bay in July, 1890, to work for the old Milwaukee Northern R. R. Co., better known now as the great Chicago, Milwaukee & St. Paul R. R. system; continued to work at that place until the A. R. U. strike in 1894 then went back to the C. & N. W. where he has remained in their actual service as a competent boiler maker for 20 years.

Until the fall of 1914, on account of sickness of vertigo and rheumatic neuralgia, not being able to perform his daily duties, was granted a pension by the head officials of the C. & N. W. R. R. Co., for the long and faithful service he had rendered. His pension service date starting February 1, 1915. Brother Abbott was born in England, October 13, 1851, and also served his apprenticeship there as before stated.

We, the members, are also gratified to learn that our brother has received a pension for his long and active service with the C. & N. W. R. R. Co., also glad to know that our Brother Abbott is still a member in good standing in our local by still retaining his death benefit fund after taking a with-

drawal card, which has entitled him to all rights and benefits of our organization, to attend meetings which we all know would be a chair vacant in our lodge room that has never been properly filled. We all join in and wish him success for the remainder of his long and active life and being the first case of a charter member arising in our local, we are gratified to have a chance to publish same in our monthly Journal, so as to give the members of our organization a good example. Enclosed also find a photograph of Brother Abbott for Journal.

Yours Fraternally,

JOHN M. SLATER, Sec'y.
JOHN CHRISTENSEN, Pres.



VANCOUVER LODGE 194, DRY DOCK BUNCH, PRINCE RUPERT, B. C.

Dear Sir and Bro: Prince Rupert, B. C.
Inclosed find picture of members of Lodge No. 194 which are working on pontoon dock here at Prince Rupert. This dock is 600 feet long, wood pontoons and steel sides.

It is for the Grand Trunk Railway. This is the first dock of its kind in British Columbia. Would be glad if you would put this picture in the Journal.

Yours fraternally, BOB LACKIE.

Dear Sir and Bro: Buffalo, N. Y.
Inclosed you will please find a program of the Buffalo Technical Evening High School, which I have been attending the past six months, taking a first year's course in mechanical drawing, and I must say that the schools today are far advanced from what they were 25 years ago since I left school.

received the prize, the only one given in this class.

Trusting this may be an opening wedge in inducing our members to attend these schools, and take some interest in the technical pages of our Journal, and with best wishes and appreciation I beg to remain,

Yours fraternally,

JOS. ERNST, Treas. L. 7.
Lima, Ohio.

The drawings that are made and the developments of same are very interesting and instructing, and ought to stimulate all of our young and old members to be up and doing something to advance themselves, for their own welfare, as well as to their employers, they can advance themselves in these schools by studying in their spare time and at the same time take advantage of the technical page of the Journal, which I myself have been following out in detail.

No doubt you will be interested in the enclosed program as out of a class of 32, I

At a regular meeting of Oak Lodge No. 259 the following resolutions were adopted unanimously.

Whereas, It has pleased the Almighty God in His divine wisdom, to remove from our midst the beloved son of our esteemed brother, A. K. Greishiemer; therefore, be it

Resolved, That we, his brothers, extend to the bereaved brother and wife our heartfelt sympathy, in this, their hour of bereave-

ment, and pray that the Almighty God may comfort and console them, and that they may bear their trials with fortitude; and be it further

Resolved, That a copy of these resolutions be spread on our minute book, a copy forwarded to our bereaved brother and wife and a copy be sent to our official Journal for publication.

HARRY L. GUNN,
A. C. THOMPSON,
PATER O'NEILL,
Committee.

Boston, Mass.

Dear Sir and Bro:

I take the liberty and pleasure at this time of showing to our brother members in the other various locals throughout the various states the work I have been accomplishing since I first took the office of business agent of Local No. 585 here in Boston, and vicinity, especially in the increasing of our membership and the general building up of our body.

With the good assistance of all my fellow members from our worthy president, Brother Wm. E. McNabb, and all of our officers and members, there has been good success, as everyone has kept their shoulder to the wheel and have always been ready and willing to assist me in the work which I have been doing.

There has been 14 boiler makers reinstated and two boiler makers initiated. There has also been 14 boiler makers' helpers who have been initiated and 15 boiler makers' helpers who have been reinstated. The above are as follows:

14 boiler makers reinstated.	\$140.00
2 boiler makers initiated.	20.00
14 boiler makers' helpers initiated.	70.00
Total.	\$305.00

We have also had 12 boiler makers' clearance cards taken in and 13 helpers' clearance cards that have been taken. This shows an increase to our body of 170 members. The outlook for a greater increase in our membership is very promising and I have assurances that in the near future our body will be one of the strongest.

I wish to say in closing that I hope every boiler maker who is not at present a member of our local in the vicinity where we are located will get on the firing line and become a union man, as it means protection to himself and a great benefit to his family. I trust that my letter will appear in the May issue of our Journal for the benefit of our fellow members.

Yours fraternally,
DANIEL N. GENERSON,
B. A. L. 585.

P. S.: I am very grateful to Brother John J. Dowd, our Sixth International Vice-President, for the great help, service and advice he has given to me while he was in Boston.

Nashville, Tenn.

Dear Sir and Bro:

You will find inclosed a copy of a memorial of Brother James Fitzgerald and wife to be published at a regular meeting of Lodge No. 42 at Nashville, Tenn., held March 25, 1915. The following resolutions were adopted:

Our brother and wife, Mike J. Fitzgerald, has been called to the great beyond; therefore, be it

Resolved, That we extend our heartfelt sympathy to the family of the deceased and trust that the Heavenly Father will comfort them in their bereavement and help them to say, not my will, Oh, Lord, but Thine be done; and be it further

Resolved, That our charter be draped for 30 days, a copy of these resolutions be spread on the minutes of our meeting, a copy sent to the bereaved family and a copy sent to our official Journal for publication.

Yours fraternally,
BROOKS BREWER,
ELVIN CARVER,
W. T. PENTECOST,
Committee.

Decatur, Ill.

The wave of laying off men has at last struck the members of Lodge No. 447, and twenty boiler makers have been laid off as well as mechanics of other crafts in like proportion. How long the lay-off will last it seems no one is able to tell at present, but we hope not long. Lodge No. 447 is attempting to organize a ladies' auxiliary. At our last regular meeting, April 6th, a short meeting was held, after which a banquet was held, attended by the wives and families of a large portion of the members of No. 447. The committee that was appointed by the lodge to handle this affair did splendid work and deserves some consideration as it was strictly handled by members of No. 447. The object was explained to all present and a great many ladies signed up for a ladies' auxiliary, the result of which remains to be seen. The evening was spent in dancing, the music furnished by members of the lodge and their wives, and all had such a joyous time. It was midnight before we left the hall. It was Lodge No. 447's first attempt and it was such a success we hope it will be repeated in the near future.

Lodge No. 447 has a large membership and should have a large ladies' auxiliary and organized labor be benefited by the cooperation by these two organizations.

Cor. Sec'y. Lodge No. 447.

East Boston, Mass.

Dear Sir and Brother:

The Third Annual Ball of Lodge No. 585, was held on the night of April 9th at Sumner Hall, East Boston, Mass., in a blaze of glory. From 8:00 to 9:00 p. m. A very enjoyable concert program was rendered by Fisk's Orchestra, Mr. Joe Fisk, leader; dancing followed from 9:00 p. m. to 2:00

a. m., with a midnight intermission for supper. The spirits of Terpsichore, Orpheus and Epicurus which seemed to linger while "the dancing was on" made the festive event one long to be remembered. The enchanting music, the beautiful floral and bunting decorations, the handsomely gowned ladies, and the well groomed gentlemen in evening dress made the scene one of animation and beauty. Perfect order prevailed, not one ripple of unpleasantness marred the placidity of the evening's entertainment. Dance number four was dedicated to our tried and true friend, Sixth International Vice-President John J. Dowd, who tried to arrange to be able to be present to greet us with his cheery presence and encouraging remarks in the general situation, particularly in the port of New York, where he has been for some time working with all his strength and sagacity in worthy grand effort to reintimate the slumbering embers of unionism in our craft in the great metropolis but duty, which is always paramount to pleasure with John J. Dowd, prevented him from attending the ball.

The success of the affair both from a social and financial standpoint was due to the committee of arrangements. Wm. E. McNabb, John Warnock, Augustus E. Page, Daniel E. Generson, Daniel B. McInnes, Secy.; Harry Hegan, Thom. J. Farmer, Wm. Clouter, Bernard McDonald, Treasurer; and Chas F. Smith. The officers of the ball were: Floor director, Wm. E. McNabb; Assistant floor director, Thos. J. Farmer; Marshal, D. N. Generson. Aids: Sam'l. Eccles, Chas. L. Schmidt, John Nolan, John J. Farrell, Chas. J. Smith, Jas. E. McNabb, Edw.

Schriren, Danial Higgins, Wm. Warnock and Thos. DeFretas, and among others present, Secretary Jos. Irwin and President Geo. A. Mitchell of Lodge No. 515.

Representative John J. Kearney of Ward No. 2, East Boston, Mass., who is a vice-president of the Massachusetts State Branch of the A. F. of L., and one of organized labor's most consistent and trusted advocates in the Massachusetts legislature.

Wm. E. McNabb and wife and son, Thos. J. Farmer, wife and son, Bernard McDonald and wife and daughter, Jas. A. Vincent, Dan'l. B. McInnes and wife, Mr. and Mrs. Chas. Griffith, Benjamin White and wife, Mrs. Catherine McDonald, Harry Hegan and wife, James R. Spiers and wife, Charles F. Smith and wife, Frank Gardis and wife, Michael Flaherty and wife, John Bernard Gahen, Chas. Jenkins, James Bogan, John W. Cartwright and wife, T. F. DeFretas and wife, Thos. Murphy and wife and daughter, John Wilson, wife and son, Matthew Mason, Thos. Bradley, Thos. Jordan, Jos. J. Kerrigan, David J. Dooley, Jos. Supino and sisters, D. Wolfso, John J. Kerrigan, J. Healey, B. Gallagher, Wm. S. Shannon, John Warnock and wife, A. E. Page and wife, Chas. L. Schmidt, Thos. Lockman, John F. Callahan, Jas. Brown and wife and daughters, Wm. Warnock and wife, Dan'l. Higgins and wife, Wm. Clouter and wife, Wm. Smith, Geo. P. Lawler, Con'l. McInnes and wife, David J. Dooly and wife, Wm. J. Westlake and wife and Arthur Clemens and wife.

Yours fraternally,

DANIEL B. MCINNES,
C. S. L., 585.



PHOTO OF BANQUET, LODGE 450, WASHINGTON, D. C.

Dear Sir and Brother: Washington, D. C.

On some occasions Local No. 450 writes to the Journal on business pertaining to our local. On this occasion we are writing to be published in our Journal of an evening of pleasure, also honor to Local No. 450, which shall go down in history in the labor movement of the Nation's Capital.

At a former meeting it was decided, to hold a banquet to celebrate our anniversary,

and primarily, to get the employer and employes in closer touch with each other, also if possible to get all unorganized boiler makers of this city to become members of Local No. 450.

With this end in view the following committees were appointed, General Banquet Committee, W. Webber, chairman; Geo. P. Smith, H. LeLaurin, M. H. Kimmerling and A. W. Sherier.

Committee on speakers. Jno. Kimmerling, chairman; Jno. Meade and J. D. Evans.

Entertainment Committee. A. W. Sherier, chairman; R. Wagner and C. Crawford. Printing and press committee. O. Baker, chairman; S. S. Kelchner and W. P. Kilroy.

The place and date decided on, the New Masonic Hall and February 29th was selected.

The following gentlemen were extended invitations. Hon. Edw. Keating, member of congress from Col. Frank Morrison, Sec. A. F. L., A. J. Berres, Secretary Metal Trades Department, A. F. of L. C. H. Clayton, clerk of committee on labor, U. S. Congress, Hon. Franklin Roosevelt, Secretary of navy, sent his regrets owing to business of a pressing nature at this particular time.

The following employers, Mr. Boswell, Mr. Webber, and Mr. Briscoe were present. Brother Keeler, secretary of Columbia Lodge No. 174, Brother Rucker of the Pattern makers, boiler makers from railroad and contract shops not members of our local and all members of Local No. 450 were present.

Brother Thos. Nolan having business in the city at the time kindly consented to act as toastmaster, which was done in a very able manner.

The reception started at 8:30 p. m. in the main auditorium, where Moody's Union Orchestra was stationed, our esteemed President, Bro. A. W. Sherier and International Vice-President Nolan in a few words of welcome led those present to the banquet hall on the next floor, which was beautifully decorated by the committee in charge who are deserving of great credit.

The tables were arranged in an artistic manner, laden with all the best the season affords, together with the beautiful vases of flowers, was a sight to freshen the appetite of those present.

This part of the program was attended to by the following wives of members of Local No. 450: Mrs. A. W. Sherier, Mrs. Wm. Webber, Mrs. Geo. Smith, Mrs. J. W. Kimmerling and Mrs. M. W. Kimmerling, also Mrs. LeLaurin, wife of our foreman boiler maker at the Navy Yard. Mr. Le Laurin although holding a withdrawal card has always taken an active interest in the welfare of our local. Great credit is due the ladies, for without their gentle touch and energy our banquet would not have been the success it was.

After all present had been filled to the utmost midst the strains of popular airs from the orchestra, a flashlight picture was taken, a copy of same I inclose for the Journal. While union made cigars were passed around, Brother Nolan in his able manner, introduced the speakers.

Hon. Edw. Keating spoke on organized labor in general, his connection with same, at present holding a card in the Printer's

Union, his remarks being received by loud applause.

Frank Morrison, spoke in his usual witty manner of telling incidents and having the honor of being an uncle to a coming boiler maker.

A. J. Berres spoke on the benefits of the metal trades department of the A. F. L.

C. H. Clayton spoke of the co-operation of the Labor Committee in Congress to assist the labor unions and to assist as far as he is able the Brotherhood of Boiler Makers.

B. P. Donnelly, chief gunner of the U. S. N., whose remarks were of interest, being scientific, theoretical and logical, concluding his speech on the effects of the speeding up systems in navy yards and arsenals in connection with the intricate parts of guns on the battleships of our navy. Though not in a position to be a union man, Mr. Donnelly has always been ready to give his assistance at any time to organized labor.

Mr. Briscoe, Mr. Boswell and Mr. Webber spoke on their intention to co-operate with the union man.

Brother Keller, noted for his oratory, and Brother Rucker also well received remarks.

The hour getting late our toastmaster moved to adjourn and all present sang "America" standing, after which all retired to their homes, satisfied that the boiler makers of Washington, D. C., Local No. 450, had paved the way of informal meetings of this nature where employes and employers could meet on equal ground, become friends for each other's interest and create the feeling of true brotherhood, which as organized men, we all strive for.

Fraternally, J. D. EVANS,
A. W. SHERIER,
W. P. KILROY.

Brainerd, Minn., April 10, 1915.
Editor Journal—Dear Sir and Brother:

It seems to have become a characteristic habit of yours to brand most statements not in accord with your views as not "authentic," "not based on fact," etc. This method is not new, nor does it satisfy the average member. Some may probably consider such a statement from you as being final, but I think the large majority of our members are too intelligent to accept such as proof.

Now, in your reply to a resolution from Lodge No. 116 and unanimously indorsed by Lodges No. 123, 111, 130 and 247 (which indorsements were not published), you take the position that said communication was simply "addressed" to J. A. Franklin and others, and these were requested to give their private opinion on the subject. Now, brother, you are either ignorant of the full contents and purport of that communication or you are resorting to subterfuge. To be sure it was addressed to J. A. Franklin as head of this organization, that, I believe is the usual manner of submitting questions to this organization, but to infer that only his opinion was requested is not only misleading but is absolutely wrong.

As proof of such, all one needs is to read the communication as published in the Machinists' Journal for November, 1914. If you have read that communication, then I insist that you are quibbling. But, possibly, you have not read it. If not, then suggestions being in order, I suggest that before accusing others of rushing into print and making misstatements, that you permit the president to answer for himself, or be sure you understand the facts yourself.

I am forced by your note to furnish proof that this communication was in reality addressed to our whole organization through the medium of our president. This communication embraces a report adopted by the general officers of the Machinists' Union, approved by their general executive board, submitted to a referendum vote and indorsed. Now the machinists' organization is not in the habit of going through all that business simply to get the private opinion of Messrs. Franklin, Kline, Haynes, McElroy, Kirby, Daly, McNulty and Alpine. The report and the resolution adopted expresses the views of the machinists' union on the question of amalgamation, and its purpose is to get the other metal crafts to investigate the proposition.

In President W. H. Johnston's letter, he makes it very clear that it is intended to bring about a full discussion and an extensive study of this question. I quote from his letter. He says, "It now becomes my duty, under the provisions of the resolution, to get in touch with you with a view of fulfilling the full purport of the resolution, and ask your organization, through you, to give me some expression as to your position on this very important question."

This is very clear, it is an expression from the boiler makers' organization that is requested, not from Brother Franklin as you infer.

Further on he states, "I am sure that you will agree with me that this is a question that cannot be worked out in a day or possibly a year. It will take time, as it is an educational question and must receive the best thought of the rank and file of your organization."

Now it is very probable that the resolution opposing this question was drawn up by one man on the committee appointed by our executive council, and possibly not more than half an hour's study of the whole question was given, if any at all, for the committee was instructed to report unfavorable.

Now brother, I respect our grand lodge officers and consider them competent men, but I must condemn the method by which they have handled this matter. Place the machinists' report side by side with the report of our executive council, and one must agree with the brothers in Winnipeg when they term our executive council's resolution "childish" and without "logic."

Considering the actions of our officers on this question, and the failure to publish said communication in our Journal, it seems

clear that an attempt is made to smother this question, hoping that it will eventually blow over. Our resolution, in view of these facts, is correct in condemning our officers' conduct. Regarding the statements made in an editorial in our Journal for December, it seems quite consistent with our officers' action, and to read it again, in the light of these further evasions and subtle insinuations, it is obvious that the motive was to breed distrust, thereby preventing a getting-together on this question.

Perhaps it was you, Brother Editor, "that acted hastily in drawing conclusions because of not being fully informed." Now I have stated this as frankly as possible. I have absolutely no personal feeling against any of the officers. I believe they have made a mistake and that you, brother, in attempting to justify wrong procedure, are also in error. It's not a good policy. So far as I am concerned, I am willing to drop this feature of the question, providing our officers see to it that this communication is published in full in our Journal, and that a free and full discussion is permitted on the question.

Lodge No. 116 feels that it has simply stated facts in plain language, not for the purpose of hurting the feelings of our president or you, brother Editor, but to impress it on our officers that the only way to do business for us is to do it openly and straightforward. This is too important a question to be handled lightly and, if amalgamation is to be the logical outcome of development in the labor movement, nothing can stop it.

I trust that our officers will look at this question in a proper light. I do not mean that they should favor it, simply that in the last analysis it is the rank and file that must decide, and necessity will determine what their decisions will be. Let us discuss amalgamation seriously from every angle. I hope that personalities and ridicule will be dispensed with and that a clear, logical argument for and against will be conducted in our Journal.

Hoping to see the communication from the machinists in this month's Journal,

Fraternally submitted,

J. G. BROWN, Lodge No. 116.

Winnipeg, Canada.

To the Officers and Members of the I. B. of B. M., I. S. B. and H. of A.:

To continue the discussion of a further amalgamation of the workers engaged in the railroad industry which was suggested by Brother McGowan of Lodge No. 377 and commenced by Lodge No. 126 of Winnipeg in the March Journal and which was replied to by Brother Franklin in the same issue, in which he states among other things that ("it might be well to add at this time that there are members of the executive council who were affiliated with the labor movement, giving the very best that was in them, in the interest of our movement when the authors of this article were in

swaddling clothes. If such statements were not disgusting to men of sober thought, they might be considered funny") and also ("it is a wonderful thing to dream dreams and to see visions").

Now one would glean from the above that Brother Franklin was attempting to convey the impression that human beings gain in wisdom, "like whiskey does in quality, with age." If such is the case, one will have to admit also that it is sometimes very difficult to "teach an old dog a new trick" and if after studying past history as far as written history goes one finds that the workers have always been treated the same, if not worse than the other animals (and I use the word animal here, as the human species is only different to the rest to the extent that he is "supposed to think") that the workers have been ruled, robbed and fooled by a master class through most of the time of written history, "ruled" to the extent that the master class had the physical and mental "might," "robbed" on an average of all they were able to produce, with the use of the different kinds of "tools of production" of the different ages, robbed of all except what it took to keep them in their different standards of living and reproduce their kind, as it is necessary to have other workers when the older ones are dead or are cast on the industrial scrap heap. "Fooled" to the extent that the master class could use the public institution of information, such as the "press," school and church, to mentally chloroform the workers and after learning the above, one comes to the inevitable conclusions that only insofar as the workers as a class understand their "class position" in human society and to that extent so organize to combat the master class, is the only way that they (the workers) have ever secured anything to their material interest.

Further we find that the position of the "working class," as compared with the masters is relatively speaking worse at present than any time in history, by this we mean that the workers on an average receive less, as compared with their total product, this being accounted for by the fact that with the aid of more modern tools, their capacity to produce more has greatly increased and the amount of the same, that they receive in the form of wages, has not kept pace with the increased product, although wages have had the appearances of increasing from time to time, hence the spectacle of the 20th century wage slave being the most prolific of any kind of a slave that has existed to date.

Also that human labor power is the "only human factor" necessary in wealth production, hence to the workers the whole product (by all the reasoning of common sense) should belong.

Now after considering the above analysis of the working class (which, by the way of a reminder, the member of this International are part and parcel of, although there is no doubt but what some might think

otherwise) we advocate certain changes in the form of our present organization, which we think will place us in a better position to combat the master class. If said changes are not in accordance with the ideas as expressed by Brother Franklin and Brother Gompfer's *la H. F. of L.* and for that reason are the external indications of a "dreamer" and one who attempts to express such ideas verbally or in writing, according to our president, are the sure symptoms of the one so doing "dreaming dreams," although we had always been led to believe that "a dreamer" was one who, in a somnolent state, was unconscious to everything except the sub-conscious involuntary action of the mind, a condition, we are not, as yet, willing to admit we are in.

But to get back again to Brother Franklin's article, page 194, *March Journal*. From reading same one would come to the conclusion that Lodge No. 126 was offering a cut and dried plan of an organization that would completely emancipate at least the metal workers, but if any have such an impression, we ask you to carefully re-read the article by Lodge No. 126, appearing on page 193 of the same *Journal*, after which we think you will agree with us, in what we intended the article to be, namely, the means of using the pages of the *Journal* for the friendly and intelligent discussion of further solidification of the railroad and metal trades and other important subjects that could and should be discussed, no doubt to the advantage of all of us, if necessary to the exclusion of the lengthy accounts given of the grand reception given to so and so, or election of officers held, after which followed smoker, etc., or some one born, died or married, all of which, no doubt, is very interesting to those immediately concerned, but with but very few exceptions is not of interest to anyone else.

In expressing the above we believe we are saying what was amply exemplified in the April issue of our *Journal* by the different articles by members of the different lodges.

Of special interest are the articles by Lodge No. 179 of Denver, the one by Brother Brown of Lodge No. 116, also the ones from "the Railway Department" and Brother Lines of Springfield.

Now just a word in answer to Brother Lines' article on page 287 of above *Journal*, where he expresses doubt as to the feasibility of men learning to be all round mechanics, permit us to say that that is the affair of the masters, not ours, our concern is not, at present at least, to produce more wealth, but how to get a greater portion; if not all of that which we already produce and the masters are looking well after their end of it, as is so ably pointed out by the article from Lodge No. 179 on page 277, that in place of the companies making all round mechanics, they are doing just the reverse, making specialist or more machine tenders if you like, something the writer as well as any "boomer" can testify to. So

let us be frank and whether we like it or not (most of us don't) and admit that our trade like most all other trades is becoming so specialized that it is impossible to tell where one trade leaves off and the others commence.

Now let us see where our interests as railroad workers are in common and for that purpose will copy the preamble of the C. N. R. R. System Federation, which was adopted at a meeting of that organization held recently.

"The Federation of Shop Employees of the Canadian Northern Railway System recognize the following as being of vital importance that may require united action at any time:

- No. 1. Hours of work.
- No. 2. Overtime rate.
- No. 3. Wages.
- No. 4. Discrimination.
- No. 5. Disposition of old employees.
- No. 6. Apprentice question.
- No. 7. Recognition of the federation.
- No. 8. Recognition of joint shop committees.

The cause for either will be cause for joint action.

Now brothers, let me ask you, if the only thing left out in the above, worth considering, is not the demarkation of trade lines which we pointed out was so complicated that it was impossible to tell where one leaves off, etc.?

Now, let us candidly ask you in the name of common sense is it worth all the expense of keeping up the different organizations as pointed out by Brother Brown of Lodge No. 116 on page 273 of April Journal? Is it worth all the time spent in jurisdictional disputes as is evident by reading the proceedings of any trade union convenient? Stop and consider the time spent by our international officers in such disputes, just read Brother Franklin's report to the last convention and see what a great amount of his time was taken up in this respect, then consider for a minute the other organizations and you will get some idea of what an expense we are put to, not to fight the "Master Class," but to scrap between ourselves, all for what? To see what worker will do a certain piece of work to the exclusion of some other worker. Can we lay claim in any sense of the word to being progressive and continue such tactics as these?

It is with regret that the writer of this article has to announce the departure of the Brother who originally started the discussion of this subject through Lodge No. 126 in the pages of the Journal, as he was compelled to leave, in search of that ever elusive "job," so it becomes our duty to continue it and in so doing, we realize that one cannot mention everything that can be said for or against a subject of this kind in one or even several articles of this size, but in finishing this time, again permit me to quote from the proceedings of the recent C. N. R. Federation Convention, after-

noon session, second day proceedings. We find this, "Whereas we believe that organized labor, particularly in the metal trades would accomplish far better results under one organization. Therefore, be it resolved that this federation go on record as being in favor of the amalgamation of the metal trades under one grand lodge and one set of grand lodge officers."

The foregoing was unanimously indorsed by the above organization, showing to what extent the move is being considered up in this country.

Just a word aside from the above subject. Lodge No. 126 has a provision, as most of you are, no doubt, aware, in the March and April Journal, offering a recall proposition for Grand Lodge Officers. It is not the intention of the writer to discuss same at this late date, only to point out that Lodge No. 126, after re-considering part of same decided to withdraw the lines (such statement not to exceed 300 words) contained in part (b). This change will no doubt be made on ballots by Brother Franklin if it receives sufficient support to get that far, which you have until May the 10th to decide on.

Now another word in regard to what appears to be a mistake of some sort, in the article by Brother Freeman of Lodge No. 96 which appears on page 288, April Journal. He deals with a resolution which according to the way it is in the Journal, is offered by Lodge No. 126, when from what follows, a mistake of some kind is very apparent.

In closing, let me add to the suggestion offered by Brother Franklin to the members of Lodge No. 126 in his article in March Journal ("not only to study the history of the labor movement in this country") but study the history of the workers, as far back as written history goes through the ages, study the class position of the workers at the present time, learn to understand the system in which you live and it is a safe bet that ere long you will be classed among the "dreamers" also as maintained in the early part of this Article.

Yours fraternally,

R. C. McCUTCHAN,
Member Lodge No. 126.

Cushing, Okla.

Dear Sir and Brother:

Under separate mailing envelope I am sending you a photo of the burial of the late Brother Alec MacAvoy, Reg. No. 31223 of Osage Lodge No. 592, who succumbed to pneumonia after a short five days' period. Brother MacAvoy was born in Lima, Ohio, initiated in Lodge No. 83 of Jackson, Tenn., April 29, 1903. Recently was reinstated in Lodge No. 486 of Tyler, Texas, had also been a member of Lodge No. 37, New Orleans, La., and No. 592 of Tulsa, Okla.

Brother MacAvoy was a tried and true member and has been the sixth member to pass away in the oil fields within the past three months. Brother Perry MacAvoy

of Lodge No. 90, Sugar Creek, Mo., brother of the deceased attended the burial and is seen in the picture near the left of the remains. Fifty members of Lodge No. 592 escorted the remains as a mark of respect from the undertaking parlors to the Catholic Church of Cushing, where Reverend Father Trienekens celebrated a requiem mass after which the remains were interred at Cushing Catholic Cemetery.

Lodge No. 592 mourns the loss of a staunch trade unionist and a beloved friend in the passing away of Brother Alec MacAvoy.

Resolutions of condolence will be found in another page of our Journal including the

names and register numbers of Brother MacAvoy, Frank Hanivan, John Carrigan, Chas. P. Callopy, O. J. McBride and James B. Farrell, who also have in the past three months been removed to eternal rest through the divine wisdom and mercy of Almighty God. May Eternal light shine upon them.

With the exceptions of Brother MacAvoy and Brother Carrigan interment was made at distant points. Brother P. J. McBride at Bloomington, Ill., Brother James B. Farrell at Dayton, Ohio, Chas. P. Callopy at Olean, N. Y., and Brother Frank Hanivan at Titusville, Pa.

Respectfully submitted,
JOS. P. RYAN, 8th I. V. P.



MEMBERS OF OSAGE LODGE 592, CUSHING, OKLA., APRIL 10, 1915,
BURIAL OF BROTHER ALEC. MACAVOY.

Dear Sir and Brother:

As a means of keeping our strike situa-

Cushing, Okla.

tion before the rank and file of our Brotherhood, I am submitting some paragraphs of some union jobs in the Cushing filedis dis-

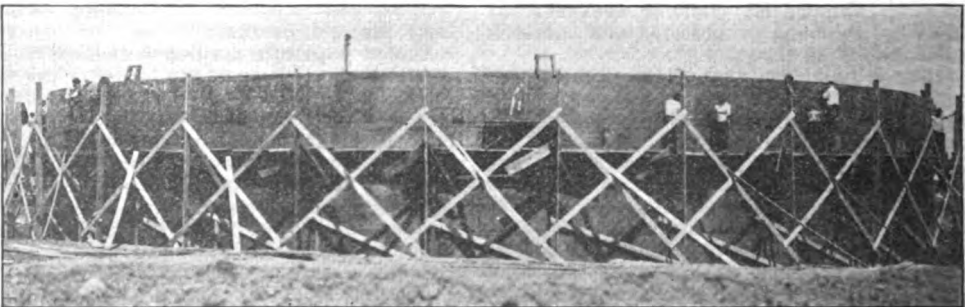

SHELL CREW ON A 55,000 BARREL TANK, GRAVER CO., UNION JOB,
CUSHING, OKLA.



LOWERING BOTTOM 55,000 BARREL TANK, UNITED IRON WORKS JOB, UNION JOB, CUSHING, OKLA.

strict, now in course of erection and under the jurisdiction of Lodge No. 592 of Tulsa, Okla. Picture No. 1, shows crew on 55,000 bbl. tank. Wm. Graver Co., James McMahon, foreman; Brother E. J. Johnson and Tom Loggins, assistant foreman.

Picture No. 2—Wm. Graver Co., camp

showing field office, dining hall, tents and tank in course of erection.

Picture No. 3—United Iron Works Co., of Iola, Kansas job, lowering bottom of a 55,000 bbl. tank. Brother Roy Conley, foreman; Brother J. Cairns, assistant foreman.

Respectfully submitted,
JOS. P. RYAN, 8th I. V.-P.

Livingston, Mont.

Dear Sir and Bro:

Please insert the following article in the May issue of our official Journal.

In the April issue of our Journal, appeared several articles written by our members, which are against the resolution presented by Lodge No. 123, and what for, to discourage the rank and file against the resolution. Of course, all the articles are a disapproval of the resolution.

It seems very strange that not a one appears approving of our resolution, and yet we know it to be a fact that an approval to our resolution was sent to the editor for publication, and which was refused on the grounds that it was inflammatory.

Brother Hinzman's article, consisting of four pages in the April issue of our Journal, not only abuses one of our members, but the entire Lodge of No. 123. He goes on with a big howl and uproar, about the articles Brother C. J. Maes wrote for the Journal, stating that they are not facts, that they are misstatements. Read Brother Hinzman's article and see if he proves that they are not facts. The statement that Brother Maes is capable of inducing seventy-five members of Lodge No. 123, is to broad a statement for anyone to make, and get away with it, without a bit of retaliation from the members of No. 123, and we feel that Brother Hinzman owes this lodge an apology. Also to Brother Maes, at the same time begin practicing what he preaches, lay aside the hammer, boost and quit knocking our members and our resolution. Talk about machine politics, what else can one make out of those articles in our Journal, everything against, nothing for, and note who wrote them, an article for the resolution is considering inflammatory. Why not print an article for once in a while. Oh, no! just what happens to suit the editor or our dear Brother Hinzman. Away with this one-man power, give

us all equal rights to the Journal. Our claim is that the rank and file is competent to transact any and all of the business of this Brotherhood, and to vote on questions after free discussion in the lodge room, without a word from the officers who happen to be paid employes of our Brotherhood, especially as the disgruntled argument Brother Hinzman wrote. He must be afraid that he won't get a raise in his salary. If high salaries is all he can advocate for officers, then we had better have no officers at all. We claim the salaries were high enough and which they are, as they receive all expenses, including everything. There is not one who looks like a "million dollar beauty" to us. You are all being paid better wages than any of us who are working at the trade.

We care not what the salaries are of the other organization officers, as that seems to be the big thing at convention, to raise the salaries of some officer and then go back home and boast of what was done. The A. F. of L. raises salaries, then the metal trades, and so on down the line until they get entirely out of any comparison of the man who toils in the shop or factory. Put the brakes on brothers, or we will have to pay more per capita tax in order to pay the officers their salary.

Yours fraternally,

C. D. CAIN, President.

THEO. W. EVERT, C. & F. S. L. 123.

Cushing, Okla.

Dear Sir and Brother:

At the last regular meeting of Osage Lodge No. 592, International Brotherhood of Boiler Makers, Iron Ship Builders and Helpers of America, the following resolutions were adopted:

Whereas, In a short period of three months the Almighty God, in his infinite wisdom and mercy, has caused to be removed from our ranks six of our brothers, namely,

Brothers James B. Farrell, Reg. No. 58684; P. J. McBride, Reg. No. 9938; John Corrigan, Reg. No. 99176; Charles P. Callopy, Reg. No. 42730; Frank Hanivan, Reg. No. 77483, and Alec MacAvoy, Reg. No. 31223; and,

Whereas, Osage Lodge No. 592 mourns the loss of the aforesaid departed brothers, as they have proved themselves tried and true trade unionists for as throughout the storms and trials undergone by our organization; and,

Whereas, We have suffered their loss at a time when the members of Osage Lodge No. 592 are engaged in a bitter struggle to maintain the wages and conditions we have fought for in the years gone by, thereby making our tribulations greater at a time when we are struggling for victory in a

fight forced upon us by seven of the largest firms erecting work in the oil fields of Oklahoma; therefore be it

Resolved, That we extend to the relatives of our late departed brothers, our heartfelt sympathy in the sad hour of their and our bereavement, that a copy of these resolutions be sent to the relatives of our departed brothers, a copy be spread upon the minutes and a copy sent to our official Journal for publication, and that our charter be draped for a period of thirty days.

JOHN J. LAWLER,
ERNEST B. AWAIN,
RICHARD LEAHY,
JAS. DONOHUE,
ED SHEEHAN,
Osage Lodge Committee.



A GROUP OF SOME OF MEMBERS OF LODGE 471, CRISTOBAL, C. Z.

Paraiso, C. Z., Pan.

Dear Sir and Brother:

Inclosed herewith a photograph of a group of boiler makers, all brothers of Local No. 471, Cristobal, C. Z., Panama, reading from left to right, top row: Ben Crozier, Tom Bozarth, Walter Jones, Victor Z. McMullen, Former Secretary Benedict, Peter Ender.

Bottom row: Andrews, P. C. Whitie, R. H. Van Hoose, Louis Dittmer. Taken in Plaza in Colon, Republic De Panama, a few months past, and thought I would send it up for publication as some have returned to the States.

With best wishes to the whole old gang, also to the fraternity, I remain

R. H. VAN HOOSE.

Livingston, Mont., April 10, 1915.

Dear Sir and Brother:

I must again ask space in our Journal as a matter of personal privilege, in answer to the various brothers who seem to think I am Lodge No. 123, or at least the head of a machine that controls it, and proceed to give me a personal lambasting, because I have committed the heinous crime of daring to criticize Grand Officers and a convention that I and others believe was dominated by them. If I had written articles criticising McNeil or Dunn during their term of office I would have got the same

dose; yet if someone had dared to investigate and expose them, how much trouble, scandal and shame would have been saved our Brotherhood. I do not consider Grand Officers our masters, but our servants, hired to do our work, and open to criticism for all acts when officially engaged. So their and their friends' sarcasm and ridicule is wasted on me, as I had no idea they would agree with me. Now it is the common practice for those accused of wrong doing to make a big fuss, enter general denials, accuse their accusers and kick up such dust that the true issue is lost sight

of, but it won't work this time. Neither Lodge No. 123 nor myself are on trial. When we are, let them come; they will find us waiting.

President Wilson said in a speech: "The Nation is not fed from the tops, but it is fed from the inconspicuous people up." This applies to a union, as well as a nation. Brother Flynn of Lodge No. 154 will not give me credit for trying to be fair and just, nor would he give anyone else who disagreed with him. I would say to Brother Flynn that I have voiced the sentiments of the "rank and file" the same as he or others who write articles on question they are interested in, no more and no less.

Now as to the "unfortunate tourists" of Brother Flynn's, I have many friends among them, as 33 years at this trade in various sections where they abound has convinced me they are no different than other brothers except they like to travel and they have a change oftener. I have met many of them in the last six months and everyone agrees with me, and many talk more bitter than I do. I have never turned one down that floated along, nor does Lodge No. 123, as we maintain ple cards at four different points all the time, and many "boomers" have told me stories that do not agree with Brother Flynn's of the generosity of Grand Officers. I have not figured out the per cent, per member, per year, like Brother Flynn, nor do I care to, as it is not the question. Perhaps the mathematical brothers can figure out the per cent, per member, per week, that is still owing the brothers who gave up jobs on the I. C. and Harriman Lines to become "unfortunate tourists" for the benefit of organized labor. I consider that a moral debt that had better be paid before increasing salaries of those who were drawing steady pay during that time, patting the brother on the back, telling them to stick to it, we are bound to win, and finally stopping the benefits of the few who were not discouraged, but continued to fight, hoping these "well appearing" men were true prophets. About \$160 that would be due the writer at \$7 per week would look good to him now, and I gave up a job that was paying \$145 per month to be called a knocker, ridiculed and slurred by these high brows, because I am exercising my right to fight what I consider wrong, an injustice to our members and a menace to our Brotherhood. But we cannot suppose a General Organizer of the A. F. of L. like Brother Flynn to understand such a figure, as it would be wrong to pay brothers thusly, but it is better that he and others go riding over the country in Pullmans, eating in diners, stopping at the best hotels and asking for more salary on the strength of the flexibility of their jawbone and "dignified" appearance.

If I were to be robbed, I would as soon that a sneak thief would do it as a hold-up; the effect is the same. Brother Flynn gives his deduction of my motives; now my deduction of his article is that we would

sing a different tune if his commission as a General Organizer of the A. F. of L. was canceled, and he would become an "unfortunate tourist." But no danger, as professional union men of this type generally have a finger in some treasury where material for a machine is needed.

Now Brother Bingham of District No. 23 has his slam at me and No. 123. Some of his articles are logical, but the silly, absurd talks of Grand Officers having to eat at soup houses, free lunches and travel in box cars is all rot to those who know they are allowed \$3 per day for hotel bills and legitimate expenses. When we see expense accounts of \$3 per day for the calendar days of a month, then several items of Pullman fare, meals in diners, all totaling many dollars extra, we wonder how a man can sleep in a Pullman, eat in a diner and at the same time have \$3 a day bill at a hotel. It is out of the question; it can't be done except on an expense blank with a pencil. President Franklin has to O. K. such expense accounts to make them payable, and does it. When Vice-President Merrigan took charge in Canada, his reports showed hotel bills of \$2 and \$2.50 per day, but someone must have written him a letter, or put him wise, for his next reports show that all the hotels charged him \$3 per day at the same places where they charged him \$2 and \$2.50 the preceding quarter. Now, don't take my word for a bit of this; get the expense accounts from our secretary each quarter, look up the old ones and see if I am lying or "trying to give a wrong impression to our members in order to bring our Grand Officers in disrepute." Seeing is believing; look for yourselves; think for yourselves, and don't take the blarney of professional hot air artists for facts.

If Brother Bingham really wants proof of the short haul Pullman lines, let him look up the reports for the last quarter of 1914 and not rush into print disputing a man who knows whereof he writes. I never knew before that a man to have brains that would be useful in official positions, to meet employers, had to have the appearance of Apollo or the dignity of an old world monarch. I supposed such men were chiefly for high society functions. I stand corrected, Brother Bingham; I will never vote for a man for official position until he produces a certificate from a court of beauty. But I have known men of different unions and holding official positions, who seemed to deliver the goods, yet they did not strike me as \$10,000 beauties. Now as regards raising salaries, I believe it should be done by referendum, not by a convention representing about one-fifth of our Brotherhood. Our referendum law is too unwieldy, and made that way by the enemies of referendum, because under referendum a machine is not possible, and the men who pay the dues, make the laws, and not a hand-picked law committee. The machinists have adopted that plan of doing business, and who will say their order is not progressive, im-

proving and initiating more up-to-date ideas than we are with our out-of-date plan of doing business. We need referendum, but not referendum hampered by laws designed by its enemies to defeat its usefulness. I expected to hear from Brother Bingham, as he was an important part of that convention, and I did not expect him, or any of the rest of the machine, to acknowledge its existence.

Now, brothers, I should nearly fill the Journal if I endeavored to reply to all of Brother Hinzman's article, so I will only touch on it. He quotes a portion of my argument at the Railroad Department convention, and endeavors to show a veiled threat therein. Now I will trust the brothers who are not blinded by prejudice to discern the difference between a threat and a warning. I resent the insult to Lodge No. 123 in his statement of my inducing 75 members of Lodge No. 123 to indorse the resolution. I or no one else can make the members of No. 123 vote for anything they don't want, and if the dear brother thinks he can, I extend him a very cordial invitation to come and try it. Now, dear brothers, you know better, you have met other members of Lodge No. 123 and know they are not the kind of men who are led around by the nose by anybody, but a bunch who take an active interest in the affairs of our Brotherhood. Have you a better lodge on the roster, that keeps its accounts better, takes a larger interest in all union matters or takes less time of our Grand Officers? We have not had a visit from a Grand Vice-President for nearly two years, yet they have been all around us and through this city. Still, we exist and have good meetings.

Now as to my being an expert machine man, I remember having to rise to a point of order at the Railway Department convention at Kansas City, and object to Brother Hinzman voting on vive voce vote, when he was not entitled to a vote, but wished to defeat a pending motion, and his gentle voice counts some in a vote of that kind. Then to talk of me instructing him in machine politics. Why Boss Croker of Tammany Hall fame had nothing on him. And now a word to you, Brother Hinzman. I will put up my hammer when the men who pay the dues control our union and all its business. It was the fault finders who were not satisfied with conditions, who made our union possible; it was the fault finders who caused its advance, and it is the fault finders of today who are not satisfied to remain tied to the HAS BEENS and who will raise it out of the rut of self-satisfaction, and place it abreast of the times. This Rip Van Winkle period is getting very tiresome. If I am violating the laws of our Brotherhood, prefer charges, but no one can intimidate me. My closing advice to all brothers is: Read your Journals, read the quarterly reports, also the executive council proceedings, and keep track of things. I do not wish to dictate to a solitary member how

to vote, but wish them to know the truth before voting. "Eternal vigilance is the price of liberty," and this applies to unionism as well as politics.

Fraternally submitted,
C. J. MAES of Lodge No. 123.

Dear Sir and Brother: Danville, Ill.

Lodge No. 22 has sent out raffle tickets on a watch to get Brother Thompson an artificial leg.

We would like to have you print a notice in the next month's Journal, notifying all locals who have not as yet sent in their stubs or money or the tickets please do so, as we would like to hold the raffle the first of June, but if it is too late to be printed in the next Journal, we will have to hold it for the first of July.

Hoping I have made this clear enough and expecting an early reply, I am

Fraternally yours,
W. J. IRWIN, C. S. L. 22.

Cristobal, C. Z., Pan.

Dear Sir and Brother:

I was advised by our local to write you about some men here on the Isthmus who have come down here below the standard scale of wages (60 cents per hour), and some have a card; they came down here as riveters and caulkers. They are getting the men here for 60 cents per hour, first class men; we are trying to uphold the scale of wages here and there men come and tear it down.

We would like very much for you to put a notice in our Journal about this matter of men coming down here for that money.

Hoping you will do this for us, I am

Yours respectfully,
C. S. LODGE 471.

A COMMUNICATION FROM THE METAL TRADES DEPARTMENT.

Washington, D. C.

To the Internationals.

Greeting:

The secretary of the Bridgeport Metal Trades Council writes us that the Bridgeport Arms Co. of that city is increasing the size of their plant so that they can better and more capably handle the orders that they have for munitions of war. He also calls to our attention the fact that advertisements are appearing in the local papers which largely exaggerate the true conditions of affairs at Bridgeport. These articles, of course, are inspired by the manufacturers and the result of such advertising is for the one purpose of overcrowding the city with mechanics, and I am informed that there are a great many men of the metal trades out of employment at the present time.

I would suggest that mention be made of this fact through your journals to your membership so that the conditions in Bridgeport will not be made worse than they are by an over supply of workers from which the manufacturers can draw from and as a consequence perhaps reduce the wage rate.

With best wishes and hoping you will give this matter your earliest attention, I am
Fraternally yours,
A. J. BERRÉS,
Secretary-Treasurer.

Roanoke, Va.

Dear Sir and Bro:

At the last regular meeting of Melrose Lodge No. 29, the following resolutions were adopted:

Whereas, it has pleased the Almighty God to remove from this world of trials and sorrow our beloved Brother, D. B. Baker; therefore, be it

Resolved, That we, his fellow brothers, extend to his wife and daughter our heartfelt sympathy, and pray that God, the great Creator who doeth all things well, may be ever ready to comfort and console them in the hours of bereavement and sorrow, and give them confiding hope that his spirit has departed to a better and brighter sphere where sorrow is unknown; and be it further

Resolved, That a copy of these resolutions be sent to the family of Brother Baker, a copy be sent to the Journal for publication and a copy be spread upon the minutes of our meeting.

Fraternally in sympathy,
J. F. MURRAY,
H. D. MAUCK,
Committee.

Wichita, Kas.

Whereas, It has pleased the Almighty God, in His infinite wisdom, to remove from our midst the beloved mother of our worthy and esteemed brother, Joe Ringey; therefore, be it

Resolved, That we, his fellow brothers, extend to our brother our heartfelt sympathies in this sad hour of bereavement, and as we bow in humble submission to the will of Him who doeth all things well, we pray that the Almighty God may comfort and console him that he may bear his trials with fortitude; be it further

Resolved, That a copy of these resolutions be sent to our bereaved brother, and a copy be sent to the Journal for publication.

Fraternally in sympathy,
S. F. SLOAN,
PHIL DUNN,
H. B. LING,
Committee.

Lafayette, Ind.

At a special meeting of Star City Lodge No. 36 (360 O. I. B. of B. M. I. S. and H. of A.), the following resolutions were adopted:

Whereas it has pleased Almighty God in His infinite wisdom to remove from our midst the mother of our esteemed Brother, Charles Hentze; be it

Resolved that we extend to the bereaved family our sincere and heartfelt sympathy in this hour of affliction; and be it resolved that a copy of these resolutions be sent to the family of the deceased and a copy be sent to our Journal for publication and also a copy spread on the minutes of our next regular meeting.

WM. H. CASSMAN,
FRANK L. BONGEN,
WM. MATTHEWS,
CHAS. LAHRMAN,
JACK HALPIN,
Committee.

NOTE:—The following night letter was received from Brother T. C. Maddy, a delegate from Lodge No. 587, Beaumont, Texas, to the State Federation of Labor in session at Austin the contents of which is self-explanatory.—The Editor.

Austin, Tex., April 20, 1915.

J. B. Casey, Room 8, Law Bldg., K. C., Mo

To all Boiler Makers:—I am in Austin, Texas, attending State Federation of Labor; can say that we have been tendered hall of Representatives for our entire meeting; something that is unparalleled in history; please publish. Will make full report to the national secretary of No. 507, Beaumont.

T. C. MADDY.

A Compilation of Labor News.

BY THE A. F. OF L. NEWS SERVICE.

UNIONS GIVE GREATEST AID.

Toronto, Ont.—The Industrial Banner of this city is one more trade union paper that hits the nail on the head in its following summary of the value of organization:

"After all is said and done, there is nothing more certain or easy of proof than the assertion that trades union organization has accomplished more in safeguarding the rights of the working class than all other agencies combined.

"The craft that has a 100 per cent organization in any industrial center is more potent to force the concession of reasonable hours and a living wage and to maintain them, even during periods of business

depression, than the best fair wage clause that was ever enacted by a municipal council.

"While it may be true—not in Toronto, however—that when properly enforced a fair wage clause may force even unfair contractors to pay the prevailing rate of wages, the said prevailing rate is first fixed and enforced by trades union organizations.

"Where the labor unions are weak, the prevailing rate is bound to be correspondingly low, and even an efficiently enforced fair wage clause cannot secure to the wage-earner a higher scale of remuneration than the weak organization existing is able to enforce.

"Where organization is weak the hours of labor are long and the prevailing rate of wages are low, and where organization is strong it naturally follows that shorter hours and higher wages must necessarily follow.

"No fair wage clause ever seeks to do more than enforce the prevailing rate that organization has already won.

"Every craft that is in the enjoyment of the eight-hour day has secured the boon, not through the good will of the employers or the party politicians, but because of the trades unions that have compelled its recognition."

WAGES BY LAW AND LAWYERS.

Sydney, New South Wales.—Protests of trade unionists against a 25 per cent reduction of wages of waitresses has proven effective, and the old rates have been restored.

The reduction was ordered by the government wage board at the request of the Employers' association. At it would be illegal to strike, the workers gave notice they would publish a "fair list" containing names of those places that would not reduce wages to the level of the board's award, which also included workers in tea rooms, although these were not mentioned in the employers' demand. The vigorous protests of unionists and other citizens has forced a modification of the award, and the wages existing before the outbreak of the war have been restored.

The Saddlers' union is also objecting against the policy of this industry's wage board, whose decision has been appealed to the arbitration court, where, it is hinted, it will remain for six months. Last October the saddlers secured a decision providing for a minimum rate of \$15, but its enforcement was postponed for four months on account of the European war. At the end of the four months, the employers asked for a further extension of four months, but the chairman of the wage board made it twelve, despite protests by the workers who showed that this industry was never in better condition because of the demand for war supplies.

Even though New South Wales has a labor government, there has never been a labor man appointed as chairman of a board, declared ex-President O'Brien of the New South Wales Labor Council, who urged that the government be asked to appoint more industrial judges, so that appeals could be considered more speedily. The unionist said: "At present the awards are delivered by the chairman of the wage board and since these men are mainly lawyers, with no sympathy for the workers, as shown by the awards they delivered, it was inevitable that there should be appeals from their decisions."

THE A. F. OF L. EXHIBIT.

San Francisco.—The Bulletin of this city makes this reference to the American Federation of Labor and its attractive educational exhibit at the Panama-Pacific exhibition:

"The American Federation of Labor has grown in thirty-four years from a membership of less than 50,000 to a membership of more than 2,000,000. Its average membership last year was 2,020,671. The average American family is usually reckoned at five members. This would make the total number of persons dependent on the earnings of organized labor about 10,000,000. One person in every ten in our country is intimately interested in the prosperity or welfare of organized labor. Moreover, outside the organized trades, in occupations which it has not been possible to unionize, there are millions of workers whose wages and conditions of work are indirectly influenced by the conditions that have been secured in the organized trades.

"The importance of this united body of workers and voters is apparent even to those short-sighted persons who are opposed to a democratic influence in industry. No one who is not already familiar with the history, principles and program of organized labor should lose a good opportunity now presented, by the Federation's exhibit at the exposition, to become so. The policies of the Federation of Labor are a good deal more important to us than the policies of Great Britain or Germany. If it helps to solve the great problem of peaceful industrial development, as it surely is doing, it is worth sympathetic and broad minded study."

W. U. EMPLOYEES "SPOTTERS."

Chicago.—The Western Union Telegraph company not only maintains a "spotter" system, known as a special agents' department, to spy on employes with regard to their union affiliation, but the policy of the company is to fight the union with all the powers at its command, to discharge operators who are members of the union, and to refuse to deal with union officials.

These frank statements were part of the testimony of Newcomb Carlton, president of the Western Union, before the United States industrial relations commission.

The witness made no attempt to conceal Western Union's hostility to unionism, and admitted that hundreds of operators had been discharged for membership in the union and that many of these had been refused employment by certain telegraph companies controlled by Western Union. Equally frank admissions were made relative to the low wage of telegraphers.

President Konenkamp of the Commercial Telegraphers' union followed Mr. Carlton. He showed that the highest rate in New York is \$100 a month. This ranges to zero "for those who work for nothing for several months to get into the service." The witness said increased wages were followed by a "speeding up" order, and that in branch offices operators work up to thirteen hours a day seven days a week. The unionist agreed with President Carlton as to the employment of "spotters," but he went into the detailed workings of this spy system. In answer to the question, "What do you con-

sider is the remedy for these evils?" the union executive said:

"The most important remedy is the right to organize."

"What are your demands?"

"All we have ever asked is the right to organize."



Committee who adjusted grievance for the boiler makers at the Norfolk Navy, with assistant secretary of the Navy, Mr. Roosevelt. Right to left—G. F. Calvert, Thos. Nolan and Geo. J. Thomas.

EVILS OF CONVICT LEASES.

Chattanooga, Tenn.—The state legislature has voted to continue the system of convict leasing to contractors, and the Central Labor Journal of this city says:

"The convict lease system is proven by legislative investigation to be guilty of the following civic crimes: Inhumane treatment of the convicts themselves; deprivation of their families of the support they are entitled to; encouragement and breeding of tuberculosis from close confinement; illegitimate interference with manufacture and industry of the state; unfair treatment of laboring people of the state by the introduction of cheap prison labor in competition with them; depriving the farmers and others of a good public road system by failure to employ the convicts in this connection.

"Contemplate the picture of a thousand

helpless men closely confined in cramped quarters, the germ of tuberculosis rampant among them; one by one they become the victim of that dread germ till the record shows that over 50 per cent of the deaths are from this disease; each man given a man's task, and punished by the merciless lash in the hands of a stalwart guard if he fails in this task; see the loads of merchandise shipped out under these conditions, the product of pauper labor, and bearing the germs of disease into every home; see the bowed and helpless form of the released convicts, after service, returning to their homes, diseased, helpless, bearing the same germs to their neighbors. There you have the picture of conditions under the convict lease system."

HOW "SPOTTERS" SPLIT UNIONS.

Chicago.—Before the United States industrial relations commission, John G. Taylor, business agent of Oakland, Cal., machinists, testified that "spotters" engaged in disrupting unions are generally designated as follows:

1. The promoter of quarrels, who gains membership in the budding union and by his wiles sets Jew quarrelling with Gentile, Italian against Austrian and so on, thus weakening the strength of the membership.

2. The "good fellow," who makes friends with everybody and spends his money so freely that those who try to keep up their end of the entertainment presently find themselves financially embarrassed, and are thus open to suggestions of treachery to the union.

3. The "discourager." This man is a professional pessimist who is tormented with objections to unionism and predicts nothing but trouble for organizations which try to compel powerful corporations to grant the men their rights.

NEW LOAN SHARK BILL.

Harrisburg, Pa.—A new loan shark bill, aimed to correct the flaws the supreme court recently pointed out in declaring unconstitutional the statute of two years ago, has been introduced in the state assembly.

The bill regulates the loaning of money in sums of \$300 or less, either with or without security. In the preamble it is asserted that because of extortion on the part of loan sharks borrowers often have to pay interest and other charges to the extent of between 100 and 300 per cent or more; that through intimidation and ignorance borrowers have to pay many times the amount actually due. Those engaged in the lending business after the passage of this act would pay a license fee of \$50 and transact their business under the supervision of the state banking commissioner. A \$5,000 bond would be required. Interest charges would be, up to \$100, 3 per cent a month; between \$100 and \$300, 2 per cent a month; in addition to which there would be a small examination fee. Charges in excess of these figure would entitle the borrower to recover the excess

and to receive a \$50 bonus, which would be a penalty on the lender. Drastic penalties are provided.

R. R. OFFICIALS CONSCIENTIOUS?

Chicago.—According to President Markham, of the Illinois Central railroad, officials are conscientious—they are guided by public opinion and the welfare of the people. And because officials of federations of labor unions are not responsible to the people and are not answerable to this "moral tribunal," President Markham is against them. This was brought out at the hearings of the United States industrial relations commission in this city. Mr. Markham favors large corporations, because they can better serve the people, but if labor unions get too powerful, they are liable to exercise their power unwisely, he says. Public opinion, however, will hold the corporations in check, avers the Illinois Central man.

At this point in the proceedings some of the unionists present indicated a desire to laugh, but were hushed by several stern raps of the gavel, vigorously wielded by Chairman Walsh.

OPPOSE 15 CENTS AN HOUR.

Columbus, Ohio—Agitation by Columbus trade unionists against a rate of 15 cents an hour for a 10-hour day for unskilled labor by a construction company resulted in a resolution of protest being passed by the city common council, which called on the company "to pay at least 28½ cents per hour for such labor, and that the laboring men of this city be requested to refuse to work for less than 28½ cents per hour, which is the standard established by the city of Columbus."

Unionists are now organizing these unskilled workers and the publicity that has resulted has aided the organized movement in general.

LAWYERS PAID \$294,113.

Boston, Mass.—During the past four years the Bay State Street Railway company has paid lawyers \$294,113 for "retainers" or "retainers and services." This was brought out at the arbitration hearings of wage demands of the company's employes who rejected an offer, last fall, of one-half a cent an hour increase. James M. Swift, counsel for the company, assured the board that these payments to lawyers were "quite modest" when one considers the Bay State is a \$50,000,000 corporation. A few days before this evidence was made public Mr. Swift told the arbitration board that the workers were making an "appalling demand."

DAN HARRIS HAS PASSED AWAY.

Brooklyn, N. Y.—The announcement that Daniel Harris, president of New York State Federation of Labor, is dead, will come as a shock to organized workers throughout the country who knew this sterling trade unionist. He passed away last Monday, after an illness of several months. The direct cause

of death was blood pressure, which affected the throat. His illness was aggravated by a refusal to obey physicians' orders and abandon all trade union activity. Last year deceased secured some relief through a trip to the southwest, but the antagonism of the New York legislature against compensation and other labor laws found the old war horse again in the fight, which proved his last, and which caused him to really "die in the harness." He was 68 years old.

Deceased was a member of the Cigarmakers' union and held many offices in that organization. He was a trade unionist to the core and believed there was no limit to the possibilities of workers through agitation, organization and education. His death removes one more from the small circle of trade unionists who are as active today as they were 35 and 40 years ago.

PORTERS MUST LIVE ON TIPS.

Chicago.—The United States industrial relations commission is conducting the first government inquiry into the wages and conditions of employment of sleeping car porters and conductors. General Manager Mungerford, of the Pullman company, testified that porters receive \$27.50 a month for the first fifteen years. At the end of that time the rate is increased 5 per cent, making his pay \$28.87 a month. In the first ten years of service he buys \$36.50 worth of uniforms a year, but thereafter the company pays for uniforms. The witness said he did not know whether porters were dissatisfied with these low wages, as the company had "received no expressions of dissatisfaction regarding them." Porters are permitted to retire on the trains at 11 or 12 p. m. and must go on duty at 3 a. m. This applies to all trains. In answer to the question whether \$27.50 is enough to pay a man for a month's work, the general manager said: "We can get all the men we want at that rate."

RAILROADS ARE NOT SO POOR.

Chicago.—Wayne C. Ellis, statistician of the Iowa railroad commission, is not impressed with the poverty tales of railroad managers. While protesting to the interstate commerce commission against increased rates for the benefit of western roads in Iowa, Nebraska, North Dakota, South Dakota and Minnesota, which, he said, were earning from 6 to 16 per cent.

"All of the roads in this territory," he continued, "were able to pay their operating expenses, taxes, interest on bonds and debts, dividends on preferred stock and had enough left in 1914 to equal 8.76 per cent on their stock outstanding in the hands of the public. In 1913 they earned 10.68 per cent on the common stock."

The witness explained that his averages were obtained by including the non-dividend paying roads with those regarded as prosperous.

BISHOP PLEADS FOR BOYHOOD.

Los Angeles.—“The boy must not be robbed of his boyhood. It is essential to his advancement. To crush him down in a factory is one of the greatest crimes a civilized nation permits men to do,” said Bishop Edwin N. Hughes, of San Francisco, in a speech in this city.

“The boy is the true ‘Jack of all trades.’ During the course of his boyhood, and at various stages, he has ambitions to be first one thing and then another. One day he will wish to be a carpenter, the next day to be an engineer, and so on. These desires are the result of the things he sees, and the boyish mind is thrilled.

“The boy is one of the greatest problems confronting us as individuals and as a nation. The only way in which a father may understand his own son is to first try to understand his own son’s father when he was the same age as his son.”

DEFEAT CONTRACT SYSTEM.

Jefferson City, Mo.—Through organized labor’s activity, the state legislature defeated a bill to extend the contract system in convict labor in this state. The workers not only defeated this bill, but secured the passage of a law which abolishes the system and inaugurates the state-use system.

Other legislation secured is:

Miners’ bath law.

Empowering state miner inspector to close dangerous mines.

Making it easier to prosecute imitators of union labels and shop cards.

Providing for better sanitary conditions in foundries.

Labor secured the defeat of a bill to repeal the barbers’ state board of examiners, and lost in their efforts to secure a workmen’s compensation law.

EIGHT-HOUR DAY UPHELD.

Cleveland, Ohio.—Common Pleas Judge Lieghey has upheld a municipal court decision that contractors engaged on city work are legally limited to an eight-hour day. The case was against the superintendent of a construction company, who was fined \$500 and sentenced to sixty days in the workhouse, and who appealed.

SETBACK FOR LABOR AGENT.

Washington, D. C.—Leroy Brazee, a Detroit employment agent, received a setback in the United States Supreme court, which refused to issue an injunction against the Michigan authorities to restrain them from enforcing a law regulating employment agencies. Brazee is facing a sentence of 90 days in the Detroit house of correction for violation of the law.

HOLD SEAMEN’S ACT IS EFFECTIVE NOVEMBER 4.

Washington.—Attorney General Gregory has decided that the seamen’s law passed by the last Congress shall become effective November 4, and not July 1, of this year, as

had been held by the department of commerce.

Steamship owners have overwhelmed the department of commerce with protests against enforcement of the act July 1, claiming that it would be impossible for them to so equip their vessels as to conform with the act by that time.

They claimed, also, that they had been assured by committees of Congress that the law would not become effective until November.

Attorney General Gregory held the law as it affected foreign vessels shall not become effective until March 4, 1916. This delay is given in order to permit the Senate to amend treaties where necessary.

HOW ABOUT REPUTATION.

Des Moines, Ia.—The house of representatives has passed a bill which provides that the state shall compensate persons found to be innocent of crime after they have been imprisoned, for the time that they spent in prison. Compensation is to be fixed on the basis of the amount earned if the person was free.

DENIES RIGHT TO PICKET.

Lenoir City, Tenn.—The need of a state anti-injunction law, similar to the recently enacted federal Clayton act, is shown by the order of Chancellor Kyle in the case of striking textile workers and the Holston Manufacturing company, which secured a temporary injunction and which is now made permanent. Under its provisions the strikers are permitted to ask non-unionists to join them, but they are not allowed to picket or urge non-union employes to quit the service of the mill management.

The strike was caused by discharges when a local of textile workers was formed. The workers say conditions were unbearable and they were forced to unite.

SECURE ELEVEN NEW LAWS.

Austin, Tex.—Eleven new laws is the result of labor’s activity before the state legislature, just adjourned. Included in the list is compulsory education, abolishing the business of loan sharks, providing for the printing of text books in Texas, improved fire escape law, preventing private employment agencies becoming recruiting stations for strikebreakers, 54-hour law for women and a law giving communities the right to give school children free text books if they so desire. The mechanics’ lien law was changed, and now makes it more satisfactory to the worker and the material men.

CHANGE ATTACK ON SCHOOLS.

Chicago.—It appears that the attempt to divide public school in this state has failed. A new plan is now being advocated to establish a dual system of schools in Chicago by appointing a superintendent of vocational education, independent of the regular school superintendent, and with full power over a special department to be known as the “de-

partment of vocational schools." Trade unionists are opposing all these theories, as they see in them attempts to segregate the children of workers into vocational

schools, while those whose parents are more fortunately provided with the means of life will secure the usual public school education.

Among Our Exchanges.

UNIONISM IN CANADA.

A "patriotic" Canadian employing class has failed in its attempt to destroy real trade unionism in the land of the Maple Leaf.

For years the shrewd Canadian employers have favored "Canadian" trade unions.

But the "Canadian" trade unions have failed to arouse the false cry of patriotism in the breasts of Canada's toilers.

The Canadian workers are more interested in protecting themselves than in lip service to the false god of nationalism.

The government statistics, which in no way favor real organization of the working class, tell the story of the fall of the "Canadian" union and the rise of the American Federation of Labor.

In the last two years the international unions gained 191 local unions in Canada while the national unions lost 26 locals.

There were only 133,132 trade unionists in the Dominion in 1911, while last year there were 175,799.

Of the 175,799 Canadian unionists, 149,577 were members of the American Federation of Labor.

Only 26,222 men and women were enrolled in non-national unions.

But all these, 26,222 men and women, did not worship at the shrine of folly.

The Canadian Federated Letter Carriers, with several thousand members, is affiliated with the Trades and Labor Council of Canada. It is recognized and assisted by the international movement.

Several other independent organizations favor the international movement.

The Canadian Federation of Labor is on its deathbed.

It is so weak that it cannot hold a convention.

Last year it held no convention.

Patriots who want to build a wall around Canada so that the Canadian people cannot trade with their neighbors and their "mother" country do not want international trade unions.

Patriots who own the Detroit street railway and countless other corporations in this country don't want their Canadian employes to belong to an international organization.

They practice internationalism in all their dealings, but neither do they want the Canadian people to trade with their neighbors nor the Canadian toilers to unite with their brothers and sisters on this side of the border.

But Canadian workingmen and workingwomen are mangled by machines which are just as heartless as the machines which mangle their brothers and their sisters in the United States.

So Johnny Canuck does the only sensible thing. He joins the union of his class.

He has derived much benefit from his entrance into the international fold.

He has also aided the international.

Secretary Frank Morrison, of the American Federation of Labor came from a Canadian farm; and several international presidents and many general organizers of international unions were born in the Dominion.

The trade union was not formed in order that its members might indulge in mutual admiration.

The trade union was formed for self-protection.

Canadian workingmen and Canadian workingwomen know that they have everything to gain from the American Federation of Labor.

This is why they join it.—The Detroit Labor News.

REAL LIGHT.

Postmaster General Burleson is giving the American people some facts in very clear terms about the oft-repeated charge that the railroads are being cheated in the transportation of parcel post matter. Mr. Burleson says:

"Although the railroads contend that they are underpaid for carrying the mails, the facts are that they are overpaid, and that they are receiving from the government amounts which for hauls of any considerable length, exceed by about two to one the amounts they receive from express companies for like and similar service."

And Mr. Burleson backs up his words with the figures:

"Upon the two principal mail routes from New York to Chicago, over which is carried the largest daily weight of mail transported anywhere in the world by rail, aggregating about 319 tons daily; railway mail pay amounts to \$2.58 per 100 pounds, while the railroads' proportion of the first-class express rate between those cities is approximately \$1.20 per 100 pounds."

No man does a greater service in the interest of public and of business than shedding light. The American people are not disposed to treat the railroads unjustly. Why should they be? Their prosperity is interlinked with that of their industries. But they do like to know that they are being treated fairly in turn. Mr. Burleson puts his point clearly; he gives his figures to back it up. If an answer is to be made, it, too, must deal in facts.—The Milwaukee Journal.

CAPITAL AND LABOR ARE PARTNERS.

They do work for each other. Too often, however, the Capitalist has allied himself with Monopoly, and as an individual he assumes the power of Monopoly under the guise of Capital. And the Laborer, discriminating no more between the two than the Capitalist himself, bitterly resents this assumption of superiority. The direction of industry, and the management of affairs, is assumed entirely by the Capitalist; and while he realizes that he himself is helpless without the co-operation of Labor, he knows that Labor must bow to immediate necessity, and so yield to his dictation. The remedy for this state of affairs does not lie necessarily in Labor's control of industry; but it does demand that Labor be so independent that the worker can freely withhold his services from any enterprise of course that does not meet with his approval. Capital today dictates terms to Labor, not as Capital, but as Monopoly. Destroy the Monopoly, and Labor and Capital will stand upon an equal footing. For, if the natural opportunities for industry be thrown open alike to Labor and Capital, Labor will be freed from the necessity of accepting the preferred terms of Capital; and will be able to negotiate as an equal. The Capitalist being deprived of his present privilege, and compelled to deal with laborers who are not under the immediate necessity of working for him, will be obliged to share, not only the product of the joint efforts of Capital and Labor, but the honor and responsibility as well.—The Public.

FREEDOM'S BATTLE WON.

On Thursday, March 4, at about 9:30 a. m., the good news arrived at San Francisco that the Seamen's battle for freedom had been won—i.e., that President Wilson had signed the Seamen's bill.

Throughout the country the same good news was disseminated by the afternoon papers of that day.

March 4, 1915, was truly a day of rejoicing. All will agree that there was ample reason for rejoicing. In the language of Senator La Follette, the noble champion of the Seamen's cause, March 4, 1915, should be fittingly described as "the Seamen's Emancipation Day."

It has been a long and weary struggle—a contest that might well exhaust the patience of the most enduring and persevering of mortals.

From January, 1892, to March, 1915, the organized seamen of America have struggled and striven in the legislative field, always using their very best efforts to secure that measure of justice so long denied and and only just now secured.

During the years in which the Seamen's hearings and conferences upon the legislation bill has been pending in Congress, boys have grown into manhood and men have reached the declining years of life.

There have been more investigations and hearings and conferences upon the legisla-

tion asked for by the Seamen than on any other subject that ever engrossed the attention of Congress. The various Congressional committees, sub-committees, conference committee, etc., have each in turn referred, re-referred or harbored, sheltered and housed the bill for periods varying from days to months. Nearly every pigeon-hole in every committee room where maritime affairs are considered has at some time or other served as a resting place to the Seamen's bill. The volumes of printed matter issued with regard to the question, involved in the Seamen's bill if placed side by side and measured with a lead line would run well up into the 'steenth fathom mark. The actual time consumed by the various sessions of Congress in which the Seamen's bill received consideration, if measured by a monetary standard, would exceed several of the largest fortunes rolled into one.

But why relate or dwell upon the past? The fight has been made and won—

For Freedom's battle once begun,

Bequeath'd by bleeding sire to son,

Though baffled oft is ever won.

Freedom's battle has been won, and after Nov. 4, 1915, when the La Follette Act is in effect, as far as American shipping is concerned, the American seaman will stand relieved from any criminal proceedings for violating a contract to labor. In a word, he will be in exactly the same position as other workmen. And after March 4, 1916, when the Act takes effect with regard to foreign shipping at American ports, the seaman on foreign ships will enjoy the same blessings of freedom so long as they are in American ports.

As for the other important features of the La Follette Act—and there are many—it behooves every seaman to thoroughly familiarize himself with the changes and the improvements made upon existing statutes.

Without the intelligent effort of each individual seaman and the loyal backing of his economic organization, it will be utterly impossible to reap to full advantage the benefits of the new Charter of freedom.

Comrades of the Pacific, the Lakes and the Atlantic, it is necessary now, more than ever before, to attend your union meetings. It is essential to bring in every straggler not yet within the fold and, above all, remember the words of Daniel Webster:

"God grants liberty only to those who love it, and are always ready to guard and defend it."—Coast Seamen's Journal.

THE SHOE PINCHES.

Criticism of the Federal Industrial Commission and its chairman, Frank Walsh, would carry more weight if they bore less evidence of being prompted, by the spirit which denies the government any right to scrutinize business methods from the point in view of the best interests of society.

Though some of Mr. Walsh's critics may be sincere in saying that their objections to the commission are based on the chairman's methods of directing its work, most

of them are in arms because the commission has brought to light unattractive facts regarding the treatment of labor in many of our largest industries.

Had the commission gone noiselessly about its work, carefully skirting the edges of the condition known as industrial unrest, taking the easy roads and avoiding the rough ones, it might at this moment have the good will of the interests which are now denouncing it. It is because it has done the work which seemed to it necessary that it has brought upon itself this flood of hostile criticism.

The outcry against the commission and Mr. Walsh is the wincing of the "galled jade."—The Milwaukee Journal.

THE HYGIENE OF GAS LIGHTING.

When an innovation in the industrial world tends to replace some older, long-established practice, one frequently sees a vigorous defensive response on the part of the supporters of the process that is being outdistanced. This reaction usually rounds to the advantage of all concerned. It spurs the losers to renewed effort to regain lost prestige, and the end-result not infrequently is the discovery or invention of novelties which improve the condition of existence and reduce the cost of living. As a specific instance of such commercial rivalry, which is widely reflected in the affairs of everyday life, the competition between gas and electricity may be mentioned. Usually the determining factor in the use of two sources of energy for heat or light effects is a purely economic one. Electric lighting, when once perfected to a stage where it became an efficient and reasonably economical process, threatened to supplant gas lighting within doors for purely hygienic reasons. The pollution of the air by the products of incomplete or complete combustion of the illuminating material is avoided by the electric light. Large quantities of hot combustible gases are not formed and need not be removed. The contrast in the conditions that may be brought about by the two systems is too obvious to require a detailed description. The defenders of the modern systems of illumination with gas have advanced certain considerations quite independent of the relative intensity and quality of the light produced. They claim that the great production of heat in gas-light fixtures brings about a natural ventilation effect through the air currents it produces, so that the products of combustion, notably carbon dioxide, are never allowed to accumulate unduly in the atmosphere, and an excessive rise in temperature is also prevented by the movement of the air. To this has been added the statement that, with gas lighting, the micro-organisms of the air in the rooms involved are destroyed by the flame itself and likewise by the traces of combustion products like sulphurous acid which exhibit an antiseptic action. The allegations in respect to the effect of gas lighting on the bac-

terial contents of the air have been investigated in the Hygienic Institute of the University of Munich by Ahlborn. In a room of 57 cubic meters' capacity under uniform artificial circulation of the atmosphere, the number of bacteria in the air decreased 24 per cent in one hour. Under precisely comparable conditions, including the presence of three large gas-light flames with open globes, the number of micro-organisms decreased 40 per cent in the same period. This increased destruction of bacteria is undoubtedly attributable to their burning up in contact with the incandescent surfaces or their destruction by the heated gases that are produced. The point for emphasis, however, is the fact that such differences, amounting at best to only 16 per cent, are too small to possess any serious significance from the point of view of practical hygiene. The argument for the superiority of gas lighting in this respect can scarcely be maintained.—The Journal of the American Medical Association.

LABOR SHOULD BE CONTENT.

The forces of organized labor in Texas have every reason to be proud of the record achieved by the 34th legislature; in the wealth of salutary labor measures passed this legislature has probably distinguished itself over all others.

Compulsory education, long fought for and long desired, has at last become a law in this state.

Free school books in any school district of the state where the residents of that district vote for it.

The text-book law, providing that all school books used in the public schools of Texas shall be printed in Texas.

The regulation of private employment agencies which means the elimination of traffic in human misfortune.

A semi-monthly pay day for all establishments employing more than ten persons.

Extension of the masonry inspection law to include state inspection of public buildings of counties, towns and cities.

An amended mechanic's lien law giving absolute protection at minimum cost.

Extension of the 54-hour law for women to include cotton mills and textile factories.

A law making compulsory the installation of bathhouses and lockers for coal miners.

A law limiting the operation of "loan sharks"—long fought for by organized labor.

Vive, the legislature!—El Paso Labor Advocate.

ONE OF THE MOST PECULIAR PEOPLE IN WORLD.

Washington—Europe has still today one utterly peaceful people, peaceful in action, in intent, and of peaceful contemplation, according to the National Geographic society. This race is one of the most peculiar peoples in the world's history—the gypsies.

Entering into the life of all nations under the sun, yet a part of no single one;

mingling themselves within the highest civilizations, yet unlettered; pilgrims upon an eternal wander path, yet forever true to the ties of racial blood and to customs whose origin and significance have been fully forgotten, the gypsy is the most mysterious of all the strange elements of folkdom.

The Children of Cain?

Whence they came has never been settled to a certainty. All manner of fables have been spun to explain their origin. Since they first appeared upon the stage of Europe in the middle ages, they have been identified with the lost tribes of Israel, the mixed multitude that followed Moses out of Egypt, the Canaanites, the Amorites, the Saracens and the Egyptians. Some have held them to be the children of Cain, and others have decided that they were the children of the Wandering Jew and inheritors of the restless curse of their father.

The gypsies, themselves, have never professed to know who they were or where they came from, but they have shown great readiness to accept the conclusions on this subject of the people among whom they lived. It was not until the growth of comparative philosophy and the chance investigation of the gypsies' tongue in the beginning of the last century, that scientists concluded the gypsies to be a wandering low-caste tribe from northern India. Their language nearly resembles Sanscrit, the foundation tongue of all our western languages which has held itself purest in Indian sources.

Language Is Unwritten.

This language they have wonderfully preserved in the face of over-mastering cultures and eternal wandering. This has not been accomplished by a literature or by a close corporation. The gypsies have no literature, and their language is an unwritten one, while they, themselves, are scattered in small bands over the whole face of the earth, scattered even more widely than the Jew. The gypsy calls himself "rom," meaning man, "the man" of all men." His wife is "romni"; his folk-like is "romnipen," and his language is "roman." Everyone not of his race come under the generic term of "gentile."

Gypsy-folk present the strangest problems known to philology and ethnography. An elementary, nomadic folk persisting for centuries in the midst of complex civilizations, they have retained their physical characteristics, their tribal rules and customs reminiscent of their far-distant, extra European past, their highly inflected language, and their thousand years of fever for roving. They are absolutely singular and without close parallel among the peoples of earth.

Reached Germany About 1417.

They entered Europe by way of Constantinople in the twelfth century, and overflowed into the northern Balkans, Hungary, central and western Europe, England, and thence, to North and South America. The

English called them Egyptians, after their supposed origin, whence the name gypsy. They reached Germany in about 1417 and England about 1500. At first they were treated kindly by the western nations, but their strangeness, their unconventionality, their light-fingered ways, their proneness for fortune-telling, necromancy, black magic, and their unwillingness for work in all forms soon called down upon them bitter persecution in Germany, England, France and The Netherlands. In the Balkans, Russia, Hungary and Poland, they were well treated, and they are found in these countries in great numbers today. It is estimated that Europe has more than 900,000 gypsies.—Milwaukee Journal.

PAYING THE FIDDLER.

There comes a Spartan cry from all over the country from the railroads for permission to increase freight and passenger rates. A thousand and one reasons are advanced why the railroads should be given this right. And yet the real reason why such a condition has arisen has not been touched upon by any of the newspapers or those papers devoted to financial interests.

The reasons are obvious:

When such men as James J. Hill and E. H. Harriman could take hold of a road which in an intrinsic way was worth a few dollars and with glowing possibilities sell millions of dollars worth of stock to an unsuspecting public, and then leave the road to earn the interest charges upon the money which they got and did not put into the betterment of the road, it is not a far cry to chicanery. And yet today nearly ever railroad in the country is carrying millions upon millions of dollars of stock which is not represented by the investment of a single dollar.

Today the railroads are asking the people to permit them to earn interest upon billions of dollars which never went into the railroads.

It does not require a mathematician to figure that if you overcapitalize a proposition you must find a way to pay the fiddler.

And the easiest way to pay interest upon stocks and bonds which are the usufruct of stock jobbing is by saddling the burden upon those who are least able to bear it—the working men and working women of this broad land.

If a railroad had cost some \$50,000 per mile to build, it was bonded at \$100,000, the difference going into the pockets of the "financier," or what is commonly known as "Kings of Finance."

If all the money taken out of railroads by exploiters were to be returned, railroad rates could be lowered and the equipment today would be 100 per cent.

As it is, the railroads have been robbed right and left and the public is now asked to feed the "kitty."

They call Mr. Hill an "Empire Builder." He is. He is more than that. He receives

more than a million dollars for every one that he invested.

Who gave him that money?

The United States Government and the various states through which he operated. And so it was and is right here in Ohio.

Get Poor's Railroad Manual, look it over, and when you have digested just an infinitesimal part you will readily discover who got in out of the wet. Now the people are expected to create a new crop of millionaires.—The Chronicle (Cincinnati, O.)

News of General Interest.

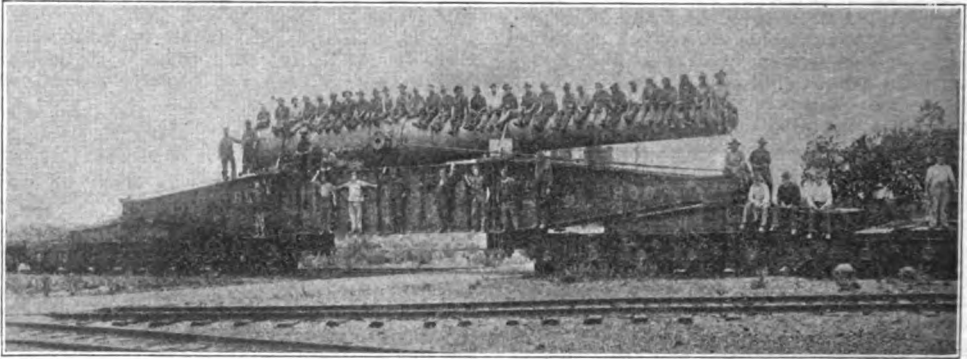

THE WORLD'S LARGEST GUN, MADE AT WATERVLLET.

By Frank C. Perkins.

The accompanying illustration shows the world's largest gun, made at Watervliet, and mounted on special car for shipment. The car carrying this 16-inch gun built some years ago at Watervliet Arsenal from forgings supplied by the Bethlehem Steel Company, and the following facts regarding this car and gun, are of interest.

This special car was designed for the transportation of large and heavy material

and has a length between couplers of 103 feet, 10½ inches. Its weight is 196,420 pounds and it has a capacity of 300,000 pounds. This car is constructed so as to distribute weight evenly on thirty-two wheels.

It may be stated that the 16-inch gun-forgings were also made at the Watervliet Arsenal, and it has a total length of 500.9 inches. Its outside diameter over the powder chamber measures 60 inches and it has a diameter at the muzzle of 28 inches, while its total weight is about 284,500 pounds.

"CATCHING" TUBERCULOSIS, OR INFECTION.

To the man who works for his living, falling sick with tuberculosis means a very real danger not only to his own life, but to the lives of his wife and children as well. His wealthier neighbor may lay aside his routine cares and "take the cure" for tuberculosis without materially affecting his family's health or income. The consumptive workingman, on the other hand, must give up his job and with it his only income, and at the same time he is frequently compelled to remain at home, a constant source of danger to his family, unless he is properly instructed. It may save you who read this article considerable money and suffering if you learn from it how to avoid the entrance of tuberculosis into your body.

Tuberculosis is infectious and communicable from one person to another. It differs in some respects from scarlet fever, measles, or small-pox, so-called "contagious" diseases, in that tuberculosis requires repeated exposures and certain special conditions to pass the germ from the sick to the well. It is not inherited, but must be com-

municated through one of the following sources from one person to another:

(1) The infection is derived in the very large majority of cases from the sputum discharged from "open" or ulcerating tubercles in the lungs.

(2) A certain number of persons, chiefly infants, estimated variously from one to ten per cent of all cases, receive the infection from the milk of tuberculous cows.

(3) A very few others may possibly obtain the infection from the urine and fecal discharges of consumptives or from the pus joints or other parts of the body which are the seat of ulcerating tuberculosis.

(4) In a few extremely rare instances the infection is conveyed through the blood of the mother to an unborn child, but the offspring seldom survive long.

(5) No infection can be conveyed from tuberculosis of the "closed" or non-ulcerated variety, or after ulcerations are completely healed.

With regard to the manner of infection, still bearing in mind that tuberculosis must be communicated from one person to another, we find that by far the most frequent

mode of infection is by inhalation; the second is by swallowing, and the least common, by inoculation of a wound or abrasion. Considering each of these modes of infection a little more carefully, we learn that:

(1) The bacilli are inhaled most often in dust. The dust is most often contaminated by careless spitting; but the germs may also be given out in the act of coughing (with the mouth unprotected) or hawking, sneezing, loud talking, singing or laughing. Quiet breathing carries no infection.

(2) The bacilli may be swallowed with food which has been contaminated with infected hands or otherwise, and also with the milk, butter and other dairy products derived from cows suffering from bovine tuberculosis.

(3) Inoculation by the infection of cuts, scratches or abrasions is not frequently observed.

While no age, race or class is immune against infection from tuberculosis, children are more susceptible than anyone else. At the age of 15, frequently as high as 75 per cent of the population may show the presence of the germs, though not that many may be sick with tuberculosis. In view, however, of the fact that these germs may lay quiet in the body of the child for years, until with unfavorable surroundings his resistance is lowered, causing the disease to develop, it is extremely important that fathers and mothers do everything possible to keep their children away from danger of infection in their earlier years.

Everything should be done at home to keep the child rugged and healthy. The father and mother, whether they have tuberculosis or not, should be scrupulously careful in their habits of spitting and personal hygiene. The working father owes it not only to his own health but to that of his children to avoid tuberculosis in every possible way.

(Editor's Note.—This article has been prepared for the Boiler Makers' Journal by the National Association for the Study and Prevention of Tuberculosis. Others will follow, giving more details as to what you should know about tuberculosis.)

A NOTORIOUS SPYING SYSTEM.

The following is a copy of a letter sent out by a detective or strike-breaking agency of Cleveland, Ohio. It was marked personal and confidential and of course was not intended for the public to read, but it fell into the hands of friends of organized labor, and, therefore, we are able to reproduce same to show the despicable methods used by some to spy on organized labor and filch money from employers of labor:

THE CORPORATIONS AUXILIARY COMPANY,

Chamber of Commerce Building.

Cleveland, O., January 15, 1915.

(Personal and Confidential.)

E. J. Brettell, General Manager, Brettell Bros, Mingo, Junction, Ohio:

Dear Sir—You no doubt are contemplating

operating your mines, permitting such of your employes as are willing to return to work, to do so irrespective of the arbitrary position assumed by the leaders of the United Mine Workers. In order to insure the success of this venture, you will require assistance such as this company is prepared to furnish, both in the way of giving protection to your loyal employes, as, no doubt, they will be molested and pressure brought to bear in every way to discourage them and in recruiting a sufficient number of workmen to conduct operations. You will also of necessity have to keep yourself informed as to what the attitude of your disloyal employes is and what steps their so-called "leaders" will take to frustrate your plans.

We have handled many strikes and have yet to lose a single one, and many of these strikes were won without the use of a single guard or the destruction of one cent's worth of property. Among recent large strikes of national prominence that we have handled we might mention the Boot and Shoe Workers' strikes in Portsmouth, Ohio, and Brooklyn, N. Y.; the Furniture Workers' strike in Grand Rapids, Mich.; the Teamsters' strike in Indianapolis, and the Rubber Workers' strike in Akron, Ohio. The officers of our company are men of repute and we have a reputation to sustain which we have built up by doing our work thoroughly at the least possible cost to our clients. In handling labor troubles we aim to bring them to a successful issue as quickly as we can, fully appreciating that it is only by our proved ability to accomplish this that we can hope to enjoy the future patronage of our clients. We are widely and favorably known, not only in this state, but throughout the country, numbering among our clients some very prominent coal operators who have gone on record as saying that our representations are true in every particular, despite the fact that we have gained but little publicity, it having always been our aim and the desire of the people we do business with to avoid this.

In conclusion, let us say a word regarding our industrial or community control service, which comprehends placing men in labor and political organizations with the idea of having them work up to the leaders, not with the object of writing history after somebody else has made it, but for the purpose of making history by influencing or dominating that particular organization. This is a big proposition, but by no means an experiment with us, as we are doing this today for some of the largest manufacturers in this country, and there is absolutely no reason why, with the support of the coal operators, it cannot be accomplished in the coal industry.

Our methods, as you appreciate, have no place in correspondence, but if you will write or phone us, appointing a time when our representative can call so that your time as well as our time—both of which are valuable—may not be wasted, we will

be glad to explain everything fully to you and know you will be interested.

Anticipating your early and favorable reply, which carries with it no obligation whatever excepting a candid discussion of a subject that is of vital importance to you, we remain,

Yours very truly,
THE CORPORATIONS AUXILIARY
COMPANY,

By DAN G. ROSS,
District Manager.

A NEW HEAVY FREIGHT SERVICE LOCOMOTIVE.

By Frank C. Perkins.

The accompanying illustration shows the construction of a new heavy freight service locomotive of the Baltimore & Ohio Rail-

LOCKED OUT MINERS OF OHIO WILL RAISE OWN VEGETABLES.

Bridgeport, O.—The locked out miners of Eastern Ohio have proved themselves to be a resourceful army in the long deadlock that has followed the operators' refusal to abide by the mine-run law on many occasions. The latest bid, however, on the part of the miners for "strategic" honors is so novel that it reads like a chapter from the Kaiser's war book. The plan is to provide garden products for their families during the spring and summer months, and unless the present plans miscarry the barren hillsides of the coal regions and the wasted lands of vacant lots will soon blossom forth into bountiful truck gardens, from which the miners will secure sufficient vegetables to reduce their meager

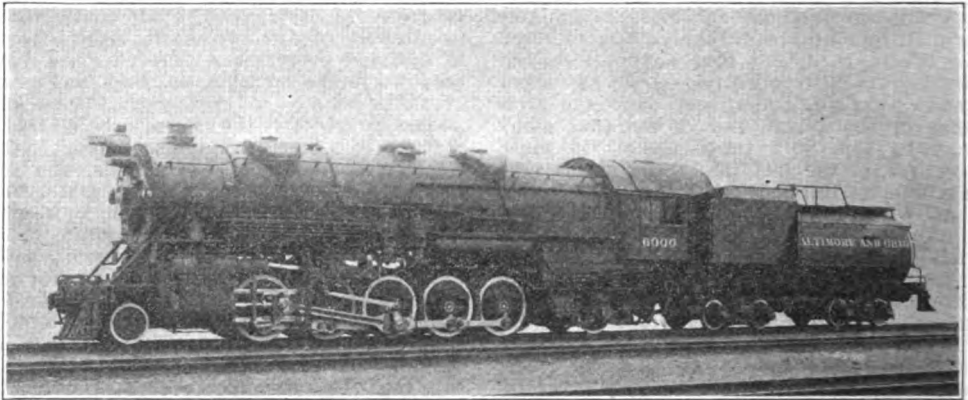

road, constructed at Philadelphia, Pa. This railroad company's class "S" locomotive has cylinders 30 by 32 inches and values of the piston type of 16-inch diameter.

The boiler is of the straight top type of a diameter of 90 inches, the thickness of sheet being $\frac{7}{8}$ inches and 15-16 inches, and the working pressure being 200 pounds. The fuel used is soft coal and the fire box has a length of 132 inches and a width of 96 inches, the depth, front, being $89\frac{1}{2}$ inches. The water space front and sides and back measure 6 inches, and the tubes of steel have a diameter of $5\frac{1}{2}$ inches and $2\frac{1}{4}$ inches and a length of 23 feet.

This engine is equipped with a Schmidt superheater, the superheater surface being 1,329 square feet. The total heating surface of the engine fire box is 258 square feet and its total 5,573 square feet, of which tubes represent 5,215 square feet.

The driving wheels have a diameter, outside of 58 inches, the diameter back being 44 inches. The driving wheel base is 21 feet, and the rigid wheel base is 21 feet, while that of the total engine and tender is 76 feet, 6 inches.

The weight of the engine and tender is 584,000 pounds.

store bills and at the same time more fully meet the demands of their appetites.

During the past few weeks many requests have been received at the Bridgeport District office, from the locked out miners, requesting that they be furnished with garden seeds. The demand grew to be so general the district officials decided to do all in their power to furnish the necessary seeds and to make the movement district-wide. Secretary Houston, of the Department of Agriculture at Washington, was appealed to to furnish the district office with a large quantity of government free seeds, in such variety as the ordinary run of garden products claimed. Although the department has not yet had time to consider the request, it is generally believed that Secretary Houston will favor the idea, as the miners promise some surprising results in diversification and scientific gardening, which at present is claiming the department's attention in a nation-wide campaign.

The first planting will occur this week, in advance of the arrival of government seeds, when in nearly every camp hot beds will be sowed with tomato seeds. When the plants have reached the proper age, weather conditions permitting, the plants will then be distributed among the miners who in turn

will set them out on the ground "home-steaded" by them for gardening purposes.

The publication of the truck gardening plan of the miners, as expected, brought forth loud protests from several of the coal companies who seriously object to the idle land being cultivated into provision-bearing plots for the benefit of the miners. This denial, however, on the part of the operators will only tend to increase the offers of free land by the farmers who are thoroughly in accord with the plan. In addition to the land secured from the farmers, prediction is being made that many home owners who have large vacant lots will solicit the miners to cultivate their holdings on a share basis.

Regardless of the difficulties, the miners are joyful over the prospective success of the idea.

"IF YOU MUST DRINK."

(From the Crescent Magazine.)

To the married man who cannot get along without his drinks, the following is suggested as a solution to a bondage of his habits.

First: Start a saloon in your own home.

Second: Be the only customer and you will have no license to pay. Give your wife two dollars to buy a gallon of whiskey, and remember there is sixty drinks to one gallon.

Third: Buy your drinks from no one but your wife, and by the time the first gallon is gone she will have \$8.00 to put in the bank and \$2.00 to start business again.

Fourth: Should you live ten years and continue to buy drinks from her and then die with snakes in your boots, she will have money enough to bury you decently, educate your children, buy a house and lot, then marry a decent man and quit thinking about you.

AN ENORMOUS STEEL COAL CAR.

By Frank C. Perkins.

At Roanoke, Va., there has been designed and constructed by the Norfolk & Western Railway Company a 100-ton car with six wheel trucks as seen in the accompanying illustration, having a capacity for nearly

pounds and is intended to carry when full loaded 90 tons, with the 10 per cent addition or about 100 tons. The car measures in length inside 45 feet, 6 $\frac{1}{4}$ inches, and it has a width of 9 feet, 6 inches, and a height of 6 feet, 5 inches. The outside dimensions are 46 feet, $\frac{3}{4}$ inch for the length of body

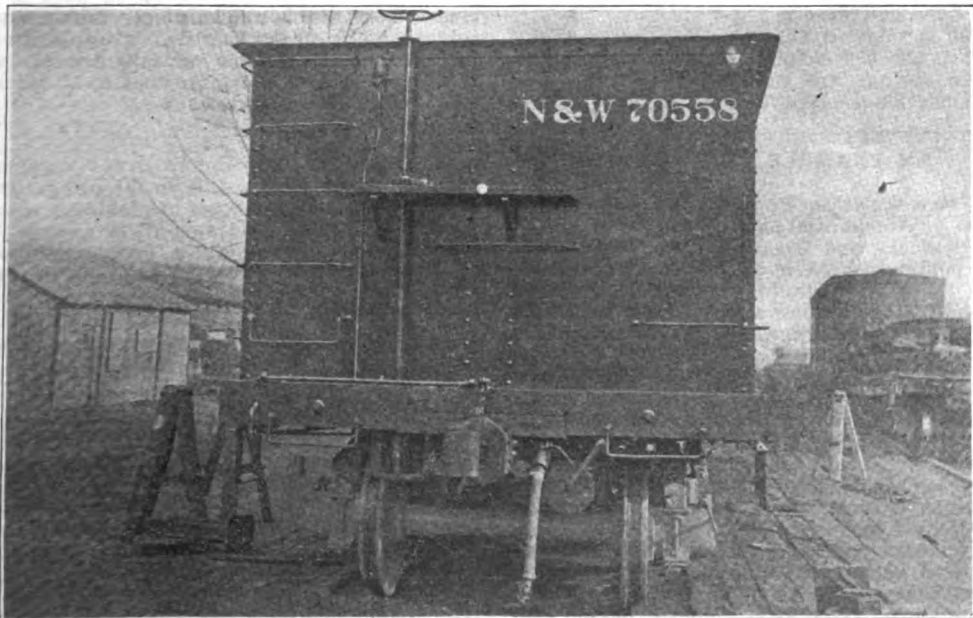

a quarter of a million pounds of coal.

This 100-ton coal car is mounted on a pair of Lewis six-wheel trucks and it is stated that this car was designed for the purpose of mounting a heavy freight car without too heavy concentration of loads on the axles. It is held that this six-axle truck is a perfectly equalized freight car truck without pedestals. The car weighs, complete, 65,200

over all, and the width of the body is 10 feet, 4 $\frac{1}{2}$ inches, while the height above rail measures 10 feet, 4 $\frac{3}{4}$ inches, and the distance between truck centers is 32 feet, 10 inches, while the length over end sill is 46 feet, 10 $\frac{3}{4}$ inches.

The car has a cubic capacity when level full of 2,829 cubic feet and a heap on top of the car at 30 degrees increases the ca-

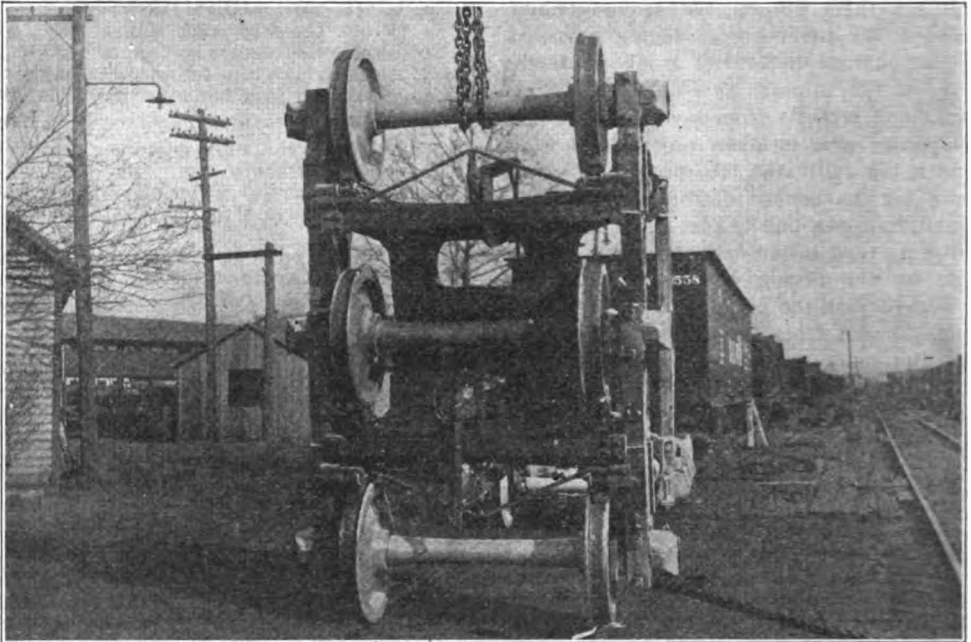

capacity 551 cubic feet so that the total cubic capacity including heat at 30 degrees is 3,380 cubic feet.

It is claimed that this car has actually on it 206,000 pounds of Pocahontas coal. The springs are so located that the side frames themselves become equalizers, and

properly distribute the coal between the wheels. The frame is articulated over the center box, which allows ample movement to take care of any vertical irregularities in the track. With this car fully loaded as mentioned above, the individual axle loads are about 44,300 pounds each.

AN EXAMPLE FOR AMERICA.

New Laws in England and Denmark Ameliorate Labor Conditions.

Denmark and Great Britain have evolved a public insurance against unemployment, so that the costs of hard times and seasonal unemployment are shifted from the individual to the group, or from the individual to society itself.

This is the most advanced legislative step taken by any country. It involves an official recognition of the fact that the old individualism of an earlier day has passed away, and that the individual alone should not be required to suffer from social conditions which have passed beyond his power of control.

America remains almost the only advanced nation that continues to ignore the fact that conditions of an earlier age have long since passed away. Social thought still treats the worker as a free man, able to turn his hand to employment if he wills, when in reality the land has been closed against him, the tools of employment are in other hands and the industrial system is wholly beyond his control.

We have not yet begun to organize, to provide means for, clearance in industry such as the banks have maintained for a generation; we have not recognized the

necessity for housing the itinerant worker, nor have we accepted the social obligation to shift to society the costs of sickness, accident, invalidity and old age, all incidents of modern industry and all a proper charge against society itself.—Frederick C. Howe in the Century Magazine.

MASS MEETING OF ORGANIZED LABOR.

The beautiful auditorium of the Los Angeles Union Labor Temple was filled to overflowing with enthusiastic trade unionists Wednesday evening, March 24, the occasion being a mass meeting to afford labor an opportunity to enter protest against recent utterances of men connected with interests antagonistic to organized labor, and to give detailed information relative to Labor Temple affairs.

The meeting was one that will long be remembered by those present. Interesting addresses laudatory of the efforts being put forth by the Board of Directors to clear the Temple of debt were made by men prominent in the movement, and an open defy hurled at the enemies of labor.

A number of organizations adjourned their meetings and attended in a body. An interesting feature of the meeting was the entrance of two hundred members of the Beer Drivers' Union, and the announcement by

one of their members, Mr. Ferd Roth, that the organization had passed a resolution in the meeting just closed to the effect that their social fund be drawn on for money enough to purchase two shares of stock for each member.

A number of individual members of the many organizations present at the mass meeting subscribed for varying amounts of stock, and the Labor Temple's European Tour Contest was given renewed impetus.

The Los Angeles Musicians' Union No. 47 A. F. of M., made a further investment in Los Angeles Labor Temple stock, and is making arrangements to enter a candidate in the European Tour Contest. They purchased 240 shares. Secretary H. P. Moore, of the Musicians, in commenting upon the deal, said:

"Had we given closer attention to Labor Temple affairs in the past we no doubt would have taken this action ere now. We have held a block of stock in the Temple for a long time and have always endeavored to do our duty toward the institution. So far as I can see, the Labor Temple property is a valuable one. It is close in and the increase in values in this district during the past ten years has been most phenomenal. While at the present time there is a temporary lull in business, none will deny that this property will continue to increase in the future as it has done in the past."

A. W. (Booth) Thomson, of Cleveland Typographical Union No. 53, has been selected by the Printers as their candidate in the Los Angeles Labor Temple European Tour Contest. Thomson is a well-known member of the International Typographical Union, having attended many conventions of that organization as a delegate. He was chairman of the Committee on Laws at the Providence, R. I. session of the I. T. U. last year, and at the present time is serving as chairman of the Committee on Vocational Training, created at that convention, which committee will make its report to the Los Angeles convention in August.

U. S. DEPARTMENT OF LABOR, BUREAU OF LABOR STATISTICS, WASHINGTON.

Butter Prices, From Producer to Consumer.

"Butter prices from producer to consumer" is the subject of a report recently issued as Bulletin No. 164 by the Bureau of Labor Statistics of the United States Department of Labor. This report relates to creamery butter only and the prices considered are those for butter passing promptly from producer to consumer, no cold storage prices being included.

The object of the report is to show the relation between the price of the raw material (butter fat) and the retail price of butter in periods of comparatively low and high prices, and the cost of distribution or the additions made to the price of butter as it passes from producer to consumer. Data as to creameries were obtained from

10 representative establishments in the famous Elgin District and in Northwestern Missouri, and prices and margins of wholesalers and retailers were obtained covering various lots of tub and print butter bought from the 10 creameries mentioned, and handled in the large markets of Chicago, Cincinnati, Cleveland, Philadelphia and Pittsburgh. June, as representing the season of high production and low prices, and December, the season of low production and high prices, were the months selected, and data was secured for these months for the following representative years: 1904, when butter prices were the lowest shown for any year since 1901; 1910, when there was a wide range of prices and the average was comparatively high; 1911, when prices fell somewhat as compared with 1910.

The primary constituent of butter is butter fat, which briefly defined is the pure oil contained in milk, cream, or butter. The farmer who supplies milk or cream to the creamery is paid on the basis of the amount of butter fat contained therein. The difference between the price paid the farmer by the creamery for the butter fat in one pound of butter and the price paid by the consumer for one pound of butter represents the total margin from producer to consumer.

In the periods covered by the report the average price received by farmers and paid by consumers, the margin between those prices, and the per cent that the margin in each case was of the retail price were as follows:

Average price paid farmer for butter fat in 1 pound of butter; June, 1904, \$0.1518; December, 1904, \$0.2326; June, 1910, \$0.2562; December, 1910, \$0.2733; June, 1911, \$0.2086; December, 1911, \$0.3297.

Average retail price per pound of butter paid by consumer, June, 1904, \$0.2428; December, 1904, \$0.3285; June, 1910, \$0.3442; December, 1910, \$0.3746; June, 1911, \$0.2982; December, 1911, \$0.4341.

Total margin, June, 1904, \$0.0910; December, 1904, \$0.0959; June, 1910, \$0.0880; December, 1910, \$0.1013; June, 1911, \$0.0896; December, 1911, \$0.1044.

Per cent margin is of retail price, June, 1904, 37.5; December, 1904, 29.2; June, 1910, 25.5; December, 1910, 27.1; June, 1911, 30.0; December, 1911, 24.1.

In December (the month of low production) the prices were considerably higher than those in June (the month of high production), especially in the years 1904 and 1911. When figures for the three years are combined the increase in December as compared with June amounts to 35.4 per cent for prices received by farmers and 28.5 per cent for those paid by consumers. In the two months of 1904 when prices were low the total margin represented a much higher proportion of the retail price than in the corresponding months of 1910 and 1911, when prices were higher.

The total margin between producer and consumer is made up of the creamery

margin, freight and cartage, wholesaler's margin, and retailer's margin. In the periods considered the average creamery margins per pound varied from a minimum of 2.04 cents in June, 1910, to a maximum of 3.38 cents in December, 1904; freight and cartage averaged the same (about three-fourths of a cent per pound; the average wholesaler's margin varied from a minimum of 1.3 cents in June, 1904, to a maximum of 1.87 cents per pound in December, 1911; the average retailer's margin varied from a minimum of 3.9 cents per pound in December, 1904, to a maximum of 5.08 cents per pound in December, 1910.

ONE DAY REST IN SEVEN.

Important Decision in New York.

The nation-wide campaign for the enforcement of one day rest in seven will be greatly assisted by the favorable decision recently handed down by the Court of Appeals in New York. As the highest court of New York has thus upheld the constitutionality of the law, it is thought improbable that it will be seriously challenged in other states. Bills to limit the working week to six days are to the front in Illinois, Pennsylvania, Ohio, Minnesota, New Hampshire, New Jersey, California and Wisconsin and a number of other states.

In giving this decision the bench of the New York Court of Appeals is unanimous. The bench states that such a law is "in the direction of the betterment of public health and welfare, and, therefore, that it is one which the state for its protection and advantage may enact and enforce." The decision also points to the special need for legislative protection of the worker in the confined atmosphere of factories and workshops. The act primarily applies to factories and mercantile establishments.

The American Association for Labor Legislation which initiated legislation for one day of rest in seven points to the new need of affording the worker this protection owing to the inadequacy of Sunday laws under modern conditions.

Many modern industries are and must be continuous in their operation. "More than 15 per cent of the employes in the iron and steel industry as a whole and more than 50 per cent of the blast-furnace workmen were on a regular schedule of seven days a week, with a long turn of eighteen, or twenty-four hours at the change of shift," stated the United States Bureau of Labor Statistics, in its report in August, 1912. This means that nearly 26,000 men, in this industry alone, were condemned to toil week in, week out, without respite.

Of 180,000 trade-union members in the state of New York one man in every five was reported to the State Department of Labor in 1910 as working regularly seven days a week. In the same year the Bureau of Labor in Minnesota reported 98,558 men working seven days each week. In Massa-

chusetts a joint legislative committee in 1907 estimated that 221,985 persons, or over 7 per cent of the population, were engaged in seven-day labor.

Not only must blast furnaces be stoked all the week but many forms of house service such as heating must be uninterrupted. Thus while the old Sunday laws are no longer practicable, the physical and moral welfare of men and women none the less demands the assurance of a day of rest.

The harmful results of continuous employment are recognized by casualty concerns. "If an applicant came to us for insurance, and we knew he was working seven days a week, we would refuse the risk, unless such excessive work was only temporary"—is the declaration of John M. Pattison, President of the Union Central Life Insurance Company. A statement more significant of the dangers of seven-day labor could hardly be found.

THREE YEARS UNDER THE NEW JERSEY COMPENSATION LAW.

That administration of workmen's compensation laws by the courts is the most unsatisfactory system that could be devised from the worker's point of view is the conclusion formed by the American Association for Labor Legislation which has just completed the first thorough investigation made into the operation of a state compensation law in this country.

New Jersey, in 1911, was the first state to establish a system of accident compensation, and the report just issued by the association covers three and a half year's experience of its operation. Since New Jersey led the way, twenty-three more states have passed workmen's compensation acts and in the present year the question is before the legislatures of forty-four states. No other single issue, it is stated, is the subject of so much legislative activity.

The New Jersey law, contrary to the usual practice, created no special machinery for the administration of the act, but left cases to be settled between the injured worker and insurance company or employer according to the schedule prescribed, contested cases to come before the courts of common pleas in the twenty-one counties of the state.

In the course of the investigation not only were numerous officials, employers and workers interviewed, but 655 cases from court records were studied and many were followed up to the homes of the workers. It was found that court proceedings seriously handicapped the workers in a number of different ways. While the worker is less well informed as to the law and court procedure, he is at the same time, owing to the expense involved, generally unable to engage such expert lawyers or witnesses as are available for the employer. Under the New Jersey law the court determines the amount to be paid in fees by the claimant to his counsel. As counsel's fee is customarily determined by the amount of the

award and not by the work done, attorneys can usually only be induced to take up cases involving larger claims on a speculative basis. Thus very few minor claims are brought to court. A scrutiny of the settlements registered with the Department of Labor showed that though many of the settlements were irregular only 7 per cent of the claims appeared in the courts. The absence of machinery for administration of the act clearly allows less scrupulous employers to repudiate minor claims with impunity. So frequently does this occur that the association indorses the estimate of the National Civic Federation and the American Federation of Labor that 40 per cent of the amount due as compensation to the workers of New Jersey is never paid at all.

A most serious deficiency following from the court method is the amount of time consumed in making settlements. In the settlement of claims arising from 72 fatal cases the average length of time was 27½ weeks; while in 150 non-fatal cases settlement took an average of 33 weeks from the date of the injury. The report cites several typical cases showing the extent of the delay. In one case a widow and dependent children were obliged to wait fifty-three weeks for an award of \$1,500 to be paid in weekly installments. This obviously meant that the family became either public charges or the object of charitable aid, and one of the main purposes of the workmen's compensation, the prevention of destitution, was thwarted.

The association estimates that the annual cost of litigation over compensation claims in New Jersey is between \$50,000 and \$60,000. This amount of money it is pointed out is spent in litigation over the 7 per cent of the claims which are brought to the county courts which tend to give different types of decisions creating uncertainty and instability in the whole administration of the law. The same amount of money spent in equipping a commission would give to the state the advantage of expert decisions on all claims.

The Association for Labor Legislation strongly urges that all states adopt for an administration of compensation laws the commission or board rather than the court system. The association sums up the case against the court system with special reference to New Jersey in the following terms:

"Administration of a workmen's compensation law by the courts, a number of separate and scattered tribunals each already overburdened by its ordinary business and all more or less likely to be unfamiliar with the laws, results harmfully in that (1) tremendous delays arise, defeating one main purpose of a compensation law, namely to care for the injured or his dependents financially during the period of no earnings; (2) fees necessarily paid to attorneys eat up large portions of the awards; (3) settlements in violation of the law are frequently sanctioned by the courts or even

ordered by them on their own initiative; (4) conflicting opinions are handed down, confusing and complicating the whole system and making justice a matter of location, not of law; and finally (5) many meritorious claims are not pressed because of a fear that court action will result in dismissal from employment. A more unsatisfactory system, from the injured workers' point of view, would be hard to devise. Much of the hostility between employer and employe, and much of the waste and injustice that existed under the old liability system, remains in New Jersey, because the machinery which gave rise to the evil practices under the old system has been retained for administering the new. Experience in other states has shown that these evils can be eliminated by the creation of a supervising board with summary power in the settlement of disputes."

AN I. W. W. ASSAULT UPON THE CHARACTER OF OUR MEMBERS IN THE OIL FIELDS OF OKLAHOMA.

The following clipping was taken from "Solidarity," Cleveland, Ohio, an I. W. W. publication, and sent us by brother living in the Northwest, which shows copies of this sheet are being widely distributed in order to catch as many dupes as possible.

The nasty and unwarranted assault upon the character of our members in the oil fields by this writer goes to show his true character and the small standards of the organization he represents. Such slanderous articles are not worthy the attention of self-respecting men and would not be noticed here were it not for the evident intentions of these people to try and create trouble for our members in the oil fields and we reproduce this as a warning to them to be on their guard against the disruptive efforts of these people.—The Editor.

From Oil Field Jobs.

Drumright, Okla., March 15.

"Drumright is the center of all work in the oil fields around here. The prospects are good for all the rebels who wish to get on the job and do something for themselves and the organization, too. There is going to be lots of work here when the weather opens up, both on building pipe lines and steel storage tanks. A few rebels are here now. Most of the work now is corralled by wine bums. There is a chance of getting control of the jobs, if live members will come here and get out on the job. There can be great things accomplished for the I. W. W. this summer.

The tank builder's strike, previously mentioned, is about to be settled. Hundreds of tanks are to be built this summer. There will not be enough union boiler makers to do the work. There will be chances for hundreds of inexperienced men to get on the job. Why not make it an I. W. W. job? All rebels will be welcomed. Spittoon philosophers and pie-card artists wishing to live off the workers, will not be welcomed."

W. S.

Smiles.

THE VANTAGE POINT.

The mayor of a small town was trying a negro for abusing his wife. She claimed he got drunk and tried to beat her and she hit him.

The mayor turned to their little girl and asked:

"Girl," was your father under the influence of whiskey when your mother hit him?"

"No, sah! He was under the kitchen table," she very quickly replied.—Mack's National Monthly.

"Now, Silas," said the speaker, "I want you to be present when I deliver this speech."

"Yassuh."

"I want you to start the laughter and applause. Every time I take a drink of water, you applaud; and every time I wipe my forehead with my handkerchief, you laugh."

"You better switch dem signals, boss. It's a heap mo' liable to make me laugh to see you standin' up dar deliberately takin' a drink o' water."—Washington Star.

Ethel used to play a good deal in Sunday-school, but one day she had been so good that the teacher said in praise:

"Ethel, my dear, you have been a very good girl today."

"Yeth'm," responded Ethel. "I couldn't help it. I dot a stiff neck."—Pittsburgh Chronicle.

A farmer in the country last autumn gave a job to a seedy-looking individual who had applied to him, and who assured him that he never got tired. When the employer went to the field where he had put the tramp to work, he found the latter lolling on his back under a tree.

"What does this mean?" asked the employer. "I thought you were a man who never got tired?"

"I don't," calmly responded the tramp. "This doesn't tire me."—Sacred Heart Review.

A LONG SEARCH.

"I've been looking for my husband for the last two hours," said an agitated woman to a calm one.

"Don't be excited, madam," replied the latter. "I've been looking for a husband for the last twenty-five years.—From Tit-Bits.

WHY HE OBJECTED.

"Now," said the principal to one of the pupils at the close of the lesson in which he had touched on the horrors of war, "do you object to war, my boy?"

"Yes, sir, I do," was the fervent answer. "Now tell us why."

WHERE HE WAS.

"The train struck the man, did it not?" asked the lawyer of the engineer at the trial.

"It did, sir," said the engineer.

"Was the man on the track, sir?" thundered the lawyer.

"On the track?" asked the engineer. "Of course he was. No engineer worthy of his job would run his train into the woods after a man, sir."

WHERE HE GOT IT.

Teacher—Now, Willie, where did you get that chewing gum? I want the truth.

Willie—You don't want the truth, teacher, an' I'd rather not tell a lie.

Teacher—How dare you say I don't want the truth! Tell me at once where you got that chewing gum.

Willie—Under your desk.—The Railroad Telegrapher.

FRANK ABOUT IT.

A Modern Maid—Am I the first girl you ever loved?

Modern Youth—I cannot tell a lie. You are not. You are simply the best of the bunch—Ex.

STRIKING.

An Irishman invalided home from the war was asked by one of his relatives what struck him most about the battles he took part in.

"What struck me most?" asked Pat. "Sure it was the large number of bullets flying around that didn't hit me."

WHO WILL WIN?

An observer was conversing with an inquirer.

Inquirer: "Who will win the war?"

Observer: "Who won the California earthquake?"—Harper's Weekly.

EASY ENOUGH.

"Here's an account of a woman who lived on raw fish for twenty days."

"That's nothing. My uncle has been living on water for the last six months."

"So you expect me to believe that eh? Why don't you add that he grew fat on it?"

"Well he did. He's a sea captain."—The Scout.

GENTLE REMINDER.

"That man has a voice like a sawmill," said the woman with a sensitive ear.

"I wouldn't say that," replied her husband.

"What do you know about it?"

"I was in the lumber business for several years. Some saw mills don't sound so bad."—Ex.

NO USE FOR SHAKESPEARE.

Father—Johnny, stop using such dreadful language

Johnny—Well, father, William Shakespeare uses it.

Father—Then don't play with him; he's no fit companion for you.

"I don't understand precisely the functions of the Supreme Court."

"It's like this: You have a dispute with your wife and she decides against you. That's the lower court."

"I see."

"You take the matter to your mother. That's the Court of Appeals."

"I see."

"Then your wife takes it to her mother. That's the Supreme Court."—Louisville Courier-Journal.

Uncle Sol threw aside the letter he was reading and uttered an exclamation of impatience.

"Doggone!" he cried, "why can't people be more explicit?"

"What's the matter, pa?" asked Aunt Sue.

"This letter from home," Uncle Sol answered, "says father fell out of the old apple tree and broke a limb."—From the Youngstown Telegram.

Standing by the entrance of a large estate in the suburbs of Dublin are two huge dogs carved out of granite.

An Englishman going by in a motor thought he would have some fun with the Irish driver.

"How often, Jack, do they feed those two dogs?"

"Whenever they bark, sir," was the straightforward reply.—Truth Seeker.

"Is dat a kickin' mule?" asked Mr. Erastus Pinkley.

"Does you want to buy him?" inquired Uncle Rasbury, cautiously.

"No."

"Den whut's de use o' comin' aroun' here axin' useless question an' temptin' me to spoil my reputation foh truth an' mendacity fer nuthin'."

A COMPARISON.

"Why is a clock like a pretty and vain young lady?"

"I fail to see any resemblance. Why?"

"Because it is all face and figure, has no head to speak of, is hard to stop when once it is wound up and has a striking way of directing attention to itself every hour of the day."—London Tit-Bits.

WISE PAPA.

"Papa, what is an escutcheon?"

"Why?"

"This story says there was a blot on his escutcheon."

"Oh, yes! An escutcheon is a light-colored vest. He had probably been carrying a fountain-pen."—Houston Post.

HIS FORTUNE.

"Darling," whispered the ardent suitor, "I lay my fortune at your feet?"

"Your fortune?" she replied in surprise. "I didn't know you had one."

"Well, it isn't much of a fortune, but it will look large beside those tiny feet."—Kansas City Times.

MODIFIED.

"I'm a glutton for work!" boasted the man.

But his wife overheard him and asked him to split some wood.

"Er—I mean an epicure!" the man hastened to correct himself.—From Puck.

Silas—I hear your son left that small town, and went to the city to have a larger field for his efforts.

Hiram—Yes; and that's what gets me. When Hank was home a 2-acre potato patch was too big a field for him.—Judge.

"What is that tune you were playing on the bugle last night?"

"That was not a bugle," replied the cornet virtuoso rather stiffly.

"Oh, well, if you're so particular as all that, it didn't sound like a tune, either."

"I can give you a cold bite," said the woman.

"Why not warm it up?" asked the tramp.

"There ain't any wood sawed."

"So? Well, give it to me cold."—New York Sun.

WHY SHE QUIT.

Dinah (employed as waitress)—Yas, mum, I am a-leavin, dis place tomorrow.

Mistress—Why, Dinah, whatever can have displeased you with your position? Haven't I been treating you well?

Dinah—Oh, yas, indeed you have, mum. But to tell the truf, miss, in dis house dey am too much shiftn' ob de dishes fo' de fewness of de vittles.—Life.

AN INSTALLMENT.

It was on a Broadway car. A passenger stopped and picked up a coin from the floor. Three of the other passengers eyed him with envy.

He said:

"Which of you people dropped a five-dollar gold piece?"

"I did!" yelled each of the three.

"Well," said the finder to the man nearest him, "here's a nickel of it."—Exchange.

"There's nothing so hard to ride as a young broncho," said the Westerner.

"Oh, I don't know," replied the man from back East. "Did you ever try the water wagon?"—Toledo Blade.

"You just told me it was one o'clock; it just struck three," wife mutters.

"But, dear," he said with aching head,

"You know that old clock stutters."

Poetical Selections.

TWO KINDS.

There are two kinds of people on earth today;
Just two kinds of people, no more, I say.
Not the sinner and saint, for 'tis well understood
The good are half bad and the bad are half good.

Not the rich and the poor, for, to count a man's wealth,
You must first know the state of his conscience and health;
Not the humble and proud, for, in life's little span,
Who puts on vain airs is not counted a man.

Not the happy and sad, for the swift flying years
Bring each man his laughter and each man his tears.

No, the two kinds of people on earth that I mean
Are the people who lift and the people who lean.

Wherever you go you will find the world's masses
Are always divided in just these two classes;
And, oddly enough, you will find, too, I ween,
There is only one lifter to twenty who lean.

In which class are you? Are you easing the load
Of overtaxed lifters who toll down the road?
Or are you a leaner, who lets others bear
Your portion of labor and worry and care?
—Henry P. Lyman-Wheaton in the Christian Herald.

IN THE PALACE OF CONTENT.

In the palace of content
There dwells a princess fair,
The sunbeams from the sky were sent
To nestle in her hair.

Her smile gay as a Maytime day
And sweeter than a rose,
And many a smile upon the way
She scatters as she goes.

Her eyes, like evening stars, are bright
(And brighter, I opine),
And with the same soft, kindly light
Of evening stars they shine.

O princess fair, O princess fair,
How does her garden grow?
Why, many happy thoughts are there,
All planted in a row!

Now, who can read this rhyme with care
And guess just what is meant?
Are you, perhaps, the princess fair
In the palace of content?

—Selected.

AN OLD MAN'S JOB.

When a young man sits on a bench in the park,

You're sorry—a little—for him.
But the future needn't be dreadfully dark
For a youngster with vigor and vim.
But the park-bench man who's the tragic man,

Who brings to the throat a sob,
Has a paper whose lines his dull eyes scan
In search of an old man's job.

Shoulders age-bent 'neath a shiny coat,
Face that is wistful and lined,
Weak, faded eyes, eager bent, to note
The pitiful chance they may find
In the paper held by the knotted hands
That shake a bit as they hold;
The chance is so little, he well understands,
For a job for the man who is old.

Gray, scant hair, and a leg that drags
As he rises and limps away
With a half-born hoping that never flags
Till the close of a fruitless day.
Employer men, you are rushed, I know—
Your duties throng in a mob;
But give him, please, just a little show
Who asks for an old man's job.
—Miriam Telchner, in New York Globe.

TELL HER SO.

Amid the cares of married life,
In spite of toil and business strife,
You who value your sweet wife;
Tell her so.

When days are dark and friends are few,
She has her troubles, same as you;
Show her your love is ever true;
Tell her so.

In days of old you praised her style,
And spent much care to win her smile,
'Tis just as well now worth your while;
Tell her so.

There was a time you thought it bliss
To get the favor of one kiss,
A dozen now won't come amiss;
Tell her so.

She'll return for each caress
A hundredfold of tenderness;
Hearts like hers are made to bless;
Tell her so.

You are hers, and hers alone;
Well you know she's all your own;
Don't wait to "carve it on a stone";
Tell her so.

Never let her heart grow cold;
Richer beauties will unfold.
She is worth her weight in gold;
Tell her so.

—A. J. Perrault.

FACE THE SUN.

Don't hunt after trouble, but look for success.
 You'll find what you look for; don't look for distress.
 If you see but your shadow, remember, I pray,
 That the sun is still shining, but you're in the way.
 Don't grumble, don't bluster, don't dream and don't shirk;
 Don't think of your worries, but think of your work.
 The worries will vanish; the work will be

done.

No man sees his shadow who faces the sun.
 —The Railroad Telegrapher.

The train was almost crowded and the poor mother was gently tossing the baby up and down in her arms in a vain endeavor to stop its crying. As the car slowed down at the stopping place the conductor looked in the door and shouted:
 "George's Cross!"
 "Yes; and perhaps if you were cutting your teeth you'd be cross, too," the lady with the baby replied sharply.—Tit-Bits.

In Memoriam

Members.

D. A. Tierney, Reg. No. 64437, boiler maker, born in Bayonne, N. J., died on March 15th after a short illness, buried in Port Arthur, Texas; initiated in Local No. 33, January 28, 1909. Member of Local 305 at time of death.

Jones of Lodge No. 292, died March 3rd, 1915, age 61 years.

Mrs. John Hunter, sister of Brother Wm. Baker of Lodge No. 206, was born in Gretna, La., 1874, died March 30, 1915, of pneumonia; age 40 years.

Relatives of Members.

William Jones, father of Brother Wm.

James M. Daniels, age 59, father of Brother Hobart Daniels, Lodge No. 549, was born Addison, Ohio, December 17, 1858, died March 8, 1915, of paralysis.

Lodge Notices

Costlow et als, Lodge No. 292.

C. Costelow, Reg. No. 46605; Peter Gillardi, Reg. No. 48540; L. Johnson, Reg. No. 86728; E. J. Lynch, Reg. No. 65825; H. J. McLaughlin, Reg. No. 36816; A. Noble, Reg. No. 51165, please correspond with the secretary of Lodge No. 292, E. P. Butler, 1723 Gabriel avenue, Parsons, Kas.

No. 567, for non-payment of a note of seventy-five dollars (\$75.00).

R. L. WHITE,
 Cor. Secretary Lodge No. 567.

P. D. Connors—Wm. Zobel.

Anyone knowing the whereabouts of Patrick Connors, Reg. No. 8954, or any secretary taking up the card of this brother, please hold same and correspond with Wm. Zobel, 2154 Chouteau avenue, St. Louis, Mo., as he has been paying this brother's insurance bills for the past 18 months.

WM. ZOBEL,
 2145 Chouteau Ave., St. Louis, Mo.

Robertson Lodge No. 173.

H. E. or Earnest Robertson is wanted by Lodge No. 173, for failing to make good some money he borrowed.

J. P. TAYLOR, Lodge No. 173.

Stewart et al—Lodge No. 66.

Any secretary taking up the card of Edgar Stewart, Reg. No. 21232, or Noble C. Townsend, Reg. No. 62088, will please correspond with the secretary of No. 66, Little Rock, Ark., as these brothers misrepresented facts and secured transportation out of Little Rock and Lodge No. 66 had to pay for same.

E. WORTHSMITH,
 Corresponding Secretary No. 66.

Frank Brodrick—R. H. Walker.

Anyone knowing the whereabouts of Frank Brodrick will confer a favor by writing to the undersigned, as he has valuable information for him. R. H. WALKER,
 617 Walnut St., Hattiesburg, Miss.

E. L. Chafin—Lodge No. 587.

We have suspended Brother E. L. Chafin for not paying dues or honest debts. I, myself, loaned this brother some money to bury his little child, and he will not pay it back. He also owes several bills that he won't pay.

C. C. MADDY, C. S. L. 587.

LIST OF MEMBERS PREVIOUSLY ADVERTISED

L. D. Landault, Reg. No. 87363, left Teague, Tex., owing a grocery bill of thirty-nine dollars and ninety-five cents (\$39.95). He is wanted by Mrs. John Cure, Teague, Tex., who stood good for the amount.

T. D. Swain, Reg. No. 38826, by Lodge

W. M. Horstmeyer—Lodge No. 381.

Any secretary taking up the card of Brother W. M. Horstmeyer, Reg. No. 9735, please hold same and correspond with Joe Wilson, secretary Lodge No. 381, Amarillo, Tex., as this brother borrowed some money from this lodge which he has forgot to return.
 JOE WILSON, L. 381.

OFFICIAL ROSTER--International Officers

J. A. FRANKLIN.....International President
Room 15, Law Bldg., 721 Minnesota Ave., Kansas City, Kas.

F. P. REINEMEYER.....Int. Secretary-Treasurer
Rooms 10 to 12 Law Bldg., 721 Minnesota Ave., Kansas City, Kas.

JAMES B. CASEY.....Editor-Manager of Journal
Room 9, Law Bldg., Kansas City, Kas.

A. HINZMAN.....First Int. Vice-President
Room 15, Law Bldg., 721 Minnesota Ave., Kansas City, Kas.

MISSOURI AND MISSISSIPPI SECTION.
States of Iowa, Missouri, Kansas, Nebraska, Arkansas, Mississippi, Alabama (other than Mobile), Tennessee, North and South Dakota, Oklahoma and Minnesota.

THOS. NOLAN.....Second Int. Vice-President
700 Court St., Portsmouth, Va.
GULF AND SOUTH ATLANTIC SECTION.
States of Texas, Louisiana, Florida, Georgia, North and South Carolina, Virginia, Maryland and Delaware, and Mobile, Ala.

J. P. MERRIGAN.....Third Int. Vice-President
91 Manufacturer St., Montreal, Que., Can.
CANADIAN SECTION.
The Dominion of Canada.

LOUIS WEYAND.....Fourth Int. Vice-President
6201 Fir Avenue, N. W., Cleveland, Ohio.
GREAT LAKES AND TERRITORY SECTION.
States of Wisconsin, Michigan, Cities of Chicago, Toledo, Cleveland and Lorain, O., Erie, Pa., State of New York (other than the City of New York).

District Lodges and Officers

DISTRICT No. 2—New York, N. Y. Meets 1st and 3rd Wed. Patrick T. Kenneally, President, 9 Magnolia Ave., Jersey City, N. J.

Wm. Brown, Vice-Pres., Elizabeth Ave., Elizabeth, N. J.
Gerald A. Daly, Sec.-Treas., 676 60th St., Brooklyn, N. Y.

DISTRICT No. 5—St. Louis, Mo. Mo. Pac. and Iron Mountain R. R. Lodges represented: 32, 38, 44, 66, 82, 106, 113, 117, 286, 322, 403, 507, 521, 542, 543, 565, 583 and 599.

John C. Morrow, Pres., 613 W. 4th St., Coffeyville, Kans.
Hal. Stack, Vice-Pres., Van Buren, Ark.

John J. Murphy, Secy., 3404 Eads Ave., St. Louis, Mo.

J. N. Shirley, Treas., Box 495, Hoisington, Kans.

A. E. Stewart, Member Ex. Board, 2533 Myrtle Ave., Kansas City, Mo.

A. J. Radford, Member Ex. Board, 624 Oak St., Little Rock, Ark.
Chas. A. McDonald, E. A., 4414 Winsor St., Kansas City, Mo.

DISTRICT No. 6—Southern Pacific R.R. Lodges represented: 32, 33, 46, 48, 52, 74, 92, 49, 98, 101, 113, 179, 193, 206, 216, 223, 239, 252, 309, 345, 339, 538, 553, 169.
J. J. Jones, Pres. and C. S., 1630 New Hampshire Ave., Los Angeles, Cal.

J. C. Carroll, V.-P., North Platte, Neb.

S. T. Feazelle, Sec.-Treas., Gate City Hotel, Pocatello, Idaho.

DISTRICT No. 10—Davenport, Ia. Rock Island System. Lodges represented: 377, 144, 346, 193, 340, 293, 323, 434, 439, 491, 96, 32, 66, 476, 522, 523.

Geo. W. Pring, Pres. & B. A., 677 38th St., Des Moines, Ia.
John Mitchell, V.-P., 1502 McGowan St., Little Rock, Ark.

W.M. ATKINSON.....Fifth Int. Vice-President
212 South Pittsburg St., Spokane, Wash.
ROCKY MOUNTAIN AND PACIFIC COAST SECTION.

Honolulu, States of California, Oregon, Washington, Idaho, Utah, Nevada, Montana, Wyoming, Colorado, Arizona, Old Mexico, New Mexico and Canal Zone, Panama.

JOHN J. DOWD.....Sixth Int. Vice-President
133 Wegman Place, Jersey City, N. J.
EASTERN SEABOARD SECTION.

States of Maine, New Hampshire, Vermont, Massachusetts, Rhode Island, Connecticut, New Jersey and New York City.

M. A. MAHER.....Seventh Int. Vice-President
2114 Eighteenth St., Portsmouth, Ohio.

OHIO VALLEY AND TERRITORY SECTION.
States of Pennsylvania (other than the city of Erie), Ohio, West Virginia, Kentucky, Indiana and Illinois (other than the City of Chicago).

JOS. P. RYAN.....Eighth Int. Vice-President
5830 Wentworth Ave., Chicago, Ill.
Phone Wentworth 8739.

HELPERS' VICE-PRESIDENT OF WESTERN SECTION.
All states west of dividing line between Indiana and Ohio.

JOHN F. SCHMITT.....Ninth Int. Vice-President
1489 N. Fourth St., Columbus, Ohio.
HELPERS' VICE-PRESIDENT OF EASTERN SECTION.

All states east of dividing line between Indiana and Ohio.

S. T. Sample, C. & F. S., 515 N. Jackson St., Pratt, Kas.
J. J. Lynch, Treas., Box 655, Herington, Kas.

DISTRICT No. 12—New York, New York Central System. Lodges represented: 5, 7, 10, 64, 67, 85, 150, 157, 169, 175, 197, 218, 223, 229, 321, 413, 492.
A. M. Anderson, Pres., 2208 Francis St., Jackson, Mich.

G. H. Gates, Vice-Pres., 148 N. Orchard St., Watertown, N. Y.
J. J. Leamy, Sec.-Treas., 68 Livingston Ave., Albany, N. Y.
Trustees—Wm. Weber, E. J. McNamara and Thomas Ranger.

DISTRICT No. 13—Birmingham, Ala. Southern R. R. System. Organized Feb. 23, 1904. Lodges represented: 2, 4, 12, 14, 40, 50, 28, 105, 143, 170, 226, 235, 312, 320, 334, 344, 369, 419, 511, 524; H. D., 27, 111, 175, 240.

Thos. J. Garvey, Pres., 414 E. Byrd St., Richmond, Va.

A. E. Barksdale, V.-P., 543 E. Lafayette St., Jackson, Tenn.
P. E. Berney, Sec.-Treas., R. F. D. 12, Knoxville, Tenn.

DISTRICT No. 15—Chicago, Ill. C. & N. W. R. R. Lodges represented: 38, 60, 129, 145, 161, 201, 227, 311, 395, 440, 485, 496, 539, 597.

W. F. Scholes, Pres., 1929 Ave., B. Council Bluffs, Ia.
J. W. Francis, V.-P., 534 Springfield Ave., Chicago, Ill.

T. E. Burdette, Sec.-Treas., 428 North Chesnut Ave., Green Bay, Wis.

DISTRICT No. 19—Roanoke, Va. Norfolk & Western System. Lodges represented: 28, 402, 30, 405, 557. Meets Union Labor Hall.

C. D. Craft, Pres., 1402 Center St., Portsmouth, O.

M. F. Glenn, V.-P., 1414 McConnell Ave., Portsmouth, Ohio.
J. B. O'Brien, Treas., Roanoke, Va.

E. J. Horgan, C. & F. S., 404 7th Ave., S. E., Roanoke, Va.

DISTRICT No. 20—Ill. Cent. R. R. Headquarters, Chicago, Ill.

Lodges represented: 56, 88, 133, 137, 40, 224, 426, 180, 220, 234, 300, 315, 363, 399, 95; H. D., 97, 106, 116, 102, 230, 174, 232, 223.
K. H. Eicker, Pres., 315 Dane St., Waterloo, Ia.

W. T. McCoid, V. P., 412 Madison St., Clinton, Ill.
E. G. Pullen, C. S. & Treas., 303 Columbia St., Waterloo, Ia.

DISTRICT No. 22—D. R. G. System, Colorado and Utah. Meeting place, Denver, Colorado; Date meeting, 2d Monday in July, 1915; Lodges represented: 44, 103, 179, 335, 427, 446, 473.
Geo. S. Warden, Pres. & B. A., 1507 E. 7th St., Pueblo, Colo.

H. F. Jones, Vice-Pres., 135 Sackett Ave., Salida, Colo.
A. A. Duncan, Sec.-Treas., Box 611, Alamosa, Colo.

DISTRICT No. 23—Meets at St. Louis, Mo., 2d Monday in October, 1914. Lodges represented: 4, 22, 27, 70, 95, 96, 180, 286, 418, 449, 458, 530, 531, 543, 546, 565, 575.

A. F. Bingham, Pres. and B. A., 701 Lombart St., Springfield, Mo.

L. W. Lawson, V.-P., 821 N. Maxey St., Sherman, Texas.

J. W. Reddick, Financial and Recording Secretary, 817 Lincoln St., Springfield, Mo.

A. A. Denton, Cor. Sec. and Treas., 1044 W. Mt. Vernon St., Springfield, Mo.

DISTRICT No. 24—Springfield, Ill. Wabash System. Lodges represented: 54, 81, 267, 384, 581, 594.

Edward F. Siebold, Pres., 1130 St. Mary's Ave., Ft. Wayne, Ind.

Wm. F. Furrow, Vice-Pres., 1017 E. Eldorado St., Decatur, Ill.

F. R. Lee, Secy-Treas., 601 Monroe Ave., Moberly, Mo.

DISTRICT No. 25—Livingston, Mont. Northern Pac. R. R. J. G. Brown, Pres., 610 N. 9th St., Brainerd, Minn.
Frank Depender, V.-P., 735 E. Nora Ave., Spokane, Wash.
Theo. W. Everett, Sec.-Treas., P. O. Box 554, Livingston, Mont.

Trustees—A. H. Shanks, 221 N. 2nd St., Missoula, Mont.; Hugh Roberts, Gen. Del., Glendive, Mont.; G. M. Owens, 312 So. E. St., Livingston, Mont.
DISTRICT No. 26—Aberden, S. D. C. M. & St. P. and Puget Sound R. Rs. Lodges represented: 11, 15, 22, 38, 41, 104, 244, 302, 485, 520, 528, 568, 588, 595, 603, 606.
 G. H. Hawksworth, Pres., Box 817, Deer Lodge, Mont.
 F. J. O'Brien, Vice-Pres., Avery, Idaho.
 Ed. McSperritt, Secy., Gen. Del., Miles City, Mont.
 P. W. Gunn, Treas., 3316-30 Ave., South, Minneapolis, Minn.
 J. L. Callahan, B. A., 3606 Clifton St., Milwaukee, Wis.
DISTRICT No. 27—Int. G. N. R. E. W. O. Faulk, Pres., Palestine, Tex.
 W. K. Saddler, Vice-Pres., Mart, Texas.
 E. H. Frick, Sec.-Treas., San Antonio, Tex.
 W. B. Graham, B. A., Palestine, Tex.
DISTRICT No. 29—Cincinnati, O. C. H. & D. R. R.
 W. J. Redmond, Pres., 204 N. Wash. St., Indianapolis, Ind.
 A. R. Griesheimer, Vice-Pres., 329 N. Elizabeth, Lima, O.
 Wm. J. McGee, Jr., Sec.-Treas., 1255 Richmond St., Cincinnati, O.
DISTRICT No. 30—Canadian Pacific. District Headquarters, Winnipeg, Man. Lodges in affiliation: 126, 134, 194, 379, 392, 451, 466, 478, 505, 529, 548, 417.
 Geo. F. Chadburn, Pres. and Acting Sec.-Treas., 1585 Alexander St., Winnipeg, Man.
 J. B. Smith, V.-P., 162 Annette St., Toronto, Ont.
 R. Carswell, V.-P., 684 Home St., Winnipeg, Man.
DISTRICT No. 31—Cincinnati, O. B. & O. System. Lodges represented: 5, 10, 79, 99, 105, 135, 241, 259, 318, 328, 332, 444, 493, 498, 514, 579, 578.

J. C. Smith, Pres., Box 292, Garrett, Ind.
 J. R. Cline, Vice-Pres., Cleveland, O.
 M. W. Luke, Sec.-Treas., 1007 W. Main, Washington, Ind.
DISTRICT No. 32—Grand Rapids, Mich. Pere Marquette System. Lodges represented: 34, 124, 413.
DISTRICT No. 34—Boston, Mass. Boston & Maine System. Lodges represented: 245, 371, 388, 481, 515, 517. Meets at Boston, Mass., 1st Monday in August and 2d Monday in February.
 W. H. Wells, Pres., 108 Westford St., Lowell, Mass.
 P. J. Kelley, Vice-Pres., 3 Devon St., Greenfield, Mass.
 T. J. Donahue, Sec.-Treas., 5 Ferndale St., Lowell, Mass.
DISTRICT No. 35—Parsons, Kas. M. K. & T. R. R. System. Lodges represented: 292, 209, 501, 576 and 265.
 Fred Alsord, Pres. & B. A., 515 W. Owings St., Denison, Tex.
 C. Dudding, V.-Pres., 2229 Crawford St., Parsons, Kas.
 Robt. Rosbottom, Sec.-Treas., 600 W. Texas St., Denison, Tex.
 C. A. Denton, Rec. Sec., Parsons, Kas.
 Wm. Dickerson, Chairman Trustees, 810 Cleveland St., Waco, Tex.
DISTRICT No. 37—Texarkana, Tex. Cotton Belt R. R. System. Meets 3d Saturdays in January and July.
 R. M. Cummins, Pres. & B. A., 308 E. Valentine St., Tyler, Tex.
 John A. Smith, V.-P., 1908 E. 8th St., Pine Bluff, Ark.
 B. E. Shields, Sec.-Treas., 1503 E. 7th Ave., Pine Bluff, Ark.
DISTRICT No. 38—Atlantic Coast Line. Lodges represented: 20, 26, 239, 422, 425, 448, 570.
 A. J. Dixon, Pres., Rocky Mount, N. C.
 W. A. Cahill, Vice-Pres., Montgomery, Ala.

E. S. Ryan, Sec.-Treas., 508 Lackawana Ave., Jacksonville, Fla.
DISTRICT No. 39—Central of Georgia System. Meets 1st Friday after Thanksgiving each year at Columbus, Ga. Lodges represented: 4, 12, 26, 436, 510.
 R. J. Black, Pres., 913 2nd St., Macon, Ga.
 J. J. Dean, Vice-Pres., 226 Taylor St., Savannah, Ga.
 Chas. A. Buchhell, Sec.-Treas., 103 Gordon W., Savannah, Ga.
 R. M. Kendrick, Rec. Sec., Route 5, Cedartown, Ga.
 R. S. Barry, Cor. and Fin. Sec., 1109 5th Ave., Columbus, Ga.
DISTRICT No. 40—Hamlet, N. C. Seaboard Airline and leased lines. Lodges represented: 2, 20, 25, 173, 298.
 B. M. Jewell, Pres., 727 W. Monroe St., Jacksonville, Fla.
 J. F. Brice, Vice-Pres., 204 Whitehall St., Atlanta, Ga.
 W. J. Wertz, Secy.-Treas., 333 Tattarnall St., Savannah, Ga.
DISTRICT No. 41—Hinton, W. Va. Chesapeake & Ohio System. Lodges represented: 170, 238, 249, 364, 384, 525.
 R. L. King, Pres., 822 N. Twenty-sixth St., Richmond, Va.
 L. F. Moats, Vice-Pres., 159 W. Third St., Peru, Ind.
 C. L. Barnett, Sec.-Treas., 419 Summers St., Hinton, W. Va.
 Trustees—M. L. Steinbuck, Box 336, Clifton Forge, Va. D. C. Dowdy, 2046 7th Ave., Huntington, W. Va., A. J. Poke, 1817 Scott Ave., Covington, Ky.
DISTRICT No. 42—Danville, Ill. Chicago & Eastern Illinois R. R. Meets 1st Tues. in Feb., 1916. Lodges represented: 22, 95, 575.
 G. D. Davis, Pres. and B. A., 18 N. Hazel St., Danville, Ill.
 James B. Keenan, V.-P., 1006 E. Madison St., Danville, Ill.
 Office Henthorn, R. & F. S., 102 Iowa St., Danville, Ill.
 A. Welch, Cor. Sec. & Treas., Villa Grove, Ill.

Subordinate Lodges and Officers

1—CHICAGO, ILL. 2d-4th Wed., Bricklayers' Hall, Monroe and Peoria Sts.
 James McKiernan, Pres.
 John E. Burke, C. & F. S., 3009 Archer Ave.
 John Dohney, 8123 So. Peoria.
2—ATLANTA, GA. 2d-4th Thurs.
 A. D. Lundbon, Pres., 224 E. Fair.
 John Fitcher, C. S., 406 Pullian.
3—ST. PAUL, MINN. 1st-3d Fri., New Odd Fellows' Home, 9th and Franklin.
 Geo. Cox, Pres., 1746 Logan.
 Wm. Harrington, F. S., 695 Pine.
 Wm. Parranto, B. A., 400 E. Jenks.
4—BIRMINGHAM, ALA. 1st-3d Tues., K. of C. Hall.
 Fred Baker, Pres., 2021 1/2 3d Ave.
 A. L. Carmack, F. S. & B. A., Office: 335 Hood Bldg.
5—CLEVELAND, OHIO. 1st-3d Thurs., Room 3, Federation Hall, 310 Prospect.
 Chas. Tongreen, Pres., Superior.
 G. H. Brady, C. S. & B. A., 310 Prospect.
7—BUFFALO, N. Y. 2d-4th Fri., Council Hall, 33 E. Warron.
 Geo. F. Muir, Pres., 116 Goodell.
 Thos. J. King, C. S., 1943 Seneca.
 Frank P. O'Brien, F. S., 238 Schiller.
8—COLUMBUS, O. Meets 2d-4th Thurs., F. of L. Hall.
 Chas. L. Nicklaus, Pres., 473 Poplar Ave.
 Adam Ruckel, C. S., 267 Liebert.
10—INDIANAPOLIS, IND. 2d-4th Thurs., 114 N. Delaware.

E. P. Leopard, Pres., 206 N. Tremont Ave.
 Wm. Frohlinger, C. S., 542 East Louisiana St.
 L. E. Hirsch, F. S., 851 Ashland Ave.
11—MINNEAPOLIS, MINN. 2d-4th Mon., Richmond Hall, 223 5th St.
 H. P. Farly, Pres., 1356 Vine Place.
 E. A. Conlin, C. S., 2404 Bloomington Ave.
12—MACON, GA. 2d-4th Friday, Morgan's Hall, cor. Elm and Broadway.
 J. T. Fenlon, Pres., 1974 Third St.
 R. J. Black, C. & F. S., 913 2d.
14—CHATTANOOGA, TENN. Central Labor Hall, 8th and Cherry Sts., 2d-4th Mon.
 Wm. Quigley, Pres.
 Jas. E. Evans, C. & F. S., 19 Jefferson.
15—DUBUQUE, IOWA. 1st-3d Tues., Union Hall, 19th and White Sts.
 E. Keck, Pres., 1272 Lincoln Ave.
 R. Ruof, C. & F. S., 975 Clay St.
16—JERSEY CITY, N. J. 1st-3d Mon., Fischer's Hall, Newark Ave., cor. Erie St.
 Patrick J. Kennally, Pres., 209 Magnolia Ave.
 Hugh Fitzpatrick, C. S., 244 York.
 Ed. McCarty, B. A.
19—PHILADELPHIA, PA. 2d-4th Fridays, Bricklayers' Hall, Broad and Fairmount Ave.
 Frank Goodfellow, Pres., 159 W. Palmer St.
 R. S. Hopkins, C. S., 2426 S. Clarion.

20—JACKSONVILLE, FLA. Meets every Monday, Central Labor Hall, 46 1/2 W. Bay.
 C. A. Clarke, Pres.
 E. S. Ryan, C. & F. S., 508 Lackawana Ave.
21—NEW YORK, N. Y. 1st-3d Mon.
 John H. Sullivan, Pres., 607 W. 46th St.
 James McGeney, C. S., 352 Schermerhorn St., Brooklyn, N. Y.
 Thomas Broadley, F. S., 519 W. 42d St.
22—DANVILLE, ILL. 1st-3d Mon., Trades and Labor Hall.
 Ray Schenk, Pres., California St.
 Wm. J. Irwin, C. S., 7 Illinois.
 Frank Jergens, F. S., 418 N. Bowman Ave.
 G. D. Davis, B. A., 18 N. Hazel.
25—SAN FRANCISCO, CALIF. Roesch Hall, 15th and Mission Sts., 2d-4th Thurs.
 John Kane, Pres., 41 Collingwood.
 Thos. J. Sheridan, C. S. & Treas., 2312 24th St.
 Wm. P. Bowser, B. A., 314 14th.
26—SAVANNAH, GA. 1st-3d Tues., Whittaker St. and Liberty Lane.
 E. C. Howie, Pres., 1110 E. 32d St.
 R. B. Allen, C. S., 509 E. 32d St.
27—ST. LOUIS, MO. 2d-4th Thurs., 10th and Carr.
 Larry Kickham, Pres. & B. A., 5322 Vernon Ave.
 James Callahan, C. S., 3408 Laclede Ave.
 Henry Seikmann, F. S., 1908A Madison.

- 29—**ROANOKE, VA.** 2d-4th Wed., Labor Home Hall, Commerce and Salem Aves.
G. J. Lucas, Pres., 1121 2d Ave. N. W.
J. R. Anderson, C. S., 502 Campbell Ave.
- 30—**ROANOKE, VA.** 2d-4th Mon., Labor Hall, cor. Commerce St. and Salem Ave.
C. E. Eades, Pres., 318 7th Ave. N. E.
B. I. Wade, C. S., 811 Jamison Ave.
- 31—**ST. JOSEPH, MO.** 2d-4th Mon., Jucker Hall.
B. E. Stitts, Pres., 2228 So. 6th. Edward Knight, C. S., 2119 So. 9th St.
- 32—**KANSAS CITY, MO.** 2d-4th Fri., Labor Temple, 14th and Woodland.
Thomas Mulvihill, Pres., 3715 Springfield St., Rosedale, Kas.
W. E. Dwyer, C. & F. S., 4402 Windsor.
Chas. McDonald, B. A., 4416 Norledge.
- 37—**NEW ORLEANS, LA.** 2d-4th Wed., Martin's Hall, Iberville & Exchange Place.
Wm. J. Smith, Pres., 228 Morgan St., Algiers, La.
Lewis J. Costella, C. S. & B. A., 638 N. Olympia.
Victor Escousse, F. S., 617 Alix St., Algiers, La.
- 38—**OMAHA, NEB.** 1st-3d Wed., Blair Hall, 19th & Farnum.
M. J. McGovern, Pres., 1617 Burt. L. G. Rankin, C. S., 2825 Cass.
J. H. Massman, F. C., 1511 Locust.
- 39—**SOUTH CHICAGO, ILL.** 2d-4th Tues., Union Headquarters, 92d St. and Erie Ave., South Chicago.
Frank Bacton, Pres., 10149 Ave. J. John Coglan, C. S. & B. A., 9344 Ave. H.
Jos. Manners, F. S., 10123 Ave. L.
- 40—**LOUISVILLE, KY.** 2d-4th Wed., in Beck's Union Hall, 1st and Jefferson Sts.
Thomas Mitchell, Pres., 1422A Broadway.
F. J. Kiesler, C. S., 212 Collins Court.
- 41—**HARLOWTON, MONT.** 2d-4th Thurs., Winer Hall.
John Dennis, Pres.
Harry Schultz, C. & F. S.
- 42—**NASHVILLE, TENN.** 2d-4th Thurs., Carpenters' Hall, 342 1/2 4th Ave. N.
James E. Kanan, 1006 E. Madison St., Danville, Ill.
H. R. Brown, Pres., 611 1/2 Church. W. T. Pentecost, C. S., 2143 Oakland Ave.
- 44—**PUEBLO, COL.** Every Thurs., New Pope Blk., Main bet. 3d and 4th Sts.
Walter M. Pitts, Pres., 631 E. 5th St.
Geo. S. Warden, C. & F. S., 1507 E. 7th St.
- 45—**BROOKLYN, N. Y.** Greenpoint and Manhattan Aves., 2d-4th Thurs.
Gerald A. Daly, Pres. & C. S., 676 60th St.
M. J. Callahan, F. S., 119 Terrell
- 46—**CHEYENNE, WYO.** Union Hall, 2d-4th Wed.
Geo. R. Wallace, Pres., P. O. Box 151.
E. Cole, C. S., 215 E. 9th St.
- 47—**DES MOINES, IA.** 1st-3d Thurs., Trades Assembly Hall.
James Gillespie, Pres., 1113 Columbus Ave.
Fritz Johnson, C. & F. S., 922 W. 1st St.
- 48—**LARAMIE, WYO.** 1st-2d Tues., Moose Hall.
Jacob Claus, Pres., 114 Cedar St.
Frank M. Lepper, C. S., 360 N. 3d St.
- 50—**CHARLESTON, S. C.** 1st-3d Tues., Y. M. C. A. Hall, George St.
H. J. Hartnett, Pres., 18 Anson St.
John J. Clair, C. & F. S., 196A Spring St.
- 51—**ST. LOUIS, MO.** 2d-4th Wed., Lafayette Hall, 17th and Cass Ave.
Frank H. Johannngmire, Pres., 1923 Sullivan Ave.
Mike Whalen, C. S., 1715 N. 11th St.
Geo. Wheaton, F. S., 4159 Lee Ave.
- 54—**FORT WAYNE, IND.** Last Wed., West Berry St.
Edward F. Siebold, Pres. & C. S., 1130 St. Mary's Ave.
O. P. Ewald, F. S., 1419 S. Calhoun.
- 55—**NEWPORT NEWS, VA.** Every Wed., 3 p. m., C. L. U. Hall, 32d and Wash. Ave.
Wm. H. Healy, Pres., 3711 Huntington Ave.
D. McArthur, C. S., 311 37th.
W. Hannah, F. S., P. O. Box 430.
- 56—**VICKSBURG, MISS.** 1st-3d Tues., K. of P. Hall, N. Washington St.
Ed. Snelling, Pres., 2137 Washington St.
W. C. Hughes, C. & F. S., 2312 Mulberry.
- 57—**PORTSMOUTH, VA.** 1st-3d Thurs., C. L. U. Hall.
O. C. Hartung, Pres., 1248 Park Ave.
J. H. Parrish, F. S., 622 Clifford.
Geo. Thomas, C. S., 204 Lincoln.
- 60—**PEORIA, ILL.** 1st-3d Mon., 411 Cedar St.
Andy Yates, Pres., 1709 S. Adams.
F. Hierspiel, C. S., 410 Warner Ave.
- 61—**NEW HAVEN, CONN.** 1st-3d Thurs., Boardman Bldg., cor. State and Chapel Sts.
Wm. Hefferman, Pres., 95 Carlyle.
M. J. Whalen, C. & F. S., 138 Carlyle.
- 64—**JACKSON, MICH.** Every Tues., Labor Hall, Main and Jackson Sts.
Geo. Bonea, Pres., 140 Bates.
Ed. McNamara, C. S., 619 South Pleasant St.
- 65—**VICTORIA, VA.** 2d-4th Sundays, Lunenburg Hall.
J. H. Jones, Pres., Gen. Del.
W. H. Slayton, C. S., Gen. Del.
- 66—**LITTLE ROCK, ARK.** 1st-3d Thurs., Brannon Hall, Markham and Cross Sts.
W. J. Flynn, Pres., 908 Denison.
E. Wortsmith, C. & F. S., 300 W. 11th St., Argenta, Ark.
C. A. McDonald, B. A., 4416 Norledge, Kansas City, Mo.
- 67—**BAY CITY, MICH.** 1st-3d Thurs., Central Trades Council Hall.
Wm. H. Benedict, Pres., 703 E. Winona Ave., W. S.
Joe Malton, V.-P., 317 S. Jackson.
Nelson Heglung, C. & F. S., 514 Adams St.
- 68—**PINE BLUFF, ARK.**—2d-4th Wed., Labor Temple.
A. J. Barton, Pres., 1701 W. 6th.
B. E. Shields, F. S., 1503 E. 7th.
J. A. Smith, C. S., 1908 E. 8th.
- 70—**SPRINGFIELD, MO.** 2d-4th Wed., Eagles' Hall, E. Commercial St.
R. A. Lines, Pres., 316 W. Atlantic St.
Scott Daffer, C. & F. S., 937 Broad St.
A. F. Bingham, B. A., 701 Lombard St.
- 72—**PORTLAND, ORE.** 2d-4th Thurs., 230 1/2 Yamhill St.
Arthur Gallon, Pres., 649 Milwaukee.
F. E. Disbrow, C. & F. S., 810 E. 11th.
Joe Reed, B. A., 507 Bismark.
- 73—**TROY, N. Y.** 2d-4th Mon., Swan and Georgia Sts., Mechanics' Hall.
Huntington Ave.
John Donnelly, Pres., 23 3d St.
Cohoes, N. Y.
David Boyd, C. & F. S., 319 9th St., Waterloilet, N. Y.
- 74—**HOUSTON, TEXAS.** 1st-3d Wed., Woodman Hall, 1823 Washington St.
D. C. Bryan, Pres., 4607 Washington.
F. C. Jackson, C. & F. S., 3118 Lublick St.
- 79—**GARETTT, IND.** 1st-3d Tues., K. of P. Hall, Randolph.
Geo. Richmond, Pres., 214 E. Keyser.
J. C. Smith, C. & F. S., Box 223.
- 80—**ANACONDA, MONT.** 2d-4th Wed., M. & M. Hall, Lodge Box 372.
J. C. Smith, Pres., 510 Cherry St.
James W. Hogan, C. S., 300 Birch.
- 81—**SPRINGFIELD, ILL.** 2d-4th Tues., Fortunes Hall.
Ed Sellers, Pres., 130 E. Edwards.
Louis L. Mutter, C. & F. S., 1631 S. 8th.
- 82—**OSAWATOMIE, KAS.** 1st-3d Mon., K. & L. Sec. Hall.
Hurb Fader, Pres.
J. E. Sturgess, C. & F. S., Box 64.
C. A. McDonald, B. A., 4416 Norledge, Kansas City, Mo.
- 83—**KANSAS CITY, KAS.** 2d-4th Tues., K. F. Hall, 624 Minn. Av.
Thomas Knowles, Pres., 760 Shawnee.
Frank Stover, C. & F. S., 322 Nebraska Ave.
- 84—**GRAND RAPIDS, MICH.** 1st-3d Mon., Trade & Labor Hall, 67 Monroe Ave.
Frank C. Lemke, Pres., 551 Shamrock St.
Nelson M. Warren, C. S., 127 E. Delaware St.
- 85—**TOLEDO, OHIO.** 2d-4th Tues., Mitchell's Hall, cor. Walnut and Summit Sts.
J. S. Durst, Pres., 163 Gibbons St.
Ellsworth Richardson, C. S., 1137 Western St.
- 86—**DALLAS, TEX.** 1st-3d Mon., Broadnar Hall.
W. H. Riley, Pres., 1408 Corinth.
C. B. Stout, C. S., R. R. 10, Box 84.
- 88—**JACKSON TENN.** 2d-4th Fri., Labor Hall.
B. B. Seward, Pres.
A. E. Barkdale, C. S., 119 E. Orleans St.
- 90—**SUGAR CREEK, MO.** 2d-4th Thurs., Woodman's Hall.
L. Novak, Pres.
C. R. Snider, C. & F. S., 1222 W. Electric St., Independence, Mo.
- 91—**ELMWOOD PLACE O.** 1st-3d Mon., Kellers Hall.
Geo. Urban, Pres., St. Bernard. O.
John Cullen, C. S., 39 Prosser Ave.
- 92—**LOS ANGELES, CAL.** 2d-4th Wed., Union Labor Temple, 540 Maple Ave.
Charles Clarke, Pres., 206 S. Workman St.
H. E. Herman, C. & F. S., 530 S. Griffin Ave.
- 93—**JOLIET, ILL.** 2d-4th Tues., Conner's Hall.
John Buckley, Pres., 111 Willard Ave.
Richard Farrell F. S., 503 London Ave.
Charles Mork, C. S., 424 Landon Ave.
- 94—**SACRAMENTO, CAL.** 1st-3d Thurs., Labor Temple.
J. Grabfelder, Pres., 3001 G St.
J. S. Heller, Acting C. S., 1317 15th St.
- 95—**EVANSVILLE, IND.** 2d-4th Mon., Ruh's Hall.
Chas. T. Mooney, Pres., 1802 Michigan.
Herman H. Grundman, C. & F. S., 307 Mary St.

- 93—FORT WORTH, TEX.** E. of L. F. & E. Hall, 1st-3d Thurs. J. J. Dempsey, Pres., 504 Calhoun. L. A. Freeman, C. & F. S., 3250 Jennings St.
- 99—NEWARK, OHIO.** Druid's Hall, S. 3d St., 1st-3d Sun. Emil Indlekofer, Pres., 68 Curtis Ave. Cecil Roberts, C. & F. S., 45½ S. Third St.
- 100—MARSHALL, TEX.** 1st-3d Tues., I. O. O. F. Hall. Smith Hayden, Pres., 514 Greenwood Ave. J. P. O'Neil, C. & F. S., 708 E. Ruak.
- 103—SALT LAKE CITY, UTAH.** Labor Temple, 3d East, bet. 1st and 2d S. St., 1st-3d Wed. Wm. H. Garrick, Pres., 416 Edith Ave. B. S. R. Harrison, C. & F. S., 562 Ouray Ave.
- 104—SEATTLE, WASH.** 1st-3d Thurs. Labor Temple, 6th and University St. Fred Counter, Pres., 3260 15th Ave., So. Dan McKillop, Sec. & B. A., 166½ 10th Ave., Phone Elliott 845W.
- 105—CINCINNATI, OHIO.** 2d-4th Tues., Workman's Hall, Mercer and Walnut Sts. Chas. Granger, Pres., 329 Union St., Bellevue, Ky. D. L. O'Brien, C. S. & B. A., 23 Forest Ave., Ludlow, Ky. Frank Bareswilt, F. S., 1023 5th Ave., Dayton, Ky.
- 106—MCGHEE, ARK.** 2d-4th Wed., K. of P. Hall. Wm. E. Crupper, Pres., Box 215. Chas. A. Stewart, C. & F. S., Box 432.
- 107—MILWAUKEE, WIS.** 1st-3d Tues., Speers Hall, Cor. National & 3d Ave. J. Hoppens, Pres., 1302 Fraternity. R. Dale, Fin. Sec., 319 4th Ave. P. Sonnenberg, C. S. & B. A., 623 Greenbush.
- 108—AUGUSTA, GA.** 2d-4th Tues., Machinists' Hall, Broad. Patrick Rice, Pres., 1342 Walton Way. E. E. Bennett, C. S., 1406 Silcox.
- 109—CHADRON, NEB.** J. W. Boyd, Pres. Ed Grady, C. S., Gen. Del.
- 111—MISSOULA, MONT.** 2d-4th Tues., Eagler's Hall. H. A. Chase, Pres., Box 1304. A. Frasier, C. S., R. R. No. 1.
- 112—SEBALA, MO.** 1st-3d Tues., Labor Temple. Chas. Hall, Pres., Gen. Del. C. A. McDonald, B. A., 4416 Norledge, Kansas City, Mo. W. H. Sin., C. S., 1306 E. 7th St.
- 116—BRAINERD, MINN.** 2d-4th Fri., Trades and Labor Hall. Henry Voight, Pres., E. Oak. Wm. E. Good, C. S., Imperial Block.
- 117—DE SOTO, MO.** 1st-3d Mon., Federation Hall. R. B. Parks, Pres. S. L. Johnson, C. & F. S., Box 248.
- 118—NORTH PLATTE, NEB.** 4th Sat. K. of P. Hall. John Beth, Pres. Peter McGovern, C. S., 511 Locust.
- 122—LIVINGSTON, MONT.** 1st-3d Thurs., Trades and Labor Hall. C. D. Cain, Pres., 304 S. K St. Theo. W. Evert, C. & F. S., P. O. Box 554.
- 124—SAGINAW, MICH.** 1st-3d Fri., Petre & Meek's Hall, Genesee Ave. John Doyle, C. & F. S., R. F. D. No. 1.
- 125—WINNIPEG, MAN.** 1st Wed. and 3d Sun., 2:30 o'clock, Labor Temple. Wm. L. Hall, Pres., 1576 Elgin Ave. L. W. Prince, C. & F. S., 290 Milton.
- 130—CLINTON, IOWA.** H. Qualman, C. S., 231 14th Ave.
- 130—BUTTE, MONT.** 1st-3d Tues., Carpenters' Hall, cor. Granite and Montana Sts. T. F. Shulta, Pres. Harry Goodland, C. & F. S., 177 E. Center.
- 132—GALVESTON, TEX.** 2d Mon., Cooks and Waiters' Hall, 23d St. S. Nawdascher, Pres., 3223 Ave. H. E. T. Chester, C. & F. S., 2309 Ave. I.
- 133—WATERLOO, IOWA.** Central Labor Hall, 3d-4th Wed. E. G. Pullen, Pres., 502 Columbia St. Geo. A. McMillan, C. S., 702 Barclay St.
- 134—MONTREAL, QUE., CAN.** 1st-3d Fri., Monument National, St. Lawrence and Main Sts. Stephen Craig, Pres., 1251 Mosier. R. Chorlton, C. S., 1184 Desormier Ave.
- 135—CHILLICOTHE, O.** 1st-3d Mon., Plaecker Hall. L. J. Medert, Pres., 516 E. Water St. James Hunsinger, C. & F. S., 390 E. 4th St.
- 136—COLORADO CITY, COLO.** Red Men's Hall, 1st-3d Fri. H. J. Norton, Pres., care National Hotel. R. D. Wing, C. S., 12 So. 12th, Colorado Springs, Colo. J. H. Cook, F. S., 216 N. 12th.
- 137—PADUCAH, KY.** 2d-4th Sun., Central Labor Hall, 12½ N. 4th. B. C. Beadles, Pres., 1029 Madison. Wm. Black, C. & F. S., 315 N. 3d St.
- 138—HARRISON, ARK.** H. C. Heppard, Pres. T. T. Chubb, C. S.
- 140—PEN ARGYL, PA.** 2d-4th Mon., Steinmitt's Hall, Bangor, Pa. Joseph Wenninger, Pres. & C. S., care Realty. J. A. Morgan, Fin. Sec., care Albion House.
- 143—KNOXVILLE, TENN.** 219 N. Gay St., 1st-3d Tues. J. D. Krause, Pres., R. F. D. No. 1. Joe Galloway, C. S., 1000 Broadway. W. D. Amanns, F. S., R. F. D. No. 12, Lincoln Park.
- 144—CEDAR RAPIDS, IOWA.** 1st-3d Wed., I. O. O. F. Hall, cor. 1st St. and 2nd Ave. W. Chas. T. Bowman, Pres., 316 Ellis Blvd. Frank C. Schwarz, C. & F. S., 830 G Ave., W.
- 145—MISSOURI VALLEY, IOWA.** 1st-3d Thurs., Walker's Hall. Hans Witt, Pres., Box 181. Harvey Nichols, C. S.
- 148—VALLEJO, CALIF.** 1st-3d Tues., Vallejo Temple Hall. Wm. Fountain, Pres., 225A Penn. Harry Duthie, C. & F. S., 638 Captiol.
- 149—MARSHALLTOWN, IOWA.** 1st-3d Tues., Trades and Labor Assembly Hall, Main St. Chas. Vyskocil, Pres., 9 E. Boone. W. E. Pouley, C. S., 1110 W. Cole.
- 150—CHAMPAIGN, ILL.** 1st-3d Sun., 2:30 p. m., I. C. System Fed. Hall. Thos. H. Monahan, Pres., 511 W. Washington St. A. E. Strode, C. S., 325 Hickory.
- 153—GASSAWAY, W. VA.** J. E. Perkins, Pres., Gen. Del. R. Lee Boone, C. & F. S., Gen. Del.
- 154—PITTSBURGH, PA.** 1st-3d Fri., Labor Temple, cor. Washington and Webster Ave. Frank Bann, Pres., 304 South Ave. N. S. Henry J. Thumel, C. & F. S., 1213 Itin St. N. S. James P. Carr, B. A., Labor Temple, Wash. and Webster Ave.
- 155—BLOOMINGTON, ILL.** 1st-3d Mon., Redmen's Hall, Main and Front Sts. H. F. Lambrecht, Pres., 1004 N. Livingston St. L. J. Metzner, C. & F. S., 1207 N. Mason.
- 157—SYRACUSE, N. Y.** 1st-3d Wed., Bartenders' Hall, Clinton & W. Genesee St. J. J. Hardeny, Pres., 214 Hartson. Thomas Ranger, C. S., 130 Lydell.
- 161—BOONE, IOWA.** 1st-3d Mon., at Electrical Workers' Hall. Frank Whitman, Pres., 1602 Benton. H. W. Martens, C. & F. S., 1329 Meridan St.
- 163—HOBOKEN, N. J.** 2d-4th Fri., 500 Bloomfield St. Jeremiah Cahill, Pres., 38 Troy. P. L. Grownay, C. S., 1019 Willow Ave.
- 165—DULUTH, MINN.** 2d-4th Sat., Irwin-Sloan Block, 20th Ave. and Superior St. James A. Graham, Pres., 5705 Grand Ave., W. Duluth, Minn. Alfred S. Nelson, C. & F. S., 5705 Grand Ave., W. Duluth, Minn.
- 169—DETROIT, MICH.** 2d-4th Thurs., 273 Gratiot Ave. Charles Komes, Pres., 31 Celaren. Chas. F. Aderholdt, C. & F. S., 9 Sylvan St.
- 170—RICHMOND, VA.** 1st-3d Wed., Labor Temple, 5th and Marshall Sts. R. L. King, Pres., 323 N. 26th St. F. C. Blount, F. S., 1101 N. 23d. E. M. Daywalt, C. S., 2203 Venable St.
- 173—ALEXANDRIA, N. C.** B. F. Long, Pres., 218 N. McDowell. J. P. Taylor, C. & F. S., 615 W. North.
- 175—OSWEGO, N. Y.** 2d-4th Mon., 8 p. m., Forester Hall, E. Bridge St. Wm. Perau, Pres., 90 Hart St. James Gorman, C. S., 54 Murray.
- 176—ELIZABETH, N. J.** 2d-4th Wed., Dahmen Hall, 4th and E. Jersey St. John H. Reynolds, Pres., 33 Delaware St. Samuel M. Rankin, Secy., 64 Florida. E. J. McCarthy, B. A., 67 St. Mark's Place, New York City.
- 179—DENVER, COLO.** 2d-4th Wed., Room 301 McPhee Bldg., 17th and Glenarm. Geo. Gauss, Pres., 3869 Newton. H. Shaffroth, C. & F. S., 3749 Wynkoop St.
- 180—MEMPHIS, TENN.** Italian Hall, 1st-3d Fri. W. T. Funston, Pres., 389 Webster Ave. C. F. Gillenwater, C. S., 134 W. Iowa Ave.
- 187—MIAMI, ARIZ.** Every Tues., Miami Hall. J. W. Landers, Pres. Roy Drummond, C. & F. S., Box 1121.
- 191—VICTORIA, B. C.** 2d-4th Tues., 1424 Government St. A. Clyde, Pres. Sub. P. O. No. 2. A. Stewart, C. S., Box 48, Beaumont. P. O. Esquimalt, B. C.
- 193—BALTIMORE, MD.** Every Tues., Patterson Bldg., Baltimore and Gay Sts. John Shanley, Pres. James Chaney, F. S., 1419 Patapsica St. Philip Yingling, C. S., 410 E. 37th St.

- 194—VANCOUVER, B. C. CANADA. 1st-3d Mon., at Labor Temple.
A. Campbell, Pres., 17th Ave., West Vancouver.
A. Fraser, C. S., 1151 Howe St.
- 195—KEWANEE, ILL. 1st-3d Fri., O'Donnell's Hall, 3d St.
M. J. Carney, C. S., 411 N. 1st St.
- 197—ALBANY, N. Y. 31 Green St., 2d-4th Sat.
J. H. Sullivan, Pres. & B. A., 173 2d St.
Jno. J. Leamy, C. S., 68 Livingston Ave.
- 198—OGDEN, UTAH. 2d-3d Tues., Union Labor Hall on 24th St., bet. Washington and Grant.
F. S. Dunn, C. & F. S., 116 23d St.
- 199—MORTON, KAS. 1st-3d Thurs., Carman's Hall.
Barney Drew, Pres.
E. S. McGinnis, C. & F. S., Box 622.
- 200—STATEN ISLAND, N. Y. I. O. G. T. Hall, W. Brighton, S. I., N. Y., 1st-3d Mon.
Richard Hough, Pres., 55 Bay Ave., Pt. Richmond, S. I.
Ethan A. Johnson, C. S., 208 Broadway, W. Brighton S. I., N. Y.
E. McCarty, B. A., 67 St. Mark's Place, N. Y. City.
- 201—WINONA, MINN. Labor Temple, 1st-3d Tues.
Frank Rice, Pres., 574 W. 7th St.
W. Kukowski, C. S., 176 Mankato Ave.
J. H. Buchholtz, F. S., 251 E. King.
- 204—HONOLULU, H. I. Waverly Hall, 2d-4th Thurs.
Wm. Brown, Pres., Honolulu Iron Works.
Thos. Murrey, C. S., 1541 King.
- 205—SAN FRANCISCO, CALIF. 2d-4th Tues., Rosch Hall, 15th and Mission.
Wm. P. Bowser, Pres., 507 20th.
J. M. Enright, C. S., 1431 Delores.
Walter Anderson, F. S., 607 Anderson.
- Wm. P. Bowser, B. A., 314 14th.
206—ALGIERS, LA. 2d-4th Fri., RENECKY Hall.
Jos. Koenig, Pres. & C. S., 825 Elmira Ave.
C. A. Reynolds, F. S., McDonoughville, La.
- 209—DENISON, TEXAS. 2d-4th Mon., over State Nat. Bank.
A. McDowell, Pres., 504 W. Owings St.
S. E. Harris, C. & F. S., 923 W. Morgan St.
- 216—EL PASO, TEXAS. 2d-4th Thurs., Union Labor Hall.
Wm. Beeson, Pres., Gen. Del.
Frank H. Bait, C. S., 114 S. Stanton St.
- 218—SPRINGFIELD, MASS. 2d-4th Wed., Winkler's Hall, Bridges and Water St.
Michael Fitzgerald, Pres., 843 Caren St.
Wm. E. Donovan, B. A., 9 Arbor.
Jerh C. Driscoll, C. S., 141 Patton.
- 220—CHICAGO, ILL. 2d-4th Tues., Pusey's Hall, 901 E. 7th.
M. Casey, Pres., 6351 Drexel Ave.
A. G. Smith, C. & F. S., 7036 Harper Ave.
- 221—PITTSBURG, KAS. 1st-3d Tues., Red Men's Hall, W. 3d St.
E. E. Hiett, Pres., 1803 N. Grand Ave.
P. J. Hiett, C. S., 1801 N. Grand.
- 222—MART, TEXAS. W. O. W. Hall.
E. J. Blount, Pres.
G. W. Coates, C. & F. S.
- 223—UTICA, N. Y. Labor Temple, 2d Fri.
Louis Wengert, Pres., 8 Wiley St.
Edward Wengert, C. S., 43 Fass Ave.
- 225—ELMIRA, N. Y. 2d-4th Sun., Trades & Labor Hall, 200 E. Water St.
A. E. Stevenson, Pres., 964 McGee.
- N. P. Durnin, R. & C. S., 519 Penn Ave.
226—SALISBURY, N. C. W. O. W. Hall, Innes and Main Sts., 2d-4th Fri.
J. J. Garvey, Pres., E. Spencer, N. C.
P. P. Surratt, C. & F. S., Box 278, Spencer, N. C.
- 227—CHICAGO, ILL. Garfield Park Hall, 4039 W. Madison St., 2d-4th Sat.
John Seldon, Pres., 1107 Keeler Ave.
Thomas Dean, F. & C. S., 2214 W. 13th St.
- 229—ROCHESTER, N. Y. 2d-4th Wed., 14 N. Water St.
W. Weston, Pres., 17 Coffrey Place.
Robt. Little, C. S., 211 Garfield.
- 233—OAKLAND, CAL. 2d-4th Mon., cor. 7th and Peralta Sts.
H. Brown, Pres., 1003 Pine St.
Geo. Young, C. S., 1788 9th St.
- 235—COLUMBIA, S. C. 2d-4th Tues., Plumbers' Hall, 1623 Main St.
E. R. Fenell, Pres., 1712 Blanding.
J. W. Bankhead, C. & F. S., 1727 Laurel Ave.
- 236—MARQUETTE, MICH. 4th Thurs., E. Seigle's Hall.
Albert Bastien, Pres., 347 West Washington.
Arthur Bourgois, C. S., 817 North 3d St.
- 237—HARTFORD, CONN. 2d-4th Wed., at C. L. U. Hall, Central Row.
James Thornton, Pres., 52 Green.
John J. Relly, C. S., 46 Pliny.
- 238—CLIFTON FORGE, VA. 1st-3d Fri., Junior Hall.
A. J. Hauer, Pres., 34 Alleghany.
M. L. Steinbuck, C. & F. S., Box 338.
D. G. Clark, F. S., 192 Ridgeway.
- 239—ROCKY MOUNT, N. C. 1st-3d Mon., Machinist Hall, cor. Sunset and Main Sts.
A. J. Dixon, Pres., 208 Atlantic Ave.
J. S. Wakefield, C. S., Box 224.
- 241—WASHINGTON, IND. Zinkin's Hall, 3d and Vantrees Sts., 1st-3d Tues.
J. C. Mooney, Pres., East George.
M. W. Luke, C. & F. S., 1097 W. Main.
- 242—SPOKANE, WASH. 2d-4th Wed., Carpenters' Hall, No. 9 Madison St.
Frank Depender, Pres., 611 E. Indiana Ave.
R. L. Mason, C. S., 218 S. Pittsburg St.
- 243—BELLEFONTAINE, O. Last Sunday in each month, Eagles' Hall.
H. S. Dickenson, Pres., 329 Garfield.
R. E. McNeff, C. & F. S., 105 N. Elm.
- 244—SIOUX CITY, IOWA. Labor Temple, 5th St., near Pierce, 3d Wed.
John Ewing, Pres., 103 Alice St.
Robt. O'Hern, C. S., No. 5 14th.
- 245—CONCORD, N. H. 2d-4th Mon., Central Labor Union Hall.
Geo. Tanner, Pres., Hall St.
J. Berryman, C. S., 143 S. Main.
J. R. New, F. S., 120 Broadway.
- 246—TERRE HAUTE, IND. Cor. 8th and Wabash Ave., 1st-3d Tues.
H. M. Showalter, Pres., 1410 S. 17th.
Jesse Dukes, C. S., 1561 S. 18th.
F. Wittke, F. S., 1709 N. 12th.
- 247—TACOMA, WASH. 1st-3d Mon., Odd Fellows' Hall, S. Tacoma.
Andrew Hansen, Pres., 5406 So. Paks St.
Wm. Polzin, C. & F. S., 5814 S. Lawrence St., So. Tacoma, Wash.
- 249—HUNTINGTON, W. VA. Every Wed., Thompson Bldg., cor. 20th St. and 3d Ave.
J. S. Myers, Pres., 2720 Collis Ave.
Eugene Brennan, C. & F. S., 823 23d St.
D. C. Dowdy, B. A., 2048 7th Ave.
- 250—BOSTON, MASS. Hollis Hall, 724 Washington St., 1st-3d Fri.
James Downey, Pres., 8 Cathedral.
Jeremiah Murphy, C. S. & B. A., 107 Union Park St.
James Niece, F. S., 1177A Tremont.
- 254—CHICAGO HEIGHTS, ILL. 1st-3d Mon. at Trades & Labor Assembly Hall, West End Ave.
Thomas Hines, Pres., 1656 West End Ave.
Thomas Brooks, C. & F. S., 306 W. 15th Place.
- 256—POTTSVILLE PA. Wm. Greaff, Pres., 542 E. Market.
W. Smith, C. S., 215 Front, Minersville, Pa.
- 259—LIMA, OHIO. 2d-4th Thurs. 334 No. Main.
A. C. Thompson, Pres., East Finley.
A. K. Griesheimer, C. S., 329 N. Elizabeth.
Harry Gunn, F. S., 723 West Wayne.
- 265—SMITHVILLE, TEXAS. 1st-4th Mon.
M. C. Vaughn, Pres., P. O. Box 521.
Guy Cooper, C. & F. S., P. O. Box 356.
- 267—MOBERLY, MO. 2nd and 4th Thurs., Painters' Hall.
J. J. Cadagin, Pres.
F. R. Lee, C. S., 601 Monroe Ave.
- 276—ST. LOUIS, MO. 2d-4th Fri., N. E. Cor. 11th and Locust.
Herbert Abbey, Pres., 2618 Ann Ave.
Henry Waeckerle, C. S., 2919A Miami.
Clyde Stevens, F. S., 1914 N. 21st.
E. St. Louis, Ill.
- 278—ELKINS, W. VA. 2d-4th Thurs., Kendall Hall.
Geo. Cade, Pres., 620 Yokem.
C. H. Goodwin, C. & F. S., 3 Center St.
- 279—EDMONTON, ALB. CAN. 1st Mon., Calder, Edmonton.
Wm. J. Fitzmaurice, Pres., Box 2100, of E. D. & B. C. Ry.
James McLean, C. & F. S., 10236 113th St.
- 281—NORWOOD, MASS. 2d-4th Fri., 724 Washington St., Boston.
Arno Bennett, Pres., 185 Appleton St., Boston, Mass.
Robert Henderson, C. S., 274 Metropolitan Ave., Roslindale, Mass.
- 284—FREEPORT, ILL. Every 3d Wed. at Blust Hall.
J. W. Daniels, Pres., 27 Shawnee St.
E. L. Meyers, C. S., 80 Oak St.
- 286—FORT SCOTT, KAS. 1st-3d Mon., Redmen's Hall, 111 E. Wall St.
J. W. McNowen, Pres., 816 Marion Ave.
J. C. Bonesteel, C. S., 1213 So. National.
- 287—KINGSVILLE, TEXAS. W. B. Poor, Pres.
E. C. Martin, C. S., Box 162.
- 290—BREMERTON, WASH. Percy Counter, Pres., Charleston, Wash.
John Hornby, C. & F. S., Gen. Del.
- 292—PARSONS, KAS. 2d-4th Tues., Moose Hall.
C. Dudding, Pres., 2229 Crawford St.
E. P. Butler, C. S., 1723 Gabriel.
- 293—SHAWNEE, OKLA. 2d-4th Mon., Moose Hall.
Ed. S. Pine, Pres., 711 N. Tucker.
A. D. Ross, C. & F. S., 429 N. Park Ave.

- 298—PORTSMOUTH, VA. C. L. U. Hall, 2d-4th Thur.
M. A. Garlin, Pres., 2226 King.
H. W. Jarrett, F. S., 1822 County.
Robt. T. Howe, C. S., 826 4th St.
- 300—WATER VALLEY, MISS. I. O. F. Hall, 1st-3d Thur.
C. H. Baker, Pres. and Treas.
- 301—CANTON, OHIO, 1st-3d Mon., Switzer Hall, Cherry and 8th Sts.
Joe Petch, Pres., 1119 5th St., N. E.
E. J. Gussett, C. & F. S., 1202 McKinley Ave., S. W.
- 302—MILWAUKEE, WIS. 1st-3d Sat., Lipp's Hall, 3d and Prairie.
Henry J. Murray, Pres., 113 29th St.
E. P. Youngbluth, C. S., 35 35th St.
John DuBrucq, F. S., 317½ 4th Ave.
- 305—FORT ARTHUR, TEXAS. 2d-4th Tues., Labor Hall.
C. L. Bragg, Pres., Gen. Del.
T. O. Riley, C. S. & B. A., Box 683.
James Rose, F. S., Box 8.
309—EVANSTON, WYO. I. O. O. F. Hall, 1st-3d Wed.
John T. Whittle, Pres., County Road.
J. H. Willoughby, C. S., Box 419.
- 311—SOUTH KAUKAUNA, WIS. 2d-4th Mon., Odd Fellows' Hall.
Louis Crevier, Pres.
Chas. Robedeau, C. & R. S., P. O. Box 279.
- 312—SELMA, ALA. 1st-3d Wed., at R. R. Y. M. C. A.
J. F. Ryals, Pres.
W. F. Fawcett, C. S., 1599 Selma.
- 315—MCCOMB, MISS. Central Trade and Labor Hall, 1st-3d Wed., at 7:30.
R. O. Bean, Pres. & C. S., Box 684.
- 317—RICHMOND, CALIF. 2d-4th Fri., Barnman's Hall, 19th St.
Frank Mallinson, Pres., care Randall Hotel.
Wm. Jones, C. & F. S., Box 634.
- 318—PITTSBURGH, PA. 1st-3d Mon., Hazlewood Bank Bldg., cor. 2d and Hazlewood.
W. Mertz, Pres., Path Alley.
T. A. Hudson, F. S., 310 Johnston Ave.
- 320—MERIDAN, MISS. B. L. E. Hall, 5th St., and 40th Ave., 1st-3d Thurs.
J. A. Smitheren, Pres., 511 40th Ave.
J. E. Alexander, C. & F. S., 3817 38th St.
- 322—ST. LOUIS, MO. 1st-3d Tues., Reddy Hall, 3109 Chautau.
John Coots, Pres., 2726 Washington Ave.
M. Renth, C. S., 4537 Michigan Ave.
- 323—CHICKASHA, OKLA. 2d-4th Fri., Labor Hall, 4th and Choctaw.
C. A. Chincholl, Pres., P. O. Box 582.
W. L. Harkins, C. & F. S., 528 S. 15th.
- 328—SHREVEPORT, LA. K. of E. Hall, over West End Drug Store, 2d-4th Thurs.
H. Abbott, Pres., 1542 Luchina Ave.
H. W. Huff, C. S., 1863 Texas Av.
- 332—CUMBERLAND, MD. 1st-3d Mon., Odd Fellows' Hall.
C. C. Bowen, Pres., 107 W. 1st.
Geo. H. Little, C. S., 401 E. 1st.
J. R. Beck, F. S., 106 W. 1st.
- 334—PRINCETON, IND. 2d-4th Tues., Redmen's Hall.
Joe Myers, Pres., 1101 S. Race.
J. E. Clark, C. & F. S., 702 S. Prince.
- 338—GRAND JUNCTION, COLO. 2d-4th Fri., Eagles' Hall.
G. R. Stoll, Pres., 337 White.
E. H. Friend, C. & F. S., 308 Pitkin Ave.
- 339—SPARKS, NEV. 2d-4th Wed., Engineers' Hall.
Wm. Daseler, Pres., P. O. Box 214.
C. H. Crouch, C. S., P. O. Box 204.
- 340—HERRINGTON, KAS. 1st-3d Sat., I. O. O. F. Hall.
John Olson, Pres.
J. E. Anderson, C. S., 303 N. 8th.
- 341—PHILADELPHIA, PA. 2d-4th Tues., 8 p. m., Labor Headquarters, 232 N. 9th St.
Wm. J. Boyle, Pres., 208 N. 58th St.
Chas. Heberly, C. S., 3084 Aramingo Ave.
- 344—SHEFFIELD, ALA. 1st-3d Wed., at I. O. O. F. Hall, Montgomery Ave.
W. H. Wilson, Pres., Tusculmbia, Ala.
E. T. Holland, C. S., Box 65.
- 345—SAN ANTONIO, TEXAS. Trades Council Hall, 2d-4th Thurs.
F. E. Hamilton, Pres., 2103 W. Travis.
E. H. Frick, C. & F. S., 1223 W. Traves Ave.
Deirympel, E. A., 410 River Ave.
- 348—TRENTON, MO. 1st-3d Tues., at Cutlip's Hall.
Water Mason, Pres., 1726 Lula Ave.
Geo. W. Singer, C. & F. S., 1801 Maine St.
- 353—HANNIBAL, MO. Wm. James, Pres., 300 Rock.
J. J. Sughnes, C. & F. S., 836 Grand Ave.
- 354—BROOKFIELD, MO. 1st-3d Tues., 212 N. Main St.
Martin Murphy, Pres., 391 Elm St.
J. K. Burnham, C. S., 212 W. John St.
- 355—CONNEAUT, OHIO. 2d-4th Fri., Stationary Eng. Hall, Main St.
Chas. Ward, Pres., 685 Lakeview Ave.
J. M. Irish, C. S., 530 Sherman.
E. J. Dickson, F. S., 815 Main.
- 356—HAMMOND, IND. 1st-3d Wed., Long's Hall, State St.
James Boyle, Pres.
Thomas Boyle, C. S., 264 State-line St.
- 360—LAFAYETTE, IND. 1st-3d Thurs., Bartenders' Hall, 3d and Ferry Pt.
Fred Hamp, Pres., 1601 N. 12th.
Wm. Peterson, C. S., 426 Lingie.
James Goldsberry, F. S.
- 363—EAST ST. LOUIS, ILL. 1st-3d Fri., Wyant Hall, Broadway and Main.
James Rose, Pres., 318 S. 5th.
John Roche, C. & F. S., 614 Ohio Ave.
- 364—COVINGTON, KY. 1st-3d Mon., Heidels' Hall, N. W. cor. 21st and Russell Sts.
Herman Dedden, Pres., 19th and Euclid Ave.
R. F. Powers, C. S., 3011 Pearl St.
- 367—HAVRE, MONT. 3d Sat., Kyfaxford Hall.
Kyo Cone, Pres., 1428 3rd St.
Elmer Burns, C. S., 1037 2nd St.
- 369—ALEXANDRIA, VA. 1st Thur. in month during summer months, 108 N. Patrick St.
James Moran, Pres., 1219 Duke.
M. Gemeny, R. & F. S., 1514 King.
- 371—LOWELL, MASS. 1st-3d Sat.
James Lanigan, Pres.
J. J. Cunningham, C. S., 656 Gorham.
- 377—MOLINE, ILL. 1st-3d Fri., Moline Industrial Home, cor. 14th St. and 5th Ave.
Carl Robison, Pres., 7th St., Silvis, Ill.
John Fulton, F. S., 7th St., Silvis, Ill.
- Charles McGowan, B. A., 7th St., Silvis, Ill.
C. R. Kiser, C. S., Box 581, Silvis.
- Walter S. Schneider, B. A., 1317 35th St., Rock Island, Ill.
- 378—MONCTON, N. B., CAN. 2d-4th Fri., Sons of Temperance Hall.
Alex McDougall, Pres., 143 High St.
R. D. Donnelly, C. S., 69 Downing St.
- 379—McADAM JUNCTION, N. B., CAN. 2d-4th Fri., Orange Hall.
Geo. Guest, Pres.
A. J. McLaggan, C. S.
- 381—AMARILLO, TEXAS. 1007 Buchanan.
M. L. Parker, Pres., Box 407.
Joe Wilson, C. S., 1007 Buchanan.
- 382—CHILDRRESS, TEXAS. 2d-4th Fri., at 7:30 p. m., in Labor Temple.
Mack Leopold, Pres., P. O. Box 835.
J. M. Neal, C. S.
- 384—PERU, IND. 2d-4th Tues., Labor Trades Hall.
Floyd W. Seitz, Pres., 164 N. Lafayette.
W. H. Hawkins, F. & C. S., 404 W. 13th St.
Frank Sullivan, B. A., 133 W. 3d.
- 388—MECHANICSVILLE, N. Y. 2d and last Tues., A. O. H. Hall, North Main St.
James S. Kennedy, Pres., S. Second Ave.
Sidney Crozier, C. S., 28 Railroad.
Chas. Chapman, F. S., 112 N. 2d.
- 390—TRINIDAD, COLO. 2d-4th Wed., Labor Union Hall, East Main St.
W. T. Flynn, Pres., Arizona Ave.
A. A. Loftus, F. & C. S., 107 Goddard St.
- 391—DAVENPORT, IOWA. 2d-4th Fri., Danish Hall.
John Schoch, Pres., 516½ W. 3d.
R. F. Stewart, C. S., 616 Tremont Ave.
W. C. Richards, F. S., 1938 Bridge Ave.
- 392—CALGARY, ALBERTA, CAN. 3d Sat., 2:30 p. m., Labor Temple.
J. Chambers, Pres., Ogden, P. O. F. Adams, C. S., Ogden, P. O. Alb.
- 393—GOODLAND, KAS. 1st-3d Tues., Calvert & Sparks' Law Office.
S. E. Braffet, Pres.
Earl Crause, C. & F. S.
- 395—NORTH FOND DU LAC, WIS. 1st-3d Fri., Trades and Labor Hall, cor. 3d and Main.
Carl Deyer, Pres., 615 Michigan Ave.
Jos. A. Huntzinger, C. S., 223 E. Johnson, Fond du Lac, Wis.
- 396—NORWICH, N. Y. 4th Wed. in Cook Block.
James E. Callahan, Pres., 1 Columbia St.
Julius Schrafft, C. & F. S., 13 Davis.
- 398—RIVIERE DU LOUP, QUEBEC, CANADA. 2d-4th Mon., Rioux Hall.
Max Bourgoins, Pres., River du Loup Station.
Jos. Beaulieu, B. A., Blaisville.
Ludger Oullet, C. & F. S., Blaisville.
- 400—MIDDLETON, N. Y. 1st-3d Fri., Odd Fellows' Hall.
Wm. Springer, Pres., 55 Beattie Ave.
Wm. E. Appel, F. S., 378 North.
Chris Smith, C. S., 381 North St.
- 402—PORTSMOUTH, OHIO. 2d-4th Fri., C. L. U. Hall.
Fred Miller, Pres., cor. Robinson and Summit St.
Edward Snyder, C. S., 2113 17th St.

- 403—HOISINGTON, KAS. I. O. O. F. Hall, 1st-3d Mon.
Ray Bowler, Pres., P. O. Box 72.
C. W. Cramer, C. & F. S., Box 494.
- 405—BLUEFIELD, W. VA. 1st-3d Fri., Masonic Temple.
E. K. Collins, Pres., Princeton Ave. E.
W. F. Dupree, C. & F. S., Gen. Del.
- 406—VAN WERT, OHIO. 3d Thurs., Suite 236 Home Guard Bldg.
E. K. Murlin, Pres., 208 N. Race.
- 410—SAN FRANCISCO, CAL. 2d-4th Wed. Labor Temple, 16th and California.
Ed Hanny, Pres., 518 Alvarado.
L. Kevie, C. S., 208 Springdale Ave.
- 413—ST. THOMAS, ONTARIO, CAN. 2d-4th Tues., Machinists' Hall, Talbot St.
Frederick Brooks, Pres., 5 Maama Frank Roberts, C. S., 61 Wilson
- 414—ONEONTA, N. Y. 1st Wed. and 3rd Sun., 2:30 p. m., Redmen's Hall.
James Walsh, Pres., 51 Church.
David Lawrie, C. & F. S., 73 W. Broadway.
- 415—JACKSONVILLE, ILL. F. McKenna, C. S., 475 E. State.
- 417—NORTH BAY, ONT., CAN. 2d-4th Mon., L. O. L. Hall.
A. E. Lye, Pres., Box 799.
Frank Crotcher, C. S., Box 1773.
- 418—NEODESHA, KAS. 1st-3d Sat., Baldwin Hall.
Chas. Brown, Pres.
E. P. Reddick, C. S., Box 775.
A. F. Bingham, B. A.
- 419—SOMERSET, KY. 1st-3d Tues., at Owen's Hall.
Peter Lefter, Pres., Sta. A.
J. A. Schofield, C. & F. S., Sta. A.
- 421—HAMILTON, ONT. 1st-3d Fri., Labor Hall, John St. 50.
L. Lawton, Pres., No. 21 Tuckett.
F. Honson, C. & F. S., 6 Bristol.
- 422—SANFORD, FLA. 2d-4th Wed., Eagles' Hall.
H. B. Purden, Pres.
J. H. Shuman, C. S., 115 W. 9th.
- 423—BIG SPRINGS, TEX. 2d-4th Tues., I. O. O. F. Hall.
D. D. Crawford, Pres., cor. Gregg and 3d.
W. P. Warren, C. & F. S., 201 W. 1st.
- 424—FLORENCE, S. C. 2d Thurs., Y. M. C. A.
L. H. Mims, Pres., 222 Covington St.
- A. H. Dickman, C. & F. S., 609 Day St.
- 425—WAYCROSS, GA. 1st-3d Thurs., Loot Hitch Bldg.
C. M. Schultz, Pres., 37 Stephens Ave.
- L. J. Flohr, C. & F. S., Box 236.
- 427—SALIDA, COLO. 2d-4th Thurs., Adliss Hall.
H. P. Jones, Pres., 135 E. Sacket Ave.
- Wm. Dargavel, C. S., 221 E. St.
- 428—NORFOLK, VA. 2d-4th Wed., Pythian Castle Hall.
W. M. Wood, Pres., 617 Liberty St., Berkely, Va.
- Thos. Callahan, C. & F. S., 116 Middleton St., Berkeley, Va.
- 430—CAPE GIRARDEAU, MO. 1st-3d Tues., Haas' Hall.
Geo. Stanley, Pres., 223 Frederick St.
Oscar O. Berry, F. S., 415 S. Frederick St.
- 431—BOSTON, MASS. 2d Thurs., Naomi Hall, 724 Washington.
Thos. R. Kennan, C. S., 80 W. 5th St., So. Boston.
- 434—CHICAGO, ILL. 2d-4th Wed., Boulevard Hall, 55th and Halstead Sts.
H. Fischer, Pres., 6507 Sangamon.
L. M. Craft, C. S., 715 E. 48th.
- 435—BRISTOL, TENN. 2d-4th Fri., Sixth and Shelby Sts.
M. C. Cooper, Pres., V. & S. W. Ry. Shops.
J. B. Wood, C. & F. S., 37 Lancaster St., Bristol, Va.
- 436—COLUMBUS, GA. 1st-3d Fri., Trades and Labor Assembly Hall.
R. S. Barry, Pres., 911 4th Ave.
E. W. McMichael, C. & F. S., 411 10th St.
- 437—TWO HARBORS, MINN. 2d and last Thurs., Iron Dock Grove Hall.
Christ. Anderson, Pres.
Charles Larson, C. & F. S., Box 298.
- 438—GALETON, PA. 2d-4th Tues., Eagles' Hall.
Daniel B. Shine, C. S., 20 First St.
- 439—FAIRBURY, NEB. 4th Wed., K. of L. S. Hall.
B. Z. Milliken, C. & F. S., P. O. Box 167.
Fred Kurat, B. A.
- 440—BELLE PLAINE, IOWA. 2d-4th Mon., Fireman's Hall.
Charles Corns, Pres., 10th St.
Warren Wheeler, C. S., P. O. Box 608.
- 442—NEW ORLEANS, LA. 3d Tues., McMahon Hall, 1112 Drades.
James Miller, Pres., 1204 So. Franklin.
John Mocklin, C. & F. S., 606 S. Telemachus St.
- 444—CONNELSVILLE, PA. J. W. Easley, C. S., 517 N. Pgh.
- 446—ALAMOSA, COLO. 2d-4th Wed., Trades Assembly Hall.
Albert Jacobson, Pres.
Chas. F. Darling, C. S., Box 64.
- 447—DECATUR, ILL. 1st-3d Tues., Ashley Hall, Mason Temple.
Jas. Gray, Pres., 317 N. Broadway.
Chas. J. Younger, C. & F. S., 432 E. King St.
- 448—MONTGOMERY, ALA. 1st-3d Wed., Young's Hall.
J. A. Redding, Pres., 316 Columbus.
E. J. Ford, C. S., 75 Morgan Ave.
- 449—SAPULPA, OKLA. 2d-4th Mon., Moose Hall.
M. E. Lange, Pres., 913 E. Hobson.
Irwin Shipman, C. S., Box 338.
- 450—WASHINGTON, D. C. 2d-4th Wed., New Masonic Hall, 8th and F Sts., N. E.
A. W. Sherler, Pres., 106 15th S. E.
- W. F. Kilroy, C. S., 11 I St., N. E.
- 451—WINNIPEG, MAN., CAN. 2d-4th Fri., Labor Temple.
D. Nelson, Pres., 323 Morley Ave.
F. Snare, C. & F. S., 263 Bradford St., St. James.
- 453—COPPERHILL, TENN. 1st-3d Tues., I. O. O. F. Hall.
Chas. Frenz, Pres., Box 711.
E. N. Hall, C. S., Box 382.
- 454—CHICAGO, ILL. 2d-4th Thurs., Persey Hall.
Walter Love, Pres., 752 E. 69th St.
- E. R. Dettmer, C. S., 9245 Stoney Island Ave.
- 455—SHERMAN, TEXAS. 2d-4th Thurs., Fulton Hall.
C. S. Hanshey, Pres., Old Phone 893.
John W. Plexoco, C. S., 424 S. Gribble.
- 463—BALBOA, CANAL ZONE, PANAMA. 1st-3d Fri., Ancon Lodge Hall.
A. R. R. Charters, Pres., Carozal, C. Z.
W. H. Keenan, C. & F. S., Box 26, Culebra, C. Z.
- 464—PALESTINE, TEXAS. Labor Temple, 2d-4th Wed.
W. B. Graham, Pres., 106 Green.
J. D. Mallette, C. & F. S., 503 La.
- 466—REVELSTOCK, B. C. 3rd Sat., Selkirk Hall.
M. M. Keller, Pres., Box 138.
A. Harris, C. & F. S., Box 132.
- 467—PUNTSMOUTH, N. H. 3d Wed., Eagles' Hall.
John Quinn, Pres., Court St.
Alfred Olson, C. S., Box 37, Kittery, Me.
- 469—TERRELL, TEXAS. 2d-4th Fri., Trades and Labor Hall, 203 E. Moore Ave.
J. R. Poston, Pres., 608 E. College St.
R. E. O'Reilly, C. S., 906 E. Moore Ave.
- 471—CRISTOBAL, C. Z. 2d-4th Thurs., Bldg. No. 147.
J. Z. Knapp, Pres.
A. P. Elkert, C. & F. S., Box 369.
- 473—HELPER, UTAH. 1st-3d Wed., K. of P. Hall.
Wm. R. Welsh, Pres.
H. W. Smith, C. & F. S., Box 411.
- 475—GRAND ISLAND, NEB. 1st-3d Mon., City Hall, 3d St.
H. W. Hunt, Pres.
Sherman Aldrich, F. S., 1014 E. 4th St.
- 476—DALHART, TEXAS. 3d Fri., Socialist Hall.
H. C. Fritche, Pres.
Theo P. Nelson, C. & F. S., Box 332.
- 478—MOOSE JAW, SASKATCHEWAN, CANADA. 2d-4th Mon., Trades and Labor Hall, Main St.
Wm. Gillies, Pres., 364 Fairford St., W.
Geo. Walters, C. S., Broadview P. O.
- 479—DEVIL'S LAKE, N. DAK. 1st Fri., Opera House Hall.
J. A. Thompson, Pres., Box 324.
M. J. Feeney, C. S., Box 143.
- 481—LYNDONVILLE, VT. 1st-3d Wed., Eaton's Hall.
E. A. Hinds, Pres.
E. A. Phillips, C. & R. S., Box 121, Lyndon Center, Vt.
J. M. Bresson, B. A.
- 482—ALTON, ILL. Schwartzbeck Hall, 3d and Ridge. 1st-3d Tues.
D. Stafford, Pres., 1009 E. 5th St.
Robt. Dale, C. S., 8008 Edwards.
- 485—GREEN BAY, WIS. 1st-3d Thurs.
John Christianson, Pres., 323 S. Maple Ave.
John Slater, C. & F. S., 425 5th St.
J. L. Callahan, B. A., 3606 Clifton Ave., Milwaukee, Wis.
- 486—TYLER, TEXAS. 1st-3d Wed., K. O. T. M. Hall.
J. A. Fuller, Pres., 1116 Irvin.
J. M. McCarty, C. & F. S., 221 Center St.
C. R. Welch, B. A., 1433 N. Fannie Ave.
- 491—VALLEY JUNCTION, IOWA. 1st-3d Tues., I. O. O. F. Hall.
Frank S. Hoppe, Pres.
J. C. Carroll, C. S., Box 165.
Geo. W. Fring, B. A., Pres.
- 492—WORCESTER, MASS. 1st-3d Thurs., Foresters' Hall.
Patrick I. Curran, Pres., 4 Wilson.
- John Casey, C. S., 61 E. Central.
- 493—NEW CASTLE, PA. Jan. 13, 1915, and every other Wed., Trades Assembly Hall.
D. E. Sturdevant, Pres., 516 Waldo.
E. A. Horchler, C. & F. S., 906 E. Washington.
- 495—HATTIESBURG, MISS. 1st-3d Tues., 600 Boule St.
C. W. LeBlanc, Pres., 107 Evans.
A. H. Waddell, C. & F. S., 500 Boule.
- 496—HURON, SOUTH DAKOTA. 2d Sun. and 4th Fri., Labor Hall.
Peter Palusnak, Pres.
C. Storkson, C. & F. S., 228 Beach St.

- 500 — EVERETT, WASH.** 2d-4th Tues., Labor Temple, 3506 Everett Ave.
Wm. Faulke, Pres., 3506½ Everett Ave.
Bert Bloomington, C. S., 3523 Smith Ave.
- 501—WACO, TEXAS.** 2d-4th Fri., Labor Hall.
Chas. Bullock, Pres., R. F. D. No. 2.
Wm. Dickerson, C. & F. S., 810 Cleveland St.
- 502—TEAGUE, TEXAS.** 1st-3d Mon., Davis Hall.
Thos. McGrath, Pres., Box 244.
J. D. Clayton, C. S.
- 503—FITZGERALD, GA.** 1st-3d Wed., I. O. O. F. Hall.
M. J. Mauns, Pres., P. O. Box 636.
A. B. Campbell, C. S.
- 504—MUSKOGEE, OKLA.** 1st-3d Wed., Carpenters' Hall.
Guy Carver, Pres., 1220 Baltimore.
W. H. Hammond, C. & F. S., Gen. Del.
- 505—FORT WILLIAM, ONTARIO, CAN.** 1st-3d Fri., Electricians' Hall, Murphy Block, Simpson Ave.
James Duncan, Pres.
A. Cruickshank, C. S., 1007 Minn. Ave.
- 507—ATCHISON, KAS.** 1st-3d Mon., Fireman's Hall, 1521 Main St.
J. F. Coyle, Pres., 1418 Kansas Ave.
John J. Frelbott, C. & F. S., 1420 Kansas Ave.
- 508—JACKSON, OHIO.** 4th Tues., Hibernian Hall.
O. B. Reynolds, Pres., 77 High St.
Albert Edmonds, C. S., 77 Hunt St.
J. B. Fillinger, B. A. and Journal Cor., 53 Main St.
- 510—CEDARTOWN, GA.**
E. M. Kendrick, Pres.
I. C. Smith, C. S.
- 511—WHISTLER, ALA.** 1st-3d Mon., I. O. O. F. Hall.
J. L. Scholls, Pres.
C. C. Crone, C. S., 209 Bauregard.
- 515—EAST CAMBRIDGE, MASS.** Engineers' Hall, 164 Canal St., Boston, Mass., 1st-3d Fri.
Geo. A. Mitchell, Pres., 39 S. Russell St., Boston, Mass.
Joseph Irwin, C. & F. S., 38 Glendate St., Everett, Mass.
- 517—GREENFIELD, MASS.** 2d-4th Sat., Forester Hall.
Patrick Kelley, Pres., 3 Devens.
T. L. Scannell, C. & F. S., 6 Russell St.
- 518 — WICHITA, KAS.** 1st-3d Thurs., 216 N. Main St.
G. W. Thompson, Pres., 2127 University Ave.
O. E. Maze, C. S., 1415 W. Maple.
- 520—MILES CITY, MONT.** 2d-4th Fri., Wilboux Hall, 7th and Main.
P. J. Gallagher, Pres., 602 N. Lake St.
Chas. E. Cook, C. & F. S., 119 N. Streville.
- 521—VAN BUREN, ARK.** 1st-3d Thurs., W. O. W. Hall.
Charles Pathhast, Pres.
Otto Pyles, C. S., Box 343.
C. A. McDonald, B. A., 4416 Norledge, Kansas City, Mo.
- 522—EL RENO, OKLA.** 1st-3d Tues., Redmen's Hall.
H. E. Hart, Pres., Box 624.
H. A. Mathews, C. & F. S., Box 12.
- 523—PRATT, KAS.** 2d-4th Tues., at S. T. Sample's residence.
W. F. Stephen, Pres., 701 N. Ninircah St.
F. W. Sharpe, C. S., Box 73.
- 524—MURPHYSBORO, ILL.** 2d-4th Wed., Machinists' Hall, 107 S. 10th.
A. R. McFarland, Pres., 638 N. 8th.
E. P. Herin, C. & F. S., 2107 Wall.
- 525—HINTON, W. VA.** 1st-3d Mon., Big Four Bldg.
W. L. Taylor, Pres., 108 Grace St.
C. L. Barnette, C. & F. S. & B. A., 419 Summer Ave.
- 528—DEER LODGE, MONT.** 2d-4th Fri., I. O. O. F. Hall.
T. J. Messing, Pres.
J. H. Thomas, C. & F. S., P. O. Box 877.
- 520—WINNIPEG, MAN., CAN.** 1st Sun., Campbell Hall, Transcona, 3rd Sun., Labor Temple, Winnipeg, 3 p. m.
A. Orr, Pres., 3 Gallagher Ave., Brooklands, Man., Can.
Robt. Clark, C. & F. S., 471½ Fortage Ave.
- 530—SPRINGFIELD, MO.** 3d Mon., Denkeldem's Hall.
J. W. Reddick, Pres., 817 Lincoln.
John Cain, C. & F. S., 507 Fort.
A. F. Bingham, B. A., 701 Lombard St.
- 531—CHAFFEE, MO.** 1st-3d Thurs., City Hall.
T. C. Davis, Pres.
C. P. Bourion, C. & F. S., Box 365.
- 537—COVINGTON, KY.** 2d-4th Fri., Workman Hall, 122 Pike St.
A. J. Pope, Pres. & B. A., 1817 Scott St.
John J. Fielding, C. & F. S., 1341 Holman.
- 541—BEDFORD, IND.** 2d-4th Thurs., Labor Union Hall.
Dan J. Kane, Pres., 511 N. I St.
Chas. J. Bordenet, C. S., 628 N. I St.
- 542—COFFEYVILLE, KAS.** Labor Temple, 2d-4th Wed.
R. M. Jones, Pres., 807 W. 14th.
J. C. Morrow, C. & F. S., 613 W. 4th St.
- 543—WICHITA, KAS.** 216 N. Main St., 2d-4th Wed.
E. C. Hadler, Pres., 358 Lulu Ave.
C. E. Grove, C. & F. S., 701 W. Central.
- 546—MONETT, MO.** 1st-3d Tues., K. C. Hall.
David Elder, Pres., 406 9th St.
John Linebarger, C. & F. S., 214 Pearl St.
- 547—CARBONDALE, PA.** Pugh-anas Hall, 2d-4th Fri.
E. T. Dickenson, Pres., 142 Wyoming.
James A. Flannery, C. & F. S., Box 185.
Wilkes Barre Representative, T. J. Cavan, 60 Chester St., Wilkes Barre, Pa.
- 548—TORONTO, CAN.** 2d-4th Wed., Labor Temple, Church Jas. Dobson, Pres., 280 Perth Ave.
W. H. Watson, C. S., 162 Annette St.
- 549—MIDDLEPORT, O.** 1st-3d Tues., Firemen's Hall.
Lester Cunningham, Pres.
Perry Cooper, C. & F. S.
- 551—PRINCETON, W. VA.** Castle Hall, 1st-3d Thurs.
J. J. Bower, Pres., 576 Bluefield.
J. H. Blackwell, C. S., Box 312.
- 553—LA GRANGE, ORE.**
Wm. Andis, Pres., 1506 V Ave.
Jas. H. Guttridge, C. S., Box 197.
- 556—OKLAHOMA CITY, OKLA.** C. S. Cochran, Pres., 406 W. Frisco.
E. F. Ryan, C. & F. S., 400 West Frisco.
- 557—WILLIAMSON, W. VA.** 2d-3d Tues., 3d Ave.
- Bert Williams, Pres.
H. W. Bias, C. & F. S., 124 Oak.
- 565—FALLS CITY, NEB.** 1st-3d Thurs., W. O. W. Hall.
C. W. Jonas, Pres.
E. Woodington, C. & F. S., 710 E. 16th St.
- 567—SAN ANGELO, TEX.** 1st-3d Wed., Eagles' Hall.
O. M. Seay, Pres., 321 W. Ave. I.
R. L. Wright, C. S., 27 West Ave. I.
- 568—TACOMA, WASH.** Maccabee Hall, 1109½ C St., 2d-4th Thurs.
Chas. Manning, Pres., 5808 S. Lawrence St.
A. W. Rickett, C. & F. S., 615 So. State.
- 570—HIGH SPRINGS, FLA.**
H. A. Smith, Pres., P. O. Box 273.
F. C. Magerstaadt, C. S.
- 571—DE PERE, WIS.** De Both Hall, 1st Sun.-3d Wed.
T. J. McDonald, Pres., Lock Box 44, W. De Pere, Wis.
A. B. Steinfeldt, R. S., P. O. Box 207.
- 573—LANSFORD, PA.**
Wm. J. Williams, C. S., 843 East Ridge St.
- 575—VILLA GROVE, ILL.** 1st-3d Fri., Red Men's Hall.
James Tally, Pres.
A. Welch, C. S.
H. A. Downes, F. S.
- 576—WICHITA FALLS, TEX.** 2d-4th Thurs., Labor Hall.
J. H. Gibson, Pres., 309 Lee St.
C. K. Matthews, C. & F. S., Box 760.
C. H. Shoemaker, B. A., Box 18, Healdton, Okla.
- 577—CUMBERLAND, MD.** 1st-3d Thurs., Trades Council Hall.
E. H. Steahley, Pres., 403 Mechanic.
C. E. Dowlan, C. & F. S., 14 Emly.
- 578—HAGERSTOWN, MD.** Moose Hall, 2d-4th Thurs.
L. J. Murray, Pres., 25 Vine St.
Fred H. Stouffer, C. S., 817 Summit Ave.
- 579—KEYSER, W. VA.** 1st-3d Tues., City Building.
W. H. Wolf, Pres., Gilmore St.
P. R. Dougan, F. S., Gilmore St.
Joseph F. Hines, C. S., Piedmont, W. Va.
- 581—MONTPELIER, O.** 1st-3d Wed., Ry. Trainmen's Hall.
S. Brown, Pres.
J. Birmingham, C. S.
- 582—BATON ROUGE, LA.** 2d-4th Thurs., Odd Fellows' Hall, 3d St.
W. P. Kidd, Pres., 302 St. Phillip St.
S. V. Acosta, C. & F. S., 918 St. Ferdinand St.
- 583—NEVADA, MO.** Socialist Hall, So. Main St., 1st-3d Thurs.
A. C. LeQuellec, Pres., 520 E. Cherry.
L. E. Whitehead, C. & F. S., R. F. D. No. 1.
C. A. McDonald, B. A., 4416 Norledge, K. C., Mo.
- 584—LUDLOW, KY.** 1st-3d Thurs., Morley Hall.
Thos. Jackson, Pres., 17 Pherry.
H. J. Stroer, C. S., 833 Main, Covington, Ky.
- 585—BOSTON, MASS.** 1st Thurs., 3 p. m., and 3d Sun., 2:30, Hemstead Hall, 724 Washington St.
Wm. E. McNabb, Pres., 263 Chelsea, E. Boston, Mass.
Daniel B. McInnes, C. S., 288 Marginal Ave., E. Boston, Mass.
Daniel N. Gersoner, B. A., 17 Bul-lard, Dorchester, Mass.
James Vincent, F. S., 77 Lavin Hill.

- 586—SLATER, MO.** 2d-4th Mon., I. O. O. F. Hall; Chas. Crawford, Pres., Andy Phelps, C. & F. S.
- 587—BEAUMONT, TEX.** 2d-4th Thurs., Trades Assembly Hall, O. H. Greer, Pres., Box 149, T. C. Mackay, F. & C. S., 229 Fulton.
- M. J. Ickles, B. A., 249 College.**
- 588—CHICAGO, ILL.** 2d-4th Tues., Koop's Hall, California & North Ave., Thomas Godfrey, Pres., 920 E. 44th St.
- John McNaney, C. & F. S., 2613 Iowa St.**
- 589—MILWAUKEE, WIS.** 2d-4th Thurs., 928 E. Water St., Frank Thines, Pres., 729 5th, M. J. Gleason, C. & F. S., 202 Michigan St.
- 590—MONROE, LA.** 1st Fri., 615 A St., J. W. Grant, Pres., 501 Wood St., J. J. Devereux, C. & F. S., 615 Calypso St.
- 591—OLENDDIVE, MONT.** 2d-4th Fri., Noderhoff Hall, V. E. O'Connor, Pres. & C. S., 317 Valentine St., J. J. Shinault, F. S., Gen. Del.
- 592—TULSA, OKLA.** 2d-4th Sat., 214 1/2 S. Main, J. E. Dixon, Pres.
- C. E. Houghton, Act. Secy, 215 Reeder Bldg.**
- 593—CLIFTON, ARIZ.** Every Sat., Carpenters' Hall, H. Halter, Pres., Box 1252, Gus Kuentsz, C. & F. S., Box 186.
- 594—STANBURY, MO.** 2d-4th Tues., U. of F. Hall, John Inman, Pres., E. W. McNew, C. S.
- 595—AVEBY, IDAHO.** 2d-4th Mon., Godfrey's Home, West Avery, A. Anderson, C. & F. S., Gen. Del.
- 596—CASPER, WYO.** 2d-4th Mon., C. C. Starr, Pres., P. O. Box 71, A. R. Witz, C. & F. S., P. O. Box 172.
- 597—ESCANABA, MICH.** 1st-3d Thurs., Lemmer Hall, Ludington St., Jos. Vickers, Pres., 506 Wells Ave., Wm. Grosnich, C. & F. S., 714 Wells Ave.
- 598—SALAMANCA, N. Y.** 1st-3d Mon., 3 Maple St., A. G. Frey, Pres., 165 E. State St., D. J. Carpenter, C. & F. S., 3 Maple St.
- 599—PARAGOULD, ARK.** 1st-3d Thurs., Carpenters' Hall, J. W. Frey, Pres., 321 S. 2d St., A. Johnson, C. & F. S., 216 N. 5th Ave., C. A. McDonald, B. A., 4416 Norledge, Kansas City, Mo.
- 600—AKRON, OHIO.** Walsh Bldg., Jas. Shaughnessy, Pres., 876 So. Main St., R. C. Price, C. & F. S., 150 Adams St.
- 601—QUEBEC, CAN.** J. Thompson, Pres., 130 2d St., Simollon, G. Dery, C. S., 153 4th St., Lamorlow, Can.
- 602—GREAT FALLS, MONT.** 1st-3d Tues., Judge Safford's Court Room, Frank Yelocan, Pres., 1500 8th Ave. N., Roy J. Preston, C. & F. S., 706 3th Ave. So.
- 603—OTHELLO, WASH.** 1st-3d Mon., I. O. O. F. Hall, O. W. Bohusock, Pres., W. O. Clark, C. S., Box 137.
- 604—JOLIETTE, QUE., CAN.** H. Fournier, Pres., Gen. Del., W. C. Williams, C. & F. S., Box 238.
- 605—TOOELE, UTAH.** 2d-4th Thurs., Fraternal Hall, D. B. Sullivan, Pres., L. Fornoff, F. S., Box 294.
- 606—MORRIDGE, S. D.** 1st-3d Thurs., Moose Hall, J. P. Schmickrath, Pres., Box 721, H. L. Adams, C. & F. S., Box 166.

International Officers of the Ladies' Auxiliary

- MRS. J. W. EDWARDS**.....President
1234 S. 9th East St., Salt Lake City, Utah.
- MRS. F. R. REINEMEYER** ...1st Vice-President
Tauromee Ave., Kansas City, Kans.
- MRS. MOLLIE GEARY**.....2nd Vice-President
6428 S. Albany St., Chicago, Ill.
- MRS. A. F. BINGHAM**.....Secretary-Treasurer
701 Lombard St., Springfield, Mo.
- L. A. 5—SALT LAKE CITY, UTAH.**
Mrs. J. W. Edwards, Pres. & C. S., 928 W. South Temple St.
Mrs. Lydia Smithen, V.-Pres., 360 West 1 South St.
Mrs. J. C. Walton, F. S.
Mrs. Jane Foreman, Treas.
Mrs. Morton, R. S., 116 Markham.
- L. A. 7—SUNFLOWER, Parsons, Kas.** 2d-4th Tues. aft., Kennedy Hall,
Mrs. Lillian Dudding, Pres., 2229 Crawford Ave.
Mrs. Alice Leach, Vice-Pres.
Mrs. Zita Rever, Treas.
Mrs. Lula VanVleck, C. & R. S., 2701 Clark Ave.
Mrs. Ethel Smith, Fin. Sec., 2227 Wash. Ave.
Mrs. Mary Carver, Chaplain.
Mrs. Marion Butler, Marshall.
Mrs. Ida Corman, Conductress.
Mrs. Kate McMullen, In. Guard.
Mrs. Emma Pilkington, O. Guard.
- L. A. 8—FRANKLIN, McComb, Miss., Ladies' Aux. Hall, Ave. F. East** McComb, 2d-4th Thurs.
Miss Lula Hassfield, Pres., R. F. D. No. 1.
Mrs. E. Sullivan, V.-P. & Treas., 725 Ave. F.
Miss Emma Sullivan, C. S., 725 Ave. F.
Miss Lulu Hassfield, R. S.
- L. A. 9—GRAND JUNCTION, COLO.**
Mrs. W. H. Holeman, Past Pres., 914 S. 5th St.
Mrs. F. N. Davies, Pres. & Treas., 538 Ute Ave.
Mrs. J. W. Cox, C. & F. S. & V.-P., 925 S. 5th St.
Mrs. L. A. Turner, R. & S. T.
- L. A. 10—SPRINGFIELD, MO.**
Mrs. A. F. Bingham, Pres., 701 Lombard St.
Mrs. J. Gestring, Vice-Pres.
Mrs. C. S. Gilliland, C. & R. S., 1914 Johnson St.
Mrs. Wm. Specht, F. S. & T., Route 6.
Mrs. Rheaden, Chaplain.
Mrs. J. East, Conductress and Marshall.
Mrs. J. Ritterhouse, Inside Guard.
Mrs. Gestring, Mrs. Gilliland and Mrs. East, Trustees.
- L. A. 11—LONE STAR, Palestine, Texas, Labor Temple, 2d-4th Tues. afternoons.**
Mrs. Frances Brunson, Pres., 15 Cottage Ave.
Mrs. Helen Redus, V.-P., 106 Queen St.
Mrs. Florence Payne, R. S. & Treas., 212 Palmer Ave.
Mrs. Willie Welch, C. & F. S., 511 Green St.
- L. A. 12—GARFIELD PARK, Chicago, Ill., 1st-3d Sat., 8 p. m., Garfield Park Hall, 4039 W. Madison.**
Mrs. Maud Reinemeyer, Past Pres.
Mrs. Mollie Geary, Pres., 6428 S. Albany Ave.
Mrs. E. Farrell, V.-P., 4118 Carroll Ave.
Mrs. Helen Hughes, Cor. & Rec. Sec., 716 N. Avers Ave.
Mrs. Mary Driscoll, Fla., Sec. & Treas., 4135 Carroll Ave.
- L. A. 14—TOLEDO, O.**
Mrs. E. Richardson, Pres.
Mrs. Allen Thomson, V.-Pres.
Mrs. C. F. Haga, R. S.
Mrs. C. J. Sugrue, C. & F. S.
Mrs. Carrie Stephan, Treas.
Mrs. Louise Brown, Conductress.
Mrs. Lena Kern, Inspectress.
- L. A. 15—SAPULPA, OLKA.**
Mrs. Cora Johnson, Pres.
Mrs. Myrtle Clifton, V.-Pres.
Mrs. Addie Allen, R. S.
Mrs. Bessie Lewis, C. S.
Mrs. Hester Chapman, F. S.
Mrs. Ethel Edwards, Treas.
Mrs. Hettie Rondon, Chaplain.
Mrs. Ferrel Wells, Conductress.
Mrs. Emma Davis, Inside Guard.
Mrs. Katie Hoover, Marshall.
Trustees—Laura Cargill, Mrs. Emma Davis, Mrs. Addie Allen.

Boilermakers' Lodges by States.

Alabama.
 Birmingham . . . 4
 Montgomery . . . 443
 Selma . . . 312
 Sheffield . . . 344
 Whistler . . . 511

Arizona.
 Clifton . . . 593
 Miami . . . 187

Arkansas.
 Harrison . . . 138
 Little Rock . . . 66
 McGehee . . . 106
 Paragould . . . 599
 Pine Bluff . . . 68
 Van Buren . . . 521

Canada.
 Calgary, Alberta . . . 392
 Edmonton, Alb. . . 279
 Ft. William, Ont. . . 505
 Hamilton, Ont. . . 421
 Joliette, Que. . . 604
 McAdam Jct. . . 379
 Moncton, N.E. . . 373
 Montreal . . . 134
 Moose Jaw, Sask. . . 478
 North Bay, Ont. . . 417
 Quebec . . . 601
 Revelstoke . . . 466
 Riviere du Loup, Que. . . 398
 St. Thomas, Ont. . . 413
 Toronto, Ont. . . 548
 Transcona, Man. . . 529
 Winnipeg, M. . . 126
 Winnipeg, M. . . 451

British Columbia.
 Vancouver . . . 194
 Victoria . . . 191

California.
 Los Angeles . . . 92
 Oakland . . . 233
 Pt. Richmond . . . 317
 Sacramento . . . 94
 S. Francisco . . . 25
 S. Francisco . . . 205
 S. Francisco . . . 410
 Vallejo . . . 148

Colorado.
 Alamosa . . . 446
 Colorado . . . 136
 Denver . . . 179
 Grand Jct. . . 335
 Pueblo . . . 44
 Salida . . . 427
 Trinidad . . . 390

Connecticut.
 Hartford . . . 237
 New Haven . . . 61

Delaware.
 Dist. of Columbia
 Washington . . . 450

Florida.
 High Springs . . . 570
 Jacksonville . . . 20
 St. Augustine . . . 230
 Sanford . . . 573
 Sanford . . . 422

Georgia.
 Atlanta . . . 2
 Augusta . . . 108
 Cedartown . . . 510
 Columbus . . . 426
 Fitzgerald . . . 503

Macon . . . 12
 Savannah . . . 26
 Waycross . . . 425

Idaho.
 Avery . . . 595

Illinois.
 Alton . . . 483
 Bloomington . . . 155
 Chicago . . . 1
 Chicago . . . 39
 Chicago . . . 220
 Chicago . . . 227
 Chicago . . . 454
 Chicago . . . 434
 Chicago Hts. . . 254
 Chicago . . . 588
 Danville . . . 22
 Decatur . . . 447
 Freeport . . . 284
 Joliet . . . 93
 Kewanee . . . 195
 Mattoon . . . 224
 Moline . . . 377
 Peoria . . . 60
 Murphysboro . . . 524
 Springfield . . . 81
 E. St. Louis . . . 363
 Urbana . . . 150
 Villa Grove . . . 575

Indiana.
 Bedford . . . 541
 Evansville . . . 95
 Ft. Wayne . . . 54
 Garrett . . . 79
 Hammond . . . 356
 Indianapolis . . . 10
 Lafayette . . . 360
 Peru . . . 384
 Princeton . . . 334
 Terre Haute . . . 246
 Washington . . . 241
 Wabash . . . 324

Iowa.
 Belle Plaine . . . 440
 Boone . . . 161
 Cedar Rapids . . . 144
 Des Moines . . . 47
 Dubuque . . . 15
 Marshalltown . . . 149
 Mo. Valley . . . 145
 Sioux City . . . 244
 Valley Jct. . . 491
 Waterloo . . . 133

Kansas.
 Atchison . . . 507
 Coffeyville . . . 542
 Ft. Scott . . . 286
 Goodland . . . 393
 Herington . . . 340
 Holington . . . 408
 Horton . . . 199
 Kansas City . . . 83
 Neodesha . . . 418
 Osawatomie . . . 82
 Parsons . . . 292
 Pittsburg . . . 221
 Pratt . . . 523
 Wichita . . . 543
 Wichita . . . 518

Kentucky.
 Covington . . . 537
 Covington . . . 364
 Louisville . . . 40
 Ludlow . . . 584
 Paducah . . . 137
 Somerset . . . 419

Louisiana.
 Baton Rouge . . . 532
 New Orleans . . . 37
 New Orleans . . . 442
 Shreveport . . . 328
 Algiers . . . 206
 Monroe . . . 590

Maryland.
 Cumberland . . . 332
 Cumberland . . . 577
 Baltimore . . . 193
 Hagerstown . . . 578

Massachusetts.
 Boston . . . 250
 Boston . . . 431
 Boston . . . 585
 Cambridge . . . 515
 Dorchester . . . 574
 Greenfield . . . 517
 Lowell . . . 371
 Norwood . . . 281
 Springfield . . . 218
 Worcester . . . 492

Michigan.
 Bay City . . . 67
 Detroit . . . 169
 Escanaba . . . 597
 Grand Rapids . . . 84
 Jackson . . . 64
 Marquette . . . 236
 Saginaw . . . 124

Minnesota.
 Brainerd . . . 116
 Duluth . . . 165
 Minneapolis . . . 11
 St. Paul . . . 3
 Two Harbors . . . 437
 Winona . . . 201

Mississippi.
 McComb City . . . 315
 Meridan . . . 320
 Vicksburg . . . 56
 Water Valley . . . 300

Missouri.
 Brookfield . . . 354
 Cape Girar-deau . . . 430
 Chaffee . . . 531
 De Soto . . . 117
 Hannibal . . . 353
 Kansas City . . . 32
 Moberly . . . 267
 Monett . . . 546
 Nevada . . . 583
 Sedalia . . . 113
 Springfield . . . 70
 Springfield . . . 530
 Slater . . . 686
 St. Louis . . . 27
 St. Louis . . . 51
 St. Louis . . . 276
 St. Louis . . . 322
 St. Joseph . . . 31
 Stanbury . . . 594
 Sugar Creek . . . 90
 Trenton . . . 346

Montana.
 Anaconda . . . 80
 Deer Lodge . . . 528
 Glendive . . . 591
 Great Falls . . . 602
 Harlowton . . . 41
 Havre . . . 367
 Livingston . . . 123
 Miles City . . . 520
 Missoula . . . 111
 Butte . . . 130

Nevada.
 Sparks . . . 339

Nebraska.
 Chadron . . . 109
 Fairbury . . . 439
 Falls City . . . 565
 Grand Island . . . 475
 North Platte . . . 118
 Omaha . . . 38

New Hampshire.
 Concord . . . 245
 Portsmouth . . . 467

New Jersey.
 Elizabeth . . . 176
 Hoboken . . . 163
 Jersey City . . . 16

New York.
 Albany . . . 197
 Brooklyn . . . 45
 Buffalo . . . 7
 Elmira . . . 225
 Mechanicsville . . . 388
 Middletown . . . 400
 Norwich . . . 396
 Oneonta . . . 414
 Oswego . . . 175
 Rochester . . . 229
 Salamanca . . . 598
 Staten Island . . . 200
 Syracuse . . . 157
 Troy . . . 73
 Utica . . . 223
 N. Y. City . . . 21

North Carolina.
 Raleigh . . . 173
 Rocky Mount . . . 239
 Salisbury . . . 226

North Dakota.
 Devils Lake . . . 479

Oklahoma.
 Muskogee . . . 504
 Okla. City . . . 556
 Sapulpa . . . 449
 Shawnee . . . 293
 Chickasha . . . 323
 El Reno . . . 522

Ohio.
 Akron . . . 600
 Bellefontaine . . . 243
 Canton . . . 391
 Chillicothe . . . 135
 Cincinnati . . . 106
 Cleveland . . . 5
 Columbus . . . 8
 Conn-aud . . . 355
 Elmwood . . . 91
 Place . . . 91
 Jackson . . . 509
 Lima . . . 259
 Middleport . . . 549
 Montpelier . . . 581
 Newark . . . 92
 Niles . . . 285
 Portsmouth . . . 402
 Springfield . . . 18
 Toledo . . . 85
 Van Wert . . . 409

Oregon.
 La Grand . . . 553
 Portland . . . 72

Panama.
 Emplre, C. Z. . . 463
 Cristobal . . . 471

Pennsylvania.
 Carbondale . . . 547
 Connellsville . . . 444
 Galeton . . . 438
 Lanford . . . 573
 New Castle . . . 493
 Philadelphia . . . 341
 Pen Argyl . . . 140
 Pittsburgh . . . 154
 Pittsburgh . . . 318
 Philadelphia . . . 19
 Pottsville . . . 256

South Carolina.
 Charleston . . . 50
 Columbia . . . 235
 Florence . . . 424

South Dakota.
 Huron . . . 496
 Moberidge . . . 606

Tennessee.
 Bristol . . . 435
 Copperhill . . . 453
 Jackson . . . 88
 Knoxville . . . 143
 Memphis . . . 189
 Nashville . . . 42
 Chattanooga . . . 14

Texas.
 Amarillo . . . 331
 Beaumont . . . 587
 Big Spring . . . 423
 Childress . . . 382
 Dalhart . . . 476
 Dallas . . . 86
 Denison . . . 209
 El Paso . . . 216
 Ft. Worth . . . 96
 Galveston . . . 132
 Houston . . . 74
 Kingsville . . . 287
 Marshall . . . 100
 Mart . . . 222
 Palestine . . . 464
 Sherman . . . 458
 Fort Arthur . . . 305
 Smithville . . . 265
 San Antonio . . . 345
 Teague . . . 502
 Terrell . . . 469
 Tyler . . . 486
 Waco . . . 501

Utah.
 Helper . . . 473
 Ogden . . . 198
 Salt Lake City . . . 103
 Tooele . . . 605

Vermont.
 Lyndonville . . . 481

Virginia.
 Alexandria . . . 369
 Clifton Forge . . . 238
 Newport News . . . 55
 Norfolk . . . 426
 Portsmouth . . . 298
 Portsmouth . . . 57
 Richmond . . . 170
 Roanoke . . . 30
 Roanoke . . . 29
 Victoria . . . 65

Washington.
 Bremmerton . . . 290
 Everett . . . 500
 Othello . . . 603
 Spokane . . . 242
 Seattle . . . 104
 Seattle . . . 489
 Tacoma . . . 247
 Tacoma . . . 568

West Virginia.
 Bluefield . . . 405
 Elkins . . . 278
 Gassaway . . . 152
 Hinton . . . 525
 Huntington . . . 249
 Keyser . . . 579
 Princeton . . . 551
 Williamson . . . 567

Wisconsin.
 Butler . . . 589
 De Pere . . . 571
 Green Bay . . . 485
 Milwaukee . . . 107
 Milwaukee . . . 302
 N. Fond du Lac . . . 395
 S. Kaukauna . . . 311

Wyoming.
 Casper . . . 596
 Cheyenne . . . 46
 Evanston . . . 309
 Laramie . . . 48

By Insisting Upon Purchasing Union Stamp Shoes



You help better shoemaking conditions.
 You get better shoes for the money.
 You help your own labor position.
 You abolish child labor.

Do not be misled by retailers who say: "This shoe does not bear the union stamp, but is made under union conditions." This is false—no shoe is union made unless it bears the union stamp.

Boot and Shoe Workers' Union

246 SUMMER STREET, BOSTON, MASS.

JOHN F. TOBIN, President.

CHAS. L. BAINE, Sec.-Treas.

THE COMMERCIAL NATIONAL BANK

of KANSAS CITY, KANSAS.

CAPITAL AND SURPLUS, \$550,000.00.

DEPOSITS.....\$5,000,000.00

We cordially invite the Boiler Makers and Ship Builders of the United States who desire to transact banking business with us (which can be done readily by mail), to write to any of their officers and ask any questions they may desire to ask about our reliability and standing.

P. W. GOEBEL, President.

C. L. BROKAW, Cashier.

A. C. FASENMYER, Vice-President.

G. J. BISHOP, Asst. Cashier.

When Writing Advertisers

PLEASE MENTION

The Boiler Makers' Journal

Notice to Subscribers of the Journal

When members change their address, or do not receive Journal promptly, fill out the following blank and forward to the editor:

Name Reg. No. Lodge.....

Old Address, Street.....CityState.....

New Address, Street.....CityState.....

I have not received Journal for month of.....

KANSAS CITY, KAS., JUNE, 1915.

THE BOILERMAKERS JOURNAL

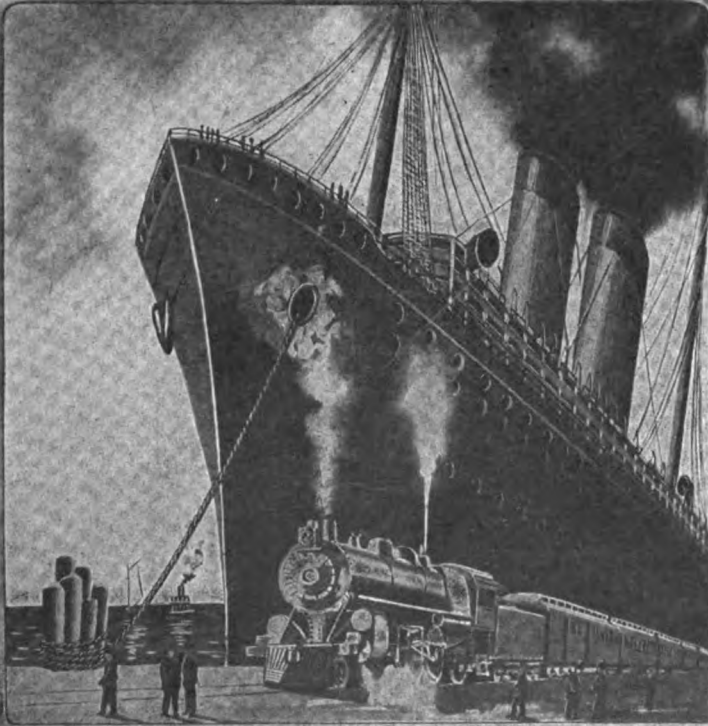

OFFICIAL ORGAN OF THE
INTERNATIONAL BROTHERHOOD
OF BOILERMAKERS, IRON SHIP BUILDERS
AND HELPERS OF AMERICA

HEADLIGHT

UNION MADE

OVERALLS

**“ A SMILE OF
SATISFACTION
WITH EVERY PAIR ”**

**Snug-fitting, adjustable collar
--keeps out grime and cinders.**

**Good, long, wide sleeves
with adjustable, dust-proof
cuffs, that can be unbuttoned
in a moment and rolled
back over the arm.**

**Wider, more elastic, adjustable
suspenders--can't cut or slip off
shoulders.**

High, broad, keep-clean apron.

**New patented safety watch pocket, keeps
your watch absolutely safe.**

**Higher cut waist--more comfortable, keeps
you cleaner.**



Larned, Carter & Co., Detroit, Mich.

WORLD'S GREATEST OVERALL MAKERS

Factories:-Detroit, Pt. Huron, Mich., St. Louis, Mo. Sarnia, Ont.

SECURITY SECTIONAL ARCH

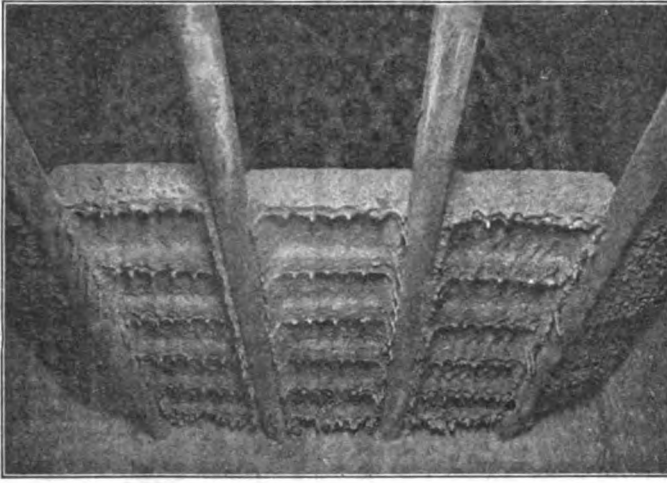

This arch is of light weight
It is built up of small sections
So made as to cool off quickly
It is easily removed for work
Made so to help the boilermaker

AMERICAN ARCH COMPANY

30 CHURCH STREET, NEW YORK

McCORMICK BUILDING, CHICAGO

Price List of Supplies

B. M. and I. S. B. monthly due stamps, each.....	\$1.00
Helpers' monthly due stamps, each.....	.60
Apprentices' monthly due stamps, each.....	.60
B. M. and Ship Builders' initiation stamps, each.....	1.00
Helpers' initiation stamps, each.....	.50
Apprentices' initiation stamps, each.....	.50
B. M. or Iron Ship Builders' out of work stamps, each.....	.20
Helpers' out of work stamps, each.....	.10
Apprentices' out of work stamps, each.....	.10
Universal reinstatement stamps, each.....	.50
Local assessment stamps, per 100.....	.25
Subordinate Lodge or District Charters, each.....	2.00
Seals, each.....	2.75
Punch, each.....	1.00
Ledger, 400 page, each.....	2.50
Minute Books, 400 page, each.....	1.50
Journal or Day Book, 400 page, each.....	1.50
Monthly report books, each.....	1.00
Receipt book, Treasurer, each.....	.35
Warrant book, R. S., each.....	.35
Receipt book, members B. A. or F. S., each.....	.35
Rituals, each.....	.30
Duplicate due books, B. M. or H., each.....	.25
Due books, B. M. or I. S. B., each.....	.10
Due books, Helpers, each.....	.10
Constitutions, each 5c, or per dozen.....	.50
Letter heads, ruled, per 100.....	.70
Letter heads, unruled, per 100.....	.70
Envelopes, per 100.....	.60
Application blanks, B. M. or H., per doz.....	.10
Delinquent notices, B. M. or H., per doz.....	.10
Withdrawal cards, B. M. or H., each.....	.10
Clearance cards, B. M. or H., each.....	.02
Ballot boxes, each.....	1.25
Gavels, each.....	.25
Ballot balls, white or black, per doz.....	.10
Rolled gold charms, each.....	1.75
Solid gold charms, each.....	8.00
Official Emblem buttons, small size, ea.....	1.00
Official Emblem buttons, large size, ea.....	1.50
Official Ribbon Badges:	
1 badge.....	1.50
2 or more, each net.....	1.25
6 or more, each net.....	1.00
12 or more, each net.....	.75

Free.

- Labels.
- Supply Blanks.
- Grievance Blanks.
- Pedigree Blanks.
- Affidavit Blanks.
- Blank Bonds.
- Strike Rolls.
- Roster Blanks.
- Trial Blanks.
- Application for Bonds.

District Lodge.

100 Letterheads..	\$1.50	100 Envelopes..	\$1.00
200 Letterheads..	2.25	200 Envelopes..	1.50
300 Letterheads..	2.50	300 Envelopes..	1.75
400 Letterheads..	2.75	400 Envelopes..	2.00
500 Letterheads..	3.00	500 Envelopes..	2.25
600 Letterheads..	3.25	600 Envelopes..	2.50
District due stamps, per 100.....	.25		
District assessment stamps, per 100....	.25		

Secretaries must keep a duplicate of all orders on file in their Lodges.
 Secretaries shall give full name and correct address and number of articles wanted in the left hand margin.

No Supplies Sent Unless Cash Accompanies the Order

You know OVERALLS, Uniforms, Shirts, etc., are



if they have this  mark

on the back of the material on the inside of the garment.

It's the cloth in the garment that gives the wear.

Stifel's Indigo Cloth

Standard for over 75 years.

Its continuous use by three generations of the "men of the road," factory and field is certain proof of extraordinary quality. Stifel Indigo wears like leather. Every washing makes it like new.



REGISTERED

This little mark is put on the back of the cloth on the inside of the garments for your protection.

Look for it before you buy.

Cloth manufactured by

J. L. STIFEL & SONS

Indigo Dyers and Printers

WHEELING, W. VA.

SALES OFFICES

- NEW YORK.....260-262 Church Street
- CHICAGO.....223 W. Jackson Boulevard
- SAN FRANCISCO.....Postal Telegraph Building
- ST. JOSEPH, MO.....Saxton Bank Building
- ST. PAUL.....238 Endicott Building
- TORONTO.....14 Manchester Building

The Boilermakers' Journal

Official Organ of the
**International Brotherhood of Boilermakers
Iron Ship Builders and Helpers of America**

Vol. XXVII.

KANSAS CITY, KAS., JUNE, 1915.

No. 6.

A SPIRIT HELPFUL TO LABOR.

By J. W. Sullivan in the American Federationist.

We are not all inveterate partisans in our public activities nor immovable bigots in our mental and moral makeup. Some of us are tired of being worked by the propagandists. One may in fact imagine nowadays the prayer of a sincere inquirer in sociology to run somewhat in this manner: "Please do not try any of your social cure-all volumes on me. I am not seeking a panacea, 'a sure way out.' And spare me the infliction of your party leaflets. I have no need to start with the elementary teachings of any school of economists or so-called radicals. I have something more than a smattering of all such primers. But it would be pleasing to have, from a sober pen, a summary of the progress of the more or less tried-out practical propositions, and of the trend of helpful thought, relative to at least the major phases of the social unrest. Put me in communication with a philosophical spirit fresh from a studious survey of our social system. Let me read his best conclusions on that broad subject. I shall be better pleased if he has considered the proposals and methods of the venturesome radicals and of the cautious conservatives alike and summed up his estimate of the values of their work in their separate lines. Give me something not too sketchy nor yet over-elaborate; something not reflecting the authority of a high priest orating from a throne; something stamped with simplicity and sincerity; something that will save me from the dabbling and groping and squabbling that come with so large a part of the economic literature of the time; something that may possibly suggest fundamental workable social principles."

I have in mind such a prayer in reading Walter Lippman's "Drift and Mastery: An Attempt to Diagnose the Current Unrest." Nothing has come from the press recently better suited to respond to the requirements of a fair-minded person seeking sober guidance in the wide field—one might almost say the wild waste—of "social reform." In short, Mr. Lippman's book is to be recommended alike to beginners in the task of tackling the great knot of social problems and to veterans who through the

help of its pages may run a parallel to their labors in reaching their resting places in thought relative to radicalism or reformism.

What Mr. Lippman has to say regarding labor organization illustrates his style and method. Subjoined is his chapter on labor, condensed through indicated omissions:

"The fact is that nothing is so stubbornly resisted as the attempt to organize labor into effective unions. Yet it is labor organized that alone can stand between America and the creation of a permanent servile class. Unless labor is powerful enough to be respected, it is doomed to a degrading servitude. Without unions no such power is possible. Without unions industrial democracy is unthinkable. Without democracy in industry, that is where it counts most, there is no such thing as democracy in America. For only through the union can the wage-earner participate in the control of industry, and only through the union can he obtain the discipline needed for self-government. Those who fight unions may think they are fighting its obvious errors, but what they are really against is just this encroachment of democracy upon business. . . .

"The unions are the first feeble effort to conquer the industrial jungle for democratic life. They may not succeed, but if they don't their failure will be a tragedy for civilization, a loss of co-operative effort, a balking of energy, and the fixing in American life of a class-structure. . . .

"No wonder they despise a scab. He is justly despised. Far from being the independent, liberty-loving soul he is sometimes painted, the scab is a traitor to the economic foundations of democracy. . . .

"The picket-line is to these little economic democracies the guardian of their integrity, their chief protection from foreign invasion. . . .

"As long as the unions have to fight for mere existence, their immense constructive possibilities will be obscured in the desperation of the struggle. The strike-breaker, then, is not only a peril to the union, he is a peril to the larger interests of the nation. He keeps workmen from their natural organization, deprives them of the strength that union brings, and thwarts all attempts to train men for industrial democracy. Instead of discipline and preparation

for the task of the future, instead of deep-grounded experience in co-operative effort, we shall get, if strike-breakers and blind legislators and brutal policemen and prejudiced judges and visionless employers prevail, despair and hate and servile rebellions.

"There are certain preliminaries of civilization which the great mass of workingmen have not yet won. They have not yet won a living wage, they have not yet won anything like security of employment, they have not yet won respect from the government, they have not yet won the right to be consulted as to the conditions under which they work. Until they do it is idle to talk about industrial peace, and folly to look for 'reasonable' adjustments of difficulties. Reason begins when men have enough power to command respect; a co-operative solution of industrial problems is possible only when all the partners to the co-operation must listen to each other. Until labor is powerful enough to compel that it can not trust to the benevolence of its masters—it has to be suspicious, it has to cling to the few weapons left it, for labor is right in supposing that no national conscience and no employers' conscience yet exhibited are adequate.

"There are certain occupations where workingmen have won these preliminaries of civilized life. The most notable example is in railroading, where the Brotherhoods have become a real part of the industrial structure. They are so powerful that they can't be left out. More than that, they are so powerful that they don't have to flirt with insurrection. It is the weak unions, the unorganized and shifting workers, who talk sabotage and flare up into a hundred little popgun rebellions. Guerilla warfare is the only tactic open to weakness. But where unions can meet the employers on a real equality, as railroad workers can, there you will find very little insurrectionary talk.

"You will meet in these powerful unions what radical labor leaders call conservatism. That is a very interesting accusation. The railroad men have won wages and respect far beyond anything that the I. W. W. can hope for. They have power which makes the I. W. W. look insignificant. If the I. W. W. could win for the unskilled anything like the position and responsibility that railroad men enjoy, it would have achieved something that might well be called a social revolution. The fact is that the railroad men are 'conservatives' in the labor world, just as the Swiss are conservatives among the nations. They have won the very things the lack of which makes rebellion necessary. For if men are ground down in poverty, if the rights of assemblage and free speech are denied them, if their protests are ineffective and despised, then rebellion is the only possible way out. But when there is something like a democracy where wrong is not a matter of life and death, but of better and worse,

then the preliminaries of civilization have been achieved, and more deliberate tactics become possible. . . .

Syndicalists and anarchists half recognize the fact that only a small minority of the workers can be aroused to bitter revolt. So they have begun to sing the praises of a 'conscious minority.' In other words they have abandoned the path of democracy, because it is incompatible with the temper they most admire. Workers who were really effectively organized would produce great changes in our social structure, but they would have to act with a deliberation that no temperamental anarchist can stomach. This is the paradox of the labor movement, that those who can't overthrow society dream of doing it, while those who could don't want to. If there is one occupation where syndicalist tactics might work it would be on the railroads. A small minority could paralyze the country and precipitate a general strike. But American railroad men are not likely to do this because, they don't need to. They have a stake in the country, a genuine representation in public opinion, and they can at all times secure a respectful hearing. If that were taken away from them, if their unions were disintegrated, they too might take to conspiracy.

"It is a commonplace of radicalism that power makes for peace. It is deeply true of the labor movement that the alternatives before it are powerful peace and weak insurrection. Thus if the I. W. W. should succeed in organizing the unskilled on any extensive scale, the I. W. W., as we know it, would have abolished itself. For the unions which were created would inevitably seek a different type of leader, men of administrative capacity who can wield power without exhausting it. The extreme weakness of the unskilled workers has made them listen so eagerly to the large hopes of men like Haywood, Ettor and Giovannitti. . . .

"So far the real peril to the nation from the side of labor is the existence of great masses of unorganized, and perhaps unorganizable, workers. From them will come most of the street-fights, the beatings and the sabotage. They have no share in the country, they have 'nothing to lose but their chains.' But with the tactics open to them they haven't 'a world to win. They can parade and shout, call the police 'cossacks,' and talk revolution. But they have to put up with the pettiest gains. . . .

"When these prime conditions are achieved, labor's demands tend toward an increasing share of control. The right of summary discharge is the issue in many a strike. For unions will encroach more and more on matters of discipline; they are seeking to raise themselves to a partnership in the management. It is no idle guess to suppose that they will come to demand the right to choose their own foremen, perhaps to elect some of the directors, and to

take not only wages, but a percentage of the profits. . . .

"In this movement to eat into economic absolutism, very perplexing questions, of course, arise. What is the proper structure for a union? Shall it be organized by crafts, or occupations, or industries? With amalgamation, or by federation? How shall the unions be governed; by representatives or by direct vote? In fact, there is hardly a problem of constitutional government which doesn't appear in acute form among the workers. And in passing, one might suggest that scholars who wish to see sovereignty in the making can not do better than to go among the unions. They will find the initiative and referendum in constant use. They will find all phases of corruption and misrepresentation: the disappointments of indiscriminate democracy and the blight of officialism. . . .

"You think of the powerful organizations ready to combat every sign of unionism, of the congestion of immigrants in the labor market, of the hostility of courts and newspapers to the preliminaries of industrial democracy. I don't know, no one knows, whether labor can realize its promise. The odds seem to be overwhelming. . . .

"The unions are struggling to give the wage-earners representation, and that is why the hopes of democracy are bound up with the labor movement. Bound up, not with words and dogmas, but with the purpose which animates it. Labor needs criticism, needs inventive thought, needs advice and help. But no one can be given any of these things who has not grasped with full sympathy that impulse for industrial democracy which is the key to the movement."

FIXING WAGES BY LAW OR UNIONISM.

Mr. Harris Weinstock's Criticism.

"My attention has been called to the editorial published in a recent issue of your publication under the title of 'Trade Unionism, Progress and Liberty,' in which you take issue with me on an article written by me, and published in the Industrial Outlook, justifying the legal minimum wage for women and minors. In commenting upon my views as therein expressed, you say among other things:

"Now certain political actionists and benevolent outsiders present to trade unionists the proposition that regulation hours of work and wages be placed in the hands of political agents—minimum wage and universal eight-hour laws for private industries have been persistently advocated and trade unionists have been denounced because they have not favored them without reservation. Yet the surrender to outside authority of power to determine hours of work and wages means also to place in governmental authority either the enforcement of such determinations or the punishment of those who refuse to yield their freedom."

"Please remember that the question at issue between Mr. Rome G. Brown, who opposed a legal minimum wage, and myself was in relation to women and child workers, only a trifling percentage of whom are organized and are in a position to bargain collectively for themselves. State action has been advocated because of the weakness of these workers to scure for themselves reasonable hours and reasonable wages. To illustrate—the eight-hour day for women and minors has been in successful and satisfactory operation in the state of California now for about two years. If it had been left to trade unionists to bring about this desirable condition, it would have in all likelihood taken many decades to do so, if it could ever have been brought about. Meanwhile the fair employer, operating on an eight-hour basis, would have been seriously handicapped by the unfair employer operating on a nine or ten or a twelve-hour basis. Under the law all California employers were, so to speak, over night put upon the same basis so far as working hours for women and minors are concerned.

"In the matter of wages for women and minors, unionists are, of course, earnestly striving to establish collective bargaining, but it is likely to be many, many decades before, so far as women and minors are concerned, unionists will be in a position to establish a minimum wage in all branches of industry where women and children are employed. Whereas the state can bring about a change over night and all employers can again be placed absolutely on an equal basis, so that in the matter of wages for women and children the fair employer starts out on an even footing with the unfair employer, who will be compelled so far as labor cost is concerned to figure on precisely the same basis as does the fair employer.

"It would, of course, be a great satisfaction to trade unionism if it could be the means of bringing about this result. It would seem to me however that the interests of the untold thousands of unorganized women and child workers ought to be considered of greater importance than the desires of trade unionists, who, at best, represent a small minority of women and child workers. What ought to be sought for is the greatest good to the greatest number.

"You further state, 'Is human nature so constituted that the workers can trust matters affecting their real liberty in the hands of "disinterested" outsiders?'

"Under the legal minimum wage the worker takes no greater risk than does the employer. While it is true the worker might waive his right to fix a minimum wage, it also takes away from the employer his right to fix a minimum wage.

"As a rule the minimum wage laws are so devised that both the employer and worker have a voice in determining such minimum wage, and, as a rule, the state only intervenes as umpire, through its commission,

when the two parties, through their representatives, can not come to an agreement.

"Trade unionism has been in the field for many decades. It has not been able, generally speaking, to wipe out the sweat-shop. In New Zealand, in Australia, and in England, the state, by virtue of its minimum wage law, has succeeded in wiping out their sweat-shops. In other words, the state has been able to do over night, so to speak, what organized labor has not been able to do in many decades. The legal minimum wage has not only bettered the condition of the worker, but it has at the same time made it more possible for the fair employer successfully to compete with the unfair employer.

"If it were constitutional in the United States (which I gravely doubt) to fix a legal minimum wage for men as well as for women, I should for the foregoing reasons also advocate that. There would still be left the widest opportunities for trade unionists to go on serving the worker and society by striving for better working conditions, for the educational and moral uplift of the worker, and for continued legislative measures in the interest of the wage-earner. Therefore, in my opinion, trade unionism has little to fear from a legal minimum wage for men as well as for women, provided such legal minimum wage is determined, as it ought to be determined, by giving both sides in each trade a voice, calling upon the state only to act as umpire when the two parties at interest can not agree.

The A. F. of L. Rejoinder.

In the above criticism of our editorial published in the March issue, Mr. Harris Weinstock fails to consider the fundamental objection urged against regulation of industrial relations by law. Betterment of industrial relations for wage-earning women involves the same principles as betterment of industrial relations for wage-earning men.

In discussing wage regulation for women one must keep in mind the revolutionizing changes that have been taking place in the lives of women. Women have always done their share of the world's work. Formerly that work was done at home. Changes in industrial methods have taken that work out of homes into shops and factories. Women have followed their work out into the industrial world where they are no longer the helpers but the industrial competitors of their men folks. So far as industrial relations with employers are concerned there is no difference between male or female. A system of regulating industrial relations established for one class of workers will affect and, it is reasonable to believe, finally apply to the other. In New Zealand, in Australia, and in England laws establishing the principle of governmental regulation of wages apply to both men and women. In Australia a vigorous fight was

made to exclude men from the provisions of such legislation, but that policy did not prevail.

The workers have learned from experience that permitting governmental agents to regulate the terms under which they work puts into outside hands power to control conditions of work. That policy restricts the freedom and therefore the power of the workers themselves.

The woman movement of the present day is a movement for freedom of women. Men can and will aid, but women must achieve their freedom. The best help that society can give them is to secure them opportunity.

The best way for women to secure better wages and better working conditions is through organization. With betterment that comes as a result of intelligent personal efforts, come increasing self-development, increasing power, resourcefulness and ability to take advantage of gains and use them as the basis for further progress.

Mr. Weinstock offers as an objection that only a small percentage of women and child workers are organized. We are sorry that that is true but just as the remedy for many of the defects of democracy is more democracy, so the remedy for this evil is more organization. When a worker's arm muscles are weak the physician prescribes exercise. A hoisting apparatus might perform the work but it would only relieve those muscles of responsibility, and would continue the weakening of them. If Mr. Weinstock, other employers and well-meaning persons would apply their efforts to removing obstacles that retard organization they would be promoting the establishment, not of minimum wages but of wages that would enable wage-earners to maintain American standards of living, and would put them in a position to raise those standards as opportunities might be afforded.

In Oregon the Industrial Welfare Commission fixed the minimum for factory workers at \$8.64 per week, nine-hour days. That sum has been carefully determined by expert analysts who painstakingly reduced women's essential needs to cents—not the conscientious 64 cents. Mrs. Gee of the Garment Workers' Union of Portland, in her testimony before the federal Industrial Relations Commission, of which Mr. Weinstock is a member, stated that the highest wage paid to the organized garment workers was \$25 (16 2-3 per cent of workers received this sum); that the average wage was a little more than \$10 a week; and that the minimum wage paid to apprentices was \$8. However, as the garment workers had established the eight-hour day through their organization, the union minimum was a higher rate than that fixed by the Industrial Welfare Commission.

Fortunately the eight-hour day of the garment workers is under their own control and not subject to the more "liberal" ideas of legislative action such as "over night" granted the Industrial Welfare Commission

authority to suspend the women's ten-hour law for canneries.

Even the most ardent advocate of regulation of wages by legislative methods concedes that the method by organization is the better way, wherever practical. That it is practical is demonstrated by what the needle industries have done in organizing "mere girl" workers. The labor movement does not always attain its aims as quickly as one could wish—it is a movement of poor people. It has to break down barriers and opposition interposed by the ignorant and the sordid wealthy. But it will succeed in time; all it asks is opportunity. Meanwhile it demands that so-called "philanthropists" shall not throttle it by regulations "by law."

If the same efforts that are now expended in legislation to regulate women's wages were expended in promoting organization so that wage-earning women would be in a position to manage their own affairs, those sympathizing with underpaid workers would be doing them not only a greater but a permanent service which will not come home to haunt and shackle them.

Through legislation an eight-hour day may be secured "over night, so to speak," Mr. Weinstock argues. Through legislation it may again become a twelve-hour day "over night" as happens in the canneries of New York state. What is secured through legislation can be lost through legislation. This is demonstrated by the work of reactionary state legislatures during this year's sessions in New York, Ohio, Iowa, Washington, Oregon.

In New South Wales, "over night" wages prescribed by wages boards dropped to 13s and 12s (about \$3.25 and \$3). For several days and nights they remained at under-subsistence mark and returned to 17s and 16s only after a vigorous protest of organized workers. This "over night" change reveals the ease with which wages boards may be manipulated by interested employers. In New South Wales the public or "the state only intervenes as umpire"—an arrangement which Mr. Weinstock regards as a guarantee of security to the workers.

No development happens "over night." The causes and forces that result in the development may not always be apparent but nevertheless they exist. Even the state can not do things over night for laws do not become automatically effective. Law reflects a definite demand of public opinion and its enforcement is the result of the activity of those who will be affected by its enforcement.

Whatever benefits have come to the workers have come because they themselves first called attention to existing wrongs and demanded justice. The unorganized have benefited directly and indirectly from organization. Does Mr. Weinstock or any one else imagine that if all organizations were destroyed the workers would be protected by any amount or kind of legislation?

Unorganized workers are powerless to secure either the enactment of a law or its enforcement. Organized workers do not need legislation of the character suggested, for through their organization they participate in making the laws directly affecting them and their interests. And what is of equal importance is that they administer these laws. These laws are not declared unconstitutional or repealed. Regulation of industrial relations through organization is based upon democratic principles and is the antithesis of bureaucracy or paternalism.

Australia is generally referred to as a country governed by "Labor"—at present so-called labor government is in control in the Commonwealth and several of the states. Even under such conditions, the workers complain that the governmental machinery to regulate industrial relations is manipulated by employers to increase their own profits.

Mr. Weinstock says: "In New Zealand, in Australia, and in England, the state, by virtue of its minimum wage laws, has succeeded in wiping out their sweat-shops."

The author of that sweeping statement does not lack courage. Can it be that anyone believes that sweat-shops no longer exist in England? As for New Zealand and Australia perhaps Mr. Weinstock may be persuaded to admit that there may be different opinions as to the economic and social conditions there.

The attention of Mr. Weinstock is here called to the statement published in the Australian paper quoted in the first article in this issue and here requested:

"With all our laws, have we not stodgy, ill-ventilated tenements? Have we not evil-smelling, disease-reeking, tiny backyards and alley ways? Do we not see, right here, sallow-faced girls, aged before the blush of maidenhood has left their cheeks? Do we not see frail mothers double bent, because of the lack of proper knowledge to show them that they are living under improper conditions? Do we not see the puny children, pale and listless, tired and devoid of energy, and, as I am told by an eminent physician, full two inches short in their height, because they live in the slum quarters of our own cities?"

The workers of Australia, through their official journals and papers, complain of exploitation and sweat-shop conditions. One of the most radical labor papers recently contained this statement:

"Unionism is the hope of the world. It is the only way of salvation for the workers."

Mr. Weinstock in his reply again implies that the trade union movement is actuated by selfish motives in its opposition to the legislative method for regulating industrial relations. Despite the viewpoint that our critic insists upon attributing to organized labor, the reasons for our opposition are those which we have presented here and at

many other times. The workers think that their widest opportunities and their greatest welfare will result from organization preferably than from governmental regulation. Because Mr. Weinstock differs from us does not prove us wrong. Rather it is proof that an employer even when acting as umpire will still be influenced by employers' interests and employers' ideals of "educational and moral uplift" of the workers.

From recent events it is fair to assume that Mr. Weinstock has come under the influence of the Drews and the Merritts of the National Association of Manufacturers.—American Federationist.

THE VOCATIONAL SCHOOL VS. AMERICA.

As pathetic a philanthropy as one might see is some good woman's bequeathing her fortune to a school for the training of servants. Unheard of in America, it is no unusual happening in England. Vocational schools for maid servants, for butlers, waiters and the like has become in a sense one of the proper departments of education. To the American mind there is a vague pathos and humiliation about such an institution which does not easily explain itself.

What is wrong with a school for waiters? American as it is to maintain an equality of all vocations, and therewith an equality of dignity and honor, something in a school for waiters nevertheless frightens the American as it would no other countryman. Why not the trained waiter? One feels, somehow, a twinge of abridged democracy at the thought.

The trouble is in the recognition of the waiter by the educational system. To wait on table is no disgrace for a good American. To accept that as one's proper place is a different matter. One dislikes education to admit waitership as a proper aspiration.

A vocational school of waitership imposes a limit on the ambitions of a certain group of citizens. This limitation is more decisive as the citizen making the choice is younger. Why this is not a proper limit for the aspirations of some men is a long discussion. The remaining fact is that for the American it is not. No other people have so keen a contempt for an accepted humble place. No other people have so high a respect for a humble place unrecognized.

This is the trouble with the vocational school of waitership. Its tendency to classify certain men, and to train them to accept the limitations and duties of a certain class is not traditional in this country. There is a difference between the vocational school and the professional school. The former from its nature and method seems to impose un-American limitations on a boy's opportunity. These limitations are not so much outer circumstances as the boy's own spe-

cialized training, his restricted purpose, his inability to enter other classes.

The only justification for waiters and such, in western opinion, is that men come to it by accident. When citizens are waiters by accident of money, of brains, of health, of friends, of circumstances, in general, they are respected. When they are waiters by ideal and plan they are true spirited Americans no longer. This, it may be, is a misguided aspiration, but it is American democracy.

The democratic protest to a vocational school for waiters applies in lesser degree to all vocational schools. A boy bred to a vocation is a member of a definitely recognized class. A good school has formative, differentiative influence on a boy. A vocational school is no exception.

Has education a right to direct a group of citizens into a social blind canyon, early vocational training? The trade and, in the narrower sense usually meant, the vocation admittedly do not offer opportunity for higher self-realization that traditional America demands. It may be happy and comfortable enough in the blind canyon, but the truth remains that the boy or girl by training, breeding and plan is limited to the space within its walls. Classes must be, but to the American they must remain accidental.

But does not vocational training in another sense offer just the equality of opportunity that democracy demands? Is not here youth's chance to make his choice and to become what he wishes? There are two cogent factors against this. The vocational school by its method makes all later and more mature choices subservient to an early and in many cases ill-considered choice. The school in reality becomes the determinative factor in the necessary and mature choice of life work.

The vocational school, secondly, groups our citizenship into special classes. It specializes and trains children for a specific class, excluding him proportionately from other classes. That he chooses, usually immaturely, does not relieve the trouble. The educational recognition of class, be it waiter or harness maker is in danger. It destroys the western principle of the accident of classes.

Our schools, until recently at least, have had as a tacit ideal to train every boy for the possible presidency and every girl a possible first woman of the land. Without regard for vocational differences and, which is eventually the same thing, class differences, America trained her child for himself rather than for his position. Vocational training can be the beginning, or at least the recognition of a beginning, of a class system. That this is wholly evil no one can affirm. That it is not without dangers to western institutions and customs is also doubtful. It can be the breaking of America's frontier ideals.—B. B. in "Teaching," the State Normal School, Emporia, Kas.

THE BOILER MAKERS' JOURNAL

Official Organ of the International Brotherhood of Boiler Makers, Iron Ship Builders and Helpers of America.

A. Monthly Publication Issued the First of Each Month from Room 8, Law Building, Kansas City, Kansas.

JAMES B. CASEY, Editor and Manager.

Subscription Price.....\$1.00 Per Year in Advance

ADVERTISEMENTS.

Advertising Rates Will be Furnished Upon Application to the Editor-Manager. No Reading Space Will be Sold for Advertising Purposes Under Any Circumstances.

All New Members Must Have Their Name and Address Sent in Through the Secretary of Their Lodge. After That They May Have Changes Made in Their Address by Filling Out Blank Form in Back of Book and Forwarding to the Editor.

All Copy Must be Received by the Editor by the 18th of the Month to Insure Publication in the Following Issue.

All Contributions and Correspondence Relating to the Journal Should be Addressed to J. B. Casey, Editor, Room 8, Law Building, Kansas City, Kansas.

Entered at Postoffice, Kansas City, Kansas, as Second Class Mail Matter.

THE BONUS SYSTEM TRIED AND FOUND WANTING IN EQUITY AND JUSTICE.

About eleven years ago the Santa Fe System cut off all dealings with organized labor among its shop or mechanical trades and since has not allowed union men to remain in its employ. About the same time it inaugurated the Emerson system of stop watches, standard time, bonus and its other attendant evils. Since that time the shops of this company have been as isolated to union men as was Japan to the balance of the world before one of our American admirals forced open to trade one of its ports. Union men were not given employment if their affiliation with organized labor was known and were discharged when discovered, unless it was hard pressed for competent men when those in charge would shut their eyes to the fact until the rush was over.

The officials of this company will no doubt say they are maintaining their shops on an open shop basis. This is the hypocritical assertion of all unfair employers who falsely prate about the open shop and freedom of contract. Labor has long since learned to interpret the meaning of these false platitudes to mean that the open shop is open to all but union men and that its freedom of contract is the untrammelled freedom of the employer to impose any unfair conditions it wishes upon their employes without the restraining influence of organized labor.

Some time ago an industrial survey of the city of Topeka, Kas., was made under the auspices of the Russell Sage Foundation. A copy of this report was recently forwarded to us, and we find that considerable space is devoted to the bonus system of paying wages in the Santa Fe shops, located there, which by the way are the largest shops on this road.

While the report is based upon the records as furnished by the company and of course it would not reveal any damaging testimony against any of its methods, still an unprejudiced person cannot read the report of the investigation without being forced to realize how unfair and detrimental to the working people is this unfair bonus system. Like all such it has proven to be a delusion and a snare. One cannot beat the manipulator of a shell game, neither can they make anything working this bonus or piece-working system, as there is

generally some way to prevent one from realizing the advantages held out as a possible reward.

The Santa Fe System promises 20 per cent premium for those who perform a certain piece of work within the time allowed—the workers have nothing whatever to do with setting the time allowed—this is done in an arbitrary manner by so-called experts. They can alter, change, raise or lower to suit themselves. However, it is quite likely their continued employment depends on it being kept down to an irreducible minimum—the amount of bonus earned. The records show that so far as the boiler shop is concerned very few men are able to earn this 20 per cent bonus and that only 50 per cent of all those working the system in the boiler shop earn any bonus at all. The records show the rates of pay is much lower than that paid in this section, and that even when the bonus is added to the day's rate, the amount received is less than that paid by other roads in this section. Furthermore, the handy men and helpers do more than two-thirds of the work, and the apprentices more than half of the balance. For instance, here is the number of men given as the average for the month in which this "survey" took place.

Boiler makers, 28; apprentices, 37; handy men, 18, and helpers, 115.

These figures will show at a glance the conditions that obtain as well as the inferior class of work that must be turned out. Furthermore, it shows why the management does not want to deal with organized labor. They are not willing to accord to their employes a square deal; these industrial despots try in vain to justify their unfair position; they can't do it. These conditions are some of the real causes for industrial unrest.

The Pennsylvania Railroad recently had a sixty-page book printed and distributed broadcast, trying to explain away the odium attached to its tyrannical industrial system, in which it refuses to treat with organized employes under the false plea that to do so it would have to contend with strikes, discord, etc. This is false reasoning and the reverse of this result would ensue if these corporations would treat with organized labor and enter into yearly agreements that would remove all unrest, provided they are willing to be fair to their employes. On the other hand, by refusing to treat with organized labor, their employes will remain unorganized for the present, but the time will come when these men will wake up to the injustice and tyranny that has been practiced upon them and will indulge in anarchy and sabotage. They are sewing the wind and will reap the whirlwind.

INDEPENDENT DEALERS ATTACK THE UNITED CIGAR STORES COMPANY.

The Independent Retail Tobacconist Association has gone on the war path against the United Cigar Stores Company and the American Tobacco Company. The association has filed complaint with the United States attorney general, asking for the dissolution of the United Cigar Stores Company as an illegal combination in restraint of trade under the federal anti-trust laws.

It is charged that the American Tobacco Company will only sell its products to the United Cigar Stores Company, and that both of these companies are

mixed up with the United Profit Sharing Corporations, which gives coupons and promises gifts for every so many million coupons secured. When the whole facts are unearthed it will no doubt be found that these other two corporations are only subsidiaries of the American Tobacco Company.

In the meantime our members should not patronize any of these stores, as they do not handle any union made goods of any description, while the independent stores usually do, and they should be patronized.

EMPLOYEES OF THE LA FRANCE ENGINE CO. STRIKE.

On May 6th the boiler makers and machinists employed by the LaFrance Engine Company, of Elmira, N. Y., went on strike. Six boiler makers and about 135 machinists are involved. The company refused to treat with the men as an organized body. Representatives of the machinists and our organization, as well as those from the Mediation and Arbitration Board of the state of New York, tried to settle the matter peaceably but without result. The company is connected with and being supported by the Manufacturers' Association.

Hours and conditions of employment as well as wages are the causes for the strike, all of which are bad, we are told.

FEDERAL ARBITRATORS MAKE AWARD OF WAGE INCREASE FOR ENGINEERS AND FIREMEN.

The arbitrators appointed under the Newland Act, to whom was referred the request of the engineers and firemen on eighty-eight Western railroads for an increase in pay and other concessions and who have had the matter under consideration since November 30, 1914, recently rendered an award in which a small increase in wages was granted. From the sentiments expressed by representatives of the two organizations the award was very much of a disappointment to them.

While we naturally sympathize with anyone seeking an increase in wages and like to see them realize their desires, however, the experience of the past demonstrates fully that it is not, as a general thing, possible to advance the wages of one class of mechanics very far above that of other trades, and as the wages of the transportation employes are much higher than that of the shop trades we fear they will find it hard work boosting them much further until the shop trades are able to secure a boost for their members.

There is an inexorable law of interdependence of all trades and callings. What affects one will eventually affect all in a more or less degree, and therefore what concerns one should concern all.

The transportation organizations in the past have held aloof from the balance of organized labor. This policy of isolation may have served them in the past, but we believe that in the not far distant future it will not prove so desirable and that these organizations will come to realize that it is to their advantage to seek affiliation with and become a part of the general labor movement.

A LARGE INCREASE IN BUILDING PROGRAM OF NAVY.

It is reported that Congress, at its next session, will be asked to authorize the building of six large high speed battle cruisers, four battleships, a number of torpedo boats and destroyers and a large number of submarines. If all were authorized, it would be by far the largest program of building ever undertaken by our government, but whether all are provided for or not it is more than likely that the number will be considerably increased over the number authorized in the past.

Several of the battle cruisers will be decided on, no doubt. Up to the present time our navy officials have failed to build any of this class. They are equal almost to a battleship and have a very high speed. Some of these vessels will, no doubt, be built in the navy yards. Most if not all should be built there, for instead of the profits going to stockholders, in the navy yards it is divided among the men in shorter hours and a living wage.

The New York yard has gotten most of the ships built in government yards so far, but there is no reason why at least two yards on the Atlantic and the same number on the Pacific should not be equipped to build any of the ships needed. It would insure economy in cost of work and better work being done on the ships, and in time of war should we be so unfortunate as to have to face such, they would be invaluable to the navy.

Our navy yard lodges, where conditions and facilities would warrant such an undertaking, should get busy and endeavor to have appropriations made for the necessary equipment and machinery. If they secure these, the building of vessels will soon follow.

Twenty-two or twenty-three years ago some large and powerful vessels were built at the Norfolk navy yard. These ships afterwards made splendid records for efficiency, especially the old battleship Texas.

As that section of the country abounds with lots of efficient mechanics and the facilities and equipment of that yard have been greatly increased in recent years, there is no reason why there should not be a ship on the stocks there all of the time.

No doubt as good reasons can be given why ships should be built in yards on the Pacific coast.

A. F. OF L. WITHDRAWS INDORSEMENT OF THE TAILORS' UNION LABEL.

At a recent meeting of the Executive Council of the American Federation of Labor complaint was made against the Journeymen Tailors' Union by representatives of the United Garment Workers of America, that they were placing the tailors' label on ready-made clothing and clothing made by the seceding faction of the United Garment Workers of America, and that it was in direct conflict with the laws of the Tailors' Union, which forbids the label being used by anyone not a member of that organization.

The facts leading up to this condition seems to be that at a convention of the United Garment Workers last year a portion of the delegates bolted the

convention when they could not carry things as they wished them, and organized a dual organization. The tailors' organization is dominated at the present time by advocates of industrial unionism, and in order to help carry out their ideas of a one big union they formed an amalgamation with this dual organization of garment workers. The last convention of the A. F. of L. investigated the matter and ordered the Journeymen Tailors' Union to resume their former name and sever their connection with the seceding faction of the garment workers. It seems, however, the tailors' officials proceeded to form the "Tailors' Industrial Union," and were using the tailors' label on work done by both the tailors and the garment workers. The Executive Council of the A. F. of L. canceled and withdrew the A. F. of L. indorsement of the Journeymen Tailors' label until such time as this organization complies with the orders of the A. F. of L. convention.

It seems the tailors' organization is in the throes of factional fights, which are bound to have a demoralizing effect. However, there seemingly is a rift in the clouds and that the question of amalgamation will be again opened and that it will back away from the suicidal policy of federating with seceders from another organization.

EX-MAYOR HARRISON OF CHICAGO FAVORS PUBLIC OWNERSHIP.

On the eve of retiring from the office of mayor, after having served in that capacity for five terms, Carter Harrison came out as an advocate of public ownership of public utilities. He is quoted as saying: "The more I see of private ownership of public utilities the more I am convinced that there is but one safe plan for the public to adopt, namely, to set its mind upon public ownership and not to deviate by a hair's breadth. Private management is interested in profitable operation. Economy of operation and inferior service contribute to increase profits. Economy of operation consists chiefly of low wages and long hours for all employes except the higher officials.

"Private management, however, can be made profitable by all the devious ways known to the modern financier. The Chicago surface lines are paying stockholders 5 per cent upon a valuation of which \$40,000,000 is represented by no physical property whatever.

"Years ago the conviction forced itself upon me that graft in municipal government was directly attributable to the private ownership of public utilities *and to the contract system of construction of public works.*"

While there is nothing new in these statements, we all have confidently believed all of them and more were true, still it is well to have the opinion of a man who, for twelve years, was in a better position than possibly any other American official to know and see what the real conditions were and the source of the corruption that seems to be inseparable from corporations owning public utilities. These as well as the large trusts are the source of more corruption in public and private life than all other causes combined.

We believe with Mr. Harrison that public ownership of public utilities is bound to come, and the sooner it arrives the better it will be for everybody, and especially the cities and their inhabitants.

AN OUTRAGEOUS VERDICT.

Justice has been outraged in the verdict of the venal jury that brought in a verdict of murder against John R. Lawson, executive board member of the United Mine Workers' organization, for alleged complicity in the death of a gunman in the employ of the mine owners at Ludlow. It was not charged that he had any direct connection with the killing or that he was even present when it occurred, but simply on the grounds that he was the leader of the men on strike. To use such a flimsy pretext with which to fasten such a crime upon one who was not even present when the killing took place is a travesty on justice and it does the working people a far greater injury than did the Ludlow massacre, when women and children were brutally shot and burned to death by gunmen acting as militiamen. These brutes were white washed and allowed to go scot free, while Lawson was found guilty of murder and sentenced to prison for life, not because he had anything to do with the killing of this gunman, but because he was the leader of the men on strike.

It is charged that the two chief witnesses for the prosecution were gunmen in the employ of the Baldwin-Felts Detective Agency; that the presiding judge, who was recently appointed judge, previous to his appointment, was an attorney for the mine owners and that he had severely criticised officials of the union. He was accused of prejudice against organized labor while the trial went on, but refused to disqualify himself from presiding. Furthermore, it is charged that some, if not all of the members of the jury, were tools of the company—that it was, in fact, a hand picked jury. If half of these charges are true no wonder a verdict in conformity with the wishes of the mine owners was rendered.

Of course, this unjust verdict will be fought to the bitter end, for it is a stab at the vitals of human liberty and justice, and it is but one of the series of such that labor has received from the courts in the past few years. Some of the worst of which have come from the federal courts. Here are a few of them: Fine and imprisonment for A. F. of L. officials because they published a boycott list, legalizing the black list; holding the members of the Hatters responsible for triple damages because they went on strike, and the firm they were working for pleaded a loss, and this last stab where they are trying to establish the principle of personal responsibility of labor leaders for any unlawful acts that any disorderly person may commit even though it be without his knowledge or consent. It might even be a strong armed hireling of the struck company—it matters not. The forces and influence behind this farcical trial and sentence of Lawson would establish such a diabolical precedent so that labor forces would be deprived of leaders, either through intimidation or imprisonment.

An old saying handed down possibly from ancient Grecian mythology to the effect that "Whom the gods wish to destroy they first make mad," it may be so in this case. At any rate unless the courts take a tumble to themselves it will only be a short time until the people will insist on a new deal, with greatly curtailed powers for these courts.

SECRETARY OF LABOR, WILSON, CALLS A CONFERENCE ON LABOR.

We are informed by the daily press that Secretary of Labor Wilson has called a conference of representatives from federal, state and municipal governments to be held at San Francisco August 2nd.

The main purpose of the conference, we believe, is to arrange for a system of co-operation between the federal, state and municipal authorities in solving the problems of labor distribution and the maintenance of labor exchanges. A conference of this kind should be productive of good, practical results in dealing with this important subject.

There has been so much fraud and rascality shown in connection with private employment agencies in the past few years, we are thoroughly convinced that all private employment agencies should be suppressed and this matter handled by federal, state and city governments. All incentive for fraud and gouging of unfortunate people out of employment would be eliminated, and by a system of co-operation, these governmental agencies would give better results in distributing and finding employment for those out of work.

PULLMAN CAR COMPANY GROWING WEALTHY ON TIPS.

At the Chicago hearing of the Industrial Commission, the Pullman sleeping car porters came in for investigation, or rather the methods and wages paid by the company, and it was found that only about one-fourth of the actual money needed to keep themselves and family was paid these porters as wages by the company, and the public was expected to pay the balance, notwithstanding the fact that this company has paid fabulous amounts in the past twenty years as dividends; some of the latter were stock dividends issued so that the enormous surplus of net earnings might the more readily be absorbed.

This tipping system is an imposition upon the traveling public and at the same time degrading and demoralizing to those who receive them. The company should be forced to establish an equitable standard of wages for these porters and be made to pay it out of its earnings instead of by the public.

It is a strange freak of fate that placed a son of Abraham Lincoln at the head of this corporation that so shamelessly uses the colored man to extract tips from the public in order to make its pay roll less a burden. While the father emancipated the colored man, the son is the executive head of a corporation that keeps an army of them in industrial bondage. The company is the real recipient of these tips, as they obviate the necessity of paying a living wage.

A. F. OF L. TO WAGE A CAMPAIGN AGAINST DETECTIVE AGENCIES.

At a recent meeting of the Executive Council of the American Federation of Labor it was decided to inaugurate a campaign, having for its object the

regulation of detective agencies by having Congress and the state legislatures enact laws for this purpose.

The Executive Council indorsed the Illinois law on this subject as a model law, and it seems that Congressman Baltz introduced in Congress last year a bill fashioned after this law, and which the Executive Council thinks can be passed if the forces of labor get behind it and work earnestly and diligently for its passage.

These detective and strike breaking agencies have been fattening long enough off the carcasses of defunct labor unions which they, by all kinds of foul and unfair means, have helped to put out of commission, and our members to a man should solidly line up behind this measure and resolve to work aggressively and diligently until these laws have been enacted. Senators, congressmen and members of state legislatures should be questioned as to how they will stand when this measure comes up for enactment.

The public has had many examples of corruption in connection with detective agencies recently and which show conclusively that they should be strictly regulated by law, for the benefit of the community in general and organized labor in particular, as they have been used by unscrupulous employers to harass and oppress labor on all sides, and if they are properly regulated their power for evil towards organized labor will have been destroyed.

The strike breaking agencies often organized in conjunction with some of these agencies are the most corrupt and debased bodies of men imaginable and don't hesitate at any crime in order to carry their point. By all means let's push this campaign and resolve not to let up until they have been brought back within the pale of the law and their power for mischief and crime removed.

CHICAGO LABOR OFFICIALS INDICTED.

The daily press recently announced that a federal grand jury had brought in indictments against eighteen labor officials of Chicago, and eighty-two contractors and corporations, on the charge of violating the Sherman anti-trust law, by preventing the unloading of machinery shipped from another state into Chicago. They are also accused of forming a combination to force the sale of only certain electrical apparatus, so that articles of this kind shipped from other states could not be sold in Chicago because of this combination.

We do not know what ground there is for these charges. Grand jury indictments should not have much weight, as only one side and ex parte testimony is given. The true facts will no doubt come out in the trials. As for the charge of preventing the unloading of unfair machinery shipped into Chicago from another state, even if true, there should be nothing to it, as this is clearly a right of the men. It is a part of the right to peaceable picketing, and if the machinery, or contractors using it, are unfair to the men it is within their right to try to prevent its being unloaded or used, provided they do so peaceably. To make any other construction would be to take from labor all power to force redress of grievances. As for the alleged combination to limit the sale of electrical apparatus to a certain make, approved by the combination, we know nothing about and will wait the evidence and facts before forming a conclusion.

DEATH OF A PROMINENT LABOR EDITOR.

The international officers of the International Association of Machinists recently announced the death of Mr. D. Douglass Wilson, editor of the Machinists Journal, which occurred on the 3rd day of May.

This brother was one of the oldest in the point of service of any of the international editors, having served as editor of the Machinists Journal for twenty years, and while sorely afflicted, physically, issued a journal that reflected credit upon himself as well as the organization he represented.

The Journal extends its sympathy to the family of the deceased.

AN "OPEN SHOP" TANK BUILDING FIRM LOSES WORK.

Word was received at headquarters a couple of days before closing this issue that the work which was being erected for the Gulf Refining Company at Port Arthur, Tex., by the firm of Reeves Bros., of Alliance, O., had been taken over by the Gulf Refining Company to be completed by itself with the union men on strike against Reeves Bros.

This is one of the firms that formed a combination and tried to establish open shop conditions in the Oklahoma oil fields, and when our men were locked out in Oklahoma, our men employed by these firms in other places, including this work for the Gulf Refining Company, quit work and have been on strike since.

The work will now be done by these men working under union conditions and for a fair company.

OUR POSITION INDORSED.

Since the last issue went forth to our members we have received in various ways, many expressions of approval for the stand we took in cutting out the publication of articles of a personal or muck-raking nature.

We are glad to receive these expressions of approval from our members, not only because it vindicates our position but because it shows our members are thoroughly alive to the best interests of our organization, and all of its members. There could not be anything gained by anyone in continuing to publish articles like some we had in the past few issues, on the contrary it would tend to disrupt and destroy our organization; surely there is not one of our members that desires to be a party to such a result. We firmly believe so and, therefore, look for a continued compliance from all, to our request to not send anything of a personal, abusive, fault-finding, criticising nature. We hope our expectations in this matter will be realized, but if it is not and articles containing personal abuse or criticism, or insinuations or like matter, is sent in, we will be compelled to adhere to our announcement and cut out the offensive paragraphs or reject the articles entirely.

QUOTATIONS.

I should wish to act, no doubt, in every instance as I pleased, but I reflect that the rest also of mankind would then do the same; to which state of uni-

versal independence and self-direction I should meet with so many checks and obstacles to my own will, from the opposition and interference of other men's, that not only my happiness but my liberty would be less than whilst the whole community were subject to the domination of equal laws. The boasted liberty of a state of nature exists only in a state of solitude. In every kind and degree of union and intercourse with his species it is possible that the liberty of the individual may be augmented by the very laws which restrain it; because he may gain more from the limitation of other men's freedom than he suffers from the domination of his own. Natural liberty is the right of common upon a waste; civil liberty is the safe, exclusive, unmolested enjoyment of a cultivated inclosure.—Paley.

Pride is as loud a beggar as want, and a great deal more saucy. When you have bought one fine thing, you must buy ten more, that your appearance may be all of a piece; but it is easier to suppress the first desire than to satisfy all that follow it.—Benj. Franklin.

Probability is the appearance of the agreement or disagreement of two ideas by the intervention of proofs whose construction is not constant, but appears for the most part to be so.—Locke.

Who by aspersions throw a stone at the head of others, hits their own.—Herbert.

He who will not reason is a bigot; he who cannot is a fool, and he who does not is a slave.—Byron.

STRIKES NOW IN FORCE.

- Illinois Central R. R. (Federated Trades strike on.)
- Harriman Lines. (Federated Trades strike on.)
- Pere Marquette R. R., Grand Rapids and Saginaw, Mich. (System Federation strike.)
- Contract shops, Mobile, Ala. (Metal Trades strike.)
- Atlantic Basin Iron Works (Shields & Moran, New York). (Strike on.)
- Hibbon & Co., contract shop, South Chicago, Ill. (Unfair.)
- Milwaukee Boiler Co., Milwaukee, Wis. (Strike on.)
- Stockton, Calif. (Metal Trades strike.)
- Warren City Boiler & Tank Co., Warren, Ohio. (Strike on.)
- Standard Boiler & Plate Iron Co., Niles, Ohio. (Strike on.)
- Reeves Bros., Alliance, Ohio. (Strike on.)
- Hammond Iron Works, Warren, Pa. (Strike on.)
- The Petroleum Iron Works, Sharon, Pa. (Strike on.)
- The Treadwell Construction Co., Midland, Pa. (Strike on.)
- Riter-Conley Construction Co., Pittsburgh, Pa. (Strike on.)
- Des Moines Bridge & Iron Works, Des Moines, Iowa. (Erecting work at Bremerton, Wash., Valejo, Calif., and Norfolk, Va., Navy Yards.)
- La France Engine Co., Elmira, N. Y. (Strike on.)

Mechanical Department.

To Develop Frustum of a Hexagon Shaped Pyramid

A-b-c-d-e-f-a, Fig. 1, shows the outline of plain view and h-n-i-k-m-j, Fig. 2, shows the side elevation, and Fig. 3 is the template.

To lay out, first ascertain the desired diameter and with G as a center strike circle in Fig. 1, divide the circle into six equal parts and strike lines from one division

continue until it cuts center line at O then strike line from K through I to the same point O. Next return to Fig. 1, and from Point G strike a line at right angles with line e-b, then take distance from M to O, Fig. 2, and transfer it to line G-o, Fig. 1, also take distance from M to N and mark it on line G-o, Fig. 1, and strike right angle line, then strike a line from b to o.

Then with O as a center and radius o-b

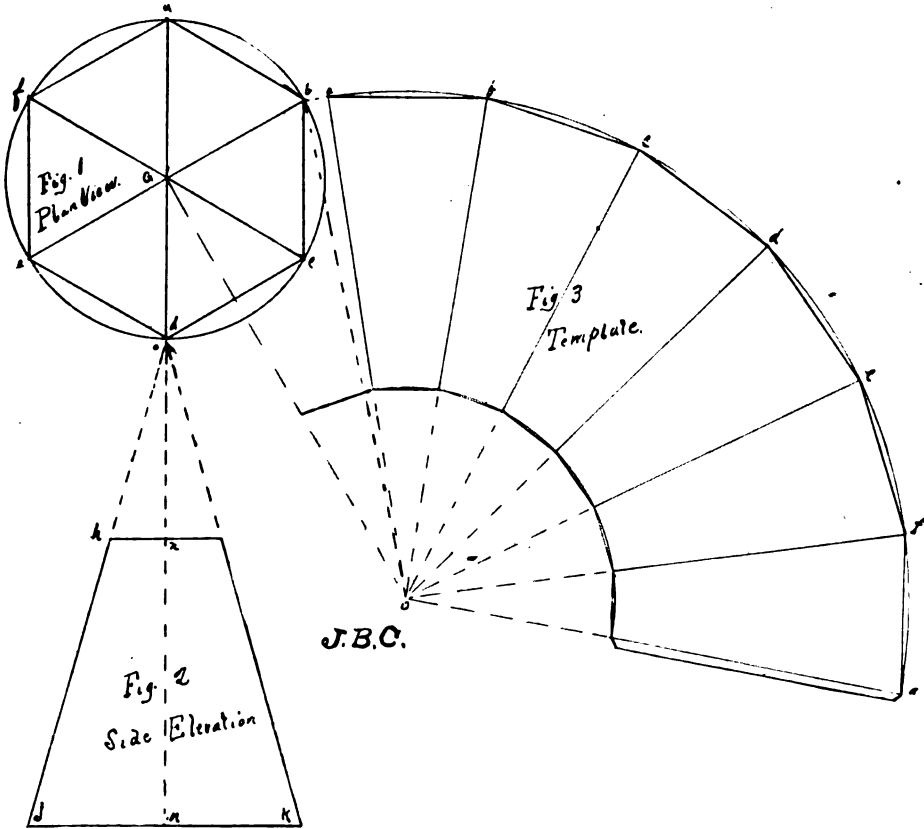

point to another until all are connected, then strike lines through center, draw lines connecting points on opposite sides as e to b, f to c, etc.

Next proceed to lay down the side elevation. First strike horizontal line j-m-k and make it as long as the distance from f to b or e to c, Fig. 1, and from the center M erect a right angle line m-n-o mark the straight height of frustum of cone from m to n, strike right angle line h-i through N then strike line from J through h and con-

strike the large circular line in Fig 3, next take the height which shows top of frustum, strike small or top end of frustum, take distance from a to b, Fig. 1, and mark it from a to b, Fig. 3, continue to mark in like manner until all points are taken, from these divisional lines strike lines to o until all points are taken, these lines represent the bending line.

Add sufficient metal on end of template to make a lap.

Connect points a b b c c d d e e f f A by straight lines, do the same with the top lines this will complete the template.

International Officers' Reports.

REPORT OF THE I. S. T. ON VOTE ON AMENDMENTS AND CONSTITUTION.

Kansas City, Kas., May 20, 1915.

To the Officers and Members of all Subordinate Lodges, Greeting:

I herewith submit the vote taken on the proposed amendment submitted by Lodge No. 123 to Article 5, Section 3 of the International Lodge Constitution, which has been published in the official Journal in the March and April issues:

Lodge	Vote
4.....	No
32.....	No
44.....	No
70.....	Yes
83.....	No
96.....	No
99.....	Yes
103.....	Yes
104.....	Yes
113.....	No
116.....	Yes
123.....	Yes
136.....	No
179.....	Yes
201.....	Yes
209.....	No
221.....	No
242.....	No
278.....	Yes
281.....	Yes
318.....	No
322.....	No
335.....	Yes
368.....	Yes
405.....	Yes
410.....	Yes
449.....	No
451.....	No
501.....	No
520.....	Yes
528.....	Yes
529.....	Yes
568.....	No
588.....	Yes
595.....	No

Total: Yes, 18; No, 17.

Number of lodges in good standing, 343. Total number of lodges voting, 35. Number of lodges indorsing the resolution, 18. Number of lodges voting against resolution, 17. Total votes cast equals 10.2% of lodges in good standing. Number of votes cast in favor of resolution equals 5.25% of lodges in good standing. Total number of votes cast against resolution equals 4.96% of lodges in good standing. Number of indorsements required by Article 3, Section 1, resolution failed to get the 20% indorsement in good standing equals 68 lodges. The resolution failed to get the 20% indorsement as required by Article 3, Section 1, as will be noted by the results shown falling far short of the mark, only receiving a frac-

tion more than one-fourth the required number.

Hoping this will be satisfactory, and with best wishes, I beg to remain,

Yours fraternally,
FRANK P. REINEMEYER, I. S. T.

To the Officers and Members of all Subordinate Lodges, Greeting:

We, the undersigned, have canvassed the vote taken by the lodges on the amendment submitted by Lodge 123, and certify that the result as prepared by International Secretary-Treasurer Reinemeyer is correct.

J. B. CASEY,
A. HINZMAN.

Kansas City, Kas., May 20, 1915.

To the Officers and Members of all Subordinate Lodges, Greeting:

I herewith submit the vote taken on the proposed amendment submitted by Lodge No. 126 to Article 5, Section 5, of the International Lodge Constitution, which has been published in the Official Journal in March and April issues:

Lodge	Vote
4.....	Yes
44.....	No
70.....	Yes
96.....	No
103.....	Yes
104.....	Yes
113.....	Yes
116.....	Yes
123.....	Yes
136.....	No
179.....	Yes
209.....	No
221.....	No
242.....	No
276.....	Yes
281.....	Yes
318.....	No
322.....	No
335.....	Yes
363.....	Yes
449.....	No
451.....	Yes
501.....	No
520.....	Yes
529.....	Yes
548.....	Yes
568.....	Yes
595.....	Yes

Total: Yes, 18; No, 10.

Number of lodges voting for Resolution, 18. Number of lodges voting against Resolution, 10. Total votes cast equals 8.16% of lodges in good standing. Number of votes cast favoring resolution equals 5.25% of lodges in good standing. Number of votes cast against resolution equals 2.91% of lodges in good standing. It will be noticed by the members of the Brotherhood that this resolution did not carry the percentage as required by Article 3, Section 1, and fell

far below the vote taken on resolution submitted by Lodge No. 123.

Hoping this will be satisfactory, and with best wishes, I beg to remain,
Fraternally yours,

FRANK P. REINEMEYER, I. S. T.

To the Officers and Members of all Subordinate Lodges, Greeting:

We, the undersigned, have canvassed the vote taken by the lodges on the amendment submitted by Lodge No. 126, and certify that the result as prepared by International Secretary Reinemeyer is correct.

J. B. CASEY,
A. HINZMAN,

REPORT OF SECOND INTERNATIONAL VICE-PRESIDENT NOLAN.

My last report was from Washington, D. C., March 5, received instructions from first international vice-president to take a matter up with the secretary of the navy which had been pending for some time, relative to an increase in wage for the boiler makers employed at the Norfolk Navy Yard as recommended by the wage board in 1914. After several conferences the question seemed to be adjusted satisfactorily and so notified the members of Lodge No. 57, through their secretary, Brother Thomas, but later on complications came up in the distribution of increase, which will be explained later on in this report.

March 7, by instructions from Vice-President Hinzman, left Washington, D. C., to investigate a grievance in the interest of Lodge No. 55. Met Brother Healy and other members after which I had a meeting with the general manager of the Newport News Shipbuilding and Dry Dock Company on the settlement of late strike; am waiting future developments pending an adjustment as agreed to between a committee of Lodge No. 55, Brothers McArthur, Williams and Ledwetch and the general manager of the company in order to make a complete report in next issue of Journal.

Lodges No. 57 and 428 have been doing some active work of late in reinstating delinquents and initiating new members. Have now about 97 per cent membership in both lodges.

The Sea Board Air Lodge No. 298, Portsmouth, Va., have a 100 per cent membership, but nevertheless are active just the same in helping to build the membership of the navy yard and contract lodges, hence through the active co-operation of all three lodges effective organizing has been done.

March 11, I was notified by Vice-President Hinzman to proceed to Rocky Mount, N. C., and confer with Brother Dixon on a grievance pending for some time with the officials of the Motive Power Department of the Atlantic Coast Line Railroad Co. Brother Dixon was chairman of the boiler makers on the system. On reaching Rocky Mount I met Brother Dixon and several other brothers of lodge No. 239, getting all information in connection with grievance as well as local conditions.

While at Rocky Mount I attended a local federated meeting of the trades employed at the Coast Line shops. Several short talks were made by members of the local federation, which was of special interest to the entire federation on the Coast Line, which I have no doubt will be carefully considered and acted on at the next regular federated convention. Before adjourning Brother Dixon made a very interesting explanation on the local situation, what had been done in the past and what can be accomplished in the future in the interests of justice, when labor forces stand royally together. His appeal for united action either in defense of the individual members, or the principles of the federation was surely appreciated by every member present, as Brother Dixon's statements on the question of federation and how conducted was absolutely correct.

March 14 I had a meeting with Mr. R. E. Smith, general superintendent of motive power, Coast Line Railroad, at Wilmington, N. C., going over the entire situation relative to Brother Dixon's grievance with the Company, using every appeal and argument to have him reinstated at the Rocky Mount shops, but no adjustment of grievance was made, unless to inform me that on his first visit to Rocky Mount shops, which would be in a few days, he (Mr. Smith) would make an investigation of Boiler Maker Dixon's case, and notify me result of investigation, but am still patiently awaiting his report on the promised investigation which I haven't received up to date, May 3.

Same date, March 14, I received a telegram from international office to leave as soon as possible for Portsmouth, Va., and report to the secretary of Lodge No. 57. On meeting Brother Thomas I found that a small increase in wage given was the cause of the grievance, due to the fact that the boiler makers employed at the Norfolk navy yard and the industrial manager couldn't agree on the introduction of a system that meant a decrease in wage for fifty per cent of the boiler makers. A pretty nice piece of economic juggling on the part of the industrial management, sure. An increase for 50 per cent of the force employed, and four new ratings added to the four old ratings in force for several years, which, if accepted, would make eight ratings in the boiler shop. There seems at this time to be no limit to the vagaries of the advocates of what is known as shop efficiency, even to the extent of disorganization of practical methods of production.

March 15 a special meeting of all boiler makers was held, Brother Phillips in the chair, in order to take definite action on the distribution of the wage increase, also the four new ratings about to be established. The result of the special meeting was, that a committee of two were appointed, Brothers Thomas and Calvert, to take up grievance with the general foreman boiler maker, Mr. Boole, as a matter of courtesy and naval regulations, also the industrial manager, Mr. Watts, and the secretary of the navy, if nec-

essary. According to instructions, Brothers Thomas and Calvert and an International representative called on the general foreman boiler maker, explaining to him action taken at special meeting. Afterwards called at the office of the industrial manager, but found he was absent, according to information given the committee, but Mr. Norris, his assistant, advised that we call later.

The following day, March 17, at 10:30, the committee had a meeting with the industrial manager in company with Mr. R. E. Glover, formerly a member of the Brotherhood, was a charter member of Lodge No. 57 and at present is the sheriff of the city of Portsmouth, Va., always ready to assist the boiler makers when called on, or any other craft when involved in a justifiable controversy with either a private corporation or the government in the interest of a square deal.

After being introduced to the industrial manager we explained the object of our visit and our reasons for opposing the injustice of the non-equal distribution of the wage increase, as well as the united opposition of the boiler makers to any increase in classes, other than the four classes then in force, but no amount of argument on the part of the committee or Mr. Glover could convince the industrial manager to recede from his position; pleaded with him to allow the four classes to remain in force, which had been for years, and distribute the increase to all as a matter of justice which they were entitled to, but would not consider an appeal whatever. Therefore committee informed him that the grievance would be taken before the secretary of the navy, handing him before leaving his office a protest to be forwarded to the Navy Department, after which a telegram was forwarded Senator Swanson of Virginia, to arrange date for committee with the secretary of the navy, and later on received the following wire:

Mr. Geo. Thomas, 204 Lincoln street, Portsmouth, Va. Meeting arranged with the secretary of navy at 10:30 a. m., March 23. Signed, Senator Swanson.

Committee left for Washington on the 22, Mr. R. E. Glover in company with them, arriving there on the morning of the 23, called on Senator Swanson, senate office in building, to explain nature of grievance and also to have him accompany the committee to the office of the secretary of the navy. The committee were received very courteously by the secretary, and the entire situation relative to grievance of the boiler makers at the Norfolk navy yards were fully discussed, also asking the committee many questions for information in connection with the case. However, no decision was reached, unless to refer the entire matter at issue to the assistant secretary of the navy. On his return from the Pacific Coast about April 10, committee leaving for home.

March 26 I left for Philadelphia to attend meeting of Lodge No. 19, of whose members are employed in the navy yard. On my ar-

rival there visited the yard in order to notify some of the members of Lodge No. 19 as per instructions of the International office.

Brother Higgs, late corresponding secretary of Lodge No. 19, called on me at hotel, also another member whose name I have forgotten, and in company with them left for meeting.

Meeting was called to order by Brother Goodfellow, president of Lodge No. 19, who explained the object of meeting, as well as conditions in the navy yards. A pretty fair attendance showed up considering the extreme cold weather, at least to the writer from the Sunny South. There were several good speakers present, namely: Brother Hitche, representative of the American Federation of Labor; Brother Roach, representative of the Moulders Union of North America; Brother Keenan, representative of the International Associations of Machinists of Philadelphia. Brother Ritche was chosen as permanent chairman of meeting, which he accepted, assuring all present that he considered it a pleasure as well as a duty on his part to assist in every way possible to build up the membership of locals whose craftsmen take no interest in the welfare of themselves, or their fellow workers, and thanked the officers and members of Lodge No. 19 for honor conferred.

Brother Ritche made a good practical address on the trades union movement and the absolute necessity of it to protect fair working conditions and wage in this age of financial combinations. Organized for the express purpose of defeating the legitimate efforts of organized labor, and closing his remarks with an appeal to all present to use every possible effort, not only in the interest of the Brotherhood of Boiler Makers and Iron Shipbuilders and Helpers of America, but all crafts in the city of brotherly love.

Brothers Roach and Keenan both made forcible addresses on the object of labor movement, giving practical reasons of the imperative necessity of organization among the wage earners in order to cope with the organized opposition of capital against their every interest. The meeting was a success and I desire to thank the officers and members of lodge No. 19 for consideration shown while in their city, and trust it's only a question of a short time when the boiler makers, iron shipbuilders and helpers employed in the government navy yards and arsenals will have a district lodge with a representative in Washington, D. C., to guard their interests and adjust grievances when necessary to do so. It can be done if the necessary co-operation of all lodges are given.

A federation of all crafts in navy yards and arsenals is an absolute necessity to secure legislation of a general character, otherwise it's impossible, as local efforts have not been successful in the past. Local federations should be organized in all government navy yards and arsenals, then in a

convention of delegates representing local federation, a national naval federation of trades can be organized on a permanent basis under the jurisdiction of their respective internationals, and the American Federation of Labor. There are several reasons why a naval federation of trades is necessary, in fact all employes know it from the past experience.

While in Philadelphia I received orders from Vice-President Hinzman to get in touch with Brother Napier, business agent of Lodge No. 341, relative to the struck job at Marcus Hook, Pa., and in company with Brother Napier went there, was introduced to Brother Carter in Chester and the other brothers then on strike at Marcus Hook, and talked over the strike situation there. Before leaving Philadelphia reported the strike situation to the International president.

I regretted very much to leave Philadelphia before having an opportunity of visiting the navy yard, but owing to an arranged meeting with the general manager of the Newport News Shipbuilding Co., on March 30, was compelled to do so. Meeting was held as arranged, Bro. McArthur of Lodge 55 with me, and was assured that settlement made with the committee would be carried out, therefore, will be in a better position to give a full and complete history of settlement of strike, cause of same and results, in a future issue of the Journal, as future developments may change the situation satisfactorily I hope.

March 30 I left on an evening boat for Baltimore to confer with the members of Lodge No. 193, also to assist in every way possible in building up their membership. Met Brothers Chaney and Gontrom, old members of the Brotherhood in the city of Baltimore. Afterwards had a conference with Brother Shandley, president of No. 193, on general conditions in Baltimore. Called on Brother Ickelberger, representative of the American Federation of Labor, to discuss matters of general interest to our Brotherhood and both of us were of one opinion as to what should be done to effect an organization of our craftsmen there, which was forwarded to President Franklin by night letter for his approval. Telegram was sent after Brother Shandley and I visited the tank jobs at Fairfield, now under construction by the Bartlett and Hayward Co., and the Novelty Iron Works of Baltimore.

April 7, attended an open meeting of Lodge No. 193; a fairly good attendance showed up from both jobs, which I believe will bring good results later on as several by a show of hands expressed a desire of becoming members at next regular meeting, as many of our craftsmen in Baltimore now realize that there must be an organization there, as conditions are going from bad to worse. No agreement to work under, no co-operation whatever, nothing but the privilege of competing one against the other.

When I look back at the position of the Brotherhood several years ago in the city of Baltimore and the present conditions, I must confess that I couldn't believe such a change would ever come about. At one time the Banner City of the Brotherhood in the East, working under an agreement and a fair wage, but matters have gone wrong, due to lack of an organization. No interest whatever unless to forge a chain for the purpose of making absolute slaves of our craftsmen in the interest of grasping corporations that recognize no principle or condition in the interest of human rights.

April 8, left Baltimore for Norfolk, Va., by order of the International president, to attend an arranged meeting between the officials of the Seaboard Air Line Railroad and the executive board of the federated trades on the above system, on a grievance pending since October, 1914, at the company's shops, Savannah, Ga. On reaching Norfolk found that meeting was postponed from April 12 to the 19 inst., during that time visited Newport News as well as attending to several matters in Portsmouth and Norfolk which needed attention.

April 19, the arranged meeting between the Seaboard officials and the federated executive board was held. After a two days' conference the grievance was adjusted satisfactorily. Brother Garvey represented the federated district. Brother Jewell, chairman of the boiler makers on Seaboard Air Line system, was also present as member of the executive board.

April 13, a telegram was received from Senator Martin of Virginia, dated Washington, D. C., representing the boiler makers of the Norfolk navy yards to send their committee there, as a meeting was arranged for them with the assistant secretary of the navy at 10:30 a. m., April 14. The committee was Brothers Thomas and Calvert, also the writer, arrived in Washington on date as requested, called on Senator Martin to explain nature of grievance; however, the senator informed the committee that owing to Lincoln Memorial holiday all government departments were closed until the following day. We afterwards called on Brother Berres, secretary-treasurer of the metal trades department, and knowing from past experience around Washington, that he is always ready to help when called on, we extended him an invitation to be with the committee when meeting Mr. Roosevelt the following morning, which he kindly agreed to do.

The following morning in company with Senator Martin, Congressman Holland, also Brother Berres, representing the metal trades department, and a committee from Lodge No. 57, Brothers Thomas and Calvert, met in conference the assistant secretary of the navy yard, also Captain Bryan, director United States navy yards, and am pleased to report that the controversy between the industrial manager and the boiler makers at the Norfolk navy yard have been

adjusted satisfactorily through the navy department. Therefore in consideration of adjustment the members of Lodge No. 57 desire to express their sincere appreciation through the columns of the Journal to their many friends who assisted them in adjusting a rather complicated situation.

On returning from Washington, D. C., visited the P. I. W. and Des Moines Bridge and Iron Co.'s jobs in company with the business agent of Lodge No. 428. Both jobs unfair, refused to recognize the Brotherhood, but our members obeyed the order of the International president, refusing to scab on their brothers in the oil fields of Oklahoma and other places where strike is on for fair conditions and recognition of the Brotherhood and again organized capital, whose object is to debase and crush the labor movement.

The strike of the boiler makers against the Roper Lumber Co., at New Bern, N. C., has not been settled yet, although every effort has been made to adjust it with the general manager and superintendent of the company on various occasions.

Just think, in this age of modern civilization that any corporation would insist on increasing the hours of labor from No. 9 to No. 11 without any compensation and further claim such was done from a humanitarian standpoint in order to keep the men employed because of depressed business conditions in the lumber industry, see, yet the company got away with it, as such conditions have been accepted by the employes of the company, with the exception of the machinists and boiler makers, who are still out.

April 17, a federation of navy yard trades was organized at Portsmouth, Va.; by-laws were adopted and local officers elected. A copy of the by-laws will be mailed to each International president of the affiliated trades for their approval and when approved every effort will be made to organize a national federation of navy yards and arsenals under the jurisdiction of their respective internationals and the American Federation of Labor.

Lodge No. 428 held a smoker and social good time on April 30, at the Red Men's Hall, Berkley, Va. An invitation was extended to the members of Lodges No. 57 and 298, which was accepted and quite a large number were present. Brother Callahan and his committee did everything possible to make the occasion one of pleasure for the members of the visiting lodges.

Brother Shultz of Lodge No. 57 made the principal address of the evening which was very much appreciated on account of his many years of experience as a member of the Brotherhood in this and other sections of the country, and when closing his remarks urged closer co-operation among the members as well as a careful study of the many problems that confront our craftsmen at this particular time, when co-opera-

tion, education and constitutional discipline should be the watchword of the movement, and urged all present to join in singing the opening Ode of the Brotherhood, which was complied with, all standing.

Several other brothers responded after which all left for their homes, satisfied with an evening of pleasure and wishing Lodge No. 428 every success in the future.

In my last report for Journal in connection with late banquet of Lodge No. 450, Washington, D. C., I failed, through an oversight on my part, to give proper credit to Brother J. W. Kimmerling as a member of the committee on speakers, who was untiring in his efforts in securing prominent speakers on that occasion; in fact the active work of all the committees and co-operation of the entire membership of Lodge No. 450 made a success of their 9th anniversary as a lodge of the Brotherhood of Boiler Makers, Iron Shipbuilders and Helpers of America.

Yours fraternally,

THOS. NOLAN, I. V. P.

REPORT OF INTERNATIONAL VICE-PRESIDENT MERRIGAN.

To the Officers and Members of the Brotherhood:

At the conclusion of my last report, I stated that I had visited Lodges 379, 378 and 398. Lodge 379, McAdam Junction, was holding its membership intact. Short time prevailed there as at all other points on the system. I found that this lodge had not been paying any district lodge per capita for some time, and instructed the members to see to it that they make a start the following month, as it was imperative that all lodges on the system pay per capita to District Lodge No. 30. I was requested by the members to have a number of due stamps redeemed by the I. S. T., as they were purchased in advance and had been left by former Secretary Brother Moore, who had recently started in another field of labor.

While in Moncton, I had a special meeting with the members of Lodge No. 378. This meeting was well attended by both boiler makers and helpers. Relations there were harmonious as in the past. Working hours had been shortened for a few weeks. Our members employed on the Intercolonial are not experiencing such trying times as their brothers on other railroads. The usual force of employes is maintained.

From Moncton, I went to Riviere-du-Loup to meet with the members of Lodge No. 398. Had a special meeting and informed the members of the changes to our constitution enacted at the last convention. There were a few matters which the lodge desired that I investigated in regard to members at other points east of there. Former president of the local lodge had been recently promoted to foreman of the back shop, Brother P. Laperriere.

I arrived in Quebec the following day and arranged for a meeting with the members of Lodge No. 601 for that evening. I had had a request from Lodge No. 601 to call there, as there was a dispute existing among the members in regard to some work that was being performed outside of the shop. After a thorough explanation in regard to such matters, the members were satisfied that they were unable to take any action in such matters. Brother Thompson, president of the local lodge, had been off work, owing to blood poisoning in one of his arms, and was out of town. Members employed by the C. N. R. were working about 45 hours per week.

I left Quebec late that night, arriving the following day in Montreal, and attended regular meeting of Lodge No. 134 that evening, which was fairly well attended. One of the many matters which come before the meeting was the shortage in the accounts of the late financial secretary, George McFetrich. After some discussion, I was requested to investigate the matter, as the lodge had received a communication from International President Franklin, advising that I would take the matter in hand. Committees were endeavoring to reach McFetrich, between meetings, but without avail. I ascertained the facts in connection with the shortage of the late financial secretary's accounts from the special committee and later made arrangements with a local attorney to take action against the late financial secretary, and left the matter in the hands of the attorney.

As I had received a message from International President Franklin, advising that the Executive Council would convene on October 12, I had to leave town the day following, arriving at headquarters for the 12th.

The Executive Council convened on the 12th and concluded their work on the 26th. Owing to the proceedings of the Executive Council being printed and published in pamphlet form for the benefit of our members, it is hardly necessary for me to go into detail at this time. However, pursuant to the last convention, your Executive Council was called upon to make such changes in compliance with the constitution which consumed some extra time apart from the regular routine of business. We believe the work performed in connection with the supplies of the Brotherhood has met with the approval of the membership. The usual number of grievances had to be dealt with, which come from different lodges throughout our organization and other sources. We feel confident that our decisions upon the various matters brought to our attention were in the best interest of the rank and file, notwithstanding criticism to the contrary.

Before leaving headquarters on the 27th, I had an understanding with International

President Franklin in connection with my work in this territory, explaining what I deemed advisable to be done in the interest of our organization. On the 27th I left headquarters, arriving at Montreal on the 29th. Owing to the falling off in the membership in Lodge No. 134, I deemed it advisable to remain in Montreal for some time. I endeavored to reach as many delinquents as possible through the mail, and by visiting them personally at their homes and others at their places of employment, which proved effective. At the same time I took up the matter of the shortage found in the books of the late financial secretary of Lodge No. 134 and tried to bring him to account for same through the local court. Every legitimate course was taken in this matter to locate McFetrich, but to no avail. Early in the month of December we were informed that McFetrich had left the country some time previous, but we were unable to ascertain his whereabouts.

Later I received a phone message from the president of Lodge 604 to come to Joliet, as the audit committee had found a shortage in the accounts of their financial secretary, who in the meantime had left town for a few weeks, but later he returned to the old folks at home for shelter. It was after his return to Joliet that I was requested to visit there, and endeavor to have him make good the shortage in his accounts. With the assistance of the local president I met him and talked the matter over with him with the result that he would replace the amount that he appropriated for his pleasure, within six months.

On December 7 I left Montreal, to attend an open meeting of the metal trades employed at Sherbrooke, where Brother Geo. Brunet, A. F. of L. organizer, was holding special meetings. Brothers Arcand and McLelland of the Carpenters and Machinists, respectively, were also present. The meetings were addressed in both the English and French languages, as there was a fairly large attendance. While in Sherbrooke, I was in a position to ascertain what business Lodge 370 was doing. After I had called a special meeting of the boiler makers and helpers, I learned that the few that are employed at our trade there were not sufficiently interested in the labor movement to continue to conduct meetings and safeguard their interests, at least for the time being, as they could not see their way clear to pay dues owing to the short hours they were working, and the few that were interested were not sufficient to constitute a quorum. However, these men will see the necessity of organization later when they are in need. After I was through at Sherbrooke, I returned to Montreal to take up some unfinished work.

On December 14th, I left for Riviere-du-Loup, to investigate a grievance which was brought to my attention by one of the members of Lodge 398, employed at Chaudiere Junction. The aggrieved brother, an-

other member and myself arrived at Riviere-du-Loup on the night of the 17th and after a special meeting of organized labor was held, we held a special meeting of Lodge 398, to investigate the grievance. At a meeting of Lodge 398, a few months previous, the members in attendance saw fit to notify the aggrieved brother that he had been suspended and that he could consider himself no longer a member of the Brotherhood. No reason had been advanced other than the members had learned through another employe that the aggrieved brother had commented unfavorably of some work that had been performed at Riviere-du-Loup, when it arrived at one of the divisional points. At the meeting it was found that there had been some talk at one of the regular meetings of Lodge 398, regarding what one of the members had heard from a traveling employe, and on the strength of this information, the secretary had been instructed to notify the aggrieved brother that he had been suspended as a result of this information. Further investigation showed that the brother had not been suspended, and that the letter which was forwarded was meant to be a warning. Communications from Lodge 398, are written in the French language, and the aggrieved brother being English, some confusion existed owing to the phraseology of the communication. However, the grievance was amicably settled, and the members present regretted that the matter had caused any annoyance. I returned the day following and stopped at Chaudiere Junction, and had a talk with three helpers who were eligible for membership in our organization and had them fill in applications and forward same to the secretary of Lodge 398, afterwards returning to Montreal, remaining there until January 6th, during which time with other work I endeavored to interest some shipbuilders who were employed at the Canadian Vickers Company, in our organization. Most of them were members of the society of Boiler Makers and Shipbuilders of Great Britain. I arranged for a special meeting, and later I was informed that they were unable to attend as there was to be a banquet under the auspices of the Canadian Vickers football team, and that all of them had previously bought tickets and regretted that they did not have the date in mind while talking over the matter of holding a meeting, but would be glad to take up the subject at a later date.

As I had a request from Lodge 417, to visit North Bay, at my earliest convenience, I left Montreal January 7th, arriving at North Bay that evening, so as to be in attendance at their regular meeting on the 8th. I met several of the officers and members the day following and was informed that they had changed the dates of their meetings, and that the next regular meeting would be held on the 11th, and was requested to call on several delinquent members in the meantime. On the 11th, I

addressed the regular meeting of Lodge 417, which was very well attended by the boiler makers and helpers employed at North Bay, from the T. & N. O. and the C. P. R. shops. The meeting was not altogether a closed one. Every member delinquent and non-members were invited to attend. At the adjournment the officers and members were pleased at the attendance, satisfied that my visit to North Bay would make those employed at the trade more enthusiastic in the labor movement.

I left North Bay, after the adjournment of the meeting to go to St. Thomas, as I had received a communication while at North Bay from International President Franklin advising that I go there and ascertain the grievance of Lodge 413. I arrived at St. Thomas on the 12th, and attended the regular meeting of Lodge 413 that night. After hearing the nature of the grievance I had a special committee appointed to meet the following evening so as to get to the cause of the grievance. At the meeting it was learned that the members of Lodge 413 employed by the Pere Marquette Railway at St. Thomas on date of December 3rd, saw fit to present to the superintendent of motive power, a revised schedule of working conditions and also requesting an increase in wages all around of one cent per hour. A reply was received from the company to the effect that the company did not consider such would be to the best interests of the company, to enter into any signed agreements with the various shop crafts at the present time, and that they did not consider it necessary to have any signed document in order to treat their employes just and fair, which they proposed to do. And also wished to notify them that their present schedule in effect at that time, would become null and void on and after January 1, 1915. Lodge 413 had previously decided to place the matter before the Department of Labor at Ottawa, and the secretary had written to the department for a few blank forms so as to enable them to make application for a Board of Conciliation if necessary. A reply was received from the Minister of Labor requesting information as to the cause of their grievance, and at the same time advancing the idea that he did not think that WE would be able to continue wages during these trying times as in times of prosperity, and inclosed several blank forms. After we had discussed the grievance for some time it was decided that I should go to Ottawa, and take the matter before the Minister of Labor. A communication which I desired in connection with this grievance was at headquarters, and I requested that same be forwarded to me to Ottawa, so that I would have it when I arrived there. I left St. Thomas, the following afternoon, arriving at Ottawa the following morning. I had an interview with the Minister of Labor, regarding the grievance, and could not receive any definite assurance that he would personally use his influence in having the agreement restored

to the employes of the Pere Marquette Railway at St. Thomas. Although I had a long talk with the minister, regarding the grievance. While in Ottawa, a rumor was afloat that submarines were to be built at Montreal, at the Canadian Vickers Company plant for Great Britain, and as I had to call at the Labor Department in the course of a few days, I went to Montreal on the 16th, remaining there until the 21st, during which time I got in touch with some of the officers and members of Lodge 134, so as to ascertain whether the rumor was authentic or not. The rumor proved to be true, and a large number of our members who were unemployed were seeking employment. The number of under-water boats to be built could not be learned definitely. However, it was generally understood that the job would not be completed much before the month of June. The contract for the under-water boats was given to the Fore River Shipbuilding Company, or in other words to the Schwab interests. A large number of men experts in the building of such boats were dispatched from Quincy, Mass., and others from San Francisco, Calif., to complete certain operations.

While I was in Montreal I received a communication from headquarters advising that the letter I desired in connection with the grievance at St. Thomas, could not be located at the time of writing, but if found later, same would be forwarded to me.

On the 22nd I left for Ottawa, to take up some other matters with the Department of Labor, and also called on our members employed at the C. P. R. roundhouse. At the later place I met with one of our members who informed me that he had a grievance and desired to know to whom the matter could be referred to. I heard the grievance of this member and forwarded the same to the secretary of Lodge No. 134, instructing that the lodge take immediate action, which I learned later had been complied with and that the matter had been taken before the lodge and later before the meeting of the System Federation.

On the 23rd I left for Trenton, arriving there that evening, and remained there until the 25th. I met with the members employed at the C. N. R., who are members of Lodge No. 548, and discussed the advisability of instituting a lodge at Trenton, so as to bring the members employed on the eastern division closer. All were in favor of the measure and had been seriously considering during the time I was off the road, and since the reduction of force and the short time being worked, they had decided to hold the idea over until a more opportune time. I also called at the new roundhouse of the C. P. R., where there are two men employed. Both of them were delinquent, but had not lost interest in our organization entirely, and assured me that they would be reinstated as early as possible.

On the 26th I left for St. Thomas, arriving

there same day, and attended the regular meeting of Lodge No. 413. Reported regarding my interview with the Minister of Labor, and the assurance which I had received from him. The following evening I met with the special committee and drafted a letter, and forwarded same to the superintendent M. P., of the Pere Marquette Ry. Later I received a communication from the chairman of the committee, advising that a reply had been received from the superintendent M. P., and the members of Lodge No. 413 had decided to hold the matter in abeyance until times were more prosperous.

After meeting with the committee, we proceeded to the local meeting of the Trades and Labor Council, and I had the honor of installing the newly elected officers for the ensuing term. The Trades and Labor Council of St. Thomas, hold interesting meetings, as I had witnessed the business transacted on other occasions while in St. Thomas. The delegates from Lodge No. 413 attend regularly and hold office in the local council.

On the 28th I left for Edmonton, Alberta, stopping off at Winnipeg for a few hours for train connections, and met with the president of Lodge No. 451, to ascertain what action had been taken in regards to the request of our members who made application for a charter at Edmonton, some of whom were members of Lodge No. 451, and also desired to be granted a certain jurisdiction. I was informed that Lodge No. 451 had conceded the request of our members at Edmonton, and that the information had been forwarded to the secretary pro tem. I left Winnipeg that evening, arriving at Edmonton the following night. On February 1st, I met with some of the members who had made application for the charter, and learned that there would be a meeting that night, as they had expected I would arrive on that date. I attended the meeting that night, installed the officers and instructed all present what would be expected of each and every member were they to expect the results that could be obtained through organization, and the aims of our brotherhood. After many matters had been discussed in regard to the welfare of the union, the meeting adjourned with the assurance that each member would do his part towards the building of their local lodge and the brotherhood in general.

From the 2nd to the 4th I was in Edmonton. As I had made an appointment with the newly elected secretary, to familiarize him with the office he had accepted, and the work in connection with said office. I also called on some of our members employed at the G. T. P. at West Edmonton, and before leaving I had meetings with other members employed by the Edmonton, Dunvegan and British Columbia Ry., who had made application for a board of conciliation to the Department of Labor at Ottawa.

On the 5th I left for Winnipeg to attend the annual meeting of District Lodge No. 30,

arriving there on the morning of the 7th. The meeting convened Monday afternoon, the 8th, and adjourned Saturday the 13th. Meeting was called to order by Brother Geo. Chadburn, president District Lodge No. 30. Credentials were received from the following lodges: Nos. 126, 134, 417 and 392. The following delegates represented the lodges respectively: C. Davis, J. W. Johnstone, M. J. Frawley, J. Chapman and J. J. Chambers. Reports of officers were heard and commented upon. The report of the president in part referred to his trip to Montreal, to take over the books and supplies of District Lodge No. 30, from the late secretary-treasurer, Geo. McFetrich. It was found that McFetrich had appropriated the funds of the district lodge to the amount of \$300.00 for his pleasure, and in some instances forged the name of the president, so as to enable him to draw the money from the bank. McFetrich was not bonded, and the district lodge was the losers. The report of the delegates regarding organization was favorable. All reported slackness of trade and that there were a number of unemployed members as a consequence. The finances of the district lodge were ascertained. Brother Chadburn also submitted his report as secretary-treasurer pro tem, from the time he had taken over the books from McFetrich to date. The by-laws of the district were revised so as to be made more explicit for the members, and to render more financial assistance to the lodges affiliated than in the past. Communication from the secretary of the System Federation was read, seeking the opinion of District Lodge No. 30, as to the advisability of holding a convention of the System Federation. Brother Chadburn, who represented district 30 on western lines, and the sole representative of the boiler makers and helpers, stated that he had replied to the communication to the effect that owing to the prevailing industrial conditions throughout the country he had arrived at the opinion that it would be useless expenditure of money and that little could be accomplished. As there was no convention of the System Federation held it is evident that the other crafts affiliated had also arrived at the opinion that little could be accomplished. The decision of Brother Chadburn was approved by the delegates in attendance.

The election to the offices of president and vice-president had to be submitted to the lodges affiliated with District Lodge No. 30, as none of the delegates in attendance desired to accept either office. Brother Geo. Chadburn was nominated and elected to the office of secretary-treasurer.

The meeting decided that the next convention would be held in the city of Winnipeg.

After the adjournment of the district convention, I returned to Edmonton, arriving Monday morning, the 15th. As a Board of Conciliation had been applied for and granted, to investigate the dispute between the E. D. & B. O. Railway and the em-

ployes, I was requested to assist our members employed on that road, at the meetings held by the board. After the board had been appointed the first meeting was to be held January 25th. Later, owing to all members of the board being unable to be present on the latter date, February 15, was decided upon. Again the first meeting was postponed subject to call, and it became necessary for me to keep in touch with our attorney and board representative and committees. We had been disappointed several times as to the date the board would hold its first meeting. We held several committee meetings preparatory to the board holding its first meeting, so as to be in readiness. Finally we had our initial meeting and several other meetings were held up to and including the meeting held March 13th, when the Board of Conciliation was transformed into one of arbitration, after having failed to reach a satisfactory settlement. During the course of the Board of Conciliation, the members of the board recommended the general manager and myself meet with a view of arriving at a satisfactory settlement. We met on two different occasions, but were unable to agree, and reported back to the board. On March 13th, the board had reached what was thought to be a basis for an agreement. The general manager of the McArthur Construction Company was asked if the company would consent to the changes dating back to November 1st, and he refused. The board then asked if it altered its work from that of conciliation to arbitration, would both parties agree. A reply was received in the affirmative, and the members of the board decided on March 18th, for the date of the first hearing and several meetings were held concluding on March 22d. To date the board has not submitted its award, although I expect a copy of same when made and will submit same to our editor for publication in the columns of the Journal. The cause of this dispute arose on November 2d, last, when the company posted notice that the rates of pay would be reduced, effective November 1st. On the notice boiler makers were to be reduced from forty-seven and one-half cents per hour to thirty-five cents per hour, and helpers from thirty cents per hour to twenty-two and one-half cents per hour. And all others in proportion. Upon protests from the organized members of the various crafts employed, a board of conciliation was appointed. W. MacAdams, representing the men; O. M. Biggar, the company, and Mr. Justice Hyndman, as chairman. The running trades were also in dispute, and had applied for a separate board. The employes on the construction of the Hudson Bay Railway were also in dispute with the McArthur Construction Company owing to a reduction in wages. As the latter was a government contract the matter was immediately taken up with the government with a view of having it enforce the fair wage clause which is inserted in such con-

tracts. The Dominion Fair Wage officer was instructed to make an investigation and from all accounts the report of the Fair Wage officer was in favor of the claims of the employes, and recently information was received that the old rates would be restored. The rates that prevailed prior to November 1st and after the reduction, will be found in the columns of our Journal, April issue.

On March 23rd, I had some matters to attend to with the representative of the men and other matters in connection with this office.

On the 24th I left for Hardisty to investigate a grievance of one of our members employed by the C. P. R. as washout man. On the 25th, I located the member and heard his grievance. He informed me that he had been discharged because of being intoxicated while at work. I took the matter up with the locomotive foreman and learned why it had become necessary for him to discharge this member. The foreman claimed that it had not been the first offense of this nature, and that after satisfying himself personally, that the member was not giving his work the required attention; he informed him that he could consider himself discharged from the service of the company. This member took his discharge papers to the effect that he was intoxicated while on duty, and it seemed difficult for the writer to have him reinstated. However, I urged the foreman to reinstate him to his former position, but the matter was out of his hands, and he could do nothing more, and referred me to the master mechanic at Saskatoon.

On the 26th I left for Moose Jaw, arriving there the same day, and later met with several of the members of Lodge 478. I had expected to meet others, but somehow the letter which I had mailed to the secretary did not reach him in time to inform the members that I would be in town. Members there complained of the slackness of trade, and unemployment. After having a talk with several of the members, I left on the night train for Saskatoon, arriving there the following morning, and later took up the grievance of our brother member at Hardisty, with the master mechanic. The information I received in connection with this grievance was to the effect that the company did not intend to have employes intoxicated while on duty, and that the evidence in the case in dispute was ample for the dismissal of any employe of the company and that since the employe openly violated the rules of the company and had been warned on previous occasions of his actions, the company could not consider his reinstatement.

I left Saskatoon at noon, after calling on several of our members employed by the C. N. R., arriving at Winnipeg the following morning and attended to some correspondence during the day. On the 29th, Monday, I met with Brother Chadburn, sec-

retary-treasurer of District 30, and requested that he take the grievance of the brother at Hardisty before the local officials of the company at his earliest convenience. I supplied him with the necessary information in the matter, so that he could present the grievance. I left that night for Fort William, arriving there the following morning and arranged to meet with the members of Lodge 505 that night. The force at Fort William which had been employed by the C. P. R., had been reduced considerably in all departments and with every boiler maker and helper employed there being a member of the local lodge, the membership would be little more than a quorum. There are three members of Lodge 451 employed at Port Arthur (in the vicinity of Fort William), by the C. N. R., and Lodge 451 has been requested to transfer these members to Lodge 505, so as to enable said members to attend the meetings of the local lodge, and at the same time strengthen the membership of Lodge 505. However, the members of Lodge 451 do not deem it to be in the best interests of these members to be transferred in case some grievance should arise.

On the 31st I left for Hamilton, stopping off at North Bay for a few hours to make train connections during which time I was in a position to meet with several of the officers and members of Lodge 417.

The above will conclude my report to April 1st. Trusting same will meet with your approval and with kindest regards to all, I am,

Yours fraternally,
J. P. MERRIGAN,
Third I. V. P.

REPORT OF FOURTH INTERNATIONAL VICE-PRESIDENT WEYAND.

Dear Sir and Brother:

The following is my report of the organizing campaign carried on in the city of Cleveland, in the interest of Lodge No. 5.

In taking up this work in the months of December, 1914, January, February, March and April, 1915, and before going into details, I may say I believe every one of our members must be aware that the great industrial depression which confronted the workers of the entire country made it almost impossible to make very much progress in the line of organizing work. I found in most cases many of the unorganized were very much backward in declaring themselves, owing to the lack of money on the part of the workers to pay the necessary reinstatement fee. However, we were fortunate enough in this campaign to make some gains in the membership of Lodge No. 5.

My first efforts in line with this work were to make an investigation as to the existing conditions of Lodge No. 5, and found the membership down to about 88 members.

The revenue derived from the small membership was insufficient to meet the salary of the business agent, Mr. George H. Brady, and other lodge expenses. In order to meet this expense I decided to arrange for a drawing so as to meet the additional expenses. With the assistance of Brother George H. Brady, I arranged to send a special communication to all delinquent members of Lodge No. 5 inviting them to a special meeting which we had arranged, and informed all at the same time that a special dispensation would be granted for their reinstatement. Our special meeting was well attended and we had some reinstatements. Vice-President Brother Maher and Vice-President Horn of the blacksmiths were some of the speakers at the special meeting, as they were in Cleveland in connection with the Federated Trades of the Wheeling & Lake Erie Railroad.

Brother Brady and myself also visited all shops and requested all delinquent members to take part in the organizing campaign and become reinstated.

During Vice-President Maher's stay in Cleveland he informed me that he was ordered to Conneout, Ohio, as a gentleman by the name of Plerse was making all efforts to disrupt the organization of the Nickel-Plate Railroad. At the request of Vice-President Maher I made several trips to Conneout, O., and assisted Vice-President Maher and other representatives of labor to keep the legitimate movement intact.

On January 6th I received orders from President Franklin to go to Alliance, O., and endeavor to get an interview with Mr. George Reeves, president of the Reeves Tank Building Industry, relative to a general conference between all the operators in the Oklahoma oil field and our President, Mr. J. Franklin; also local representatives of Lodge No. 592. Mr. Reeves promised me he would bring our request for a general conference before their association and if they granted the request he would arrange with Mr. Franklin personally.

On my return to Cleveland I received orders from President Franklin to come to headquarters and take charge of the office during his absence, as he was compelled to go east on official business. Being detained at headquarters until January 18th, when I returned to Cleveland, I again took up my work.

As our drawing was scheduled to take place on January 21, I arrived in Cleveland to take charge of same. I may say the drawing was very successful from a financial standpoint, and helped to adjust some matters and dispose of some of the back-standing bills. However, it was a foregone conclusion that we had to have greater revenue to meet the general expenses, and also to keep the business agent in the field. Brother Brady and myself went to Lorraine, O., and got several reinstatements and new applications of the B. & O. R. R. Brother Brady and myself also visited many shops and

jobs in the building line and adjusted such grievances that came up from day to day.

By instructions from the members of Lodge No. 5 I assisted a committee to draw up a more specific outside agreement along the lines of the old scale and presented same to all employers with the understanding that same would be enforced on all outside work in the future. Brother Brady and myself visited all employers and talked matters over relative to the agreement, and we found most all the employers opposed to raising their price per hour except on such work which called for strictly union labor. The results are we expect considerable trouble in this line of work in Cleveland.

I also found the local metal trades department in the city of Cleveland in a very weak condition and very few of the organizations taking any interest in the department. This matter was brought to the attention of the business representative, Mr. Thomas Farrall of the Cleveland Federation. Brother Farrall immediately arranged for a conference with the various metal trades representatives, and after several meetings we were able to put new life into the local department. The results were they are now carrying on the campaign against two firms known as the Bishop & Babcock Co., and the Lowe Manufacturing Co. Those two firms do a large amount of brewery work, but were very unfair to organized labor in various departments. If those two firms can be convinced to organize their plants it would mean at least 15 additional members for Lodge No. 5.

I arranged for another open meeting with the endeavor to interest the unorganized, and in order to advertise this meeting, I arranged for over 2,000 hand bills and had them distributed in all boiler shops of the entire city; also had many good speakers from the local building trades department. This meeting was well attended and we received some applications but not the number I expected. Brother Brady and myself also visited the boiler makers and helpers at Lindale roundhouse of the Big Four Railroad, and were successful in getting those men to become reinstated.

On March 27th I received orders from President Franklin to go to Massillon, O., to address a mass meeting on Sunday, March 28. On my arrival in Massillon I met the representatives of the moulders and machinists; also local men of the Central Labor Union and our local members of Lodge No. 600. We had two well attended meetings, one in the afternoon, another in the evening at the city hall at Massillon. Those meetings were arranged by the officers of the Central Labor Union and the officers of the Federated Trades of the Wheeling & Lake Erie R. R. for the purpose of putting new life into the union men of Massillon and have them take more of an interest in organizing the workers who are outside of the fold.

On my return to Cleveland I received

orders from President Franklin to come to headquarters and take charge of the office as President Franklin and Vice-President Hinzman were to attend a hearing before the Industrial Relations Committee in the city of Chicago relative to the Illinois Central and Harriman lines strike. During the absence of President Franklin I was detained at headquarters until April 16, when I returned to Cleveland.

On April 19 I went to Elmira, N. Y., to meet with our members of Lodge No. 225. On my arrival in Elmira I found our members who were employed by the American-LaFrance Fire Apparatus Company had made a request for an increase in wages. I also found the machinists had made a like request. After going over the matter with our members I arranged to meet the management with our committee on Thursday, April 22. After a two hours' conference we were not successful in convincing the management that the men were entitled to an increase. I then offered a compromise in order to settle the matter, but the officials refused to accept the same. As the representatives of the machinists with their committee were to meet the management the following day, we decided to wait until after this meeting and if they were not successful we would appeal to the president of the company and make it a joint proposition. As the machinists were no more successful than the boiler makers, we appealed to President Clarke as a joint committee. Mr. Clarke agreed to meet a committee of his employes, but he absolutely refused to meet the representatives of the organization, stating that if we wished to, we could meet their representative of the Manufacturers Association, located in the city of Chicago. During the conference with Mr. Clarke the committee was not successful in getting concessions and naturally reported back to us. As we did not wish to stand in the way of a conference and a possible settlement, we advised the joint committee to again meet Mr. Clarke and make an effort to bring about a settlement if possible, but Mr. Clarke refused to grant anything whatsoever and requested the men to see their foreman as individuals and if he recommends an increase he would allow the increase, but only as an individual. As President Johnson was coming to Elmira we decided to have a joint meeting that evening and have the joint committee make a report in President Johnson's presence. The report was very unfavorable to the men and the prospects of both crafts will possibly have to suspend work in order to force the company to pay the standard rate of pay.

This concludes my report up to May 1, 1915, and trusting the same is satisfactory, and with best wishes and very kind regards, I am

Yours fraternally,
 LOUIS WEYAND,
 Fourth International Vice-President.

REPORT OF EIGHTH INTERNATIONAL VICE-PRESIDENT RYAN.

Port Arthur, Texas, May 14, 1915.

Since the conclusion of my last report, my time has been spent in connection with the strike in the oil fields of Oklahoma and Texas. On April 16 I was called to Kansas City by President Franklin, in connection with the strike situation, and was instructed to go to Port Arthur, Tex., as a new phase of the situation had presented itself, in the fact that the Gulf Refining Company had taken over some of the work which the Reeves Brothers were erecting and which we have been on strike against since January 18, 1915. Upon instructions from President Franklin, I returned to Cushing, made some arrangements in regard to strike rolls, etc., and left for Port Arthur on the 20th, stopping at Fort Worth and Shreveport enroute in connection with some business I had with Lodges No. 96 and No. 328.

Arriving at Port Arthur, I learned that the Gulf refinery which had at first refused to hire any of the strikers on the Reeves job, had changed its attitude and had placed several to work. A committee arranged for a conference and we met Mr. Tryon, the local manager, and he requested, after talking the matter over, that we await the arrival of some Pittsburgh, Pa., officials of the company. We agreed, and while waiting the arrival, May 1 I made a short visit to Beaumont and Galveston, Tex.

Monday, May 3, a committee of Lodge No. 305, Business Agent T. O. Riley and myself prepared to meet with the Gulf officials again, they having arrived. Mr. Taber of Pittsburgh, Pa., requested that Brother Riley and myself meet with him and Mr. Tryon. Not wishing to be arbitrary in the matter, we agreed and so advised the committee, same being satisfactory to them. We went into the subject of the Reeves Brothers work being taken over by the Gulf Refining Company and endeavored to get Mr. Taber and Mr. Tryon to agree to make that particular job a closed shop, or a strictly union job. We discussed the matter thoroughly with them, but were unable to get them to agree. They maintained that they could not make any distinction between the union men at the refinery and the men who were not members of the organization. They offered to increase the force on this job to the extent of placing fifteen of the remaining strikers on the strike roll to work. Four men they objected to, but would not give their reasons. We adjourned the conference to take the proposition offered us up with the members at a special meeting, which was held on May 4. The committee reported and the proposition was discussed and finally rejected and the committee instructed to continue.

We again met Mr. Tryon on May 10 and went over the proposition with him, this time we enlarged the committee to four members. We advised him that the men had rejected his offer of May 3. We endeavored to get him to adjust the matter

by placing the non-members on the paraffine plant job and using all union men on the Reeves work, which the Gulf Company was erecting. To this he would not agree. We finally made an effort to get the Gulf Refinery to take over all of the Reeves job, dismiss the deputy sheriffs on guard, get rid of the Reeves scabs and foremen and complete the work with their own employes and place the rest of our strikers to work. He agreed to increase the number from fifteen to eighteen, leaving one man whom he objected to. Stated, as final, that they would not make the job a closed shop affair, but that he would take up the question of taking over all of the Reeves work as a means of eliminating the unpleasant conditions existing in the plant and that he would give us a definite reply in a few days' time, after consulting Pittsburgh, Pa., offices.

In the interval between conferences, and in order to be prepared in case of serious trouble on the job, I arranged with Lodge No. 305 to get a grievance blank filled out and mailed to the International President for the approval of the Executive Council, to strike if necessary, secured the official strike ballots and took a strike vote. None but employes at the Gulf Refining Company's plant were allowed to vote. The result of this vote stood 36 to 15, giving us the necessary two-thirds majority. The committee was instructed to continue negotiations and the men remained at work pending the final outcome of the matter. May 11 Mr. Tryon communicated with Business Agent T. O. Riley and wanted to know if the men were going to strike, or if he was to be given time to take up the question of taking over all of the Reeves work, as we agreed in conference. Brother Riley assured Mr. Tryon that there would be no trouble, pending his final reply.

I went to Beaumont to attend a regular meeting of Lodge No. 587 on the 11th, by request. Brother Riley joined me there on the 12th, as we had some matters to look after pertaining to the organization. Upon our return to Port Arthur we were advised that at noon on the 12th the men on the Reeves work being done by Gulf Refinery employes were laid off and told that the Reeves would complete the job. On the 13th we called Mr. Tryon up on the telephone and asked what was the object of this action. He informed Brother Riley that he and Mr. Taber had concluded that inasmuch as the men had rejected their former offer, they had decided to lay off the men and let Reeves Brothers finish the job. This action while not what we were endeavoring to obtain, has partly complied with our request, which was to the effect that the Gulf Company either make a union job of the Reeves work taken over by them, or else lay the men off and let Reeves complete same with their scabs.

The wages which prevail in the field, \$4.50, \$4.75 and \$5.00, are being paid on the work in question; but work conditions and

other working conditions being satisfactory, with the exception that the company wants to work the job under the open shop plan. Our members in Lodge No. 305 feel that after being on strike against the Reeves Brothers Company on this work for nearly four months that they cannot continue on same unless the job is made a strictly union job and will strike to force the Gulf Refinery to make the job a closed shop job, or else let the Reeves Brothers' scales finish the job under scab conditions.

While we enjoy certain working conditions in the shop proper, the Gulf Refinery will sign no agreement with us. This situation also prevails with the kindred trades, machinists, blacksmiths, railway carmen, coopers and bricklayers. This about covers the controversy to date.

The Magnolia Refinery at Beaumont, Tex., is erecting considerable tank work with the shop force. Shop wages prevail on this job. The P. I. W. is erecting scab jobs here at the Texas Company Refinery and at Port Neches, Texas, under guard of deputy sheriffs. Brothers, I would urge upon you to remain away from Port Arthur, Tex. Lodge No. 305 still has a number of strikers on the strike roll here, and there is no work to be had at the trade.

I desire to thank the many officers and members who have so ably assisted me in my work in this section, and I take pleasure in reporting that my efforts in the sale of emblem buttons and watch charms have increased materially since my last report on same. In connection with my report, I am submitting a list of brothers who are now wearing the official emblem of our organization, and I ask you respectfully to help the good work along. "BUY AND WEAR A BUTTON OR A CHARM."

Fraternally yours,

JOS. P. RYAN, 8th I. V. P.

Statement of Emblem Buttons and Watch Charms Sold by Joseph P. Ryan, Eighth International Vice-President.

N. W. Deplenty, \$1.00; Bruce Blair, \$1.00; Charles Olson, \$1.00; Tom Lennon, \$1.75; Oran Roix, \$1.00; Frank Kanfield, \$1.00; Lou Hanna, \$1.00; Jack Frost, \$1.00; A. Purks, \$1.00; John Ravells, \$2.75; J. E. Ickles, \$1.00; James Brennan, \$1.75; George Hereford, \$1.00; Chas. H. Mashman, \$1.00; W. Adams, \$1.75; B. G. Richard, \$1.00; D. Laughlin, \$1.00; E. Ballinger, \$1.00; P. H. Ickles, \$1.00; Howard Lieb, \$1.00; W. W. Manns, \$1.00; W. Morris, \$1.00; C. H. Cook, \$1.00; B. R. Highsaw, \$1.00; S. R. Womstead, \$1.00; O. K. Alexander, \$1.00; M. J. Ickles, \$1.00; Jas. Rose, \$1.00; T. O. Riley, \$1.00; Max Boyer, \$1.00; J. P. Draper, \$1.00; Elmer Patterson, \$1.00; M. Balney, \$1.00. Total, \$37.00. Grand total, \$69.75.

Respectfully submitted,

JOS. P. RYAN,
Eighth I. V. P.

Correspondence.

FROM THE RAILWAY DEPARTMENT.

St. Louis, Mo.

(Continued from last month.)

follow. It is the duty of the members to become acquainted with the action of their respective delegates, and when it is found that they have failed to reflect the sentiment of a majority of the membership, elect delegates who will. In many instances we have witnessed the return of the same delegates year after year, and we believe this to be good policy as long as they fairly represent the members, and in the absence of any proof to the contrary, we must assume that they do, and have fairly represented the sentiment of the members, because of this we believe it to be a waste of time, as well as foolish to either berate or condemn the officers of the American Federation of Labor. Place the responsibility where it properly belongs, it is the duty of the membership to elect as delegates, members who will represent their views and if the American Trade Union Movement is not making the progress you believe it should, it's up to the rank and file to make themselves and their desires fully known. The American Federation of Labor will be just as progressive as is indicated by the expressed wishes of the more than two million members, through the voice and vote of the delegates they elect. If you don't approve of what has been done, or the manner in which it is being done, and you think you have something better, first send and get a copy of the proceedings of the A. F. of L. convention, then after becoming familiar with its contents you will be in a position to know how to proceed, and to what and to whom you are opposed.

We have every faith in the American Trade Union Movement; we believe in it and have confidence in its selected executive officers. We don't agree with everything it does, but we are going to abide by its decisions, because we know that that is the only sensible thing to do.

The men in the railway industry are today facing two concrete examples of how two individuals have decided to promote two different organizations, both presumably in the interest of the railway employees.

P. F. Richardson was president of the new defunct International Association of Car Workers, this organization was affiliated to the American Federation of Labor and at that time had approximately nine thousand members. The Brotherhood of Railway Carmen, with a membership of approximately thirty-five thousand members, sought affiliation to the A. F. of L. and the amalgamation of the two organizations. The following statements are self-explanatory and are also a matter of record:

"The American Federation of Labor, at the convention held in Denver, 1908,

brought the representatives of the two organizations of carmen together; this resulted in a plan of amalgamation being submitted to the membership of the two organizations for ratification. The Brotherhood of Railway Carmen voted for amalgamation by a vote of almost five to one. President Richardson advised that his organization had defeated the proposition.

Another attempt at amalgamation was made by the A. F. of L. in July, 1909. These conferences accomplished nothing, while the representatives of the I. A. of Car Workers pleaded a lack of authority, they (Grand Secretary-Treasurer Gibson and Vice-President Condon) finally agreed to put the matter up to the members and secure the necessary authority, when this proposition was submitted to Richardson, he repudiated the action of Gibson and Condon and declined to submit the proposition to the members of the car workers.

The question was again brought up at the Toronto convention of the A. F. of L. in November, 1909, which convention the officers of the B. of R. C. A. had been authorized to petition the A. F. of L. for a charter. The A. F. of L. convention indorsed the recommendation of the executive council as indorsed and submitted by the Adjustment committee, which was, that President Gompers and a member of the executive council at an early date invite to Washington the representatives of the two organizations for a conference. If this conference failed of amalgamation the executive council was directed to fix the terms of amalgamation. Richardson, as a delegate to the Toronto convention opposed the proposition, but the convention adopted it by an overwhelming vote, 221 delegates representing 12,189 to 42 delegates representing 1,377 votes. This meeting was held in Washington in February, 1910. Richardson, among others representing the I. A. of Car Workers; at the suggestion of President Gompers, the representatives of the two organizations went into and held a number of conferences, Secretary Morrison of the A. F. of L. being present. Because of the action of Richardson, no tangible results obtained from these conferences. President Martin F. Ryan of the Brotherhood of Railway Carmen at this time made the following statement, and while still in conference: "The Brotherhood of Railway Carmen are now willing to submit the entire matter to the President and Secretary of the A. F. of L. agreeing in advance to bind the Brotherhood to accept amalgamation on such terms as they would outline, agreeing to abide by these terms even if it meant the displacement of every present officer of the Grand Lodge of the Brotherhood of Railway Carmen of America." These conferences and negotiations resulted in a disagreement, due to objec-

tions raised by Richardson and after every possible inducement had been offered to bring about amalgamation, the result being that on August 9, 1910, President Gompers of the A. F. of L. issued a charter of affiliation to the Brotherhood of Railway Carmen of America. At the November, 1910, A. F. of L. convention, St. Louis, Mo., Richardson protested the seating of the delegates from the B. of R. C. but later, knowing he would not be sustained, withdrew the protest and the delegates of the Carmen participated in this convention.

At the November A. F. of L. convention, Atlanta, Ga., protest was again made against the seating of the delegates from the B. R. C. A. Delegate Richardson raised a point of order, claiming that charter had been granted the B. R. C. A. in violation of the laws of the A. F. of L. President Gompers ruled the point of order not well taken and cited the action of the Toronto convention, the failure of the conferences to bring about the amalgamation and then said: "The failure to amalgamate the two organizations rested upon the representatives of the organization to which delegate Richardson belongs."

On vote to concur in credential committee recommendation, which was to seat the delegates of the B. of R. C. A. only three negative votes were cast.

Richardson and his co-delegate, Humphries, then introduced resolution No. 122, protesting against the issuance of charter by the A. F. of L. The report of the Resolution Committee was to non-concur, but due to Richardson's statement that amalgamation had failed because the B. R. C. owed its members a large sum of money account of back strike benefits due, recommended a continuance of the efforts on the part of the A. F. of L. officers, to bring about amalgamation. Delegate M. F. Ryan informed the convention that the B. R. C. of A. had liquidated every dollar of its indebtedness.

President Gompers: "Now that the Brotherhood's indebtedness has been liquidated, will there be any difficulty in amalgamating, in the opinion of Delegate Richardson?"

Richardson said: "They wanted their rights and the charter of the Carmen revoked and they would talk on the question."

The vote on the committee's report showed but two votes in the negative.

Richardson then arose to a question of personal privilege, saying: "I want to surrender the charter of the International Association of Car Workers to the American Federation of Labor."

President Gompers: "Will the delegate step to the platform?"

Delegate Richardson: "Here is the charter, Mr. Chairman."

President Gompers: "The chair would like to inquire by what authority Delegate Richardson surrenders this charter?"

Delegate Richardson: "As President of the I. A. of Car Workers."

President Gompers: "The president of the American Federation of Labor places this in the hands of the secretary with the request that he inform the secretary of the International Association of Car Workers that the charter is held by him for transmission to the organization, and that President Richardson, without authority of that organization, surrendered the charter, usurping a position which no presiding officer has a right to assume in the name of a membership who have not spoken on the question."

And thus ended the connection of the I. A. Car Workers with the organized labor movement, and are there any among you who, when reading this all too brief recital of the facts portraying the arrogance and assumed authority, together with such an absolute disregard for the rights of the rank and file as exemplified in the person of Richardson, can say that such a man is either a trustworthy or a capable leader of a movement organized to promote and advance the rights of this entirely humane institution, known as the organized labor movement?

On, or about January 1, 1914, the Railway Employees Department decided to send out a general circular letter for the purpose of furnishing the membership accurate information in relation to P. F. Richardson, and his work. In accord with his previous disregard for the rights of the rank and file, Richardson arranged for a meeting of his most trustworthy lieutenants, while drawing his usual salary and expenses from the I. A. of Car Workers, but without the knowledge or consent of the then few remaining members of the organization he was supposed to be representing, and proceeded to draw up and adopt a constitution for a proposed organization to be known as the American Federation of Railroad Workers. Having called the meeting, he naturally dominated the proceedings and just as naturally selected P. F. Richardson to be president, taking care of his associates by arranging for them to fill the other offices. The first knowledge the rank and file of the I. A. of Car Workers had of this characteristic Richardson manner of procedure, was when we sent out the information contained in the circular herein referred to. After a careful review of this man's record in the labor movement, both orally and verbally, we find from the viewpoint of accomplishment, that his principal achievement and asset has been to assimilate a vocabulary peculiarly adapted to a standard code of ethics designed by him and for the express purpose of poisoning the minds of the rank and file of the bona fide labor organizations against those whom they have elected to occupy executive positions. The object in view being to bring about a loss of confidence in the honesty and integrity of the general officers, dissension among the rank and file, and eventually, the dissolution of these organizations.

The past history, the present standing and the well known honesty and integrity of

the general officers need no defense from the attacks of men of the Richardson type. The general officers are doing business for you and associating with you daily and are proving their worth. The standing and influence of your respective organizations, the standing and influence of the Railway Employees Department, all demonstrate the business capacity and integrity, as well as the untiring efforts being put forth to build up and further strengthen the organizations represented in and being a part of the bona fide labor movement of this continent.

January 1, 1915, witnessed the demise of the International Association of Car Workers, the American Federation of Railroad Workers being launched in its stead, with Richardson as president. It is said (To be continued in next month's Journal.)

METAL TRADES DEPARTMENT,

American Federation of Labor.

Washington, D. C., May 3, 1915.

To the Editor Boiler Makers' Journal, Greeting:

I am inclosing herein a brief article in connection with the Panama Canal, for publication in the June issue of your Journal.

Fraternally yours,

JAS. O'CONNELL,

President.

House Rent on the Panama Canal.

For several years the Metal Trades' Department of the A. F. of L. has busied itself in looking after the welfare of all the employes of the Panama Canal through the various departments at Washington and in communication with Governor Goethals, and without desiring to appear egotistical, we feel that we have accomplished much in the interest of the Panama Canal employes.

First, we succeeded in preventing a reduction of wages going into effect by having a resolution passed in Congress providing that the rates of wages then prevailing should not be changed until the construction work of the canal was finished or at least not before June 1, 1916. The result of this effort saved to the employes on the Panama Canal several hundred thousand dollars in wages.

We felt that there would be no further trouble on the Panama Canal nor would there be any other attempt to reduce the wages of the employes, but to our surprise an executive order was issued by President Wilson in January, 1915, putting into effect the charging for house rent, fuel and light to married men living in government houses, and for room rent to single men occupying government houses. In addition, some changes were made in the privileges allowed in connection with the government hospitals. This meant practically a ten per cent reduction in wages.

We immediately took the matter up with the authorities at Washington, had several conferences with Governor Goethals who

was here during the month of January, and who seemed to be confirmed in his opinion that the executive order should be carried out.

We then had an interview with President Wilson with a view to having the order rescinded or at least held in abeyance until we could make a more thorough investigation of the real conditions existing along the Panama Canal. The President informed us that the order was issued upon the order of the Secretary of War and advised us to call upon him, and that he would give every consideration to any proposal the Secretary of War might, either in abolishing the order or withdrawing it until an investigation could be made by us.

We called upon the Secretary of War and found him thoroughly imbued with the idea that the executive order was a just one and that he had approved of the order before it went to the President upon the recommendation of Governor Goethals, and that unless we could bring some new data that would warrant him in changing his position he could not make any other recommendation to the President other than that the order be carried out.

We then prepared a new statement, setting forth as best we could the position of the employes on the canal in opposition to the charging of rent, fuel and light, and forwarded the same to the Secretary of War, who later informed us that he had not changed his opinion.

A public meeting of the employes on the Panama Canal was held during the month of March; a committee was appointed to come to Washington to see the President with a view to having the order rescinded. This committee was made up of one locomotive engineer, one blacksmith, one plumber, one machinist and one inspector of finished material, who was the chairman of the committee and who was not a member of any organization.

This committee found it impossible to see President Wilson, but two of their members finally succeeded in having an interview with Mr. Tumulty, the President's secretary, and, so far as I know, the matter is still in the hands of the secretary. The committee has returned to the Panama Canal without receiving any further consideration at the hands of the officials of the government.

We, however, kept up the agitation and our Executive Board, upon my recommendation, authorized me to go or to delegate an officer of our department to make a personal investigation of the whole situation on the canal. We requested the Building Trades Department to join with us on this investigation and that department authorized their secretary to make the investigation with us. Later, through efforts made with officials of the government, an arrangement was made whereby Governor Goethals is to be in Washington about May 8 for the purpose of again taking up this

question and we have every reason to hope that we will be able to bring about a reconsideration of the President's order, so that charges for rent, fuel and light will at least not be put into effect on the canal until the construction period has been passed, which we believe was the original intention of Congress when the organic law was enacted.

(Signed) JAMES O'CONNELL,
President Metal Trades Department, A. F.
of L.

To the Editors of the International Journals,
Greeting:

In addition to the letter I wrote you for publication in your June issue in connection with the situation on the Panama Canal, I am pleased to report that at a conference held in Washington with Governor Goethals, Hon. W. B. Wilson, Secretary of Labor, and the Hon. L. M. Garrison, Secretary of War, we succeeded in having a joint request made upon the President to rescind the executive order in connection with the payment of rents, fuel and light and the following was agreed to:

"The two Secretaries will recommend to the President that the Executive Order in question be modified by suspending the operations thereof relating to rent, fuel and lights during the period of actual construction of the Panama Canal but not later than June 30, 1916."

Please add this to the article I have already sent you which I am sure will be pleasing information to our entire membership.

Fraternally yours,

JOS. O'CONNELL,
President.

Long Pine, Neb.

Dear Sir and Brother:

After belonging to the unemployed for the past three months I landed a job in the large city of Lonesome Pine. Never in all my travels did I go through the stunt of playing hide and seek as I did in those three months. I was unlucky enough coming out of Stockton, Cal., to try and ride the Southern Pacific Railway. After eight days of crawling behind bolts and in between cracks of the Brownies I got to Roseville, Cal., very hungry. I braced up enough nerve to try and pass the gunman at the S. P. shops. I made it, found a fellow that I took between the cars and asked him where the boiler maker was. He says, "Come on and I'll show you." He took me up to a great big six-foot nigger and says, "That is the boiler maker." I looked the nigger over and told him I was a machinist, that the man was mistaken so he took me over to the back shop and led me up to a Jap, and said this was the machinist. Well I was sick right then and not hungry. I then asked this cross between a Bohunk and Dago what part he played around there. You could have knocked me down when he said, "Me is the boss." Well I knew I might as well start right there so I got the banner and carried it all night. Never again for yours

truly over a strike bound road. If it had not been for the ladies, I would have been under the daisies at this time. This is what I think of them:

When the creator had made the good things there was still some dirty work to do, so He made the beasts and reptiles and some poisonous insects, and when He had finished He had some scraps that was too bad to put into the rattlesnake, the hyena, the scorpion, and the skunk, so He put all these together, covered it with suspicion, wrapped it with jealousy, marked it with a yellow streak and called it a scab.

This product was so fearful to contemplate that He had to make something to counteract it, so He took a sunbeam and put in it a heart of a child, the brain of a man, wrapped these with civic pride, covered it with brotherly love, gave it a mask of velvet and a grasp of steel and called it a Union Man, made him a lover of field and flowers and manly sports, a believer in equality and justice and ever since these two were, mortal man has had the privilege of choosing his associates.

So brothers, one and all, lets all boost and lay the knocking hammer down.

Yours fraternally,

C. M. BLAIR,
Lonesome Pine Lodge No. 109.

Fort Worth, Texas.

Dear Sir and Brother:

Inclosed please find card picture of scabies on the job that we pulled on the oil field strike at Jacksboro. All men that came off



stayed on the ground for several weeks. After some trouble most of the men got in bad with the minions of the law and had to leave. Soon after they left this bunch of

rats come in. The one seated on still, bare-headed, is C. Comer, a permit man known to most all of the tankers. The fine looking young man in the cap and sweater is one Carlson, known to most of the gang. The remainder of this bunch I am unable to name, but it's possible they are known and if so pass the word along.

Nothing new in this section of the country. Business is rather slow and prospects not very bright. With best wishes, I am
Yours fraternally, L. A. Freeman.

Wichita, Kas.

Dear Sir and Brother:

Please find enclosed my financial report and also Brother Sample's expense report for publication in the next issue of Journal. Sorry we are in debt on this matter of one hundred and twenty-three dollars and thirty-eight cents (\$123.38), due Brother Sample, but any suggestion that you can give to help us rid this bill will be a favor to us. Let me hear from you as I don't know what to do to rid this bill, and Brother Sample surely ought to be paid for his services for us. Of course, we will have to look to the locals that pledged themselves to support a legislature representative on boiler inspection bill, but I think it will be a hard matter to collect from these locals again, as those that did support done very well. I thought that maybe if you would send out another circular letter asking aid from the locals that did not contribute would help us pay this balance of \$123.38 due Brother Sample.

With best wishes, I remain,
Yours fraternally,
J. M. DEVLIN,
S.-T. Legislative Conference.

Financial report, money received from locals: No. 83, \$25.00; No. 518, \$16.00; No. 340, \$21.50; No. 221, \$56.00; No. 523, \$7.50; No. 292, \$43.25; No. 297, \$12.50; No. 543, \$11.50; No. 199, \$18.00. Total collected, \$211.25.

Secretary-Treasurers' expenses:
Postage stamps\$2.00
Money orders65
Stationery and stenographic work.... 3.10

Total.\$5.75

Money paid Brother Sample, our legislative representative, to date, \$205.50, leaving balance of salary and expenses of legislative representative of \$123.38.

As Locals No. 82, 542, 286, 393, 403 and 418 were not in favor of supporting a legislature representative on proposed boiler inspection bill, we will have to look to the locals that did pledge themselves and did contribute support by levying another assessment to make up the balance due Brother Sample, which is \$123.38.

Hoping all secretaries will take this matter up and let us get rid of this bill as Brother Sample did his part and surely should be paid for his services for us. All money to be forwarded to me and be receipted for same.

Hoping to hear from all the locals and that all will contribute what they can afford so we can square up this account, with best wishes and regards to all I remain,
Yours fraternally,
J. M. DEVLIN, Sec'y.-Treas.

Pratt, Kas.

Mr. J. M. Devlin.

Dear Sir and Brother:

I am submitting herewith statement of account for salary and expenses as legislative representative at Topeka.

To salary, week ending January 23...\$36.00
To salary, week ending January 30.... 36.00
To salary, week ending February 6... 36.00
To salary, week ending February 13.. 36.00
To salary, week ending February 20.. 36.00
To salary, week ending February 27.. 36.00
To salary, week ending March 6..... 36.00
To salary, week ending March 13..... 36.00
To salary, week ending March 19.... 30.00

Total.\$318.00
Telegram to Brother Casey Jan. 25....\$0.50
Telegram to Brother Casey Jan. 29.... .25
Carbon paper, Jan. 29..... .25
Typewriter paper, Jan. 29..... .50
Postage stamps, Jan. 29..... 1.00
Carbon paper, Feb. 24..... .50
Typewriter paper, Feb. 24..... .65
Postage and envelopes, Feb. 24..... 1.08
Mimeographing circulars, March 4.... 2.00
Postage, March 4..... 3.30
Envelopes, March 4..... .85

Total.\$328.88
February 28, cash received.....\$80.00
March 11, cash received..... 65.00
April 5, cash received..... 60.50

Total.\$205.50
Balance due this date.....\$123.38
Yours fraternally,
S. T. SAMPLE.

A COMMUNICATION FROM THE AMERICAN FEDERATION OF LABOR.

Washington, D. C., April 28, 1915.

To the Officers and Members of the National and International Unions, State and City Central Bodies.

Dear Sirs and Brothers:

At the meeting of the Executive Council of the American Federation of Labor held at headquarters April 19-24, the representatives of the United Garment Workers of America entered a complaint against the Journeymen Tailors' Union of America for using the union label of the Tailors upon ready-made clothing and clothing made by the seceding faction of the United Garment Workers of America. Secretary Tracy of the Union Label Trades' Department of the American Federation of Labor also entered a complaint against the Journeymen Tailors' Union for violation of trade union principles in permitting such an unwarranted use of the union label of that organization.

It was called to the attention of the Executive Council that the official journal

of the Journeymen Tailors officially confirms such improper and illegitimate use of their label by the seceding faction of the Garment Workers, which is contrary to the laws of the Journeymen Tailors' Union, which forbids the use of that label by any person not a member of that organization.

This being the case where the tailors' label has been granted by the Journeymen Tailors' Union and used by the seceders from the United Garment Workers of America in flagrant violation of the declaration and the mandates of the Philadelphia convention of the American Federation of Labor, the Executive Council of the American Federation of Labor hereby cancels and withdraws the endorsement of the label of the Journeymen Tailors' Union of America.

President Gompers was directed to notify the General Secretary of the Journeymen Tailors' Union of America and all central bodies, national and international unions that the endorsement heretofore given to the label of the Journeymen Tailors' Union of America is canceled and withdrawn and shall so stand until the Journeymen Tailors' Union complies fully with the decisions of the Philadelphia convention, to-wit: resume referendum vote their former title, "The Journeymen Tailors' Union of America," and cease to trespass on the jurisdiction of any other union in the clothing industry. Upon proper compliance by the Journeymen Tailors' Union the president of the American Federation of Labor is directed to restore the endorsement of the American Federation of Labor to the label of the Journeymen Tailors' Union of America.

Secretary Morrison was directed to continue to hold in his possession any money forwarded by the Journeymen Tailors' Union and not to credit the same upon the books of the American Federation of Labor until the tailors comply with the direction of the Philadelphia convention to resume by referendum vote their former and proper title, the Journeymen Tailors' Union of America, and cease to trespass on the jurisdiction of any other union, and stop all moral and financial support of, or affiliating with the seceding faction of the United Garment Workers of America, and that upon proper compliance by the Journeymen Tailors' Union all monies be placed to the credit of the Journeymen Tailors' Union without prejudice of any kind whatever.

President Gompers was directed to publish in the Weekly News Letter a copy of the several actions taken by the Executive Council of the conditions existing in the Tailors' Union, also in circular to be sent to each national and international union, state and city central body connected with the American Federation of Labor, and also to each local union of the Journeymen Tailors' Union and United Garment Workers of America.

President Gompers was directed to confer and to meet with the United Hebrew Trades of New York for the purpose of having that body cease its harboring and supporting

seceding garment workers located in New York City, and upon failure of that body to comply with the laws of the American Federation of Labor, the decisions and declarations of the Philadelphia convention of the American Federation of Labor, all international unions having locals in New York represented in the United Hebrew Trades be required to direct such local unions to withdraw from the United Hebrew Trades.

The above is communicated to you as the official and authoritative action of the Executive Council of the American Federation of Labor in regard to the course to be pursued by organized labor in the unfortunate condition in which the tailoring and garment working trades have been plunged by a wilful perversion of trade union principles to the great detriment of the workers in the trade.

The Executive Council aims to be of practical and efficient service to all the toilers of America, and, in this instance, to the workers in the tailoring and garment working industry, and holds itself in readiness to do any and every honorable thing to help the organization disentangle itself from the present intolerable situation.

The officers of the central labor unions will please bring this matter to the attention of their respective unions at the next regular meeting.

Trusting that I may hear from you in regard to the above matter at your convenience, I am,

Fraternally yours,

Attest: **SAML. GOMPERS,**
President American Federation of Labor.
FRANK MORRISON,
Secretary, American Federation of Labor.

New Albany, Ind.

Dear Sir and Brother:

In the journal a few months ago, there were some correspondence in regards to paying sick benefits to sick members in good standing and asking for suggestions on the matter. Now that would be a great thing if some of the worthy brothers over the country would get their heads together and quit their mud slinging, we could build up our organization second to none. I belong to the strongest and only strictly up-to-date beneficial order of the good old U. S. A. Now this is only a suggestion on my part, and I believe it is a good one. Let the dues stay like they are; when a candidate comes in he has to be a member in good standing six months before he is eligible to sick benefits and a reinstated member three months. The sick benefits to be paid such as first week two dollars, the next twelve weeks five dollars and then if he is still unable to work from the same cause, two dollars and fifty cents for one year and the death benefit be the same, about eighty dollars. If a member becomes sick and unable to follow his regular vocation through his own misconduct, he gets no benefits, and have a clause inserted, if a man is unable to follow his regular vocation but is

able to make a living at some other he will not receive benefits. Have it arranged so that the officers of the locals are relief committees and will have to visit the sick once a week, and cut out the death benefit. You now have ranging all the way from fifty dollars to two hundred and fifty dollars, and set it to one figure for all.

Now the order I belong to pays after the first thirteen weeks, two dollars and fifty cents per week as long as you remain sick, even twenty years, and I do honestly believe we are the strongest memberically and financially in the United States. If the brothers at large would stop their talk about amalgamation and use the same amount of energy in this way we would have some organization to be proud of now. Now brothers, I have been a member of the B. M. & I. S. B. & H. of N. A. for thirteen years, and have been a boomer that long. Some of you will know me and you will say that what we need is a sick benefit. Now let us all get our heads together and do something for the good old order. There are several other labor unions that pay sick benefits. I am, for my part, just as close to the machinists as I ever want to be without amalgamation.

Thanking you for giving me your time, I am
Yours fraternally,
EDW. FREEMAN.

Dear Sir and Brother. Richland, Cal.
Please find inclosed resolutions for publication in the Journal.

Yours very respectfully,
GEO. E. BENNETT, R. S. L. 317.

Resolved, That we extend our warmest sympathy to our worthy financial secretary, Brother William Jones, and wife, in the loss of their babe; and that a copy of this be sent to the Journal, and one to the family, and entered on the minutes of Lodge No. 317, Richmond, Cal.

GEO. E. BENNETT, R. S.
FRANK MALLINSON, Pres.

Beaumont, Texas.

Dear Sir and Brother:

As I told you I would make reports on proceedings of Texas Federation of Labor, I will say that union labor never has had such courtesy shown them by the highest officials of any state as was shown us at Austin. We were first welcomed to the city by Mayor Woodman.

Yours fraternally,
T. C. MADDY.

The following is a partial report of the opening ceremonies and addresses:

LABOR WELCOMED.

The convention of the State Federation of Labor was formally opened yesterday morning in the House of Representatives in a session marked by a wonderful enthusiasm. Notable speeches of welcome were made by Governor Ferguson, Mayor Woodriddle, Senator T. H. McGregor, Judge D. A. Gregg and Martin Broderick, with Judge J. D. Moore

presiding as master of ceremonies. Response for the federation was made by President Ed Cunningham.

The delegates arrived at the capitol about an hour before the convention was called to order, and by 10 o'clock had filled every seat in the vast chamber. The appearance of these men representing the labor interests of the state compared well in dignity and bearing with that of the men who occupied the seats a month ago, save the labor men were noticeably more quiet than their distinguished predecessors.

And then, too, every man remained in his seat from the first tap of the gavel in the morning to the final adjournment in the afternoon and gave his undivided attention to the work at hand, there was no "insidious" lobby to influence.

Judge Moore eloquently presided over the opening ceremonies of the morning. He introduced Martin Broaderick, who, on the behalf of the Trades Council of Austin, warmly welcomed the delegates.

"I welcome you to the most beautiful spot in all of Texas," said Mayor Woodriddle in a brilliant speech, in which he emphasized the relative importance of labor in the forces which make up the world. He maintained that labor should have the greater part of wealth because it is the greatest wealth producer. He foretold the early arrival of the time when labor will be more important than capital. He said that when labor fought for shorter hours it fought for greater efficiency.

Governor's Tribute to Labor.

In a valuable, flowery speech Judge Moore introduced Governor Ferguson as a "most distinguished citizen who has arisen from the ranks of labor."

The Governor was greeted with an applause that lasted for several minutes.

"I am glad that John got through," said the Governor amid a roar of laughter. "If he had spoken much longer I wouldn't have had anything left to say.

"I regard this as one of the most auspicious occasions of one of the most important organizations ever held in this state," the Governor continued. "While we know that labor has no better friend in Texas than Mayor Woodriddle, I disagree with him when he says the time will come when labor will be the most important thing in the country, for the time has already come when it is the most important thing in the country."

He pointed out that the delegates hold a position of great responsibility and that there was great danger of them becoming excessive with their demands, although by adhering closely to the rule of justice all of labor's needs would be obtained.

"It is as much the function of government to prevent the prostitution of labor as it is to prevent the confiscation of capital," he said. "I am not filling my office, but I am filling your office, and I trust the federation will co-operate with us in all public matters. While you are here in the city I

want you to come to see me that we may talk over these matters which are near to your fireside and mine. The Governor's Mansion is open to you."

Prolonged applause greeted the Governor's speech, and upon the motion of one of the delegates the Governor was unanimously elected an honorary member.

Governor Treasures Badge.

President Cunningham swore him in and pinned a delegate's badge on his lapel. "I would rather have this than the sword of Napoleon," remarked the Governor.

East Boston, Mass.

Dear Sir and Brother:

Lodge No. 585 is now affiliated with the Boston Metal Trades Council, a central organization of kindred crafts in Boston, that aims to secure fair play and justice for all union men, and to promote a feeling of good will and confidence between employers and employes. Grievances when discovered are considered before an advisory committee consisting of the different business agents of each craft in the council, and such grievances are adjusted with as much expedition as conditions may warrant. Our representative on the advisory board is Business Agent Daniel N. Generson, who is working hard with the assistance of his brother officers and the M. T. C. to put a stop to men of other trades infringing on boiler makers' work in this section of the country. We have six delegates to the Metal Trades Council, viz., Brothers William E. McNabb, Thomas F. Farmer, James A. Vincent, D. N. Generson, John Warnock and Daniel B. McInnes.

Brother Charles F. Scott was present recently at one of our meetings and from his standpoint of an International Organizer of our Brotherhood outlined a very comprehensive campaign for getting new members from the railroad and contract shops in this part of the country.

Our worthy treasurer, Brother Bernard McDonnell, who is constantly endeavoring to have every job that he works on to be as thoroughly "union" as possible, was presented at a regular meeting a handsome gold emblem button of the Brotherhood for selling the most tickets for our recent ball, he having sold \$31 worth.

President McNabb in conferring the button on Brother McDonnell, paid a well-deserved tribute to the ever faithful interest that Barney McDonnell takes in the welfare of Lodge No. 585 and the Brotherhood in general.

Lodge No. 585 regrets to announce the death of one of its best members, Brother John Anderson, who died suddenly at Westfield, Mass. His identity was disclosed by his union card, and Brothers Vincent and Generson worked systematically to see that Brother Anderson was given proper burial. We will miss the pleasant smile and cheery greetings of Brother Anderson, for whom the night came "when he would work no

more," but we hope that after life's fitful fever he sleeps well. Our charter will remain draped for 30 days out of respect to his memory.

Yours fraternally,
DANIEL B. McINNES, L. 585.

Salt Lake City, Utah.

Dear Sir and Brother:

I wish you would publish the following in the next Journal and continue same for two or three months if possible, as this will help to boost for a railroad that is fair to organized labor, and thus help to increase business and consequently to employ more union men. Safety First Boost for the Denver & Rio Grande Railroad, which is a boost for organized labor. Boiler makers, helpers and their friends intending to see the San Francisco Exposition should travel over the D. & R. G. Railroad. If you know of anyone going to travel or ship freight, tell them to go over fair roads, or ship over fair roads. The Denver & Rio Grande is the scenic railroad of the West. All business you can divert from Illinois Central, Harriman Lines and other struck roads means business for a railroad which is fair to organized labor, the only road which has granted the eight-hour day to its employes. Support the road that supports union labor, as more business means more employment of union men and a helping hand to our brothers.

Beauties of the scenery and general attractiveness of the Denver & Rio Grande Railroad are interestingly portrayed in the following description. The Denver & Rio Grande Railroad begins at Denver and runs over, under, through, beside, among and between vast quantities of high grade scenery on its way to Salt Lake City. Scenery is the D. & R. G.'s specialty. It hauls more people who haven't anywhere in particular to go, than any other railroad. Each year thousands of Americans and a few bold Europeans travel over the road from Denver to Salt Lake, and then turn round and go back in order to sit on the other side of the car and get another eye run of the grandeurs of nature. The sale of magazines and other time-killers on this line is exceedingly small.

"The Denver & Rio Grande begins a mile above sea level and never gets much lower. It starts for Salt Lake by going directly away from it 100 miles, and consumes 750 miles to cover 350 in the direction of the flight of an unintoxicated crow. No one minds, however, as it is considerable sport to put one's head out the window and converse with the fireman as the engine comes past on a heavy curve. The D. & R. G. climbs mountains two miles high, wriggles through canyons so narrow that only one coat of paint can be put on the cars, and crosses rivers which look like the Niagara rapids in hysterics. Over 750 miles of its lines are narrow gauge, and the scenery is a tight fit for it at that. It takes three

locomotives to hoist a train to the top of Marshall Pass, and if more than a dozen heavy men are aboard, the fireman draws time and one half."

Remember, to travel over the Missouri Pacific, Denver & Rio Grande and Western Pacific railroads when going to the fair. And when shipping freight, send it over these roads and help organized labor. I am

Yours fraternally,

B. S. R. HARRISON, C. F. S., L. 103.

Tomahawk, Wis., May 7, 1915.

Dear Sir and Brother:

The past few months a great deal of interest has been shown in the welfare of this Brotherhood by the articles in the Journal. I think enough has been said of the proposed amendments, no matter what some of us think of the increase to the salary of the president at this time. I do believe we can do away with machine politics at our conventions and that by the rank and file adopting the referendum and recall system, whereby it would be impossible to increase present officers' salaries without the consent of the rank and file of the Brotherhood.

We have had a trial of the so-called referendum at one time and some officers and members say it was a failure, but, nevertheless, we can profit by past mistakes and adopt a referendum and recall system that will be a credit to organized labor.

I would like to hear the views of more members on the referendum and recall system through the Journal, so we may send delegates to our next convention instructed to adopt the referendum and recall system

and so protect all funds of our Brotherhood and elect all officers. With best wishes I remain,

Yours fraternally,

THOS. J. FARLEY,
Member No. 302.

Portsmouth, Va.

Dear Sir and Brother:

The next State Federation of Labor Convention will be held at Fredericksburg, Va., June 7, 8 and 9. Brother George J. Thomas of Lodge No. 57 and myself, the undersigned, have been elected as delegates from the C. L. U. of Portsmouth, Va., to represent that body at this convention, and as the boiler makers of Portsmouth and Norfolk, Va., have no delegate representing their locals at this convention, but are very much interested in the boiler inspection laws by state and city legislation and as I need some good intelligent advice in this matter, I take this means because I believe in my heart and soul that there never was one individual that did any more for the working class, both organized and unorganized, as you have done when you were with us in the state of Virginia, and, therefore, I do not hesitate in asking you for the advice I seek, because I have everlasting confidence in your ability to give me what I seek for the interest of the boiler makers.

If possible I would like for you to send me a copy of the inspection laws governing state and city, as well as railroads, so I can draft up some kind of bill and take the same before the locals of Portsmouth and Norfolk, Va., for their approval and have the same indorsed by C. L. U., Norfolk, Va.



NIGHT GANG AT MONTPELIER, O. MEMBERS LODGE 581.

Left to Right, Standing—Hudson, Edwards, Lambertson, Collins, Buntain, Fickle, Tehan.
Left to Right, Bottom Row—Calvin, Farley, Emmons, Cashmere, Gumbler, Bislar.

Boiler Makers No. 428 have a committee out who are securing the number of boilers in the city. In Portsmouth we have committee doing the same thing, but are elected by C. L. U. Committee consists of boiler maker as chairman, machinist and steam fitter, so you see we are very much interested in the steam boiler inspection bills. As I have nothing further to say, I will close.

Hoping to hear from you as soon as possible for the best interest of our Brotherhood and your success, I remain

Yours fraternally,
H. E. PHELPS, Lodge 57.

Concord, N. H.

Dear Sir and Brother:

I am sending you an answer I received from my representatives at Congress which I received through my writing to them a short while ago in regards to a circular I received from the metal trades council in the Panama Canal zone.

The letter inclosed is one that I received from United States Senator Henry Hollis which he received from the governor of the Panama Canal. I wish you would publish same in the Journal.

Yours fraternally,
J. BERRYMAN, R. S. 245.
Washington, D. C., April 6, 1915.

Hon H. C. Hollis,
United States Senate,
Washington, D. C.

Sir:—

Referring to your letter of March 8, 1915, with reference to the employment of alien negro labor on the Panama Canal, and the reply from this office of the same date, you will find inclosed herewith a copy of a statement from the Governor of the Panama Canal, dated March 19, 1915, which clearly sets forth the circumstances under which alien negro labor is employed on the canal.

In the absence of the chief of office.

Very respectfully,

A. L. WAINT,

Assistant to the Chief of Office.
THE PANAMA CANAL ZONE.

Balboa Heights, March 19, 1915.

A statement relative to employment of alien labor on the Panama Canal.

In view of the fact that certain labor organizations on the Isthmus and in the United States have been for some time past severely criticising the employment of alien labor on the Panama Canal and have persistently asserted in many letters to members of congress and officers of the United States Government that American workmen were being discharged and their places filled by cheap, negro labor, I have deemed it advisable to make a general statement of the facts.

I wish to be clearly understood in the beginning as stating that there has been no change whatever in the policy of the United States Government and the canal administration which can be construed to be detrimental to the American workmen. The

assertion that American citizens are being discharged to make places for alien negroes is absurd and not true.

From the beginning of the work on the isthmus negro and native workmen have been used for most of the manual labor incident to all the mechanical, building and construction trades. It is customary in these tropical countries for white men to direct the work and negroes to do the harder parts of the manual and semi-skilled labor, partly on account of the effect of the climate on white men and partly on account of the very great preponderance of the colored population over the white population. The relative proportions of the white and black races in these countries fixes to a large extent the division of labor between them.

The powder men in the canal directed the drilling of the power holes, but the negroes ran the drills. The white carpenters bossed the building gangs, but the negroes cut the timbers and drove the nails under their supervision. White mechanics laid out the repair and manufacturing work in the shops and directed the negroes in the execution of the necessary labor. White foremen directed the mixing of the paints and supervised the painting work, but negroes were sent up on the ladders and on the roofs to do the manual labor of painting. White foremen planned and directed the execution of the electric wiring, but negroes climbed the poles and crawled into the corners where it was beneath the dignity of the white man to go. I do not make this statement disparagingly; it is a literal fact that in a country of this kind, where the negroes have always done the manual labor, it is not compatible with the white man's pride of race to do the work which it is traditional and customary for the negroes to do.

The above has been in general the situation for all the years past during the construction of the canal and is the situation today, with the exception that I have taken away from the negroes some few positions where it was pointed out that the positions were not of the class of work generally described above.

The present agitation is the result of an organized effort on the part of labor unions to force the payment of first-class mechanics' wages for all unskilled as well as skilled work in such trades as the machinists, carpenters, blacksmiths, iron workers, copper-smiths, plasterers, etc. When the reduction of force began it was necessary to let men go, and as they very naturally dislike to go, especially in view of the unsettled conditions at present in other parts of the world, they have resorted to this most unfair charge against the Canal administration to force the government to keep them at first-class rates and pay (generally sixty-five cents per hour) to do the work always performed by negroes, and which in the States would be done by helpers at low, day-labor rates of pay and by apprentices.

A committee of the metal trades unions complained that aliens were being sub-

stituted for American mechanics; their statements were general without specific instances. I suggested that the committees of the separate trades get their data and I would investigate. Though I found conditions had not changed, I put some few Americans on work which had been done previously by aliens and stated that I am perfectly willing to give every job on the canal to American citizens if they will accept the work at wages proportionate to the wages paid in the States for similar work and in comparison with the general scale paid here.

This, however, is not what the unions desire; they desire to force the government to pay first-class, skilled workmen's wages to Americans for performing low-grade, practically unskilled work now performed by negroes, as explained above. I can not concede the justice of their demand.

Within the recent past I have discharged many colored yard engineers, most of whom have been employed by the Panama Railroad Company since French times, to make places for American citizens. I have discharged many operators of small cranes to make places for American citizens. I have prohibited the employment of any but American citizens in clerical positions, paying over \$60 per month (no American clerk that is worth anything will accept less than \$75 here). I have made certain concessions to the men with respect to the machines and tools which negro helpers are allowed to use in the shops. I have endeavored to meet every reasonable demand of the men, as I fully sympathize with their desire that our own people should be given any and every job which, on the same proportionate scale as is paid in the United States, will support them and give them contentment.

But right there is the difficulty. We do not have here the great, white unskilled labor class that can be found in every city and town of the United States, and it is extremely doubtful whether with the same wages such labor receives in the States they would be satisfied with the surroundings they would find here.

It certainly is unfair to the taxpayers of the United States and to the government to ask the canal administration to do this class of work with skilled workmen at high pay for the sole and only reason that these workmen need jobs.

A white American carpenter would not be willing to take a saw, a plane and a hammer and put up a pine kitchen shelf at twenty-two cents per hour, which is all such labor is worth, but he asks us to pay him fifty-six cents an hour, which is the wage of a first-class carpenter who generally is able to plan and build a dwelling house. That is the situation in concrete form.

Since the beginning of the work we have maintained a gold and a silver roll of employes; the gold roll is the roll of American employes and the silver roll of aliens. The following table gives the percentage of Americans on the rolls from 1909 to the

present time and it will be readily seen how ridiculous is the charge that American citizens are being replaced by aliens:

Time—	Total force	Silver	Gold	Percent- age of entire force on gold
June, 1909.....	33,493	28,484	5,009	14.9
Dec., 1909.....	34,035	28,827	5,208	15.3
June, 1910.....	35,588	30,313	5,275	14.8
Dec., 1910.....	35,132	29,591	5,541	15.8
June, 1911.....	32,690	27,612	5,078	15.5
Dec., 1911.....	37,826	32,539	5,287	13.9
June, 1912.....	34,957	30,017	4,940	14.1
Dec., 1912.....	34,659	29,397	5,262	15.2
June, 1913.....	38,301	33,214	5,087	13.3
Dec., 1913.....	32,148	27,676	4,472	13.9
June, 1914.....	29,632	25,400	4,232	14.3
Dec., 1914.....	25,171	21,470	3,701	14.7
Jan., 1915.....	24,564	20,863	3,701	15.0
Feb., 1915.....	23,089	19,624	3,465	15.0

Conclusion.

In conclusion, therefore, I wish to state that the charge that there has been a change of policy on the part of the canal administration to the detriment of the American workmen is absolutely false. There could be no justification for such a change of policy. The absurd charge that Americans are being discharged and their places given to aliens is intended by those responsible for it to discredit the canal administration and create for themselves sympathy and thus force the issue.

GEO. W. GOETHALS,
Governor.

Dear Sir and Brother: Brainerd, Minn.

The policy of continuing "trade autonomy," and to segregate it within its own independent jurisdiction, when the process of machine development is inevitably interlocking the trades, when the lines that defined trade jurisdiction are being gradually obliterated, when this is the logical result of "the machine" and nothing can prevent it, is sheer folly. It is an anomaly, and we are paying the penalty in full for persisting in such an unnatural condition.

Since the first introduction of machinery into industry, the workers have been bitterly opposed to it. In the sixteenth and seventeenth centuries, we are told, the workers dreaded the "machines" so much that they destroyed them, how they even secured laws to prevent their being used. Even today we find ourselves unconsciously objecting to further encroachment of modern invention to our trade. However, we are intelligent enough to understand that the development of the machine must go on. Still the old instinct of dread exists, coupled with the knowledge that the machine, instead of lightening our burdens and giving us greater economic security, has subjected us to greater exploitation and enslavement.

In spite of the unprecedented growth of machinery during the last half century, the working class are in a less secure state

than ever before. It has robbed us of our specialized craft skill and driven millions out of employment, destroyed whole crafts (the glass bottle blowers) and eventually it will completely substitute electricity for steam power. It has built up mighty wealth for a few and reduced the masses to a state verging on poverty. As members of society so vitally affected by this evolution going on in the industry from which we derive our sustenance, it behooves us to take heed, to keep pace with this change, to conserve our strength and assets.

The modern railroad plant has a dozen or more different trades which constitute its working force. So far as the company is concerned, the sole aim and motive is to get as much work out of its force as it can, with the smallest possible outlay in return. The "force," or employes, all look alike to it. To keep these workers split up into a dozen or more different organizations, is to divide, not organize them, is to subject them to dissention and jealousies, to render them helpless against a united enemy by keeping them wrangling over insignificant jurisdictional disputes. To make use of the eleven trades in materially assisting in the defeat of one trade when it rebels and strikes. This effect is caused by our independent form of organization. It requires very little study of our "past actions and practices" to discover these outstanding disgraceful features.

Furthermore, to so divide the workers means a tremendous wasteful outlay of finances. See these crafts duplicating the same methods of conducting business as though they were all going in an opposite direction and antagonistic to each other in the struggle against a common enemy. Are they not all struggling alike for the same identical purpose? Is not their aim and motive the same? Most assuredly it is. They all seek a means of existence, better conditions of life, protection of their economic interests. This being an indisputable fact, why then should they all act independently against a solid opposition? Why quarrel over insignificant matters amongst themselves? Is there some great fundamental difference existing between the workers of the metal trade crafts that, in spite of the identity of their interests, prevents them from becoming united into one whole?

Federation does not overcome these inherent evils. It rather aggravates them. At best it is a superficial, numerical unity and greatly increases our already overwhelming waste of finances. To speak of "dropping our substance and seizing a shadow," in view of existing conditions, is illogical. In the last analysis, our treasury is our substance and through our present system of organization, it is being, to a great extent, squandered uselessly. It is idle to talk of our "substance" while we are so divided into fragments. If we had been militant unions like the "Western Federation of Miners" or the "Structural Iron Workers" and fighting for life against such

an unscrupulous foe as they are, our puny organizations would either be completely crushed, or consolidated.

Our recent experience on the Harriman and Illinois Central lines, etc., lead me to think that the big interests are about to pay the railroaders their respects. The same powers that have almost crushed the "Structural Iron Workers" and are so venomously attaching the "Miners" are speedily securing control of the railroads. When they do, beware. It is then we will need "substance." Today we cannot withstand a skirmish.

If this United States were involved in war with some powerful foreign nation, would it be sensible for each state to have its own little navy and army, each acting and fighting independently, and each being defeated in turn? Of course it would not. They would act and fight as one for then they could not be crushed. We are simply pursuing this same senseless course and we simply invite defeat and annihilation. Capitalism is becoming more arrogant, brutal and avaricious and will not quietly submit to our little puny attacks.

What the future will bring, we do not know. Therefore, it is essential that we solidify our forces and conduct our advance along proper channels. The evolution of industry goes on and at every turn it relatively changes the status of those associated with it. We are in the process that is reducing us into lever manipulators for which we will need no brains—mere automatons. So the forces at work will compel us to amalgamate or else we will be smashed.

There are those sincere but timid souls who dread any innovation. They labor under the delusion that "things have always been so and always will be so." They fear some dreadful cataclysm will occur if we attempt to change the established order. At any new proposal they cry, "It will never work." Then when it gets going, they cry, "It will never stop." The question of amalgamation is not a "cut and dried scheme" and to term it "chimerical" and "impractical" is absurd and puerile. The amalgamation of those elements whose material interests are identical is a great and profound principle and a scientific one, and when applied to a working class in its struggle for justice—"human rights versus property rights"—it will place in the hands of labor an instrument that will greatly assist in bringing about that for which we all strive—economic freedom and security. It cannot be smothered with ridicule nor can it be sneered away. It is right in principle and it rests upon us to build a sane and sturdy superstructure upon this solid foundation.

A great scientific truth is, the thoughts and actions of men are determined by the manner in which they obtain their living. This is the compelling force that always keeps us in motion, that creates the feeling within our hearts, that "united we stand, divided we fall," and that our motto must be the "concern of all." We are not called upon

to immediately drop our present organization and form a new one. This thing has got to be studied out in detail and it can only come about by mutual consent. To talk of radicals dominating or seeking to lead us astray is only confusing the issue. We are told that organized labor is in its "infancy here." Very true, and a convincing reason why we should hasten its growth is that capitalism is not only in full manhood, but in its dotage.

Now capitalism is the antithesis of organized labor, and for labor to stand, and successfully defend itself, it should at least be in the advanced stage of manhood. With the injunction, the press and brutal gunmen and thugs, the growth of labor has surely been retarded. When out of almost thirty millions of workers only about three million are organized. We surely are in our infancy, and we will remain in swaddling clothes so long as we child-like continue to lie in the old-fashioned cradle of independent organizations.

Let us stand up and feel like men, equipped with an organization through which we can secure our rights. We have the natural material, why not make use of it? The principle is sound and all that is needed is the logical and carefully worked out details.

Fraternally submitted,

J. G. BROWN,
Lodge No. 116.

Miles City, Mont.

Dear Sir and Brother:

Just a few lines to let the Brotherhood at large know the conditions in the Northwest are not as good as they used to be. The Milwaukee and the Northern Pacific both are working five days a week, eight hours per day. In former years they always worked full time on both these roads and were hiring practically all the boiler makers they could get. In outside work such as pipe lines, gas holders, oil tanks and stand pipes, it seems that the structural iron workers have all this work cornered, and if a boiler maker wants to work at his own trade outside of railroad work, he must pay to the Structural Iron Workers' Union one dollar per day for the privilege of working at his own trade. There have been enough unemployed members through Miles City since spring to build a pipe line from Tacoma to Kansas City, but still the structural iron workers have all this class of work in this section of the country. Surely somebody is not tending to their business which they are being paid to for this organization. Who it is we don't know, but we ought to take steps to find out who is at fault in this matter.

With practically two-fifths of our members unemployed and in search of a job, we think it would have been good policy to secure all this outside work for our members. Brother Callahan visited our lodge recently and he stated that the Milwaukee had laid off boiler makers at several points on the Milwaukee line east of Minne-

apolis, and we think that good times exist only in the minds of the editors of big newspapers, as we have not seen any improvement in business in the past year, nor do we look for any improvement for some time to come.

While we are always glad to see a traveling brother, we can tell him before he starts for the Northwest that it's a mighty poor place to come if he is looking for a job.

Hoping you will receive this in time for the next publication, I am

Yours fraternally,
CHAS. E. COOK, C. S. L. 520.

Note.—In reference to the alleged neglect in connection with this pipe line work, we have made inquiry and find that the first intimation that this work was being done was received at headquarters the latter part of March, and International Vice-President Atkinson was notified and instructed to investigate, which he did, and found the pipe line was about finished; he covered this in his report which appeared in May Journal. We make this statement in justice to those against whom the criticism is directed. If our members will work on jobs for months or otherwise have knowledge that work is being done by other trades that belong to our members and will not make the facts known promptly, it cannot be expected that these matters can be remedied. The members owe it to themselves as well as their organization to cooperate with the officers in matters of this kind.—The Editor.

Dear Sir and Brother: Tulsa, Okla.

Am inclosing a list of members of this Brotherhood who are working on the unfair jobs in the Oklahoma oil fields and the register number and lodge to which they belong to is unknown to us. Will ask you to publish them in the Journal below the list of names that you have with numbers and fines attached and if we are so fortunate to find where these members belong and their numbers we will prefer charges against them. We will appreciate it if any of the members who read this list will let us know of any information that will assist us in any way:

A. Tipton, Tom Reed or Reid, Slim Thompson, Buck Allen, Mike Killian, Red Palmer, Joe Boon, Al Lowry, D. D. Burke, Barney Dublock, L. M. Mullen, Jim Sears, a former member of Big Springs, Tex.; W. S. Quigg, formerly of Chanute, Kas.; James Clemo, who has a card out of some Canadian lodge.

Hoping that this is satisfactory and with best wishes I am,

Fraternally yours,
RICHARD LEAHY, Sec. 592.

Honolulu, H. I.

Dear Sir and Brother:

Inclosed find list of our new officers, as I have no official roster I will have to give them to you on this sheet: President, Frank Esman, Majestic Hotel; vice-president,

James L. McGuire, Honolulu Iron Works; recording secretary, Thomas H. Murray, 1541 King Street; corresponding secretary, W. H. Lane, 900C Kanoa Lane; treasurer, Al Ferge, 1509 Young Street, and inspector, H. W. Doyle, Caton & Neull Foundry.

I will also ask you to find space in the Journal to notify the secretaries of the different lodges through the Journal that when they send raffle tickets to Honolulu that when they receive the money, the least they could do is to send a receipt. We are buying raffle tickets every month from section of the main land, and when I send the money, asking for receipt of same, it is one out of every ten secretaries that sends a receipt and unless the result comes out in the Journal, we hear no more about them.

Kindly place a note in the Journal notifying the secretaries to that effect, and oblige,
W. H. LANE, C. F. S.

Princeton, W. Va.

Dear Sir and Brother:

Inclosed you will find a copy of resolutions which we wish to have published in the next issue of the Journal.

Yours fraternally,
J. J. BOWER, C. S. L. 551.

Whereas, It has pleased the Almighty God in his infinite wisdom to remove from our midst W. C. Wells, brother-in-law of Brother S. Garrett; be it

Resolved, That Local No. 551, Boiler Makers, Iron Ship Builders and Helpers of America, do hereby extend our utmost sympathy to the bereaved family, and a copy of these resolutions be sent to the family, a copy sent to the Journal for publication, and one to the local.

CHAS. MILLER,
W. A. MEADOWS,
W. T. FOSTER,
Committee.

At a regular meeting of Lodge No. 551, the following resolutions were adopted:

Whereas, It has pleased the Almighty God in his infinite wisdom to remove from our midst the brother of our brother, George R. Williams,

Resolved, That we extend to our brother our heartfelt sympathy in his sad hour and pray that the Almighty God may comfort and console him in this hour of sorrow; and be it further

Resolved, That these resolutions be spread on our minutes, a copy sent to our brother and a copy be published in our official Journal; also charter draped.

F. C. McDOWELL,
M. W. RATLIFF,
H. F. CHAMBERS,
Committee.

Wichita Falls, Tex.

Dear Sir and Brother:

At a regular meeting of Lodge No. 576, the following resolutions were adopted:

Whereas, It has pleased the Almighty God in his infinite wisdom to remove from our midst the beloved mother, father, sister and brother of our esteemed brother, Dud King; therefore, be it

Resolved, That we, the members of Lodge No. 576, extend to our worthy brother and family our heartfelt sympathy and condolence, in this their sad hour of bereavement softened only by the confiding hope that their spirits have departed to a better and brighter sphere where sorrow is unknown; and be it further

Resolved, That a copy of these resolutions be sent to our bereaved brother and family and a copy sent to our Journal for publication, and a copy spread upon the minutes of our meeting.

W. O. HOLLIS,
R. A. CAMPBELL,
E. A. MONOHAN,
Committee.

Chicago, Ill.

At a regular meeting of Central Lodge No. 220, I. B. of B. M. and H. of America, the following resolutions were unanimously adopted:

Whereas, It has pleased the Almighty God in his divine wisdom to remove from our midst the dearly beloved brother of our worthy and esteemed brother, Thomas P. Smith; be it

Resolved, That we, his fellow brothers, extend to our fellow brother our heartfelt sympathy in his inconsolable loss, and pray that the Almighty God may comfort and console him in his sad affliction, that he may bear his trial with fortitude; and be it further

Resolved, That a copy of these resolutions be spread on the minutes of our meeting, a copy forwarded to our bereaved brother and a copy sent to our Journal for publication.

LAWRENCE CLEGG,
THOS. KELLY,
A. G. SMITH,
Committee.

Chicago, Ill.

Dear Sir and Brother:

Inclosed you will please find a resolution for publication in our next Journal. I remain,

Yours fraternally,
EDW. OSBORN, S. L. 434.

At the regular meeting of Lodge No. 434, the following resolutions were adopted:

Whereas, It has pleased the Almighty God in his divine wisdom to remove from our midst the beloved father of our brother, Peter Kayden; therefore, be it

Resolved, That we, his fellow brothers, extend to him and family our heartfelt sympathy in this hour of sorrow; and be it further

Resolved, That a copy of these resolutions be spread upon the minutes of this

meeting, a copy be sent to the bereaved family and a copy sent to our Journal for publication.

WM. COOK,
F. CROAKE,
R. SHAW,
P. O'GRADY,
EDW. OSBORN,
Committee.

Peoria, Ill.

At our last regular meeting of Lodge No. 60, Brotherhood of Boiler Makers, Iron Ship Builders and Helpers of America, the following resolutions were adopted:

Whereas, It has pleased the Almighty to remove from our midst, by death, our esteemed brother and co-laborer, William Thomas, who has for many years occupied a prominent rank in our midst, maintaining under all circumstances a character untarnished, and a reputation above reproach; therefore,

Resolved, That in the death of William Thomas we have sustained the loss of a brother whose fellowship it was an honor and a pleasure to enjoy; that we bear willing testimony to his many virtues, to his unquestioned probity and stainless life; that we offer to his bereaved family and mourning brothers, over whom sorrow has hung her sable mantle, our heartfelt condolence, and pray that Infinite Goodness may bring speedy relief to their burdened hearts and inspire them with the consolations that hope in futurity and faith in God give even in the show of the tomb;

Resolved, That these resolutions be spread on the records of No. 60, that a copy of them be presented to the bereaved family of the departed, a copy furnished to our official Journal for publication and the Peoria Labor Gazette; also that our charter be draped for the period of sixty days.

WM. MARTIN,
F. HIERSPIEL,
OLIVER VON ALMUN,
Committee.

Big Springs, Texas.

Dear Sir and Brother:

At the last regular meeting of Signal Mt. Lodge No. 423, Big Springs, Texas, the following resolutions were adopted:

Whereas, It has pleased the Almighty God in His divine wisdom to remove from this life the infant daughter of our esteemed brother, J. E. Williams; therefore, be it

Resolved, That while we bow to Him above who doeth all things best, we, his fellow brethren, extend to the bereaved mother and father our sincere sympathy and may Almighty God help them to bear this great sorrow and loss.

Resolved, That a copy of these resolutions be placed on the minutes of our local and a copy sent to our official Journal for publication.

Signed, F. M. PURSER,
EARL UPSHAW,
JAS. G. MARTIN,
Committee.

South Kaukana, Wis.

Dear Sir and Brother:

I hereby trust you will allow a short space in the Journal for these few lines. Mr. Edward Lindsley a highly esteemed and prominent brother who was a resident of Ashland, Wis., died suddenly Monday morning, February 8, 1915, at 2 o'clock, at the home of his parents. Lodge No. 311 of Kaukana held a special meeting and sent a delegation of six brothers who acted as honorary pall bearers, who accompanied the remains to the cathedral and cemetery.

The funeral took place on the 12th, at the Cathedral. Floral designs were sent by Lodge No. 311 and friends. Surviving him are his most devoted and faithful wife and parents. No tribute beyond the good moral life of Mr. Edward Lindsley is necessary to keep his memory forever fresh in the hearts of those who knew him.

Correspondent Lodge No. 311.

Bluefield, W. Va.

At a regular meeting of Bluefield Lodge No. 405, International Brotherhood of Boiler Makers, Iron Ship Builders and Helpers of America, the following resolutions were unanimously adopted:

Whereas, It has pleased Almighty God in his divine wisdom to remove from our midst the dearly beloved mother of our worthy and esteemed brother, S. J. Jones; therefore, be it

Resolved, That we, his fellow brothers, extend to our brother our heart-felt sympathy in this, his hour of bereavement, and pray that the Almighty God may comfort and console him, and he will bear his trial with fortitude; be it further

Resolved, That a copy of those resolutions be spread on the minutes of our meeting, a copy be forwarded to our bereaved brother, and a copy be forwarded to our official Journal for publication.

W. F. DUPEN,
FRED SARVER,
J. N. UTTLEY,
W. D. CASSIDY,
J. W. GILBERT,
Committee.

At a regular meeting of Bluefield Lodge No. 405, International Brotherhood of Boiler Makers, Iron Ship Builders and Helpers of America, the following resolutions were unanimously adopted:

Whereas, It has pleased Almighty God in his divine wisdom to remove from our midst the dearly beloved mother of our worthy and esteemed brother, J. B. Poor; therefore, be it

Resolved, That we, his fellow brothers, extend to our brother our heart-felt sympathy in this, his hour of bereavement, and pray that the Almighty God may comfort and console him, that he will bear his trial with fortitude; be it further

Resolved, That a copy of these resolutions be spread on the minutes of our meet-

ing, a copy be forwarded to our bereaved brother, and a copy be forwarded to our official Journal for publication.

W. F. DUPEN,
FRED SARVER,
J. N. UTTLEY,
W. D. CASSIDY,
J. W. GILBERT,
Committee.

Moberly, Mo.

Dear Sir and Brother:

At a meeting of Wabash Lodge No. 267, the following resolutions were passed:

Whereas, the Almighty God has removed from our midst and from the ones near and dear to him our worthy brother, William Codner; therefore, be it

Resolved, That we extend to his wife and family our heart-felt sympathy in this their hour of sorrow, and may God comfort and console them; and be it further

Resolved, That a copy of these resolutions be sent to the bereaved wife, a copy to the Journal and a copy spread on the minutes of this meeting.

J. J. CADDAGAN, Pres.
F. R. LEE, Sec'y.

A Compilation of Labor News.

BY THE A F OF L NEWS SERVICE

GRUNDY IS A BITTER LOSER.

Philadelphia.—Furious over his failure to block the child labor bill, President Grundy of the Pennsylvania Manufacturers' Association has issued a public statement denouncing friends of the bill who would not agree to amendments "in some particulars."

The manufacturer declares this to be "a fanatical cruelty," which none will approve or condone when the public comes to appreciate it fully.

President Grundy—who is a mill owner—tells the public that bitter days are coming for those who championed this bill, and he wants it understood that employers cannot be blamed when wreck and ruin overtake this fair state. This is Mr. Grundy's dismal warning:

"The Pennsylvania Manufacturers' Association feels that it should make a final statement regarding its attitude toward the measure in order that the blame for the hardships, the suffering and the serious curtailment of industrial opportunities which it will produce—indeed, is already producing—may be placed upon the shoulders of those who are responsible for it, and not upon the shoulders of the employers of Pennsylvania."

President Grundy deprecates the arrival of January 1, 1916, the day the law goes into effect, for then, declares this mill owner, the doors of the factory and mill "which heretofore have afforded opportunity for livelihood and advancement to juveniles" will be closed against them.

The bill as passed by both houses, and favored by Governor Brumbaugh, provides for a nine-hour day and a fifty-one hour week, but out of these hours there must be eight hours of continuation school work between the hours of 8 a. m. and 5 p. m. This was the feature opposed by the manufacturers. President Grundy says the bill is "not a 51-hour bill, but a 37½-hour bill." He and his colleagues fear the reduction of hours will force other employes to work shorter hours, because these employes de-

pend on what President Grundy terms "juvenile workers."

Philadelphia.—School authorities in this city are preparing to spend \$250,000 and employ 150 public school teachers to establish the continuation schools demanded in the child labor bill, passed by the state legislature and approved by the governor.

MINERS' LONG STRIKE ENDS.

Cleveland, O.—The thirteen months' strike in the Eastern Ohio coal fields has ended with victory for these 15,000 members of the United Mine Workers of America. The strike has been bitterly contested, and its triumphant end is an epoch in American trades unionism, as it again emphasizes the power of economic organization, when backed by determined men.

The cause of the strike was the refusal of operators to accept the Green anti-screen law, which compelled payment for all coal mined before it was screened. Eastern Ohio operators demanded a rate of 44½ cents a ton because of the law. Operators in other sections of the state were paying the union rate, 47 cents, and were accepting the law.

The strike settlement provides for 47 cents, run of mine basis. This has been accepted by the miners' scale committee, subject to ratification by the miners' convention, to be held at Wheeling.

The settlement means that the miners, through their economic organization, have forced recognition of the principle contained in the Green anti-screen law, and which they have urged for the past twenty years. At this writing attempts are being made to repeal the Green law by making it "optional," but some miners say they are now in a position to enforce the run of mine system through their trade unions, without depending on the law.

Other provisions in the eastern Ohio strike settlement call for arbitration of all questions in dispute. This applies to the discharge of miners.

Secretary-Treasurer Wm. Green of the

United Mine Workers' union states that the international union, the miners' state organization, other labor organizations and sympathizers paid \$1,504,500 to the support of the strike, which attracted nation-wide attention because of the tenacity of these loyal unionists during the past winter.

INJUNCTIONS WRONG LABOR.

Springfield, Ill.—In urging the state legislature to pass the pending anti-injunction bill, intended to regulate the issuance of these court orders, officers of the State Federation of Labor say:

"It may be said that because violence sometimes occurs in strikes injunctions are necessary to preserve the peace. Just what does that mean? The use of violence is a crime under the law. If a man commits murder, the law provides certain methods of preferring the charge against him, of arresting him, of providing him with counsel, a trial by an impartial jury, and accords him certain rights with which in the interest of justice, it has been found necessary to clothe even the meanest criminal. It is a well recognized fact that to deny these rights to men charged with crime would result in the conviction of the innocent.

But when a working man goes on strike, judges arbitrarily deprive him of the right of trial by jury, assuming to punish him, not for the commission of the crime forbidden, but for contempt of court. The right accorded to the meanest professional criminal is denied to the working men and women on strike.

"When the court arrogates to itself the power to issue injunctions for the purpose of enforcing criminal law, it sets itself above the statutory law, departs from the domain of property rights in which the injunction process has a legitimate place—and invades that of personal rights in a manner for which there can be no excuse, except that the court thereby becomes the sole judge of the law and the fact, and, if the parties enjoined are declared guilty of contempt, the extent of the punishment. All of which is in direct violation of the law."

R. R. TRIED TO INCITE RIOT.

Washington.—Riot and bloodshed was the purpose of Pennsylvania railroad officials during the Altoona shopmen's strike of 1911 was the sworn testimony of Samuel M. Hoyer, of Altoona, before the federal industrial relations commission. The witness was mayor of Altoona at the time of the strike. General Superintendent G. W. Creighton, he said, had repeatedly urged him to arrest striking employes of the company without cause, and to prevent the employes from parading, even though their parades were conducted in the most orderly manner.

"When I told Mr. Creighton that if I did what he wanted me to do it would cause rioting and bloodshed, he asked, 'what of that?'" said Mr. Hoyer.

The ex-mayor declared the strikers were

conducting themselves with perfect order, and that there was no lawful reason for interfering with their peaceful assemblages or parades, and that to have done so would "precipitate trouble of a serious nature."

The witness told the commission of his efforts to settle the strike. He said: "Creighton did not appear to want to settle the strike. He seemed to want trouble, and apparently, was seeking to cause a riot."

FOLLOWS U. S. SUPREME COURT.

Columbus, O.—The state supreme court has followed the decision of the United States supreme court in setting aside the Kansas law which made it illegal to discharge a worker because of membership in a union. The Ohio court affirmed the judgment of the Hamilton county (Cincinnati) court of appeals in the suit of a member of a union dual to the bona fide Boot and Shoe Workers' union, who asked redress because he was discharged. Both Ohio courts hold with the United States supreme court that a worker can quit for no reason or any reason, and the employer has the right to discharge.

Trade unionists in this state say that even were the law upheld, anti-union employers would find ways to evade it, and these workers point to the fact that hostile employers do not usually make it a practice to give membership in a union as the reason for dismissal.

The decision is used as an argument for the necessity of strong organization among the workers to protect them from being victimized.

The Ohio statute was passed in 1892. The Ohio supreme court was divided on the question.

PROTEST LAWSON'S TRIAL.

Scranton, Pa.—The Evening Times of this city makes vigorous protest on the verdict at Trinidad, Colo., in the case of President Lawson, of the Colorado district, United Mine Workers of America.

The editor says, in part:

"Lawson was charged with the murder of a deputy. Nobody saw Lawson fire the shot that killed the armed deputy. Nobody heard Lawson issue orders to shoot the deputy. Nobody testified that Lawson had anything to do with the incident.

"Lawson was one of hundreds of men, women and children who had been put out of house and home by the operators and lived in tents on the hillsides.

"Because of his position as a union officer, Lawson was recognized by the men as their leader. On the purely theoretical ground that Lawson was the commander of the men, some of whom fought with the deputies, Lawson was accused of the worst crime a man can commit, and put on trial.

Lawson's life was to be the forfeit. A jury found him guilty. The state calls it a great victory for law and order.

"Remembering the massacre of Ludlow, the activity of hired company thugs as

deputies, the wild excesses of the militia, the stupidity and the cowardice of the state, and the conditions imposed upon men, women and children by the operators with the consent of the state and in violation of the law, as has been expressly shown, the conviction of Lawson is a sickening perversion of justice and an outrage that adds another smear to Colorado's mean record."

"SPOTTERS" LAW ILLEGAL.

Boston.—It would be unconstitutional to pass a law in this state compelling railroads, before discharging or disciplining an employe, to permit him to make a statement in the presence of the person giving information.

This is the opinion of the state supreme court, which passed on the question at the request of the state senate, now considering a bill to regulate railroad "spotters."

The opinion, a majority one, answers three questions asked by the senate. The majority say: First, that the legislature may not enact legislation limiting the right of railroad corporations to discharge their employes for cause; second, that the legislature may not give railroad employes, as a class, privileges not enjoyed by the rest of the community; third, that senate bill 537 is unconstitutional.

Justices Loring and Crosby transmitted a dissenting opinion.

UNIONISM PAYS, IS WORLD STORY.

Melbourne, Australia.—Unionism is the best investment a worker can make, declared G. M. Prendergast, in an address before the Cold Storage Employes' Union, which started in 1908 with forty members, and has now enrolled 735. At one time wages were 6d (12 cents). The rates now are 1s 3d (31 cents) and is 4½d (33½ cents), with extra pay for overtime. The speaker showed that the annual dues of 26s (\$6.50) made possible an average increase of \$325 per year, "which was a long way better than any other investment."

ROADS' NEW REVENUE HIGHER.

Washington.—Net revenues per mile on 49,727 miles of Eastern railroads for March amounted to \$474 as against \$425 in March, 1914, according to a statement made by the interstate commerce commission. Railway operating revenues amounted to \$90,212,176 in March, 1915, as compared with \$95,975,347 in March, 1914; railway operating expenses, \$66,643,157, as compared with \$74,879,730; net revenue from railway operations, \$23,569,019, as compared with \$21,095,617; revenue per mile, \$1,814, as compared with \$1,935; expenses per mile, \$1,340, as compared with \$1,510; net revenue per mile, \$474, as compared with \$425.

LONE MINER DEFEATS COMPANY.

Wilkes-Barre, Pa.—Joseph Levanovage of Buck Mountain has won his fight in an arbitration court against the Lehigh Valley

Coal Company, which is ordered to pay him \$75 for time lost because of the dispute. Proceedings were conducted under the conciliation and arbitration agreement between the operators and miners. Judge George Gray of Wilmington, Del., decided the controversy, which had a different ending from the days when miners were unorganized and were discharged if they dared to protest.

CONVICT LABOR TO END.

St. Paul, Minn.—The long agitation against convict labor in the city prison broom making plant is bearing fruit. Commissioner Goss has assured a delegation of unionists he opposes the plan, and if he is supported by the city council it will be discontinued. Nothing definite can be done until the first of the year when council will compile a new budget. In the meantime, agitation will be continued.

PASS PRISON REFORM BILL.

Harrisburg, Pa.—The house of representatives passed without opposition a bill providing that convicts shall be employed in the manufacture of such articles as can be purchased by state and county institutions, thus removing them from direct competition with free labor generally. Provision is also made for the payment to the prisoners of a certain proportion of their wages, while the balance is to go to their dependents.

TO URGE PENSION THEORY.

Washington.—The Federal Retirement Association has been formed by navy yard machinists in this city. The organization will not be partial to any particular form of retirement, but will devote its energies to education, depending on Congress to work out a pension which it thinks best for federal employes.

VIOLATE LABOR LAWS.

Charleston, S. C.—On the complaint of state authorities, manufacturers and merchants in this city have been fined for violating the law regulating hours of labor for females. Sensational developments were expected in one case of women forced to labor more than sixty hours a week, but the accused employer pleaded guilty.

DO UNSKILLED EAT LESS?

Washington.—In her annual report, Constance D. Leupp, president of the Consumers' League of the District of Columbia, favors the creation of boards in each industry "to decide on what the lowest legal wage shall be, not for the untried worker, but for the adult, experienced girl and woman."

GERMAN MILLS USE WIND AND STEAM POWER.

A curious combination of ancient and modern power is seen in some sections of Germany where many of the mills are equip-

ped with windmills, much like those of Holland, as well as with modern engines using superheated steam, one serving as auxiliary to the other. One flour mill, which is typical, is driven by wind power

whenever possible, but is provided with an 80-horsepower engine which assists in furnishing the power when the wind power is lacking or insufficient.—Popular Mechanics.

Among Our Exchanges.

PAYING THE PRICE.

Whatever a man soweth that shall he also reap is a truth that cannot be disputed. Not only does he reap in kind, but he also reaps in proportion. There is no great excellence without great labor, and there is little achievement without self-denial. We must always pay the price. These truths are worthy of deep consideration; indeed, we cannot give them too much thought. They apply in everything that we undertake. Then let us apply them to the labor movement.

When we ask why labor is always at the bottom the answer is, because it has not paid the price. We have not done the things necessary to bring about better conditions. Had we done those things, happier results would have followed with mathematical certainty. It is true that we have done enough, and more than enough, and have suffered enough to have brought us the good times we long for. But our labor and sacrifice have not been devoted to our own advantage. Our time and toil have been given to make others rich.

Hence, we are not poor and destitute because we cannot and do not make enough to meet all of our reasonable needs, but because we do not give proper care to our own interests—to advancing our own cause. We build fine houses, but they are for the occupation or gain of men who have grown fat upon our toil; we erect and operate great enterprises, but the dividends come not to us, and we laboriously give our strength and skill to produce much more than enough to feed, clothe and shelter the whole family of mankind, but the distribution is unequal—somebody else gets the lion's share of what we produce.

Can anybody compel us to submit to this inequality in profit sharing by force or cunning, if we are wise and alert? Certainly not. Most of us would do the same thing if we had the chance. The blame rests solely with us—we are not willing to pay the price of justice.

Eternal vigilance is the price of liberty; it is also the price of justice.

There are a number of things that constitute the price of success in the labor movement, all of which are suggested by common sense and which may be easily done. Among these is the purchase of union made goods. This may not, in many cases, directly benefit you or your craft, and for that reason many union people are not careful about it, but it never fails to help the cause as a whole, and thus help all indirectly. Another thing of importance is the prompt and punctual attendance at union

meetings, especially meetings for the discussion of questions affecting the interests of union labor. Men in other callings never fail to attach great importance to such conferences, and, as a result, they reap the rich reward. The men who succeed in climbing up over our heads never fail to keep in close touch with politics, and they watch and endeavor to influence all legislation bearing upon their interests.

All union institutions, especially the labor press, ought to be liberally and constantly sustained. Look at the numbers, wealth and wide circulation of the publications that are not friendly to the cause of labor. We spend thousands, yes, millions to make them rich and powerful, while we often fail to pay the price of our own publications. What can we expect of the harvest?—The Amalgamated Journal.

REACTIONARY LEGISLATION.

With the exception of the National Congress, a vast majority of the law-making bodies of this country have seemingly gone out of their way in an effort to destroy by repeal the progress made by the enactment of laws during the past few years which had for their intent the betterment of social conditions generally.

In no section of the country has this condition been found to exist so acutely as in New York state, where, under the pressure of the party "whip" legislation of the most reactionary character has been jammed through the legislature regardless of the protests made against this action, by the people.

During the past three years a vast amount of constructive legislation has been enacted which has been of great benefit to the workers of New York state, much of which has aided in bringing the Department of Labor to a very high state of efficiency, and to destroy these laws seems to be the particular job of the Republican party, which is temporarily in power in the legislative and executive branches of the state government.

Not content with nullifying the state fire laws in relation to factories by abolishing the State Fire Marshal's office and other "ripper" legislation of the same character, nor with the amendment to the compensation law which virtually gives complete control to the casualty companies in the adjustment of claims in case of injury, a bill is now before the legislature which to all intents and purposes abolishes the effectiveness of the Department of Labor and the Compensation Commission by combining

these two important branches of the public service.

The sinister motive behind this legislation is receiving condemnation on every hand, and it is being openly charged that the party in power is paying political debts to the casualty companies, manufacturing and real estate interests, who will be the beneficiaries of the "ripper" laws that are being enacted.

The attitude of disrespect toward the wishes of the people which is being exhibited by the governor and the legislature is, to say the least, unbearable, and it is predicted on all sides that when this band of reactionaries again appeals to the people for their suffrage, many of them will be relegated to private life, where they properly belong.

Organized labor, its friends and sympathizers will fight to the last ditch to preserve the laws which have been enacted for the preservation of life and limbs of the workers, and when the day of reckoning comes for those who would destroy these laws with impunity, the hosts of labor will not be found wanting.—The Garment Worker.

A GOOD FIGHTER.

The most abused man in the ranks of organized labor is the one who tries to better the conditions of his fellow workers. It does not matter how sincere he is or whether he is paid for the time he loses, and it is often the case that the man who does the most work in this line is the less thanked, not to say paid. Employers call him an agitator and assert that if it were not for him they could hire help cheaper. Employers do not stop to think that the poorest paid people in the land today are the officers of labor organizations. If some of them had to do the work gratis that is performed by good and true union men they would throw up their hands in holy horror.

The conservative labor agitator is a benefactor. It is through his efforts that fair wages and short hours are granted; it is he who fights the battles of his many fellows, and it is he who is first discharged when occasion requires a laying off or a reduction of expenses. He is a bold man—in the eyes of the employer. And yet this same agitator may have a large family to support, and the time he loses is his own. A labor organization without an agitator might as well not exist.

The men who stump the corridors of the legislative halls looking after legislation are dubbed agitators. What would you call the well paid lawyers who look after the interests of the corporations around the capitol? They must be called legal gentlemen. It is only the man who has the courage to voice the sentiment of the oppressed toiler who is an agitator.

These words are from an exchange and every honest man, whether in the ranks of labor or outside, must acknowledge the truths contained in them. There is one sad fact, however, not contained in the fore-

going, and that is that the laboring man who does the most for the interest of his fellow toilers is frequently the recipient of greater abuse from those same "fellow-toilers" than from the employers. The sincere, honest, unselfish union man, whose thought and time and efforts are devoted to the interests of all, often meets the basest ingratitude. Under such circumstances the progress made by unionism is truly wonderful, but it would have been greater had we always been true to each other and thoroughly sincere and honest in the prosperity of organized labor. If there is any class of men among whom the spirit of true brotherhood should exist that class is organized labor.

Unionism stands for all that is grand and noble in men. Our mutual interests demand that we act the part and be union men in thought and deed as well as in name.—Exchange.

PEACE HATH HER VICTORIES.

May Day paid its annual visit to Rochester this year in comparative peace, and it left behind a heritage of good will in which we all may share.

While other parts of the country have been torn by industrial strife, this city remained practically free from any serious labor disputes.

The cloud of a possible trolley strike was cleared away by an appeal to reason, and the happy ending of the painters' difficulty, under the guiding hand of Mediator McManus, as well as the friendly negotiation of a new agreement between Division 282 and the local railway company, were proof indeed that the principle of "give and take" was uppermost in the minds of both workers and employes on May Day, 1915.

The public is usually well informed on the horrors of war, but hears little about the victories of peace.

Numerous contracts between Labor and Capital, affecting thousands of our people, have been quietly renewed during the past few days, and the benefits involved must in the long run contribute much to the prosperity and progress of the city.

Surely the way of the mutual agreement is the best way after all.—Labor Herald, Rochester, N. Y.

O, YOU KNOCKER, YOU SOREHEAD, READ THIS.

Salt Lake Times: After God had finished the rattlesnake, the toad and the vampire, He had some awful "substance" left with which He made a "knocker." A knocker is a two-legged animal with a corkscrew soul, a water-sogged brain and a combination backbone made of jelly and glue. Where other people have their hearts, he carries a tumor of rotten principles. When the knocker comes down the street honest men turn their backs, the angels weep tears in heaven, and the devil shuts the gates of hell to keep him out. No man has the right to knock as long as there is a pool of water

deep enough to drown his body in, or a rope to hang his carcass with. Judas Iscariot was a gentleman compared to a knocker, for after betraying his Master he had enough character to hang himself, and a knocker has not.

ONE MORE FEATHER IN THE PLUMAGE OF THE I. W. W.

Robert D. Watson has been arrested in Butte, Mont., charged with robbing the Murray bank.

Watson has been the spokesman for the I. W. W., who were largely responsible for the destruction of the Butte Miners' Union Hall nearly a year ago, and was the pal of "Muckie" McDonald and "Joe" Bradley, who are serving time in the penitentiary at Deer Lodge.

After Watson was arrested it was discovered that he was a Burns detective. Watson was the loudest and most violent shouter for the seceders and I. W. W. in Butte, and the fact that he is on the payroll of the Burns agency puts another feather in the plumage of the I. W. W.

The claim is made that Watson is guilty of a number of holdups, and at present his chances are bright to graduate with high honors in the same institution that has been honored with such celebrities as McDonald and Bradley.—Seattle Union Record.

JOHN BUNNY.

In this day and age nearly everyone goes to the "movies."

And throughout this broad land there is weeping tonight among those who go to the "movies," among those who help make the "movies," and among those who manage the motion picture machines that make the "movies" move.

John Bunny, prince of all movie characters, is dead!

He passed away this week, and his legion friends, for his friends were legion, are sad.

John Bunny with his optimistic smile brought gladness to millions of hearts that were otherwise made sad in this mad scramble for existence.

But John Bunny was something more than a "movie" actor.

Many Detroit union men, and particularly the members of the Motion Picture Operators' Union, have good reason to remember this man who made the whole world laugh.

John Bunny became a union man while playing at a theater in this city.

That was one night last year.

It was not a funny occasion for our dead union brother.

The occasion was most solemn for this man, who was paid a higher salary than the president of the United States is paid, for his acting.

He was being initiated into a labor union. Joining that labor union meant something to him.

It was an event in his life.

When he was presented with his membership card in the Motion Picture Operators'

Union, the card being of gold, the man who dried the tears of others himself wept.

He told the Detroit union men who were present his views of unionism.

He told them that their cause was just and that they should stand solidly together because they were members of the world's most progressive organization.

So that while every lover of the "movies" has reason to be sad tonight, Detroit union men and women throughout the land have reason to regret the passing of one who was a brother in this struggle for progress.—The Detroit Labor News.

A SOURCE OF DANGER.

The Massachusetts legislature is engaged in making a peculiarly reactionary record. Even Republican papers are commenting on this, and coupling it with New York. An explanation of the boldness of the reactionary element is offered by the Boston Transcript, a conservative Republican paper. The legislature is controlled by the senate. In the senate are thirty-three Republicans and only seven Democrats. And it takes a one-fifth vote to demand a roll call. According to the Transcript, there has been a gentlemen's agreement not to demand roll calls, which is, says the Transcript further, "the process commonly known as whispering measures to death."

It need not be said that it is a fundamental need of voters that they know the record of their representatives on any important measure. A deal of trading and downright disregard of constituents is possible under the viva voce vote system. For an instance take this from the news report of the Wisconsin assembly's vote on the Hambrecht bill which makes an open attack on the civil service:

"The bill was recommended to be killed by the state affairs committee. But the assembly by a viva voce vote which seemed to be pretty much all one way, ordered it engrossed. Members who uphold the high competitive system seemed to be caught napping and did not even ask for a roll call. The bill will be up for passage next week."

Obviously no Wisconsin constituency has any way of discovering what was the stand of its representative on a matter so important as this effort to weaken the civil service and make it more amenable to the spoils system.

In the face of this, it cannot but seem unfortunate that the assembly should have turned down with so little investigation a system of electrical voting which carried the prestige of having convinced the committee on accounts of the national house of representatives of its desirability, which has been invented by a Milwaukee man, and which would cut down by days the time taken up in each session by roll calls. At the same time, this would make it possible to put every member of either house on record on any measure without a chance for the complaint of wasted time.

Something needs to be done about time wasted in voting. Something needs to be done about the rich possibilities of the viva voce vote for deceiving constituencies.—Milwaukee Journal.

PRIDE AND SENSE.

Fine clothes, fine houses, fine cars may give pleasure, but they are no real cause for pride. Neither are fine intellect and great knowledge; the really great are thankful for what they know rather than proud of it. They realize how small a part of wisdom it is. You may be generous, giving largely to help others, but the feeling that others should admire you for it, that it sets you above anyone is no part of true charity. Beauty is a gift of nature to appreciate and be glad of, but even beauty carries no distinction to make one proud. It amounts to

very little if it is not backed by goodness of heart. Whatever your acquisitions or possessions, do not boast of them; for of all these things circumstances may deprive you. It happens often that "pride leaves home on horseback, but returns on foot."

Proper pride keeps a man from doing a mean act. It moves him to give others their due of profit and of praise. It never thrusts on the notice of others the good qualities one supposes he has or the wealth of which he is possessed. It is a pride that leads him to choose worth while companions, to avoid low things and coarse things, to pay his own way and be independent of others. It is this kind of pride that prompts a man to do his work well and faithfully, to be unwilling to take pay for slipshod work. It makes for uprightness and integrity. It is pride worth having.—Milwaukee Journal.

News of General Interest.

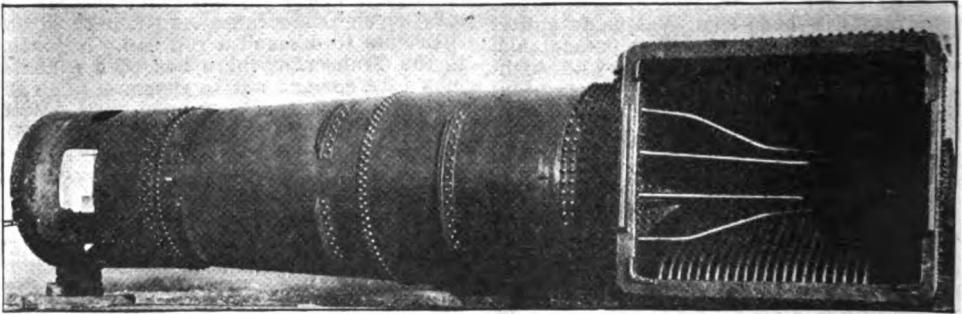

THE RIEGEL FIREBOX ON PACIFIC TYPE LOCOMOTIVE.

By Frank C. Perkins.

The accompanying illustrations, Figs. 1, 2 and 3, show the construction of a modern Pacific type locomotive with a special water tube boiler Riegel firebox, as developed by S. S. Riegel, Mechanical Engineer of the Motive Power and Equipment Department of

the Delaware, Lackawanna & Western Railroad Co., at Scranton, Pa.

The photograph, Fig. 4, shows one of fourteen of these engines built at Lima, Ohio, by the Lima Locomotive Corporation.

This locomotive, however, has a boiler equipped with a special form firebox. The boiler consists of a combination of the standard type of firebox and shell with a water

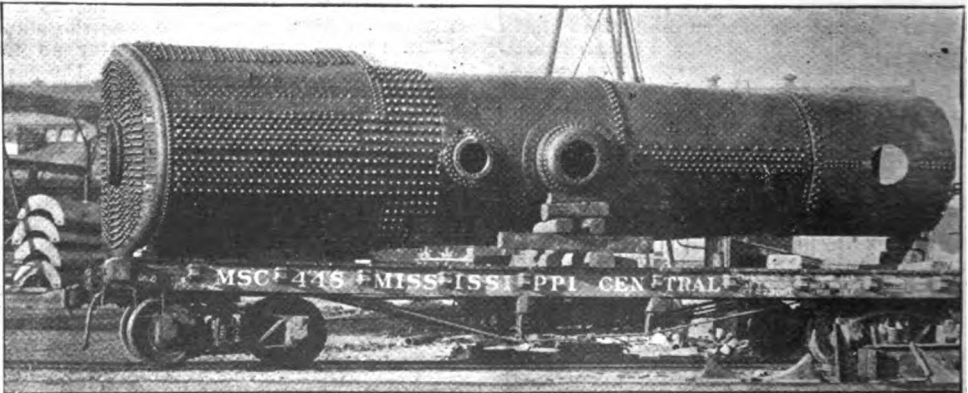

tube construction, which introduces a definite water circulation system. It has an installation of two nests of water tubes of sixty-six tubes each, placed right and left in the firebox over the grates, thus taking advantage of the water tube method of circulation with the object of providing definite cycles of circulation of water through the zones of greatest heat intensity, and locating the heating surfaces in the best possible manner.

The locomotive was designed for a standard gauge of 4 ft. 8½ in. and the diameter of driving wheels is 69 in., while the tractive power is 43,200 lbs.

The engine has cylinders 25x28 in. and the weight on trucks in working order is 50,000

sons who are already wage earners so as to increase their skill, earning power, and opportunities for advancement has long been a problem with educators and employers, as well as with wage earners themselves. The short unit course is designed for effectively solving this problem for certain groups of workers. It is not a short cut to the trade.

The short unit course is an intensive form of instruction in a limited number of lessons, which is intended to serve a specific need of a particular group. Each course deals with one part of the trade and is complete in itself. The courses include only what has been found to be of practical value in the trade. The material se-

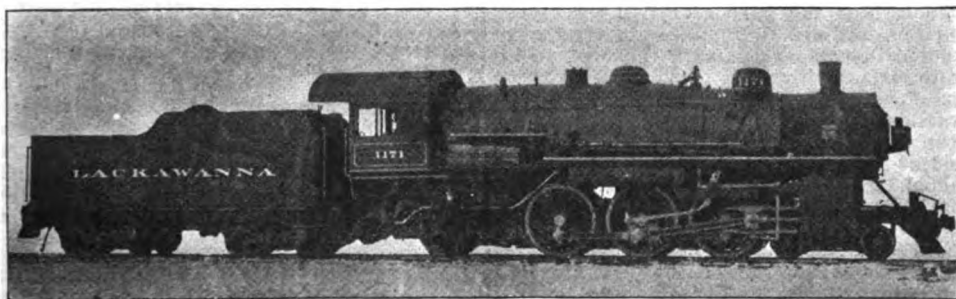

lbs., while the weight on drivers in working order is said to be 189,600 lbs. The weight on trailer truck in working order is 58,000 and total weight of engine in working order is 297,000 lbs., while the coal capacity of tender is 10 tons. The water capacity of tender is 9,000 gals.

It may be stated that the total weight of tender loaded is fully 165,500 lbs, and the total weight of engine and tender combined is 463,000 lbs.

The boiler pressure of this engine is 200 lbs. and the grate area 69 sq. ft. The diameter of boiler is 78 in. and a firebox measures 89x111 in., while factor of adhesion is 4.39.

The heating surface of the water tubes measures 471 sq. ft., and the heating surface of the fire tubes 3,177 sq. ft., while that of the arch tubes is 24 sq. ft., and the total heating surface of firebox is 783 sq. ft. The boiler has a total heating surface of 3,960 sq. ft., of which the superheater heating surface is 740 sq. ft., and the heating surface of firebox and combustion chamber is 288 sq. ft.

U. S. DEPARTMENT OF LABOR BUREAU OF LABOR STATISTICS.

Short Unit Courses for Wage Earners and a Factory School Experiment.

Short unit courses for wage earners and a factory school experiment is the title of Bulletin No. 159, just issued by the Bureau of Labor Statistics of the Department of Labor. The best method of assisting per-

lected is taught by a practical teacher, with references to its adaptability to the trade needs of the particular group. By eliminating all unnecessary preparatory work, the courses economize the time of the pupil.

A common weakness of the courses frequently offered for wage earners is that they are laid out to cover three or four years, and only a few pupils remain in school long enough to complete the course. The short unit course meets the difficulty by dealing with one specific thing in each course and by making the unit so small that the pupil will be able to complete it within the time the school can probably hold him. If the unit course is laid out for ten lessons, the pupil who remains during the course gets all the school has to offer on a specific topic. By offering a series of short unit courses on the same subject, experience goes to show that when one course is completed the pupil is likely to return for the next one, and thus actually remains in the school longer than he would if the same work were laid out in the form of a continuous course. . .

The method of instruction by short unit courses for wage earners has proved successful in many localities. Examples of such successful work are the courses for specialized machine hands in the evening classes of the Newton, Mass., Trade School, those for piano tuners in the Murray Hill Evening Trade School, New York City, those for machine hands in the furniture industry in the Evening Trade School of Grand Rapids, Mich., and those for steam engineers

in the Industrial School at New Bedford, Mass. Numerous detailed examples of the short unit courses in successful use are given in this Bulletin.

One great advantage claimed for the short unit course method is that out of a study of the needs of the worker new courses may be readily developed. Some of the methods already in use, particularly those dealing with the more ambitious, better prepared, and abler workers engaged for the most part in highly skilled trades have long stood the test of experience.

This bulletin also contains a brief study showing the effect upon the earnings of illiterate immigrant girls in a New York City white goods factory as the result of instruction in the elements of English and arithmetic given in an experimental factory school. For the purposes of the comparison the earnings of 10 illiterate girls were studied in comparison with those of 10 literate girls, both groups of which were made up of girls of corresponding ages and of practically the same experience in the work upon which they were engaged. In a period of 32 weeks prior to the opening of the school, the average earnings per hour of the literate girls exceeded those of the illiterates by 3.7 cents, equivalent to \$1.85 per week of 50 hours. Throughout the period of school instruction the illiterate girls showed a steady increase in earnings per hour. At the end of the course of 16 weeks, their earnings had increased 2.7 cents an hour, or \$1.35 per week. During the same period the earnings of the 10 literate girls remained practically unchanged. The experiment was thus regarded as highly successful, both from the standpoint of the employer and of the employe.

DON'T WORRY OVER MISTAKES.

Perfect People Run Errands and Count Columns of Figures for Those Who Take Chances.

(From the Rockford, Ill., Register-Gazette.)

The people who make mistakes lead the world.

The perfect people work for them, running errands and counting columns of figures.

Only trifles are always true. Every great and serious truth has an obverse side which is also true.

Prof. William James was the greatest psychologist of our time, but the best he could do in defining truth was this:

"The truth is simply what will work."

Whatever is may not necessarily be right, in spite of Pope; but whatever is, is. That is the main point. And it is every man's job to accept the is-ness and get down to business.

Most men have the wrong location, have taken up the wrong profession, have failed to improve the opportunities for education they had in youth, have not married the women ideally suited to them, have not

the money, influence and position they need to show what's in them.

And they are of two classes. One class sits around the loafing places and tells its woes, and whistles, and pities itself. The other plucks up, forgets it, takes the situation as it is and makes the best of things.

The genius is not the man who never made mistakes, who had his chance thrust on him, who was endowed and all that; he is the man who had no chance and was not gifted, but who took the raw material of life and fate as he found it and made something fine out of it.

The only perfect person you will ever meet is the perfect fool.

The faultless—they are the biggest frauds of us all.

A KANSAN TABULATES READY REFERENCE FOR PARCEL POST SERVICE.

Merchants who have no rate table for parcel post packages need not worry if they will simply follow the formula given below. An enterprising Kansan who is good at mathematics has figured out the table and test proves it to be absolutely correct. It is: Postage in the first and second parcel post zones would be the number of pounds that the package weighs plus 4 cents.

In the third zone twice the number of pounds the package weighs plus 3 cents; in the fourth zone four times the weight of the package plus 3 cents; in the fifth zone six times the weight of the package plus 2 cents; in the sixth zone eight times the weight of the package plus 1 cent; in the seventh zone ten times the weight of the package plus 1 cent, and in the eighth zone the postage would be twelve times the number of pounds of the package.

CARE OF THE BABIES IN SUMMER.

Nursing the Baby Prevents Summer Diarrhea.

(First of a series of articles on the Care of Babies during Hot Weather, prepared for the Journal by the Children's Bureau, U. S. Department of Labor.)

A mother may shield her baby from suffering and illness in many ways. Her wise and loving care is never so invaluable as in the first year of the baby's life. In this country thousands of babies under one year of age die during the summer because mothers who love them do not know how to take care of them.

No other one thing a mother can do for her baby means more to him than to feed him at her own breast. Babies who are fed entirely at the breast usually do not have diarrhea, unless overfed, but bottle-fed babies are very likely to have this trouble, even if their milk is carefully prepared. This is true at all seasons of the year, but it is especially important in summer when the

heat and flies make bottle feeding so dangerous.

The mother knows that if she gives her baby the breast she is giving him—

1. Pure milk—never sour.
2. Fresh milk, made and used as needed.
3. Milk of the same temperature throughout the feeding.
4. And, most important, milk made especially for and especially adapted to the needs of the baby.

If she feeds him from a bottle, she is not sure of any of these things, for in no way can cows' milk be made as good as breast milk.

A mother can usually nurse her baby if she has been properly cared for before the baby's birth and at the time of birth, and no mother who wants to give her baby a good start will consent to deprive him of breast milk, at least during the first few months of life.

After the mother's milk comes, usually on the third day, the baby may be nursed every three hours, at 6 and 9 a. m., at 12 noon, and at 3, 6, and 9 p. m., with one feeding during the night. On the four-hour plan the nursing will come at 6 and 10 a. m., and 2, 6, and 10 p. m. In the intervals she should give him a little water which has first been boiled and cooled.

When the baby is four months old he should no longer be nursed at night, and at six months the mother should begin to lengthen the time between feedings a quarter of an hour each week until the length of time between nursings is four hours. If the milk is plentiful, the breasts should be nursed alternately, but it may be necessary to give both breasts at one feeding in order to satisfy the baby. The baby requires no other food, save breast milk and drinking water, until he is eight or nine months old.

In some cases the mother may not have enough breast milk to satisfy the baby. It is then necessary to give one or more bottle feedings a day in addition. Later articles will give directions for this kind of feeding, as well as for weaning and artificial feeding.

The nursing mother should have plenty of nutritious food. She should eat what she likes, provided her food causes her no indigestion, for if the mother is well the baby will usually be well. But if the mother has headaches or gas on the stomach or bowels, or has a coated tongue, she is not properly digesting her food, and she should try to find out what is causing the trouble.

Fat, greasy and fried foods, such as doughnuts, pancakes, baked beans, pies, heavy puddings, and dumplings, and insufficiently cooked cereals, are among the foods that may cause indigestion.

Fresh, well-cooked vegetables, good soups, bread and butter, milk, eggs, meat, fish, poultry, and fruits should form the principal part of the diet of a nursing mother. All

good food is milk-making food. It is better to do without tea or coffee, unless the mother has always been accustomed to them. If so, she should cut down the amount to one cup of each drink per day. Cocoa may be used in moderate quantities, but milk, both sweet and buttermilk, and plenty of cold pure water, are the best drinks for the nursing mother.

The nursing mother should have plenty of sleep at night, and should learn to relax and rest whenever the baby nurses. As far as possible she should be relieved of the heaviest part of the household work, because if she is tired and worn the baby will not thrive as he should.

The nursing mother should have a full movement of the bowels every day, but should not use medicine to induce an action unless absolutely necessary. Ripe, raw fruits, stewed rhubarb and prunes and well-cooked oatmeal and other cereals are laxative. Graham and bran breads are most useful in constipation. Bran bread is made as follows:

- 1 cup of cooking molasses.
- 1 teaspoonful of soda.
- 1 small teaspoon of salt.
- 1 pint of sour milk or buttermilk.
- 1 quart of bran.
- 1 pint of flour.

Stir well, and bake for one hour in a moderate oven. It may be baked as a loaf, or in gem pans, as preferred. The bread should be moist and tender, and may be eaten freely, and it will usually have a good effect if used every day for weeks.

To keep the breasts from becoming sore, they should be washed with warm water and good castile soap every night and after each nursing. For a few weeks before the baby is born the nipples should be washed in this way every night, and covered with vaseline.

STANDING OF CANDIDATES IN LOS ANGELES LABOR TEMPLE CONTEST.

The "European Tour" Contest, inaugurated the first of the year by the Los Angeles Union Labor Temple Association, is attracting wide-spread attention, a number of the candidates in the field bearing international reputations as labor leaders.

April 30, George L. Perry, president of the International Printing Pressmen's Union, and Fred C. Wheeler, of the Carpenters' organization, were tied for first place, with A. W. Thomson, of the Printers a close second; Mrs. Frances N. Noel of the Woman's Trade Union League, comes third, and C. F. Grow of the Machinists, fourth. The other candidates and their respective standing follow: J. E. McGlory, Iron Workers; E. J. Brais, Tailors; Robert Hesketh, Cooks; James J. Doherty, Bakers; Thomas E. Burke, Plumbers; Matthew Woll, Photo Engravers, and Margaret Daley, Woman's Union Label League.

By this time it is generally known that this contest was inaugurated the first of the year by the Los Angeles Labor Temple Association for a dual purpose. First to sell sufficient stock to retire mortgages on the Labor Temple property, and second, to send two people to Europe at the close of the war for the purpose of educating the prospective immigrant to the necessity of coming to America in a prepared condition, and the inevitable fate of those who arrive on these shores in an impoverished state.

In the opinion of those who have given the matter serious consideration, now is the time to prepare to meet what will soon prove a serious problem in the industrial centers of the United States, particularly that portion known as the Pacific Slope. That there will be a great influx of foreign immigrants at the close of the European war, by way of the Panama Canal, there can be no question. That this vast horde will be a menace to the future prosperity of the American workingmen, unless some educational steps are taken along the lines of the necessity of coming here in a prepared state, cannot be questioned.

The Board of Directors of the Union Labor Temple Association, believing the time has arrived to make preparation, has inaugurated its "European Tour" Contest with this thought in mind. The Association believes it is up to all organized labor to lend a hand in this praiseworthy undertaking by purchasing Los Angeles Labor Temple stock and voting it in such a manner that the best possible representatives may be selected to carry on the work.

The Los Angeles Labor Temple is a seven-story brick and steel building located right in the heart of the business section of the city, and is valued at \$350,000. Only 94,000 shares have been sold to date. The stock is \$1.50 per share and the voting strength is cumulative—the larger the number of shares the greater the voting strength. For further information address "Contest Committee," Room 203, Labor Temple, Los Angeles, Cal.

DANGER SIGNALS OF TUBERCULOSIS.

In a previous article, it was stated that nearly everybody has tuberculosis at some time or other during his lifetime. Autopsies on people have shown that hardly a single human being reaches mature life without a scar on his lungs or elsewhere showing where tuberculosis had attacked him, and he, by his normal resistance and vitality, had warded off the continuation of the attack.

Because tuberculosis is so wide-spread, every man, woman and child should give the most careful attention to those signs of the disease which point out danger. The treacherous disease germs may enter the body in early childhood and may not cause any serious trouble for ten or fifteen years. Then, all of a sudden, when the body is

weakened by overwork, worry, sickness, or bad living and working conditions, these sleeping germs wake up and become active in the destruction of the lungs or other organs. The working man or woman, therefore, cannot be too careful in the safeguarding of health and in watching out for those symptoms which indicate that the disease of tuberculosis is actually present. What, then, are some of the danger signals and what should be done about them?

(1) First of all, there is a cough that hangs on and will not clear up. If it lasts for a month or longer, it is a red light, a danger signal, which you cannot afford to ignore. It may start with wet feet or some other insignificant circumstance, but no matter how the cough started, if it does not go away, see your doctor at once. Colds frequently weaken the bodily tone and resistance, so that it is easy for the lurking germs to get a foothold.

(2) Loss of weight accompanied by a loss of appetite and a certain amount of "stomach trouble" is another danger signal, which you must not pass unheeded. Sometimes loss of weight may come from some other cause than tuberculosis, but it pays to be on your guard. You may not have a cough, and you may experience very little trouble except a sort of chronic weariness. You ought to know what your normal weight should be. If you begin to lose five, ten, or more pounds without any apparent reason, look for sound medical advice at once. Sometimes with loss of weight goes a loss of appetite, and trouble with bowels and stomach, even running to diarrhea. Whether you are losing much weight or not, look out for this danger signal. It is a warning that something is wrong.

(3) Then there is that run-down, all-the-time-tired feeling. Most people have days when they feel unusually tired, for some reason or other. Such an occasional period of "spring fever" or "lazy liver" may not be at all dangerous. But when every day for two or three weeks you hate to get up and dread to do anything but lie around and be lazy, there is danger ahead. This is Nature's warning to you that some enemy inside your body is sapping your vitality. Don't ignore the warning signal!

(4) Any one of the three symptoms just mentioned may occur singly or all of them may come at one time. When, to any or all, there is added a fever in the late afternoon or during the night, accompanied possibly by sweats, beware of this danger signal. It is a bright red flag which Nature waves before you, cautioning you to give immediate heed. Anyone's temperature may rise at times, some people's more easily than others. But for a week, every afternoon about four or five o'clock you've felt feverish, or when night after night you wake up in a dripping sweat, you may rest assured that there is nothing normal about that. Go to your doctor at once and tell him about it. You may have no cough and no other

sign of disease, and this may be the only warning you'll get. Give heed to it at once.

(5) If you have a cough and in spitting you find streaks of blood in your sputum, you may rest assured that something is wrong. It may not be a direct sign of tuberculosis, but whatever it is, you should attend to it at once. You cannot afford to waste time putting it off. Nature may give you that more emphatic warning of the presence of tuberculosis, a hemorrhage of the lungs. If so, don't be scared unduly. It is a danger signal, and if you heed it, you may be safe.

There are other danger signals, some which you can see and some which only a trained physician can detect. Your safety lies in getting medical attention as early as possible. Tuberculosis can be cured if it is discovered in time. The time to discover it is when the first symptoms show themselves. Don't take chances with Death. You'll lose every time.

Go to a good doctor, if you notice any of these danger signals, and insist that he examine you stripped to the waist. If you can't afford a doctor, go to a free clinic and be examined. It may cost a few dollars to be examined, but it may save you hundreds of dollars, untold suffering, and possibly your life and that of your wife and family.

"SAFETY FIRST" is a motto that applies to tuberculosis, especially when it is first showing itself.

OIL STORAGE TANK FIRE EXTINGUISHING BY A UNIQUE FOAM SYSTEM.

By Frank C. Perkins.

The accompanying illustrations and drawing show a most interesting automatic petroleum fire extinguisher foam system for oil storage tanks. The automatic extinguishing of fires produced by the explosion or combustion of inflammable vapors, gases or oils, has been a subject of study and endless experimentation for over a decade by chemists in Milwaukee, Wis., who demonstrate to the petroleum using world that they have successfully solved the problem.

It is of interest to note that the delegates to the convention of the National Fire Protective Association in Chicago, witnessed a wonderful fire test of these devices. A tank 27 feet in diameter was erected especially for the convenience of the engineers associated with the Underwriters' Laboratory? Sixty gallons of gasoline were floated upon the water contained in the tank. Assistant Fire Marshal Seyferlich, of the Chicago department, stated in referring to this test, "There was a gale from the northwest at the time. In ten and one-half seconds from the dropping of a lighted torch into the tank, the links fused, and the foam burst from the standpipes. In 12 seconds from the appearance of the foam the fire was entirely out."

Another test of the apparatus was made at the Standard Oil Company's Bayonne Refinery. The equipment of the 40 foot diameter tank, roofed, was as follows: Four iron standpipes, 30 inches in diame-

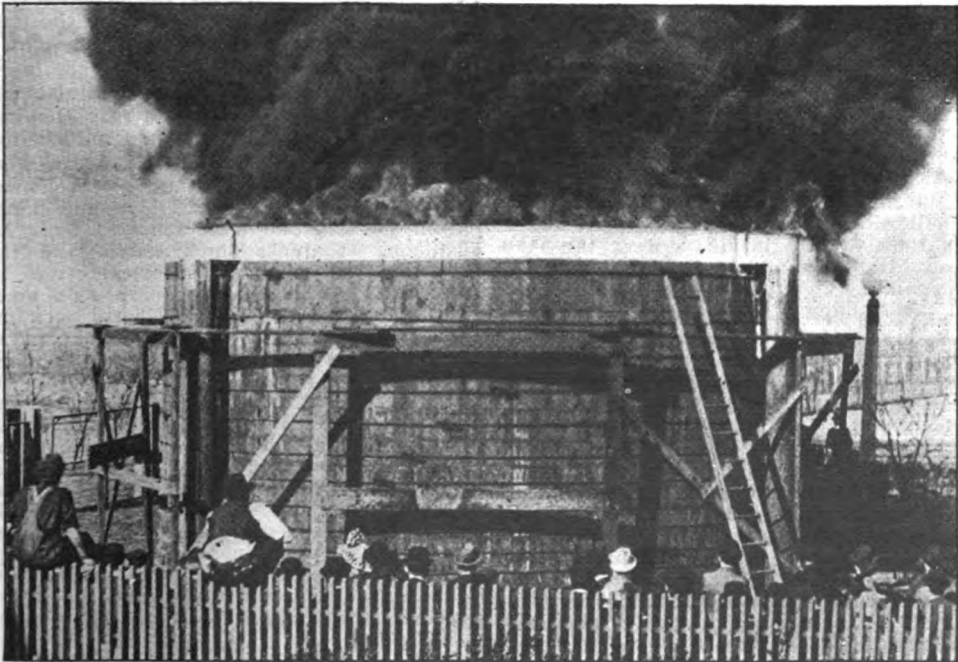

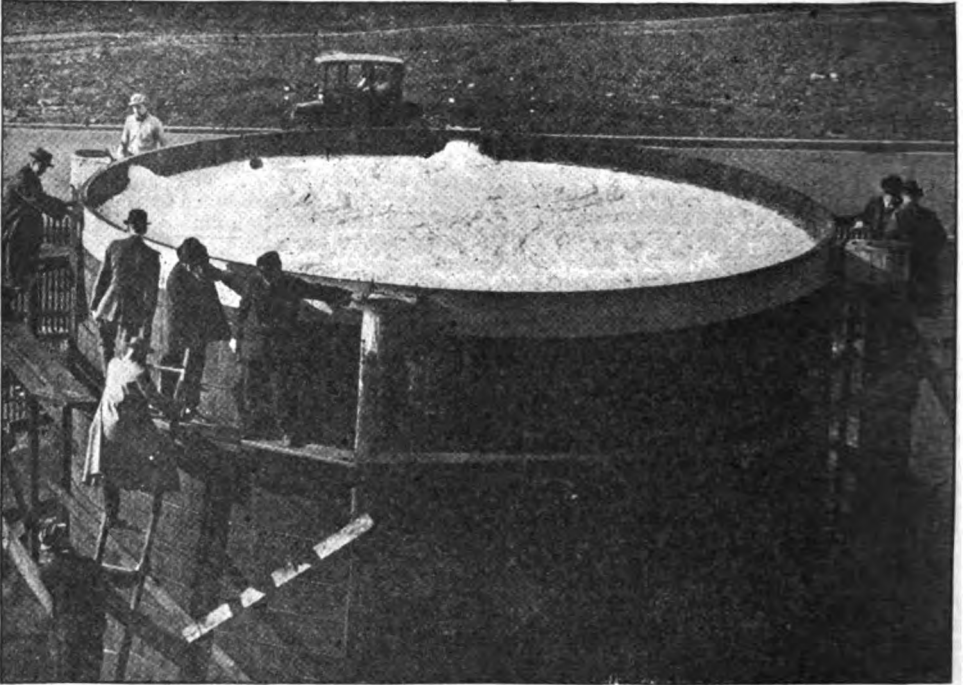

ter the height of the tank, were arranged outside the tank at intervals of 90 degrees of a circumference of same. There was a direct outlet into the tank from the standpipes about 12 inches wide by 8 deep, at the top of the wall of the tank. The standpipes contained about one gallon of chemical solution for every square foot of oil surface.

It may be stated that in the tops of the standpipes were suspended lead-lined thimbles. These contained the acid. The acid containers were suspended by means of a trap. The triggers are controlled by a cable having standard fusible links every two feet beginning at the bottom of the inside of the tank. This cable can be drawn over a pulley operating on a bracket riveted to the tank on the inside wall at the man-head. It inter-connects on the outside and immediately under the roof of the tank with all the standpipes.

It is pointed out that the controlling cables and fusible are so arranged as to permit frequent inspection. Installation is easily and simply made without endangering the lives of employes. The tank was filled with water to within three feet of the top. Three thousand gallons of Mexican crude and some naphtha were floated thereon. A torch was applied. The links soon fused, the acid containers or thimbles dropped into the chemical solution in the standpipes and the foam started instantly in a vast stream into the tank. In nine seconds the fire was automatically and completely extinguished. The fire had been smothered under 14 inches of foam.

Later there was made by the Standard Oil Company, another test on the same tank. The roof and the automatic devices were removed. It was arranged to operate the standpipes by hand from 75 feet of cable attached to the weights at each standpipe, thus releasing the acid containers when necessary. The water in the tank was lowered six feet. It was thought a severe fire might burn up the foam in its descent from the mouth of the inlet and prevent its swift delivery across the surface of the oil. Again 3,000 gallons of Mexican crude and 100 gallons of gasoline were floated upon the water. The torch was thrown into the tank. The flame and smoke from the gasoline were followed by great balloons of thick, black smoke and far-reaching flames from the Mexican crude. A breeze from the Atlantic Ocean soon made the fire look dangerous. There were billows and swirls of fire and smoke. The sight was as though a volcano, from many craters, was vomiting the mess within its confines. Soon the steel plates of the tank were red hot. The paint peeled and scaled in sheets. In just five minutes the chemicals from one standpipe were released. The foam did some extinguishing but it was evident that the other standpipes would soon have to be released. There was scarcely an eye-witness of the awful fire at this time who did not believe that it was beyond Erwin's control and that other means of extinguishing would have to be used.

It is stated that the three remaining stand-

pipes were released thirty seconds later and the fire was immediately and completely put out in just one minute after the order for the release of the standpipes was given by the Standard officials. The test proved the efficiency of the equipment. It demonstrated the completeness of the salvage, the lack of damage to the tank or appliance and that the standpipes needed only to be recharged with chemicals, to be again made ready for fire extinguishing service.

LABOR LEGISLATION OF 1914.

The annual summary of labor legislation in the United States prepared by the Bureau of Labor Statistics, which appears as Bulletin 166 of that Bureau, represents the activities of 17 legislative bodies in this field in the year 1914. Four of these met in extraordinary session, two of them enacting no labor laws. Compared with the current year, for which the work of 49 legislatures will have to be reviewed, this was an "off year" for the majority of state legislatures, so that the volume of output should be compared with that of 1912, though the number of extra sessions brought the total of the law-making bodies meeting that year up to 24. The tendency of this class of laws to increase in bulk that has been in evidence for a number of years is manifested in the fact that the 24 bodies in session in 1912 furnished but 187 pages of bulletin text, while the 17 meetings in 1914 provided approximately 200 pages.

As at other times, the laws relating to the employment of women and children are most numerous, 26 separate enactments affecting 12 jurisdictions falling under this head. One of these was the 8-hour law for women in the District of Columbia, enacted by Congress. If to this number be added the factory regulations that are often indirectly due to the presence of woman and child workers in industrial establishments, the public interest in this class of employes would appear to be great and influential. Occasionally, however, a bit of regressive legislative action is found, as in the Maryland statute reducing the age for children in street trades, or that of Mississippi fixing a lower age for the regulation of the hours of labor of children in cotton and knitting mills than is provided in other industries. But on the whole there is a steady advance in the States named, as well as others, in the direction of better protective legislation for the classes of persons who are, as the Supreme Court has pointed out, in need of special legislation that their rights may be preserved, and on whom the future of the race depends.

Masculine interests were looked after in 1914 in laws requiring frequent wage payments by public-service corporations and the redemption of scrip or coupons in Mississippi, the weighing of coal before screening in Ohio, and regulating the work time

of stationary firemen in Louisiana, and of workers in compressed air in New Jersey. A railroad "full-crew" law was enacted in Mississippi, and one was repealed by referendum in Missouri, these being the only states acting on this subject for the year. The state of Kentucky adopted a new mining code, and the Wisconsin Industrial Commission drew up a set of regulations for the protection of workmen engaged in building operations.

The subject of workmen's compensation received attention from three or four legislatures by way of amending acts, while new laws were enacted in Kentucky, Louisiana and Maryland. In the last named state the law superseded an earlier enactment which had been entirely inoperative, while the Kentucky law was found constitutionally defective before the date when it was to come into operation.

The Bulletin is in effect a supplement to the general compilation found in Bulletin No. 148, and Bulletin No. 126 which contains earlier compensation laws, both of which appeared in 1914. The value and, indeed, the necessity of these continuing publications as aids to anyone desiring to keep in touch with the large and growing body of labor legislation is obvious.

DEVICE KEEPS TRAIN SAFE.

(New York Letter to the Cincinnati Times-Star.)

President Ralph Peters of the Long Island Railroad is conducting elaborate experiments with what seems, up to this time, a marvelous device for the prevention of railroad collisions. It was invented by a telegraph operator in the Hotel Knickerbocker, and Proprietor Regan of that hostelry is financing the development of the device. Guests of President Peters's private car who saw the invention in operation this week could hardly be brought to believe that it was entirely automatic. And you couldn't blame them much, for this is what they saw:

Turned the Engine Loose.

The locomotive attached to the private car was started at twenty-eight miles an hour in pursuit of a freight train. The engineer, after setting his levers for full speed ahead, lighted a cigar and sat at the back of his cab. When a collision seemed about to occur the locomotive's whistle blew, the steam was turned off and the air brakes were thrown on. The "special" came to as quick and timely a stop as if the engineer had foreseen danger and acted to avert it.

The device can be used only where the block system has been installed. But it makes the block system automatically effective. There was no dependence upon human fallibility. At each block junction two short stretches of third rail take the contact of a shoe, attached to the engine. If the block ahead is empty there is no effect from the contact. If a train, moving

or stationary, however, is in the block which the engine is entering, the shoe picks up a current powerful enough to operate three electric devices on the engine. One of them blows the whistle, another throws on the air brakes and the third shuts off the steam. The devices operate with the same effect if there is a broken rail in the block which is being entered or—which is of great importance—if a switch is thrown behind the train. Thus a train may be stopped almost instantly by a switchman after it has passed him.

Invention Has Stood All Tests.

President Peters says that the invention up to the present time, has stood every test to which it has been put. It seems practical in every way. However, there will be no chance of its adoption for actual use until the experiments have continued for some months, both on the Long Island and the Pennsylvania railroads. The inventor is a young Italian, Anthony J. Casale. He has been working for fourteen years to perfect his device, having begun work on his first model while he was still a school boy.

TAKE A LOOK AT YOURSELF.

What is your normal attitude toward yourself? Much depends upon this. When you look at the great, wide, world and then at yourself in your own little center of it, how does it impress you? That is to say, are you a constant source of surprise and wonderment to yourself, which causes you ever and anon to halt in your tracks, look back over the road you came and marvel that you were able to make it?

Or do you take yourself for granted and consider that it is the most natural thing in the world for you to be where you are and doing what you are?

Or have you been so excruciatingly busy trying to get somewhere that you have had no time to take these little mental invoices to discover just where you are and why and for how long?—From Life.

THE IMPORTANCE OF MANNERS.

Manners are of more importance than laws. Upon them, in a great measure, the laws depend. The law touches us but here and there, and now and then. Manners are what vex or soothe, corrupt or purify, exalt or debase, barbarize or refine us, by a constant, steady uniform insensible operation, like that of the air we breathe in. They give their whole form and color to our lives. According to their quality, they aid morals; they supply them or they totally destroy them.—Edmund Burke.

GOVERNMENT AID TO HOME OWNING AND HOUSING OF WORKING PEOPLE IN FOREIGN COUNTRIES.

Government aid to home owning and housing of working people in foreign countries is the subject of Bulletin No. 158, just

issued by the Bureau of Labor Statistics of the United States Department of Labor. The report presents a comprehensive study of the work which has been done in the principal European and Australian countries, a work so important that it has already called for no less than 10 international housing congresses. The activities of foreign official authorities in the aid of housing have grown out of the conviction that private initiative is inadequate to deal with the housing problem and that systematic government regulation, encouragement, and financial aid must be given.

The methods of granting public aid differ greatly in detail in various countries, but the form in which the aid is given usually falls under one of three classes:

1. Building directly, for rental or sale.

- (a) For government's own employes—National, as in Austria, Germany, Hungary and Roumania. State or provincial, as in Germany, Switzerland and Roumania. Municipal, as in Germany, Hungary and Roumania.
- (b) For working people generally, as in France, Germany, Great Britain, Italy, Australia and New Zealand.

2. Making loans of public funds (including also Government guaranty of loans) to—

- (a) Local authorities, as in Austria, Belgium, Denmark, Germany, Great Britain, Hungary, Luxemburg, Sweden and Norway.
- (b) Non-commercial building associations, as in Austria, Belgium (by savings bank whose deposits are guaranteed), Denmark, France, Germany, Great Britain, Italy, Luxemburg, Netherlands, Sweden and Norway.
- (c) Employers, as in Germany, Great Britain and Luxemburg.
- (d) Individuals, as in Germany, Great Britain, Australia, New Zealand and Norway.

3. Granting exemptions from or concessions in taxes or fees or granting some other form of subsidy to building associations or others, as in Austria, Belgium, France, Germany, Italy, Hungary, Roumania, Spain, Switzerland, Australia and New Zealand.

Most important among the loans of public funds are those from the funds of the state accident and sickness-insurance associations in Austria and of the funds of the invalidity and old-age institutes in France and Germany. These loans in Germany represent the most important financial aid to housing anywhere developed, having reached a total of over \$118,000,000.

Most important among the methods of aid are the loans to the so-called public welfare building associations. These are associations in which the dividends which may be paid to the stockholders are limited usually to 4, or at most 5 per cent on the paid-up capital. In many cases it is also required that upon the dissolution of the association any surplus which may exist shall not be divided among stockholders, but must go to some specified public purpose.

In continental European countries, where building associations operating under the various housing laws have attained the greatest growth, as in Belgium, France, Germany, Italy and Austria, their operations are hedged about by many regulations and restrictions whose principal objects are to safeguard the security of the capital and to see that all the dwellings erected with the funds advanced are of a kind designed to carry out the purposes of the law and that they are so managed that their benefits will be received by the class of persons intended to be served.

Probably next in importance in the work for improved housing are clearance schemes which municipalities have been carrying on in Great Britain. In these schemes the municipal authorities have undertaken the purchase and clearance of insanitary slum areas in cities and the laying out of new streets and lots and the erection of sanitary dwellings to rehouse the tenants displaced by the improvements.

One result of the improved housing is the notable reduction of death rates in areas covered when compared with the death rates in the same areas under their former insanitary conditions and with the same groups of tenants. Thus in Liverpool, according to the official report, in some of the slum areas which have been the subject of clearance schemes and where displaced tenants have been rehoused upon the same areas, a death rate ranging from 40 to 60 per 1,000 (with a death rate from tuberculosis of 4 per 1,000) has, by the improved sanitary conditions brought about, been reduced by more than one-half (the death rate from tuberculosis being correspondingly reduced).

The extent of government aid in housing in those countries which have been most active in the movement may be seen from the fact that in Belgium up to the end of 1912 nearly \$20,000,000 had been loaned under government guarantee, resulting in the building of 57,500 workmen's dwellings. The exemptions on housing property used for workmen's dwellings had amounted to over \$7,000,000, applying to over 165,000 houses per year. In France two national institutions had loaned more than \$6,000,000 for housing purposes, while the city of Paris had invested nearly \$3,000,000 in similar work. In Germany an incomplete report of the activities of public authorities showed that more than \$228,

000,000 had been furnished or made available for housing purposes. This represents the activities of the Imperial Government, the individual states, and the municipalities. In England, the London authorities alone have expended more than \$14,000,000 in clearance schemes and the erection of workmen's dwellings, providing housing for over 55,000 persons. Loans amounting to more than \$33,000,000 have been authorized for other municipalities. The general government had made loans in excess of \$25,000,000. In Austria, Hungary, Italy, the Netherlands, Norway and Sweden, millions of public funds have been invested or loaned for the promotion of improved housing, the activities being most marked in the larger cities, notable examples being found in Vienna, Budapest, Rome, Amsterdam, Rotterdam and Stockholm.

The law on model lines which has been passed in Massachusetts as well as in New York compels the employer to post in factories and mercantile establishments where Sunday work is undertaken the rest days of such workers as are employed on Sundays.

Since the enactment of the law in New York and Massachusetts not only have a number of manufacturers expressed satisfaction with the law but representatives of labor have said that the workers were much benefited by it. A labor union in New York City states: "Since the bill is enacted in the state of New York eighty-five of our members have the benefit of it. Formerly the same members had to work seven days a week and the best we had was one day off in a month. Furthermore, we maintained the same wages for six days as we formerly had for seven."

TO PLAY A BIGGER PART.

So many people drift into disappointment and dreariness because they are dissatisfied with the materials of life, and would like to play a bigger part than they are entitled to play. It is all a deep mistake, the worst mistakes a man can make. It is not the impression a man makes on life that matters; it is the impression which life makes upon him.—A. C. Benson, in the North American Review.

STRENGTH RECORD BROKEN BY NEW STEEL CABLE.

All records for cable strength are said to have been surpassed when a 3-inch steel cable withstood a pulling test of 751,600 pounds, or practically 376 tons. This cable is to form part of the longest and strongest hoisting cable in the world, and is to be used in a mine in Cuba. It weighs 15.7 pounds to the foot and is made in lengths of 8,000 feet. This cable has a hemp center around which are wound six strands consisting of nineteen steel wires each.—Popular Mechanics.

Smiles.

THE LAST WORD.

A little girl traveling in a sleeping car with her parents greatly objected to being put in an upper berth. She was assured that papa, mamma and God would watch over her. She was settled in the berth at last and the passengers were quiet for the night, when a small voice piped:

"Mamma!"

"Yes, dear."

"You there?"

"Yes, I'm here. Now go to sleep."

"Papa, you there?"

"Yes, I'm here. Go to sleep like a good girl."

This continued at intervals for some time, until a fellow passenger lost patience and called:

"We're all here! Your father, and mother, and brothers and sisters and uncles and aunts and first cousins. All here. Now go to sleep!"

There was a brief pause after this explosion. Then the tiny voice piped up again, but very softly:

"Mamma!"

"Well?"

"Was that God?"

THE JAMAICAN MIND.

Much trouble as well as much amusement was caused during the early stages of the canal work by the inability of the Jamaican negroes to take any except a strictly literal view of orders. In unloading a vessel at Colon a rope in a pulley at the head of a mast got jammed, and a Jamaican was ordered to climb up and release it. He did as ordered. Some minutes later the boss of the gang missed him, and asked with some impatience where he was. He was pointed out sitting calmly at the masthead.

"What are you doing up there?" roared the boss.

"You told me to come here, sah," the man answered, "but you haven't told me to come down?"—The Youth's Companion.

A RARE BIRD.

"Did I understand you to say that you were a reformer?"

"Yes."

"Well, I must be going."

"What's your hurry?"

"I haven't time this morning to hear a lecture on my shortcomings."

"Don't be alarmed. I'm trying to reform myself before I start in on anything else."

"Your hand, most noble creature! You are the first true reformer I've ever met."—Ex.

PRECAUTION.

Little Ikey, playing pitch-and-toss with his right and left hand in the basement, was disturbed by a heavy form descending

upon him. Extricating himself he ran up stairs.

"Fader!" he cried, "a shentleman's fallen through the coal-hole."

"Den run round an clap de cover on him quick, mine son, vile I go for der perlice. Lest we arrest him for stealing der coals, he'll sue us for damages," said Absalom.

There is nothing like promptness in the hour of trial.

A SERIOUS MATTER.

There is a Scotchman in this country who has made a big pile in the manufacture of dress goods novelties.

One evening he was dining out, an unusual thing for this thrifty soul, when his friend observed him gazing solemnly at the check the waiter had handed him.

"Does it look big enough?" chaffed the friend.

The Scot grinned. "It reminds me of the first days I spent in this country," said he. "When I landed I went with a friend that had been over here six months to the house where he boarded and lodged, and for a sum that today would seem ridiculously small. But then it looked pretty big to me, as it did to my friend.

"When we were in the midst of the dinner that was my first meal Sandy put his mouth close to my ear and whispered:

"Put butter on your pie, Angus. Three dollars a week is no joke!"

A MINORITY REPORT.

A small, meek country negro, who had always lived on one place near Frankfort, Ky., married a big, domineering woman, and very soon afterward moved into town, where the keeper of the local bar met him on the street.

"Hello, Gabe," he said, "what made you move to town? I thought you liked country life."

"Well, Mistah Franklin," explained Gabe, "I uster lak de country. But mah wife she didn't lak it—and I've done got so now dat when she don't lak a thing I jest natchelly hates it."—Saturday Evening Post.

SUCH A POOR MARKSMAN.

Sergeant (disgustedly to Private Jones): "Ugh! don't waste your last bullet. Nineteen are quite enough to blaze away without hitting the target once. Go behind that wall and blow your brains out.

Jones walked quietly away and a few seconds later a shot rang out.

"Great sausages, the fool's done what I told him!" howled the sergeant, running behind the wall. Great was his relief when he saw Private Jones coming toward him.

"Sorry, sergeant," he said apologetically, "another miss."

DOING HIS SHARE.

The teacher wishing to impress on her pupils' minds the vast population of China, said:

"Just think of it, children, two Chinamen die every time you draw your breath!"

A minute later her attention was attracted to little Jimmie James, who stood at the foot of the class puffing vigorously, with his face reddened and his cheeks distended.

"What is the matter, Jimmy?" asked the teacher. "What on earth are you doing?"

"Nothin', Miss Mary," was the indifferent response of Jimmy. "Just killin' Chinamen."

A REASON FOR BEING PROUD.

The eight-year-old son of a Baltimore physician was playing in his father's office with a friend during the absence of the doctor, when suddenly the first lad threw open a closet door and disclosed to the terrified gaze of his little friend an articulated skeleton.

When the visitor had sufficiently recovered from his shock to stand the announcement, the doctor's son explained that his father was extremely proud of that skeleton.

"Is he?" asked the other. "Why?"

"I don't know," was the answer; "maybe it was his first parent."—Harper's Magazine.

UNLIKE LAWYERS.

The Moberly Monitor is telling this little story of a lawyer there:

It happened in Judge Tedford's court, and the witness was a negro woman, whose reply to every query was, "I think so."

Finally the opposing lawyer rose and pounded on the desk. "Now, you look here," he roared, "you cut out that thinking business and answer my questions. Now, talk."

"Mr. Lawyer Man," said the witness, "Mr. Lawyer Man, you all will have to 'scuse me. I ain't like you all 'terneys. I can't talk without thinkin'."—Kansas City Times.

CAT WAS LACKING.

Norah was a new girl in the employ of the Smiths, and hardly had twenty-four hours passed before she had the misfortune to drop a piece of roast beef on the floor. Roast beef that has been used as a mop is gritty eating, so Norah thought it the part of wisdom to consign it to the garbage can.

"I think, Norah," remarked the mistress, rambling into the kitchen later in the day, "that we will have some of that roast beef cut cold for supper."

"Sure, an' it's meself thot's very sorry, ma'am," answered Norah, contritely, "but the cat got it when Oi wasn't lookin'."

"The cat got it!" exclaimed the mistress, with a surprised expression. "What cats?"

"Jay whiz, ma'am," cried Norah concernedly. "Ain't there no cat?"—Ex.

MERCY.

"Why didn't you toot your horn if you saw the man in the road ahead?"

"I figured," replied the chauffeur, "that it would be more merciful if he never knew what struck him."—Judge.

Supper was in progress, and the father was telling about a row which took place in front of his store that morning:

"The first thing I saw was one man deal the other a sounding blow, and then a crowd gathered. The man who was struck ran and grabbed a large shovel he had been using on the street, and rushed back, his eyes blazing fiercely. I thought he'd surely knock the other man's brains out, and I stepped right in between them."

The young son of the family had become so hugely interested in the narrative as it proceeded that he had stopped eating his pudding. So proud was he of his father's valor, his eyes fairly shone, and he cried:

"He couldn't knock any brains out of you, could he father?"

Father looked at him long and earnestly, but the lad's countenance was frank and open.

Father gasped slightly, and resumed his supper.—Philadelphia Public Ledger.

STRICT, ALL RIGHT.

"I understand the Blanks are strict vegetarians."

"Strict! I should say they are. Why, they won't even let their children eat animal crackers."—Boston Transcript.

THE ACID TEST.

She: "Would you leave your home for me?"

He: "I'd leave a baseball game in the ninth inning with the score a tie."

LONDON FOG.

"Talk about a London fog!" said a Yankee just returning from England. "Why, I found that they even had foghorns in the elevators at my hotel!"—Judge.

"Did you strike this man in an excess of irascibility?"

"No, sah; I done hit him in the stum-mick."

HARD TO BELIEVE.

"I was outspoken in my sentiments at the club today," said Mrs. Garrulous to her husband, the other evening.

With a look of astonishment he replied, "I can't believe it. Who outspoke you?"

COMPREHENSIVE IGNORANCE.

Two Irishmen were philosophizing. Said Pat to Mike:

"Did yez iver shtop to think that wan half of the world don't know how the other half gets along?"

"You're right," says Mike, "and neither does the other half."—Evening Post Saturday Magazine.

Poetical Selections.

BEFORE IT IS TOO LATE.

If you have a gray-haired mother
In the old home far away,
Sit down and write the letter
You put off day by day.
Don't wait until her tired steps
Reach Heaven's pearly gates,
But show her that you think of her
Before it is too late.

If you've a tender message
Or a loving word to say,
Don't wait till you forget it,
But whisper it today.
Who knows what bitter memories
May haunt you if you wait?
So make your loved ones happy,
Before it is too late.

We live but in the present,
The future is unknown.
Tomorrow is a mystery,
Today is all our own.
The chance that fortune leads to
May vanish while you wait,
So spend your life's rich pleasures
Before it is too late.

The tender words unspoken,
The letters never sent,
The long-forgotten messages,
The wealth of love unspent.
For these some hearts are breaking,
For these some loved ones wait;
So show them that you care for them
Before it is too late.

—Charles W. Coburn.

OPPORTUNITY.

A word unsaid seems a little thing,
But alas, I may never know
If the coming day to a soul may bring
The truth that I fail to show.

A song unsung seems a little thing,
But the heart that I left today
May pine for the songs that I did not sing.
As it goes on its cheerless way.

A deed undone seems a little thing,
But the burden I might have shared
Has left a heart with a bitter sting,
Of the thought that "nobody cared."

So the little things that we leave undone
Are the things that men hold dear;
Life's battles are reckoned lost or won
By a smile or a falling tear.

'Tis the little things that the burdened heart
In the time of trial needs;
Then let us lighten life's aches and smart
With the sunshine of little deeds.

—Our Little Folks.

SAFETY FIRST.

As we journey through life let us "live" by
the way,
A saying of old that applies well today.
There is nothing so sweet as life after all,
So why take the chances that hasten "your
call?"

You often save time by the "short cuts" you
take,
But whenever you do your life is at stake:
For the time that you save would never re-
pay
For the time you will lose if you "slip" on
the way.

Very often the safety of others depend
On the judgment you use, it may be a
friend;
Or the loved ones at home, remember them,
too.
Their future depends on the things that you
do.

And this is a pretty good world after all,
There are times when our spirits may crum-
ble and fall,
But there's never a time through the night
or the day,
When the chances we take are worth what
we pay.

The "safety first" way may seem longer and
slow,
But it leads you past dangers you never will
know,
So "now" is the time to look well ahead,
"Safety First" cannot help you after you're
dead.

—C. J. Bryne.

THE BRAVEST BATTLE.

The bravest battle that ever was fought
Shall I tell you where and when?
On the maps of the world you'll find it not;
It was fought by the mothers of men.
Nay, not with the cannon or battle shot,
With sword or braver pen;
Nay, not with eloquent word or thought
From the mouths of wonderful men;
But deep in the woman's walled-up heart,
A woman that would not yield,
But patiently, silently, bore her part—
Lo! there is the battlefield.
No marching troops, no bivouac songs,
No banners to gleam and wave;
And, oh! those battles they last so long—
From babyhood to the grave!
Yet faithful still as badge of stars
She fights in her walled-up town—
Fights on and on in the endless wars.
Then silent, unseen—goes down.

—Joaquin Miller.

JOY.

Today whatever may annoy,
 The word for me is Joy, just simple Joy;
 The joy of life;
 The joy of children and of wife;
 The joy of bright blue skies;
 The joy of rain; the glad surprise
 Of twinkling stars that shine at night;
 The joy of winged things upon their flight;
 The joy of noonday, and the tried
 True joyousness of eventide;
 The joy of labor and of mirth;
 The joy of air and sea and earth—
 The countless joys that ever flow from Him
 Whose vast beneficence doth dim
 The lustrous light of day,
 And lavish gifts upon our way.
 Whate'er there be a Sorrow,
 I'll put off till tomorrow,
 And when tomorrow comes; why, then!
 'Twill be today and Joy again!

—John Kendrick Bangs.

THE TRUE ARISTOCRAT.

What are the nobles of the earth,
 The true aristocrats,
 Who need not bow their heads to lords
 Nor doff to kings their hats?
 Who are they but the men of toil,
 The mighty and the free,
 Whose hearts and hands subdue the earth
 And compass all the sea.

Who are they but the men of toil
 Who cleave the forests down
 And plant amid the wilderness
 The hamlets and the towns—
 Who fought the battle, bear the scars
 And give the world its crown
 Of name and fame and history,
 And pomp of old renown.

These claim no gaud of heraldry
 And scorn the knighting rod,
 Their coats of arms are noble deeds;
 Their peerage is from God.
 They take not from ancestral graves
 The glory of their name,
 But win as once their fathers won,
 The laurel wreath of fame.

THE BREAKING PLOW.

I am the plow that turns the sod
 That has lain for a thousand years;
 Where the prairie's wind-tossed flowers nod
 And the wolf her wild cub rears,
 I come, and in my wake, like rain,
 Is scattered the golden seed;
 I change the leagues of lonely plain
 To fruitful gardens and fields of grain
 For men and their hungry breed.

I greet the earth in its rosy morn,
 I am the first to stir the soil,
 I bring the glory of wheat and corn
 For the crowning of those who toll;
 I am civilization's seal and sign,
 Yea, I am the mighty pen
 That writes the sod with a pledge divine,
 A promise to pay with bread and wine
 For the sweat of honest men.

I am the end of things that were,
 And the birth of things to be;
 My coming makes the earth to stir
 With a new and strange decree.
 After its slumbers deep and long,
 I waken the drowsy sod,
 And sow my furrow with lifts of song
 To glad the heart of the mighty throng
 Slow feeling the way to God.

A thousand summers the prairie rose
 Has gladdened the hermit bee;
 A thousand winters the drifting snows
 Have whitened the grassy sea.
 Before me curls the wavering smoke
 Of the Indians' smouldering fire;
 Behind me rise—was it God who spoke?
 At the toil-enchanted hammer's stroke,
 The town and the glittering spire.

I give the soil to the one who does,
 For the joy of him and his;
 I rouse the slumbering world that was
 To the diligent world that is.
 Oh, seer, with vision that looks away
 A thousand years from now,
 The marvelous nation your eyes survey
 Was born of the purpose that here, today,
 Is guiding the breaking-plow.

—Nixon Waterman in the National Magazine

In Memoriam

Members.

Clyde J. Masters, Reg. No. 93855, age 28, of Lodge 556, Oklahoma City, Okla.; born in Iowa, 1856; died April 29, 1915, from otitis media; married, leaving one child; member two and one-half years.

Michael Boskavich, member of Lodge 39, Reg. No. 97610; died March 9, at Whiting, Ind.

Axil Rose, Reg. No. 97015 of Lodge 39, died at Robertsdale, Ind., April 6; born in Illinois.

Relatives of Members.

James F. Clucas, age 63 years, father of Brother Wm. H. Clucas, treasurer of Lodge 227, died April 28, 1915, of old age; he was born in Isle of Man, England, 1852.

Amelia Hentze, age 74, was mother of Brother Chas. Hentze of Lodge 360, died March 23, of acute indigestion; was born in Germany, April 7, 1841.

Mrs. L. J. Frost, age 17, wife of Brother L. J. Frost, of Lodge 587, born in Sands Springs, Okla., died April 18, 1915, from peritonitis.

Lodge Notices

Jno. Fisher—Lodge No. 363.

John Fisher, Reg. No. 8871, is requested to communicate with secretary of Lodge No. 363.

JOHN ROCHE,
Secretary.

McLaughlin Relatives.

Will Boiler Maker Frank McLaughlin, or anyone knowing his whereabouts, correspond with his brother, W. A. McLaughlin, conductor, I. M. & S. R. R., or Tom McCabe, 1320 Madison St., Alexandria, La.

TOM McCABE.

Richea—His Wife.

Anyone knowing the whereabouts of J. D. Richea, boiler maker, formerly a member of Lodge No. 27, St. Louis, Mo., will please notify his wife, Mrs. Julia Richea, 107 N. 10th St., St. Louis, Mo.

C. S. Burk—Lodge No. 82.

Any secretary taking up card of Brother C. S. Burk, Reg. No. 102470, will please hold same and correspond with secretary of Lodge 82, as this brother misrepresented facts to secure transportation to Kansas City, amounting to \$1.25, and we had to pay this bill out of the treasury of the local.

A. G. EVERETT,
Secretary L. 82.

Cooper et al—Lodge No. 491.

The following names are brothers who left Lodge 491 with bills unpaid: C. E. Cooper, boiler maker, left here Sept. 17, 1914, and later worked in Boone, Iowa. Bill to F. C. Krull & Co., for clothing, \$12.35. A. J. Conelly, bill to F. C. Krull & Co., for clothing, \$3.95. John Peters, Reg. No. 80223, to F. C. Krull & Co., for clothing, \$5.50. Last heard from was at Franklin Junction, Mo. Joseph Regan, Reg. No. 95180, F. C. Krull & Co. for clothing, \$2.40, and board and room to Sutton Sisters, \$8.83; total, \$11.23. J. M. Morgan, Reg. No. 91068, borrowed money from Local No. 491, \$2.50. Helpers: W. J. Mills, Reg. No. 98504, withdrawal card out of Local No. 145, owes F. C. Krull & Co. for clothing, \$6.40. C. A. Riley, no card, left for oil fields in Oklahoma, August, 1914. Debtor to F. C. Krull & Co. for clothing, \$4.25. Local No. 491 will have to have good references from brothers wanting credit at this point, or their card will have to show 10 years or more good standing, as this is getting to be a joke, standing good for some of those so-called boomers. All that has not been squared up by July 1, 1915, will be called for again in the August Journal.

J. J. CARROLL,
Secretary 491.

LIST OF MEMBERS PREVIOUSLY ADVERTISED

J. D. Landault, Reg. No. 87363, left Teague, Tex., owing a grocery bill of thirty-nine dollars and ninety-five cents (\$39.95). He is wanted by Mrs. John Cure, Teague, Tex., who stood good for the amount.

Swain—Lodge No. 567.

T. D. Swain, Reg. No. 38826, by Lodge No. 567, for non-payment of a note of seventy-five dollars (\$75.00).

R. L. WRIGHT,
Cor. Secretary Lodge No. 567.

Robertson Lodge No. 173.

H. E. or Earnest Robertson is wanted by Lodge No. 173, for failing to make good some money he borrowed.

J. P. TAYLOR,
Lodge No. 173.

Stewart et al—Lodge No. 66.

Any secretary taking up the card of Edgar Stewart, Reg. No. 21232, or Noble C. Townsend, Reg. No. 62088, will please correspond with the secretary of No. 66, Little Rock, Ark., as these brothers misrepresented facts and secured transportation out of Little Rock and Lodge No. 56 had to pay for same.

E. WORTHSMITH,
Corresponding Secretary No. 66.

E. L. Chafin—Lodge No. 587.

We have suspended Brother E. L. Chafin for not paying dues or honest debts. I, myself, loaned this brother some money to bury his little child, and he will not pay it back. He also owes several bills that he won't pay.

C. C. MADDY,
C. S., L. 587.

W. M. Horstmeyer—Lodge No. 381.

Any secretary taking up the card of Brother W. M. Horstmeyer, Reg. No. 9735, please hold same and correspond with Joe Wilson, secretary Lodge No. 381, Amarillo, Tex., as this brother borrowed some money from this lodge which he has forgot to return.

JOE WILSON,
L. 381.

Trials and Fines.

Roberts—Lodge No. 305.

This is to certify that W. M. Roberts, Reg. No. 101127, was tried and found guilty of violating the laws of the Brotherhood by working on unfair work as riveter for the P. I. W. Co., at Englewood, near Houston, Texas, March 24, 1915, and was fined one thousand (\$1,000.00) dollars, and suspended

for 99 years and is not entitled to recognition in any way from the officers or members of this Brotherhood until such judgments are satisfied.

E. L. Chafin, delinquent member of 587, was also working on this job the same date, but as he is delinquent he cannot be brought up for trial, but we would like to have him advertised in the Journal, as this member received money while in hard luck from both members of Lodge 305 and 587, and is still in debt to Lodge 587. His Reg. No. is 80151.

C. L. BRAGG, President.
T. O. RILEY, Secretary.

E. A. Grimes—Lodge No. 495.

This is to certify that E. A. Grimes, Reg. No. 96087, has been duly tried and found guilty by Lodge No. 495 of obtaining membership in this Brotherhood through fraud and card is revoked.

C. E. DICEY, A. Pres.
D. H. KING, R. S.

Dailey, et al.—Lodge No. 592.

This is to certify that the following members of Lodge No. 592 were tried by that lodge and found guilty of violating the laws of the Brotherhood by working on unfair work in the oil fields around Cushing, Tulsa, and vicinity, of Oklahoma, and were each fined \$1,000.00 and suspended for fifty years: Walter Dailey, Reg. No. 23543; W. R. Dickie, Reg. No. 99266; Frand Adams, Reg. No. 100539; C. Brown, Reg. No. 101953; Earl A. Brown, Reg. No. 100052; Roy Ingalls, Reg. No. 99943; Claude Reed, Reg. No. 100836; Tom Moore, Reg. No. 97864; Chas. Noble, Reg. No. 100832; Frank Williams, Reg. No. 93687; Guy Shriver, Reg. No. 98473; Chas. E. Lindsay, Reg. No. 101098; Ben Noble, Reg. No. 100828; W. L. Armhelm, Reg. No. 98515; J. D. Wilkerson, Reg. No. 102082; J. T. Mullen, Reg. No. 103541; Hugh Ross, Reg. No. 102966; Mike Edwards, Reg. No. 102967; W. C. Blankenship, Reg. No. 99456; James Macho, Reg. No. 68388; Carroll Copeland, Reg. No. 101029; John Copeland, Reg. No. 101026; D. W. Copeland, Reg. No. 88708; Roy Copeland, Reg. No. 77489; Bert Lemaster, Reg. No. 101678; Wm. Clinton, Reg. No. 101667; C. J. Levett, Reg. No. 91441; R. K. Lovett, Reg. No. 92600; C. Brown, Reg. No. 101953; Elmer G. Ankeny, Reg. No. 100335; Albert J. Cameron, Reg. No. 97800; John McPherson, Reg. No. 93676; A. A. Bruce, Reg. No. 100882; A. A. Meyers, Reg. No. 101940; A. A. Dosh, Reg. No. 90967; Chas. D. Cameron, Reg. No. 101354; Mack Miller, Reg. No. 103087; Porter Harris, Reg. No. 27319; Wm. O'Neill, Reg. No. 101222; Warren J. Hill, Reg. No. 31475; Henry LaPointe, Reg. No. 101221; Dick Rutherford, Reg. No. 43047; Ed. L. Ryan, Reg. No. 101027; Tom Burke, Reg. No. 93513; C. W. Huff, Reg. No. 79427; D. B. Askew or Asknee, Reg. No. 102969; Guy Sain, Reg. No. 97930; Charles English, Reg. No. 101861; F. T. Trammell, Reg. No. 101688; and are

not entitled to recognition in any way from the officers or members of this Brotherhood until such judgments are satisfied.

E. DIXON, President.
RICHARD LEAHY, Cor. Sec'y.

Lost and Found.

Lost Due Book—Costa.

Anyone finding the clearance card and due book of Brother Bert Costa, Reg. No. 22233, will please forward to the undersigned. Due book was out of Lodge No. 74, Houston, Texas, and clearance card Lodge No. 32, paid to March 31.

WALTER E. DWYER,
Secretary Lodge No. 32.

Lost Due Book—Busch.

The card and due book of Brother J. C. Busch was lost while on his way from Tacoma, Wash., and Portland, Ore. Anyone finding or having same will please correspond with the undersigned.

WM. POLZING,
Secretary Lodge No. 247.

Lost Due Book—Ivey.

Edw. E. Ivey, Reg. No. 74216, lost his due book and card on the Milwaukee Railroad. Finder please return to Grand Lodge.

EDW. E. IVEY.

Found Due Book—I. S. T.

Found due book and card of Brother Geo. Sullivan, said book and card found in Miami, Ariz., owner may have same by proving property, having same come through the lodge.

F. P. REINEMEYER,
I. S. T.

Walpale—Lodge No. 521.

Any secretary taking up the card of Bro. W. B. Walpale, Reg. No. 63322, will confer a favor by notifying the undersigned, or if Brother Walpale reads this it will be to his interest to write the secretary of Lodge No. 521.

OTTO PYLES.

Notice.

Frank C. Hasse, Reg. No. 27346, has paid fine and reinstatement fee in full and now is entitled to all rights and privileges of our organization.

JOHN S. COGHLAN,
B. A. and C. S., Lodge No. 39.

Thompson—Lodge No. 587.

F. W. Thompson, Reg. No. 20987, has been suspended by this local for non-payment of dues; he also owes about \$40.00 here. I kept after this brother while here; he got \$4.00 per day but could not keep in the clear, nor hold his job for good old booze.

T. C. MADDY,
Secretary Lodge No. 587.

OFFICIAL ROSTER—International Officers

J. A. FRANKLIN.....International President
Room 15, Law Bldg., 721 Minnesota Ave., Kansas City, Kas.

F. P. REINEMEYER.....Int. Secretary-Treasurer
Rooms 10 to 12 Law Bldg., 721 Minnesota Ave., Kansas City, Kas.

JAMES B. CASEY.....Editor-Manager of Journal
Room 9, Law Bldg., Kansas City, Kas.

A. HINZMAN.....First Int. Vice-President
Room 15, Law Bldg., 721 Minnesota Ave., Kansas City, Kas.

MISSOURI AND MISSISSIPPI SECTION.
States of Iowa, Missouri, Kansas, Nebraska, Arkansas, Mississippi, Alabama (other than Mobile), Tennessee, North and South Dakota, Oklahoma and Minnesota.

THOS. NOLAN.....Second Int. Vice-President
700 Court St., Portsmouth, Va.

GULF AND SOUTH ATLANTIC SECTION.
States of Texas, Louisiana, Florida, Georgia, North and South Carolina, Virginia, Maryland and Delaware, and Mobile, Ala.

J. P. MERRIGAN.....Third Int. Vice-President
91 Manufacturer St., Montreal, Que., Can.

CANADIAN SECTION.
The Dominion of Canada.

LOUIS WEYAND.....Fourth Int. Vice-President
6201 Fir Avenue, N. W., Cleveland, Ohio.

GREAT LAKES AND TERRITORY SECTION.
States of Wisconsin, Michigan, Cities of Chicago, Toledo, Cleveland and Lorain, O., Erie, Pa., State of New York (other than the City of New York).

WM. ATKINSON.....Fifth Int. Vice-President
212 South Pittsburg St., Spokane, Wash.
ROCKY MOUNTAIN AND PACIFIC COAST SECTION.

Honolulu, States of California, Oregon, Washington, Idaho, Utah, Nevada, Montana, Wyoming, Colorado, Arizona, Old Mexico, New Mexico and Canal Zone, Panama.

JOHN J. DOWD.....Sixth Int. Vice-President
133 Wegman Place, Jersey City, N. J.

EASTERN SEABOARD SECTION.
States of Maine, New Hampshire, Vermont, Massachusetts, Rhode Island, Connecticut, New Jersey and New York City.

M. A. MAHER.....Seventh Int. Vice-President
2114 Eighteenth St., Portsmouth, Ohio.

OHIO VALLEY AND TERRITORY SECTION.
States of Pennsylvania (other than the city of Erie), Ohio, West Virginia, Kentucky, Indiana and Illinois (other than the City of Chicago).

JOS. P. RYAN.....Eighth Int. Vice-President
5830 Wentworth Ave., Chicago, Ill.
Phone Wentworth 8739.

HELPERS' VICE-PRESIDENT OF WESTERN SECTION.
All states west of dividing line between Indiana and Ohio.

JOHN F. SCHMITT.....Ninth Int. Vice-President
1489 N. Fourth St., Columbus, Ohio.

HELPERS' VICE-PRESIDENT OF EASTERN SECTION.
All states east of dividing line between Indiana and Ohio.

District Lodges and Officers

DISTRICT No. 2—New York.
N. Y. Meets 1st and 3rd Wed.
Patrick T. Kenneally, President, 9 Magnolia Ave., Jersey City, N. J.

Wm. Brown, Vice-Pres., Elizabeth Ave., Elizabeth, N. J.
Gerald A. Daly, Sec.-Treas., 676 60th St., Brooklyn, N. Y.

DISTRICT No. 5—St. Louis, Mo.
Mo. Pac. and Iron Mountain R. R. Lodges represented: 32, 38, 44, 66, 82, 106, 113, 117, 286, 322, 403, 507, 521, 542, 543, 565, 583 and 599.

John C. Morrow, Pres., 613 W. 4th St., Coffeyville, Kans.
Eal Stack, Vice-Pres., Van Buren, Ark.

John J. Murphy, Secy., 3404 Eads Ave., St. Louis, Mo.
J. N. Shirley, Treas., Box 495, Hoisington, Kans.

A. E. Stewart, Member Ex. Board, 2533 Myrtle Ave., Kansas City, Mo.

A. J. Radford, Member Ex. Board, 624 Oak St., Little Rock, Ark.
Chas. A. McDonald, B. A., 4414 Winsor St., Kansas City, Mo.

DISTRICT No. 6—Southern Pacific R.R. Lodges represented: 32, 33, 46, 48, 52, 74, 92, 49, 98, 101, 113, 179, 193, 206, 216, 223, 239, 252, 309, 345, 339, 538, 553, 169.

J. J. Jones, Pres. and C. S., 1630 New Hampshire Ave., Los Angeles, Cal.

J. C. Carroll, V.-P., North Platte, Neb.

E. T. Feazelle, Sec.-Treas., Gate City Hotel, Pocatello, Idaho.

DISTRICT No. 10—Davenport, Ia.
Rock Island System. Lodges represented: 377, 144, 346, 199, 340, 293, 323, 434, 439, 491, 96, 32, 66, 476, 522, 523.

Geo. W. Pring, Pres. & B. A., 677 38th St., Des Moines, Ia.

John Mitchell, V.-P., 1502 McGowan St., Little Rock, Ark.

S. T. Sample, C. & F. S., 615 N. Jackson St., Pratt, Kas.
J. J. Lynch, Treas., Box 655, Herington, Kas.

DISTRICT No. 12—New York.
New York Central System. Lodges represented: 5, 7, 10, 64, 67, 85, 150, 157, 169, 175, 197, 218, 223, 229, 321, 413, 492.

A. M. Anderson, Pres., 2208 Francis St., Jackson, Mich.
G. H. Gates, Vice-Pres., 148 N. Orchard St., Watertown, N. Y.
J. J. Leamy, Sec.-Treas., 68 Livingston Ave., Albany, N. Y.

Trustees—Wm. Weber, E. J. McNamara and Thomas Ranger.

DISTRICT No. 13—Birmingham, Ala.
Southern R. R. System. Organized Feb. 23, 1904. Lodges represented: 2, 4, 12, 14, 40, 50, 28, 105, 143, 170, 226, 235, 312, 320, 334, 344, 369, 419, 511, 524; H. D. 27, 111, 176, 240.

Thos. J. Garvey, Pres., 414 E. Byrd St., Richmond, Va.
A. E. Barksdale, V.-P., 543 E. Lafayette St., Jackson, Tenn.

P. E. Berney, Sec.-Treas., R. F. D. 12, Knoxville, Tenn.

DISTRICT No. 15—Chicago, Ill.
C. & N. W. R. R. Lodges represented: 38, 60, 129, 145, 161, 201, 227, 311, 395, 440, 485, 496, 539, 597.

W. F. Scholes, Pres., 1929 Ave. B., Council Bluffs, Ia.

J. W. Francis, V.-P., 534 Springfield Ave., Chicago, Ill.

T. E. Burdette, Sec.-Treas., 428 North Chesnut Ave., Green Bay, Wis.

DISTRICT No. 19—Roanoke, Va.
Norfolk & Western System. Lodges represented: 28, 402, 30, 405, 557. Meets Union Labor Hall.

C. D. Craft, Pres., 1402 Center St., Portsmouth, O.

M. F. Glenn, V.-P., 1414 McConnell Ave., Portsmouth, Ohio.

J. B. O'Brien, Treas., Roanoke, Va.

E. J. Horgan, C. & F. S., 404 7th Ave. S. E., Roanoke, Va.

DISTRICT No. 20—Ill. Cent. R. R. Headquarters, Chicago, Ill.

Lodges represented: 56, 88, 133, 137, 40, 224, 426, 180, 220, 234, 300, 315, 363, 399, 95; H. D. 97, 106, 116, 102, 230, 174, 232, 223.

K. H. Elicker, Pres., 315 Dane St., Waterloo, Ia.
W. T. McCoid, V. P., 412 Madison St., Clinton, Ill.

E. G. Pullen, C. S. & Treas., 303 Columbia St., Waterloo, Ia.

DISTRICT No. 22—D. R. G. System.
Colorado and Utah. Meeting place, Denver, Colorado; Date meeting, 2d Monday in July, 1915; Lodges represented: 44, 103, 179, 335, 427, 446, 473.

Geo. S. Warden, Pres. & B. A., 1507 E. 7th St., Pueblo, Colo.

H. F. Jones, Vice-Pres., 135 Sackett Ave., Salida, Colo.

A. A. Duncan, Sec.-Treas., Box 611, Alamosa, Colo.

DISTRICT No. 23—Meets at St. Louis, Mo., 2d Monday in October, 1914.
Lodges represented: 4, 22, 27, 70, 95, 96, 180, 256, 418, 449, 458, 530, 531, 543, 546, 565, 575.

A. F. Bingham, Pres. and B. A., 701 Lombard St., Springfield, Mo.

L. W. Lawson, V.-P., 821 N. Maxey St., Sherman, Texas.

J. W. Reddick, Financial and Recording Secretary, 817 Lincoln St., Springfield, Mo.

A. A. Denton, Cor. Sec. and Treas., 1044 W. Mt. Vernon St., Springfield, Mo.

DISTRICT No. 24—Springfield, Ill.
Wabash System. Lodges represented: 54, 81, 267, 384, 581, 594.

Edward F. Siebold, Pres., 1130 St. Mary's Ave., Ft. Wayne, Ind.

Wm. F. Furrow, Vice-Pres., 1017 E. Eldorado St., Decatur, Ill.

F. R. Lee, Secy-Treas., 601 Monroe Ave., Moberly, Mo.

DISTRICT No. 25—Livingston, Mont.
Northern Pac. R. R.

J. G. Brown, Pres., 610 N. 9th St., Brainerd, Minn.

Frank Depender, V.-P., 735 E. Nora Ave., Spokane, Wash.

Theo. W. Everett, Sec.-Treas., P. O. Box 554, Livingston, Mont.

Trustees—A. H. Shanks, 221 N. 2nd St., Missoula, Mont.; Hugh Roberts, Gen. Del., Glendive, Mont.; G. M. Owens, 312 So. E. St., Livingston, Mont.

DISTRICT No. 26—Aberden S. D. C. M. & St. P. and Puget Sound R. R. Lodges represented: 11, 15, 32, 38, 41, 104, 244, 302, 485, 520, 528, 568, 588, 595, 603, 608. G. H. Hawkworth, Pres., Box 817, Deer Lodge, Mont.

F. J. O'Brien, Vice-Pres., Avery, Idaho.

Ed. McSperritt, Secy., Gen. Del., Miles City, Mont.

F. W. Gunn, Treas., \$316-30 Ave., South, Minneapolis, Minn.

J. L. Callahan, B. A., 3606 Clifton St., Milwaukee, Wis.

DISTRICT No. 27—Int. G. N. R. R. W. O. Faulk, Pres., Palestine, Tex.

W. K. Saddler, Vice-Pres., Mart, Texas.

E. H. Frick, Sec.-Treas., San Antonio, Tex.

W. B. Graham, B. A., Palestine, Tex.

DISTRICT No. 29—Cincinnati, O. C. H. & D. R. R.

W. J. Redmond, Pres., 204 N. Wash. St., Indianapolis, Ind.

A. R. Grieshelmer, Vice-Pres., 329 N. Elizabeth, Lima, O.

Wm. J. McGee, Jr., Sec.-Treas., 1255 Richmond St., Cincinnati, O.

DISTRICT No. 30—Canadian Pacific. District Headquarters, Winnipeg, Man. Lodges in affiliation: 126, 134, 194, 379, 392, 451, 466, 478, 505, 529, 648, 417. Geo. F. Chadburn, Pres. and Acting Sec.-Treas., 1585 Alexander St., Winnipeg, Man.

J. B. Smith, V.-P., 162 Annette St., Toronto, Ont.

R. Carswell, V.-P., 684 Home St., Winnipeg, Man.

DISTRICT No. 31—Cincinnati, O. B. & O. System. Lodges represented: 5, 10, 79, 99, 105, 135, 241, 259, 318, 326, 332, 444, 492, 498, 514, 579, 578.

J. C. Smith, Pres., Box 292, Garrett, Ind.

J. R. Cline, Vice-Pres., Cleveland, O.

M. W. Luke, Sec.-Treas., 1007 W. Main, Washington, Ind.

DISTRICT No. 33—Grand Rapids, Mich. Pere Marquette System. Lodges represented: 34, 124, 413.

DISTRICT No. 34—Boston, Mass. Boston & Maine System. Lodges represented: 245, 371, 388, 481, 515, 517. Meets at Boston, Mass., 1st Monday in August and 2d Monday in February.

W. H. Wells, Pres., 108 Westford St., Lowell, Mass.

P. J. Kelley, Vice-Pres., 3 Devon St., Greenfield, Mass.

T. J. Donahue, Sec.-Treas., 5 Fernald St., Lowell, Mass.

DISTRICT No. 35—Parsons, Kas. L. & T. R. R. System. Lodges represented: 292, 209, 501, 576 and 265.

Fred Alsdorf, Pres. & B. A., 515 W. Owings St., Denison, Tex.

C. Dudding, V.-Pres., 2229 Crawford St., Parsons, Kas.

Robt. Rosbottom, Sec.-Treas., 600 W. Texas St., Denison, Tex.

C. A. Denton, Rec. Sec., Parsons, Kas.

Wm. Dickerson, Chairman Trustees, 810 Cleveland St., Waco, Tex.

DISTRICT No. 37—Texarkana, Tex. Cotton Belt R. R. System. Meets 3d Saturdays in January and July.

R. M. Cummins, Pres. & B. A., 308 E. Valentine St., Tyler, Tex.

John A. Smith, V.-P., 1908 E. 8th St., Pine Bluff, Ark.

B. E. Shields, Sec.-Treas., 1503 E. 7th Ave., Pine Bluff, Ark.

DISTRICT No. 38—Atlantic Coast Line. Lodges represented: 20, 26, 239, 422, 425, 448, 570.

A. J. Dixon, Pres., Rocky Mount, N. C.

W. A. Cahill, Vice-Pres., Montgomery, Ala.

E. S. Ryan, Sec.-Treas., 501 Lackawana Ave., Jacksonville, Fla.

DISTRICT No. 39—Central of Georgia System. Meets 1st Friday after Thanksgiving, each year at Columbus, Ga. Lodges represented: 4, 12, 28, 436, 510. R. J. Black, Pres., 913 2nd St., Macon, Ga.

J. J. Dean, Vice-Pres., 226 Taylor St., Savannah, Ga.

Chas. A. Buchhell, Sec.-Treas., 103 Gordon W., Savannah, Ga.

E. M. Kendrick, Rec. Sec., Route 6, Cedartown, Ga.

R. S. Barry, Cor. and Fin. Sec., 1109 5th Ave., Columbus, Ga.

DISTRICT No. 40—Hamlet, N. C. Seaboard Airline and leased lines. Lodges represented: 1, 20, 26, 173, 298.

B. M. Jewell, Pres., 727 W. Moore St., Jacksonville, Fla.

J. P. Erice, Vice-Pres., 204 Whitehall St., Atlanta, Ga.

W. J. Wertz, Secy-Treas., 333 Tattarnall St., Savannah, Ga.

DISTRICT No. 41—Hinton, W. Va. Chesapeake & Ohio System. Lodges represented: 170, 238, 249, 364, 384, 525.

R. L. King, Pres., 822 N. Twenty-sixth St., Richmond, Va.

L. F. Moatz, Vice-Pres., 159 W. Third St., Peru, Ind.

C. L. Barnett, Sec.-Treas., 419 Summers St., Hinton, W. Va.

Trustees—M. L. Steinbuck, Box 336, Clifton Forge, Va. D. C. Dowdy, 2046 7th Ave., Huntington, W. Va. A. J. Poke, 1817 Scott Ave., Covington, Ky.

DISTRICT No. 42—Danville, Ill. Chicago & Eastern Illinois R. R. Meets 1st Tues. in Feb., 1916. Lodges represented: 22, 95, 575. G. D. Davis, Pres. and B. A., 18 N. Hazel St., Danville, Ill.

James B. Keenan, V.-P., 1006 E. Madison St., Danville, Ill.

Oliver Henthorn, R. & F. S., 102 Iowa St., Danville, Ill.

A. Welch, Cor. Sec. & Treas., Villa Grove, Ill.

Subordinate Lodges and Officers

1—CHICAGO, ILL. 2d-4th Wed., Bricklayers' Hall, Monroe and Peoria Sts. James McKiernan, Pres. John E. Burke, C. & F. S., 3009 Archer Ave. John Dohney, 8123 So. Peoria. Frank Condon, B. A., 912 Monroe.

2—ATLANTA, GA. 2d-4th Thurs. A. D. Lundbon, Pres., 224 E. Fair. John Fitcher, C. S., 406 Pullian.

3—ST. PAUL MINN. 1st-3d Fri., New Odd Fellows' Home, 9th and Franklin. Geo. Cox, Pres., 1746 Logan. Wm. Harrington, F. S., 695 Pine. Wm. Parranto, B. A., 400 E. Jenks.

4—BIRMINGHAM, ALA. 1st-3d Tues., K. of C. Hall. Fred Baker, Pres., 202 1/4 3d Ave. A. L. Carmack, F. S. & B. A., Office: 335 Hood Bldg.

5—CLEVELAND, OHIO. 1st-3d Thurs., Room 3, Federation Hall, 310 Prospect. Chas. Tongreen, Pres., Superior. G. H. Brady, C. S. & B. A., 310 Prospect.

7—BUFFALO, N. Y. 2d-4th Fri., Council Hall, 33 E. Warron. Geo. F. Muir, Pres., 116 Goodell. Thos. J. King, C. S., 1943 Seneca. Frank P. O'Brien, F. S., 238 Schiller.

8—COLUMBUS, O. Meets 2d-4th Thurs., F. of L. Hall. Chas. L. Nicklaus, Pres., 473 Poplar Ave. Adam Ruckel, C. S., 287 Liebert.

10—INDIANAPOLIS, IND. 2d-4th Thurs., 114 N. Delaware.

E. P. Leopard, Pres., 206 N. Tremont Ave. Wm. Frohlinger, C. S., 542 East Louisiana St. L. E. Hinach, F. S., 851 Ashland Ave.

11—MINNEAPOLIS, MINN. 2d-4th Mon., Richmond Hall, 223 5th St. H. F. Farly, Pres., 1356 Vine Place. E. A. Conlin, C. S., 2404 Bloomington Ave.

12—MACON, GA. 2d-4th Friday. Morgan's Hall, cor. Elm and Broadway. J. T. Fenlon, Pres., 1974 Third St.

R. J. Black, C. & F. S., 913 2d.

14—CHATTANOOGA, TENN. Central Labor Hall, 8th and Cherrle Sts., 2d-4th Mon. Wm. Quigley, Pres. Jas. E. Evans, C. & F. S., 19 Jefferson.

15—DUBUQUE, IOWA. 1st-3d Tues., Union Hall, 19th and White Sts. E. Keck, Pres., 1272 Lincoln Ave. R. Ruof, C. & F. S., 975 Clay St.

16—JERSEY CITY, N. J. 1st-3d Mon., Fischer's Hall, Newark Ave., cor. Erie St. Patrick J. Kennally, Pres., 209 Magnolia Ave. Hugh Fitzpatrick, C. S., 244 York. Ed. McCarthy, B. A.

19—PHILADELPHIA, PA. 2d-4th Fridays, Bricklayers' Hall, Broad and Fairmount Ave. Frank Goodfellow, Pres., 159 W. Palmer St. R. S. Hopkins, C. S., 2426 S. Clarion.

20—JACKSONVILLE, FLA. Meets every Monday, Central Labor Hall, 46 1/2 W. Bay. C. A. Clarke, Pres. E. S. Ryan, C. & F. S., 508 Lackawana Ave.

21—NEW YORK, N. Y. 1st-3d Mon. John H. Sullivan, Pres., 607 W. 46th St. James McGeney, C. S., 352 Schermerhorn St., Brooklyn, N. Y. Thomas Broadley, F. S., 619 W. 42d St.

22—DANVILLE, ILL. 1st-3d Mon., Trades and Labor Hall. Ray Schenk, Pres., California St. Wm. J. Irwin, C. S., 7 Illinois. Frank Jergens, F. S., 418 N. Bowman Ave. G. D. Davis, B. A., 18 N. Hazel.

25—SAN FRANCISCO, CALIF. Roesch Hall, 15th and Mission Sts., 2d-4th Thurs. John Kane, Pres., 41 Collingwood. Thos. J. Sheridan, C. S. & Treas., 2312 24th St. Wm. P. Bower, B. A., 314 14th.

26—SAVANNAH, GA. 1st-3d Tues., Whittaker St. and Liberty Lane. E. C. Howie, Pres., 1110 E. 32d St. R. B. Allen, C. S., 509 E. 32d St.

27—ST. LOUIS, MO. 2d-4th Thurs., 10th and Carr. Larry Kickham, Pres. & B. A., 5322 Vernon Ave. James Callahan, C. S., 3408 La-clede Ave. Henry Selkmann, F. S., 1908A Madison.

- 20—ROANOKE, VA.** 2d-4th Wed., Labor Home Hall, Commerce and Salem Ave.
G. J. Lucas, Pres., 1121 2d Ave. N. W.
J. R. Anderson, C. S., 502 Campbell Ave.
- 30—ROANOKE, VA.** 2d-4th Mon., Labor Hall, cor. Commerce St. and Salem Ave.
C. E. Bades, Pres., 218 7th Ave. N. E.
B. I. Wade, C. S., 211 Jamison Ave.
- 31—ST. JOSEPH, MO.** 2d-4th Mon., Jockey Hall.
E. E. Stitts, Pres., 2228 So. 6th.
Edward Knight, C. S., 2119 So. 9th St.
- 32—KANSAS CITY, MO.** 2d-4th Fri., Labor Temple, 14th and Woodland.
Thomas Mulvihill, Pres., 3715 Springfield St., Rosedale, Kas.
W. B. Dwyer, C. & F. S., 4402 Windsor.
Chas. McDonald, B. A., 4416 Norledge.
- 37—NEW ORLEANS LA.** 2d-4th Wed., Martin's Hall, Iberville & Exchange Place.
Wm. J. Smith, Pres., 223 Morgan St., Algiers, La.
Lewis J. Costella, C. S. & B. A., 636 N. Olympia.
Victor Escouse, F. S., 617 Alix St., Algiers, La.
- 38—OMAHA, NEB.** 1st-3d Wed., Blairrig Hall, 19th & Farnum.
M. J. McGovern, Pres., 1617 Burt.
L. G. Rankin, C. S., 2825 Cass.
J. H. Massman, F. C., 1511 Locust.
- 39—SOUTH CHICAGO, ILL.** 2d-4th Tues, Union Headquarters, 92d St. and Erie Ave., South Chicago.
Frank Bacton, Pres., 10149 Ave. J.
John Cogan, C. S. & B. A., 9944 Ave. H.
Jos. Manners, F. S., 10123 Ave. L.
- 40—LOUISVILLE, KY.** 2d-4th Wed., in Beck's Union Hall, 1st and Jefferson Sts.
Thomas Mitchell, Pres., 1422A Broadway.
F. J. Kiesler, C. S., 212 Collins Court.
- 41—HARLOWTON, MONT.** 2d-4th Thurs., Winer Hall.
John Dennis, Pres.
Harry Schultz, C. & F. S.
- 42—NASHVILLE, TENN.** 2d-4th Thurs., Carpenters' Hall, 342½ 4th Ave. N.
James E. Keenan, 1006 E. Madison St., Danville, Ill.
H. R. Brown, Pres., 611½ Church.
W. T. Pentecost, C. S., 2143 Oakland Ave.
- 44—PUERBLO, COL.** Every Thurs., New Pope Bldg., Main bet. 3d and 4th Sts.
Walter M. Pitts, Pres., 631 E. 5th St.
Geo. S. Warden, C. & F. S., 1507 E. 7th St.
- 45—BROOKLYN, N. Y.** Greenpoint and Manhattan Aves., 2d-4th Thurs.
Gerald A. Daly, Pres. & C. S., 676 60th St.
M. J. Callahan, F. S., 119 Terrell
- 46—CHEYENNE, WYO.** Union Hall, 2d-4th Wed.
Geo. R. Wallace, Pres., P. O. Box 151.
E. Cole, C. S., 215 E. 9th St.
- 47—DES MOINES, IA.** 1st-3d Thurs., Trades Assembly Hall.
James Gillespie, Pres., 1113 Columbus Ave.
Fritz Johnson, C. & F. S., 922 W. 1st St.
- 48—LARAMIE, WYO.** 1st-3d Tues., Moose Hall.
Jacob Claus, Pres., 114 Cedar St.
Frank M. Lepper, C. S., 360 N. 3d St.
- 50—CHARLESTON, S. C.** 1st-3d Tues., Y. M. C. A. Hall, George St.
H. J. Hartnett, Pres., 18 Anson St.
John J. Clair, C. & F. S., 196A Spring St.
- 51—ST. LOUIS, MO.** 2d-4th Wed., Lafayette Hall, 17th and Cass Ave.
Frank H. Johannimgmire, Pres., 1923 Sullivan Ave.
Mike Whalen, C. S., 1715 N. 11th St.
Geo. Wheaton, F. S., 4159 Lee Ave.
- 54—FORT WAYNE, IND.** Last Wed., West Berry St.
Edward F. Siebold, Pres. & C. S., 1130 St. Mary's Ave.
O. P. Ewald, F. S., 1419 S. Calhoun.
- 55—NEWPORT NEWS, VA.** Every Wed., 8 p. m., C. L. U. Hall, 32d and Wash. Ave.
Wm. H. Healy, Pres., 3711 Huntington Ave.
D. McArthur, C. S., 211 37th.
W. Hannah, F. S., P. O. Box 430.
- 56—VICKSBURG, MISS.** 1st-3d Tues., K. of P. Hall, N. Washington St.
Ed. Snelling, Pres., 3127 Washington St.
W. C. Hughes, C. & F. S., 2312 Mulberry.
- 57—DORCHMOUTH, VA.** 1st-3d Thurs., C. L. U. Hall.
O. C. Hartung, Pres., 1248 Park Ave.
J. H. Parrish, F. S., 622 Clifford.
Geo. Thomas, C. S., 204 Lincoln.
- 60—PEORIA, ILL.** 1st-3d Mon., 411 Cedar St.
Andy Yates, Pres., 1709 S. Adama.
F. Hierspiel, C. S., 410 Warner Ave.
- 61—NEW HAVEN, CONN.** 1st-3d Thurs., Boardman Bldg., cor. State and Chapel Sts.
Wm. Hefferman, Pres., 95 Carlyle.
M. J. Whalen, C. & F. S., 138 Carlyle.
- 64—JACKSON, MICH.** Every Tues., Labor Hall, Main and Jackson Sts.
Geo. Bones, Pres., 140 Bates.
Ed McNamara, C. S., 619 South Pleasant St.
- 65—VICTORIA, VA.** 2d-4th Sundays, Lunenburg Hall.
J. H. Jones, Pres., Gen. Del.
W. H. Slayton, C. S., Gen. Del.
- 66—LITTLE ROCK, ARK.** 1st-3d Thurs., Brannon Hall, Markham and Cross Sts.
W. J. Flynn, Pres., 908 Denison.
E. Wortsmitth, C. & F. S., 300 W. 11th St., Argenta, Ark.
C. A. McDonald, B. A., 4416 Norledge, Kansas City, Mo.
- 67—BAY CITY, MICH.** 1st-3d Thurs., Central Trades Council Hall.
Wm. H. Benedict, Pres., 703 E. Winona Ave., W. S.
Joe Malton, V.-P., 317 S. Jackson.
Nelson Heglung, C. & F. S., 514 Adams St.
- 68—PINE BLUFF, ARK.**—2d-4th Wed., Labor Temple.
A. J. Barton, Pres., 1701 W. 6th.
B. E. Shields, F. S., 1503 E. 7th.
J. A. Smith, C. S., 1908 E. 8th.
- 70—SPRINGFIELD, MO.** 2d-4th Wed., Eagles' Hall, E. Commercial St.
R. A. Lines, Pres., 216 W. Atlantic St.
Scott Daffer, C. & F. S., 987 Broad St.
A. F. Bingham, B. A., 701 Lombard St.
- 72—PORTLAND, ORE.** 2d-4th Thurs., 230½ Yamhill St.
Arthur Gallon, Pres., 649 Milwau-kee.
F. E. Disbrow, C. & F. S., 810 E. 11th.
Joe Reed, B. A., 507 Bismark.
- 73—TROY, N. Y.** 3d-4th Mon., Swan and Georgia Sts., Mechanics' Hall.
Huntington Ave.
John Donnelly, Pres., 23 3d St.
C. Hoes, N. Y.
David Boyd, C. & F. S., 319 9th St., Waterloist, N. Y.
- 74—HOUSTON, TEXAS.** 1st-3d Wed., Woodman Hall, 1823 Washington St.
D. C. Bryan, Pres., 4607 Wash-ington.
F. C. Jackson, C. & F. S., 2113 Lubbock St.
- 79—GARETT, IND.** 1st-3d Tues., K. of P. Hall, Randolph.
Geo. Richmond, Pres., 214 E. Key-ser.
J. C. Smith, C. & F. S., Box 232.
- 80—ANACONDA, MONT.** 2d-4th Wed., M. & M. Hall, Lodge Box 372.
J. C. Smith, Pres., 510 Cherry St.
James W. Hogan, C. S., 800 Birch.
- 81—SPRINGFIELD, ILL.** 2d-4th Tues., Fortunes Hall.
Ed Sellers, Pres., 130 E. Ed-wards.
Louis L. Mutter, C. & F. S., 1621 S. 8th.
- 82—OSAWATOMIE, KAS.** 1st-3d Mon., K. & L. Sec. Hall.
Hurb Fader, Pres.
J. E. Sturges, C. & F. S., Box 64.
C. A. McDonald, B. A., 4416 Norledge, Kansas City, Mo.
- 83—KANSAS CITY, KAS.** 2d-4th Tues., K. P. Hall, 624 Minn. Av.
Thomas Knowles, Pres., 760 Shaw-nee.
Frank Stover, C. & F. S., 322 Ne-braska Ave.
- 84—GRAND RAPIDS, MICH.** 1st-3d Mon., Trade & Labor Hall, 67 Monroe Ave.
Frank C. Lemke, Pres., 551 Sham-rock St.
Nelson M. Warren, C. S., 127 E. Delaware St.
- 85—TOLEDO, OHIO.** 2d-4th Tues., Mitchell's Hall, cor. Wal-nut and Summit Sts.
J. S. Durst, Pres., 153 Gibbons St.
Ellsworth Richardson, C. S., 1137 Western St.
- 86—DALLAS, TEX.** 1st-3d Mon., Broadnax Hall.
W. H. Riley, Pres., 1408 Corinth.
C. B. Stout, C. S., R. R. 10, Box 64.
- 88—JACKSON TENN.** 2d-4th Fri., Labor Hall.
B. B. Seward, Pres.
A. E. Barkdale, C. S., 119 E. Or-leans St.
- 90—SUGAR CREEK, MO.** 2d-4th Thurs., Woodman's Hall.
L. Novak, Pres.
C. R. Snider, C. & F. S., 1222 W. Electric St., Independence, Mo.
- 91—ELMWOOD PLACE O.** 1st-3d Mon., Kellers Hall.
Geo. Urban, Pres., St. Bernard, O.
John Cullen, C. S., 39 Prosser Ave.
- 92—LOS ANGELES, CAL.** 2d-4th Wed., Union Labor Temple, 540 Maple Ave.
Charles Clarke, Pres., 206 S. Workman St.
H. E. Herman, C. & F. S., 520 S. Griffin Ave.
- 93—JOLIET, ILL.** 2d-4th Tues., Conner's Hall.
John Buckley, Pres., 111 Willard Ave.
Richard Farrell, F. S., 503 Lon-don Ave.
Charles Mork, C. S., 424 Lenden Ave.
- 94—SACRAMENTO, CAL.** 1st-3d Thurs., Labor Temple.
J. Grabfelder, Pres., 3001 G St.
J. S. Heller, Acting C. S., 1317 19th St.
- 95—EVANSVILLE, IND.** 2d-4th Mon., Ruhl's Hall.
Chas. T. Mooney, Pres., 1802 Mich-igan.
Herman H. Grundman, C. & F. S., 307 Mary St.

- 96—FORT WORTH, TEX. B. of L. F. & E. Hall, 1st-3d Thurs. J. J. Dempsey, Pres., 504 Calhoun. L. A. Freeman, C. & F. S., 2250 Jennings St.
- 99—NEWARK, OHIO. Druid's Hall, S. 3d St., 1st-3d Sun. Emil Indlekofer, Pres., 48 Curtis Ave.
- Cecil Roberts, C. & F. S., 45½ S. Third St.
- 100—MARSHALL, TEX. 1st-3d Tues., I. O. O. F. Hall. Smith Hayden, Pres., 514 Greenwood Ave.
- J. P. O'Neil, C. & F. S., 708 E. Rusk.
- 103—SALT LAKE CITY, UTAH. Labor Temple, 3d East, bet. 1st and 2d S. St., 1st-3d Wed. Wm. H. Garrick, Pres., 416 Edith Ave.
- B. S. R. Harrison, C. & F. S., 362 Ouray Ave.
- 104—SEATTLE, WASH. 1st-3d Thurs. Labor Temple, 6th and University St.
- Fred Counter, Pres., 2360 15th Ave., So.
- Dan McKillop, Sec. & B. A., 166½ 10th Ave., Phone Elliott 845W.
- 105—CINCINNATI, OHIO. 2d-4th Tues., Workman's Hall, Mercer and Walnut Sts.
- Chas. Granger, Pres., 339 Union St., Bellevue, Ky.
- D. L. O'Brien, C. S. & B. A., 23 Forest Ave., Ludlow, Ky.
- Frank Barrows, F. S., 1028 5th Ave., Dayton, O.
- 106—MCGHEE, ARK. 2d-4th Wed., K. of P. Hall.
- Wm. E. Crupper, Pres., Box 215.
- Chas. A. Stewart, C. & F. S., Box 432.
- 107—MILWAUKEE, WIS. 1st-3d Tues., Speers Hall, Cor. National & 3d Ave.
- J. Hoppens, Pres., 1302 Fratney.
- R. Dale, Fin. Sec., 319 4th Ave.
- P. Sonnenberg, C. S. & B. A., 623 Greenbush.
- 108—AUGUSTA, GA. 2d-4th Tues., Machinists' Hall, Broad.
- Patrick Rice, Pres., 1342 Walton Way.
- E. E. Bennett, C. S., 1406 Silcox.
- 109—CHADRON, NEB. J. W. Boyd, Pres.
- Ed Grady, C. S., Gen. Del.
- 111—MISSOULA, MONT. 2d-4th Tues., Eagles' Hall.
- H. A. Chase, Pres., Box 1304.
- A. Fraser, C. S., R. R. No. 1.
- 112—SEDALIA, MO. 1st-3d Tues., Labor Temple.
- Chas. Hall, Pres., Gen. Del.
- C. A. McDonald, B. A., 4416 Norledge, Kansas City, Mo.
- W. H. Sin, C. S., 1306 E. 7th St.
- 116—BRAINERD, MINN. 2d-4th Fri., Trades and Labor Hall.
- Henry Voigt, Pres., E. Oak.
- Wm. B. Good, C. S., Imperial Block.
- 117—DE SOTO, MO. 1st-3d Mon., Federation Hall.
- R. B. Parks, Pres.
- S. L. Johnson, C. & F. S., Box 248.
- 118—NORTH PLATTE, NEB. 4th Sat., K. of P. Hall.
- John Beth, Pres.
- Peter McGovern, C. S., 511 Locust.
- 123—LIVINGSTON, MONT. 1st-3d Thurs., Trades and Labor Hall.
- C. D. Cain, Pres., 204 S. K St.
- Theo. W. Evert, C. & F. S., P. O. Box 554.
- 124—SAGINAW, MICH. 1st-3d Fri., Petre & Meek's Hall, Genesee Ave.
- John Doyle, C. & F. S., R. F. D. No. 1.
- 126—WINNIPEG, MAN. 1st Wed. and 3d Sun., 2:30 o'clock, Labor Temple.
- Wm. L. Hall, Pres., 1576 Elgin Ave.
- L. W. Prince, C. & F. S., 290 Millton.
- 129—CLINTON, IOWA. H. Qualman, C. S., 221 14th Ave.
- 130—BUTTE, MONT. 1st-3d Tues., Carpenters' Hall, cor. Granite and Montana Sts.
- T. F. Shultz, Pres.
- Harry Goodland, C. & F. S., 177 E. Center.
- 132—GALVESTON, TEX. 2d Mon., Cooks and Waiters' Hall, 23d St.
- S. Naudascher, Pres., 3228 Ave. H.
- E. T. Chester, C. & F. S., 3209 Ave. I.
- 133—WATERLOO, IOWA. Central Labor Hall, 2d-4th Wed.
- E. G. Pullen, Pres., 502 Columbia St.
- Geo. A. McMillan, C. S., 702 Barclay St.
- 134—MONTREAL, QUE., CAN. 1st-3d Fri., Monument National, St. Lawrence and Main Sts.
- Stephen Craig, Pres., 1251 Moosier.
- R. Chorlton, C. S., 1184 Delormier Ave.
- 135—CHILLICOTHE, O. 1st-3d Mon., Flaecker Hall.
- L. J. Medert, Pres., 516 E. Water St.
- James Hunsinger, C. & F. S., 390 E. 4th St.
- 136—COLORADO CITY, COLO. Red Men's Hall, 1st-3d Fri.
- H. J. Norton, Pres., care National Hotel.
- R. D. Wing, C. S., 12 So. 12th, Colorado Springs, Colo.
- J. H. Cook, F. S., 216 N. 12th.
- 137—PADUCAH, KY. 2d-4th Sun., Central Labor Hall, 122½ N. 4th.
- B. C. Beadles, Pres., 1029 Madison.
- Wm. Black, C. & F. S., 315 N. 3d St.
- 138—HARRISON, ARK. H. C. Heppard, Pres.
- T. T. Chubb, C. S.
- 140—PEN ARGYL, PA. 2d-4th Mon., Steinmitz's Hall, Bangor, Pa.
- Joseph Weninger, Pres. & C. S., care Realty.
- J. A. Morgan, Fin. Sec., care Albin House.
- 143—KNOXVILLE, TENN. 319 N. Gay St., 1st-3d Tues.
- J. O. Krause, Pres., R. F. D. No. 1.
- Joe Gallaway, C. S., 1000 Broadway.
- W. D. Amanns, F. S., R. F. D. No. 12, Lincoln Park.
- 144—CEDAR RAPIDS, IOWA. 1st-3d Wed., I. O. O. F. Hall, cor. 1st St. and 2nd Ave. W.
- Chas. T. Bowman, Pres., 816 Ellis Blvd.
- Frank C. Schwarz, C. & F. S., 830 G Ave., W.
- 145—MISSOURI VALLEY, IOWA. 1st-3d Thurs., Walker's Hall.
- Hans Witt, Pres., Box 181.
- Harvey Nichols, C. S.
- 146—VALLEJO, CALIF. 1st-3d Tues., Vallejo Temple Hall.
- Wm. Fountain, Pres., 225A Penn.
- Harry Duthie, C. & F. S., 638 Capitol.
- 149—MARSHALLTOWN, IOWA. 1st-3d Tues., Trades and Labor Assembly Hall, Main St.
- Chas. Vyskocial, Pres., 9 E. Boone.
- W. E. Pouley, C. S., 1110 W. Cole.
- 150—DEANFAIR, ILL. 1st-3d Sun., 2:30 p. m., I. C. System Fed. Hall.
- Thos. H. Monahan, Pres., 511 W. Washington St.
- A. E. Strode, C. S., 325 Hickory.
- 153—GASSAWAY, W. VA. J. E. Perkins, Pres., Gen. Del.
- R. Lee Boone, C. & F. S., Gen. Del.
- 154—PITTSBURGH, PA. 1st-3d Fri., Labor Temple, cor. Washington and Webster Ave.
- Frank Bann, Pres., 304 South Ave. N. S.
- Henry J. Thumel, C. & F. S., 1218 10th St. N. S.
- James P. Carr, B. A., Labor Temple, Wash. and Webster Ave.
- 155—BLOOMINGTON, ILL. 1st-3d Mon., Redmen's Hall, Main and Front Sts.
- H. F. Lambrecht, Pres., 1004 N. Livingston St.
- L. J. Metzner, C. & F. S., 1207 N. Mason.
- 157—SYRACUSE, N. Y. 1st-3d Wed., Bartenders' Hall, Clinton & W. Genesee St.
- J. J. Hardeny, Pres., 214 Hartson.
- Thomas Ranger, C. S., 130 Lydell.
- 161—BOONE, IOWA. 1st-3d Mon., at Electrical Workers' Hall.
- Frank Whitman, Pres., 1603 Benton.
- H. W. Martens, C. & F. S., 1329 Meridan St.
- 163—HOBOKEN, N. J. 2d-4th Fri., 500 Bloomfield St.
- Jeremiah Cahill, Pres., 38 Troy.
- P. L. Growney, C. S., 1019 Willow Ave.
- 165—DULUTH, MINN. 2d-4th Sat., Irwin-Sloan Block, 20th Ave. and Superior St.
- James A. Graham, Pres., 5795 Grand Ave., W. Duluth, Minn.
- Alfred S. Nelson, C. & F. S., 5705 Grand Ave., W. Duluth, Minn.
- 169—DETROIT, MICH. 2d-4th Thurs., 273 Gratiot Ave.
- Charles Komes, Pres., 31 Celaren.
- Chas. F. Aderholdt, C. & F. S., 9 Sylvan St.
- 170—RICHMOND, VA. 1st-3d Wed., Labor Temple, 5th and Marshall Sts.
- R. L. King, Pres., 822 N. 26th St.
- F. C. Blount, F. S., 1101 N. 23d.
- E. M. Daywalt, C. S., 2208 Venable St.
- 173—RALEIGH, N. C. B. F. Long, Pres., 218 N. McDowell.
- J. P. Taylor, C. & F. S., 615 W. North.
- 175—OSWEGO, N. Y. 2d-4th Mon., 8 p. m., Forester Hall, E. Bridge St.
- Wm. Ferrau, Pres., 90 Hart St.
- James Gorman, C. S., 54 Murray.
- 176—ELIZABETH, N. J. 2d-4th Wed., Dahmen Hall, 4th and E. Jersey St.
- John H. Reynolds, Pres., 33 Delaware St.
- Sauel M. Rankin, Secy., 64 Florida.
- E. J. McCarthy, B. A., 67 St.
- Mark's Place, New York City.
- 179—DENVER, COLO. 2d-4th Wed., Room 301 McPhee Bldg., 17th and Glenarm.
- Geo. Gauss, Pres., 3569 Newton.
- H. Shaffroth, C. & F. S., 3749 Wynkoop St.
- 180—MEMPHIS, TENN. Italian Hall, 1st-3d Fri.
- W. T. Funston, Pres., 889 Webster Ave.
- C. F. Gillenwater, C. S., 134 W. Iowa Ave.
- 187—MIAMI, ARIZ. Every Tues., Miami Hall.
- J. W. Landers, Pres.
- Roy Drummond, C. & F. S., Box 1121.
- 191—VICTORIA, B. C. 2d-4th Tues., 1424 Government St.
- A. Clyde, Pres. Sub. P. O. No. 2.
- A. Stewart, C. S., Box 48, Beaumont.
- P. O. Esquimalt, B. C.
- 193—BALTIMORE, MD. Every Tues., Patterson Bldg., Baltimore and Gay Sts.
- John Shanley, Pres.
- James Chaney, F. S., 1419 Patapsica St.
- Phillip Yingling, C. S., 410 E. 27th St.

- 194—VANCOUVER, B. C., CAN-
ADA. 1st-3d Mon., at Labor
Temple.
A. Campbell, Pres., 17th Ave.,
West Vancouver.
A. Fraser, C. S., 1151 Howe St.
195—KEWANEE, ILL. 1st-3d
Fri., O'Donnell's Hall, 3d St.
M. J. Carney, C. S., 411 N. 1st St.
197—ALBANY, N. Y. 31 Green
St., 2d-4th Sat.
J. H. Sullivan, Pres. & E. A., 173
2d St.
Jno. J. Leamy, C. S., 68 Living-
ton Ave.
198—OGDEN, UTAH. 2d-3d
Tues., Union Labor Hall on
24th St., bet. Washington and
Grant.
F. S. Dunn, C. & F. S., 116 23d St.
199—HORTON, KAS. 1st-3d
Thurs., Carman's Hall.
Barney Drew, Pres.
E. S. McGinnis, C. & F. S., Box
622.
200—STATEN ISLAND, N. Y. 1
O. G. T. Hall, W. Brighton,
S. L. N. Y., 1st-3d Mon.
Richard Hough, Pres., 55 Bay
Ave., Pt. Richmond, S. I.
Ethan A. Johnson, C. S., 208
Broadway, W. Brighton S. L.
N. Y.
E. McCarty, B. A., 67 St. Mark's
Place, N. Y. City.
201—WINONA, MINN. Labor
Temple, 1st-3d Tues.
Frank Rice, Pres., 574 W. 7th St.
W. Kukowski, C. S., 176 Mankato
Ave.
J. H. Buchholtz, F. S., 251 E.
King.
204—HONOLULU, H. I. Waverly
Hall, 2d-4th Thurs.
Wm. Brown, Pres., Honolulu Iron
Works.
Thos. Murrey, C. S., 1541 King.
205—SAN FRANCISCO, CALIF. 2d-
4th Tues., Rosch Hall, 15th
and Mission.
Wm. P. Bowser, Pres., 507 20th.
J. M. Enright, C. S., 1431 Delores.
Walter Anderson, F. S., 607 And-
over.
Wm. P. Bowser, B. A., 314 14th.
206—ALGIERS, LA. 2d-4th Fri.,
Renecky Hall.
Jos. Koenig, Pres. & C. S., 825
Elmira Ave.
C. A. Reynolds, F. S., McDonogh-
ville, La.
209—DENISON, TEXAS. 2d-4th
Mon., over State Nat. Bank.
A. McDowell, Pres., 504 W. Ow-
ings St.
S. E. Harris, C. & F. S., 923 W.
Morgan St.
216—EL PASO, TEXAS. 2d-4th
Thurs., Union Labor Hall.
Wm. Beeson, Pres., Gen. Del.
Frank H. Balt, C. S., 114 S. Stan-
ton St.
218—SPRINGFIELD, MASS. 2d-
4th Wed., Winkler's Hall,
Bridges and Water St.
Michael Fitzgerald, Pres. 843
Caren St.
Wm. E. Donovan B. A., 9 Arbor.
Jerb C. Driscoll, C. S., 141 Patton.
220—CHICAGO, ILL. 2d-4th
Tues., Pusey's Hall, 901 E. 75th.
M. Casey, Pres., 6351 Drexel Ave.
A. G. Smith, C. & F. S., 7036 Har-
per Ave.
221—PITTSBURG, KAS. 1st-3d
Tues., Red Men's Hall, W. 3d St.
E. E. Hiett, Pres., 1803 N. Grand
Ave.
P. J. Hiett, C. S., 1801 N. Grand.
222—MART, TEXAS. W. O. W.
Hall.
E. J. Blount, Pres.
G. W. Coates, C. & F. S.
223—UTICA, N. Y. Labor Tem-
ple, 2d Fri.
Louis Wengert, Pres., 8 Wiley St.
Edward Wengert, C. S., 43 Fass
Ave.
225—ELMIRA, N. Y. 2d-4th Sun.,
Trades & Labor Hall, 200 E.
Water St.
A. E. Stevenson, Pres., 964 McGe.
- N. P. Durnin, R. & C. S., 519 Penn
Ave.
226—SALISBURY, N. O. W. O.
W. Hall, Innes and Main Sts.,
2d-4th Fri.
J. J. Garvey, Pres., E. Spencer,
N. C.
P. P. Surratt, C. & F. S., Box 278,
Spencer, N. C.
227—CHICAGO, ILL. Garfield
Park Hall, 4039 W. Madison St.
2d-4th Sat.
John Seldon, Pres., 1107 Keeler
Ave.
Thomas Dean, F. & C. S., 2214 W.
13th St.
229—ROCHESTER, N. Y. 2d-4th
Wed., 14 N. Water St.
W. Weston, Pres., 17 Coffrey
Place.
Robt. Little, C. S., 211 Garfield.
233—OAKLAND, CAL. 2d-4th
Mon., cor. 7th and Peralta Sts.
H. Brown, Pres., 1003 Pine St.
Geo. Young, C. S., 1738 9th St.
235—COLUMBIA, S. C. 2d-4th
Tues., Plumbers' Hall, 1623
Main St.
E. R. Fenell, Pres., 1712 Blanding.
J. W. Bankhead, C. & F. S., 1727
Laurel Ave.
236—MARQUETTE, MICH. 4th
Thurs., E. Seig's Hall.
Albert Bastien, Pres., 347 West
Washington.
Arthur Bourgois, C. S., 817 North
3d St.
237—HARTFORD, CONN. 2d-4th
Wed., at C. L. U. Hall, Central
Row.
James Thornton, Pres., 52 Green.
John J. Reilly, C. S., 46 Pilyny.
238—CLIFTON FORGE, VA. 1st-
3d Fri., Junior Hall.
A. J. Hauer, Pres., 34 Alleghany.
M. L. Steinbuck, C. & R. S., Box
336.
D. G. Clark, F. S., 192 Ridge-
way.
239—ROCKY MOUNT, N. C. 1st-
3d Mon., Machinist Hall, cor.
Sunset and Main Sts.
A. J. Dixon, Pres., 208 Atlantic
A. Ave.
J. S. Wakefield, C. S., Box 224.
241—WASHINGTON, IND. Zin-
kln's Hall, 3d and Vantrees
Sts., 1st-3d Tues.
J. C. Mooney, Pres., East George.
M. W. Luke, C. & F. S., 1097 W.
Main.
242—SPOKANE, WASH. 2d-4th
Wed., Carpenters' Hall, No. 9
Madison St.
Frank Depender, Pres., 611 E.
Indiana Ave.
R. L. Mason, C. S., 218 S. Pitts-
burg St.
243—BELEFONTAINE, O. Last
Sunday in each month, Eagles'
Hall.
H. S. Dickenson, Pres., 329 Gar-
field.
R. E. McNeff, C. & F. S., 105 N.
Elm.
244—SIOUX CITY, IOWA. Labor
Temple, 5th St., near Pierce,
3d Wed.
John Ewing, Pres., 103 Alice St.
Robt. O'Hern, C. S., No. 5 14th.
245—CONCORD, N. H. 2d-4th
Mon., Central Labor Union Hall.
Geo. Tanner, Pres., Hall St.
J. Berryman, C. S., 143 S. Main.
J. R. New, F. S., 120 Broadway.
246—TERRE HAUTE, IND. Cor.
8th and Wabash Ave., 1st-3d
Tues.
H. M. Showalter, Pres., 1410 S.
17th.
Jesse Dukes, C. S., 1561 S. 18th.
F. Wittke, F. S., 1709 N. 12th.
247—TACOMA, WASH. 1st-3d
Mon., Odd Fellows' Hall, S. Ta-
coma.
Andrew Hansen, Pres., 5406 So.
Paks St.
Wm. Polizin, C. & F. S., 5814 S.
Lawrence St., So. Tacoma,
Wash.
- 249—HUNTINGTON, W. VA. Ev-
ery Wed., Thompson Bldg., cor.
20th St. and 3d Ave.
J. S. Myers, Pres., 2720 Collis Ave.
Eugene Brennan, C. & F. S., 823
23d St.
D. C. Dowdy, B. A., 2048 7th
Ave.
250—BOSTON, MASS. Hollis Hall,
724 Washington St., 1st-3d Fri.
James Downey, Pres., 8 Cathed-
ral.
Jeremiah Murphy, C. S. & B. A.,
107 Union Park St.
James Niece, F. S., 1177A Tre-
mont.
254—CHICAGO HEIGHTS, ILL.
1st-3d Mon. at Trades & Labor
Assembly Hall, West End Ave.
Thomas Hines, Pres., 1656 West
End Ave.
Thomas Brooks, C. & F. S., 306
W. 15th Place.
256—POTTSVILLE PA.
Wm. Greaff, Pres., 542 E. Market.
W. Smith, C. S., 215 Front, Min-
arsville, Pa.
259—LIMA, OHIO. 2d-4th Thurs.
334 No. Main.
A. C. Thompson, Pres., East Fin-
ley.
A. K. Grieshelmer, C. S., 329 N.
Elizabeth.
Harry Gunn, F. S., 723 West
Wayne.
265—SMITHVILLE, TEXAS. 1st-
4th Mon.
M. C. Vaughn, Pres., P. O. Box
521.
Guy Cooper, C. & F. S., P. O.
Box 356.
267—MOBERLY, MO. 2nd and 4th
Thurs. Painters' Hall.
J. J. Cadagin, Pres.
F. R. Lee, C. S., 601 Monroe Ave.
276—ST. LOUIS, MO. 2d-4th Fri.,
N. E. Cor. 11th and Locust.
Herbert Abbey, Pres., 2618 Ann Av.
Henry Waeckerle, C. S., 2919A Mi-
ami.
Clyde Stevens, F. S., 1914 N. 21st,
E. St. Louis, Ill.
278—ELKINS, W. VA. 2d-4th
Thurs., Kendall Hall.
Geo. Cade, Pres., 620 Yokem.
C. H. Goodwin, C. & F. S., 3 Cen-
ter St.
279—EDMONTON, ALB. CAN. 1st
Mon., Calder, Edmonton.
Wm. J. Fitzmaurice, Pres., Box
2100, of E. D. & B. C. Ry.
James McLean, C. & F. S., 10236
113th St.
281—NORWOOD, MASS. 2d-4th
Fri., 724 Washington St., Bos-
ton.
Amos Bennett, Pres., 135 Apples-
ton St., Boston, Mass.
Robert Henderson, C. S., 274 Met-
ropolitan Ave., Roslindale, Mass.
284—FREEPORT, ILL. Every
3d Wed. at Blust Hall.
J. W. Daniels, Pres., 27 Shawnee
St.
E. L. Meyers, C. S., 80 Oak St.
286—FORT SCOTT, KAS. 1st-3d
Mon., Redmen's Hall, 111 E.
Wall St.
J. W. McNowen, Pres., 316 Marlon
J. Ave.
J. C. Bonesteel, C. S., 1213 So.
National.
287—KINGSVILLE, TEXAS.
W. B. Poor, Pres.
E. C. Martin, C. S., Box 161.
290—BREMERTON, WASH. Percey
Counter, Pres., Charleston,
Wash.
John Hornby, C. & F. S., Gen.
Del.
292—PARSONS, KAS. 2d-4th
Tues., Moose Hall.
C. Dudding, Pres., 2230 Crawford
St.
E. P. Butler, C. S., 1723 Gabriel.
293—SHAWNEE, OKLA. 2d-4th
Mon., Moose Hall.
Ed. S. Pine, Pres., 711 N. Tucker.
A. D. Ross, C. & F. S., 429 N.
Park Ave.

298-PORTSMOUTH, VA. C. L. U. Hall, 2d-4th Thur.
 M. A. Garris, Pres., 2226 King.
 H. W. Jarrett, F. S., 1822 County.
 Robt. T. Howe, C. S., 826 4th St.
300-WATER VALLEY, MISS. I. O. O. F. Hall, 1st-3d Thur.
 C. H. Baker, Pres. and Treas.
301-CANTON, OHIO, 1st-3d Mon., Switzer Hall, Cherry and 8th Sts.
 Joe Patch, Pres., 1119 5th St., N. E.
 E. J. Gussett, C. & F. S., 1203 McKinley Ave., S. W.
302-MILWAUKEE, WIS. 1st-3d Sat., Lipp's Hall, 3d and Prairie.
 Henry J. Murray, Pres., 113 29th St.
 E. P. Youngbluth, C. S., 35 35th St.
 John DuBrucq, F. S., 317½ 4th Ave.
305-PORT ARTHUR, TEXAS. 2d-4th Tues., Labor Hall.
 C. L. Bragg, Pres., Gen. Del.
 T. O. Riley, C. S. & B. A., Box 683.
 James Rose, F. S., Box 8.
306-EVANSTON, WYO. I. O. O. F. Hall, 1st-3d Wed.
 John T. Whittle, Pres., County Road.
 J. H. Willoughby, C. S., Box 419.
311-SOUTH KAUKAUNA, WIS. 2d-4th Mon., Odd Fellows' Hall.
 Louis Crevier, Pres.
 Chas. Robedeau, C. & R. S., P. O. Box 279.
312-SELMA, ALA. 1st-3d Wed., at R. R. Y. M. C. A.
 J. F. Ryals, Pres.
 W. P. Fawcett, C. S., 1509 Selma.
315-McCOMB, MISS. Central Trade and Labor Hall, 1st-3d Wed. at 7:30.
 R. O. Bean, Pres. & C. S., Box 684.
317-RICHMOND, CALIF. 2d-4th Fri., Barnman's Hall, 19th St.
 Frank Mallinson, Pres., care Randall Hotel.
 Wm. Jones, C. & F. S., Box 634.
318-PITTSBURGH, PA. 1st-3d Mon., Hazlewood Bank Bldg., cor. 2d and Hazlewood.
 W. Mertz, Pres., Path Alley.
 T. A. Hudson, F. S., 310 Johnston Ave.
326-MERIDAN, MISS. B. L. E. Hall, 5th St. and 40th Ave., 1st-3d Thurs.
 J. A. Smitheren, Pres., 511 40th Ave.
 J. E. Alexander, C. & F. S., 3817 38th St.
322-ST. LOUIS, MO. 1st-3d Tues., Reddy Hall, 3100 Chautau.
 John Coots, Pres., 2726 Washington Ave.
 M. Renth, C. S., 4537 Michigan Ave.
323-CHICKASHA, OKLA. 2d-4th Fri., Labor Hall, 4th and Choctaw.
 C. A. Chincholl, Pres., P. O. Box 502.
 W. L. Harkins, C. & F. S., 528 S. 16th.
325-SHREVEPORT, LA. K. of P. Hall, over West End Drug Store, 2d-4th Thurs.
 H. Abbott, Pres., 1542 Luchina Ave.
 H. W. Huff, C. S., 1863 Texas Av.
329-CUMBERLAND, MD. 1st-3d Mon., Odd Fellows' Hall.
 C. C. Bowen, Pres., 107 W. 1st.
 Geo. H. Little, C. S., 401 E. 1st.
 J. R. Beck, F. S., 106 W. 1st.
334-PRINCETON, IND. 2d-4th Tues., Redmen's Hall.
 Joe Myers, Pres., 1101 S. Race.
 J. E. Clark, C. & F. S., 702 S. Prince.
335-GRAND JUNCTION, COLO. 2d-4th Fri., Eagles' Hall.
 G. R. Stoll, Pres., 337 White.
 E. H. Friend, C. & F. S., 303 Pitkin Ave.

339-SPARKS, NEV. 2d-4th Wed., Engineers' Hall.
 Wm. Daseier, Pres., P. O. Box 214.
 C. M. Crouch, C. S., P. O. Box 204.
340-HERINGTON, KAS. 1st-3d Sat., I. O. O. F. Hall.
 John Olson, Pres.
 J. E. Anderson, C. S., 303 N. 8th.
341-PHILADELPHIA, PA. 2d-4th Tues., 8 p. m., Labor Headquarters, 232 N. 9th St.
 Wm. J. Boyle, Pres., 208 N. 58th St.
 Chas. Heberly, C. S., 3084 Aramingo Ave.
344-SHEFFIELD, ALA. 1st-3d Wed. at I. O. O. F. Hall, Montgomery Ave.
 W. H. Wilson, Pres., Tuscumbia, Ala.
 E. T. Holland, C. S., Box 65.
345-SAN ANTONIO, TEXAS. Trade Council Hall, 2d-4th Thurs.
 F. E. Hamilton, Pres., 2103 W. Travis.
 E. H. Frick, C. & F. S., 1233 W. Traves Ave.
 Delrympel, B. A., 410 River Ave.
346-TRENTON, MO. 1st-3d Tues., at Cutlip's Hall.
 Walter Mason, Pres., 1736 Lula Ave.
 Geo. W. Singer, C. & F. S., 1801 Maine St.
353-HANNIBAL, MO. Wm. James, Pres., 300 Rock.
 J. J. Sughnee, C. & F. S., 836 Grand Ave.
354-BROOKFIELD, MO. 1st-3d Tues., 212 N. Main St.
 Martin Murphy, Pres., 291 Elm St.
 J. K. Burnham, C. S., 212 W. John St.
355-CONNEAUT, OHIO. 2d-4th Fri., Stationary Eng. Hall, Main St.
 Chas. Ward, Pres., 685 Lakeview Ave.
 J. M. Irish, C. S., 530 Sherman.
 E. J. Dickson, F. S., 815 Main.
356-HAMMOND, IND. 1st-3d Wed., Long's Hall, State St.
 James Boyle, Pres.
 Thomas Boyle, C. S., 264 State-line St.
360-LAFAYETTE, IND. 1st-3d Thurs., Bartenders' Hall, 3d and Ferry Pt.
 Fred Ramp, Pres., 1601 N. 12th.
 Wm. Peterson, C. S., 426 Lingle.
 James Goldsberry, F. S.
363-EAST ST. LOUIS, ILL. 1st-3d Fri., Wyant Hall, Broadway and Main.
 James Roose, Pres., 318 S. 5th.
 John Roche, C. & F. S., 614 Ohio Ave.
364-COVINGTON, KY. 1st-3d Mon., Heldels' Hall, N. W. cor. 21st and Russell Sts.
 Herman Dedden, Pres., 19th and Euclid Ave.
 R. F. Powers, C. S., 2011 Pearl St.
367-HAVRE, MONT. 3d Sat., Oxford Hall.
 Kyle Cope, Pres., 1428 3rd St.
 Elmer Burns, C. S., 1027 2nd St.
369-ALEXANDRIA, VA. 1st Thur. in month during summer months, 108 N. Patrick St.
 James Moran, Pres., 1219 Duke.
 M. Gemeny, R. & F. S., 1514 King.
371-LOWELL, MASS. 1st-3d Sat.
 James Lanigan, Pres.
 J. J. Cunningham, C. S., 656 Gorham.
377-MOLINE, ILL. 1st-3d Fri., Moline Industrial Home, cor. 14th St. and 5th Ave.
 Carl Robison, Pres., 7th St., Illinois, Ill.
 John Fulton, F. S., 7th St., Illinois, Ill.

Charles McGowan, B. A., 7th St., Illinois, Ill.
 C. H. Kizer, C. S., Box 581, Illinois, Ill.
 Walter S. Schneider, E. A., 1317 38th St., Rock Island, Ill.
378-MONCTON, N. B., CAN. 2d-4th Fri., Sons of Temperance Hall.
 Alex McDougall, Pres., 143 High St.
 R. D. Donnelly, C. S., 69 Downing St.
379-McADAM JUNCTION, N. B., CAN. 2d-4th Fri., Orange Hall.
 Geo. Guest, Pres.
 A. J. McLaggan, C. S.
381-AMARILLO, TEXAS. 1007 Buchanan.
 M. L. Parker, Pres., Box 407.
 Joe Wilson, C. S., 1007 Buchanan.
383-CHILDRESS, TEXAS. 2d-4th Fri., at 7:30 p. m., in Labor Temple.
 Mack Leopold, Pres., P. O. Box 835.
 J. M. Neal, C. S.
384-PERU, IND. 2d-4th Tues., Labor Trades Hall.
 Floyd W. Seitz, Pres., 164 N. Lafayette.
 W. H. Hawkins, F. & C. S., 404 W. 12th St.
 Frank Sullivan, B. A., 133 W. 3d.
388-MECHANICSVILLE, N. Y. 2d and last Tues., A. O. H. Hall, North Main St.
 James S. Kennedy, Pres., S. Second Ave.
 Sidney Crozier, C. S., 28 Railroad.
 Chas. Chadman, F. S., 112 N. 2d.
390-TEINIDAD, COLO. 2d-4th Wed., Labor Union Hall, East Main St.
 W. T. Flynn, Pres., Arizona Ave.
 A. A. Loftus, F. & C. S., 107 Goddard St.
391-DAVENPORT, IOWA. 2d-4th Fri., Danish Hall.
 John Schach, Pres., 516 ¼ W. 3d.
 R. F. Stewart, C. S., 616 Tremont Ave.
 W. C. Richards, F. S., 1938 Bridge Ave.
392-CALGARY, ALBERTA, CAN. 3d Sat., 2:30 p. m., Labor Temple.
 F. Chambers, Pres., Ogden, P. O. F. Adams, C. S., Ogden, P. O. Alb.
393-GOODLAND, KAS. 1st-3d Tues., Calvert & Sparks' Law Office.
 S. E. Braffett, Pres.
 Earl Crause, C. & F. S.
395-NORTH FOND DU LAC, WIS. 1st-3d Fri., Trades and Labor Hall, cor. 3d and Main.
 Carl Deyer, Pres., 615 Michigan Ave.
 Jos. A. Huntsinger, C. S., 223 E. Johnson, Fond du Lac, Wis.
396-NORWICH, N. Y. 4th Wed. in Cook Block.
 James E. Callahan, Pres., 1 Columbia St.
 Julius Schraft, C. & F. S., 13 Davis.
398-RIVIERE DU LOUP, QUEBEC, CANADA. 2d-4th Mon., Rioux Hall.
 Mag. Bourgoin, Pres., River du Loup Station.
 Jos. Beaulieu, B. A., Blaisville.
 Ludger Oullet, C. & F. S., Blaisville.
400-MIDDLETON, N. Y. 1st-3d Fri., Odd Fellows' Hall.
 Wm. Springer, Pres., 55 Beattie Ave.
 Wm. E. Appel, F. S., 378 North.
 Chris Smith, C. S., 381 North St.
402-PORTSMOUTH, OHIO. 2d-4th Fri., C. L. U. Hall.
 Fred Miller, Pres., cor Robinson and Summit St.
 Edward Snyder, C. S., 2113 17th St.

- 403—HOISINGTON, KAS. I. O. O. F. Hall, 1st-3d Mon.
Ray Bowler, Pres., P. O. Box 72.
C. W. Cramer, C. & F. S., Box 494.
- 405—BLUEFIELD, W. VA. 1st-3d Fri., Masonic Temple.
E. K. Collins, Pres., Princeton Ave. E.
W. F. Dupree, C. & F. S., Gen. Del.
- 406—VAN WERT, OHIO. 3d Thurs., Suite 226 Home Guard Bldg.
E. K. Murlin, Pres., 208 N. Race.
- 410—SAN FRANCISCO, CAL. 2d-4th Wed. Labor Temple, 16th and California.
Ed Hanny, Pres., 518 Alvarado.
L. Kevie, C. S., 208 Springdale Ave.
- 413—ST. THOMAS, ONTARIO, CAN. 2d-4th Tues., Machinists' Hall, Talbot St.
Frederick Brooks, Pres., 5 Maama Frank Roberts, C. S., 61 Wilson
- 414—ONEONTA, N. Y. 1st Wed. and 3rd Sun., 2:30 p. m., Redmen's Hall.
James Walsh, Pres., 51 Church.
David Lawrie, C. & F. S., 73 W. Broadway.
- 415—JACKSONVILLE, ILL. F. McKenna, C. S., 475 E. State.
- 417—NORTH BAY, ONT., CAN. 2d-4th Mon., L. O. L. Hall.
A. E. Lye, Pres., Box 799.
Frank Crotcher, C. S., Box 1778.
- 418—NEODESHA, KAS. 1st-3d Sat., Baldwin Hall.
Chas. Brown, Pres.
E. P. Reddick, C. S., Box 775.
A. F. Bingham, B. A.
- 419—SOMERSET, KY. 1st-3d Tues., at Owen's Hall.
Peter Letter, Pres., Sta. A.
J. A. Schofield, C. & F. S., Sta. A.
- 421—HAMILTON, ONT. 1st-3d Fri., Labor Hall, John St. So.
L. Lawton, Pres., No. 21 Tuckett.
F. Honison, C. & F. S., 6 Bristol.
- 422—SANFORD, FLA. 2d-4th Wed., Eagles' Hall.
H. B. Furden, Pres.
J. H. Shuman, C. S., 115 W. 9th.
- 423—BIG SPRINGS, TEX. 2d-4th Tues., I. O. O. F. Hall.
D. D. Crawford, Pres., cor. Gregg and 3d.
W. P. Warren, C. & F. S., 201 W. 1st.
- 424—FLORENCE, S. O. 2d Thurs., Y. M. C. A.
L. H. Mims, Pres., 222 Covington St.
A. H. Dickman, C. & F. S., 609 Day St.
- 425—WAXCROSS, GA. 1st-3d Thurs., Loot Hitch Bldg.
C. M. Schultz, Pres., 37 Stephens Ave.
L. J. Flohr, C. & F. S., Box 236.
- 427—SALIDA, COLO. 2d-4th Thurs., Adilas Hall.
H. F. Jones, Pres., 135 E. Sacket Ave.
Wm. Dargavel, C. S., 821 E. St.
- 428—NORFOLK, VA. 2d-4th Wed., Pythian Castle Hall.
W. M. Wood, Pres., 617 Liberty St., Berkeley, Va.
Thos. Callahan, C. & F. S., 116 Middleton St., Berkeley, Va.
- 430—CAPE GIRARDEAU, MO. 1st-3d Tues., Haas' Hall.
Geo. Stanley, Pres., 223 Frederick St.
Oscar O. Berry, F. S., 415 S. Frederick St.
- 431—BOSTON, MASS. 2d Thurs., Naomi Hall, 724 Washington.
Thos. R. Keenan, C. S., 80 W. 5th St., So. Boston.
- 434—CHICAGO, ILL. 2d-4th Wed., Boulevard Hall, 55th and Halstead Sts.
H. Fischer, Pres., 6507 Sangamon.
L. M. Craft, C. S., 715 E. 48th.
- 435—BRISTOL, TENN. 2d-4th Fri., Sixth and Shelby Sta.
M. C. Cooper, Pres., V. & S. W. Ry. Shops.
J. B. Wood, C. & F. S., 27 Lancaster St., Bristol, Va.
- 436—COLUMBUS, GA. 1st-3d Fri., Trades and Labor Assembly Hall.
R. S. Barry, Pres., 911 4th Ave.
E. W. McMichael, C. & F. S., 411 10th St.
- 437—TWO HARBORS, MINN. 2d and last Thurs., Iron Dock Grove Hall.
Christ. Anderson, Pres.
Charles Larson, C. & F. S., Box 298.
- 438—GALETON, PA. 2d-4th Tues., Eagles' Hall.
Daniel B. Shine, C. S., 30 First St.
- 439—FAIRBURY, NEB. 4th Wed., K. of L. S. Hall.
E. Z. Milliken, C. & F. S., P. O. Box 167.
Fred Kurat, B. A.
- 440—BELLE PLAINE, IOWA. 2d-4th Mon., Fireman's Hall.
Charles Corns, Pres., 10th St.
Warren Wheeler, C. S., P. O. Box 608.
- 442—NEW ORLEANS, LA. 3d Tues., McMahon Hall, 1112 Des. James Miller, Pres., 1204 So. Franklin.
John Mocklin, C. & F. S., 606 S. Telemachus St.
- 444—CONNELSVILLE, PA. J. W. Easley, C. S., 517 N. Pgh.
- 446—ALAMOSA, COLO. 2d-4th Wed., Trades Assembly Hall.
Albert Jacobson, Pres.
Chas. F. Darling, C. S., Box 64.
- 447—DECATUR, ILL. 1st-3d Tues., Ashley Hall, Mason Temple.
Jas. Gray, Pres., 817 N. Broadway.
Chas. J. Younger, C. & F. S., 432 E. King St.
- 448—MONTGOMERY, ALA. 1st-3d Wed., Young's Hall.
J. A. Redding, Pres., 316 Columbus.
- 449—FORD, C. S., 75 Morgan Ave.
- 449—SAPULPA, OKLA. 2d-4th Mon., Moose Hall.
M. E. Lange, Pres., 913 E. Hobson.
Irwin Shipman, C. S., Box 338.
- 450—WASHINGTON, D. C. 2d-4th Wed., New Masonic Hall, 8th and F Sts., N. E.
A. W. Sherier, Pres., 106 15th S. E.
- W. F. Kilroy, C. S., 11 I St., N. E.
- 451—WINNIPEG, MAN., CAN. 2d-4th Fri., Labor Temple.
D. Nelson, Pres., 323 Morley Ave.
F. Snare, C. & F. S., 263 Bradford St., St. James.
- 452—COFFERHILL, TENN. 1st-3d Tues., I. O. O. F. Hall.
Chas. Frenz, Pres., Box 711.
E. N. Hall, C. S., Box 382.
- 454—CHICAGO, ILL. 2d-4th Thurs., Persey Hall.
Walter Love, Pres., 752 E. 69th St.
E. R. Dettmer, C. S., 9245 Stoney Island Ave.
- 455—SHERMAN, TEXAS. 2d-4th Thurs., Fulton Hall.
C. S. Hanshey, Pres., Old Phone 893.
John W. Plexco, C. S., 424 E. Gribble.
- 463—BALBOA, CANAL ZONE, PANAMA. 1st-3d Fri., Ancon Lodge Hall.
A. R. R. Charters, Pres., Carozal, C. Z.
W. H. Keenan, C. & F. S., Box 26, Culebra, C. Z.
- 464—PALESTINE, TEXAS. Labor Temple, 2d-4th Wed.
W. B. Graham, Pres., 106 Green.
J. D. Mallette, C. & F. S., 503 La.
- 466—REVELSTOKE, B. C. 3rd Sat., Seabark Hall.
M. M. Keller, Pres., Box 138.
A. Harris, C. & F. S., Box 138.
- 467—PORTSMOUTH, N. H. 3d Wed., Eagles' Hall.
John Quinn, Pres., Court St.
Alfred Olson, C. S., Box 27, Kittery, Me.
- 469—TERRELL, TEXAS. 2d-4th Fri., Trades and Labor Hall, 202 E. Moore Ave.
J. R. Poston, Pres., 603 E. College St.
R. E. O'Reilly, C. S., 906 E. Moore Ave.
- 471—CRISTOBAL, C. Z. 2d-4th Thurs., Bldg. No. 147.
J. Z. Knapp, Pres.
A. P. Elkert, C. & F. S., Box 369.
- 473—HELPER, UTAH. 1st-3d Wed., K. of P. Hall.
Wm. R. Welsh, Pres.
H. W. Smith, C. & F. S., Box 411.
- 474—OLAND ISLAND, NEB. 1st-3d Mon., City Hall, 2d St.
H. W. Hunt, Pres.
Sherman Aldrich, F. S., 1014 E. 4th St.
- 476—DALHART, TEXAS. 3d Fri., Socialist Hall.
H. C. Fritche, Pres.
Theo P. Nelson, C. & F. S., Box 232.
- 478—MOOSE JAW, SASKATCHEWAN, CANADA. 2d-4th Mon., Trades and Labor Hall, Main St.
Wm. Gillies, Pres., 364 Fairford St., W.
Geo. Walters, C. S., Broadview O.
- 479—DEVIL'S LAKE, N. DAK. 1st Fri., Opera House Hall.
J. A. Thompson, Pres., Box 324.
M. J. Feeney, C. S., Box 148.
- 481—LYNDONVILLE, VT. 1st-3d Wed., Eaton's Hall.
E. A. Hinds, Pres.
B. A. Phillips, C. & R. S., Box 121.
Lyndon Center, Vt.
J. M. Bresson, B. A.
- 482—ALTON, ILL. Schwartzbeck Hall, 3d and Ridge. 1st-3d Tues.
D. Stafford, Pres., 1009 E. 5th St.
Robt. Dale, C. S., 3008 Edwards.
- 485—GREEN BAY, WIS. 1st-3d Thurs.
John Christianson, Pres., 822 S. Maple Ave.
John Slater, C. & F. S., 425 5th St.
J. L. Callahan, B. A., 3606 Clifton Ave., Milwaukee, Wis.
- 486—TYLER, TEXAS. 1st-3d Wed., K. O. T. M. Hall.
J. A. Fuller, Pres., 1116 Irvin.
J. M. McCarty, C. & F. S., 221 Center St.
C. R. Welch, B. A., 1428 N. Fannie Ave.
- 491—VALLEY JUNCTION, IOWA. 1st-3d Tues., I. O. O. F. Hall.
Frank S. Hoppe, Pres.
J. C. Carroll, C. S., Box 165.
Geo. W. Pring, B. A., Treas.
- 492—WORCESTER, MASS. 1st-3d Thur., Foresters' Hall.
Patrick I. Curran, Pres., 4 Wil-son.
John Casey, C. S., 61 E. Central.
- 493—NEW CASTLE, PA. Jan. 12, 1915, and every other Wed., Trades Assembly Hall.
D. E. Sturdevant, Pres., 516 D. Waldo.
E. A. Horchler, C. & F. S., 906 E. Washington.
- 495—HATTIESBURG, MISS. 1st-3d Tues., 500 Boule St.
C. W. LeBlanc, Pres., 107 Evans.
A. H. Waddell, C. & F. S., 500 Boule.
- 496—HURON, SOUTH DAKOTA. 2d Sun. and 4th Fri., Labor Hall.
Peter Paluszak, Pres.
C. Storkson, C. & F. S., 228 Beach St.

- 500 — EVERETT, WASH. 2d-4th Tues., Labor Temple, 3506 Everett Ave.
Wm. Faulke, Pres., 3506 1/2 Everett Ave.
Bert Bloomington, C. S., 3523 Smith Ave.
- 501—WACO, TEXAS. 2d-4th Fri., Labor Hall.
Chas. Bullock, Pres., R. F. D. No. 2.
Wm. Dickerson, C. & F. S., 810 Cleveland St.
- 502—TEAGUE, TEXAS. 1st-3d Mon., Davis Hall.
Thos. McGrath, Pres., Box 244.
J. D. Clayton, C. S.
- 503—FITZGERALD, GA. 1st-3d Wed., I. O. O. F. Hall.
M. J. Mauns, Pres., P. O. Box 686.
A. B. Campbell, C. S.
- 504—MUSKOGEE, OKLA. 1st-3d Wed., Carpenters' Hall.
Guy Carver, Pres., 1220 Baltimore.
W. H. Hammond, C. & F. S., Gen. Del.
- 505—FORT WILLIAM, ONTARIO, CAN. 1st-3d Fri., Electricians' Hall, Murphy Block, Simpson Ave.
James Duncan, Pres.
A. Cruickshank, C. S., 1007 Minn. Ave.
- 507—ATCHISON, KAS. 1st-3d Mon., Fireman's Hall, 1521 Main St.
J. F. Coyle, Pres., 1418 Kansas Ave.
John J. Frohott, C. & F. S., 1420 Kansas Ave.
- 509—JACKSON, OHIO. 4th Tues., Hibernian Hall.
O. B. Reynolds, Pres., 77 High St.
Albert Edmonds, C. S., 77 Hunt St.
J. B. Fillingier, B. A. and Journal Cor., 53 Main St.
- 510—CEDARTOWN, GA. E. M. Kendrick, Pres.
I. C. Smith, C. S.
- 511—WHISTLER, ALA. 1st-3d Mon., I. O. O. F. Hall.
J. L. Scholls, Pres.
C. C. Crone, C. S., 209 Bauregard.
- 515—EAST CAMBRIDGE, MASS. Engineers' Hall, 164 Canal St., Boston, Mass., 1st-3d Fri.
Geo. A. Mitchell, Pres., 39 S. Russell St., Boston, Mass.
Joseph Irwin, C. & F. S., 36 Glendale St., Everett, Mass.
- 517—GREENFIELD, MASS. 2d-4th Sat., Forester Hall.
Patrick Kelley, Pres., 3 Devens.
Tha Scannell, C. & F. S., 6 Russell St.
- 518 — WICHITA, KAS. 1st-3d Thurs., 216 N. Main St.
G. W. Thompson, Pres., 2127 University Ave.
O. E. Mase, C. S., 1415 W. Maple.
- 520—MILES CITY, MONT. 2d-4th Fri., Wilbaux Hall, 7th and Main.
P. J. Gallagher, Pres., 602 N. Lake St.
Chas. E. Cook, C. & F. S., 119 N. Strevelle.
- 521—VAN BUREN, ARK. 1st-3d Thurs., W. O. W. Hall.
Charles Pathast, Pres.
Otto Fyles, C. S., Box 343.
C. A. McDonald, B. A., 4416 Norledge, Kansas City, Mo.
- 522—EL RENO, OKLA. 1st-3d Tues., Redmen's Hall.
H. E. Hart, Pres., Box 624.
H. A. Mathews, C. & F. S., Box 12.
- 523—PRATT, KAS. 2d-4th Tues., at S. T. Sample's residence.
W. F. Stephen, Pres., 701 N. Ninirscach St.
F. W. Sharpe, C. S., Box 73.
- 524—MURPHYSBORO, ILL. 2d-4th Wed., Machinists' Hall, 167 S. 10th.
A. R. McFarland, Pres., 638 N. 8th.
E. P. Herin, C. & F. S., 2107 Wall.
- 525—HINTON, W. VA. 1st-3d Mon., Big Four Bldg.
W. L. Taylor, Pres., 108 Grace St.
C. L. Barnette, C. & F. S. & B. A., 419 Summer Ave.
- 528—DEER LODGE, MONT. 2d-4th Fri., I. O. O. F. Hall.
T. J. Messing, Pres.
J. H. Thomas, C. & F. S., P. O. Box 877.
- 520—WINNIPEG, MAN., CAN. 1st Sun., Campbell Hall, Transcona, 3rd Sun., Labor Temple, Winnipeg, 3 p. m.
A. Orr, Pres., 3 Gallagher Ave., Brooklands, Man., Can.
Robt. Clark, C. & F. S., 471 1/2 Portage Ave.
- 530—SPRINGFIELD, MO. 3d Mon., Dengeldem's Hall.
J. W. Reddick, Pres., 817 Lincoln.
John Cain, C. & F. S., 507 Fort.
A. F. Bingham, B. A., 701 Lombard St.
- 531—CHAFFEE, MO. 1st-3d Thurs., City Hall.
T. C. Davis, Pres.
C. P. Bourion, C. & F. S., Box 365.
- 537—COVINGTON, KY. 2d-4th Fri., Workman Hall, 122 Pike St.
A. J. Pope, Pres. & B. A., 1817 Scott St.
John J. Fielding, C. & F. S., 1341 Holman.
- 541—BEDFORD, IND. 2d-4th Thurs., Labor Union Hall.
Dan J. Kane, Pres., 511 N. I St.
Chas. J. Bordenet, C. S., 628 N. I St.
- 542—COFFEYVILLE, KAS. Labor Temple, 2d-4th Wed.
R. M. Jones, Pres., 807 W. 14th.
J. C. Morrow, C. & F. S., 613 W. 4th St.
- 543—WICHITA, KAS. 216 N. Main St., 2d-4th Wed.
E. C. Hadler, Pres., 358 Lulu Ave.
C. E. Grove, C. & F. S., 701 W. Central.
- 546—MONETT, MO. 1st-3d Tues., K. C. Hall.
David Elder, Pres., 406 9th St.
John Linebarger, C. & F. S., 214 Pearl St.
- 547—CARBONDALE, PA. Pughanas Hall, 2d-4th Fri.
E. T. Dickenson, Pres., 142 Wyoming.
James A. Flannery, C. & F. S., Box 185.
Wilkes Barre Representative, T. J. Cavan, 60 Chester St., Wilkes Barre, Pa.
- 548—TORONTO, CAN. 2d-4th Wed., Labor Temple, Church Jas. Dobson, Pres., 280 Perth Ave.
W. H. Watson, C. S., 162 Annette St.
- 549—MIDDLEPORT, O. 1st-3d Tues., Firemen's Hall.
Lester Cunningham, Pres.
Perry Cooper, C. & F. S.
- 551—PRINCETON, W. VA. Castle Hall, 1st-3d Thurs.
J. J. Bower, Pres., 576 Bluefield.
J. H. Blackwell, C. S., Box 312.
- 553—LA GRANGE, ORE. Wm. Andis, Pres., 1506 V Ave.
Jas. H. Gutridge, C. S., Box 197.
- 556—OKLAHOMA CITY, OKLA. C. S. Cochran, Pres., 406 W. Frisco.
E. F. Ryan, C. & F. S., 400 West Frisco.
- 557—WILLIAMSON, W. VA. 2d-3d Tues., 3d Ave.
- Bert Williams, Pres.
H. W. Bias, C. & F. S., 124 Oak.
- 565—FALLS CITY, NEB. 1st-3d Thurs., W. O. W. Hall.
C. W. Jonas, Pres.
E. Woodington, C. & F. S., 710 E. 16th St.
- 567—SAN ANGELO, TEX. 1st-3d Wed., Eagles' Hall.
O. M. Seay, Pres., 821 W. Ave. I.
R. L. Wright, C. S., 27 West Ave. I.
- 568—TACOMA, WASH. Maccabee Hall, 1109 1/2 C St., 2d-4th Thurs.
Chas. Manning, Pres., 5808 S. Lawrence St.
A. W. Rickett, C. & F. S., 615 So. State.
- 570—HIGH SPRINGS, FLA. H. A. Smith, Pres., P. O. Box 273.
F. C. Magerstaadt, C. S.
- 571—DE PERE, WIS. De Both Hall, 1st Sun.-3d Wed.
T. J. McDonald, Pres., Lock Box 44, W. De Pere, Wis.
A. B. Steinfeldt, R. S., P. O. Box 207.
- 573—LANSFORD, PA. Wm. J. Williams, C. S., 843 East Ridge St.
- 575—VILLA GROVE, ILL. 1st-3d Fri., Red Men's Hall.
James Tally, Pres.
A. Welch, C. S.
H. A. Downes, F. S.
- 576—WICHITA FALLS, TEX. 2d-4th Thurs., Labor Hall.
J. H. Gibson, Pres., 309 Lee St.
C. K. Matthews, C. & F. S., Box 760.
C. H. Shoemaker, B. A., Box 18, Healdton, Okla.
- 577—CUMBERLAND, MD. 1st-3d Thurs., Trades Council Hall.
E. H. Steahley, Pres., 403 Mechanic.
C. E. Dowlan, C. & F. S., 14 Emily.
- 578—HAGERSTOWN, MD. Moose Hall, 2d-4th Thurs.
L. J. Murray, Pres., 25 Vine St.
Fred H. Stouffer, C. S., 817 Summit Ave.
- 579—KEYSER, W. VA. 1st-3d Tues., City Building.
W. H. Wolf, Pres., Gilmore St.
P. R. Dougan, F. S., Gilmore St.
Joseph F. Hines, C. S., Piedmont, W. Va.
- 581—MONTPELIER, O. 1st-3d Wed., Ry. Trainmen's Hall.
S. Brown, Pres.
J. Birmingham, C. S.
- 582—BATON ROUGE, LA. 2d-4th Thurs., Odd Fellows' Hall, 3d St.
W. P. Kidd, Pres., 302 St. Phillip St.
S. V. Acosta, C. & F. S., 918 St. Ferdinand St.
- 583—NEVADA, MO. Socialist Hall, Hall, So. Main St., 1st-3d Thurs.
A. C. LeQuellec, Pres., 520 E. Cherry.
L. E. Whitehead, C. & F. S., R. F. D. No. 1.
C. A. McDonald, B. A., 4416 Norledge, K. C., Mo.
- 584—LUDLOW, KY. 1st-3d Thurs., Morley Hall.
Thos. Jackson, Pres., 17 Pherry.
H. J. Stroer, C. S., 833 Main, Covington, Ky.
- 585—BOSTON, MASS. 1st Thurs., 8 p. m., and 3d Sun., 2-30, Hemstead Hall, 724 Washington St.
Wm. E. McNabb, Pres., 263 Chelsea, E. Boston, Mass.
Daniel B. McInnes, C. S., 288 Marginal Ave., E. Boston, Mass.
Daniel N. Generson, B. A., 17 Bul-lard, Dorchester, Mass.
James Vincent, F. S., 77 Lavin Hill.

586—SLATER, MO. 2d-4th Mon., I. O. O. F. Hall. Chas. Crawford, Pres. Andy Phelps, C. & F. S.
587—BEAUMONT, TEX. 2d-4th Thurs., Trades Assembly Hall, O. H. Greer, Pres., Box 149. T. C. Maddy, F. & C. S., 229 Fulton.
 M. J. Ickles, B. A., 249 College.
588—CHICAGO, ILL. 2d-4th Tues., Koop's Hall, California & North Aves. Thomas Godfrey, Pres., 930 E. 44th St. John McNamee, C. & F. S., 2613 Iowa St.
589—MILWAUKEE, WIS. 2d-4th Thurs., 923 E. Water St. Frank Thines, Pres., 729 5th. M. J. Gleason, C. & F. S., 202 Michigan St.
590—MONROE, LA. 1st Fri., 615 A. St. J. W. Grant, Pres., 501 Wood St. J. J. Devaux, C. & F. S., 615 Calypso St.
591—GLENDEVE, MONT. 2d-4th Fri., Noderhoff Hall. V. B. O'Connor, Pres. & C. S., 217 Valentine St. J. J. Shinault, F. S., Gen. Del.
592—TULSA, OKLA. 2d-4th Sat. 214 1/2 S. Main. J. E. Dixon, Pres.

C. E. Houghton, Act. Secy, 215 Reeder Bldg.
593—CLIFTON, ARIZ. Every Sat., Carpenters' Hall. H. Halter, Pres., Box 1252. Gus Kuentz, C. & F. S., Box 186.
594—STANBURY, MO. 2d-4th Tues., K. of P. Hall. John Inman, Pres. E. W. McNew, C. S.
595—AVERY, IDAHO. 2d-4th Mon., Godfrey's Home, West Avery. A. Anderson, C. & F. S., Gen. Del.
596—CASPER, WYO. 2d-4th Mon. C. C. Starr, Pres., P. O. Box 71. A. R. Witz, C. & F. S., P. O. Box 172.
597—ESCANABA, MICH. 1st-3d Thurs., Lemmer Hall, Ludington St. Jos. Vickers, Pres., 506 Wells Ave. Wm. Grosnich, C. & F. S., 714 Wells Ave.
598—SALAMANCA, N. Y. 1st-3d Mon., 3 Maple St. A. G. Frey, Pres., 185 E. State St. D. J. Carpenter, C. & F. S., 3 Maple St.
599—FARGO, ARK. 1st-3d Thurs., Carpenters' Hall. J. W. Frey, Pres., 221 S. 3d St. A. Johnson, C. & F. S., 216 N. 5th Ave. C. A. McDonald, B. A., 4416 Norledge, Kansas City, Mo.

600—AKRON, OHIO. Walsh Bldg. Jas. Shaughnessy, Pres., 876 So. Main St. R. C. Price, C. & F. S., 150 Adams St.
601—QUEBEC, CAN. J. Thompson, Pres., 130 3d St. Simollon. G. Dery, C. S., 153 4th St., Limorlow, Can.
602—GREAT FALLS, MONT. 1st-3d Tues., Judge Safford's Court Room. Frank Yelocan, Pres., 1500 8th Ave. N. Roy J. Preston, C. & F. S., 706 8th Ave. So.
603—OTHELLO, WASH. 1st-3d Mon., I. O. O. F. Hall. O. W. Bohusock, Pres. W. O. Clark, C. S., Box 137.
604—JOLIETTE, QUE., CAN. H. Fournier, Pres., Gen. Del. W. C. Williams, C. & F. S., Box 228.
605—TOOELE, UTAH. 2d-4th Thurs., Fraternal Hall. D. B. Sullivan, Pres. L. Fornoff, F. S., Box 294.
606—MORRIDGE, S. D. 1st-3d Thurs., Moose Hall. J. P. Schmicrath, Pres., Box 721. H. L. Adams, C. & F. S., Box 168.

International Officers of the Ladies' Auxiliary

MRS. J. W. EDWARDS.....President
 1224 S. 9th East St., Salt Lake City, Utah.
MRS. F. E. REINEMEYER ...1st Vice-President
 Tauroome Ave., Kansas City, Kans.

MRS. MOLLIE GEARY.....2nd Vice-President
 6428 S. Albany St., Chicago, Ill.
MRS. A. F. BINGHAM.....Secretary-Treasurer
 791 Lombard St., Springfield, Mo.

L. A. 5—SALT LAKE CITY, UTAH.
 Mrs. J. W. Edwards, Pres. & C. S., 928 W. South Temple St.
 Mrs. Lydia Smithen, V.-Pres., 360 West 1 South St.
 Mrs. J. C. Walton, F. S.
 Mrs. Jane Foreman, Treas.
 Mrs. Morton, R. S., 116 Markham.

L. A. 9—GRAND JUNCTION, COLO.
 Mrs. W. H. Holeman, Past Pres., 914 S. 5th St.
 Mrs. F. N. Davies, Pres. & Treas., 528 Ute Ave.
 Mrs. J. W. Cox, C. & F. S. & V.-P., 925 S. 5th St.
 Mrs. L. A. Turner, R. & S. T.

L. A. 12—GARFIELD PARK, Chicago, Ill., 1st-3d Sat., 8 p. m., Garfield Park Hall, 4039 W. Madison.
 Mrs. Maud Reinemeyer, Past Pres.
 Mrs. Mollie Geary, Pres., 6428 S. Albany Ave.
 Mrs. E. Farrell, V.-P., 4118 Carroll Ave.
 Mrs. Helen Hughes, Cor. & Rec. Sec., 716 N. Avers Ave.
 Mrs. Mary Driscoll, Fla., Sec. & Treas., 4185 Carroll Ave.

L. A. 7—SUNFLOWER, Parsons, Kas., 2d-4th Tues. aft., Kennedy Hall.
 Mrs. Lillian Dudding, Pres., 2229 Crawford Ave.
 Mrs. Alice Leach, Vice-Pres.
 Mrs. Zita Rever, Treas.
 Mrs. Lula VanVleck, C. & R. S., 2701 Clark Ave.
 Mrs. Ethel Smith, Fin. Sec., 2227 Wash. Ave.
 Mrs. Mary Carver, Chaplain.
 Mrs. Marion Butler, Marshall.
 Mrs. Ida Cormany, Conductress.
 Mrs. Kate McMullen, In. Guard.
 Mrs. Emma Pilkington, O. Guard.

L. A. 10—SPRINGFIELD, MO.
 Mrs. A. F. Bingham, Pres., 701 Lombard St.
 Mrs. J. Gestring, Vice-Pres.
 Mrs. C. S. Gilliland, C. & R. S., 1914 Johnson St.
 Mrs. Wm. Specht, F. S. & T., Route 6.
 Mrs. Rheaden, Chaplain.
 Mrs. J. East, Conductress & Marshall.
 Mrs. J. Ritterhouse, Inside Guard.
 Mrs. Gestring, Mrs. Gilliland and Mrs. East, Trustees.

L. A. 14—TOLEDO, O.
 Mrs. E. Richardson, Pres.
 Mrs. Allen Thomson, V.-Pres.
 Mrs. C. F. Haga, R. S.
 Mrs. C. J. Suggre, C. & F. S.
 Mrs. Carrie Stephan, Treas.
 Mrs. Louise Brown, Conductress.
 Mrs. Lena Kern, Inspectress.

L. A. 8—FRANKLIN, McComb, Miss., Ladies' Aux. Hall, Ave. F. East McComb, 2d-4th Thurs.
 Miss Lula Hasfield, Pres., R. F. D. No. 1.
 Mrs. E. Sullivan, V.-P. & Treas., 725 Ave. F.
 Miss Emma Sullivan, C. S., 725 Ave. F.
 Miss Lulu Hasfield, R. S.

L. A. 11—LONE STAR, Palestine, Texas, Labor Temple, 2d-4th Tues. afternoons.
 Mrs. Frances Brunson, Pres., 15 Cottage Ave.
 Mrs. Helen Redus, V.-P., 106 Queen St.
 Mrs. Florence Payne, R. S. & Treas., 212 Palmer Ave.
 Mrs. Willie Welch, C. & F. S., 511 Green St.

L. A. 15—SAPULPA, OKLA.
 Mrs. Cora Johnson, Pres.
 Mrs. Myrtle Clifton, V.-Pres.
 Mrs. Addie Allen, R. S.
 Mrs. Bessie Lewis, C. S.
 Mrs. Hester Chapman, F. S.
 Mrs. Ethel Edwards, Treas.
 Mrs. Hettie Rondon, Chaplain.
 Mrs. Ferrel Wells, Conductress.
 Mrs. Emma Davis, Inside Guard.
 Mrs. Katie Hoover, Marshall.
 Trustees—Laura Cargill, Mrs. Emma Davis, Mrs. Addie Allen.

Boilermakers' Lodges by States.

Alabama.
 Birmingham . 4
 Montgomery . 443
 Selma . 312
 Sheffield . 344
 Whistler . 511

Arizona.
 Clifton . 593
 Miami . 187

Arkansas.
 Harrison . 138
 Little Rock . 66
 McGhee . 106
 Paragould . 599
 Pine Bluff . 68
 Van Buren . 521

Canada.
 Calgary .
 Alberta . 392
 Edmonton .
 Alb. . 279
 Ft. William .
 Ont. . 505
 Hamilton .
 Ont. . 421
 Joliette, Que. 604
 McAdam Jct. 379
 Moncton, N.B. 378
 Montreal . 134
 Moose Jaw,
 Sask. . 478
 North Bay,
 Ont. . 417
 Quebec . 601
 Revelstoke . 466
 Riviere du
 Loup, Que. 398
 St. Thomas,
 Ont. . 413
 Toronto, Ont. 548
 Transcona,
 Man. . 529
 Winnipeg, M. 126
 Winnipeg, M. 451

British Columbia.
 Vancouver . 194
 Victoria . 191

California.
 Los Angeles . 92
 Oakland . 233
 Pt. Richmond. 317
 Sacramento . 94
 S. Francisco . 25
 S. Francisco . 205
 S. Francisco . 410
 Vallejo . 148

Colorado.
 Alamosa . 446
 Colorado . 136
 Denver . 179
 Grand Jct. . 335
 Pueblo . 44
 Salida . 427
 Trinidad . 390

Connecticut.
 Hartford . 237
 New Haven . 61

Delaware.
 Dist. of Columbia
 Washington . 450

Florida.
 High Springs. 570
 Jacksonville . 20
 St. Augustine. 230
 Sanford . 573
 Sanford . 422

Georgia.
 Atlanta . 2
 Augusta . 108
 Cedartown . 510
 Columbus . 426
 Fitzgerald . 503

Macon . 12
 Savannah . 26
 Waycross . 425

Idaho.
 Avery . 595

Illinois.
 Alton . 483
 Bloomington 155
 Chicago . 1
 Chicago . 59
 Chicago . 226
 Chicago . 227
 Chicago . 454
 Chicago . 434
 Chicago Hts. 254
 Chicago . 588
 Danville . 22
 Decatur . 447
 Freeport . 284
 Joliet . 93
 Kewanee . 195
 Mattoon . 224
 Moline . 377
 Peoria . 60
 Murphysboro 524
 Springfield . 81
 E. St. Louis. 363
 Urbana . 150
 Villa Grove. 575

Indiana.
 Bedford . 541
 Evansville . 95
 Ft. Wayne . 54
 Garrett . 79
 Hammond . 356
 Indianapolis . 10
 Lafayette . 360
 Peru . 384
 Princeton . 334
 Terre Haute. 246
 Washington . 241
 Wabash . 324

Iowa.
 Belle Plaine. 440
 Boone . 161
 Cedar Rapids. 144
 Des Moines . 47
 Dubuque . 15
 Marshalltown. 149
 Mo. Valley . 145
 Sioux City . 244
 Valley Jct. . 491
 Waterloo . 133

Kansas.
 Atchison . 507
 Coffeyville . 542
 Ft. Scott . 286
 Goodland . 393
 Herington . 340
 Holsington . 408
 Horton . 199
 Kansas City. 83
 Neodesha . 418
 Osawatomie . 82
 Parsons . 292
 Pittsburg . 221
 Pratt . 523
 Wichita . 543
 Wichita . 513

Kentucky.
 Covington . 537
 Covington . 364
 Louisville . 40
 Ludlow . 584
 Paducah . 137
 Somerset . 419

Louisiana.
 Baton Rouge. 532
 New Orleans. 37
 New Orleans. 442
 Shreveport . 328
 Algiers . 296
 Monroe . 590

Maryland.
 Cumberland . 332
 Cumberland . 577
 Baltimore . 193
 Hagerstown . 578

Massachusetts.
 Boston . 250
 Boston . 431
 Boston . 585
 Cambridge . 515
 Dorchester . 574
 Greenfield . 574
 Lowell . 371
 Norwood . 281
 Springfield . 218
 Worcester . 492

Michigan.
 Bay City . 67
 Detroit . 169
 Escanaba . 597
 Grand Rapids 84
 Jackson . 64
 Marquette . 236
 Saginaw . 124

Minnesota.
 Brainerd . 116
 Duluth . 165
 Minneapolis . 11
 St. Paul . 3
 Two Harbors. 437
 Winona . 201

Mississippi.
 McComb City. 315
 Meridan . 320
 Vicksburg . 56
 Water Valley. 390

Missouri.
 Brookfield . 354
 Cape Girar-
 deau . 430
 Chaffee . 531
 De Soto . 117
 Hannibal . 353
 Kansas City. 32
 Moberly . 267
 Monett . 546
 Nevada . 583
 Sedalia . 113
 Springfield . 70
 Springfield . 530
 Slater . 586
 St. Louis . 27
 St. Louis . 51
 St. Louis . 278
 St. Louis . 322
 St. Joseph . 31
 Stanbury . 594
 Sugar Creek . 90
 Trenton . 346

Montana.
 Anaconda . 80
 Deer Lodge. 528
 Glendive . 591
 Great Falls. 602
 Harlowton . 41
 Havre . 367
 Livingston . 123
 Miles City . 529
 Missoula . 111
 Butte . 130

Nevada.
 Sparks . 339

Nebraska.
 Chadron . 109
 Fairbury . 439
 Falls City . 565
 Grand Island. 475
 North Platte. 118
 Omaha . 38

New Hampshire.
 Concord . 245
 Portsmouth . 467

New Jersey.
 Elizabeth . 176
 Hoboken . 163
 Jersey City . 16

New York.
 Albany . 197
 Brooklyn . 45
 Buffalo . 7
 Elmira . 225
 Mechanicals-
 ville . 388
 Middletown . 400
 Norwich . 396
 Oneonta . 414
 Oswego . 175
 Rochester . 229
 Salamanca . 598
 Staten Island. 200
 Syracuse . 157
 Troy . 73
 Utica . 223
 N. Y. City . 21

North Carolina.
 Raleigh . 173
 Rocky Mount. 239
 Salisbury . 226

North Dakota.
 Devils Lake. 479

Oklahoma.
 Muskogee . 504
 Okla. City . 556
 Sapulpa . 449
 Shawnee . 293
 Chickasha . 323
 El Reno . 522

Ohio.
 Akron . 600
 Bellefontaine. 243
 Canton . 301
 Chillicothe . 135
 Cincinnati . 105
 Cleveland . 5
 Columbus . 8
 Conneaut . 356
 Elmwood .
 Place . 91
 Jackson . 509
 Lima . 259
 Middleport . 549
 Montpelier . 581
 Newark . 92
 Niles . 275
 Portsmouth . 402
 Springfield . 18
 Toledo . 85
 Van Wert . 409

Oregon.
 La Grand . 553
 Portland . 72

Panama.
 Empire, C. Z. 463
 Cristobal . 471

Pennsylvania.
 Carbondale . 547
 Connellsville . 444
 Galeton . 438
 Lansford . 573
 New Castle. 493
 Philadelphia . 341
 Pen Arky . 140
 Pittsburg . 154
 Pittsburg . 318
 Philadelphia . 19
 Pottsville . 256

South Carolina.
 Charleston . 50
 Columbia . 235
 Florence . 424

South Dakota.
 Huron . 496
 Mobridge . 606

Tennessee.
 Bristol . 435
 Copperhill . 453
 Jackson . 88
 Knoxville . 143
 Memphis . 189
 Nashville . 42
 Chattanooga . 14

Texas.
 Amarillo . 331
 Beaumont . 587
 Big Spring . 423
 Childress . 382
 Dalhart . 476
 Dallas . 86
 Denison . 209
 El Paso . 216
 Ft. Worth . 98
 Galveston . 132
 Houston . 74
 Kingsville . 287
 Marshall . 100
 Mart . 222
 Palestine . 464
 Sherman . 458
 Port Arthur. 305
 Smithville . 265
 San Antonio. 345
 Teague . 502
 Terrell . 469
 Tyler . 486
 Waco . 501

Utah.
 Helper . 473
 Ogden . 198
 Salt Lake
 City . 103
 Tooele . 606

Vermont.
 Lyndonville. 481

Virginia.
 Alexandria . 369
 Clifton Forge. 238
 Newport News. 55
 Norfolk . 426
 Portsmouth . 228
 Portsmouth . 170
 Richmond . 170
 Roanoke . 30
 Roanoke . 29
 Victoria . 65

Washington.
 Bremerton . 290
 Everett . 500
 Othello . 603
 Spokane . 242
 Seattle . 104
 Seattle . 489
 Tacoma . 247
 Tacoma . 568

West Virginia.
 Bluefield . 405
 Elkins . 278
 Gassaway . 152
 Hinton . 525
 Huntington . 249
 Keyser . 579
 Princeton . 551
 Williamson . 557

Wisconsin.
 Butler . 589
 De Pere . 571
 Green Bay . 485
 Milwaukee . 107
 Milwaukee . 302
 N. Fond du
 Lac . 395
 S. Kaukauna. 311

Wyoming.
 Casper . 596
 Cheyenne . 46
 Evanston . 309
 Laramie . 48

By Insisting Upon Purchasing Union Stamp Shoes



You help better shoemaking conditions.
You get better shoes for the money.
You help your own labor position.
You abolish child labor.

Do not be misled by retailers who say: "This shoe does not bear the union stamp, but is made under union conditions." This is false—no shoe is union made unless it bears the union stamp.

Boot and Shoe Workers' Union

246 SUMMER STREET, BOSTON, MASS.

JOHN F. TOBIN, President.

CHAS. L. BAINE, Sec.-Treas.

THE COMMERCIAL NATIONAL BANK

of KANSAS CITY, KANSAS.

CAPITAL AND SURPLUS, \$550,000.00.

DEPOSITS.....\$5,000,000.00

We cordially invite the Boiler Makers and Ship Builders of the United States who desire to transact banking business with us (which can be done readily by mail), to write to any of their officers and ask any questions they may desire to ask about our reliability and standing.

P. W. GOEBEL, President.

C. L. BROKAW, Cashier.

A. C. FASENMYER, Vice-President.

G. J. BISHOP, Asst. Cashier.

When Writing Advertisers

PLEASE MENTION

The Boiler Makers' Journal

Notice to Subscribers of the Journal

When members change their address, or do not receive Journal promptly, fill out the following blank and forward to the editor:

NameReg. No.Lodge.....

Old Address, Street.....CityState.....

New Address, Street.....CityState.....

I have not received Journal for month of.....

KANSAS CITY, KAS., JULY, 1915.

THE BOILERMAKERS JOURNAL

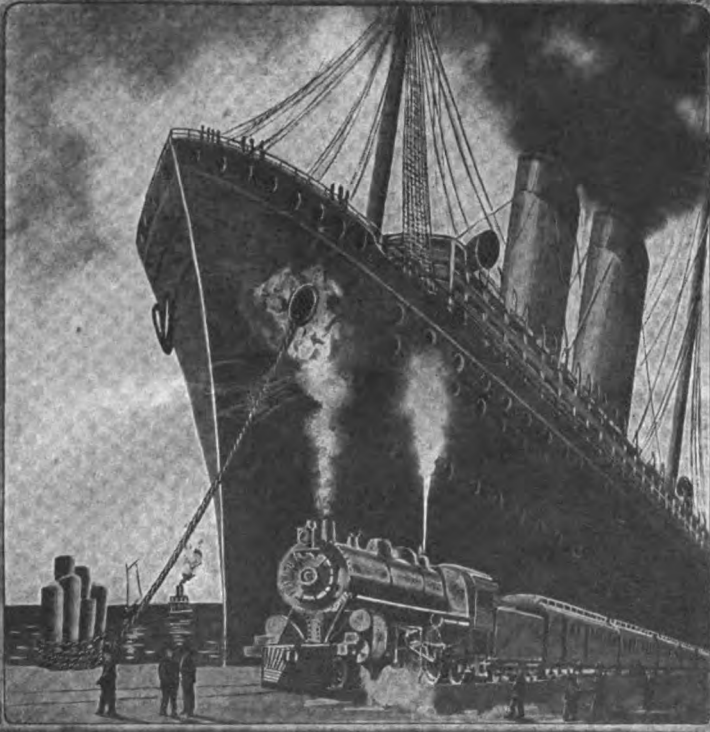

OFFICIAL ORGAN OF THE
INTERNATIONAL BROTHERHOOD
OF BOILERMAKERS, IRON SHIP BUILDERS
AND HELPERS OF AMERICA

Headlight Overalls
bring "a smile of
Satisfaction" in
the home.



HEADLIGHT UNION MADE OVERALLS

They stand the
wash tub test-
the real test
of an overall

Larned, Carter & Co., Detroit, Mich.
WORLD'S GREATEST OVERALL MAKERS
Factories:-Detroit, Pt. Huron, Mich., St. Louis, Mo. Sarnia, Ont.

SECURITY SECTIONAL ARCH

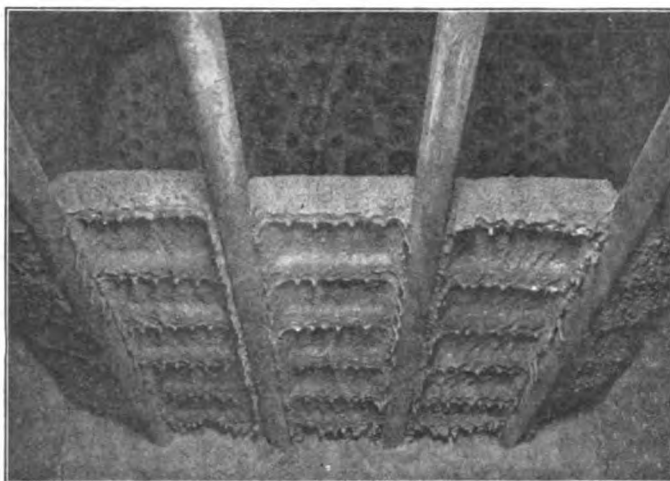

This arch is of light weight
It is built up of small sections
So made as to cool off quickly
It is easily removed for work
Made so to help the boilermaker

AMERICAN ARCH COMPANY

30 CHURCH STREET, NEW YORK

MCCORMICK BUILDING, CHICAGO



Since the first railroads

Stifel's Indigo Cloth

Standard for over seventy-five years

has been the "old reliable" Over-all---Uniform---Shirt---Jumper---cloth for the "men of the road."

To three generations of railroaders it has demonstrated that *it's the cloth in the garments that gives the wear.* Stifel's Indigo wears like leather and looks good as long as it lasts.

Be sure you see this mark on the back of the cloth, *inside* the garments before you buy. It's your guarantee of the genuine Stifel Indigo.



REGISTERED

Cloth manufactured by

J. L. STIFEL & SONS

Indigo Dyers and Printers. WHEELING, W. VA.

SALES OFFICES

NEW YORK.....	260-262 Church Street
BALTIMORE.....	114 W. Fayette Street
PHILADELPHIA.....	324 Market Street
BOSTON.....	31 Bedford Street
CHICAGO.....	223 West Jackson Boulevard
SAN FRANCISCO.....	Postal Telegraph Building
ST. JOSEPH, MO.....	Saxton Bank Building
ST. LOUIS.....	425 Victoria Building
ST. PAUL.....	238 Endicott Building
TORONTO.....	14 Manchester Building
WINNIPEG.....	400 Hammond Block
MONTREAL.....	100 Anderson Street



The Boilermakers' Journal

Official Organ of the
**International Brotherhood of Boilermakers
Iron Ship Builders and Helpers of America**

Vol. XXVII.

KANSAS CITY, KAS., JULY, 1915.

No. 7.

LAWSON A CONVICT—ROCKEFELLER A SAINT?

By Samuel Gompers, in the American Federationist.

"Guilty of murder in connection with the death of—the words came with a weird shock. They had an appalling fascination because of their unbelievable reality. John Lawson has been found guilty of being an officer of organized labor and sentenced to living death in connection with the man of whose death he knew nothing. Why? Because somebody wants to get John Lawson out of the way. It is a familiar trick of hostile employers to undermine unionism by getting the leaders out of the way by allurement, discharge or jail—some way, any way. John Lawson is a miner; he is one of the strong, courageous, reliable men in the movement to establish industrial justice and freedom for those who work.

That the labor movement is a great evolutionary force, that it brings in its wake a new industrial status, employers fully appreciate. The coal barons of Colorado have been dominated by a man who would sacrifice all of his investments in Colorado rather than recognize the new industrial situation which assures wage-earners a voice in determining conditions under which they work. In the relentless pursuance of this policy John Lawson became a marked man.

But John Lawson was known throughout the state of Colorado as an honorable, just man, a man who had reverence for human life. Because of the world-wide publicity which the strike gained, due to the subversion of civil authority and to the disgraceful civil war that was inaugurated by the coal barons, John Lawson became equally well-known as a responsible, frank, kindly advocate of human justice. The governmental officials and agencies of Colorado have become infamous for facile subservience to the machinations of corporate "vested interests." But the existing agencies could not be trusted to convict John Lawson of a murder that he did not even see. A special tribunal was "made to order."

A new judgeship was created to which was appointed Granby C. Hillyer, formerly corporation attorney for the coal barons. To him could be entrusted trials of union miners indicted during the strike. Jesse Northcutt, the well-known attorney for the coal operators, acted as prosecuting attorney.

When this "machinery of justice" was ready for business the labor "trials" began. The first trial was that of Louis Zancanelli. The machine clogged—careful study revealed defects in the jury. The newspaper of Colorado assert that the jury was "improved" by the injection of three gunmen, a corporation doctor, and a man who was said to have bet on the trial. This time the machine did the trick and was pronounced equal to the work of getting John Lawson out of the way.

Profiting by the first experiment the sheriff provided a hand-picked jury chosen by open venire. The law of Colorado provides that juries shall be chosen by drawing names from the jury box, but as that method was inconvenient for this special judicial machine it was not permitted to interfere. Then the machinery to convict the leader of the miners of Colorado was ready and the formalities of securing legal "sanction" for connecting John R. Lawson with the death of the gunman, John Nimmo, were enacted.

There was not a scintilla of evidence to establish Lawson's guilt. It was not even proved that he was present at the battle. The prosecution simply proved Lawson to be a union official, but failed to establish that he advocated, practiced or even encouraged violence. The employes and gunmen of the coal operators offered testimony to substantiate the company's prosecution.

After long deliberation the hand-picked jury brought in its verdict. In the death-like stillness Lawson was declared guilty of murder in the first degree in connection with the death of John Nimmo, October 25, 1913. A gasp of unbelieving wonder followed this travesty of justice—wonder that grew into indignation and protest as people came to realize the principle involved. That principle is of vital importance to every working man and woman in the country.

To understand the significance of the verdict it is necessary to understand the civil war which has been devastating the coal fields of southern Colorado. In 1913 the coal miners presented grievances to the coal operators. They were trying to organize in order to secure for themselves the industrial right to a voice in determining conditions of work. Their demands were as follows: An eight-hour workday for all men employed in the mines; the right to employ check-weighmen; the right to belong to a labor union; abolition of the truck store and scrip system; a semi-monthly payday;

a 10 per cent increase in wages, and the abolition of the guard system.

Five of these demands were legal rights accorded by statutes enacted by the state legislature. But because the workers lacked the economic power to enforce their legal rights the laws were dead letters. The mine operators treated laws with contempt and yet no official nor court presumed to punish them. Why was not more effort made to establish regard for law and order in the policies of the operators? Were these operators above the law? What then of the boast (or the platitude) that all citizens are equal before the law?

When the demands were under consideration, the mine operators began preparation for war. They began importing arms and ammunition, they borrowed the field artillery that had been used in the coal war in West Virginia; they began shipping in the Baldwin-Feltz gunmen who had served in West Virginia. Did they not deliberately plan a policy of violence?

Before the strike was declared a gunman on the street in Trinidad shot Gerald Lippiatt, a union organizer; that was the first act of physical violence connected with the strike. The men responsible for the presence of that gunman in Trinidad were "guilty of murder in connection with the death" of Gerald Lippiatt—yet not one of them has been convicted, arrested or even indicted. Does the same law apply to miners and mine operators in Colorado?

When the industrial struggle became inevitable the miners knew that they must make some provision for shelter. The homes in which they lived were company houses. In fact, under the feudal conditions that existed no striker had a right even to a space to stand on in the vast holdings of the mine operators. The mine operators own the land where the miners work, the houses in which they live, the stores where they buy necessities of life, the school houses, the churches, the postoffices, the courts, the banks, and the public highways. Eviction always follows strikes—a miner who demands rights has no right on the land of the mine owners. He becomes a "trespasser."

The miners purchased or leased suitable tracts of land for tent colonies. These camps were erected at Ludlow, Forbes, Hastings, Oak Creek, Walsenburg, and other places.

On September 23 the strike was declared. The Baldwin-Feltz men began their usual work, shooting, trying to incite violence. On October 9 they made an attack on Ludlow. Since Ludlow had no police protection the men had to defend their own lives and to maintain order in the tent city. When the militia arrived October 11 the men say that all arms were given up to welcome their arrival. But immediately gunmen were sworn into service in the militia—and thus what was nominally a governmental agency for "law and order" became a private army in the employ of the

mine operators and used for strikebreaking purposes. On October 17 an attack was made on the tent colony at Forbes. The company had an automobile iron-plated, and armed it with a rapid-fire gun shooting 147 times a minute. This automobile was driven up to the Forbes colony by Baldwin-Feltz deputies. One of the men approached the camp and asked if they were union men. Their "confession" was the signal for the withdrawal of "law and order." The men in the automobile open fire on the camp—one miner was killed and a boy was shot nine times in the legs. Those tents, however poor, were the miners' homes and contained women and children. Would men refuse to defend their homes? No one has yet been indicted for "murder in connection with the death" of this man.

A "death special," consisting of a train of three steel cars, was armed with rapid-fire guns to hurl "law and order" into the bodies of the strikers.

On October 24 an attack was made upon the colony at Walsenburg and a number of the miners living in the colony were killed.

On the following day, while the strike benefits were being paid at Ludlow, the gunmen opened fire upon that colony from the heights overlooking the Ludlow plains. The miners arranged a place of safety for the women and children and then prepared to defend them and themselves. The attack upon the colony was led by John Nimmo, who, as those present contend, was shot by his own men. Whatever shooting the miners at Ludlow did was done in self-defense. The "law" even of Colorado permits a man to defend his own life and that of his wife and children.

Isn't it more than passing strange that in a country where the constitution firmly proclaims equal rights for all, that industrial war in one state may become a matter of international information and criticism and yet only wage-earners are indicted for punishment in connection with violence and murder? No one denies that Louis Tikas and other miners were killed, but neither of the John D. Rockefellers nor J. F. Welborne was indicted for their murder. If the leader of the strikers can be held responsible legally for violence alleged to be committed by the strikers, then every mine owner is legally responsible for the deaths of men, women and children killed in the war waged to suppress and prevent miners from securing rights assured them under state laws.

The state of Colorado does not condemn violence or disregard for the law—it condemns only strikes and convicts only strikers. It accords mine operators the right to private police, private armies and to the use of violence "to put down" the demands of wage-earners—in other words, it legalizes violence in the interest of property.

Miners employed by the Colorado Fuel and Iron Company must order their lives, direct their minds and curb their desires as

the company dictates—they have not the right to petition their rulers for redress of grievances. These rulers have officially declared that no grievances exist.

The strike is the final protest that a free worker can make. The law of Colorado accords the workers the right to strike. Yet all of the organized forces of the government were put at the service of the coal operators to deny the miners the normal and lawful opportunity to make their rights effective. When strikebreakers are brought in the strike becomes ineffective. Yet the coal operators were allowed to use violence under the pretense of protecting the strikebreakers. The operators imported the same strikebreakers who had been used in West Virginia, for strikebreaking has become an established interstate business. Strikebreakers are protected by police, militias and the private armies on the lands of feudal employers, backed by a partial judiciary.

The whole country was aroused by the subversion of civil authority in Colorado, by the arrogance with which the mine operators disregarded all attempts by the Congress or by the President of the United States to adjust grievances of employes. So long as private individuals are permitted to control organized physical forces through the right of corporation police, just that long will violence be provoked in industrial disputes.

The coal operators of Colorado employed hirelings to do the physical violence that has so often accompanied Colorado coal strikes; through their political and military servitors they wronged the wage-earners by a subtler form of violence—violence to their constitutional rights, violence to their ideals of freedom, violence to their lives and hearts and minds. Responsibility for this terrible violence to humanity must inevitably fall upon the mine owners—there is not one who can rid his conscience of guilt.

Under present conditions society does not condemn violence—it only restricts the use of violence to a privileged few. Colorado says to the mine operators, you may use guns for offensive and defensive purposes; it says to the miners, you shall be held responsible for complicity in connection with the death of any of these soldiers of the mine operators.

Is this equality before the law? Before whose law?

Back in 1913 a grand jury in Colorado returned indictments against several national and state officials of the United Mine Workers for alleged conspiracy under the Sherman anti-trust law. The grand jury condemned some of the methods of the organization as illegal, but stated that striking miners had been denied protection of the law. The same grand jury further charged the coal barons as follows:

State laws have not been obeyed. Could there be more insidious anarchy?

The coal companies have in many cases

controlled local politics by reprehensible methods, including various forms of discrimination and the changing of precinct boundaries in order to eliminate unfavorable votes.

The scrip system and obligatory trading at company stores, abuses of long standing forbidden by law, still exist and are frequent causes of complaint.

Saloons are maintained by many companies in their camps and they collect from the keepers of such saloons a per capita sum of 25 to 40 cents per month for each person whose name appears upon the company payroll.

Employes have been discharged for insisting upon a system of check-weighing in accordance with state laws.

Not only labor unions but fraternal societies are opposed and discouraged by the coal companies. Thus state laws and elemental rights of citizenship are disregarded.

Constitutional rights of legal procedure have been disregarded by camp marshals whose appointments and salaries are controlled by the coal companies. Many of these petty officials have exercised a system of espionage and has resorted to arbitrary powers of police control, acting in the capacity of judge and jury.

Men who have incurred the enmity of the superintendent of the pit boss for having complained of real grievances have not only been denied hearing but have been given the sentence of "Down the canyon for you," which means that the miner is discharged on the spot and driven from camp. These camp marshals are often guilty of brutal assaults upon miners.

As a result of these and similar conditions, miners generally fear to complain of real grievances because of the danger of their discharge or of their being placed in unfavorable positions in the mines.

Despite this finding by the grand jury—the agency for law and order—no steps were ever taken to punish these malefactors of great wealth for their violations of law. What manner of justice exists in Colorado? How long will the citizens of Colorado endure the rule of the corporation interests? When will they rise in the dignity and the might of free citizens and demand the rights of free men and the constitutional rights of citizens of a republic?

There is a tremendous issue involved in the verdict returned against John R. Lawson—an issue of grave importance to every worker, to every liberty-loving citizen of the United States.

The mine operators have demonstrated that they can secure a conviction of murder against a union leader merely because he is a union leader, even though he is in no way connected with the alleged violence.

The mine operators will now endeavor to have that verdict confirmed by a higher court as a legal precedent. To incorporate that principle into the law of the land is to place in the hands of employers hostile to labor an opportunity for endless prose-

cution and litigation that will not only drain union treasuries, but harass the toilers by diverting them from necessary organizing, protective and beneficent activities. Employers have ever diligently sought methods to force unions to squander funds for unprofitable expenditures.

The trade union is a great evolutionary force seeking to establish in industrial life the rights of human beings to life and to the products of labor. It is a force making for the uplift of humanity and must not be outlawed by legislative enactment, judicial perversion of justice, or by the organized violence of employers and their Hessians.

The labor movement is the hope of the workers.

This attempt to hold John R. Lawson responsible in connection with the death of a man of which he had no knowledge stands out in vivid contrast to the studied efforts of John D. Rockefeller, Jr., to establish his complete ignorance of the Colorado strike and hence his complete irresponsibility. John R. Lawson had nothing to gain by the death of John Nimmo, but John D. Rockefeller had profits at stake in the suppression of the Colorado strike.

At the New York hearing of the Commission on Industrial Relations, John D. Rockefeller calmly disavowed ordinary intelligence as to labor conditions in Colorado; to the House of Representatives' Committee on Mines, he asserted that he accepted the judgment of his agents without question; with regard to the public he sought to establish for himself the reputation of a figurehead.

Chairman Walsh has made public letters written by Mr. Rockefeller which seem to fill up the mental blanks which Mr. Rockefeller has attributed to himself. Mr. Rockefeller has been again subpoenaed to tell what he knows. That hearing may open opportunities for making Mr. Rockefeller assume responsibility which he ought to assume—responsibility for the violence and the injustice that exist in Colorado, responsibility that he seeks to shift upon an officer of organized labor.

Existing law, existing judicial interpretation of law, and existing administration of law are a heritage from past customs, traditions and developments. During the past ages governmental influences and control have been in the hands of men who have considered government an institution for the protection of property. Where the theory of the sacredness of property is not the dominant force it is a background that gives tone and direction to governmental interpretations.

Regard for the welfare of the workers who are the necessary power in the creation of property has been subordinated to regard for property. Holders of property have created a tradition of the paramount importance of property and have exalted and exaggerated the part that property has in production. At the same time they have minimized and detracted from the service

that the laborers render. Through their political influence gained by their economic power they have incorporated this misconception into governmental and legal theory. It is against this inequality, this injustice, that the workers are now directing the power of the labor movement.

Slowly the workers are learning to appreciate their great economic power. As producers they have the world in their grasp. Through their economic power they have been slowly injecting into political and legal thought the conception of the sacredness of human life and the paramount importance of humanity. They are trying to establish a real equality of opportunity in industrial and in political affairs; they are trying to secure equal governmental protection for all human beings. This is the real revolution the labor movement is working.

There can be no equality of opportunity industrially or politically so long as any private citizen is privileged to have control over agencies of force and coercion. All the agencies of government must be representative of all the people and exercised by those responsible to the people. There can be no equality of opportunity so long as all of the coercive agents of organized society can be utilized by employers for tyranny, injustice, greed and profit—for strikebreaking purposes. It is mockery to legalize strikes and then to use every governmental agency to make strikes ineffective. Where there is no equality of opportunity there is no equality, and equal rights to all becomes a platitude.

It is everywhere recognized that the attempt to railroad John R. Lawson to prison is a part of the sinister plan and the vengeance of the subtle power that has directed the policy of the coal operators of Colorado. John D. Rockefeller cannot escape responsibility for his deeds. The spectres of Ludlow have not yet vanished from the memories of men nor have they ceased to haunt him who is responsible.

How long, Mr. Rockefeller, will you persist in your unbridled audacity? How long will you try to conceal under the cloak of private philanthropy your tyrannical denial of the rights of free citizens to those in your employ? When the miners of Colorado ask for justice, you mock them with your hypocritical charity.

The money you give for charity carries with it distrust because of the way it was made. Charity will not buy you freedom from responsibility for "murder in connection with the deaths" in Colorado and in connection with the living death that the courts of Colorado have prepared for John R. Lawson, nor for the human lives that have been warped and embittered through injustice and denial of rights.

The great injustice and wrong already inflicted on Lawson must be undone and righted.

John R. Lawson must be freed!

THE BOILER MAKERS' JOURNAL

Official Organ of the International Brotherhood of Boiler Makers, Iron Ship Builders and Helpers of America.

A Monthly Publication Issued the First of Each Month from Room 9, Law Building, Kansas City, Kansas.

JAMES B. CASEY, Editor and Manager.

Subscription Price.....\$1.00 Per Year in Advance

ADVERTISEMENTS.

Advertising Rates Will be Furnished Upon Application to the Editor-Manager. No Reading Space Will be Sold for Advertising Purposes Under Any Circumstances.

All New Members Must Have Their Name and Address Sent in Through the Secretary of Their Lodge. After That They May Have Changes Made in Their Address by Filling Out Blank Form in Back of Book and Forwarding to the Editor.

All Copy Must be Received by the Editor by the 18th of the Month to Insure Publication in the Following Issue.

All Contributions and Correspondence Relating to the Journal Should be Addressed to J. B. Casey, Editor, Room 9, Law Building, Kansas City, Kansas.

Entered at Postoffice, Kansas City, Kansas, as Second Class Mail Matter.

ORGANIZED LABOR'S EXHIBIT AT THE FRISCO EXPOSITION.

From all reports the exhibit at the Panama-Pacific Exposition, devoted to the cause of organized labor and arranged under the auspices of the American Federation of Labor, is in every way worthy of the great cause it represents and it should be one of the first places to be visited by every loyal member and well wisher of organized labor, who visits the Exposition. The labor exhibit is in a booth at the western end of the Palace of Education and Social Economy. The booth is located on the corner of Sixth Street and Ave. D.

It is 20x55 feet in size.

We are told that one of the most striking features of the booth is the frieze which adorns the side and end of the interior, which represents by human figures and symbols, the work in mines, mills, factories, agriculture and horticulture. An illuminated chart containing the following extract from the Clayton anti-trust act, "The Labor of a Human Being Is Not a Commodity or Article of Commerce," expresses the Central thought of the whole exhibit.

Various charts are exhibited, showing the progress that various organizations have made, in organizing and in securing better conditions and wages for their members. A stereomograph throws upon a screen industrial scenes and the union labels of organizations in affiliation with the Union Label Trades Department of the A. F. of L., and we are told that every exhibit and article of furniture, in fact everything in connection with the exhibition, as far as possible, bears the union label.

We have secured a couple of cuts of this booth, through the courtesy of General Organizer Young of the A. F. of L., which we will reproduce in this issue for the benefit of our members.

AN UNWISE MOVE.

We have been informed that an effort is being made to form a "Panama Gold Employes' Organization" on the Isthmus of Panama, independent of all other organizations.

We do not know just who the Panama Gold Employes are, that is, what trades and callings the term covers, but we have no hesitation in saying such a move would be a serious mistake. We have had fourteen years' experience as a navy yard employe and know something of the conditions under which government employes labor and the handicaps they have to contend with. Mechanics and civilians employed by the Army and Navy Departments are subject more or less to the military discipline which pervades these branches of the government service; it is strict, stern and unyielding, and the only thing that will induce the officials of these departments to change their policy or treatment of civil employes is political influence, and the political influence of a bunch of working men employed and living on the Isthmus is a negligible quantity. What they cannot secure by moral persuasion they must depend on others to get for them, and the logical ones for them to turn to, is their fellow working men in the States. Therefore, instead of the men in the canal service assessing themselves ten per cent of their wages for a month in order to start a new organization, they, to a man, should become affiliated with the legitimate organization of their trades in the United States and in this way be in a position to claim the assistance of their fellow union men here, in their efforts to secure what they think they are entitled to for work in the Canal Zone.

In this way they can secure the assistance and the influence of the whole American labor movement and the help of the officers of the A. F. of L. in its departments at Washington to secure for them a square deal. It is through this influence that all the concessions, these government employes have secured in the past have come and it is their one best bet for the future. The organized employes on the Isthmus could, with propriety and no doubt with advantage, select one of their brainest and most experienced members and send him to Washington to represent them before committees of Congress at its next session. He can, if he uses proper discretion, help put in motion all of labor's influences in behalf of those who sent him.

RICHMOND, VA., UNIONS ARE PROGRESSING.

We are in receipt of a copy of "The Square Deal," a bright, newsy weekly paper, issued under the auspices of the Trades and Labor Council of Richmond, Va. It bears all the earmarks of a well edited, up-to-date paper, that will no doubt do valiant service for the cause of organized labor, not only in Richmond, but the entire state of Virginia.

We congratulate the unions of Richmond on their enterprise and wish every success to their venture into the Journalistic world.

The establishing of a paper, however, is but one of the many enterprising efforts the union men of that city are putting forth, all of which are for the advancement of the interests of the working people of that city.

One of the enterprises now under way is an effort to have a representative in the legislature, a right which the voters of Richmond has recognized for a long time. At a recent meeting of the Trades and Labor Council, Mr.

R. T. Bowden of the Typographical Union, and now vice-president of the Council, was unanimously indorsed as labor's candidate for legislative honors, and have inaugurated a campaign to insure his election.

Mr. Bowden is in every way worthy of the honor and confidence bestowed upon him by the union men of Richmond, and we hope his candidacy will receive the united active support of every working man in that city.

We do not believe it will be necessary to do any urging upon the boiler makers and helpers there to rally to his support. We hope they will not only vote for him, but that they will get out and diligently work in his behalf from now until the primary takes place.

FORD ISSUES AN ENORMOUS AMOUNT OF WATERED STOCK.

The daily papers recently announced that the Ford Motor Company had increased its capital stock from two millions to one hundred millions of dollars, forty-eight millions of which was voted as extra dividends to the stockholders. This is 98 per cent of water and one of the most glaring cases of watered stock issues ever made public. Of course it will be expected that the employes working for this company shall help earn a dividend on all of this inflated stock.

This is the company that made a dramatic announcement of a co-operative plan some time ago and announced five dollars as its minimum rate of pay.

If this company can make money paying this rate and at the same time earn enough to pay dividends of this tremendous, outrageous increase in its stock, then they must be robbing those who buy from them.

It is high time that laws were enacted preventing such shameless stock increases, which is based only on the power of the Company to pay a dividend at the present time. The states must enact laws to regulate the issuing of stocks and bonds, for as it is at present practiced, it is a stench in the nostrils of honest business.

A VOICE FROM THE FORGOTTEN PAST.

Ex-President Taft appeared before the "Eat It With a Spoon" Club of Kansas City recently, and unburdened himself of a lot of criticisms of organized labor and its tendencies, he prefaces his long tirade of criticisms with the statement that "now combination and organization have come to labor as well as capital. By these means the worker, originally at a disadvantage has placed himself on an equality with his employer." It is not necessary to tell our readers that organized labor is far from this desirable goal, thus arguing from false premises it is plainly evident that Mr. Taft reached erroneous conclusions in most of the criticisms he made. He asserts that unionism is tending towards the dead level and that it is discouraging skill and production, because it successfully opposed the efforts of certain inter-

ests and of certain officers to install the Taylor system in the government arsenals and navy yards. Mr. Taft's dense reasoning and illogical conclusions shows he does not know any more about these matters than he did about the affairs of state, and which resulting in his hitting oblivion with a dull thud and in short order.

He throws a fit about the Clayton amendment to the anti-trust laws which exempts labor and farmers' unions from the provisions of these laws, but does not give a single reason based on equity or fairness, why this amendment should not have been made a part of the law, but indulges in aspersions upon the members of organized labor that would do credit to a veritable demagogue, only he inverts the usual order.

In our humble opinion what Mr. Taft needs is to go away back and sit down or confine his speeches to such subjects as he knows something about, for in matters concerning the welfare of the masses he has not a heart throb that beats in unison with them.

His associations, training, past actions and utterances all show plainly he is for the favored few at the expense of the many.

MEMBERS SHOULD FURNISH CHANGES OF ADDRESS.

We would like to again impress upon our members everywhere, the importance of keeping the secretary of their lodge informed of all changes they make in their address, so that when the secretary is preparing new lists to be sent to this office, they will not give the wrong address, which will result in their failure to receive the Journal, for our mailing list is corrected in accordance with the last list received from all lodges, and the postoffice employes will not pay any attention to or deliver second class matter unless the correct address is given.

When the members move from one street to another they should write their name and old as well as new address on a slip of paper and either give or send it to the secretary. They must recognize the fact that the duty of giving this notice to the secretary is theirs and they cannot blame anyone but themselves if they fail to get their Journal. Under no circumstances should they wait for the secretary to ask them for it. They should remember that he has the task of looking after and sending lists of all the members to this office.

Many times members of various lodges notify us direct of changes of their address and we make the necessary changes on our mailing list, providing it is of a local character. However, this does not relieve them of the duty of notifying their secretary of these changes also, for later on the secretary may prepare and send to us another list, using this member's old address. We take it for a change of address and correct accordingly and the consequence is the Journal fails to reach them. If each member will do their duty in this matter, it will greatly aid the secretaries and make sure the Journal is reaching them promptly.

CHAIRMAN WALSH AROUSES THE IRE OF BIG BUSINESS.

From the daily press we learn that the recent examination of John D. Rockefeller, Jr., and some of his satellites and retainers, by Mr. Frank Walsh, chairman of the Federal Industrial Relations Committee, has aroused the resentment of these people. This straightforward, searching, deep probing, investigations and examinations of witnesses breaks all records for commissions, none have heretofore really probed for the facts or asked embarrassing questions. Therefore, the friends of big business and special privilege are resentful towards Chairman Walsh and are clamoring for his dismissal.

Heretofore we have not been in favor of industrial commissions for the reason that they were mere farces. They did not ask any disagreeable questions or seek the true conditions, although many volumes of prepared beforehand testimony was given and put into type, but the only ones who ever read these reports were the printers and proofreaders who put them into print and got so much per day for doing so. However, with the present commission it is different. Labor has a larger representation than ever before, being represented by three able and experienced leaders that enjoys the full confidence of the masses of people. Besides this we are fortunate in having so able and fearless a man for chairman as Mr. Walsh, who from the first has shown broad and humane views and since he has gone deeper into this investigation and seen, at first hand, the real conditions underlying our industrial system, he has shown unmistakable signs that his heart beats in unison with the aspirations of the masses for better conditions, and a higher standard of civilization.

The oppressors of labor may rave at Mr. Walsh if they will, but they cannot harm him. They may clamor all they want for his removal as chairman, but we feel sure President Wilson has no intention of molesting him and dare not do so even if he was so inclined, because of public opinion. The working people appreciate Mr. Walsh's work and brave stand.

REACTIONARY STANDPATTERS AGAIN SEEKING CONTROL.

Every indication points to a renewed and determined effort of the reactionary forces, which were such pliant tools of privilege hunting, boodling corporations, to secure control of the government again. In fact, we find that in several states they have already wormed back into power, the legislatures in these states in the past few months, not only refused to pass any legislation asked for by organized labor, but in many instances hamstrung laws already on the statute books which were previously enacted for the protection of the masses.

Already the forces of the invisible powers of government, the boodling, privilege hunting, corrupt corporations are busying themselves trying to arrange to capture the national government again and if they succeed in their designs, Mr. Taft's standpatting record would not be a circumstance to their

choice for president, and if the working people are wise they will awake to the importance of the matter and earnestly strive to prevent such a result, which would give to the cause of organized labor, a serious set-back.

In New York state, the eight-hour law for women working in canneries was repealed and the time extended so that they and children can be worked twelve hours a day if necessary.

In Washington, the minimum wage law was attacked. In other states it was something else, anything to put the working people on the defensive so that they will have to devote their whole time in defending the laws they already have instead of being free to work for the other needed legislation.

In the last Washington hearing of the Industrial Relations Commission, Chairman Walsh unearthed a letter from L. M. Bowers, former vice-president of the Colorado Fuel and Iron Company, and now a personal representative of Rockefeller, in which he states they will fight the striking miners "until our bones are bleached white as chalk in the Rocky Mountains," and in another letter from the same source to Mr. Rockefeller, this significant statement is made: "I believe the position you so ruggedly maintained will do more for the millions of laboring men than all of the efforts of social reformers in as many years. It will set thousands of faltering employes to thinking. Now for an aggressive warfare to 1916 and beyond for the open shop."

In a speech before the Manufacturers' Association recently, E. H. Gary of the Steel Trust, is quoted as saying: "**The captains of industry will again become popular in the United States.** This sentiment has been brought about by the efforts of business men to satisfy the public in regard to their reasonable demands. The individual, or the nation whose standard of conduct conforms to the golden rule, will obtain the largest pecuniary success. If we conduct our affairs properly, if we make the most of our opportunities, if we co-operate with one another, **if the government and governmental agencies and the business people are allies**, we shall become stronger, richer and more potential in our influence after this war and we shall be able to occupy a position in the van of nations."

These two quotations plainly show what these trust magnates and so-called captains of industry will seek to accomplish by an "aggressive warfare." They will seek to get control of the government again in 1916, and with the invisible powers of government again in working order, to use this force to help them inaugurate universal open shop conditions. Some of our courts seemingly have surrendered to these influences and have dealt organized labor some death dealing blows, and as a consequence it is passing through one of the most important and perilous periods of its existence, and it is important that labor meet these evil influences with united ranks and an active and intelligent campaign to try to neutralize and make abortive the corporations' designs. However, in doing so, we must not allow anything to transpire that would tend to alienate from us the influence and sympathy of public opinion, that great force which make and unmake laws.

U. S. GOVERNMENT RAILROAD BUILDING IN ALASKA A BIG JOB.

From all accounts the road building undertaking of Uncle Sam in Alaska will be a large undertaking, the road which will extend from Seward to Fairbanks, a distance of nearly five hundred miles; the Alaskan Northern has already been built part of the way, but the further the road extends north the more it becomes isolated from the world and difficult the construction. However, American working men and engineers will build this road successfully and in short order. The road will tap a rich section of the country, immense quantities of good coal abounds and we are told that this will be mined and furnished to supply the navy on the Pacific Ocean.

Seward is 1,500 miles nearer to the Philippine Islands bases than is the Mare Island Yard, and it is said the quality of the coal is of the best. While the job of building this road is no doubt a big one, it is not likely to have the difficult engineering feats that the building of the Panama Canal presented.

ARE U. S. SUBMARINES BELOW STANDARD?

The charge is made that our submarine torpedo boats are below standard and that in case of an emergency they would be practically useless. In substantiation of these charges, it is asserted that in the recent fleet maneuvers out of twelve submarines in use, six were put out of commission by breakdowns and had to retire. In connection with this, it will be remembered that one of our torpedo boats sank in the harbor of Honolulu, Hawaiian Islands, and the whole crew drowned. While the efforts to raise this boat has been going on steadily since it sank, at last reports it had not been brought to the surface, so that the cause for this awful disaster may be ascertained; however, the charge is made that this boat was built in Seattle by an unfair ship-building company and that the poor quality of the work done by the unfair men who built it was the cause of this boat sinking. Whether this is so or not may never be known, but every effort possibly should be made to try to find out.

The importance of a rigid investigation is made much more manifest when we come to remember that bids for 26 submarines are to be let at an early date, two of which are to be of the latest and largest sea going type. If after building, any of these vessels fail because of poor workmanship and the crews lose their lives, the responsibility would rest with the contractor, and it would be little short of murder.

The safest and best plan would be for the government to build all of these vessels in the navy yards, thus insuring honest and efficient workmanship, as there would be no incentive to use unfair material or skimp on the work.

If we are to continue to enlarge our navy the only safe plan is to insist on eliminating contractors and having this work done in government yards.

MEMBERS OF AN ORGANIZATION MUST OBEY ITS LAWS.

The Supreme Court of British Columbia, recently decided a suit which upholds the authority of organized labor to enforce, among its members, compliance with its laws.

The suit referred to was a damage suit for \$10,000 instituted by a member of the Printers' Union against his local lodge. This man failed to comply with the laws of this lodge, in reference to making payment of dues we believe, and was suspended and afterwards lost his job because he was not in good standing and instituted suit with the above result. The decision was in accord with sound judgment and fair dealings, no union or any other organization could long exist unless it had the authority to enforce discipline among its members and compel their compliances with laws.

Members in joining, solemnly agree to abide by the will of the majority and lawful authority and are not entitled by any fair code of laws, to do as they please or disobey the laws of the organization they belong to.

CONVENTION OF HATTERS' UNION IGNORE LOEWE & CO. VERDICT.

It will be remembered that some time ago the United States Supreme Court awarded damages to D. Loewe & Company, of Danbury, Connecticut, against the union hatters of that city, and the homes of a number of the members were attached, and now this company threatens to have these attachments executed in order to satisfy this judgment of the court.

Interested parties, including the beneficiaries of this verdict, were hoping and expecting to see the A. F. of L. undertake to raise funds to satisfy this judgment, which with interest and court costs amounted to something like \$300,000. The matter came up at the last convention of the A. F. of L., and was referred to the Executive Council of that body, after mature consideration, the council decided that the Federation neither had the funds or the means of raising so large a sum, and therefore could not undertake the task of satisfying this unjust judgment. They put it up to the Hatters' Union at a recent convention of that body. It was decided to not undertake the task of raising the necessary amount to satisfy this judgment, but that it would endeavor to raise funds for the relief of those who have their homes taken from them. This decision will no doubt be a disappointment to the anti-boy-cott association who were backing the suit, as well as D. Loewe & Company, who, if they can cash such judgments, would make more money in lawsuits than they could making hats.

While the law has been amended since this verdict was rendered, and at present there is no apparent reason for a repetition of this verdict, still no one knows how soon some scheming and unscrupulous lawyer will find some excuse for a biased judge of some court to use in "handing down" another such verdict, and facilitating the cashing of these verdicts would make stronger the incentive to secure others. Let them whistle for the amount.

ANOTHER UNION HATER PASSES AWAY.

The public press recently announced the death of David M. Parry of Indianapolis, and a one-time president of the Manufacturers' Association, and in this capacity he showed his deep seated prejudice and hatred of unions. This is the third former president of this association to pass away recently, all of whom shows much prejudice towards organized labor.

It may be that this feeling of hatred had something to do with their demise, for hatred is a cankerous poison that brings death and destruction, not only to soul but to the body as well, none of these three men, Van Cleave, Post or Parry, were old men and with wiser rules of life might have lived to ripe old age, but the bile of their hatred, like a cancer, ate and destroyed the vitals of their bodies.

This points a moral which all might well bear in mind, which is that the world is not large enough for hatred to exist between the members of the human race, no matter what the cause, none of us should allow the canker of hatred for our fellow men to take root in our breast, for it means decay and death, not to those against whom it is directed, but to ourselves. We do not mean by this that even though we should be unjustly attacked, we should not resent it or try to defend ourselves, not at all; on the contrary, it is the natural instinct of a man to repel such aggressions with all of our power if necessary, and until reparation or apology is given, we are justified in remaining aloof from those seeking our injury, but to hate them, we should not, under any circumstances.

Were this rule of life adopted by all concerned in the industrial field, and all tried to live in accordance with the Golden Rule of doing unto others as we would have others do unto us, it would not be a hard job to solve the problems that confront us, and if we ever do successfully settle all of them it will be along the lines of this rule rather than that of force and the big stick.

In the meantime the union haters among the employers might take these lessons of the past to heart with profit, injustice and hatred leads to death and destruction, while fair dealing, and upright living begets confidence and love.

AMERICAN NEUTRALITY.

From revolutionary days, when American liberty was born, down to the present time, the policy and desires of the United States has been one of peace, peace with ourselves and the world at large, these peaceful desires prompted us to follow the advice of Washington, to avoid entangling alliances with other nations, so that we could continue to pursue this policy indefinitely, and the nations of the world have come to realize our sincerity in this policy.

However, it has not always been possible for us to pursue our way in peace, conditions arose in the past, that made it necessary for us to assume the attitude of warriors so that the rights and liberties of mankind might not be taken from them by the ruthless hand of military despotism. It was in defense of these rights that prompted our Government shortly after coming

into existence to send a fleet of warships against the Buccaneers of the Barbary coast and drive them out of existence because they were preying upon and destroying American ships and commerce; it prompted this nation to declare war against England in 1812 because that nation insisted in taking men from ships flying the American flag and impressing them into service in the English navy. It was this spirit that in 1898, prompted us to take up the task of freeing Cuba from Spanish tyranny. Thus it will be seen that even though our Government and our people have always been peaceably inclined, we have at times, in the past, been forced to assume a different role and we are quite likely to be confronted with like conditions in the future, in fact we are face to face with a serious situation at the present time, due to practices arising from the awful world war that is now raging in Europe, that threatens to destroy the rights and lives of the people of neutral nations, and especially that of our own or at least that portion whose duty or business requires them to travel upon the high seas. While we all hope and expect a peaceable settlement of this matter, still we must recognize the serious aspects of the situation, as well as the impossibility of our surrendering our rights in the matter. There can be no justification for the practice of sinking merchant vessels without notice, a notable case of which was the sinking of the *Lusitania* when thirteen hundred non-combatants, most of whom were women and children, were sent to a watery grave at the bottom of the ocean, and of this number more than one hundred were American citizens.

The United States has demanded of Germany that it cease such warfare in the future and make compensation to the families of those who have already been killed or drowned.

Germany's reply to our first note was very evasive and another note reiterating our position has gone forward. This is the note our erstwhile Secretary of State, Bryan, used as a pretext for resigning his office, and is now busily engaged in advocating a peace at any price campaign. While he was no doubt sincere in his belief, we are convinced his judgment was seriously at fault in resigning at the time and under the circumstances he did; his action, no doubt, considerably embarrassed the Government for the time being, by creating the belief abroad, that the administration as well as the nation was seriously divided in their plans and policies.

However, public opinion has shown unmistakably that the people of the United States stand unitedly behind the President and the Cabinet. The people want peace with honor and not peace at any price, if this government would tamely submit to having the rights of neutrals ruthlessly taken from them and their lives placed in jeopardy by such high handed practices as torpedoing merchantships without notice, then would all the other nations of the world have to submit to this cruel and unjust warfare also. There are also grievances we have against England, because of the methods of holding up and delaying our ships in reaching their destination in neutral ports; our Government must and will insist on these things being righted without delay, and the surest way to have them satisfactorily, speedily and peaceably adjusted, is for the whole nation to show it stands firmly and unitedly behind

the President in the stand he has taken. With most of the nations of the world at war, with millions upon millions of men grappling at each others' throats, Mr. Bryan will find that he is several eons ahead of time, in advocating a peace at any price policy. To all those whose hearts and desires are attuned to peace this policy is pleasing to the ear, however, its practice is not only detrimental but absolutely dangerous to the future peace and liberty of our people for it would destroy all of our weapons of warfare and prevent any preparations of defense against any enemy of the future, and such helpless condition would soon create one, as it did with China only recently. We all must strive for peace, but at the same time neglect none of the precautions of preparation, which prudence and forethought suggests.

QUOTATIONS.

Let us stand by the constitution as it is, and by our country as it is, one united and entire; let it be a truth engraved on our hearts; let it be borne on the flag under which we rally in every exigency, that we have one country, one constitution, one destiny.—Daniel Webster.

Have you ever rightfully considered what the mere ability to read means? That it is the key which admits us to the whole world of thought and fancy and imagination? To the company of saint and sage, of the wisest and wittiest at their wisest and wittiest moment? That it enables us to see with the keenest eyes, hear with the finest ears, and listens to the sweetest voices of all time? More than that, it annihilates time and space for us.—Lowell on Books and Libraries.

Justice is the fundamental and almost only virtue of social life; as it embraces all those actions which are useful to society; and that every virtue, under the name of charity, sincerity, humanity, probity, love of country, generosity, simplicity of manners, and modesty are but varied forms and diversified applications of this axiom. Do unto another only that which thou wouldst he should done unto thee.—Volney.

To dread no eye, to suspect no tongue, is the great prerogative of innocence; an exemption granted only to invariable virtue. But guilt has always its horrors and solitudes; and, to make it yet more shameful and detestable, it is doomed often to stand in awe of those to whom nothing could give influence or weight, but their power to betray.—Dr. S. Johnson..

There is not, in my opinion, anything more mysterious in nature than this instinct in animals, which thus rises above reason and falls infinitely short of it. It cannot be accounted for by any properties in matter, and at the same time works after so odd a manner that one cannot think it the faculty of an intellectual being. For my own part, I look upon it as upon the principle of gravitation in bodies, which is not to be explained by any known qualities inherent in the bodies themselves, nor from the laws of mechanism.

but according to the best motions of the greatest philosophers, is an immediate impression from the first mover, and the Divine energy acting in the creatures.—Addison.

The great high road to human welfare lies along the old highway of steadfast well-doing; and they who are most persistent, and work in the truest spirit, will invariably be the most successful; success treads on the heels of every right effort.—Smiles.

Philosophy has been defined. The science of things, divine and human, and the causes in which they are contained; the science of effects by their causes; the science of sufficient reasons; the science of things possible, inasmuch as they are possible; the science of things evidently deduced from their first principles; the science of truths, sensible and abstract; the application of reason to its legitimate objects; the science of the relations of all knowledge to the necessary ends of human reason; the science of the original form of the ego, or mental self; the science of science; the science of the absolute; the science of the absolute indifference of the ideal and real.—Hamilton.

The surest and most pleasant path to universal esteem and true popularity is to be just, for all men esteem him most who secures most their private interest and protects best their innocence; and all who have any notion of a Deity believe that justice is one of His chief attributes, and that, therefore, whoever is just is next in nature to Him, and the best picture of Him and to be revered and loved.—MacKenzie.

STRIKES NOW IN FORCE.

- Illinois Central R. R. (Federated Trades strike on.)
- Harriman Lines. (Federated Trades strike on.)
- Pere Marquette R. R., Grand Rapids and Saginaw, Mich. (System Federation strike.)
- Contract shops, Mobile, Ala. (Metal Trades strike.)
- Atlantic Basin Iron Works (Shields & Moran, New York). (Strike on.)
- Hibbon & Co., contract shop, South Chicago, Ill. (Unfair.)
- Milwaukee Boiler Co., Milwaukee, Wis. (Strike on.)
- Stockton, Calif. (Metal Trades strike.)
- Warren City Boiler & Tank Co., Warren, Ohio. (Strike on.)
- Standard Boiler & Plate Iron Co., Niles, Ohio. (Strike on.)
- Reeves Bros., Alliance, Ohio. (Strike on.)
- Hammond Iron Works, Warren, Pa. (Strike on.)
- The Petroleum Iron Works, Sharon, Pa. (Strike on.)
- The Treadwell Construction Co., Pittsburgh, Pa. (Strike on.)
- Riter-Conley Construction Co., Pittsburgh, Pa. (Strike on.)
- Des Moines Bridge & Iron Works, Des Moines, Iowa. (Erecting work at Bremerton, Wash., Valejo, Calif., and Norfolk, Va., Navy Yards.)
- La France Engine Co., Elmira, N. Y. (Strike on.)

Mechanical Department.

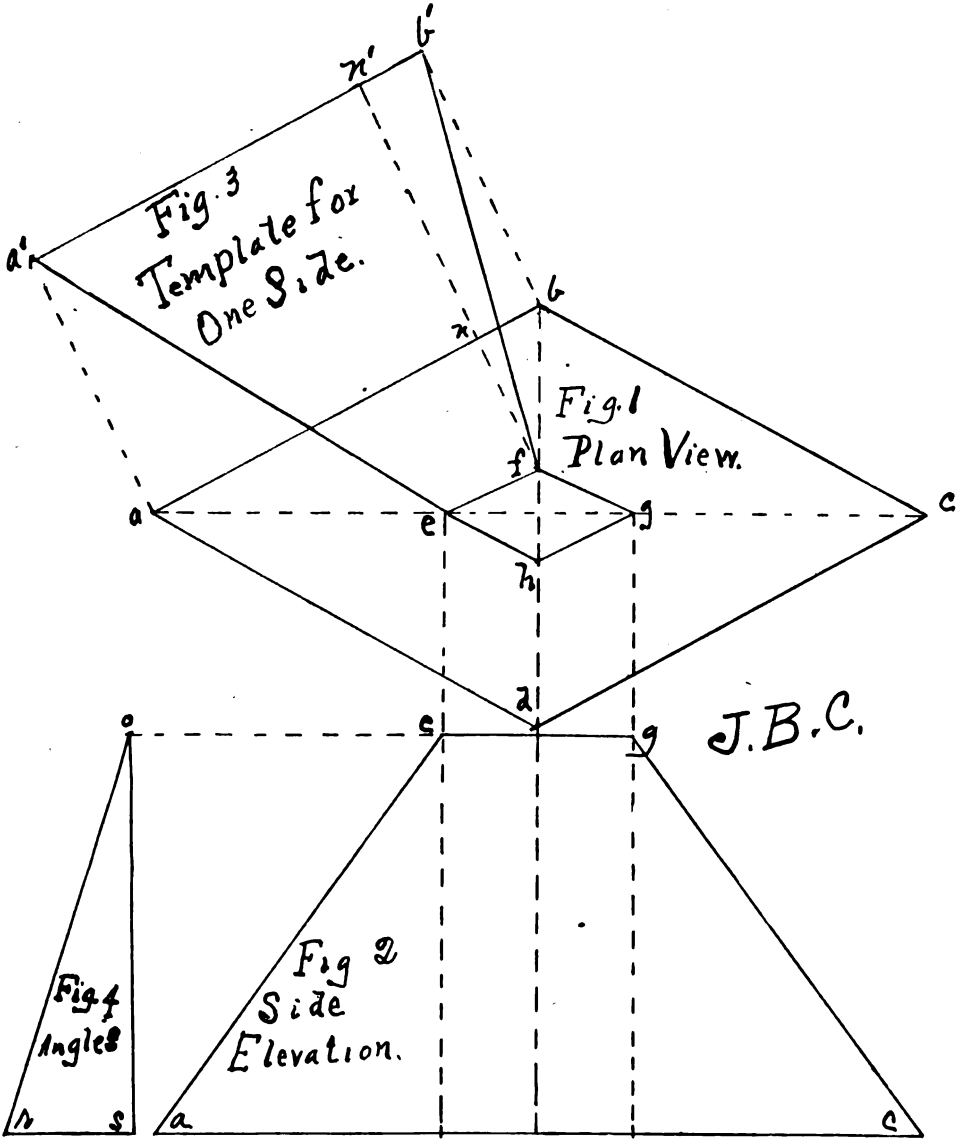

TO LAYOUT THE FRUSTUM OF A DIAMOND-SHAPED CONE.

In the accompanying cut, Fig. 1 shows the plan view and Fig. 2 the elevation of a diamond-shaped frustum of a cone, and Fig. 3 shows the layout of template for one side. To layout frustum, make plan view and elevation the desired size and shape. Next erect the angles, Fig. 4; from S erect line $S-O$, at right angles to $R S$; then turn to Fig. 1, and from center f strike a line at right angles to line $f-e$; then take the distance from f to where this line crosses the line $a-b$ at N and transfer distance to Fig. 1, from s to r , and from this point strike line from O to r . Take the distance from

these two points and mark it off from f to n' , Fig. 3; from point n' on this line strike line at right angles to $f-n'$ and parallel to $a-b$, Fig. 1. Take distance from n to b , Fig. 1, and transfer from n' to b' , Fig. 3, and from point b' strike a line to f . Next take distance from n to a , Fig. 1, and transfer from n' to a' , Fig. 3, and from the last point, a' , strike a line to e , Fig. 1. This completes the template for one side, with the exception of adding material for laps, if necessary. All sides being alike, the other three sides can be marked from this one template; however, two will have to be reversed, that is, turn over the template while marking off two sides.

International Officers' Reports.

COMMUNICATION FROM THE INTERNATIONAL SECRETARY-TREASURER.

Kansas City, Kas.

All All Members, Greetings:

We have been notified by several of the lodges of this Brotherhood that when traveling brothers are going over the country they should secure a service letter before leaving their last place of employment, if they intend to receive transportation over railroads, as we have received many complaints stating that the shop committee would not, or could not, vouch for our members who did not have service letters. Therefore, we kindly ask all members to be governed accordingly.

Hoping that you will comply with this request, and with best wishes, I beg to remain,

Yours fraternally,

FRANK P. REINEMEYER,
International Secretary-Treasurer.

COMMUNICATION FROM THE INTERNATIONAL SECRETARY-TREASURER.

June 18, 1915.

To the Officers and Members of All Subordinate Lodges, Greeting:

I desire to say a few words to the members of our organization through the columns of the Journal, and that is that each and every member take an active interest in all of the meetings and see that the officers fulfill their duties to which they are assigned and especially to see that the financial secretary forwards his report promptly each month so the individual members may not be deprived of their good standing in reference to death and disability benefits.

Under the new reporting system, these reports are checked up each month with the cards in the card index system, and it will show at any time the members' standing since we have installed the card index system and the new reporting system. We will be able to notice at any time when a member becomes three months in arrears, so it would be well for each and every member to see that he does not become three months in arrears and see that the secretary forwards his report promptly.

No doubt you are all well aware of the fact that the benefits paid by the organization are in reference to death and disability benefits and I do not believe there is any other organization that pays the benefits this organization does for members to keep themselves in good standing.

I wish to say a few words to the secretaries. We have three hundred forty-three lodges which we consider in good standing and of these three hundred forty-three lodges there are eighty-five per cent of the secretaries who always have their reports to this office in accordance with the constitution under Article 8, Section 4, and I am of the opinion that if eighty-five per

cent of the secretaries can get their reports mailed by the 8th of the following month, the other fifteen per cent should be able to do the same. The majority of the secretaries of this fifteen per cent who fail to get their reports to this office in due time are secretaries of small lodges ranging with a membership from ten to perhaps fifty, and I have noticed this very carefully and the secretaries of our large lodges are always prompt with their reports, so I do not see any reason why a secretary of a small lodge could not be as prompt as a secretary of a large lodge.

I hope that the secretaries who have not been sending their reports in promptly will do so in the future.

I also wish to remind the financial secretaries of this Brotherhood that we desire to have the International Lodge stamp report filled out completely each month, as we are now getting our records in shape so we will be able to tell at any time if the secretaries are purchasing sufficient number of stamps for the members they are reporting. We expect to make an equalization every six months, for the time being, on the stamp account and the members reported. Therefore, I request that each and every secretary give us the exact number of stamps they have on hand the first day of July and immediately upon checking up the June reports with the cards in the card index system, each Lodge will get a statement showing the members reported and the stamps purchased since January 1, 1915, up to and including June 30, 1915. Any lodge that has failed to purchase sufficient number of stamps, according to the members reported, we will have to request that they remit the amount to the International as per capita tax on the membership reported.

Trusting that all secretaries will comply with this request, with best wishes and kind regards, I beg to remain

Yours fraternally,

F. P. REINEMEYER,
International Secretary-Treasurer.

REPORT OF SECOND INTERNATIONAL VICE-PRESIDENT NOLAN.

To the Officers and Members of the Brotherhood, Greeting:

At the conclusion of my last report I was leaving for Rocky Mount, N. C., to take up a grievance for Brother A. J. Dixon, a member of Lodge No. 239, with the Motive Power Department of the Atlantic Coast Line Railroad Company.

Brother Dixon had been an employe in the boiler department for a period of almost four years and was laid off last October with five other boiler makers because of a depression in business as claimed by the company at that time.

Brother Dixon's record while in the employ of the company was excellent, and his work as a mechanic was never questioned; in fact, the shop officials at Rocky Mount so stated on many occasions that Boiler Maker Dixon gave entire satisfaction during his service with the company, and further never had a reason to visit a doctor or lay off on account of illness during his term of service.

January, 1915, there was a vacancy at the Wilmington, N. C., shop. Brother Dixon made application for same, but was turned down by the foreman as an undesirable, and in the face of the above record given him by the officials of the Rocky Mount shops. Which indicates very plain of a nigger in the woodpile somewhere, but later on the position was offered him, but under certain conditions which Brother Dixon could not accept: First, his family was located in Rocky Mount and he had been out of employment since October, 1914, and was not in a position financially to bear the expense of moving. Second, if he accepted the job at the Wilmington shops he would be compelled to give up all committee work in connection with District No. 38, which he was president of at that time. However, he had the absolute right to refuse the position as the Wilmington shops are under the jurisdiction of the master mechanic of the Rocky Mount shops, which entitled him to the first vacancy at the Rocky Mount shops, according to seniority and expected nothing whatever until such vacancy did occur.

On April 27 Brother Dixon received notice from Mr. J. H. Painter, shop superintendent, Rocky Mount, notifying him that there was a vacancy in the boiler shop, and to report to work May 1, providing his medical examination was satisfactory. Brother Dixon reported, as instructed, to the company's doctor, and although an employe of the company for several years, not discharged from the service of the company at any time, was temporarily laid off because of dull business conditions; yet he was disqualified by the medical examiner after a severe blood and urine test.

When Brother Dixon first entered the service of the company he stood a medical examination and passed as physically qualified to perform the work required, but, strange to say, at his last examination, April 27, 1915, Brother Dixon was disqualified from entering the service of the company, on account of being physically unsound, although never unwell in the company's service. See?

On May 3 I arrived in Rocky Mount, N. C., and met Vice-President McCreery of the Brotherhood of Railway Carmen, who was there at that time on business in connection with his organization. We held a meeting with Brother Dixon, also Brother Moore, who is one of the executive board members of the A. C. L. Federation of Shop Trades, going over the entire situation in connection with Brother Dixon's case, and,

realizing from information given that nothing could be accomplished by a local committee, I wired President J. F. Aylward of the A. C. L. Federation of Trades to come to Rocky Mount as soon as possible. He arrived on the 9th inst.; committee meeting was called the same date, and those present were President Aylward, A. C. L. Federation; Brother McCreery, Vice-President of B. R. C. of A.; Brother Moore, executive board member; also Brother Dixon and the writer.

Every detail in connection with the grievance was discussed by the committee and finally agreed that Brothers Aylward and Moore would wait on the superintendent of motive power at the Rocky Mount shops the following morning. The committee did so, but reported to the general committee later that nothing whatever was accomplished with the superintendent of motive power, as that official absolutely refused to place Brother Dixon back to work until a clean bill of health was given by the medical examiner of the A. C. L. Railroad Company.

Brothers Aylward and Moore afterwards called on the medical examiner at Rocky Mount and used every argument and appeal possible to have Brother Dixon returned to work, pending a re-examination, but he refused to take any further action other than what he had already done, and, realizing that nothing could be done either with the local officials or the medical examiner of the Rocky Mount shops, I left for Wilmington, N. C., on the 12th, accompanied by President Aylward and Brother Moore, also Brother Dixon, in order to meet the general superintendent of motive power, Mr. R. E. Smith, arriving there the same date, 10:30 a. m. Brother Aylward mailed him a communication, advising that there was a committee in the city who desired to meet him on Boiler Maker Dixon's grievance—namely, his disqualification for re-employment, by the medical examiner of the company at Rocky Mount, N. C., and later on the committee was notified that he, Mr. Smith, would meet committee at 12 p. m., same date. After a general discussion on the merits of the case by the committee, nothing was done whatever in the way of reinstating Brother Dixon, as the same old argument was put up by the general superintendent of motive power as the local officials put up at Rocky Mount, N. C., nothing whatever against Boiler Maker Dixon, his character good, his workmanship entirely satisfactory, but, nevertheless, he could not return to work unless he passed a satisfactory medical examination, which discussion was final with him, but he had no objection whatever to a re-examination of Brother Dixon by the chief medical examiner at Wilmington, N. C. The committee took advantage of this suggestion and waited on the chief medical examiner, but that official absolutely refused to take any further action, owing to the fact that the company's doctor at Rocky Mount dis-

qualified Boiler Maker Dixon as physically unable to perform the duties as required, but later on if Brother Dixon showed any signs of improvement that he would give the matter consideration.

Before leaving Wilmington, N. C., we got out an explanatory circular covering Brother Dixon's case as near as possible, a copy of which was mailed to each member of the executive board of the A. C. L. Federation of Trades, also one to President Franklin for his information and future action if in his judgment it was deemed necessary. In connection with the explanatory circular of President Aylward let me say that in the interest of justice to the shop employes of the A. C. L. Railroad System, that a concerted move should be made by the Federation to abolish such a weapon of discrimination which can be used successfully against any employe who may be deemed undesirable because of activity in the interest of his fellow men.

A relief association on a railroad system has for its object the protection of the shop men when sick or injured by accident, but used for any other purposes, as in Brother Dixon's case, debarred by a medical examination with no possible means of redress, although in the employ of the company for several years. This system should receive the careful consideration not only of the men employed in the mechanical department, but in the transportation department, paying money into the institution for the privilege of being disqualified when making application for re-entering the service after being laid off on account of a reduction of force, although never sick or requiring a doctor previous to suspension.

It is no wonder that state or national legislation is enacted to curb the efforts of some unfair corporations in their dealings not only with the general public, but their employes also, who would least expect fair consideration at all times for services rendered. There are many corporations whose officials desire to be fair, and many more that are absolutely unfair and to such an extent that their method of dealing with their employes is a blot on the American civilization and American manhood and must be stopped. As every man and every woman who are wage earners must and have the absolute right to organize for their protection against such unfair opposition, all business bodies, as well as professional bodies, organize for mutual protection in securing freedom of thought, freedom of action, according to law, in the regulation of their business for greater profit at every opportunity, and the very men who are the loudest in proclaiming their right to do so according to law when their own particular interests are involved, use every means in their power to crush the legitimate effort of the wage workers of America in securing sufficient wage to maintain a decent standard of living which they are entitled to.

In conclusion and in connection with Brother Dixon's case, I desire to make a

special mention of the active co-operation of Brother McCreery, Vice-President of the Brotherhood of Railway Carmen, in his efforts with me while at Rocky Mount, N. C. Brother McCreery is well known in this section and has the absolute confidence of the railroad shop men in the Southeastern District, as his work in their interest has at all times got results; although a blunt speaker, yet he is conservative, always looking carefully at both sides of a controversy. Justice is his motto. It doesn't make any difference which party is entitled to it, the men or the company, he doesn't hesitate to render justice where justice is due.

May 13, received instructions by wire from First Vice-President Hinzman to proceed to Waycross, Ga., when business at Wilmington, N. C., was finished, and adjust a misunderstanding between Lodges No. 425 and District 38, A. C. L. System, reaching there on the 14th.

Met Brother Schultz, president of Lodge No. 425, as well as other officers and members, same date, and arranged to hold a special meeting on the 14th. Brother Schultz suggested that I wire Brother Ryan, secretary of District No. 38 to come to Waycross to be present at a special meeting, requesting that he bring with him minutes of last district meeting at Savannah, Ga. Brother Ryan complied with request, arriving evening of the 14th.

Meeting was called to order by Brother Schultz, president of No. 425, who explained the object of meeting and the reason why the district secretary was requested to attend meeting, after which he requested the writer to take the chair; there was a fair attendance, considering the extreme hot weather, and much interest was manifested during the entire meeting. On taking the chair I explained the object of my visit to Waycross and my instructions from the International President in connection with Lodge No. 425 and District No. 38, and am pleased to report that after a general heart-to-heart discussion on the part of Brother Schultz, president of No. 425, also Brother Ryan, secretary of District No. 38, as well as many of the members present a satisfactory adjustment was reached, which I am confident will prevent any misunderstanding in the future, as it was agreed that all questions at issue between No. 425 and the district would be taken up at a regular district meeting or with the International President if necessary. I have known Brother Schultz for several years, and he is always on the job and willing to line up at all times according to conditions as he sees and understands them, and if any misunderstanding or mistake was made by Lodge No. 425 in connection with business of District 38, it was done with the absolute impression that their position was correct, as the argument on the night of the 14th fully demonstrated that fact, but when proved otherwise there was very little trouble in adjusting matters satisfactorily, and I desire to thank the officers and mem-

bers of No. 425 for their co-operation on that occasion.

Brother Ryan, secretary of District No. 38, is also secretary of Lodge No. 20, Jacksonville, Fla. and is generally known as the old reliable. You can't get by unless the goods are on you (an up-to-date card), faithful to the duties of the offices he holds and for the interests of the membership at all times. Many traveling brothers who have met him in Jacksonville, Fla., know it, for when Brother Ryan says, "No," there is nothing doing, and when he says, "Yes," he is there with the goods.

Left Waycross, Ga., for Jacksonville, on the 15th, in company with Brother Ryan, to attend a meeting of Lodge No. 20, also to be present at the funeral of Mrs. B. M. Jewell, wife of Brother Jewell, president of District No. 40, Seaboard Air Line Railroad, who was buried at Jacksonville, Fla., on May 16.

There was a large turnout at the funeral, of the members of Lodge No. 20, to pay their last tribute of respect to the departed, and fraternal sympathy to her husband, Brother Jewell. Before the mortal remains of Mrs. Jewell were removed to her last resting place, the officiating clergyman recited the burial service, after which he delivered an impressive address on the duties of Christian life.

The floral offerings were many and beautiful and among them was one from Lodge No. 20. May she rest in peace.

May 17, attended a meeting and smoker of Lodge No. 20, and as usual almost the entire membership was present. Promptly at 8 p. m. President Clarke called the meeting to order; many important questions came up for consideration, which were handled with promptness and in constitutional form. Lodge No. 20 hews right to the line, regardless of opposition, and the result is there is very little kicking when a constitutional decision is made by the chair. After the regular order of business was transacted, a lunch and other hot weather life preservers were served up in good shape, which was appreciated by all present, so much so that several good practical talks were made on the Brotherhood, both local and national, as follows:

Brother Jewell on state laws and also the necessity of an effort having been made through the central body of Jacksonville and the State Federation of Florida for a state boiler inspection law, and other necessary legislation for the protection of the wage workers of the state of Florida.

Brother Cole also made a fine address on the absolute need of co-operative action of organized labor on many vital questions, both city and state that should be carefully considered in the future, and practical methods adopted to push it forward to success, and assured all present that a pull together was the great lever to success.

I had the pleasure of visiting Brother Cole's home the night before leaving Jacksonville. He lives in the suburbs of the

city with his family, and I must say he has a beautiful home. May his years be long and prosperous in the enjoyment of it.

May 19th, left for Savannah, Ga., on my way to Brunswick; on arriving at Savannah I called up Brother Buchhiet who called on me later on in company with Brother Black, formerly of Lodge No. 12, Macon, Ga., afterwards met Brother Dillon of Lodge No. 26.

May 21st, left for Brunswick, Ga., in company with Brother Dillon, arriving there that evening. The following morning started to investigate conditions, shops, and the number of boiler makers employer there. We first visited the shops of Parker-Ensell & Co. Has a fairly well equipped boiler shop but no boiler makers employed, nor did I see any work of any kind on the floor, either new or repair. A small river boat was tied up at the dock with three niggers at work in the fire room, not a white boiler maker employed, and the only contract boiler shop at Brunswick, Ga.

Brother Dillon and I next visited the shops of the Georgia Coast & Piedmont Railroad Co., where I found one boiler maker, one blacksmith, three machinists and seven carmen, all white, which was the entire force of that company. Got the boiler maker to accept an application for membership and later on will be initiated in Lodge No. 26. Returning to Savannah, Ga., on the night of the 22nd. Brunswick, Ga., is now a hundred per cent organized, one white boiler maker in that burg, and later on when business improves a system federation will be formed as all crafts are now organized, some federation, will have a membership of twelve, comprising the four trades.

May 24th, attended a special meeting of Lodge No. 26 with a fair attendance present, Brother Masey in the chair. Brother Tripp, president of the Savannah Trades and Labor Council, was present and made a pretty able address on the benefits of a strong labor movement, and further assured all present he was much pleased with the delegates from Lodge No. 26 and hoped the good work would continue, not only in the Boiler Makers Lodge but all locals in Savannah, as co-operation was one and the only road to success in the labor movement. There was several other short talks made by several members, including Brothers Black and Dillon.

While in Savannah I had the pleasure of meeting a brother whom I have known for several years, Brother Kent, of Lodge No. 26, and always an active, hard worker, not only in the interests of his own organization but the entire labor movement of the Forest City of Savannah, and hope the good Lord in his wise dispensation of earthly favors will give Brother Kent many more years to enjoy a well spent life, for Brother Kent is now in the same class as the writer in his declining years. Before adjourning Brother Kent was requested to make a few remarks in connection with the Brotherhood

and done so, said he was always pleased to speak on the good work of the Brotherhood he was a member of so long. His remarks was given the closest attention by all present, due to the fact of his interest for the boiler makers of Savannah for many years, and his royalty to the principles which the labor movement stands for, and in closing appealed to the members, to get close together so as to protect themselves and families which is the real issue of the movement to make it possible to secure a decent existence.

While in Savannah I was informed there was a certain foreman in the railroad shop who was trying to play horse with some of his men, regardless of the agreement with the company; a word to the wise is sufficient, better stop it, give every man a square deal, conditions being equal, seniority to govern, that's business.

May 25, left Savannah, Ga., for Chattanooga, arriving there morning of the 26th. The object of my visit in Chattanooga was to assist Lodge No. 14 in reinstating their delinquents, as well as organize the unorganized boiler makers there, also to cooperate in a forward labor movement in that city which had been under way for several weeks. Various international representatives were in the city all co-operating with each other, and in the interest of their respective crafts. Among others were Vice President McCreery of the Railway Carmen, Corley of the Machinists, Flanagan of the Blacksmiths, Smith of the Moulders and Swick of the Painters. Had the pleasure of meeting Brother Jack Gribben of Lodge No. 14; hadn't met him since the Baltimore convention of the Brotherhood about fifteen years ago. Brother Gribben is still active as ever, has an eye on business at all times, has given me his experience and co-operation in lining up the delinquents of Lodge No. 14, attending special meetings of Lodge No. 14 as well as other local organizations, even in bad, stormy weather, when younger men who should be there refused to show up.

Brother Evans, secretary of Lodge No. 14, also gave me much information as to conditions, scale of wages and hours worked in the several contract boiler shops in and around the city of Chattanooga, as follows: Casey & Hedges, Walsh & Wagner, Chattanooga Boiler & Tank Co., and the Lockett Boiler Co., all of which are working a ten-hour day, when a nine-hour day could be established without very much trouble if there was a metal trades council there, as Chattanooga is somewhat of a manufacturing city and at present has organized local metal trades sufficient to secure better conditions.

I have noticed there is a lack of practical methods in conducting the affairs of the local organized movement in the mountain city. It is true there is a good central body in Chattanooga and a few live wires affiliated with it, but what is very much needed to get labor forces closer together is a local federation of railroad shop crafts

as well as a local trades council to protect the industrial situation, which is a very important factor and will be more so in the future, as cheap labor and long hours of toil retards the progress of any city and the average business man hasn't foresight enough to see it, as the poor gets poorer year after year, while the manufacturing interests gets theirs. Yet we find mechanics who claim to have good American horse sense, won't organize in order to have the unhuman privilege of competing against each other. Surely there is something out of joint with men of that caliber, willing to be crushed when there is an opportunity to prevent it.

May 28, attended a special meeting of Lodge No. 14, in the C. L. U. Hall, to discuss the question of a greater membership, and before adjourning it was agreed to reinstate all delinquents of Lodge No. 14 on the same basis as all other organizations were doing through a Forward Labor Movement in Chattanooga. Same night attended a meeting of the C. L. U., which was a success, as the large hall was packed and considerable interest was manifested in hearing the different speakers explain the necessity and object of the American labor movement.

May 30, attended another special meeting of Lodge 14 which was an explanatory meeting, each delinquent giving his reasons why he became in arrears; however, three delinquents concluded to make their peace in returning to the Brotherhood and respect the constitution which they took an obligation to do at one time, after which meeting adjourned to hold another later on.

I am very sorry in having to report the untimely death of Brother Robert Rodgers, Reg. No. 72184, initiated in Lodge No. 14, June, 1907. At this writing there is no detailed account of the accident which caused Brother Rodgers' death only that it occurred in the vicinity of New Orleans. The body was shipped to the home of his father in Chattanooga where he was buried on June 1st. The funeral was largely attended by his many friends as well as the members of Lodge No. 14.

The following members of Lodge No. 14 acted as pallbearers: Brother Jack Gribben, J. E. Evans, J. E. Anderson, W. Gribben, Jas. Johnson, William Nash, G. W. Wolfe and John Ruel.

Brother Rodgers leaves a father two sisters and a brother to mourn his sad ending. The writer was present during the funeral service and extended my sincere sympathy to the family in their sorrow for the loss of a son and brother.

In next report will explain result of last special meeting of lodge No. 14, held on June 4th, as well as others matters in connection with the general labor movement in the city of Chattanooga.

With best wishes to the officers and members of the Brotherhood, I am

Faternally yours,

THOS. NOLAN.

REPORT OF FIFTH VICE-PRESIDENT ATKINSON.

Spokane, Wash.

I was in Helena, Montana, on my way to Great Falls when I sent in my last report. Upon my arrival at Great Falls I arranged for a meeting with the members of Lodge 602; also invited all boiler makers and helpers that were employed at the smelter to attend the meeting, and I am pleased to report I was successful in getting 19 applications. Also had a committee appointed to go with me the following Tuesday night to the mill smeltermen's meeting for the purpose of trying to get that organization to release the boiler makers and helpers that were employed at the smelter. Up to the present time all boiler makers and helpers that worked in the smelter had been compelled to pay dues into the mill and smeltermen's organization; as that organization claims jurisdiction over all men employed in and around the mines and smelters.

We have made several attempts to have the mill and smeltermen's organization allow the boiler makers and helpers employed at the smelter to work without paying dues into their organization, as we considered it was an injustice to the boiler makers and helpers to have to pay dues into two organizations. I am very pleased to report we were successful in getting the mill and smeltermen to release all boiler makers and helpers, and hereafter any boiler maker or helper going to work in the smelter can do so without being forced to pay dues into the mill and smeltermen's organization.

The following evening I arranged to hold another meeting with the members of Lodge 602 for the purpose of obligating the new members and electing officers, and I feel sure if the members of Lodge 602 will give the officers the proper support they should that Lodge 602 will be as good a local as we have in our Brotherhood.

I went to Anaconda from Great Falls, and held a meeting with the members of Lodge No. 80, and I am pleased to report that I found the members of Lodge No. 80 all good union men and doing everything they possibly can to hold the conditions they already have. The members of Lodge No. 80 have been having considerable trouble lately on account of the iron workers, claiming work that rightfully belongs to our members; but I feel sure in the future our members will insist on getting all work that rightfully belongs to our members. Also will insist that the agreement we have with the iron workers will be lived up to.

I am glad to report that quite a few of our members have gone to work in Anaconda, but from letters I have received from some of our members since leaving Anaconda, I would not advise any of our I have been informed that they are full-handed at the present time.

From Anaconda I went to Butte City, and had the pleasure of attending a meeting with the members of Lodge No. 130. I also found

the officers and members of Lodge No. 130 all good Union men and doing everything they possibly can to better the conditions of our members.

I went to Deer Lodge from Butte and held a meeting with the members of Lodge No. 528. The members of Lodge 528 all work for the Milwaukee, and I am sorry to report that work is still very slack, and no prospects of any change in the near future, but I am pleased to report that the officers and members of Lodge 528 are all good union men, and are always ready and willing to do their part to assist in bettering the conditions of their fellow men. While in Deer Lodge I had the pleasure of meeting and eating supper with my old friend, C. F. Hoziea.

From Deer Lodge I went to Havre, Montana, and held a meeting with the members of Lodge 367. Also glad to report that I was successful in getting several applications while in Havre. Also found that the members of Lodge 367 were working very short time and prospects of no change in the near future.

From Havre I came to Spokane, stopping off at Whitefish and Troy. Am in Spokane at the present time, trying to get the boiler makers and helpers that are not members of our organization to join, but I am sorry to report prospects are not very encouraging, as the boiler makers and helpers are working very short time in Spokane, and in all my travels I have never seen any boiler makers and helpers that are so easy satisfied as the unorganized boiler makers and helpers in Spokane. All they want is a job and plenty of work; money or conditions cut no figure with them. They are working for from 15 to 18 cents an hour less than union men are receiving at the present time in this section of the country.

There is another thing I would like to call to the attention of our members. I have received complaints lately from our members both in Panama and Honolulu about some of our members accepting employment for less than the standard rate of pay, and I hope in the future if any of our members accepts employment in either Honolulu or Panama they will insist on getting the standard rate of pay, which is 62½c per hour in Honolulu, and 65c per hour in Panama.

Also see that Article X, Sec. 2, of Subordinate Lodge Constitution, is carried out, which plainly says members must deposit clearance cards immediately after receiving employment.

At this time I feel as though I should say a few words in reference to the Harri-man and Illinois Central strikes. I understand that there is considerable agitation on the part of a few individuals to have these strikes declared off. Now, brothers, I believe before any action is taken to declare these strikes off, each and every member should consider well what effect it is going to have on the rank and file of our organization. I for one, consider we have

everything to gain and nothing to lose by continuing these strikes. If I thought for a minute that even ten per cent of the men that came out on strike would be taken back, I then might agree to the declaring off of these strikes. But from past experience I have learned that there is nothing gained by declaring off strikes, and admitting defeat.

I remember well when we declared the Santa Fe strike off. The statement was made on the floor of the convention at St. Paul: "Declare the Santa Fe strike off and we will go back, and inside of one year, we will organize that road." Well, brothers, that has been seven long years ago, and I can assure you that there is very little organization among any of the shop crafts today on the Santa Fe. I will admit that there are a few good union men working on the Santa Fe, but I also know there are men working on the Santa Fe carrying cards for no other purpose than to find out all they can and keep the officials of the company posted in case there is any attempt being made to organize the shop men on that road. I feel sure if the Harriman and Illinois Central strikes were declared off tomorrow the only men that would be taken back is men that would promise the officials of the company that they will never have anything to do with a labor organization as long as they work on the Harriman and Illinois Central, and when the officials of the company pick out what men they want, I feel sure that the road will be a closed road for years to come against any union men. I believe if the strikes are declared off at the present time we will be doing exactly what the officials of the company are hoping and praying we will do, for I am satisfied the condition at the present time on the Harriman and Illinois Central are not at all satisfactory to the officials of the company.

We hear some of our members say: "Look at the number of mechanics we are making by continuing these strikes." I am positive that there has been very few mechanics made on the Harriman or the Illinois Central since the men were forced to go on strike, for the conditions on these roads are so bad that even a scab does not stay very long. I am sure that the officials of the Harriman and Illinois Central have hired more men to work in the shops the past three years and eight months than they hired in fifteen years previous to the strike. These strikes are not costing the different organizations involved very much at the present time, as all organizations have discontinued paying strike benefits some time ago, and I believe that over 90 per cent of the men that came out on strike have secured employment at other places, and in view of these facts I say, let us continue these strikes just as long as the officials of the Harriman and Illinois Central insist on making slaves out of our members.

I know that the men that were forced to go on strike on the Harriman and Illinois Central had a just grievance, as they have

not received any increase in pay for four years on the Southern Pacific, and in many of the shops conditions were very bad, and the agreements the men had were being violated by the officials of the company continually.

Another thing, the men on the Harriman and Illinois Central lines were not asking for anything more than had already been granted the shop men on many other roads in this country. I also know that the men did everything that was possible to be done to prevent these strikes. They were ready and willing at any time to meet the officials of the company more than half way, in order to avoid trouble, but the officials of the company were determined to wipe out organized labor on those lines and in their effort to do so, they have cost the stockholders thousands of dollars, and I, for one, do not consider they have accomplished what they started out to do.

I again say, in justice to the men that were forced to go out on strike on these lines, that each and every one of us do everything that we possibly can to assist them to win these strikes. Let us ask every union man, friend and sympathizer of organized labor not to travel or ship freight over the Harriman or Illinois Central. Remember every time we stop a man from buying a ticket to and from the coast it means very near \$100.00 profit gone, and I believe the best way to win a strike is to hit the fellow's pocket book that is fighting you as hard as you can.

I believe we should advertise these strikes in every labor journal and labor paper in the United States. Also place pickets with a banner in front of the ticket offices in all the principal cities notifying the traveling public that the shop men on the Harriman and Illinois Central are on strike for a living wage and better shop conditions.

Hoping this report will be satisfactory, I will close, with best wishes and kindest regards.

Yours fraternally,
WM. ATKINSON.

REPORT OF INTERNATIONAL DEPUTY ORGANIZER SCOTT.

Boston, Mass.

Dear Sir and Brother:

My last report for the Journal was written in Pottsville, Pa., where I had been assigned to do some work by President Franklin, upon a request of the Central Labor Union of that city. I found upon arriving in Pottsville that it was almost impossible to render any assistance to Lodge No. 256 as a great number of their men employed in the Philadelphia Coal & Iron Company's shop had been laid off recently, and that those that were working were only on half time. I learned while there of a tank that was being erected in one of the breweries by non-union boiler makers, and succeeded, with the assistance of the local committee, in having the job straightened out. Some of our men who were idle were put on the job to finish it.

About this time I received a telegram from President Franklin instructing me to proceed to Green Island, N. Y., to meet there with the representatives of other organizations in order to take up some work in connection with the Railway Department. On arriving in Green Island I met with Brothers Tobin of the Blacksmiths, Davison of the Machinists, and Knight of the Car-men. We held a meeting in the hotel, and after comparing notes found that our instructions were to go over the D. & H. and the O. & W. systems, holding joint meetings at all the principal points for the purpose of building up both federations and in order that the misrepresentation and the misstatements made by the disciples of a new brand of I. W. W.-ism (a bosses' dual union that is trying to tear down the organizations on these systems) might be straightened up and our members enlightened as to the real facts.

I am not going into details in this report about the meetings we held and the success we met with at every point we visited. I have made reports to President Franklin regularly and in detail since I have been assigned to this work. The secretary of our crew, Brother Davison, has also sent weekly reports of our work to President A. O. Wharton of the Railway Department and I believe that it is understood that latter on the department will make a report of our work through the different official journals. I want to say that in this new move of the department, the fight is being brought home to the enemies of organized labor just as it should have been done long ago. In every meeting we held the records of dual unions in the labor movement were gone into thoroughly; their object and their purpose were fully explained, as also the reputation, the purpose and the aim of the fakers and grafters who head these movements, and as a result a large number of men, and in some places whole locals, swung over to where they belonged. The defense put up by these disciples of the "one big stew" in defense of themselves and their dual union didn't ring true, and their battle cry of "Down with Gompers and the American Federation of Labor" proves beyond a reasonable doubt just where they belong.

This cry of theirs, like their form of organization, is anything but new; both originate from the same source—the Employers' Association. That is the cry of Drew, Perry, Taft and all the rest of the labor haters in creation. Post, of ground peanut fame, the greatest enemy of organized labor this or any other country ever produced, used that cry with his dying breath, and yet we find long after he has committed suicide, the American Federation of Labor is stronger than it ever was, and Brother Gompers is still its President, and so it will be when this dual union has run its course and its leaders have taken their places in history, with the other crooks and traitors who were hired from time to time to try and wreck the labor movement.

Long after they are forgotten, the name of President Gompers will be honored, and the American Federation of Labor will continue to prosper.

Shortly before finishing up on the O. & W. we received instructions from President Wharton to proceed to Boston and take up the same line of work on the N. Y., N. H. & H., the B. & M. and the Maine Central. We attended a meeting of the New Haven System Federation, and then left for Portland, Me., where we held two big open meetings; we also held a meeting at Waterville, Me. The boiler makers and their helpers at both these points did belong to the dual union, but since these meetings were held there are a number at both places that have quit paying dues, and I believe that it will be only a question of a short time until these men on the Maine Central are back where they belong.

After the last meeting in Portland, we decided to split up for a while; the other representatives left to take up work at other points, and I went back to Boston to try and build up Lodge No. 515 which was then in real bad shape. I spent nearly five weeks there and in that time succeeded in reinstating over sixty members in that local. A new set of officers was elected, also new shop and other committees. The lodge is now in a prosperous condition, and with the exception of one shop that is working short time we have a hundred per cent organization. The men in this shop are coming in as fast as can be expected, and it won't be long before this point is straightened out, too.

I was called home in the early part of May on account of sickness in my family, and while there received word from Secretary Reinemeyer that Lodge No. 573 at Lansford was in bad shape, as there had been no reports received from them in over three months. I got in touch with the men there as soon as possible, called a meeting of the lodge and discovered that the financial secretary was to blame for this condition of affairs. Upon further investigation I found that he was not only careless, but that he was short in his accounts since taking office, to the extent of \$170. In order to protect the lodge and the international organization, I was compelled to swear out a warrant for his arrest, charging him with embezzlement. The case was finally settled to the satisfaction of all concerned, by his paying back part of the money and having his family, who are real estate owners, sign a note for the balance to be paid within one year. This is another case of the members of a lodge depending too much on their officers. Lodge No. 573 was fortunate in getting the settlement they did, and I believe that they have learned a lesson that will be useful to them in the future.

While working in Boston I made several unsuccessful attempts to organize the men at the navy yard. I believe, however, that there will be a chance to do something with

these men later on. I also gave what assistance I could to Brother Generson, the business agent of Lodge No. 585, in straightening out some trouble our men had with the Bartlett & Haywood firm on a gas holder that was being erected at Marblehead, Mass. It was necessary for us to take the men off this job for a time, in order to get justice. The strike only lasted for a few days, the trouble being adjusted satisfactorily.

On finishing in Lansford, Pa., I returned to New York to join the other representatives and attended a meeting at Van Nest, N. Y., where there is real good prospects of getting the pipe fitters and the electricians there away from the dual union.

From Van Nest we went to New Haven, where we held a very successful meeting of all crafts May 28. While in New Haven my time was taken up pretty well investigating a dispute between the boiler makers and the helpers regarding the funds of the old helpers' local; this money never was turned over at the time of the amalgamation, and some of the former officers of the old helpers' local, who had control of these funds became dissatisfied lately, and, acting on the advice of some of these union busters, decided to draw this money out of the bank and divide it up. The matter is now in the hands of one of the best lawyers in New Haven, and these misguided helpers may learn to their sorrow that while "division and silences" may be all right, and in accord with the principles of the leaders of this dual union, it is not in accord with the laws of Connecticut.

This concludes my report up until June 1. Hoping that it meets with approval, and with kindest regards, I remain

CHAS. F. SCOTT,
International Deputy Organizer.

REPORT OF INTERNATIONAL DEPUTY ORGANIZER REED.

Victoria, B. C.

At the conclusion of my last report I was in Portland, where we had a large number of members working on the government dredge Chinook, which was undergoing extensive alterations. This job I am glad to report was a strict union job and was completed without any trouble whatever, and I wish to take this opportunity of congratulating both the men and the contractors, Messrs. Cornfoot and Rogers, on the perfect harmony that prevailed throughout. At the same time the Willamette Iron Works were busy on the large repair job mentioned in my last report, and this job run along smoothly until Lincoln's birthday, when a controversy arose as to this day being a legal holiday. It had been proclaimed a legal holiday in the state of Oregon in 1913 and Lodge No. 72 recognized it as such. Since that date, however, the firm refused to pay double time and then men took the day off and on reporting for work the following morning every man was

handed his pay check. Unfortunately I had left three days previously for Seattle and was there when I received a wire notifying me of the trouble. I returned to Portland at once and on arrival was informed that Mr. Andrews, the superintendent of the works, had personally visited some of their riveters at their homes and requested them to return to work. I advised these men to go to work until I had a conference with the firm. I met Mr. Andrews at noon that day and requested him to reinstate all the men that had been paid off. This he refused and said that outside of the men who had returned to work that morning not one of them would be taken back. I then told him that if that was the stand he had decided to take, there was no other course left for me but to pull the riveting gang off again, which I did. A special meeting was called and applications sent to Grand Lodge for strike benefits, which was granted, and a strong picket line was maintained. But I am sorry to say that in spite of the splendid work of the pickets, the firm was able to ship scabs in from different points and finish the job, and were assisted greatly by three of our ex-members who probably thought they would get a lifetime job for scabbing for this firm, but will find their mistake out in the near future. The names of these three men are Lester French, John Larsson, or Lawson, and C. Gill, the last named was one time secretary of Lodge No. 72. Having spent five weeks in Portland, and having done all I could I left for Seattle, where Lodges No. 104 and 489 had consolidated and elected Brother Dan Killop as business agent, and I am satisfied that they acted wisely, and I am glad to say that in spite of the continued depressions of trade in this district, Brother McKillop is increasing his membership and doing fine work.

I left Seattle for Vancouver where I had several matters to take up on behalf of Lodge No. 194 and where we are still taking in new members. I again returned to Portland to take up business in connection with a number of tanks to be built for the Shell Company of California in the Northwest, and having made satisfactory arrangements in this direction, I returned to Seattle and in company with Brother McKillop went to Bremerton where the Des Moines Bridge and Iron Works were erecting two large tanks, and had refused to recognize the union or pay the scale of wages. After Brother McKillop and myself had done all we could without success it was decided to strike the job, and as we had seven men on the job we were able to tie it up for the time being, and from last reports received they are making very slow progress. I left Seattle for Victoria, B. C., to try to line up a stand pipe job, and on reaching the job found it had started that morning, and there was a boiler maker, a past members, and a helper on the job pulling the steel into position, but were not being paid the scale. I took the matter up with the man in charge and he agreed to

pay the boiler maker and helper the union scale, and if he required any more help to apply to Brother Stewart, secretary of No. 191. As this was satisfactory I talked to the men on the job and they promised to line up. While I was in Victoria I received a wire requesting that I go to Prince Rupert as our members working on the construction of the dry dock were on strike. I left for Prince Rupert the same day and on my arrival found they were on strike in sympathy with one of the helpers who had been fired and the firm had refused to pay his transportation back to Vancouver, B. C. Now my arrangement with the firm at the start of this job was that first class fare would be paid to the men after they were on the job thirty days, and the return fare would be paid at the completion of the job, and the company reserved the right to discharge a man for incompetency or neglect of work at any time. In this case the company while claiming that this helper was in every way qualified as he had proved by working five months on the job without complaints started to lay down on the job for the purpose of getting fired. However, on I had heard the story for all sides I was of the opinion that the company had good grounds for an argument. However, Mr. Deane, representing the Pool-Deane Co., contractors for the job, agreed to pay the transportation under protest and appeal to the grand lodge. As I considered he had a perfect right to do this and this being acceptable to the men then returned to work, and as Mr. Deane was in favor of having a signed agreement, Brothers Marley and Laurie, stewards on the job, and

myself, drew up one and submitted same to Mr. Deane and the members, and after a few alterations was accepted and signed, so there ought to be no further trouble on the job. I wish to take this opportunity of thanking Brothers Marley and Laurie for their valuable assistance rendered me during my stay in Prince Rupert.

Having no further business in Prince Rupert I returned to Vancouver where I am sorry to say business is very dull at this time. After a few days in Vancouver I went to Victoria where the British cruiser Kent is in for repairs to damages she received in the naval battle off the Falkland Islands and most of our members from Lodge No. 191 are working on this job, and a number of lapsed members who have promised to reinstate. There was a question of overtime in connection with this job. I was requested to take up on behalf of the members of Lodge No. 191, and I am pleased to report had a conference with the chief engineer of the yard, the outcome of which was in every way satisfactory. Through the courtesy of the chief engineer I received an invitation to visit the shop and got a very good idea of the terrible havoc that can be wrought in naval warfare. I could not conclude this report without extending my sincere thanks to Brother Alex Stewart, secretary of No. 191, and his wife, for their kindness in entertaining me on my visit to Victoria. This will conclude my report to date.

Hoping same will be satisfactory, and with best wishes, I remain,

Yours fraternally,

JOE REED, I. D. O.

Correspondence.

FROM THE RAILWAY DEPARTMENT.

St. Louis, Mo.

(Continued from last month.)

by way of comparison, that the leopard cannot change its spots, this is equally true of Richardson and the staff of officers under his supervision. The I. A. of C. went out of existence simply because the great majority of its membership learned that Richardson had, by his own statements, proven himself to be absolutely unreliable; his campaign of vituperation, acting as a boomerang, had brought upon his own head, and justly so, its own reward. What has Richardson accomplished? He has spent thousands of dollars, collected from all sources where money was obtainable, in an effort to disrupt our organizations. He is today, as always, sending his paid emissaries into any locality that appears to offer a field in which they can sow their seed of discontent and dissension. He has absolutely failed to successfully guide the destinies of the International Association of Carworkers, the members of which were, and are now, associating themselves with the Brotherhood of Railway Carmen. The

following charters issued during the past few months represent in whole, or in part, members who left Richardson's organization to become affiliated to the B. R. C. A.: Nos. 209, 355, 387, 392, 446, 463, 474, 480, 515, 533, 543, 559, 560, 561, 563, 564, 565, 567, 568, 569, 575, 576, 577 and 581.

Richardson claimed that none of the men who belonged to his organization have gone over to the Brotherhood of Railway Carmen. The above list is the answer and can be verified by writing the secretaries of any of these locals. On the other hand, we have the proof in his own Journal that one of his organizers, established a lodge on the M., O. & G. Railway, Muskogee, Okla., during the life of the federated strike on this road. This lodge is composed of strikebreakers who took the places of the men on strike. We know what Richardson tried to do on the Illinois Central; we don't know that he has ever been paid for acting in the capacity of a strikebreaker, but we believe he ought to have been; anyone who desires further information can secure the facts by communicating with the editor of the Strike Bulletin, Clinton, Ill.

The American Federation of Railroad Workers is similar to the plan of the I. W. W. and has just about as much to recommend it. This is not Richardson's first attempt along this line, while still acting in the capacity of President of the I. A. Carworkers, and under salary, without the knowledge or consent of the members, he organized and put afloat the now extinct Eastern Federation of Carworkers, and like his latest scheme for exploiting the workers, he took in every workman that could be separated from the price of admission; the life of this organization was a short but stormy one, and those who accepted his promises and became associated with Richardson in this venture, came to grief. If you doubt this, ask the men on the Lehigh Valley and Philadelphia and Reading Railroads.

Now comes along another exponent of how it should be done, in the person of W. H. Pierce; he, too, failed to make good as a salaried representative of one of the transportation organizations, and when he failed to be elected to office, and his salary was discontinued, he started out to build up an organization of his own and, as a matter of course, pronounced himself its President, named his own salary and drafted a constitution—otherwise eminently satisfactory to Pierce, if not to anyone else. He made the term of office four years and so framed the laws that it would be rather difficult to elect anyone to succeed him for at least another four years.

We have not gone into his activities and the disastrous results following his efforts to organize the men on the Pennsylvania Railroad, where he called a strike without any hope of success or means of taking care of those who followed his leadership. Pierce has named his organization the Brotherhood of Federated Railroad Employes and its purpose to be that of organizing all railroad employes into one organization. Both Richardson and Pierce represent that type of trades unionists who refuse to recognize the will of the majority; they have both advocated a similar form of organization as a panacea for all the difficulties coincident to the trades union movement. Both have failed to recognize the necessity of tolerance or respect for those who differ with them, and in this, as in all other respects, they have forfeited the right to have or hold the confidence of their fellow workers. The progress made and the things accomplished by the American labor movement are in themselves proof of the survival of the fittest; we cannot hope for or expect to make progress out of proportion to the standard of intelligence or reasoning powers of the majority, those who think they possess the mental qualifications and ability to point out the way, must be capable of successfully appealing to and convincing at least a majority that they are advocating the thing to be desired.

A labor union represents an organization of workmen who have voluntarily associated

themselves together for the purpose of securing improved working conditions, better opportunities for self improvement and mutual protection, the basic principles necessary to the successful maintenance of such an organization, are that of honesty, tolerance and faith. We will leave it to the judgment of the rank and file as to whether or not it would be either a safe or profitable investment to desert the organizations that have withstood the acid test of time, the combined attacks of organized capital, the insidious machinations of the traitor and which represent a value to their respective members that cannot be measured in dollars and cents, to follow the leadership of men who have demonstrated their incapacity as such, and whose chief claim to distinction lies in their refusal to respect the wishes of, or abide by the will of, the majority.

The bona fide trades unions recognize and obey the laws and rules of procedure which the members adopt for the government of their respective organizations; there can be no argument advanced that will justify the secession of any portion of the membership; any attempt at secession stamps the promoters as being opposed to majority rule, and carried to a logical conclusion, this would mean the disintegration of all organized effort.

The Railway Employes' Department of the American Federation of Labor as now organized places at the disposal of its affiliated membership the opportunity of solidifying the railroad workers as never before; the progress made has got beyond the experimental stage. Over seventy system federations are now organized; a majority of them are working under federated agreements and have justified the expectations of the rank and file; the laws of the department may not meet with the full approval of all, but they can and no doubt will be changed from time to time to suit the ever changing industrial conditions.

We have called to your attention the failure of the Knights of Labor and the American Railway Union; the mere fact that these organizations went out of existence should be sufficient to prove that they were fundamentally lacking in those essentials necessary to the successful performance for which created. The Industrial Workers of the World have but recently added another chapter to the already long list of failures directly chargeable to organizations based upon a theory that has been proven to be fundamentally unsound. We refer to Butte, Mont., where, as a result of the growth and activity of the adherents to the I. W. W. principles, one of the strongest union centers on this continent has all but been disrupted. They succeeded in accomplishing that which the mine owners assisted by the Pinkerton detectives, had been unable to do. The Western Federation of Miners had successfully fought and maintained their organization and union conditions of employment, against every con-

ceivable form of attack promulgated by the mine owners, but they were unable to cope with the I. W. W. If you want the facts, giving in detail just what the I. W. W. succeeded in accomplishing in Butte, Mont., write the Western Federation of Miners, Denver, Colo., and secure a copy of "The Miners' Magazine" issue of November 5, 1914. If you are not in possession of this information, you owe it to yourself, your family and your organization, to become fully acquainted with the attendant results of secession and mob rule as exemplified by the advocates of this one big union.

The American Federation of Railroad Workers (the Richardson organization) and the Brotherhood of Federated Railroad Employes (the Pierce organization), like all other organizations of this kind, attempt to justify their existence by promising immediate results and benefits, out of all proportion to the results and benefits obtained by the members of the organizations which have proven their worth and justified their existence by their record of things actually accomplished. Any organization launched by men who employ tactics so closely resembling the methods used by the paid emissaries of the employers in their efforts to nullify and even destroy the organizations of the workers, certainly cannot gain a permanent following among the earnest workers of this great movement.

Temporarily, Richardson and Pierce may succeed in their campaign of vilification and vituperation, but their own statements will be the means of their undoing; their exaggerated promises cannot be fulfilled and when those who have been induced to follow their leadership awaken to a realization of the fact that they have been unconsciously contributing their support to an organization that is being used as an agency to defeat the organized workers, Richardson and Pierce will be left standing alone and forsaken, as they deserve to be.

Not so long ago, we found Richardson on the Atlantic Coast Line, where in order to retain the semblance of an organization, he sanctioned the signing of an agreement from which the apprenticeship and several other important rules were eliminated by the company, all of which had previously been in the agreement. The majority of the men in the Car Department belong to the Brotherhood of Railway Carmen and are affiliated with the Railway Employes' Department. This is only an example of what may be expected, yet it represents an additional expense to the members of the bona fide organizations, with the employer reaping the benefit.

The Railway Employes' Department represents a form of organization that meets with the approval of a large majority of the members who follow railroad work. It is not a theory, it is not patterned after organizations that have been tried out and found to be impracticable; its laws are made by the representatives of the rank

and file and are the result of years of experience and observation. Its officers are also elected by the representatives of the rank and file and both office and laws are subject to change, by this same authority.

We have but one object in view and that is to perform our duty and put forth our best efforts to strengthen and solidify the organizations of the workers; we are not fighting union men, neither are we trying to tear down and substitute a theory for a certainty; we have a fair conception of our weaknesses and knowing them we endeavor to make due allowances for our shortcomings. The labor movement is too serious a problem and represents too much to the workers, to permit men who have proven their incapacity, to experiment with it. We favor evolution rather than revolution; changes are taking place every day and we are adjusting ourselves to meet them just as rapidly as the majority of the members are ready. We cannot bring ourselves to believe that there is even a single trades unionist who honestly believes that it would be advisable to destroy the bona fide organizations in order to try out an experiment. Yet that is exactly what is being advocated by men of the Richardson and Pierce type. We believe that every sensible man must recognize that agitation and education are the only methods that can be safely relied upon to bring about any desired form of organization, or the amalgamation of kindred crafts, and make such organization or amalgamation permanently effective or successful, when a minority attempts to use force, coercion or intimidation to compel a majority to accept that which they are not prepared to accept, failure is sure to result.

Just remember that a labor organization represents an institution that is composed of men and women who have voluntarily associated themselves together, and to insure its permanency one of its fundamental principles must be based upon the right of the majority to rule.

A. O. WHARTON,

President Railway Employes Dept.

Fort Worth, Tex.

At a regular meeting of Lodge No. 96 the following resolutions were adopted:

Whereas, Our Heavenly Father, whom we believe and know doeth all things well, has in His infinite wisdom, called to His Heavenly Home, the beloved mother of our worthy and esteemed Brother, P. O. Kilander; therefore, be it

Resolved, That we extend to our brother and his family our sincere and heartfelt sympathy in this their hour of sorrow.

As one more tie is broken there will be one more to welcome them when they have reached that land where there is no more parting nor sorrow.

Be it further resolved, that a copy of these resolutions be sent to the family, a

copy spread on our minutes, and a copy sent to our official Journal for publication

Respectfully submitted,
J. M. CRAIG,
LEO. BAUER,
L. A. FREEMAN,
Committee.

Fort Worth, Tex.

Whereas, death has entered the home of our worthy and esteemed Brother, Oscar Henderson, and removed his beloved son to his Heavenly Home above; therefore, be it

Resolved, That Lodge No. 96 extend to Brother Henderson and his family our sincere sympathy and consolation in this, their hour of sorrow.

May they find comfort in the words of Jesus when He said, "Suffer little children to come unto me for such is the kingdom of Heaven."

Be it further resolved, that a copy of these resolutions be sent to the family, a copy spread on our minutes and a copy be furnished our official Journal for publication.

Respectfully submitted,
J. M. CRAIG,
T. M. SMITH,
L. A. FREEMAN.

New Orleans, La.

Dear Sir and Brother:

I have been requested by Lodge No. 205 to mail the enclosed photo to the editor of the Journal for reproduction in July Journal, and hope you can do so as Lodge No.



BRO. D. J. CORCORAN OF LODGE 206,
ALGIERS, LA.

206 is a pretty good one. Brother Corcoran is the oldest member of the Brotherhood, at least in this section.

Yours fraternally,
THOS. NOLAN.

The subject of the above sketch of Brother D. J. Corcoran is one of the old-time school of boiler makers of the good old days now passed, but yet on the job just the same, as a layer-out of the Texas Pacific shops, Algiers, La.

Before any National or International Brotherhood of Boiler Makers were organized Brother Corcoran was an active member of the Boiler Makers' Benevolent Association which was organized in the city of New Orleans in 1870. The late secretary-treasurer of the International, Wm. J. Gilthorpe, was also a member of the New Orleans Benevolent Association of Boiler Makers which cut considerable figure in securing better working conditions and increased wages at that time.

When the International Brotherhood was organized in the city of Chicago, Ill., Brother Corcoran was a charter member of Lodge No. 41, of New Orleans, afterwards Lodge No. 37, when the consolidation of both organizations was effected the National and International at Chicago, Ill., September 1, 1893.

He is at present an active member of Lodge No. 206 and always willing to lend a helping hand to further the interests of the boiler makers and helpers of the port of New Orleans, as well as the International Brotherhood when the occasion requires and trust Brother Corcoran will enjoy life for many years to come, surrounded by his family, is the sincere desire of the boiler makers and helpers of the city of New Orleans.
LODGE No. 206.

Deer Lodge, Mont.

Dear Sir and Brother:

Inclosed please find Journal mailing list. Also wish to notify you of the death of Brother A. Klugman, Reg. No. 32518 and wish you would kindly publish a memorial in the next issue of Journal.

Brother Klugman was elected to the office of sheriff of Mineral County in November, 1914, and at that time took a withdrawal card. On May 24, 1915, after Brother Klugman had retired, someone came in his room and asked him to go to a saloon and quell a disturbance that was going on; he got up and started to dress, when his revolver fell out of his trouser pocket, and when it struck the floor discharged. The bullet struck him in the abdomen and passed clear through his body, killing him instantly. The remains were shipped to Oswego, N. Y., his old home.

Brother Klugman had been employed as a boiler maker at Aberton, Mont., for six years previous to his election, and was well liked by all who knew him, and since taking office had made a fine record. The members of Mt. Powell Lodge No. 528 all join in extending our heartfelt sympathy to the bereaved family.

Yours fraternally,
J. H. THOMAS, S. L. 528.

Newport News, Va.

Dear Sir and Bro.:

As I have received a number of letters from brothers all over the States asking for work and how Newport News is at the present time, Brother Casey, I will try to let you know in as few words as I possibly

can. First, Newport News has not been so busy for many years and at present they have orders and work on hands that run up to something like \$22,000,000. This don't speak of old work that is coming in every week, so that anyone coming this way could find a job, but the wages or rates are not so high here as in other states where it is all tank work or railway work, but it is equal to any other ship building yards in the rates in other states. Much of the work is piece work and contract work, riveters, chippers and caulkers (hand and machine), also drillers are all piece work. Ship fitters and others are contract work (bonus system), all other trades are the same. Fitters get from 25 cents to 32 cents per hour. Riveters, day work, 25 cents per hour. Riveters, piece work, what they make. Chippers and caulkers, day work, 22 cents to 25 cents. Chippers and caulkers, piece work, what they make. Fitters are guaranteed their weeks' wages if they don't make out, and a bonus every week if the job is finished in time. Brother Casey, this is all I can say at present as there is plenty of work but little inducement for any man to come any great distance to here, but any brother in good standing coming this way I can say that the members of No. 55 will do their best for them.

With best wishes, I am

Yours fraternally,

DAVID McARTHUR, C. S. L. 55.

P. S. Will be glad to answer any letters.

Wichita, Kas.

Dear Sir and Brother:

Whereas, We the boiler makers and helpers of the state of Kansas do extend our most heartfull and many thanks to our legislature representative, Brother S. T. Sample, also Brother Jas. B. Casey, for their good work done in our past legislature, and while we did not accomplish our intended boiler inspection bill, the brothers done their best, and we extend them many thanks for their services.

Yours fraternally,

BRO. J. M. DEVLIN,

S-T. Legis. Con. of B. M., State of Kas.

Chicago, Ill.

Dear Sir and Bro.:

At a regular meeting of Garden City Lodge No. 1 of Chicago, Ill., the following resolutions were adopted:

Whereas, It has pleased the Almighty God, to take from our midst, our dearly beloved brother, Jas. Ross.

Resolved, That we extend to his bereaved family our sincerest condolence, in their most sorrowful hour.

Resolved, That our charter be draped and a copy of the above resolutions be spread on our minutes and a copy be sent to the bereaved family.

J. McKIRENAN,

JOS. CROTTY,

JNO. BURKE,

Committee.

Danville, Ill.

Dear Sir and Bro.:

Whereas, It has pleased the Almighty God in his infinite wisdom to remove from our midst Jacob Schroll; be it

Resolved, That Local 22, Boiler Makers, Iron Shipbuilders and Helpers of America do hereby extend our utmost sympathy to the bereaved family, and a copy of these resolutions be sent to the family, a copy sent to the Journal for publication, and one to the Local and our local charter be draped for sixty days.

FRANK JERGENS,

HERMAN POGGENDORF,

WM. J. IRWIN,

Committee.

Birmingham, Ala.

At a regular meeting of Lodge No. 4, International Brotherhood of Boiler Makers, Iron Ship Builders and Helpers of America, the following resolutions were adopted:

Whereas, God in His infinite wisdom has removed from this world of strife and toil, J. C. Horn, a brother of A. L. Horn of Lodge No. 4.

Resolved, That we, his brothers, extend to the family our heartfelt sympathy and condolence in this sad hour of sorrow and grief; and be it further

Resolved, That a copy of these resolutions be sent to the Journal for publication, a copy sent to the family, and a copy spread on the minutes.

JOHN DOUGLASS,

A. L. CARMACK,

R. D. HOOT,

Committee.

Pittsburg, Kas.

Dear Sir and Brother:

Please insert a notice in the Journal that I would like to locate the following brothers: Deny Callahan, Geo. Stevens, Dan McCarthy, Brodie McDonald and Martin Murphy, all real Irish boys and my friends, and would appreciate a letter from them. Getting old and lonesome.

With best wishes to all.

G. SPRATLEY, Reg. No. 547.

Baton Rouge, La.

Dear Sir and Brother:

Inclosed please find Journal mailing list, also a script which I wish you would publish in the next Journal.

Lodge No. 528 is offering a prize to the member which brings in the most applicants between June 10 and September 10, 1915. Prize, solid gold emblem watch charm.

Hoping this will be satisfactory to you, I beg to remain,

Fraternally,

S. V. ACOSTA.

East Boston, Mass.

Dear Sir and Bro.:

Lodge 585, on Tuesday evening, June 15, participated in the opening up of a vigorous campaign that has been started by the Metal

Trades Council of Boston for the purpose of adding to the numerical strength of the various bodies of organized labor in the metal trades crafts, and of injecting a degree of energy and activity into trade unionists in those crafts which has of late been sadly lacking.

President Frank Tully of Blacksmiths' Union 105, A. F. of L., Boston, who is also president of the Metal Trades Council, presided, briefly stating the object of the open mass meeting, which nearly filled Hibernian Hall.

Our worthy Sixth International Vice-President, Brother John J. Dowd, was the first speaker. He said in part:

"This proposition of the Metal Trades Council to establish a close bond of union among all the workers in the metal industries should be given consideration by all men employed in these different trades. Wherever there is a local branch of the International Metal Trades Council established it means that efforts will be made to protect the interests of all concerned. We should have a good metal trades council in Boston and I am pleased to know that the Boiler Makers of Boston have become affiliated with it, for it means a lot to us. If the metal trade workers at Newport News, Va., had been thoroughly organized and united, it would not have been necessary for the boiler makers there to go on strike for months in a protest against the unjust piecework, nor would it have been necessary for the boiler makers at the Franklin Steam Boiler Works to accept a reduction of fifty cents a day in their pay, if the workers in the various metal industries in the port of New York had been systematically organized. Signs are apparent that prosperity is coming in business in the metal trades and I hope that every man working at any of these trades shall attend and boom these mass meetings which are educational especially for the boiler makers, men of red blood who have proved their courage and intelligence. If the workers in the metal trades are organized we would get speedy recognition from the manufacturers to whom we can reply when they say to us: 'We are the ones who give you men your bread and butter.' Yes, but we (the workmen) are the ones who by the fruit of our labor make it possible for you manufacturers to live in luxury. I hope," continued Brother Dowd, "that those concerned will take this metal trades organization to heart and hope the Boston Metal Trades Council will be soon one of the biggest in the country which it has good prospects of being, for the men having it in charge have been years in the labor movement and are capable of framing propositions to promote the cause, and I hope to be back in Boston soon to help build up your organization."

Brother Dowd's remarks were warmly applauded.

Addresses followed by Business Agent John Connolly of the Machinists' Union; President Michael Birmingham, of the Bos-

ton Electrical Workers' Union; Business Agent Daniel N. Generson, of Boiler Makers' Lodge 585; Herman Cumerford, B. A. of Stationary Engineers' Union 203, all of whom spoke hopefully for the thorough organization of the metal trades in the City of Boston, and pledging themselves to put forth their best efforts to promote the same. Bro. Charles Scott, who has been doing good work in his capacity of deputy organizer for our International Brotherhood among the railroad boiler makers' organizations, which he has put new life into, when introduced, said:

"I am glad to speak here tonight to forward the progressive movement of your Metal Trades Council, and I hope your future meetings will be large that the work that has been started will go on till your aims have been accomplished."

The benefits that have been derived from trade unionism are so plain and visible that it is hardly necessary to enumerate them, for there is hardly a man working at any trade that has not been benefited by a labor organization. The boiler makers of Boston, who have gone through four strikes and have secured reduction in hours of labor and increase of wages can give a fitting answer to those who ask, what has the organization done for "us" and what is true in Boston applies to other cities where real genuine organizations exist in our crafts. None of the material, financial, or hygienic benefits enjoyed by mechanics at the government navy yards and arsenals would be enjoyed today were it not for the influence of trade unionism, which strange to say, is today receiving small support and little encouragement from these men.

Today the labor movement in the United States is passing through one of the most critical periods of its existence, for the National Manufacturers' Association is busy trying to throttle organized labor. Their propaganda we may say is divided into four departments, first the legal department, guided by Elihu Root, and these who are trying hard to have great labor laws declared unconstitutional, second the educational department, which embraces such men as ex-President of the United States Taft, Drew and Perry, who are delivering "lectures" throughout the country poisoning the minds of the public, with their theoretical sophistry in their analysis of trade unionism, third the political department typified by the notorious Penrose of Pennsylvania, who is working hand in hand with Barnes, of New York, who has had the audacity to proclaim that he intends, if possible, to wipe off the statutes every labor law that has been enacted at Albany, and fourth the labor department, the worst of all a lot of grafters, who have been thrown out of their own organizations for their crookedness and who at the behest and with the financial support of the sworn foes of organized labor start "dual" organizations in order to create dissension and to disrupt the real bona fide trade unions so it behooves us to be on our guard and look

forward to the time when every workman will safeguard his own interests by belonging to a true labor organization. Brother Scott's pungent remarks aroused great enthusiasm and among the membership of Lodge 585, who attended this initial meeting to boom the metal trades unionizing movement, were Vice-President Thomas J. Farmer, Business Agent D. M. Generson, Secretary D. B. McInnes, Treasurer Bernard McDonnell, Trustees John Warnock, Patrick Frawley and James J. Kerrigan and Brothers Thomas De Freitas, Austus E. Page, Chas. F. Smith, John J. Kerrigan, Charles Jenkins, John Hankard and Thomas Halsom. President Wm. E. McNabb was unavoidably prevented from attending, but the movement to perfect the Metal Trades Council in this city has no abler advocate than Brother McNabb.

Yours fraternally,
DANIEL B. MCINNES,
Secretary Lodge 585.

Algiers, La.

Dear Sir and Brother:

Lodge No. 206 was honored at their last regular meeting, June 11, 1915, with the presence of our second international vice-president, Thos. Nolan, the grand old man of the Brotherhood. Lodge No. 206 retaliated by giving a little smoker which was enjoyed by all present. Brother Nolan is here for the purpose of assisting our B. A., Brother Wm. J. Smith, in drawing up a new agreement with the contract shops and from all indications they will be successful in their efforts. Brother Nolan spoke on many matters of interest and how much has been accomplished through organization. He also promised to organize the Boiler Makers and Helpers in Algiers and New Orleans, as they have never been before, if permitted to stay. We trust the international president will grant the request.

The wave of slack times has hit Algiers and New Orleans a solar plexus blow. We have 60 per cent of our members idle at present, nevertheless the men are in good spirits and expect business to pick up in the near future. Lodge 206 has 46 members in good standing, something we never had before, which goes to show the members have not lost any of their union spirit. Besides Bro. Nolan and Bro. Smith we had Bro. D. J. Corcoran at the meeting. In spite of his 69 years of usefulness he still displays some of his youthful ambition, always with the bunch.

Hoping to see this in the next issue, I remain,

Yours fraternally,
JOSEPH KOENIG,
P. and C. S., L. 206.

Argenta, Ark.

Dear Sir and Brother:

I wish you would advertise Brother W. C. ShROUT, Reg. No. 32553, in our Journal, as he received a pass from Little Rock to Van Buren on false statements and Lodge No. 66 had to pay for the pass. So any secre-

tary taking up his card will please let me know of his whereabouts and hold card.

Also Brother C. Townsend, Reg. No. 62088. He secured a pass from Little Rock to Wynne, Ark., at the expense of No. 66. No more passes will be given out at Little Rock unless you have a service letter.

I hope you will find space in the Journal for this, and oblige

ED. WORTSMITH, S. L. 66.

Hoisington, Kas.

Dear Sir and Brother:

There appeared in the issue of the Strike Bulletin of May 5 an item stating that Brother E. J. Barrette, Reg. No. 6342, was scaling at Paducah, Ky., which is false. This brother has been working here in Hoisington for three years and is still here. We believe it would pay the editor of the Strike Bulletin to investigate before printing such untruths.

Hoping this contradiction appears in the next issue of the Journal, I remain

Yours fraternally,
C. W. CRAMER, C. S. L. 403.

New Orleans, La.

Dear Sir and Brother:

I am inclosing you small photo of the late Brother Robert Rodgers, Reg. No. 72184. The members of Lodge No. 14, as well as his father, would like very much to have same reproduced in next issue of Journal.



ROBT. RODGERS.

Brother Rodgers was accidentally killed by a railroad train on May 28, somewhere in the vicinity of New Orleans; no details of the accident have been learned yet. He was buried in Chattanooga, Tenn., on June 1. I have mailed May report under separate cover.

Yours fraternally,
THOS. NOLAN.

Savannah, Ga.

Dear Sir and Brother:

I inclose photo of Brother L. J. Flohr, secretary of Lodge No. 424 of Waycross, Ga., which I would like to have reproduced in July issue of Journal.

Brother Flohr is very active and has been

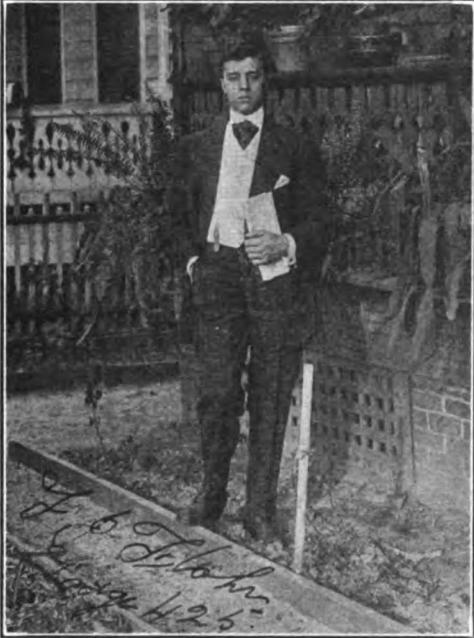

L. J. FLOHR.

since he was initiated as an apprentice about five years ago. The members of No. 425 speak very highly of him and would appreciate very much to see his photo in Journal.

I have just returned from Brunswick, Ga.; will attend a meeting of Lodge No. 26 on the 24th, after which I will wire the office for further instructions. I am

Yours fraternally,

THOS. NOLAN.

Jacksonville, Fla.

Dear Sir and Brother:

I am inclosing a memorial on the death of Brother Jewell's wife. Please have it published in our official Journal.

With best wishes, I am,

Fraternally,

E. S. RYAN.

At a regular meeting of St. John's Lodge No. 20, the following resolutions were adopted:

Whereas, It has pleased the Almighty God in His divine wisdom to remove from our midst the dearly beloved wife of our worthy and esteemed brother, B. M. Jewell, therefore, be it

Resolved, That we, his fellow brothers, extend to him our heartfelt sympathy in this his sad hour of bereavement, and pray that the Almighty God may comfort and console him that he may bear his trial with fortitude; and be it further

Resolved, That our charter be draped in mourning for thirty days, a copy of these resolutions be spread upon the minutes of our meeting and a copy be forwarded to our bereaved brother, also a copy to our official Journal for publication.

J. C. GARVEY,

B. M. COLE,

E. S. RYAN,

Committee.

Jackson, Ohio.

Dear Sir and Brother:

I, Otto Lee Martin, and family wish to give our heartfelt thanks to the Brotherhood of Boiler Makers, Iron Ship Builders and Helpers of Lodge No. 509 and to our foreman, Mr. Frank Kanur, for their kindness in the death of my beloved sister, Mrs. Charles Saluock. I remain,

OTTO LEE MARTIN,

Secy. L. 509.

Kansas City, Mo.

Dear Sir and Brother:

In our last issue of Journal there are several pieces that the members of our organization ought to read and study them over, especially the traveling members. The ones I mean are on pages 438, 440, 445, 468. The time has passed when boiler makers can jump from place to place and leave all things behind them. The future and the past are going to get you into trouble. In a central point like our city, they come and go every day and some traveling members think because they have a card and a book that the poor home guards owe them a living. There are some traveling brothers that are O. K. and square; others are not.

What would you think of a man who got 19 meals on a meal ticket or one that tried to trade a meal ticket to the saloon man for a bucket of beer. Lodge No. 32 has had cases like them.

Brothers, if you have to travel, why not travel clean? Get your clearance card fixed up right, the proper stamps in your book, pay all your bills and remember, don't want the earth, there is someone traveling behind you; and Register Numbers 89812, 99704, 56652, 21642, 28,001, 8986 and 23852. stay away from Kansas City; Lodge No. 32 is not running a free boarding-house.

Business is poor around Kansas City; there are enough boiler makers in town to fill 20 shops.

With best wishes, I am

Yours fraternally,

WALTER E. DWYER, S. L. No. 32.

Brainerd, Minn.

Whereas, It has pleased Almighty God in his infinite wisdom, to remove from our midst the dearly beloved son of our brother,

Charles Torkelson; therefore, be it Resolved, That we, the members of Pine City Lodge No. 116, hereby express our sympathy for Brother Torkelson and his family in their sad hour of bereavement and pray that they may receive strength and fortitude to sustain them in their sorrow; and be it further

Resolved, That a copy of this resolution be sent to our brother, a copy spread upon the minutes and a copy sent to our official Journal for publication.

RALPH HASTINGS,
MARTIN WIKLUND,
WALTER BULK,
Committee.

Albany, N. Y.

Dear Sir and Brother:

Will you kindly put this in your valuable Journal.

Fraternally,
JOS. ARNOLD,
Acting President.

THE DEATH ROLL.

Miss Josephine Leamey.

The funeral of Miss Josephine C. Leamey, the youngest daughter of John J. Leamey and the late Ella Grumbley Leamey, took place from the residence, 68 Livingston Avenue, and later from St. Joseph's Church, where a solemn mass was celebrated by

standing cross, graduating class 1913; spray of flowers, George Hudson; standing wreath, Mrs. B. Degan and Mrs. Pryor; standing wreath, Mr. Joseph A. Hughes. Rensealer; standing wreath, Mrs. Frank J. McGovern; standing wreath, George Hudson; standing wreath, Champion family; casket pieces—Mr. and Mrs. James Smith, Mrs. A. L. Robe, Miss Grumbley, Aquinas Circle of St. Joseph's Academy, Mr. and Mrs. Cyril Cassiday, Margaret Richford, Rhea Helen Conway, Mae E. Halsdorf, Breath Maas, Mr. and Mrs. M. J. Frizel, Mrs. J. C. Merrigan, George J. Baetzhof and Miss S. Pryor, Mrs. Leahy and family of Troy, N. Y., George Gabriel, Mrs. D. Lawloe, Mrs. Trainor, Mrs. Pearsall, Mr. and Mrs. Joseph Matthews, Mrs. Kane, Miss Winifred Dunphy, Mr. and Mrs. John Tracey.

The bearers were Messrs. John Curtis, Joseph Hughes, James Breen, Edward Flynn, Frederick Walsh, James Smith, Cyril Cassiday and Eugene Driscoll. Interment was made in St. Anges' Cemetery. Rev. Father Dunney officiated. Champion & Sons, undertakers.

Lafayette, Ind.

Dear Sir and Bro.:

It has, no doubt, been some time since there has been anything in the Journal from



A GROUP OF SOME OF THE MEMBERS OF LODGE 360, LAFAYETTE, INDIANA.

Rev. Leo Liddane as celebrant, Rev. Francis Kelly as deacon and Rev. Edwin Watson as sub-deacon. Father Liddane delivered the eulogy. The funeral was largely attended by the Children of Mary. Among the many funeral pieces were: Pillow, from father; standing cross, sister and brothers; star and crescent, Aunts Elizabeth and Sarah; wreath, Mr. M. F. Grumbley and wife; standing wreath, Mr. and Mrs. Mark McAvoy; wreath, Grumbley Brothers; standing heart, George and John Hughes; standing lyre, Mr. John Burns;

Local 360, so I have been appointed to correspond with you occasionally.

On Thursday evening, May 20, our regular meeting night, Local 360 gave a lamb roast and smoker for the entertainment of the members, at the Bartenders' hall, corner Third and Ferry Streets.

Meeting was called to order by President Ramp earlier than the usual hour so as to have ample time for the entertainment. The hall was decorated with Jack-o-lanterns and old gold and black, making a very beautiful appearance. About 9 p. m. the commit-

tee had everything in readiness for a good time. Committee: James H. Goldsberry, James A. Peacock and Merel Schoff. The table was very neatly arranged, laden with roast spring lamb and other delicatessen too numerous to mention. With several bouquets of carnations neatly placed about the table making a very appetizing appearance, everybody did justice to the supper. Next Brother Peacock passed some good union made cigars which was followed by a speech by Brother Goldsberry, taking for

us the next ball we have. Everybody had a good time that they will not soon forget.

The photo I am sending you is a flashlight taken by Brothers Montgomery and Peacock. Only about three-fifths of the members that attended lodge that evening are on it. They had left before we got that far.

Work around Lafayette is very slack, working 45 hours per week, about three weeks per month. A new boiler maker is put on occasionally but you have got to



A GROUP OF SOME OF THE MEMBERS OF LODGE 187, MIAMI, ARIZONA.

his text, "The Progress of Local 360 and the Brotherhood at Large," that caused much enthusiasm. It was now Brother Jack Halpin's turn to make his debut. Jack is an able entertainer, making many an otherwise idle moment jolly. He recited some good poetry but received more applause for singing.

By this time the boys began to look for something else to do. Some played cards, but most of us went to the bar-room where Brother "Smokey" Burroughs and Floyd "3/8" Montgomery were always on the job with a big foamy T. & W. while some of the others fed the big electric piano with jitneys and danced. There are several good dancers belonging to Local 360, and watch

have a good card or no work for you here.

As my letter is getting rather long I will have to close, hoping you will have space for our picture and letter. With regards, I remain,

Yours fraternally,
FRANK L. BONGEN.

Miami, Ariz.

Dear Sir and Bro.:

Please find enclosed picture of boiler makers and helpers taken at the Inspiration Mill shop, which I wish you would publish in the next issue of the Journal. Having nothing more to write, I am,

Yours fraternally,

Leo GAYAN.

A Compilation of Labor News.

BY THE A F OF L NEWS SERVICE

"SPEEDING UP" SYSTEMS.

Washington.—"Speeding up" systems are sufficient to upset the mind of an ordinary individual and produce insanity.

This is what the solicitor of the United States department of labor thinks of the stop watch method of production.

The department has sustained this view, which is included in an opinion by its legal adviser that a worker injured because of a strain from working under a "speeding up" system is entitled to relief under the federal workmen's compensation act.

The decision was made in the case of D. C. Manning, sailmaker at the Mare Island navy yard, California, who worked for twenty years without losing a day from illness. A time card system was introduced, and in his plea for compensation, Manning brought out these points:

"Under the time card system you had to give an account of every minute you were on the job, and we were given to understand that the men who did the most work would hold their jobs the longest. Later the Halsey system was introduced. Under this plan a time man, equipped with tablet, lead pencil and stop watch, sat in front of the worker to find out how long it takes to do a certain piece of work. The report to headquarters was your future standard for that class of work.

"The Halsey system is designed to get out of the man employed under it the greatest possible amount of work he can do in a given time, with the fear ever hanging over his head that a failure to keep up to the standard will cause him to lose his job."

Manning was engaged in making coaling bags, which are 42 inches long and eight feet in circumference. It is the hardest work in sailmaking.

Between the physical strength necessary in this work and the mental strain caused by every move being "tabbed," Manning collapsed, and asked for relief under the compensation act because of "a strain from rushing work under the Halsey system." Physicians reported that he would be disabled for life and that he was "suffering from incurable heart condition."

The attending physician reported that Manning was "an unusually vigorous man, as well as an energetic worker."

In indorsing the statement of claimant that he was entitled to compensation, the solicitor of the department of labor declared that the treatment accorded Manning was enough to produce insanity. The official said:

"Here was a strong, hearty, hard working employe who, for about twenty years, had been regularly employed by the government, and whose rating was first class. After putting in all those years of service and retaining his health, strength and vigor, a new system was installed in the government establishment by which the employe was kept under the highest nerve racking tension by reason of the fact that a man sat watching his every movement during every minute of an eight-hour day. In addition to this it will be observed from claimant's letter, above quoted, that the work he was performing was one of the heaviest and hardest kind to be performed in his occupation. Under such circumstances it is not a matter of surprise that his health should be injured and shattered, for it certainly seems that such treatment of a man engaged in heavy manual labor, necessitating also the use of the intellect, would be sufficient to upset the mind of

an ordinary individual and produce insanity."

The ruling of the department of labor is in line with the views of the last Congress, which passed the Deltrick bill, outlawing all forms of "speeding up" in government arsenals and navy yards. The passage of this bill was the result of a long campaign by organized labor. Opponents of the bill insisted that these "speeding up" systems really benefited the employe, who was thereby paid "according to his worth."

AMEND COMPENSATION ACT.

Boston.—The recent state legislature amended the state workmen's compensation act as follows:

In the case of an injury to a minor his future wage increases may be considered in determining damages. Allowing suit to be brought at common law when death results from the negligence of the employer and is preceded by conscious suffering. Providing for payments for injured workmen during the pendency of a bill. Providing for compensation for injuries to workmen employed by the Boston rapid transit commission. Fixing responsibility for the payment of workmen's compensation by the commonwealth and municipalities. Allowing depositions to be taken outside the state. To secure prompt payment of benefits when a foreign insurance company withdraws from this state. Allowing the Employers' Insurance association to write other liability insurance. Regulating the creation of new companies to do business under the insurance acts.

"BREAKING CONTRACTS CAN'T CRUSH UNIONS."

New York.—"You can't destroy unions by breaking agreements. We favor contracts, but we do not depend on them to live," declared President Gompers last week to an audience composed of thousands of members of the International Ladies' Garment Workers' union. It was one of the greatest labor demonstrations this city ever witnessed, and Madison Square Garden was crowded with unionists who listened to vigorous addresses by President Gompers and others on the termination of the protocol by garment manufacturers and the arrest of several officers of the union, which was denounced as "a deliberate assault on our union in particular and on the labor movement in general—an assault engineered by some of our most oppressive and unscrupulous employers in league with a band of professional strikebreakers and a gang of notorious and self-confessed criminals."

President Gompers notified manufacturers that the union's activity would not be lessened because they broke an agreement. He said the trade union movement desires these agreements, but it does not depend upon them for existence, and that it will live and prosper in spite of broken promises by employers.

"I don't know the reason behind the breaking of the protocol," said President Gompers. "Is it that the manufacturers believed the union could be crushed? Did they join in the movement to take the lives and liberties of the cloak makers' union? If it be their purpose to help take the lives and liberties of the men we believe to be innocent, they will be defeated. The killing of the men at Ludlow brings a suspicion that that is what they want to do here.

"In the fight for freedom we are going to stand shoulder to shoulder, not for war, but for peace. Any assault on our ranks or on the meanest among us, will find our ranks ready to fight to maintain the lives of the toilers of our country."

Strong resolutions were adopted in protesting against the action of employers, and these workers professed their trade union faith in the following language:

"We realize more than ever that our only protection against all assaults on the part of our employers and our other enemies lies in our organization; that our union alone will shield us from the inhuman exploitation, maltreatment and persecution to which we had been subjected before the general strike in 1910, and we pledge ourselves with renewed determination and enthusiasm to stand loyally and unflinchingly and by our faithful officers through all the struggles that may come."

INJUNCTION REFUSED, UNION VIEWS UPHOLD.

Stockton, Cal.—This city secured much publicity last year because of an attempt by the Merchants' and Manufacturers' Association to disrupt the trade union movement, and now it is again in the limelight because of the refusal of the superior court of this county to issue an anti-boycott injunction against the Building Trades Council and the Material Teamsters' Union.

In view of last year's events and the antagonistic union sentiment developed at that time, the decision is a remarkable one, and again proves the value of agitation and education by workers in the securing of rights to patronize whom they will.

While the court believes it has the right to issue injunctions even in cases covered by state and city police laws, it makes the interesting ruling that there is no such thing as a "secondary boycott," a theory elaborately defended and explained by ex-President Taft and nonunion associations. The court insists that "the legality of the secondary boycott is vigorously denied by the English courts, the Federal courts and the courts of many of the states of this Union."

The California State Supreme Court is cited in defense of this opinion, and that court is quoted as follows:

"The court recognizes no substantial distinction between the so-called primary and secondary boycott."

The superior court intimates that intimidation is a matter for injunction relief, despite the presence of sufficient police stat-

utes and trial by jury guarantees. The court, however, makes several significant statements that accord with the federal Clayton law. The most prominent is the declaration that mere numbers constitute no wrong and that whatever one man can do alone, he may do in combination with others, "because," says Judge Norton, "it has been definitely settled as a matter of law that the acts which an individual may lawfully do, an organization of individuals may lawfully do."

The decision indicates the changed sentiments on this question, and shows that in the very near future organized workers will no longer be attacked for exercising rights that are accorded others without question—the right to withhold their patronage, singly or in concert, from those who oppose them.

WOMEN UNIONISTS ADJOURN.

New York.—Few changes were made in the executive staff by the biennial convention of the National Women's Trade Union League, which adjourned last week. The next convention will be held in Kansas City, in 1917.

Among the resolutions adopted were the following:

Approving the fearless course of Frank Walsh, chairman of the commission on industrial relations; condemning the arrest and conviction of John Lawson, Colorado miner, and condemning the arrest of members of the International Ladies' Garment Workers' Union. Indorsing the minimum wage for women, the eight-hour day and the abolition of night work. Favoring the extension of public works for the provision of unemployed women; a national system of unemployment insurance, and the establishment of national, state and municipal employment agencies.

For the purpose of extending the knowledge of trade union principles, the convention made three suggestions: Hold frequent shop meetings in union and league headquarters; distribute pamphlets that show the advantages of trades unionism; hold street meetings wherever possible.

The convention indorsed equal suffrage and called on "our brother workers in the states of New York, Pennsylvania, New Jersey and Massachusetts" to support pending equal suffrage proposals.

LAWSON CASE IS DISCUSSED.

San Francisco.—The Evening Bulletin makes this comment on the Lawson verdict:

"Granby Hillyer, judge of the specially-created court which tried Lawson, went to the bench directly from the employ of Lawson's bitter enemies, the coal companies. As a coal company attorney he had helped to manufacture cases against some of the indicted miners. The jury which he allowed to serve in the Lawson case consisted of 'coal company retainers hand-picked by a coal company sheriff.'

"No one said that Lawson killed anybody. He was charged with murder because he was head of the miners' union and because, in a clash between the miners and the mine guards, a guard named John Nimmo had been killed by a bullet from some miner's rifle. If the miners, instead of the mine owners, had been in control of the legal machinery of Las Animas county, the heads of the coal companies, or even the Rockefellers, might have been indicted and the case would have been no more absurd.

"Eleven members of the Lawson jury wanted him hanged. He was let off with life imprisonment because one jurymen gagged at the death penalty.

"Unless the higher courts intervene, Lawson and those of his companions, who are most unpopular with the coal companies will spend the rest of their lives in prison. The influence of this raw capitalistic anarchy in sweetening the relations of capital and labor the country over may be left to the imagination."

WIN INJUNCTION SUIT—STRIKERS MAY PICKET.

Washington.—Justice McCoy of the Supreme Court of the District of Columbia has refused to issue an injunction against striking brewery workers from picketing.

The court ruled that "the proof preponderates in favor of the finding that the picketing is entirely peaceful."

The court said it has been repeatedly held that unionists may peacefully advise the public not to purchase nonunion products. This, together with an absence of threats by the brewery workers, led the justice to this conclusion:

"The defendants, then, having the right to curtail the sale of nonunion beer or to increase the sale of union beer by giving information to others, there is nothing in the present case which warrants them from doing so."

Attorney Ralston called attention to the Clayton law, and summarized the position of the workers as follows:

"These workers have said to the community at large: 'If you will aid us, by discontinuing the purchase and consumption of that beer, we will the sooner be able to gain the benefits which we expect to arise from our organization.' That is what they have said. And what is the essential difference, whether they say that to the employer against whom this strike takes place, or whether they solicit men on the street to do that very same thing? Essentially I say there is no difference between them. They are acts which they have a right to do individually and collectively and they are done for ends which are justifiable, which are legal."

The strike started April 2. It involves brewery workers, engineers, firemen and machinists. The workers asked that former contracts be renewed, with the added provision that work shall be equalized in times of business depression. Last November the

companies discharged fifty-one active trade unionists, and the proviso was intended to check this unfairness. Later the companies demanded that chief engineers withdraw from the Steam Engineers' Union. The strikers have presented their cause to the public in a vigorous manner and are confident of final victory. The failure of the companies to secure an injunction is but one of a long series of attempts to destroy the unions of brewery workers and their allies.

WOMEN IN IRON INDUSTRIES.

New York.—The Sun makes editorial comment on the statement of J. G. Butler, Jr., president of the Bessemer Pig Iron Association, that "it would not be surprising to find thousands of women in mills, blast furnaces, and doing the work of men before the war is over."

The Sun is not startled at the suggestion, for with babelike innocence it asks this question:

"Yet is the work which they might be called on to do in the mills, mines and blast furnaces really harder than the back-breaking occupation of floor scrubbing, which is cheerfully committed to them, or more trying than the farm labor that thousands of women perform year in and year out?"

Despite this cleverly worded defense of women in mines and steel infernos, the editor is awake to the power of labor unions in resisting the proposal, for he warns advocates of the plan.

"These statutes (regulating women workers) could not be ignored in their entirety, and their repeal would necessitate a campaign highly expensive and requiring for its successful issue, assuming the existence of economic conditions that made such repeal possible, a period of time that might easily exceed the span of the shortage of male workers which Mr. Butler believes is to ensue."

These conditions, which the editor believes are insurmountable, forces him to this conclusion:

"A feminine excursion into the mines and blast furnaces is as improbable as it would be undesirable."

The value of Mr. Butler's statement, which the Sun is undoubtedly conscious of, is to weaken further agitation for immigration restriction. "Women in mines" will be the bugaboo to offset the workers' plea to the next Congress that their living standard and education be tests for American citizenship.

ROCKFELLER MILLIONS TAINT PUBLIC PRESS.

New York.—President Gompers told delegates to the National Women's Trade Union league how the Rockefeller foundation and similar organizations possessing untold millions are poisoning the well of intelligence and often give workers the wrong viewpoint on subjects that are vital to labor. The speaker illustrated his point by referring to

the controversy between the Rockefellers and Chairman Walsh, of the commission on industrial relations. He declared he attended every session of the commission when John D. Rockefeller, Jr., was on the stand, and that the stories given out later by Rockefeller and the public press that supports him, were neither fair or honest to Chairman Walsh, who was described as doing a great work for the cause of labor.

"Frank Walsh has no business to give to the newspapers," said the unionist. "He has no secret fund upon which to draw to pay for advertisements; he has no \$200,000,000 foundation with which to corrupt the minds of the people of the country. Our own people have sometimes been misled by reason of the mis-information spread broadcast by the millions of the Rockefeller foundation, and some workers have even criticised the splendid work of Mr. Walsh; some of our own are led to side against us by reason of this false and misleading information. I have personally heard many good men criticise the splendid work of Mr. Walsh in the interest of the workers because they have been misinformed as to the facts," said President Gompers.

The speaker referred to the Clayton law as the Declaration of Industrial Independence, and said this act would undoubtedly be attacked "by the forces that are poisoning the wells of intelligence by conveying misinformation to the people through the medium of the press."

President Gompers urged the delegates to make trade unionism their life's paramount issue, and not permit themselves to let other issues overshadow the one great question of organization, that workers may regulate their lives, may have a voice in regulating wages, hours and conditions. This, the speaker insisted, was of prime importance, all other questions being secondary.

TO ANNUL TREATIES HIT BY SEAMEN'S LAW.

Washington.—The higher labor standards demanded by the LaFollette seamen's bill, passed by the last Congress, will make it impossible for the renewal of several treaties, and this government has instructed its diplomatists abroad to ask for the annulment of those paragraphs in commercial treaties which conflict with the new act.

As the section of the law that applies to foreign vessels does not take effect until March, 1916, there is sufficient time for diplomatic negotiations. While the bill was pending in Congress, Germany, Great Britain, Italy, France, Belgium and other nations made representations to this government that the bill's provisions raising the standards of labor and affecting the equipment of ships which visit American waters conflicted with their rights under treaties. Unionists pointed to these statements as proof that the law would raise the standard of seamen throughout the world, and that the various countries would have to revise their treaties if the law was passed.

ILLNESS A TAX ON WORKERS.

Washington.—The necessity for higher wages and for immediate legislation that will prevent occupational diseases is shown in a report to the federal commission on industrial relations which was prepared jointly by representatives of the commission and the federal public health service.

The report states that the average wage earner in the United States loses approximately nine days every year on account of sickness, much of which is preventable. Illness has been found to be one of the principal causes of unemployment, and a principal factor in recruiting the army of destitute and dependent persons.

Ill health, it is stated, levies an annual toll of \$750,000,000 upon wage workers because of lost wages and expense of sickness.

The greater part of this gigantic tax falls upon those workers who are least able to afford it, since sickness has been found to be much more prevalent among low-paid workers than among those whose incomes are sufficient to provide sanitary housing, adequate food and pleasant surroundings in the home and in the place of work.

The estimate of an annual loss of \$750,000,000 is conservative, it is declared. It is based on a careful examination of the sick records of nearly 1,000,000 workers in this country, and is found to correspond very closely to the figures afforded by the sick records of a long period of years of about 26,000,000 workers in Germany and Great Britain. It includes merely the loss of wages during illness and the expenses of medical attention and does not take into consideration the impairment of the worker's efficiency and vigor or the cost of illness of members of his family.

PENSION STATE EMPLOYEES.

Harrisburg, Pa. — Governor Brumbaugh has signed the bill establishing a retirement system for attaches of departments of the state government. It is to become effective September 1 and will affect all except those whose retirement is provided for. Any employe who shall have served twenty-five years or more or who shall have reached the age of 70 years and served continuously for twenty years as an attache of the state government is to be eligible to retirement on half pay. The governor is to be the authority to determine retirements and attaches must hold themselves in readiness to respond to call for their services. Attaches must make application for retirement, and no additional compensation shall be allowed to those retired for the performance of any duties they may be asked to do.

OPPOSE DANGEROUS LAW.

Phoenix, Ariz.—Trade unionists and the railroad brotherhoods are receiving assistance from citizens in all walks of life in the fight to repeal, by referendum, the law enacted by the last legislature which

provides that all costs in trial cases, including jury costs, shall be first deposited with the clerk of the court.

In opposing the bill, Judge Shamhart says:

"Why not require those who seek legislation from the legislature to pay for it? It is but a co-ordinate branch of the government. Or the governor, for executing the laws?"

"We have even abolished the fee system in the state to secure absolute impartiality of the officers. Why then apply it to jurors?"

GOOD COMPENSATION ACT.

Halifax, Nova Scotia.—John Joy, vice-president of the Canadian Trades and Labor Congress, declares the Nova Scotia compensation act, passed last month, is the best legislation of its kind in the Dominion. He says:

"The act provides for the injured workman during his disability, even if it lasts his lifetime. Under this law, litigation is pushed to one side and the question as to the right of compensation and the amount payable are determined by a board of three members. Compensation is payable in periodical sums, thus providing for continual maintenance of the injured workman or his dependents.

"The act further provides that no agreement between employer and the workman to forego the benefits of the act is valid; no part of the amount payable to the accident fund by the members is to be charged up to the workman, and no compensation can be attached, charged or assigned without the approval of the board."

All workers are included in the new law except casual workers, members of police and fire departments and those engaged in clerical and office work.

ROCKEFELLER AIDE PROTESTS.

Kansas City, Mo.—"Mr. King's charge that I distorted his testimony before the commission on industrial relations would appear to simmer down to a question whether he was boasting or confessing," said Frank Walsh, chairman of the commission, in answer to W. L. Mackenzie King's protest that the following statement made by him in Washington was given a sinister meaning:

Mr. King—"If you are speaking of the immediate force and immediate influence, I think that the conscience of young Mr. John D. Rockefeller, Jr., is more powerful on that and will effect social justice in Colorado quicker than any other single force that you would bring to bear."

The above statement has been given wide publicity, and the Rockefeller aide now realizes he lacked caution in a desire to impress upon the commission Mr. Rockefeller's power. To weaken the attack of labor papers and other publications, Mr. King now declares that wrong interpretations are placed on his statements.

LAUDS A. F. OF L. EXHIBIT.

San Francisco.—The A. F. of L. has one of the most attractive exhibits at the Panama-Pacific exposition, writes Frederick W. Ely, in the Evening Bulletin. He says:

"Taken as a whole, the exhibit is one of which the organized workers may justly feel proud. It is attracting the attention of thousands of visitors daily, many of whom are evidently seeking to know more about the principles, the aims and objects of the trade union movement. Many of these visitors are, apparently, from the leisure class. They ask all sorts of questions concerning the labor movement and frequently express sympathy and friendship for the workers and their cause. They go away armed with labor literature.

"The exhibit should, and doubtless will, arouse much interest in the doings of organized labor.

"Through its exhibit at the exposition the American Federation of Labor is doing a work that will surely be productive of results that will be helpful to the workers in their struggle for justice and liberty."

WORKERS ADVANCE STEADILY.

Racine Wis.—In a speech on "Labor Legislation," before a large crowd of unionists in this city, Congressman Cooper said:

"Sentiment in regard to the workingman has changed entirely, as is evidenced particularly by this clause in the Clayton law: 'The labor power of a human being is not a commodity or article of commerce.' This sentiment will go 'round the world, the same as Thomas Jefferson's declaration that 'all men are created equal and endowed with certain inalienable rights.' This declaration now adorns the walls of many school rooms in Europe, and has even spread to Japan."

The speaker compared present conditions with those of but a few years ago, when men were imprisoned for striking. At that time they could obtain no lien on the property they were working on, and in Massachusetts there is a case on record of a man being imprisoned for a debt of \$4, declared the Congressman.

WALKING LENGTHENS LIFE.

Washington.—The United States public health service has issued a warning that failure to walk shortens life. The medics make this plea for more pedestrians:

"The death rate after the age of 40 is increasing, in spite of more sanitary modes of living. The expectation of life after 40 is less than it was thirty years ago. This is due largely to increased prevalence of the diseases of degeneration.

"Take daily exercise. Have a hobby that gets you out of doors. Walk for the sake of walking. Join a walking club and keep your weekly score of miles. Gymnasium work is good for those who like it and can afford it, but avoid heavy athletics. You may not burn the family carriage, as Benjamin Franklin suggested, but at least, as he advised, walk, walk, walk."

UNIONS SHOULD BE CAUTIOUS.

San Francisco.—“The unions should guard against hasty and irrational moves,” warns the editor of “Organized Labor” in a first page plea to the trade union movement of this city to be cautious, in view of statements from anti-union centers that a fight will be started against San Francisco when the exposition closes.

The editor continues:

“The real danger of the union labor movement of San Francisco and California is the agent provocateur—that is, the hired detectives and sleuths which the manufacturers send into the organization for the sole purpose of promoting and starting trouble.

“There is hardly a union in California, or in any great industrial center of the country, which has not its quota of these dangerous pests, who either insanely or hypocritically mask under the cloak of unionism.

“When they get on their feet and start to ‘orate and propose,’ the union had better investigate.”

WORKERS' PENSION NEEDED.

Washington.—Pensions for government employes is a matter that must be given serious consideration by Congress, says John Skelton Williams, controller of the currency, in an interview published in a local newspaper, which also publishes letters on this subject from civil service employes. One writer says:

“The situation in the government service, from the standpoint of watchman, skilled laborer, fireman and laborer, is one grade above pauperism. These employes receive a monthly wage of \$50 and \$60. Rent takes nearly half, as it costs not less than \$20 to \$25 per month for quarters in the city. Rent in the suburbs is cheaper, but car fare makes up the difference. The cost of table maintenance for a small family in Washington cannot be less than \$1 a day. This means at least \$30, or possibly \$25. Clothing, doctor's bills, medicine, life insurance and a number of other items are to be paid out of the difference.”

PORTO RICAN PROTEST HEARD.

Washington.—President Gompers and Secretary Morrison accompanied Santiago Iglesias and P. R. Martiniz, A. F. of L. representatives at Porto Rico, to the White House last week and presented labor's protest of Porto Rican conditions to President Wilson, through Secretary Tumulty, who promised to bring the matter together with all documents to the attention of the president. The unionists declared conditions in the island are intolerable and that constitutional rights are denied workers when they attempt to better conditions. President Gompers' recent visit to Porto Rico qualified him to speak with a knowledge of affairs, which were discussed at length in the two-hour conference. Secretary Tumulty gave assurances that the protest would be given earnest attention and inquiry.

PRIVATE DETECTIVES SCORED.

Philadelphia.—In dismissing the suit of a private detective, Judge MacNelle, in municipal court, scored the practice of private detectives in seeking to prove charges of wrongdoing against innocent persons.

“This detective,” said the court, “appears to have advised this business house that he was in possession of evidence to prove an employe a thief, whereupon a contract was entered into, using the words, ‘will pay \$300 if employe is proved to be a thief.’

“It appears that, contrary to what the detective said, he did not have the evidence. He then set about to prove the man a thief. This would give rise to all sorts of dangerous consequences, not only to unfortunate employes, but to employers as well, who might easily become involved as a result of the detective's work. This is a practice that is going on entirely too much, and must be broken up.”

WANT WAGE LAW ENFORCED.

Detroit.—In the suit started by the Detroit federation of labor to compel municipal officials to obey the minimum wage law approved at the last city charter election, trade unionists are afforded an opportunity to compare the workings of wage-by-law with methods employed by their labor organizations.

By the largest majority ever given a city charter amendment the people approved a minimum wage and an eight-hour day for municipal laborers. City officials have refused to obey the mandate and the city attorney presents the strange spectacle of defending this violation in a suit started by the unionists, who have secured counsel and are now raising funds to compel the authorities to obey the law.

COMPENSATION NOT LIMITED.

Hartford, Conn.—The supreme court of this state has ruled that the jurisdiction of the Connecticut workmen's compensation act is not limited to Connecticut, even when the contract between employer and employe is entered into within the state.

The ruling was in the case of the wives of two employes of the Thames Towboat company who lost their lives when a tug foundered off the New Jersey coast. The company appealed from the compensation commission's awards, claiming that as the accident happened outside the state the compensation act has no jurisdiction. The supreme court ruled that under the conditions the law is effective.

FAVORS U. S.-OWNED RAILROADS.

New York.—Government ownership of railroads is the only solution of our industrial problems, according to Amos Pinchot, who declared against private ownership and federal regulation in a speech in this city.

The speaker said that railroad rebating “was just getting its second wind,” and that private railroading hampered industry.

ROCKEFELLER IS GENEROUS.

New York.—Colorado miners who have been victimized by company checkweighmen will be interested in the announcement that the general education board, a Rockefeller institution, has appropriated \$596,650 for educational purposes. The board states that several new lines of educational activity have been inaugurated. It has resolved to enter the field of education investigation, research and experiment, by assisting research workers connected with institutions of learning, as well as by suppling independent investigators and experiments.

AMEND COMPENSATION LAW.

Hartford, Conn.—The recent state legislature amended the workmen's compensation law by reducing the waiting period from 14 to 10 days and providing that hereafter an injured employe will receive medical attention during the entire time of his disability, instead of for 30 days, as formerly. For partial incapacity the injured employe shall receive one-half of his weekly wages, but in no case shall it be less than \$5 weekly.

PENSIONS FOR LABORERS.

Boston.—Governor Walsh has signed the bill which provides for pensions for laborers employed by Massachusetts municipalities. The act is optional with cities and towns, and applies to those workers who have reached the age of 60 years and who have been in service not less than 25 years. The act shall be voted on by the cities and towns at the next state election. Boston may retire laborers on pension who have suffered permanent injury and who have been employed not less than fifteen years.

REGULATE PRIVATE AGENCIES.

Harrisburg, Pa.—The bill to regulate employment agencies through the department of labor and industry has been signed by Governor Brumbaugh. Methods of licensing these agencies are also provided for.

TO CHECK STRIKEBREAKERS.

Boston.—The state legislature passed a law empowering the state board of conciliation and arbitration to investigate cases of alleged illegal employment by strikebreakers.

ADOPT "STATE USE" SYSTEM.

Harrisburg, Pa.—One of the reform prison measures passed by the last legislature, and just signed by the governor, introduces the so-called "state use" system in this state. This means that prisoners shall be given an opportunity to manufacture goods for use in state institutions. It is believed this will eventually result in the abolishment of convict labor in competition with free labor.

VIOLATE CONTRACT LABOR ACT.

Wilmington, Del.—Special agents of the federal department of labor have arrested four draughtsmen, following months of investigation of charges that alien workmen were employed in this city. The arrests were made under the alien contract labor law of the United States, violation of which, in event of conviction, is punishable by a fine of \$1,000 on the corporation employing such workmen and the deportation of the workers.

TO INVESTIGATE OFFICIAL.

Vancouver, British Columbia.—Agitation by trade unionists against the retention in office of Thomas Graham, inspector of mines, has been partially successful. This official is charged with concealing information from a jury that investigated the death of nineteen miners who were drowned several months ago. The government has appointed a commission to investigate the charges.

VACATION FOR "LABORERS."

Oklahoma City, Okla.—"Common laborers" employed by the city will hereafter enjoy a fifteen days' vacation with pay. This rule now applies to every department in the city. The question of cost was discussed by the commissioners, but it was finally agreed that a \$2 man is as much entitled to a vacation as anyone else. The resolution was unanimously adopted.

LABOR TEMPLE FOR DALLAS.

Dallas, Tex.—The Labor Temple association has awarded the contract for a home for Dallas unionists. The structure will be a modern three-story, fireproof building. It is hoped to dedicate the building next Labor day, when Governor Ferguson has promised to be present.

Among Our Exchanges.

SMOKER AND CONCERT.

A very successful smoker and concert took place on Monday evening, the 26th inst., in the L. O. L. Hall, under the auspices of the Boiler Makers' Union, for the benefit of a sick member.

The Citizens' Band as usual were to the fore for this good cause. Headed by their genial manager, Mr. C. E. Winters, they marched through the principal streets of

the town, finally coming to a halt at the Hall, where an exceptionally choice programme was in order. Usually at functions of this kind, special mention is made of some particular artist or artists, but on this occasion it was impossible to choose a star, every number being of a very high degree of perfection.

Great credit is due the committee, Messrs. T. Arlein, E. Taylor, E. Cook, J. Cummings,

J. Empey, F. Crowther and J. Nichol for the very able manner in which they arranged and carried out the proceedings. These gentlemen worked most diligently, and it is a pleasure to feel that their labors bore fruit. Something like \$80.00 was realized and handed over to their sick brother as a result of this affair.

The committee desires to express their united thanks to the numerous artists who took part gratuitously; also Mr. J. W. Scott of the Scott Music Store, Main West, for the free use of a splendid piano; as well as Mr. Walker, the pianist, who performed his duties in his usual efficient manner. The programme consisted of selections by the band, instrumental solos, sentimental and comic songs by some of the leading talent in town.

Light refreshments were served during the evening. About eleven o'clock the gathering dispersed, after the singing of the National Anthem. Everyone present on this occasion thoroughly enjoyed themselves, and would gladly welcome a repetition of the programme in the very near future.—The North Bay Booster.

NEW COPPER ALLOY DISCOVERED HERE LEADS TO A BIG INDUSTRY.

A new metal known as Ampco bronze, which is said to possess the strength of steel and can be die-cast in steel molds to a finished state, is being placed on the market by a concern of which Peter Weber, former city chemist, is head. The bronze stands acid tests and can be annealed or softened as other metals. It is 18 per cent lighter than brass. Those who have tested the metal predict that it will be widely used in machine construction and its manufacture may develop into an important Milwaukee industry.

The metal was invented by A. Littman, who worked in a small machine shop on Fond du Lac-av. He began experimenting in 1907. It is 80 per cent copper.—Milwaukee Journal.

WE MUST PROTECT OURSELVES.

The present war in Europe has brought to the front two sets of truly amusing people—each accusing the other of being unpatriotic—the ultra-pacifist and the ultra-militarist.

One would divest the nation of every vestige of military defense in the ridiculous fear that if maintained it would lead to the "man on horseback" and overthrow our democratic institutions; the other would burden the nation with means of warfare and fill the coffers of the armor and ammunition manufacturers with the people's hard earned money.

On the one hand we are warned, and the warning may be well worth taking, to learn a lesson from Belgium and Luxembourg and China. Belgium well armed but small comparison with Germany, defeated but not subservient, holds the respect of the world. Luxembourg, undefended, depended upon

mere treaties of peace to uphold their rights, is now overridden and is an unknown country as far as the consciences of the neutral nations are concerned. China with her 400,000,000 of uneducated and barbarous people has fallen into the hands practically of 40,000,000 Japs through being defenseless and having nothing with which to withstand an armed invasion.

Little Switzerland on the other hand, is prepared, not to invade or violate other countries, but to withstand the invasion of any other power. Switzerland, in the very midst of the war zone, is respected by all nations. Her rights are secure all because she is prepared to protect herself. She has a military system that is almost ideal. It was the Switzerland system that received the endorsement of President Wilson, who recommended to congress that a similar system be worked out in the United States. General Wood recommended the system but hesitated because of the compulsory feature. Victor Berger, in congress, recommended the system unqualifiedly and last but not least Theodore Roosevelt has sanctioned it as being adequate.

Resolutions against war undoubtedly serve their purpose but they are poor material to defend yourself with. The working class who fight the battles of the nation do not want war and no other thinking person in a community will sanction war except as a last resort. Peace has its virtues, but "peace at any price" is too costly. War brings untold profits to a certain breed of "financiers" but so does peace, both at the expense of the working class.

It is well enough to preach and clamour against hideous warfare, but to allow such preaching to blind ourselves to the facts and conditions of present day society is absolute folly.

We all hope and strive for an ideal, but when the heart is allowed to rule the head, disaster usually results. Wars under the present system of society are inevitable and while we should not resign ourselves to fate we should nevertheless be prepared to meet life as it is and not as we would like it to be.—The Labor World, Duluth, Minn.

THE VOICE THAT REACHES.

Cesar boasted a voice whose command to halt or advance was heard by 10,000 soldiers.

But the most far-reaching and commanding voice that can move mankind, is that of a character awakened and developed by a strong sense of responsibility.

A hundred years ago, Henry Clay learned to write by filling a box with sand and tracing letters with a pointed stick.

Young Daniel Webster plucked his pen out of the wing of his mother's pet goose, and made ink out of the soot scraped from the fireplace.

Fired with an overmastering sense of responsibility, these monarchs of mankind, though pinched and pressed by poverty, de-

veloped voices that have moved millions, and will continue to reach and command as long as human intelligence exists.

A Labor Union composed of members fired with such a sense of responsibility would not suffer much from suspicions or dissensions.—The Citizen.

POWER OF ORGANIZED LABOR.

Frequently wild and unreasonable individuals, both on the inside and the outside of the trade union movement, as represented by the American Federation of Labor, make the assertion that labor thus organized is impotent and the system should be changed to meet their ideas. Such opinions, of course, are not held by the intelligent and thinking portion of the American people, but as an indication of what the enemies of organized labor think of the situation with which they are confronted as a result of the manner in which labor is organized, we call attention to an address delivered by Ex-President Taft at the annual dinner of the National Association of Manufacturers in New York City last week. "I fully approve," said the former president, "of the principle of labor unions. But the power their leaders have acquired by the principle of combination in their organization has intoxicated them, and they have exercised a tyranny over society and over their own members that is certainly leading to a reaction and to a restraint of their great powers within proper and lawful limits."

We are not contending that Mr. Taft is competent to pass judgment upon organized labor. We know he is wholly unfit for such a task, because he was born with a silver spoon in his mouth and never did a day's labor in his entire career, and as a consequence knows absolutely nothing about the problems of the men and women of toil.

He is eminently qualified to express opinions concerning the other side of the question, however, and it is this fact that makes the ideas above quoted of particular value as indicating the strength and power of the American Federation of Labor and its subsidiary branches.

No one who possesses intelligence enough to analyze the achievements of the American labor movement during the past half century of its existence doubts for an instant its tremendous influence upon the social welfare of the people, but because of the fact that there are some few persons who may be deceived by the ridiculous statements made by wild-eyed rainbow chasers, it can be but healthful to occasionally see ourselves as others see us.

Mr. Taft knows, as did the manufacturers to whom he was speaking, that there is no agency in the world today so capable of curbing the greed of entrenched capital than the splendid organization of the workers built up under the banner of the American Federation of Labor. They know the labor movement not only has such power, but that it has made judicious use of it, and that because of the manner in which the

worker is wielding his newly-acquired power the door of hope is swinging open and that he will doubtless continue to drag from the hands of the oppressor a constantly-increasing portion of the good things of life, and it is this fear that spreads consternation throughout the ranks of those who have heretofore been accustomed to reap abundant harvests without the necessity of sowing or cultivating.

The labor movement, during its entire existence, has been attacked on the one side by the greedy employer and on the other by the ignorant toiler, but in spite of all opposition it has gone on from one achievement to another, daily lifting some of the burdens off the backs of the toilers and making life a little more worth while for the hewers of wood and drawers of water.

If the ignorant and whining incompetents within the ranks of the workers would put their shoulders to the wheel and become lifters rather than leaners on the overloaded backs of their fellows progress would be much more rapid and the Tafts and their kind would the sooner be compelled to dismount and carry the weight of their own existence instead of being carried through life on the backs of the toilers.

So long have these people been accustomed to the better of the bargain that they now feel that an actual injustice is being done because organized labor is taking away from them some of their highly advantageous special privileges.

Mr. Taft's complaint against the American Federation of Labor is a tribute to its effectiveness as an instrument for advancing the interests of the workers, and some of the pessimists within labor's range are advised to sit up and take notice.—The Labor Clarion, San Francisco, Cal.

INDUSTRIAL AND OTHER UNRESTS.

Frank Walsh, chairman of the federal Commission on Industrial Relations, is an investigator who uses unique, or at least unusual methods. Very likely he has made some mistakes, but he has been steadily digging for facts, and with success.

Hitherto, federal inquiries into industrial unrest have been conducted by judicially-minded people who filed noncommittal reports which were read only by the committee clerks who wrote them and the proof-readers who read proof on them, and which reposed in a quiet nook until they were hauled out and sold for waste paper.

Mr. Walsh's inquiry has been of a different character. While expert investigation, quietly carried on, was given its proper place, the chairman conducted public hearings which in one month gave the public more information as to the causes of industrial unrest than all the previous state or federal hearings put together.

Men who dominate the industrial and financial affairs of the country were put on the stand and quizzed as they had never been quizzed since the days when they were

schoolboys and robbed apple orchards. The commission's agents dug up private records and letter files and men like the Rockefellers heard the bones of their business skeletons rattle, not in the closet, but in the ears of the American people.

The result is that industrial unrest is not the only sort of unrest which we observe. The Rockefellers are noticeably restless and are showing it by protesting and forcing their henchmen to protest against the commission's work. The latest complaint is against Mr. Walsh's audacity in telling the nation how the Rockefellers managed the affairs of Colorado and how the governor of the state let them do it.

The character of the opposition which Mr. Walsh is constantly meeting is one thing in his favor. It indicates that his offense has been his success in putting facts before the people instead of into so safe and inaccessible a repository as a government report. The unrest of Big Business, due to Mr. Walsh's activities, may be very annoying to it, but the situation produces conditions and facts which are giving the people information which they want and which they ought to have.—The Milwaukee Journal.

THE CHAIRMAN OF THE INDUSTRIAL COMMISSION.

Chairman Frank P. Walsh of the United States Commission on Industrial Relations, and John D. Rockefeller, Jr., have recently indulged in a rather spicy controversy concerning Rockefeller's action, knowledge and liability in the Colorado coal miners' strike. A certain portion of the public daily press has given Mr. Rockefeller a shade in the decision. Chairman Walsh has been fearless and outspoken in his defense of labor ever since the commission was created. He is a lawyer and has no connection whatsoever with the organized labor movement. He deserves credit for the manly stand generally speaking, he has taken. The fact that Rockefeller and a hostile press have tried to discredit him should be some assistance to organized working men and women in forming conclusion as to the merits of the controversy, especially as they concern Mr. Walsh. Few men in public life, holding responsible official positions, and who are not connected with the labor movement, have been more outspoken and emphatic in the pleasant things they have said concerning labor than has Mr. Walsh.—Cigarmakers' Official Journal.

THE REAWAKENING OF PENNSYLVANIA.

Workmen's Compensation, accomplished through the seven bills put through both the House and Senate at Harrisburg and assured of signing by Gov. Brumbaugh, means more than the long withheld justice for the workers of this state.

It means the reawakening of Pennsylvania industrially.

Pennsylvania, the nation's greatest industrial state, has seen 24 of her sister states

pass such laws for the protection of workers and their families, while she did nothing.

Pennsylvania for four years has had workmen's compensation before its lawmakers, and all this time until now the great corporations, aided by their political allies, have been able through one form of a delay after another to prevent success.

The lion's share of credit for success now belongs to Gov. Brumbaugh.

People who had dealings with the state Senate at Harrisburg know what it is to get a deserving measure past that body, let alone by the 48 to 0 vote by which the governor's compensation bills were passed Wednesday in the Senate.

With the other labor measures successful in the present legislature—the most progressive legislature in years—the child labor, miners' and other bills, a record in the interest of labor has been made of which Dr. Brumbaugh, his cabinet and the two branches of the lawmaking body at the state capital may well feel proud.

At last, corporation grip on Pennsylvania appears to have been broken.

Let's give three cheers.—The Iron City Trades Journal.

JUDGE LINDSEY'S TRIUMPH.

The complete vindication of Judge Lindsey ought not to pass without record, for it is not alone a vindication of Judge Lindsey, but a victory for decency and the public rights.

Judge Lindsey's real offense has been attacking corruption. Because he spoke out those whom he reached tried again and again to defeat him at the polls, but Denver persisted in believing in him and re-electing him as judge of its juvenile court. Then to his boldness Judge Lindsey added sympathy with the striking miners. The result was a dastardly attempt to ruin his character. Persons were procured to testify to crimes unmentionable. Not content with that, his enemies attacked the character of his wife. And while the grand jury was investigating, his enemies had introduced in the legislature—and to the shame of the legislature passed—measures abolishing Judge Lindsey's court.

The answer has come in no uncertain terms. The grand jury not only completely exonerated Judge Lindsey, but added: "We are, therefore, of the opinion that the attacks made upon Judge Lindsey are unjust and unfair and deserve the severest censure and condemnation." And Governor Carlson, whose own record for independence and courage is none too clear, vetoed the measures abolishing Judge Lindsey's court, adding these words:

"Ever since the juvenile court was created, Judge Ben B. Lindsey has been the judge presiding over it. He has been elected and re-elected several times by the people of Denver. If the people of Denver want him to be the judge of the court they should

have him; if they do not want him they should elect some other person to office."

The vindication of Judge Lindsey is a vindication of Colorado, which already has too great a cloud resting on its justice to have added this other crime of "getting" a just judge.—Milwaukee Journal.

FREIGHT CAR ROAMS.

Grand Trunk freight car No. 30017 has just returned to Canada after a unique itinerary, which began at Chicago last December. From the Grand Trunk it went to the Wash; to the Chicago, Burlington & Quincy; to Wiggins Ferry; to the Mobile & Ohio; to the Atlantic Coast Line; to the Florida East Coast; a ferry to Havana, where it was photographed as a curiosity; returned to the Florida East Coast; to the Atlantic Coast Line; to the Norfolk & Western; to Wiggins Ferry; to the Terminal Railroad Association, St. Louis; to the Chicago & Eastern Illinois; to the Toledo, St. Louis & Western; to New York, Chicago, St. Louis; to Lehigh Valley; to New York, New Haven & Hartford; to Lehigh Valley, and to the Grand Trunk at Niagara Falls.—Railway Age Gazette.

CANADIAN GOVERNMENT TO OPEN ROAD.

The Canadian Government announces that in consequence of the declination of the Grand Trunk Pacific Railway to take a lease of the new government railroad, the government itself will at once proceed to put the line in operation from Moncton, N. B., to Winnipeg, Man. At the same time the government will take over and operate the Lake Superior division of the Grand Trunk Pacific, which is the branch of the National extending to Fort William. The officers of the government railway system, now operating the Intercolonial, will take charge of the operation on the new line. Between Winnipeg and Fort William, where the Grand Trunk Pacific has been running trains for some months, the employes will be taken into the government service. It appears that trains have been run by it in behalf of the contractors on about 300 miles of the line east and west of Cochrane. Cochrane is at the junction of the Temiskaming & Northern Ontario, about 500 miles north of Toronto. The government has for several months been running trains three times a week on the National between Moncton and Levis, opposite Quebec, about 466 miles.—The Railway Conductor.

NEW UNION IS FORMED—CUPID GRANTS CHARTER.

Miss Mae Ryan, daughter of Mr. and Mrs. M. Ryan, pioneers of San Jose, with large land holdings in Santa Clara County, became the bride of M. J. McGuire, labor leader, today, the wedding ceremony taking place in Mission Dolores Church, with the Rev. Father Tobin officiating.

The bride was handsomely gowned in white satin, with long tulle veil and orange blossoms. She carried a bouquet of lilies

of the valley and orchids. The bridesmaid was Estelle Bradbury. Edward A. Brown, connected with the State Housing and Immigration Commission, acted as best man. The altar was prettily decorated in cut flowers and potted ferns and palms.

Immediately after the ceremony the bridal couple left for the South, where they will spend their honeymoon. Upon their return they will reside in a charming home the groom has prepared for his bride in the Richmond district.

McGuire is one of the best known labor men in California. He has held various offices in the San Francisco Labor Council, the California State Federation of Labor, been prominent in many of the American Federation of Labor Conventions, and for some time was employed as investigator by the State Housing and Immigration Commission.—Newspaper Clipping.

DEMOCRATIZING THE NAVY.

Wholesale cribbing by the young men at Annapolis calls attention once more to the artificiality of the personal equation in the navy. By setting aside from the beginning one class of young men as seamen, and another class as officers; and by leaving the selection of the official class to individual Congressmen, who are subject to the various political influences of the district, and who, no matter what their intentions or ability, would be unable to choose from the boys of their districts one fitted for this peculiar life; and then by setting up rules of promotion that make it practically impossible for a man in the ranks to rise to distinction, we have set up all the machinery for the creation of social castes, and the deterioration of the service. The blunt old admiral who said that every man who goes to sea should come aboard through the hawsehole was right. Let every boy begin with actual service on board, where all are admitted who can qualify. Let instruction accompany practical service, with promotions for merit. Those who prove themselves most efficient can then be given special instruction at Annapolis. Such young men will get their point of view from the sea; they will be men picked by naval officers because of their fitness; and, best of all, having enlisted as common seamen, and risen by merit they will feel that the men under them are of the same order of beings; and the men will know that the officers are fellow citizens. Boys who enter Annapolis through the hawsehole of a man-o'-war will have minds less occupied by skylarking and cribbing; and they will have a better appreciation of their opportunities. The criticism of Admiral Winslow that officers in the navy are promoted because of social attainments, rather than seamanship, and the dry rot that has manifested itself in high places, are merely expressions of the class system that has sprung from the arbitrary selection of the officers. More democracy in the navy will be better for the men and better for the navy.—The Public.

News of General Interest.

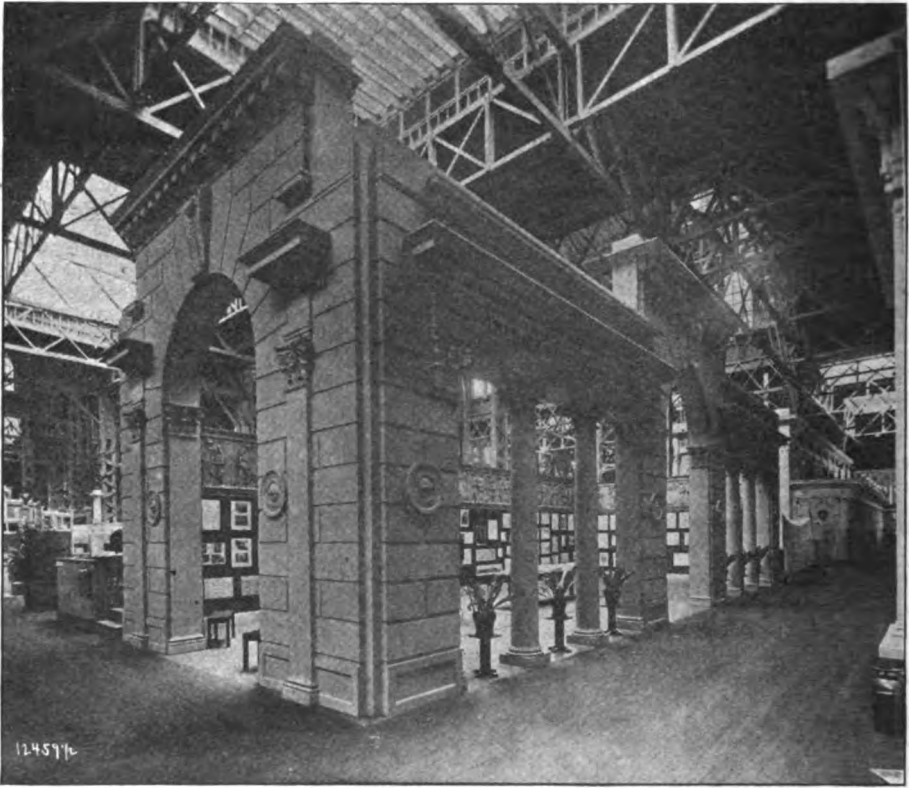

EXTERIOR VIEW A. F. OF L. BOOTH, PANAMA-PACIFIC EXPOSITION, SAN FRANCISCO, CALIF.

RETAIL PRICES OF FOOD, 1907 TO DECEMBER, 1914.

Bulletin 156, just published by the United States Bureau of Labor Statistics, shows retail prices of the principal articles of food in each of 44 important industrial cities throughout the United States. This bulletin continues the Bureau's series on retail prices, the last preceding bulletin on retail prices having dealt with prices for November and December, 1913. Actual prices for 1913 and 1914 are given, and also summaries of retail prices for the period from 1907 to 1914, inclusive.

The figures show that the highest point during 1914 was reached in September, when the price of all food was 7.1 per cent higher than the average price for 1913, and the lowest point was reached in April, when the price was 3.5 per cent lower than the average price for 1913. Except for lard and such articles as are affected by seasonal changes, the highest price during the year was either in August or September. The price of all food combined was but 2 per cent higher for the year 1914 than 1913.

For the eight years, 1907 to 1914, considering all food combined, the highest price was reached in 1914, while the lowest price prevailed in 1907. This, however, is not true of each article. Flour, for instance, was 5.3 per cent higher in 1909 than in 1914. Sugar, which reached a remarkably high point, 145.3 per cent, in August, 1914, was 7.9 per cent lower for the year 1914 than for the year 1911, and was also lower for the year 1914 than for the years 1910 and 1912. All meats were higher in 1914 than in any of the 7 preceding years.

The cities for which actual prices are shown are Atlanta, Ga.; Baltimore, Md.; Birmingham, Ala.; Boston, Mass.; Buffalo, N. Y.; Charleston, S. C.; Charleston, W. Va.; Chicago, Ill.; Cincinnati, O.; Cleveland, O.; Dallas, Tex.; Denver, Colo.; Detroit, Mich.; El Paso, Tex.; Fall River, Mass.; Indianapolis, Ind.; Jacksonville, Fla.; Kansas City, Mo.; Little Rock, Ark.; Los Angeles, Calif.; Louisville, Ky.; Manchester, N. H.; Memphis, Tenn.; Milwaukee, Wis.; Minneapolis, Minn.; Newark, N. J.; New Haven, Conn.; New Orleans, La.; New York, N. Y.; Omaha,

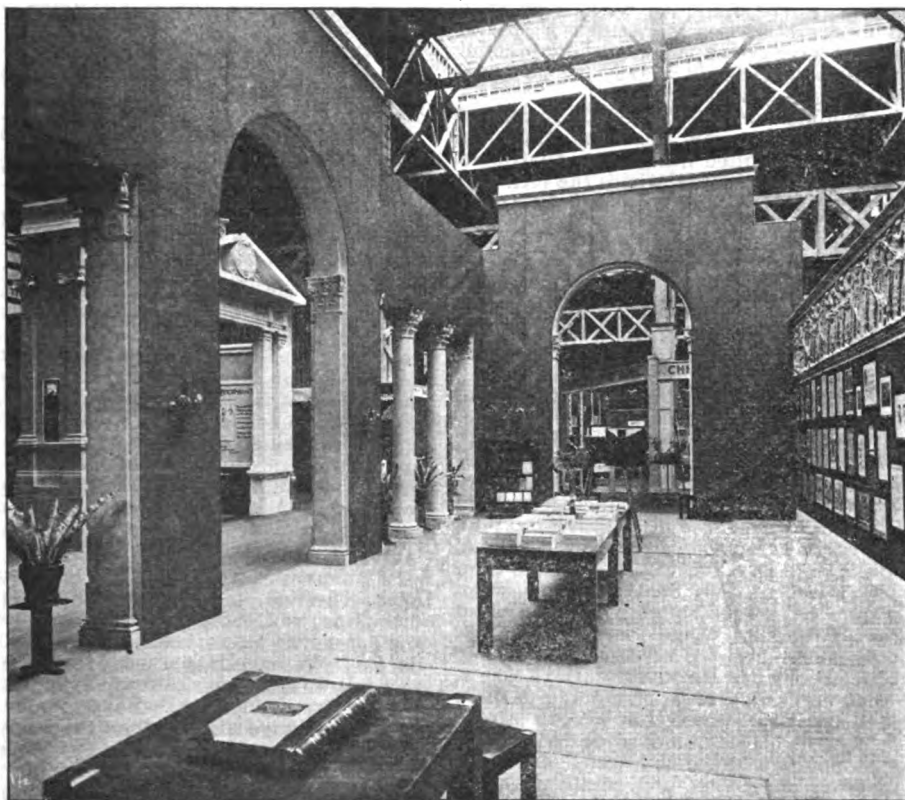

INTERIOR OF A. F. OF L. BOOTH, PANAMA-PACIFIC EXPOSITION, SAN FRANCISCO, CALIF.

Neb.; Philadelphia, Pa.; Pittsburgh, Pa.; Portland, Ore.; Providence, R. I.; Richmond, Va.; St. Louis, Mo.; St. Paul, Minn.; Salt Lake City, Utah; San Francisco, Calif.; Schenectady, N. Y.; Scranton, Pa.; Seattle, Wash.; Springfield, Ill., and Washington, D. C.

In Appendix A is described in detail the changes in the methods of dealing with the price quotations in constructing relative prices and index numbers and the shiftings of the base period from which price changes are measured in percentages of the average price for the base period.

Formerly changes in the prices of each individual commodity and of all 15 commodities included in the retail price index were expressed in percentages of the average price for each commodity and for all commodities for the period 1890-99. These percentages or relative prices were calculated by averaging relative prices expressing the percentage change in price for individual firms and for each city in a geographical district. The defects and limitations of relative prices and index numbers constructed by thus averaging percentages of prices that

differ greatly in amount are discussed, and the new methods used in this bulletin, by which relative prices and index numbers are calculated from actual money prices, are explained. A retail price index should show percentage changes in the cost of a given list of commodities—the workman's family market basket—rather than an average of the percentage changes in price of the individual articles.

For reasons made clear in this appendix the base period is changed from 1890-99 to the last completed year.

U. S. DEPARTMENT OF LABOR.

Minimum Wage Legislation in the United States and Foreign Countries.

That minimum wage legislation has been a success wherever it has been in effect long enough to show results is one of the conclusions to be drawn from Bulletin No. 167, just issued by the United States Bureau of Labor Statistics of the Department of Labor, covering minimum wage laws in the United States and foreign countries. The movement has apparently benefited em-

ployers and employes. In New Zealand and Australia, where minimum wage laws have been in operation for more than 15 years, industries have grown steadily and minimum wage laws apparently have in no way checked their growth.

The minimum wage study of the Bureau of Labor Statistics covers minimum wage legislation in the United States, the Australian states, and New Zealand, where the idea was originally put into practice, and in Great Britain. The trade boards of Germany and the proposed legislation of France are also included. A historical survey of the movement, reports of progress, analysis of legislation, and the workings of the various laws, together with the full text of the American laws and of the most important foreign laws comprise the Bulletin.

The minimum wage movement in the United States, according to the bureau, is not a sudden development in spite of the fact that no less than nine states enacted minimum wage laws in 1912 and 1913. These laws are the outgrowth of much investigation in this country and of investigation, agitation, and experience in New Zealand, Australia and England, where for more than 20 years remedies to deal with low wage conditions have been sought. In the United States minimum wage legislation was brought about because of disclosures made by official and private investigations, showing that thousands of women wage earners were being paid wages too low to afford them a "reasonable standard of living." A case in point of the many which are cited is that of department and retail stores in New York, Chicago and Philadelphia, where the weekly earnings of 40 per cent were less than \$6, while 74 per cent earned less than \$8 a week. An additional argument advanced for the minimum wage was the fact that in practically all industries employing women, establishments paying a living wage were found to be competing successfully with other establishments paying less than a living wage.

Massachusetts, in June, 1912, passed the first minimum wage law, and Oregon, Utah, Washington, Nebraska, Minnesota, Colorado, California and Wisconsin followed in the order named.

It is noteworthy that the minimum wage laws have been made to apply to men as well as to women and children in every country except the United States, where only women and children are protected.

In Utah the rates are fixed by the statute. In all the other American states the "necessary cost of living" is made the basis for the minimum wage, and the administration of the law is in the hands of appointed commissioners, who act upon the findings and recommendations of wages boards, composed of an equal number of representatives of the employers and of the employes, together with one or more representatives of the public.

All the evidence obtainable from American states which have put in effect the

legal minimum wage goes to confirm the experience of the Australian states, where the prosperity of the working class has been raised, gross "sweating" reduced, and general business conditions have thriven. In Utah, for example, where a minimum wage law became effective early in 1913, the wages of women and girls were raised, pay rolls were not increased more than 5 per cent, wages failed to tend down to the minimum level, efficiency according to many employers increased, and the law tended to equalize the cost of production or sale among manufacturers and merchants.

None of the predictions made about the minimum wage before the passage of the law in Washington State came about to any appreciable extent, according to statements gathered from local authorities. There was no wholesale discharge of women employes, no general leveling of wages, no general replacing of women employes by cheaper help, and no tendency to make the minimum wage the maximum wage. The report quotes a letter written by a Seattle garment manufacturer, who opposed the minimum wage law from the start:

"Personally, I find that my business has been benefited, as the necessity for greater discipline and more rigid enforcement of regular hours of work has become fully apparent. We have raised our average weekly pay roll, I think I am safe in saying, at least \$1 per girl if not more. Some of our help, to be sure, have always done their best and have shown but little change, but those who were satisfied with less, the minimum wage has benefited, as they saw they must earn more or quit.

"I am writing you this personal letter about my personal experience in an individual case. It has been a benefit in this factory in raising the standard of efficiency and in forcing a closer application to duty on the part of the operator and necessarily has been a benefit to the employer. I am not in position to speak for other factories and industries, but, aside from some hardship that the law may work on the less competent, I can not see why it will not give a greater efficiency to our factory forces."

No less significant is the statement of one of the secretaries of the British Board of Trade made to a parliamentary committee, when, after stating that the ultimate effects of the act could not be judged upon the present short experience, he said that the working of the act had thus far been successful beyond what anybody imagined possible and that a large number of applications had come from employers, as well as employes, to have their trades brought under the act.

The bureau is just completing and will publish shortly a study of the effects of the Oregon minimum wage law upon the numbers of girls and adult women employed, upon the rates which they are paid, and upon the labor cost to the employer of the rates established under the minimum wage law.

CARE OF THE BABY IN SUMMER.

(Prepared for the Journal by the Children's Bureau, U. S. Department of Labor.)

A baby must be kept as cool as possible in summer, because overheating is a direct cause of summer diarrhea. Even breast-fed babies find it hard to resist the weakening effects of excessive heat. Records show that thousands of babies, most of whom are bottle-fed, die every year in July and August, because of the direct or indirect effects of the heat. Next in importance to right food in summer are measures for keeping the baby cool and comfortable; frequent baths, light clothing, and the selection of the coolest available place for him to play and sleep.

A baby should have a full tub bath every morning. If he is restless and the weather is very hot, he may have in addition one or two sponge baths a day. A cool bath at bedtime sometimes makes the baby sleep more comfortably. For a young baby the water should be tepid, that is, it should feel neither hot nor cold to the mother's elbow. For an older baby it may be slightly cooler, but should not be cold enough to chill or frighten him.

If the water is very hard a tablespoonful of borax dissolved in a little water may be added to three quarts of water to soften it. Very little soap should be used and that a very bland, simple soap, like castile. Never rub the soap directly on the baby's skin, and be sure that it is thoroughly rinsed off, as a very troublesome skin disease may result if a hard soap is used or if soap is allowed to dry on the skin.

Use a soft wash cloth made from a piece of old table linen, towel, knitted underwear, or any other very soft material, and have two pieces, one for the face and head and one for the body. The towel should be soft and clean, also. Even in summer the baby should be protected from a direct draft when being bathed lest he be too suddenly chilled.

A young baby should be carefully held while in the tub. The mother puts her left hand under the baby's left arm and supports the neck and head with her forearm. But an older baby can sit alone and in summer may be allowed to splash about in the cool water for a few minutes.

When the bath is finished the baby should be patted dry, and the mother should take care to see that the folds and creases of the skin are dry. Use a little pure talcum powder or sifted corn starch under the arms and in the groin to prevent chafing. If any redness, chafing, or eruption like prickly heat, develops on the skin, no soap at all should be used in the bath. Sometimes a starch, or bran, or soda bath will relieve such conditions.

Bran Bath.—Make a little bag of cheese-cloth and put a cupful of ordinary bran in it and sew or tie the top. Let this bag soak in the bath, squeezing it until the water is milky.

Starch Bath.—Use a cupful of ordinary cooked starch to a gallon of water. (If the

laundry starch has had anything added to it, such as salt, lard, oil, bluing, it must not be used for this purpose.)

Soda Bath.—Dissolve a tablespoonful of ordinary baking soda in a little water and add it to four quarts of water.

Clothing.—Do not be afraid to take off the baby's clothes in summer. All he needs in hot weather are the diaper and one other garment. For a young baby this may be a sleeveless band which leaves the arms and chest bare, and for an older baby, only a loose thin cotton slip or apron, or wrapper, made in one piece with short kimono sleeves. Toward nightfall when the day cools, or if the temperature drops when a storm arises, the baby should, of course, be dressed in such a way as to protect him from chill.

Cotton garments are best for the baby in summer. All-wool bands, shirts, and stockings should not be worn at any time of the year, and in hot summer weather only the thinnest, all-cotton clothing should touch the baby's skin, unless he is sick, when a very light part-wool band may be needed. In general, neither wool nor starch should be allowed in the baby's clothing in summer. Wool is too hot and irritating and starched garments scratch the baby's flesh.

The baby should be kept day and night in the coolest place that can be found. The kitchen is usually the hottest room in the house, especially if coal or wood is burned for fuel. While the mother is busy with her work the baby should be kept in another room, or better, out of doors, if he can be protected from flies and mosquitoes.

A play pen, such as is described in *Infant Care*, a booklet published by the Children's Bureau and sent free on request, makes it possible to leave the baby safely by himself on the porch or in the yard, after he is old enough to creep.

A screened porch on the shady side of the house is a boon to every mother, affording a cool, secure place for the baby to play and also to sleep. Let him have his daytime naps on the porch and sleep there at night during the heat.

Do not be afraid of fresh air for the baby. He can not have too much of it. Night air is sometimes even better than day air, because it has been cooled and cleansed of dust by the dew.

The essentials in the summer care of babies are:

1. Proper food, given only at regular intervals.
2. A clean body.
3. Fresh air, day and night.
4. Very little clothing.
5. Cool places to play and sleep in.

Do not give the baby medicine of any sort unless it is ordered by the doctor. Never give him patent remedies which are said to relieve the pain of teething, or to make him sleep, or to cure diarrhea, for such medicines are likely to do the baby much more harm than good, especially in summer when the digestion is so easily disturbed. It is so much easier to keep the baby well, than it is to cure him when he is sick, that wise

mothers try to take such care of the baby that he will not be sick.

Do not fail to give the baby a drink of cool water several times a day in hot weather. Boil the water first, then cool it, and offer it to the baby in a cup, glass, or nursing bottle. Babies and young children sometimes suffer cruelly for lack of drinking water.

Bottle-Feeding.

Nothing is so important to the health of the baby in summer as the right kind of food. When for any reason breast milk can not be had a substitute must be found.

Experience in many thousands of cases has shown that cows' milk is the only food that can take the place of mother's milk with even a fair prospect of having it agree with the baby. Neither condensed milk nor the infant foods sold in the stores are so good as clean cows' milk for the baby who can not have breast milk.

But to have clean milk it is necessary to have clean cows, clean barns, clean milkers, clean pails, and clean handling. Later articles in this series will deal more particularly with the subject of milk. The country mother is often able to see the conditions under which the milk she uses is produced. City mothers, on the other hand, have the protection that is afforded when the city inspects its own milk supply.

In some cities it is possible to buy what is known as "certified" milk. This costs a little more than ordinary milk, but its purity is guaranteed by the authorities. But when certified milk can not be had, and when it is impossible for a mother to see for herself how the milk she uses is produced, she should heat all the milk she uses for the baby, in order to kill the disease germs which it may be carrying. Among the disease germs which thrive in milk are those of tuberculosis, typhoid fever, diphtheria, scarlet fever, and diarrhea.

Germs multiply very rapidly in milk, so rapidly, in fact, that even if it is reasonable clean when drawn it may become dangerous food if left standing in a warm place for some time. These germs may be killed by heating the milk. Boiling it for half an hour is a safe method, and is sometimes advisable in very hot weather; but the method of heating the milk without boiling it called pasteurizing is usually employed. An easy method of home pasteurization is as follows:

Put a gallon of water over the fire in a clean pan or kettle. When the water is boiling hard take the kettle from the fire and allow it to stand on a table for ten minutes uncovered. Then put in the filled and corked nursing bottles and leave them for half an hour, covering the kettle meanwhile with a blanket. At the end of the half hour remove the bottles and cool them as quickly as possible to 50 degrees and put them where they will keep cold until needed.

When it is time to feed the baby take out a bottle and set it in a pail of warm water over the fire to heat. The mother may test the warmth of the milk by sprinkling a few drops on her arm. If it feels just slightly warm it will be right for the baby.

After the baby has finished, the bottle should be emptied, rinsed, and filled with cold water. At some convenient hour in the day the mother will wash all the used bottles with soap and warm water, using a bottle brush to clean the inside of them. She should then rinse them and boil them in the same pan or kettle in which they were pasteurized. This kettle and all the dishes used in preparing the baby's food should be kept for that purpose alone.

The nipples should be washed carefully. A little salt rubbed on the inside will remove the milk. They should then be rinsed and dropped into boiling water for a few moments. They will dry with their own heat when removed. They should then be put away in a dry glass jar that has also been boiled, covered and kept out of the light.

When handling the sterilized nipples take hold of them by the lower rim. Do not touch the part which is to go into the baby's mouth. Never put the nipple into the mouth to test the milk, as the baby might easily be made sick if the mother happened to have a cold or throat trouble.

It will be found convenient to have enough bottles, nipples, and clean bottle corks for the entire twenty-four hours, and it will be a great saving of time if all the feedings are made up at once. This will also insure their being of uniform quality.

A later article will give a few directions for modifying the milk for babies of different ages. Whenever possible, it is best for a mother to have the advice of a good physician in regard to feeding her baby.

Whenever possible the baby's bottles should be kept on ice. A home-made refrigerator which will keep the milk sweet for 24 hours is easily and cheaply made at home. For this purpose procure a lard or candy pail, or a galvanized bucket, or even a wooden box with a cover. In the bottom place a layer of sawdust an inch thick. Inside the box or pail place another smaller receptacle, such as a ten-quart pail (tin), with a cover, and fill all the space around it with sawdust. This inner pail holds the ice and the milk.

The ice will keep longer if it is broken up and inclosed in a small covered pail. Put the little pail in the bottom of the refrigerator and pack the bottles around it, and put the cover on. Then close the outer cover, which for additional protection may be lined with newspapers, or with a cushion stuffed with hay or straw. Where ice can not be had, the bottles may stand in a pail, under a stream of running water.

A bottle baby should be fed with the same regularity as a nursing baby. The bottles may be given at 6 and 9 a. m., at 12 noon, and at 3, 6 and 9 p. m. Up to the age of four months the baby will need one more

night feeding. After that he should sleep all night.

Beginning at the fifth month the time between feedings should be lengthened a quarter of an hour each week until the interval is four hours, when the baby is six months old. Give no other food than the bottle feedings and drinking water in the first few months of the baby's life.

The baby should nurse slowly, but ought to finish his feeding in about 20 minutes. If he is inclined to take his food too greedily, withdraw the nipple from his mouth several times during the feeding and let him rest a moment.

It is especially important in summer not to over-feed the baby. It is far better to keep him on rather a low diet than to bring on an attack of diarrhea by giving him too much food, or that which is unsuitable, or by feeding him at irregular intervals.

FIRELESS LOCOMOTIVES FOR SWITCHING SERVICE.

By Frank C. Perkins.

The accompanying illustration shows one of the three fireless locomotives in use at the N. C. R. yards for switching purposes which were built at Lima, Ohio, and are of

some of the steam is condensed so that when the engine is ready for work, the drum is about three-fourths full of water. The drum is provided with a reducing valve which reduces the pressure to 60 pounds, at which pressure the engine works until the drum pressure has fallen below this.

On account of the large diameter of the cylinder, the engine has as much power at this reduced pressure as an engine of similar size would have with a high boiler pressure. The engine will work when the pressure in the drum is as low as ten pounds.

After the tank is filled, the locomotive weighs about 75,000 pounds and will run from two to three hours on each charge, depending entirely upon the number and weight of the cars handled. There is nothing passing up the stack except the exhaust steam, which makes it safe for use around the lumber yard and buildings where inflammable material is stored. As these engines are used around the office and factory buildings the smokeless feature makes them desirable.

These locomotives are said to be very economical, as the steam is generated in

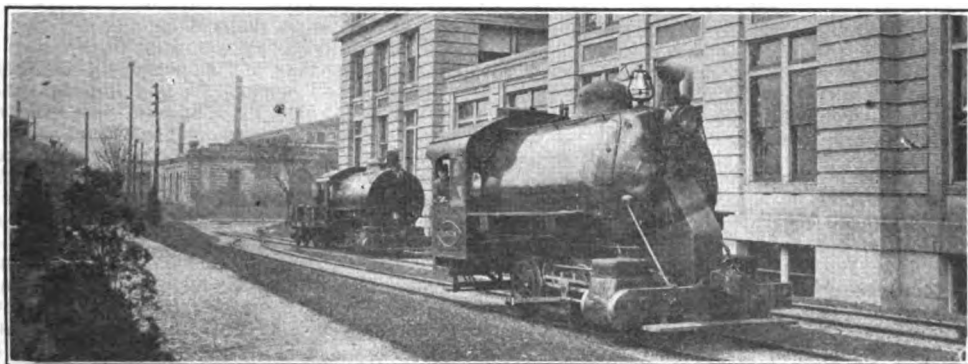

A FIRELESS LOCOMOTIVE SWITCH ENGINE.

German design. They are the only locomotives of this type in the United States except in the navy yards at Norfolk, Va., but there are a large number used in Germany.

It may be stated that these locomotives differ from the ordinary type of locomotives in being without a boiler or any means of producing fire. They consist essentially of a large tank 13 feet by 6 inches in diameter, having a capacity of 346 cubic feet, and containing no tubes; the engine cylinders are made large in order to operate on low pressure.

This type of engine operates in a very simple manner, the tank is filled about half full of water and steam at 150 pounds is injected from out boiler plant. The steam raises the pressure in the drum to 150 pounds, or boiler pressure, in from twelve to fifteen minutes. It will be seen that

the boiler plant and under the best conditions with high grade water tube boilers and stokers and when the engine is not in use, only three or four pounds pressure per hour is lost by radiation. The locomotive is used for switching purposes on more than two miles of track surrounding the factory and connecting the various buildings.

IS TUBERCULOSIS CURABLE?

Every once in a while, people will ask: "Do you really think consumption can be cured"; and then when they are told that thousands of cases all over the world bear witness to the fact of the curability of this disease, they wonder why their several friends and relatives who died with tuberculosis were not cured.

Tuberculosis is curable, but not everyone is cured, and not everyone can be cured. The chief reason why more consumptives

are not cured is because they have waited too long before they heeded the warning danger signals of the disease, or because some doctor to whom they went did not recognize this deadly plague. In its early stages, consumption can be cured, and the patient can generally resume his normal life within a period ranging from six months to two years, depending on circumstances. As high a percentage of actual recoveries from tuberculosis may be found in really early cases who follow the right course of treatment as in almost any other infectious disease.

What then, is the right course of treatment? This article cannot prescribe for individual cases, but it can and will tell what are the essentials in taking the cure for tuberculosis.

First of all there is a good doctor in whom you can rely and whose advice and inspiration is most valuable to you. He will not give you much medicine, because there isn't any drug or "cure" that he can prescribe that will do more than to relieve some immediate symptom, such as constipation, cough, headache, etc. If your doctor begins to talk of a "marvelous remedy" which will cure you, it is time you looked for another physician. That man is more than likely a quack and is simply after your money. There is no sure or quick "cure" or remedy for tuberculosis that you can buy at a drug store or that a doctor can give you.

The second essential in the cure of tuberculosis is fresh air. To the healthy person the best tonic is fresh air at work, at play, and during sleep. To the consumptive, however, air is medicine. He must take it in as large doses as he can, the more the better. It may not be easy for one who has been accustomed to indoor work to sleep and live outdoors; but since fresh air is vital, he must accustom himself to being outside all he can. At sanatoria for the treatment of tuberculosis, patients are out of doors on porches or elsewhere almost all the time. If one is at home, he can with a little ingenuity arrange devices for outdoor sleeping and sitting. The National Tuberculosis Association, 105 East 22d Street, New York, will send free of charge to anyone a booklet entitled "Directions for Living and Sleeping in the Open Air."

The next essential in the cure of tuberculosis is rest. Like fresh air, rest must be taken as a medicine by the consumptive. The reason for rest is evident, when you stop to think the way the germs of tuberculosis work. As they destroy the tissues of the lungs or other parts of the body, they make a wound or a cavity. This wound, like a cut on your finger, will not heal if it is being opened all the time. To keep the lungs as quiet as possible, rest in bed, or in a reclining chair is absolutely necessary. The dose of rest you must take will depend on your doctor's advice. He will tell you when you can get out of bed and when you can exercise and how much. But first and foremost you must learn to rest in order to give the lungs a chance to heal.

Besides a good doctor, fresh air and rest, the cure for tuberculosis requires good, wholesome food. In normal health, food of the right kind is very necessary, but in tuberculosis it is doubly important. Food is the fuel which heats the body and gives it its energy or you might almost say "steam." In tuberculosis one must pay special attention to food, because he has to provide fuel not only for the ordinary functions of the body, but he must provide an additional supply to meet the waste and damage done by the germs of the disease. This doesn't mean that you must be continually stuffing yourself, for if you do that you will upset your stomach, bowels, and liver, and you will counteract all the good the food might do. Neither does it mean that you must eat just one or two kinds of food, such as milk and eggs, which some people think are a cure for tuberculosis. They are excellent foods for people who can eat and digest them readily, and every consumptive should try to acquire an appetite for them. But meat and potatoes and bread and butter and good vegetables and almost any other nourishing, wholesome food in plenty of variety are needed also. Don't rely on tid-bits and sweets, but stoke your body furnace with food-fuel that will keep it running in the best possible order. Your doctor is the best one to advise on foods.

And, finally, a last essential in the cure of tuberculosis may be summed up in these words: "Don't worry," Keep a hopeful state of mind. If you give up and say "It's no use," you will never get well, no matter how patiently you follow the other essentials of a cure. Getting well depends for the most part on you. Backbone, hopefulness and courage will do more for you than all the doctors in the world.

Just a word as to where to take the cure. If you can go to a sanatorium, do so. There are not enough sanatoria for everyone, however. So you may have to stay at home and fight alone. Remember, tuberculosis can be cured if you take it in time and do your part.

Editor's Note.—This article has been prepared for the Boiler Makers' Journal by the National Association for the Study and Prevention of Tuberculosis. Others will follow, giving more details as to what you should know about tuberculosis.)

THE OPTIMIST.

By Walt Mason.

The optimist is one who knows that life has many kinds of woes; he doesn't say, for our relief, that there is no such thing as grief. He doesn't whoop around and swear that there is no such thing as care.

The "sunshine" fakers talk that way, and bore the world from day to day.

The optimist who says the wood knows life has much that isn't good; he doesn't fool himself with bunk, nor try to gold-plate pewter junk; he doesn't say that black is white, or see a dozen moons at night. He sees conditions as they are, yet ties his wagon to a star.

Progressiveness his watchword is; it animates his life and biz. If times are dull and business slack, he doesn't weep and wail, "Alack!" His mind is stored with useful facts which help and guide him in his acts, and so he knows just what to do, to keep his trade from falling through. A hundred useful hints he's read, and he has kept them in his head, and he can draw on that supply when business seems to wish to die. For knowledge is the stuff that wins; it beats all optimistic grins. Most any gent can smile and smile, when things jog on in splendid style; most any gent can sing and dance when he has roubles in his pants; but when all things are going wrong, the unread

copies in a file, to con them in the after-while. And there he found a thousand thoughts which surely hit a thousand spots; suggestions for that trade of his, and helps for his specific biz. And though the trade may not just hum, these things back to his memory come, and while the other chaps are sore, he's doing better than before.

A COAL STORAGE STEEL TANK.

By Frank C. Perkins.

The accompanying illustration shows a steel tank for coal storage utilized at North East, Pa. This circular steel bin is similar to a circular grain bin. The bin has a height and diameter, each about 40 feet,

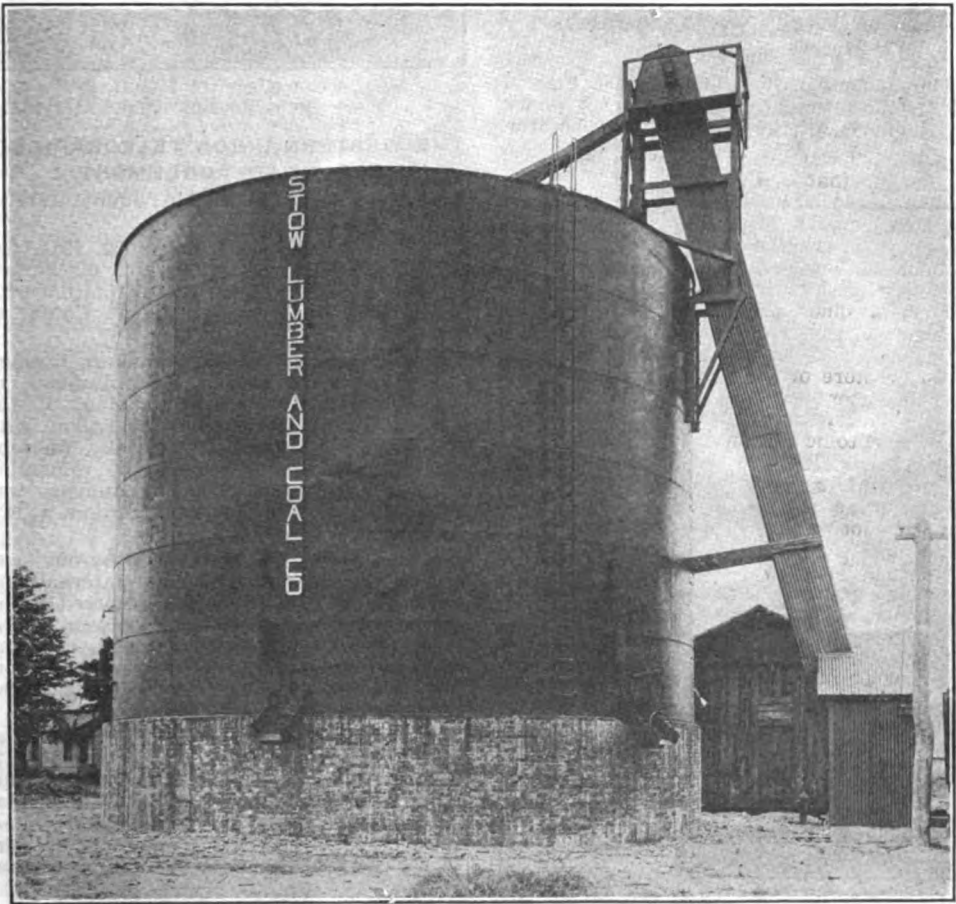

A COAL STORAGE TANK.

critter cans his song, and pulls his hair and wags his ears, and says this is a vale of tears.

When things are going doubly wrong, the optimist then looms up strong—the optimist who stores his mind with all the knowledge he can find.

He read the journal of his trade, through every page he liked to wade; he kept his

and rests on a brick foundation about 6 feet high.

It may be stated that the coal is unloaded into the bin and allowed to run from hopper-bottom cars into a pit under the center of the track. There is a bucket conveyor, inclosed in a chute, as shown at the right, and propelled by an electric motor, which carries it to the top of the bin, where it

may be diverted into any one of the six compartments.

It will be seen that as delivery is to be made to a retail customer the driver backs his truck under the gate of the proper compartment. The coal runs from the bin through a chute, the bottom of which is a screen, so that it is cleaned while being loaded.

It is claimed that this method of handling coal is very economical and satisfactory as the expense for labor is small and the proprietor is independent of that uncertain class of help upon which he must depend, and orders can be gotten out very rapidly when desired.

PUNCH PRESS WHEEL GUARDS.

By Frank C. Perkins.

The accompanying illustrations, Figs. 1 and 2, show the proper guarding of punch press wheels for the safety of the operator.

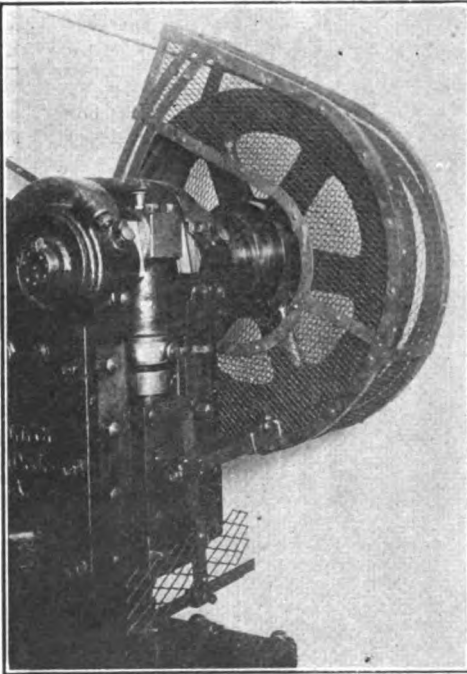

A press only half guarded is a constant source of danger and the employer has made safe not only the most dangerous part of the presses, but the wheels which are covered with screen guards. These guards have easy adjustment, as it is only necessary to remove a pin, and the door swings open, allowing easy access to the belt for repairs and shifting. There is no possibility of the workman getting his hands or clothing into the moving belt or wheel.

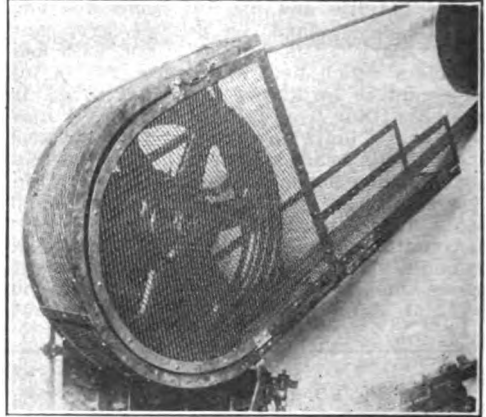

THE WESTERN UNION TELEGRAPH CO. BREAKS ITS AGREEMENT.

St. Louis, Mo., June 5, 1915.

Dear Sir and Brother:—

During the week of March 22, 1915, the Western Union Telegraph Co. discharged 48 men in St. Louis for their affiliation with the Commercial Telegraphers' Union of America.

An agreement was entered into, through the intercession of the Commissioner of Conciliation, Mr. Wm. Blackman, of the United States Department of Labor, with the Western Union Telegraph Co., whereby all discharged men were to be reinstated without prejudice. The agreement was repudiated by the Western Union a few days later.

A strike-vote was then taken by our local and carried unanimously. Our International President, S. J. Konenkamp, deferred action at the request of Mr. Wm. B. Wilson, secretary of the U. S. Department of Labor, who again delegated Mr. Wm. Blackman to confer with the Western Union officials, in the hope of averting the strike.

A second agreement was entered into at this conference. General Superintendent T. W. Carroll, of the Western Union Telegraph Company, again assured Mr. Blackman that all former agreements would be fulfilled, and that all discharged men would be reinstated without any discrimination whatsoever.

The Western Union for the second time however, refused to reinstate any of the discharged members unless they would first sever their relations with the Union and promise never again to join a labor organization antagonistic to the company because its policy was opposed to all organized labor, as publicly stated by its own president, Mr. Newcomb Carlton, at a hearing before the Industrial Relations Commission at Chicago in April, 1915.

On May 13 the strike was called and is still in effect. We are making a special ef-

fort to acquaint all members of organized labor and every friend and sympathizer with labor's cause how they can assist us in fighting for justice against this giant octopus whose tentacles reach into every hamlet of our great country.

Baseball tickers in saloons and cafes are the property of the Western Union Telegraph Co. It furnishes the service for \$5.00 weekly.

This revenue comes almost entirely from places frequented by our brother trade unionists and workmen. The receipts of the Western Union from this source alone reaches hundreds of thousands of dollars annually and you can help to cut this down to almost zero.

Prevail upon proprietors of saloons and cafes to discontinue this service. And also ask them to discontinue the clock service of the Western Union Telegraph Company. If you will do this it will help our union's fight against the most unscrupulous employer of labor in this country. The rules of the Western Union Telegraph Company, as proven on sworn testimony before the Industrial Relations Commission, are so inhuman that operators have been denied relief from duty long enough to obey the call of nature. Can you wonder why we have to begin to fight this monster? We appeal to you to help us establish human conditions and living wages for the telegraphers.

This company has planned to substitute girl typists for experienced telegraphers at miserable pay, under worse than sweat shop conditions, by the use of automatic transmission machines. While this method is inaccurate, it has been used effectively by the company as a club over the head of experienced telegraphers to keep them from demanding a living wage and better conditions.

Please don't file this, but act at once and see that committees of your organization canvass saloons and cafes and all others using the Western Union Telegraph Co.'s clock and baseball ticker service and have such committees report to you the results of their efforts.

Yours fraternally,
EXECUTIVE COMMITTEE,
Local No. 2,

Commercial Telegraphers' Union of America.
Per Phil. Schwartz, Secretary.

A NOVEL ELECTRIC WALKING JIB CRANE.

By Frank C. Perkins.

The accompanying illustration shows a 5-ton single rail 3-motor electrically driven walking jib crane developed at Hollinwood, Manchester, England. This electric walking jib crane has an 18-foot radius of hook and it is 15 feet 8 inches from rail level to center of top guide rollers, while a test load of 6¼ tons was utilized in its trial service. The crane has three movements, i. e. hoisting, traveling and slewing, each operated by a separate motor.

It may be stated that all of the motors

are of the slow speed, inclosed, series wound, reversing type, specially constructed for crane work. Each movement is independent of every other, both as to speed and direction, and may be run at will between nearly zero and the maximum for the weight being handled, the speed and direction depending respectively on the distance and direction the controlling lever is moved from its mid-position.

It will be noted that the wheelbox is of box form, constructed of mild steel plates and angles, braced and riveted together, the edges of all plates being planed. The vertical T stiffeners are riveted to the outside webs and it is fitted with two traveling wheels 27 inches in diameter, having cast iron centers hooped with double-flanged steel tires, turned on treads, and keyed on steel axles having double bearings bushed with gun-metal. The wheels are connected by steel shaft, and driven by spur and bevel gearing.

It may be mentioned that the bearings are carried by brackets bolted to the ends of the wheelbox. The motor for longitudinal traveling motion is carried inside the wheelbox. The wheel base is 18 feet and a suitable guard is provided over the roller and gear wheel at each end of the wheelbox. The wheelbox carries a fixed turned steel center post, on which revolves the jib.

It will be seen that the vertical portion of jib is constructed of two steel channels, and the horizontal and diagonal portions are of rolled steel sections, connected by gusset plates and turned bolts. The top of jib is fitted with a steel casting carrying four cast iron guide wheels 10 inches diameter, turned on tread to suit the overhead joists, and running on steel studs having gunmetal bushes. The jib revolves on a Hoffman type ball bearing.

It will be observed that the electric motor for slewing motion is fixed on the top of the wheelbox, and the driving for this motion is by spur and bevel gearing, an adjustable safety ratchet being provided. A mechanical brake is provided for slewing motion, operated by hand lever. The motor for hoisting motion is fixed at the back of the main center post on steel brackets suitably stayed. A treble purchase spur gearing is provided, and the hoisting gear is carried on pedestals attached to upper portion of jib. The barrel is 18 inches diameter, having turned groove for wire rope.

There is a length of one inch diameter flexible plough steel wire rope provided—one end of the rope being secured to the barrel, and the other end provided with counterweight and swivel hook having ball bearing. The outer end of jib is provided with rope guide pulley 18 inches diameter, working on fixed steel shaft. A powerful automatic brake of the self-contained multiple-disc type is used to sustain the load in any position, so arranged that when the current is switched on to the motor it will put into circuit an electromagnet, having sufficient power to raise the brake lever and make it inoperative when the hoisting or

lowering commences, also during the continuation of either movement, the reverse operation being produced when the current is switched off or falls from any cause whatever. If required to lower by gravity, the

feeding is stopped and another food given in its place. It should be done gradually. At first give one bottle instead of one of the breast feedings; after a week or two add another bottle, and then continue add-

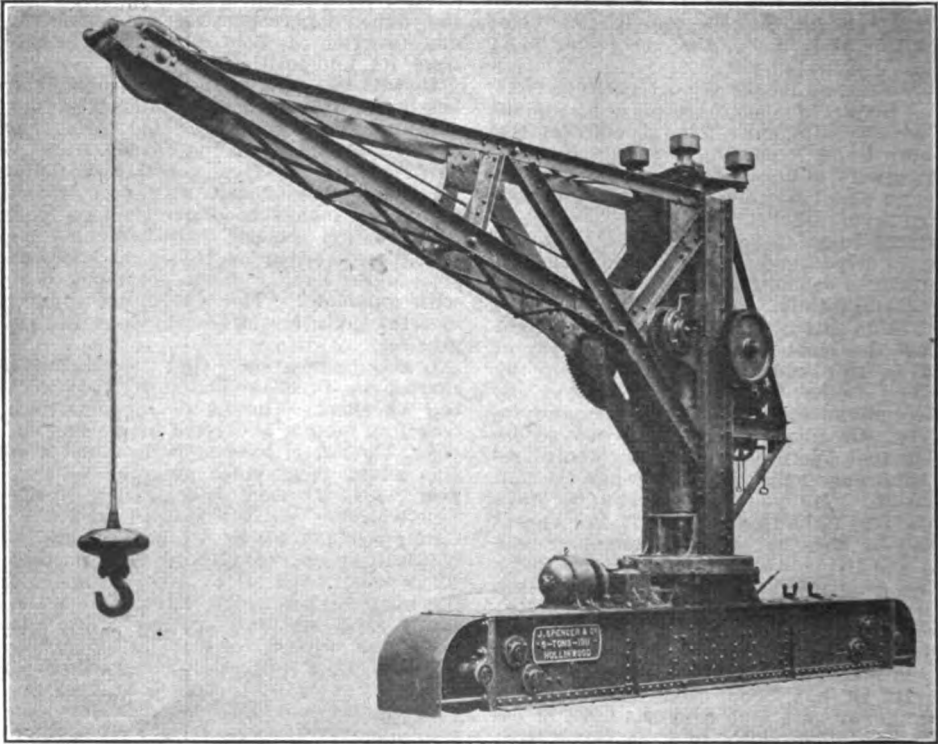

brake can be controlled by lever placed in a convenient position.

In order to prevent the possibility of the hook being overwound an arrangement is provided which automatically cuts out the current when the hook is approaching its highest position. Provision is also made to prevent overlowering. All the movements of the crane are worked by three reversing switches or controllers of the tramway type, having metallic resistances, and carried inside the wheelbox, the levers being conveniently placed to enable the attendant to control the various movements either separately or simultaneously as required.

It will be of interest to note that the various speeds of the crane, together with powers of motors are for hoisting 12 feet per minute, using a $7\frac{1}{2}$ horsepower motor, the traveling speed being 150 feet per minute with a six horsepower motor, the slewing being accomplished at a speed of 250 feet per minute, a four horsepower electric motor being utilized.

CARE OF THE BABY IN SUMMER.

(Prepared for the Journal by the Children's Bureau, U. S. Department of Labor).

Weaning and Supplementary Feeding.

Weaning is the process by which breast

ing them until bottle feedings are entirely substituted for the breast.

Never hurry the weaning. Give the baby time to get used to the new food. When it is agreeing with his digestion, there is no belching of gas or spitting up of milk, and the bowel movements are soft, yellow, and smooth. If any disturbance appears, stop the bottle until it is over, giving only the breast milk.

A baby should never be weaned in the heat of summer, if it is possible to avoid it. He is much more likely to be made sick by a strange food when the weather is hot than at other times of the year. Even if the baby has to be fed partly on the bottle the mother should nurse him often enough (three or four times a day) to keep the breast milk from drying up; for if the baby should be attacked by diarrhea, the mother's milk may be the means of saving his life.

Some mothers are able to nurse their babies a full year, but many find that their milk begins to fail by the time the baby is 6 or 8 months old, so that some additional food will be required. Practically all babies should be entirely weaned from the breast by the time they are a year

old, unless that brings the weaning in hot weather.

Babies born in the late summer or early fall should be nursed through the following summer, if the breast milk is sufficient in quantity, in order to carry them past the danger period in July and August. When breast milk lessons in quantity, it does not change in quality. By the addition of a bottle or two, therefore, the deficient quantity can be made up.

It is sometimes quite difficult to wean a baby and great patience is required on the part of the mother, but if the baby has been taught at an early age to take his drinking water from a bottle or from a cup, weaning will be easier. If the baby is nursed until he is ten months old or longer, he should be weaned directly to a cup. Earlier it will probably be easier to use a nursing bottle and nipple; but the bottle should not be used much beyond the end of the first year, save for the bed-time feeding.

Remember when feeding from a cup, that the milk must be taken very slowly, just as slowly as when feeding from a bottle. It is better to feed from a small spoon than to teach the baby to drink from a cup.

The second summer has gained the reputation of being the most critical period of a baby's life largely because mothers are apt to feed the baby many different things after he is weaned. Very much of the food that is given these older babies, is as unfit for them as artificial food is at birth.

These improper foods cause troublesome, dangerous and unnecessary illnesses which are aggravated by the heat. Careful feeding would prevent most of them.

Later articles in this series will deal with the feeding of babies from nine to twelve months, and during the second year.

When a breast-fed baby cries a good deal from hunger, and does not gain in weight, the mother is apt to feel that her milk does not agree with him, and so weans him, often because of the well-meaning advice of some neighbor. This is a mistake. The trouble is not with the quality of her milk, but with the quantity.

Instead of weaning the baby she should increase her own diet, by drinking plenty of milk, eating eggs, meat, bread and fresh vegetables, and by taking moderate exercise in the open air, regular periods of rest, and by avoiding worry and excitement. This will usually increase the milk supply sufficiently; if it does not do so, the baby must be given some additional food.

This additional food, or "supplementary" feeding, as has been said, is given when it is necessary to supplement the mother's milk with one or more bottle feedings, or for the purpose of weaning the baby. Cows' milk is the only supplementary food to use. It should be the best and cleanest milk that it is possible to get, mixed with water and sugar as described in the preceding article. A very much weaker solution than that normally required for a baby of the given age, should be tried at first, increasing the

strength slightly day by day if the baby shows no signs of indigestion, until the full strength food is reached.

To begin with give the baby one bottle feeding in place of one breast feeding. If he shows a gain in weight, this may be enough. If after a week there is no gain, two bottles may be given each day. The mother should meanwhile be doing all she can by rest and increased food to build up the breast milk, but if with all these measures the baby still fails to gain or give evidence of illness, the advice of a good doctor must be sought and followed. Do not delay in securing this advice until the baby is seriously ill.

The preceding article gave directions for the proper amount of milk mixture for babies of given ages. If the mother desires fuller information she may write to the Children's Bureau of the U. S. Department of Labor, at Washington, D. C., for a bulletin called *Infant Care*, which gives simple directions for preparing the baby's feedings and shows what amount will suit the baby of a given age. This book is sent free to everyone who asks for it. A post card request will do. The name and the address of the applicant should be written very plainly.

Weaning from the bottle should begin by the end of the first year, and after the baby is 14 months old he should have the bottle only when he goes to bed at night. Teach him to drink from a cup and eat from a spoon.

To wean a baby from the bottle, begin by giving him a little of his food from a spoon, gradually increasing the amount at each feeding until all of his food is taken in this way.

Artificial Feeding.

When a baby is deprived of his natural food, that is, his mother's milk, and must be fed from a bottle, this method is called artificial feeding. It is fraught with many dangers for the baby and much difficulty for the mother. The baby must learn to digest a food not adapted to his delicate organs, often a hard task for him to accomplish, and because of the strange food, it may take several months for him to adapt himself and begin to grow and develop as he should.

The mother or nurse has also a difficult task. To take proper care of the milk, of the utensils needed in its preparation, and the nipples and bottles, means patient, daily devotion to petty details. It means constant study to see that the milk mixture given is exactly adapted to the baby's condition, and to increase or decrease it in quantity or strength in accordance with the baby's varying needs.

The mother must be continually on guard to see that the milk is clean and fresh when it comes to her, and that it is kept clean, cold and covered while in the house, both before and after the daily feedings are made up.

All this work makes such demands on the time and strength of a busy mother that, for selfish reasons alone, she should be glad to do all in her power to nurse the baby at her own breast, even if breast feeding were not so greatly to the bay's advantage.

If, however, the baby cannot have breast milk, then the best effort possible must be put forth to adapt cow's milk to his uses.

The proper amount of milk for babies of given ages and the way to dilute and sweeten it are matters that cannot be treated completely in an article like this. Whenever possible, artificial feeding of a baby should be under the direction of a competent doctor. But if a mother cannot have such advice, she may be helped by directions given in a number of books on the subject, and in a pamphlet published by the Children's Bureau of the Department of Labor, at Washington, D. C., called *Infant Care*. This pamphlet is sent free to everyone asking for it.

Some of the general rules of artificial feeding are these:

After the first month, the average healthy baby requires $1\frac{1}{2}$ ounces of milk in 24 hours for every pound of weight, diluted with the proper amount of water for his age. Thus a 10-pound baby will probably require 15 ounces of milk, diluted and sweetened as necessary, during 24 hours.

All increases either in the strength or quantity of the food must be made very gradually.

The following directions for feeding the baby have been prepared by a committee of the American Medical Association:

Beginning on the third day, the average baby should be given 3 ounces of milk daily, diluted with 7 ounces of water. To this should be added one tablespoonful of limewater and 2 level teaspoonfuls of sugar. This should be given in seven feedings.

At 1 week the average child requires 5 ounces of milk daily, which should be diluted with 10 ounces of water. To this should be added $1\frac{1}{2}$ even tablespoonfuls of sugar and 1 ounce of limewater. This should be given in seven feedings. The milk should be increased by one-half ounce about every four days. The water should be increased by one-half ounce every eight days.

At 3 months the average child requires 16 ounces of milk daily, which should be diluted with 16 ounces of water. To this should be added 3 tablespoonfuls of sugar and 2 ounces of limewater. This should be given in six feedings. The milk should be increased by one-half ounce every six days. The water should be reduced by one-half ounce about every two weeks.

At 6 months the average child requires 24 ounces of milk daily, which should be diluted with 12 ounces of water. To this should be added 2 ounces of limewater and 3 even tablespoonfuls of sugar. This should be given in five feedings. The amount of milk should be increased by one-half ounce

every week. The milk should be increased only if the child is hungry and digesting his food well. It should not be increased unless he is hungry, nor if he is suffering from indigestion even though he seems hungry.

At 9 months the average child requires 30 ounces of milk daily, which should be diluted with 10 ounces of water. To this should be added two even tablespoonfuls of sugar and 2 ounces of limewater. This should be given in five feedings. The sugar added may be milk sugar or if this can not be obtained cane (granulated) sugar or maltose (malt sugar). At first plain water should be used to dilute the milk.

At 3 months, sometimes earlier, a weak barley water may be used in the place of plain water; it is made of one-half level tablespoonful of barley flour to 16 ounces of water and cooked for 20 minutes.

At 6 months the barley flour may be increased to $1\frac{1}{2}$ even tablespoonfuls cooked in the 12 ounces of water.

At 9 months the barley flour may be increased to 3 level tablespoonfuls cooked in the 8 ounces of water.

Bottle-fed babies are very apt to suffer from overfeeding. They may be overfed because they are fed too much at one time, or because they are fed too often, or because the food is too rich for their digestion. They may also be upset because they are fed at irregular intervals.

A baby is easily taught regular habits and no good habit is of more importance to his healthy development than that of having his food at absolutely regular intervals. He should be given his bottle once in every three hours by the clock, until he is about six months old, and then once in four hours unless the doctor orders that he be fed otherwise.

The hot weather of July and August is the time when the greatest care must be exercised in artificial feeding. The baby has less appetite, and is not as well able to digest his food during the excessive heat. On this account he should have less food than usual and it is often wise to weaken the feeding slightly by pouring out one quarter of the milk and adding the same amount of boiled water to each bottle. If the baby shows any signs of indigestion the time between feeding should be lengthened to 4 hours.

The baby will not gain in weight at such a time, as much as when the weather is cool, but it is far better to feed him less than to induce an attack of diarrhea by giving him more food than he can digest.

Especially during the hot weather, the baby should have plenty of drinking water which has been boiled and cooled. Never give him ice water.

"There's only one time in her life when a woman isn't afraid of a telegram."

"When is that?"

"On her wedding day."

BY UNITED NEWS WRITERS.

New York.—A plan whereby the so-called "business administration" of the city of New York is apparently endeavoring to evade the law which provides that the prevailing rate of wages in an industry must be paid to employes of the municipality, was brought to light by delegates at a meeting of the Central Federated Union, the central labor body of the city.

Delegates pointed out that the administration refuses to pay the prevailing rate to its regularly engaged employes, placing them upon an "annual employes'" list. The

prevailing rate is only paid to those who are engaged in day work.

By forming councils of its "annual employes," sending delegates to a central council which confers with department heads, the Mitchel regime, which is based upon "economy," is endeavoring to eliminate the influence of the unions which have jurisdiction over the city employes.

Delegates pointed out several anti-labor moves made by the Mitchel administration, particularly the discharge of 600 employes of the dock department during the extreme crisis of unemployment in the city last winter.

Smiles.

Cy Warman, author of the song "Sweet Marie," who died a few months ago in Chicago, was a high official of the Grand Trunk Railroad; but he was always modest about his post.

Once he stopped overnight at a little hotel in Northern Michigan, conducted by a man who had previously run a shooting-gallery and later a night-lunch car in New York. The host related his own life story at length. Then he became interested in the biography of the visitor.

"What do you do up in Montreal, Mr. Warman?"

"I work for the Grand Trunk," said Warman.

"What kind of a job have you got—do you sell tickets or handle baggage?"

"Oh, I've got a better job than either of those," said Cy. "You know the man who taps the wheels with a hammer to see that everything is all right? . . . Well, I help him listen."—Everybody's.

SUPPLY CUT OFF.

Weary Walker: "No, mum, I ain't dirty from choice. I'm bound by honor. Yer see I once wrote a testimonial for a soap-maker and promised to use no other."

Madam: "Well, why don't you use that?"

Weary Walker: "Because, mum, the firm failed about five years ago.—Boston Transcript.

He: "I wonder what the name of that picture is? The youth and the maiden are in a tender attitude."

She: "Oh, don't you see? He has just asked her to marry him. How sweet! What does the artist call the picture?"

He (looking about): "Oh, I see. It's written on the card at the bottom, 'sold.'"
—Ex.

HIS MAIN NEED.

Mabel: "How are you getting on at college, Percy?"

Percy: "Oh, all right. I'm trying awfully hard to get ahead, you know."

Mabel: "Well, heaven knows, you need one!"—Judge.

HONORS EVEN.

"Dear May," wrote the young man, "pardon me, but I'm getting so forgetful. I proposed to you last night, but really forget whether you said yes or no."

"Dear Will," she replied by note, "so glad to hear from you. I know I said 'no' to someone last night, but I had forgotten just who it was."

SHE JOINED IN, TOO.

"But why did you leave your last place?" the lady asked the would-be cook.

"To tell the truth, mum, I just couldn't stand the way the master an' the missus used to quarrel, mum."

"Dear me! Do you mean to say that they actually used to quarrel?"

"Yis, mum, all the time. When it wasn't me an' him, it was me an' her."

Hobo: "Yes'm, I wunst had a good job managin' a hand laundry, but it failed on me."

Lady: "Poor man. How did it happen to fail?"

Hobo: "She left me and went home to her folks."

THE COSTLY CAR.

Redd: "Is that your own car?"

Greene: "Oh, yes."

Redd: "I understand it will take no one's dust."

Greene: "Well, it's taken a whole lot of mine."—Yonkers Statesman.

SOME SATISFACTION.

She: "No, Mr. Simpson, I'm sorry; but I wouldn't marry the best man living."

He: "No. Well, at any rate, you will have the satisfaction of knowing that he offered himself."—Boston Transcript.

"I heard you had an execution in your house the other day."

"In a way."

"What do you mean by that?"

"I was hanging some pictures and my wife was killing time."

DIPLOMACY.

A well-known English politician was much annoyed by reporters. One day he was enjoying a chat at a London hotel when a strange young man came up who seemed to have something of importance to communicate, and led him across the room. Arrived in a corner, the stranger whispered, "I am on the staff of an evening paper, and I should like you to tell me what you think of the government's foreign policy."

Mr. Dash looked a little puzzled; then he said, "Follow me." Leading the way, he walked through the reading-room, down some steps into the drawing-room, through a long passage into the dining-room, and drawing his visitor into the corner behind the hatrack, he whispered, "I really don't know anything about it."—*Weekly Telegraph.*

SPOKE TOO SOON.

A party of young women visited an observatory to have a peek through the monster telescope at the new comet. The astronomer conducted them to the instrument, and they looked through in turns.

"Oh, isn't it charming, heavenly, enchanting, wonderful!" etc., ad libitum.

After a while the sly astronomer observed:

"Now, ladies, I shall remove the cover and place the instrument in position, if you will allow me."—*Ex.*

RIGHT BACK AT HIM.

"Look at me!" exclaimed the leading lawyer, warmly. "I never took a drop of medicine in my life, and I'm as strong as any two of your patients put together."

"Well, that's nothing," retorted the physician. "I never went to law in my life, and I'm as rich as any two dozen of your clients put together."—*Tit-Bits.*

END MAN JOCOSITY.

"Sambo, if an aviator, born in Greece and having a German father and a Welsh mother, were to fall out of his machine at a height of 1,000 feet, what nationality would he be when he landed?"

"Ah doan know, Mr. Interlocutor."

"He'd come down a Rushin', Sambo."—*Philadelphia Ledger.*

HIS THREE REASONS.

"Why don't you get married?"

"Well, you see, I am very particular. My wife must be rich, handsome and stupid."

"Why all that?"

"Very simple. She must be rich and handsome, otherwise I would not have her; and she must be stupid, otherwise she would not have me."—*Fliegende Blatter.*

"Because," said the youth, "wars make history, an' I jest hate history."—*Ladies' Home Journal.*

A CHANGE COMING.

In correcting the exercises of her class a teacher recently observed a new name inscribed on one of the papers—Will Evans. She looked round the class, but could see no new boy. Not a little puzzled, she requested Will Evans to stand.

Up jumped Will Jones, and the teacher got more puzzled still.

"Your name's Jones," she said, "not Evans!"

Will looked not a little abashed, and shifted uneasily from one foot to the other.

"Please, ma'am," he said, "it's owing to family trouble. I didn't do it, please, ma'am."

"But," she said, sternly, "I repeat, your name is Jones."

"Please, ma'am," said the boy, "it's changed now. Ma's married the lodger!"—*Red Hen.*

NOW HE IS NEUTRAL.

"Come here, Jim," said Brown. "We want you to settle an argument. What do you think of that submarine business?"

"Nothin' doin', Jake," responded Brown. "It was only yesterday that I went over all that with Bob Green."

"You did, did you?" interestedly returned the other. "What did you arrive at?"

"Well," answered Brown a little sadly, "Bob arrived at the hospital and I arrived at the police station."—*Philadelphia Telegraph.*

A SAFE POSITION.

The Italians bound for Tripoli were boarding a transport.

The colonel was at his post watching the men. As one of them stepped on the gangway his mother clutched him and pulled him to her bosom.

With intense emotion she cried and crooned over him, and then she saw the colonel.

"My boy," she exclaimed, "stick close to the colonel, and you'll never get hurt!"—*Tit-Bits.*

A NEW TROUBLE ON A ROUGH ROAD.

A traveler in the dining car of a Georgia railroad had ordered fried eggs for breakfast. "Can't give you fried eggs, boss," the negro waiter informed him, "lessen you wait till we stop."

"Why, how is that?"

"Well, de cook, he says de road's so rough dat every time he tries to fry aigs dey scrambles."—*Housekeeper.*

A LITTLE GIRL'S IMPORTANCE.

Grandma (impatiently): "Dorothy, I do wish you would keep quiet for a little while!"

Dorothy: "I'll try, grandma; but please don't scold me. Just remember that if it wasn't for me, you wouldn't be a grandma at all."—*Chicago Record-Herald.*

A DOMESTIC WARNING.

Mrs. Gordon was spending some time at Palm Beach, and during her stay she wrote her husband, saying:

"Dear Will: I inclose the hotel bill."

Will wrote back:

"Dear Edith: I inclose check, but please don't buy any more hotels at this price. They are robbing you."

"Nigger," warned one, "dout mess wid me, 'cause when you do you sure is flirtin' wid de hearsee."

"Don't pesticate wid me, nigger," replied the other, shaking his fist; "don't fo'ce me t' press dis upon you', 'cause if I does I'll hit you' so ha'd I'll separate yo' ideas from yo' habits; I'll jes' knock you f'um amazin' grace t' a floatin' opportunity."

"If yo' mess wid me, nigger," continued the other, "I'll jes' make one pass an' dere'll be a man pattin' yo' in de face wid a spade tomorrow mornin'."—Ex.

A "cub" reporter on a New York newspaper was sent to Paterson to write the story of the murder of a rich manufacturer by thieves. He spread himself on the details and naively concluded his account with this sentence:

"Fortunately for the deceased, he had deposited all of his money in the bank the day before, so he lost practically nothing but his life."—Harper's.

CREDIT WHERE DUE.

"My wife made me a success," remarked the man.

"I am glad to hear you say that," declared his pastor.

"Yes, she has always wanted so many things that I've had to hustle."

Prof.: "Pst! Are you looking for German spies?"

"Mais oui?" said the policeman, taking from under his cape his notebook and pencil.

"Then go to the Hotel de Blanc and arrest the proprietor. He's put up at least two concrete beds there. I know, because my wife and I slept in 'em last night."—Washington Star.

A MARVEL OF TRAINING.

Rose had called on her afternoon out to see her friend, Arabella. Arabella's mistress had just purchased a parrot, and Rose was much interested in the bird.

"Birds is shore sensible," she observed.

"You kin learn them anything. I uster work for a lady that had a bird in a clock, an' when it was time to tell de time ob day it uster come out an say 'cuckoo' jest as many times as de time was."

"Go along. Yo' doan' say so," said Arabella, incredulously.

"Shore thing," replied Rose, "and de mos' wonderful part was dat it was only a wooden bird, too."—Harper's.

NOT FOR TEN TIMES AS MUCH.

Marks: "So you saw the woman who dropped the purse, but lost her in the crowd. Did you advertise for her?"

Parks: "Yes; I put this in: 'If the very homely woman of 40; wearing a dress of last year's style and a most unbecoming hat, who lost her purse containing \$3.50 or Boylston Street, Saturday, will apply to —, her property will be returned.' I've had no answer, though."

Marks: "Good Lord! Do you think a woman would own up to that description for \$3.50?"—Boston Evening Transcript.

THANKING THE JUDGE.

An old woman was profuse in her gratitude to a magistrate who had dismissed a charge brought against her.

"I though you wouldn't be 'ard on me, your worship," she remarked as she left the dock. "I know how often a kind 'art beats be'ind a ugly face."—Tit-Bits.

A correspondent sends us this story, evidently from an ironical Swiss paper. A few soldiers belonging to part of a Swiss regiment in garrison at Basel went to a cafe for refreshments. One of them sat down at a table. Later a civilian, a German, joined him and the two began to talk war politics. "Would you shoot on the Germans if they invaded Switzerland?" asked the German.

"Oh, no, never!" exclaimed the soldier.

"Waiter, a pint of beer and a beefsteak with potatoes for this brave man," ordered the civilian.

"And your pals sitting at the next table—would they also not shoot the Germans if they tried to invade this country?"

"Oh, no, never!" retorted the Swiss.

"Waiter, a glass of beer for each of the soldiers at the next table!" ordered the civilian.

And addressing again the soldier, he asked: "Is this generally the view held in the Swiss army in regard to a possible German invasion? Are all the Swiss soldiers so Germanophil?"

"I don't know," replied the soldier.

"But why would you not shoot the Germans?"

"Because we belong to the band."—Manchester Guardian.

HE KNEW.

The "Swanky" One: "I'm smoking a terrible lot of cigars lately."

The Other (with conviction): "You're right, if that's one of them."—Tit-Bits.

IT MUST FOLLOW.

Committee Chairman: "How does the organization of which you are a director make all its money?"

Millionaire Witness: "I have no exact knowledge of the details, but it is an altogether different process from the one they use at the mint."—Baltimore American.

Poetical Selections.

ASHAMED OF YOUR MOTHER!

Ashamed of your mother! whose tresses of silver
Have changed in the years from the wave-lets of gold;
Ashamed of her garments, her poor hands have toiled for,
Ashamed just because they are faded and old.
Ashamed of her tear-drops, her patience, and sorrow,
When you in your anger have been so unkind;
But go where you will, there will not be another—
So soon to forgive as your mother, you'll find.

Ashamed of her form, and the deep sunken furrows,
So long interwoven upon her pale brow;
You loved her back in the days of your youthtime,
Why, then, are you slack in your love for her now?
She sat by your cradle, and soothed you to slumber,
She crooned the sweet songs as she stroked your fair head.
And then in your childhood, she guarded your footsteps—
And covered you up in your wee trundle bed.

O! the pathway of mother is not strewn with roses,
Her heart has been punctured by many a thorn;
Go tell her your faults, and add to her comfort,
She has toiled without rest since the day you were born.
Ashamed of your mother! whose heart is now yearning,
For one fond embrace for the love that she gave;
Her days may be few, and the time is now fleeting,
Love cannot avail when she sleeps in the grave.
—Frederick A. Davies, Cleveland, O.

MEMORIES OF "THE OLD VIRGINIA REEL."

By Adelbert Clark.

In this old Colonial mansion,
Where the ancient ivies climb,
With their slender branches clutching
At the throat of Father Time,
Here tonight the years turn backward,
'Till my youthful days I feel,
And I seem to hear the music
Of "The Old Virginia Reel."

It was here I first met Martha
In her gown of snow-white silk,
With rich amber jewels shining
On her neck and arms of milk.
And 'twas in this quaint, old parlor,
That I found her true as steel,
When we gaily danced together
In "The Old Virginia Reel."

Life was then a dream of Eden,
So we laughed the hours away,
While the stars above grew dimmer,
With the dawning of the day.
How we laughed and sang and chattered,
As she tapped the scarlet heel,
To the merry, merry music
Of "The Old Virginia Reel."
But those youthful days have vanished,
And sweet Martha, she is dead,
And above her breast the roses
Drop their petals white and red.
Was it just the ivy tapping
'Gainst the wall that made me feel
That my soul was all enraptured
With "The Old Virginia Reel"?

No, for when the silv'ry moonbeams
Spread their veil upon the floor,
I can see the beaux and sweethearts
Just as in the years before.
I can hear the jolly fiddler,
And the organ's joyful peal,
And the dancers' changing movements
In "The Old Virginia Reel."

THE VOICELESS.

We count the broken lyres that rest
Where the sweet wailing singers slumber,
But o'er their sister's breast
The wild-flowers who will stoop to number?
A few can touch the magic string,
And noisy fame is proud to win them:—
Alas for those that never sing,
But die with all their music in them.

Nay, grieve not alone for the dead alone
Whose song has told their hearts' sad story,—
Weep for the voiceless who have known
The cross without the crown of glory!
Not where Leucadian breezes sweep
O'er Sappho's memory-haunted billow,
But where the glistening night-dews weep
One nameless sorrows' churchyard pillow.

O hearts that break and give no sign
Save whitening lip and fading tresses,
Till Death pours out his longed-for wine
Slow-dropped from Misery's crushing presses—
If singing breath or echoing chord
To every hidden pang were given,
What endless melodies were poured,
As sad as earth, as sweet as heaven!
—Oliver Wendell Holmes.

THE VOICE OF THE PEOPLE.

(By James G. Clarke, in the American Federationist for May.)

Swing inward, O gates of the future,
Swing outward, ye doors of the past,
For the soul of the people is moving
And rising from slumber at last;
The black forms of night are retreating,
The white peaks have signaled the day,
And freedom her long roll is beating,
And calling her sons to the fray.

And woe to the rule that has plundered
And trod down the wounded and slain,
While the wars of the old time have
thundered,

And men poured their life-tide in vain.
The day of its triumph is ending,
The evening draws near with its doom,
And the star of its strength is descending
To sleep in dishonor and gloom.

Though the tall trees are crowned on the
highlands

With the first gold of rainbow and sun,
While far in the distance below them
The rivers in dark shadows run,
They must fall, and the workmen shall burn
them

Where the lands and the low waters meet,
And the steeds of the new time shall spurn
them

With the soles of their swift-flying feet.

Swing inward, O gates of the future,
Swing outward, ye doors of the past;
A giant is waking from slumber
And rending his fetters at last.
From the dust where his proud tyrants
bound him,

Unhonored and scorned and betrayed,
He shall rise with the sunset around him
And rule in the realm he has made.

WHAT I LIVE FOR.

I live for those who love me,
Whose hearts are kind and true,
For the heaven that smiles above me,
And awaits my spirit, too;
For all human ties that bind me,
For the task by God assigned me,
For the bright hopes left behind me,
And the good that I can do.

I live to learn their story,
Who suffered for my sake,
To emulate their glory,
And follow in their wake;
Bards, patriots, martyrs, sages,
The noble of all ages,
Whose deeds crown history's pages,
And time's great volume make.

I live to hold communion
With all that is divine,
To feel there is a union
'Twixt nature's heart and mine;
To profit by affliction,
Reap truths from fields of fiction,
Grow wiser from conviction,
And fulfill each grand design.

I live to hail that season
By gifted minds foretold.
When men shall live by reason,
And not alone by gold;
When man to man united,
And every wrong thing righted,
The whole world shall be lighted
As Eden was of old.

I live for those who love me,
For those who know me true.
For the heaven that smiles above me,
And awaits my spirit, too;
For the cause that lacks assistance,
For the wrong that needs resistance,
For the future in the distance,
And the good that I can do.

—G. Linnaeus Banks.

In Memoriam

MEMBERS.

William Messersmith, Reg. No. 8638, age 39 years, 2 months, 5 days, of lodge No. 161, Boone, Iowa, born McComb, Ill., March 21, 1876; died May 26, 1915, from nervous breakdown. Married; leaves two daughters of tender age. Length of membership, three years in Local No. 161.

Charles Galvan, Reg. No. 99205, age 52, of Lodge No. 37, New Orleans, La., was born in New Orleans, 1862; died of complicated disease. Married, leaving two children. Member since October, 1914.

RELATIVES OF MEMBERS.

Catharine Norton, age 45, wife of Brother Dan Norton of Lodge No. 227, was born in

Chicago, Ill., October 13, 1870; died May 13, 1915, of pneumonia.

Charles Ottman, age 65, was father of Brother Joseph Ottman of Lodge No. 37, was born in Holland, August 17, 1850; died April 9, 1915, of heart trouble.

James McGowan, age 21 years, was son of Brother A. McGowan of Lodge No. 37; was born in New Orleans, La., 1893; died March 28, 1915, from blood poison.

Jack McGrevy, age 41, brother of Brother William McGrevy of Lodge No. 587, was born in Mason City, Ill.; died May 27, 1915, from tuberculosis.

Lodge Notices

D. J. Fitzgibbons et al.—Lodge No. 99.
Any secretary taking up the card of D. J. Fitzgibbons, Reg. No. 67599, or F. G. Hayes, Reg. No. 21882, will please correspond with the secretary of Lodge No. 99, Newark, Ohio, as these brothers borrowed money from this local which they forgot to return.
CECIL C. ROBERTS,
Secretary Lodge No. 99.

William Varney—Lodge No. 80.
Any secretary taking up the card of Brother William Varney, Reg. No. 57786, will please hold same and correspond with Local No. 80, Anaconda, Mont.
JAMES W. HOGAN,
Corresponding Secretary Lodge No. 80.

Robert Canton—Lodge No. 384.
Anyone knowing the whereabouts of Robert Canton, boiler maker's helper, will please notify the secretary of Lodge No. 384, as this brother left this lodge without paying his bills that the lodge went good for.
H. W. JOHNSON,
Secretary Lodge No. 384.

W. C. Shrout—Lodge No. 82.
Any secretary taking up the card of Brother W. C. Shrout, Reg. No. 52553, will please hold same and correspond with the secretary of Lodge No. 82, Osawatimie, Kas., as this brother left this lodge owing a \$9 board bill to Mrs. G. H. Troxell.
A. G. EVERETT,
Secretary Lodge No. 82.

Shrout—Lodge No. 521.
Any secretary taking up the card of Brother W. C. Shrout, Reg. No. 52553, will please hold same and correspond with secretary of Lodge No. 521, as this brother misrepresented facts to secure transportation from Van Buren, Ark., to Coffeyville, Kas., amounting to \$4.95, and Local No. 521 had to pay same.
OTTY PYLES,
Corresponding Secretary Lodge No. 521.

Douglas et al.—Lodge No. 587.
Lodge No. 587 has suspended M. E. Douglas, Reg. No. 100307, for non-payment of dues. We have also bills aggregating to \$80 against this brother. P. A. Kerr, Reg. No. 91305, also suspended for non-payment of dues and assessments. All locals look out for them.
T. C. MADDY,
Secretary and Treasurer Lodge No. 587.

Shrout—Lodge No. 32.
Any secretary taking up the card of Brother W. C. Shrout, Reg. No. 52553, or the brother himself should he see this, please write to secretary of Local No. 32, Kansas City, Mo.
WALTER E. DWYER,
Secretary Lodge No. 32.

Lost Due Book—Lercher.

Brother Frank Lercher, Reg. No. 98830, has been granted a withdrawal card from Lodge 568, dated March 27, 1914. Said withdrawal card, with his due book, has been lost. Anyone finding this due book and card will kindly forward to this office.
F. P. REINEMEYER,
International Secretary-Treasurer.

Milarn—Lodge No. 447.

Will Brother J. R. Milarn, Reg. No. 63402, please correspond with the secretary of Lodge No. 447, or anyone knowing his whereabouts please notify No. 447?
CHAS. J. YOUNGER,
Secretary Lodge No. 447.

Duson—Tornice.

Anyone knowing the whereabouts of Frank Duson, boiler maker, will please notify Theo. Tornice, Soldiers' Home, Danville, Ill., or William J. Irwin, Corresponding Secretary Lodge No. 22.

LIST OF MEMBERS PREVIOUSLY ADVERTISED

Stewart et al.—Lodge No. 66.

Any secretary taking up the card of Edgar Stewart, Reg. No. 21232, or Noble C. Townsen, Reg. No. 62088, will please correspond with the secretary of No. 66, Little Rock, Ark., as these brothers misrepresented facts and secured transportation out of Little Rock and Lodge No. 56 had to pay for same.
E. WORTHSMITH,

Corresponding Secretary Lodge No. 66.
March Journal.

E. L. Chafin—Lodge No. 587.

We have suspended Brother E. L. Chafin for not paying dues or honest debts. I, myself, loaned this brother some money to bury his little child, and he will not pay it back. He also owes several bills that he won't pay.
C. C. MADDY,

Corresponding Secretary Lodge No. 587.
April Journal.

W. M. Horstmeyer—Lodge No. 381.

Any secretary taking up the card of Brother W. M. Horstmeyer, Reg. No. 9735, please hold same and correspond with Joe Wilson, secretary Lodge No. 381, Amarillo, Tex., as this brother borrowed some money from this lodge which he has forgotten to return.
JOE WILSON,

April Journal. Lodge No. 381.

Thompson—Lodge No. 587.

F. W. Thompson, Reg. No. 20987, has been suspended by this local for non-payment of dues; he also owes about \$40 here.

T. C. MADDY,
June Journal. Secretary Lodge No. 587.

Cooper et al.—Lodge No. 491.

The following names are brothers who left Lodge No. 491 with bills unpaid: C. E. Cooper, boiler maker; bill to F. C. Krull

& Co., for clothing, \$12.35. A. J. Conelly, bill to F. C. Krull & Co., for clothing, \$3.95. John Peters, Reg. No. 80223, to F. C. Krull & Co., for clothing, \$5.50. Joseph Regan, Reg. No. 95180, F. C. Krull & Co., for clothing, \$2.40, and board and room to Sutton Sisters, \$8.83; total, \$11.23. J. M. Morgan, Reg. No. 91068, borrowed money from Local No. 491, \$2.50. Helpers: W. J. Mills, Reg. No. 98504, withdrawal card out of Local No. 145, owes F. C. Krull & Co. for clothing, \$6.40. C. A. Riley, debtor to F. C. Krull & Co., for clothing, \$4.25.

J. J. CARROLL,
Secretary No. 491.
June Journal.

C. S. Burk—Lodge No. 82.

Any secretary taking up card of Brother C. S. Burk, Reg. No. 102470, will please hold same and correspond with secretary of Lodge No. 82, as this brother misrepresented facts to secure transportation to Kansas City, amounting to \$1.25, and we had to pay this bill out of the treasury of the local.

A. G. EVERETT,
Secretary Lodge No. 82.

June Journal.

Trials and Fines

Notice of Correction and Apology of Richard Leahy, Secretary of Local No. 592.

Through an error, Brother W. L. Amrhein, Reg. No. 98515, was published as a scab. This is not true and was caused by me in misinterpreting a name of a member who is scabbing, and I am asking those brothers who read his name in the June Journal to please tell those whom you told he was a scab that he is and has been true and will continue so. I realize that I have wronged this brother grievously, and although he has already accepted my apology and holds no enmity, it will require a great deal of explaining to right this mistake of mine; so you members of Baton Rouge, Port Arthur, Beaumont and Fort Worth who have read or heard that this brother went wrong will know that it is the fault of the secretary of Local No. 592, and I sincerely hope that there is no repetition of such a grievous blunder.

Very regretfully yours,

RICHARD LEAHY,
Corresponding Secretary Lodge No. 592.

E. A. Grimes—Lodge No. 495.

This is to certify that E. A. Grimes, Reg. No. 96087, has been tried by Lodge No. 495 and found guilty by Lodge No. 495, Hattiesburg, Miss., of obtaining membership in this Brotherhood through fraud, and card is revoked.

C. E. DICEY,
President.

A. H. WADDELL,
Corresponding Secretary Lodge No. 495.

Mitchel et al.—Lodge No. 37.

This is to certify that the following members were tried by Lodge No. 37 and found

guilty of scabbing as riveters at Avondale, La., May 12, 1915, and were fined \$150 by Lodge No. 37, New Orleans, La.:

John Mitchel, Reg. No. 96819; Ike Bejerskey, Reg. No. 102006; J. J. Maise, Reg. No. 100198.

WILLIAM J. SMITH,
President.

LEWIS J. COSTELLA,
Corresponding Secretary Lodge No. 37.

This is to certify that Gus Wink, age 34, Lodge No. 39, Reg. No. 26962, has been tried by Lodge No. 39 and found guilty of violating the laws of the Brotherhood by working on unfair work at Gary, Ind., for John Mohr & Sons as boiler maker, and is subject to a fine of \$100 and 99 years' suspension, and is not entitled to recognition in any way from the officers or members of this Brotherhood until such judgments are satisfied.

FRANK BECTON, President.
JOHN COGHLAN.

Belinski et al.—Lodge No. 592.

This is to certify that the following members of Lodge No. 592 were tried by that lodge for violating the laws of the Brotherhood by working on unfair work as boiler makers and helpers in the oil fields of Oklahoma, June 15, 1915, and were each fined one thousand dollars and suspended for fifty years:

Frank S. Belinski, Reg. No. 88571; John D. Brothers, Reg. No. 100682; F. E. Buckley, Reg. No. 102977; C. A. Campbell, Reg. No. 96652; H. Cling, Reg. No. 90571; James Clemmons, Reg. No. 89861; J. M. Dunn, Reg. No. 100317; Leonard East, Reg. No. 64522; Ernest Edwards, Reg. No. 99880; J. Guy Fain, Reg. No. 97030; O. S. Fain, Reg. No. 100339; R. T. Garner, Reg. No. 100324; S. L. Griffin, Reg. No. 100332; William Grubbs, Reg. No. 90808; Cole B. Horner, Reg. No. 100312; Thomas F. Horner, Reg. No. 101349; William J. Hill, Reg. No. 101722; B. F. Holt (Wild Bill), Reg. No. 101228; E. O. Hamilton, Reg. No. 70250 (C. C. from No. 592 in pocket); Ed James, Reg. No. 100687; Harry Kirheart, Reg. No. 101921; Harry Kane, Reg. No. 58103 (White Kane of Chicago); Frank Killian, Reg. No. 100835; John Lyons, Reg. No. 96110; Frank McMullen, Reg. No. 78596; Mack McGee, Reg. No. 99098; W. T. Rogers, Reg. No. 65765; Robert L. Rutherford, Reg. No. 88912; Cleve Rutherford, Reg. No. 65135; Ben Turley, Reg. No. 87705; Sherman Turley, Reg. No. 97032; Ralph Cook, Reg. No. 101672; Jim Harmon, Reg. No. 100164; Joe Stout, Reg. No. 101720; Mack Miller, Reg. No. 89154 (two men of this name); T. W. McNames, Reg. No. 95967; Willard Ellis, Reg. No. 96258.

This is an additional list of members of Local No. 592 who are scabbing on unfair jobs in this vicinity and hope you will have them published in the next issue of the Journal.

ED. L. CLAY,
President.

RICHARD LEAHY,
Corresponding Secretary Lodge No. 592.

OFFICIAL ROSTER--International Officers

J. A. FRANKLIN.....International President
Room 15, Law Bldg., 721 Minnesota Ave., Kansas City, Kas.

F. P. REINEMEYER.....Int. Secretary-Treasurer
Rooms 10 to 12 Law Bldg., 721 Minnesota Ave., Kansas City, Kas.

JAMES B. CASEY.....Editor-Manager of Journal
Room 9, Law Bldg., Kansas City, Kas.

A. HINZMAN.....First Int. Vice-President
Room 15, Law Bldg., 721 Minnesota Ave., Kansas City, Kas.

MISSOURI AND MISSISSIPPI SECTION.
States of Iowa, Missouri, Kansas, Nebraska, Arkansas, Mississippi, Alab a (other than Mobile), Tennessee, North and South Dakota, Oklahoma and Minnesota.

THOS. NOLAN.....Second Int. Vice-President
700 Court St., Portsmouth, Va.

GULF AND SOUTH ATLANTIC SECTION.
States of Texas, Louisiana, Florida, Georgia, North and South Carolina, Virginia, Maryland and Delaware, and Mobile, Ala.

J. P. MERRIGAN.....Third Int. Vice-President
91 Manufacturer St., Montreal, Que., Can.

CANADIAN SECTION.
The Dominion of Canada.

LOUIS WEYAND.....Fourth Int. Vice-President
8201 Fir Avenue, N. W., Cleveland, Ohio.

GREAT LAKES AND TERRITORY SECTION.
States of Wisconsin, Michigan, Cities of Chicago, Toledo, Cleveland and Lorain, O., Erie, Pa., State of New York (other than the City of New York).

WM. ATKINSON.....Fifth Int. Vice-President
212 South Pittsburg St., Spokane, Wash.

ROCKY MOUNTAIN AND PACIFIC COAST SECTION.

Honolulu, States of California, Oregon, Washington, Idaho, Utah, Nevada, Montana, Wyoming, Colorado, Arizona, Old Mexico, New Mexico and Canal Zone, Panama.

JOHN J. DOWD.....Sixth Int. Vice-President
133 Wegman Place, Jersey City, N. J.

EASTERN SEABOARD SECTION.

States of Maine, New Hampshire, Vermont, Massachusetts, Rhode Island, Connecticut, New Jersey and New York City.

M. A. MAHER.....Seventh Int. Vice-President
2114 Eighteenth St., Portsmouth, Ohio.

OHIO VALLEY AND TERRITORY SECTION.
States of Pennsylvania (other than the city of Erie), Ohio, West Virginia, Kentucky, Indiana and Illinois (other than the City of Chicago).

JOS. P. BYAN.....Eighth Int. Vice-President
5830 Wentworth Ave., Chicago, Ill.

HELPERS' VICE-PRESIDENT OF WESTERN SECTION.

All states west of dividing line between Indiana and Ohio.

JOHN F. SCHMITT.....Ninth Int. Vice-President
1489 N. Fourth St., Columbus, Ohio.

HELPERS' VICE-PRESIDENT OF EASTERN SECTION.

All states east of dividing line between Indiana and Ohio.

District Lodges and Officers

DISTRICT No. 2--New York.
N. Y. Meets 1st and 3rd Wed.
Patrick T. Kenneally, President, 9 Magnolia Ave., Jersey City, N. J.

Wm. Brown, Vice-Pres., Elizabeth Ave., Elizabeth, N. J.

Gerald A. Daly, Sec.-Treas., 676 60th St., Brooklyn, N. Y.

DISTRICT No. 5--St. Louis, Mo.
Mo. Pac. and Iron Mountain R. Lodges represented: 32, 38, 44, 66, 82, 106, 113, 117, 286, 322, 403, 507, 521, 542, 543, 565, 583 and 599.

John C. Morrow, Pres., 613 W. 4th St., Coffeyville, Kas.

Hal. Stack, Vice-Pres., Van Buren, Ark.

John J. Murphy, Secy., 3404 Eads Ave., St. Louis, Mo.

J. N. Shirley, Treas., Box 495, Holsington, Kans.

A. E. Stewart, Member Ex. Board, 2533 Myrtle Ave., Kansas City, Mo.

A. J. Radford, Member Ex. Board, 624 Oak St., Little Rock, Ark.

Chas. A. McDonald, B. A., 4416 Norledge Ave., Kansas City, Mo.

DISTRICT No. 6--Southern Pacific R.R. Lodges represented: 32, 33, 46, 48, 52, 74, 92, 49, 98, 101, 113, 179, 193, 206, 216, 223, 239, 252, 309, 345, 339, 538, 563, 169.

S. T. Feazelle, Sec.-Treas., Gate City Hotel, Pocatello, Idaho.

DISTRICT No. 10--Davenport, Ia.
Rock Island System. Lodges represented: 377, 144, 346, 199, 340, 293, 323, 434, 439, 491, 96, 32, 66, 476, 522, 523.

Geo. W. Prink, Pres. & B. A., 677 38th St., Des Moines, Ia.

John Mitchell, V.-P., 1502 McGowan St., Little Rock, Ark.

S. T. Sample, C. & F. S., 515 N. Jackson St., Pratt, Kas.

J. J. Lynch, Treas., Box 655, Her- rington, Kas.

DISTRICT No. 12--New York.
New York Central System. Lodges represented: 5, 7, 10, 64, 67, 85, 150, 157, 169, 175, 197, 218, 223, 229, 321, 413, 492.

A. M. Anderson, Pres., 2208 Francis St., Jackson, Mich.

G. H. Gates, Vice-Pres., 148 N. Orchard St., Watertown, N. Y.

J. J. Leamy, Sec.-Treas., 68 Livingston Ave., Albany, N. Y.

Trustees--Wm. Weber, E. J. McNamara and Thomas Ranger.

DISTRICT No. 13--Birmingham, Ala.
Southern R. R. System. Organized Feb. 23, 1904. Lodges represented: 2, 4, 12, 14, 40, 50, 28, 106, 143, 170, 226, 235, 312, 320, 334, 344, 369, 419, 511, 524; H. D., 27, 111, 175, 240.

Thos. J. Garvey, Pres., 414 E. Byrd St., Richmond, Va.

A. E. Barksdale, V.-P., 543 E. Lafayette St., Jackson, Tenn.

P. E. Berney, Sec.-Treas., R. F. D. 12, Knoxville, Tenn.

DISTRICT No. 15--Chicago, Ill.
C. & N. W. R. R. Lodges represented: 38, 60, 129, 145, 161, 201, 227, 311, 395, 440, 485, 496, 539, 597.

W. F. Scholes, Pres., 1929 Ave., B., Council Bluffs, Ia.

J. W. Francis, V.-P., 584 Springfield Ave., Chicago, Ill.

T. E. Burdette, Sec.-Treas., 428 North Chesnut Ave., Green Bay, Wis.

DISTRICT No. 19--Roanoke, Va.
Norfolk & Western System. Lodges represented: 28, 402, 30, 405, 557. Meets Union Labor Hall.

C. D. Craft, Pres., 1402 Center St., Portsmouth, O.

M. F. Glenn, V.-P., 1414 McConnell Ave., Portsmouth, Ohio.

J. B. O'Brien, Treas., Roanoke, Va.

E. J. Horgan, C. & F. S., 404 7th Ave., S. E., Roanoke, Va.

DISTRICT No. 20--Ill. Cent. R.
R. Headquarters, Chicago, Ill.

Lodges represented: 56, 88, 133, 137, 40, 224, 426, 180, 220, 234, 300, 315, 363, 399, 95; H. D., 97, 106, 116, 102, 230, 174, 232, 223.

K. H. Eicker, Pres., 315 Dane St., Waterloo, Ia.

W. T. McCoid, V. P., 412 Madison St., Clinton, Ill.

E. G. Pullen, C. S. & Treas., 303 Columbia St., Waterloo, Ia.

DISTRICT No. 22--D. R. G. System, Colorado and Utah. Meeting place, Denver, Colorado; Date meeting, 2d Monday in July, 1915; Lodges represented: 44, 103, 179, 335, 427, 446, 473.

Geo. S. Warden, Pres., & B. A. 1507 E. 7th St., Pueblo, Colo.

H. F. Jones, Vice-Pres., 135 Sackett Ave., Salida, Colo.

A. A. Duncan, Sec.-Treas., Box 611, Alamosa, Colo.

DISTRICT No. 23--Meets at St. Louis, Mo., 2d Monday in October, 1914. Lodges represented: 4, 22, 27, 70, 95, 96, 180, 286, 418, 449, 458, 530, 531, 543, 546, 565, 575.

A. F. Bingham, Pres. and B. A., 701 Lombart St., Springfield, Mo.

L. W. Lawson, V.-P., 821 N. Maxey St., Sherman, Texas.

J. W. Reddick, Financial and Recording Secretary, 817 Lincoln St., Springfield, Mo.

A. A. Denton, Cor. Sec. and Treas., 1044 W. Mt. Vernon St., Springfield, Mo.

DISTRICT No. 24--Springfield, Ill. Wabash System. Lodges represented: 54, 81, 267, 384, 581, 594.

Edward F. Siebold, Pres., 1130 St. Mary's Ave., Ft. Wayne, Ind.

Wm. F. Furrow, Vice-Pres., 1017 E. Eldorado St., Decatur, Ill.

F. R. Lee, Secy.-Treas., 601 Monroe Ave., Moberly, Mo.

DISTRICT No. 25--Livingston, Mont. Northern Pac. R. R.
J. G. Brown, Pres., 610 N. 9th St., Brainerd, Minn.

Frank Depender, V.-P., 735 E. Nora Ave., Spokane, Wash.

Theo. W. Everett, Sec.-Treas., P. O. Box 554, Livingston, Mont.

- Trustees—A. H. Shanks, 221 N. 2nd St., Missoula, Mont.; Hugh Roberts, Gen. Del., Glendive, Mont.; G. M. Owens, 312 So. E. St., Livingston, Mont.
- DISTRICT No. 26—Aberden, S. D.** C. M. & St. P. and Puget Sound R. Rs. Lodges represented: 11, 15, 32, 38, 41, 104, 244, 302, 485, 520, 528, 568, 588, 595, 603, 606.
- G. H. Hawksworth, Pres., Box 817, Deer Lodge, Mont.
- F. J. O'Brien, Vice-Pres., Avery, Idaho.
- Ed. McSperritt, Secy., Gen. Del., Miles City, Mont.
- P. W. Gunn, Treas., 3316-30 Ave. South, Minneapolis, Minn.
- J. L. Callahan, B. A., 3606 Clifton St., Milwaukee, Wis.
- DISTRICT No. 27—Int. G. N. R.** R. W. O. Faulk, Pres., Palestine, Tex.
- W. K. Saddler, Vice-Pres., Mart, Texas.
- E. H. Frick, Sec.-Treas., San Antonio, Tex.
- W. B. Graham, B. A., Palestine, Tex.
- DISTRICT No. 29—Cincinnati, O.** C. H. & D. R. R.
- W. J. Redmond, Pres., 204 N. Wash. St., Indianapolis, Ind.
- A. R. Griesheimer, Vice-Pres., 329 N. Elizabeth, Lima, O.
- Wm. J. McGee, Jr., Sec.-Treas., 1255 Richmond St., Cincinnati, O.
- DISTRICT No. 30—Canadian Pacific.** District Headquarters, Winnipeg, Man. Lodges in affiliation: 126, 134, 194, 379, 392, 451, 466, 478, 505, 529, 548, 417.
- Geo. F. Chadburn, Pres. and Acting Sec.-Treas., 1585 Alexander St., Winnipeg, Man.
- J. B. Smith, V.-P., 162 Annette St., Toronto, Ont.
- R. Carswell, V.-P., 684 Home St., Winnipeg, Man.
- DISTRICT No. 31—Cincinnati, O.** B. & O. System. Lodges represented: 5, 10, 79, 99, 105, 135, 241, 259, 318, 326, 332, 444, 493, 498, 514, 579, 578.
- J. C. Smith, Pres., Box 292, Garrett, Ind.
- J. R. Cline, Vice-Pres., Cleveland, O.
- M. W. Luke, Sec.-Treas., 1007 W. Main., Washington, Ind.
- DISTRICT No. 33—Grand Rapids, Mich.** Pere Marquette System. Lodges represented: 34, 124, 413.
- DISTRICT No. 34—Boston, Mass.** Boston & Maine System. Lodges represented: 245, 371, 388, 481, 515, 517. Meets at Boston, Mass., 1st Monday in August and 2d Monday in February.
- W. H. Wells, Pres., 108 Westford St., Lowell, Mass.
- P. J. Kelley, Vice-Pres., 3 Devon St., Greenfield, Mass.
- T. J. Donahue, Sec.-Treas., 5 Fernald St., Lowell, Mass.
- DISTRICT No. 35—Parsons, Kas.** M., K. & T. R. R. System. Lodges represented: 292, 209, 501, 576 and 265.
- Fred Alsdorf, Pres. & B. A., 515 W. Owings St., Denison, Tex.
- C. Dudding, V.-Pres., 2229 Crawford St., Parsons, Kas.
- Robt. Rosbottom, Sec.-Treas., 600 W. Texas St., Denison, Tex.
- C. A. Denton, Rec. Sec., Parsons, Kas.
- Wm. Dickerson, Chairman Trustees, 810 Cleveland St., Waco, Tex.
- DISTRICT No. 37—Texarkana, Tex.** Cotton Belt R. R. System. Meets 3d Saturdays in January and July.
- R. M. Cummins, Pres. & B. A., 308 E. Valentine St., Tyler, Tex.
- John A. Smith, V.-P., 1908 E. 8th St., Pine Bluff, Ark.
- B. E. Shields, Sec.-Treas., 1503 E. 7th Ave., Pine Bluff, Ark.
- DISTRICT No. 38—Atlantic Coast Line.** Lodges represented: 20, 26, 239, 422, 425, 448, 570.
- A. J. Dixon, Pres., Rocky Mount, N. C.
- W. A. Cahill, Vice-Pres., Montgomery, Ala.
- E. S. Ryan, Sec.-Treas., 508 Lackawana Ave., Jacksonville, Fla.
- DISTRICT No. 39—Central of Georgia System.** Meets 1st Friday after Thanksgiving each year at Columbus, Ga. Lodges represented: 4, 12, 26, 436, 510.
- R. J. Black, Pres., 913 2nd St., Macon, Ga.
- J. J. Dean, Vice-Pres., 226 Taylor St., Savannah, Ga.
- Chas. A. Buchhell, Sec.-Treas., 103 Gordon W., Savannah, Ga.
- E. M. Kendrick, Rec. Sec., Route 5, Cedartown, Ga.
- R. S. Barry, Cor. and Fin. Sec., 1109 5th Ave., Columbus, Ga.
- DISTRICT No. 40—Hamlet, N. C.** Seaboard Airline and leased lines. Lodges represented: 2, 20, 26, 173, 298.
- B. M. Jewell, Pres., 727 W. Monroe St., Jacksonville, Fla.
- J. F. Brice, Vice-Pres., 204 Whitehall St., Atlanta, Ga.
- E. C. Howle, Secy-Treas., 1119 E. 32nd St., Savannah, Ga.
- DISTRICT No. 41—Hinton, W. Va.** Chesapeake & Ohio System. Lodges represented: 170, 238, 249, 364, 384, 525.
- R. L. King, Pres., 822 N. Twenty-sixth St., Richmond, Va.
- L. F. Moatz, Vice-Pres., 159 W. Third St., Peru, Ind.
- C. L. Barnett, Sec.-Treas., 419 Summers St., Hinton, W. Va.
- Trustees—M. L. Steinbuck, Box 336, Clifton Forge, Va. D. C. Dowdy, 2046 7th Ave., Huntington, W. Va., A. J. Poke, 1817 Scott Ave., Covington, Ky.
- DISTRICT No. 42—Danville, Ill.** Chicago & Eastern Illinois R. R. Meets 1st Tues. in Feb., 1916. Lodges represented: 22, 95, 575.
- G. D. Davis, Pres. and B. A., 18 N. Hazel St., Danville, Ill.
- James E. Keenan, V.-P., 1006 E. Madison St., Danville, Ill.
- Otice Henthorn, R. & F. S., 102 Iowa St., Danville, Ill.
- A. Welch, Cor. Sec. & Treas., Villa Grove, Ill.

Subordinate Lodges and Officers

- 1—CHICAGO, ILL.** 2d-4th Wed., Bricklayers' Hall, Monroe and Peoria Sts.
- James McKiernan, Pres.
- John E. Burke, C. & F. S., 3009 Archer Ave.
- John Dohney, 8123 So. Peoria.
- Frank Condon, B. A., 912 Monroe.
- 2—ATLANTA, GA.** 2d-4th Thurs.
- A. D. Lundbon, Pres., 224 E. Fair.
- John Fitcher, C. S., 406 Pullian.
- 3—ST. PAUL, MINN.** 1st-3d Fri., New Odd Fellows' Home, 9th and Franklin.
- Geo. Cox, Pres., 1746 Logan.
- Wm. Harrington, F. S., 695 Pine.
- Wm. Parranto, B. A., 400 E. Jenks.
- 4—BIRMINGHAM, ALA.** 1st-3d Tues., K. of C. Hall.
- Fred Baker, Pres., 2021½ 3d Ave.
- A. L. Carmack, F. S. & B. A., Office: 335 Hood Bldg.
- 5—CLEVELAND, OHIO.** 1st-3d Thurs., Room 3, Federation Hall, 310 Prospect.
- Chas. Tongreen, Pres., Superior.
- G. H. Brady, C. S. & B. A., 310 Prospect.
- 7—BUFFALO, N. Y.** 2d-4th Fri., Council Hall, 33 E. Warren.
- Geo. F. Muir, Pres., 116 Goodell.
- Thos. J. King, C. S., 1943 Seneca.
- Frank P. O'Brien, F. S., 238 Schiller.
- 8—COLUMBUS, O.** Meets 2d-4th Thurs., F. of L. Hall.
- Chas. L. Nicklaus, Pres., 473 Poplar Ave.
- Adam Ruckel, C. S., 267 Liebert.
- 10—INDIANAPOLIS, IND.** 2d-4th Thurs., Labor Temple, 138 W. Washington St.
- E. P. Leopard, Pres., 206 N. Tremont Ave.
- Wm. Frohlinger, C. S., 542 East Louisiana St.
- L. E. Hirsch, F. S., 851 Ashland Ave.
- 11—MINNEAPOLIS, MINN.** 2d-4th Mon., Richmond Hall, 223 5th St.
- H. P. Farly, Pres., 1356 Vine Place.
- E. A. Conlin, C. S., 2404 Bloomington Ave.
- 12—MACON, GA.** 2d-4th Friday, Morgan's Hall, cor. Elm and Broadway.
- J. T. Fenlon, Pres., 1974 Third St.
- R. J. Black, C. & F. S., 913 2d.
- 14—CHATTANOOGA, TENN.** Central Labor Hall, 8th and Cherrie Sts., 2d-4th Mon.
- Wm. Quigley, Pres.
- Jas. E. Evans, C. & F. S., 19 Jefferson.
- 15—DUBUQUE, IOWA.** 1st-3d Tues., Union Hall, 19th and White Sts.
- E. Keck, Pres., 1272 Lincoln Ave.
- R. Ruof, C. & F. S., 975 Clay St.
- 16—JERSEY CITY, N. J.** 1st-3d Mon., Fischer's Hall, Newark Ave., cor. Erie St.
- Patrick J. Kennally, Pres., 209 Magnolia Ave.
- Hugh Fitzpatrick, C. S., 244 York.
- Ed. McCarthy, B. A.
- 19—PHILADELPHIA, PA.** 2d-4th Fridays, Bricklayers' Hall, Broad and Fairmount Ave.
- Frank Goodfellow, Pres., 159 W. Palmer St.
- R. S. Hopkins, C. S., 2426 S. Clarion.
- 20—JACKSONVILLE, FLA.** Meets every Tuesday, Central Labor Hall, 46½ W. Bay.
- E. F. Ketchey, Pres., 841 W. Monroe.
- E. S. Ryan, C. & F. S., 603 Park.
- 21—NEW YORK, N. Y.** 1st-3d Mon.
- John H. Sullivan, Pres., 607 W. 46th St.
- James McGeney, C. S., 295 Livingston St., Brooklyn, N. Y.
- Thomas Smith, F. S., 692 Henry St., Brooklyn, N. Y.
- 22—DANVILLE, ILL.** 1st-3d Mon., Trades and Labor Hall.
- Ray Schenk, Pres., California St.
- Wm. J. Irwin, C. S., 7 Illinois.
- Frank Jergens, F. S., 418 N. Bowman Ave.
- G. D. Davis, B. A., 18 N. Hazel.
- 25—SAN FRANCISCO, CALIF.** Roesch Hall, 15th and Mission Sts., 2d-4th Thurs.
- John Kane, Pres., 41 Collingwood.
- Thos. J. Sheridan, C. S. & Treas., 2312 24th St.
- Wm. P. Bowser, B. A., 314 14th.
- 26—SAVANNAH, GA.** 1st-3d Tues., Whittaker St. and Liberty Lane.
- E. C. Howle, Pres., 1110 E. 32d St.
- R. B. Allen, C. S., 509 E. 32d St.
- 27—ST. LOUIS, MO.** 2d-4th Thurs., 10th and Carr.
- Larry Kickham, Pres. & B. A., 5322 Vernon Ave.
- James Callahan, C. S., 3408 Laclede Ave.
- Henry Selkmann, F. S., 1908A Madison.

- 29—ROANOKE, VA.** 2d-4th Wed. Labor Home Hall, Commerce and Salem Ave.
G. J. Lucas, Pres., 1121 2d Ave. N. W.
J. R. Anderson, C. S., 502 Campbell Ave.
- 30—ROANOKE, VA.** 2d-4th Mon. Labor Hall, cor. Commerce St. and Salem Ave.
C. E. Eades, Pres., 318 7th Ave. N. E.
B. I. Wade, C. S., 811 Jamison Ave.
- 31—ST. JOSEPH, MO.** 2d-4th Mon., Jucker Hall.
B. E. Stitts, Pres., 2228 So. 6th. Edward Knight, C. S., 2119 So. 9th St.
- 32—KANSAS CITY, MO.** 2d-4th Fri., Labor Temple, 14th and Woodland.
Chas. Lackenby, Pres., 2022 Bell-ville.
W. E. Dwyer, C. & F. S., 115 N. Elmwood.
Chas. McDonald, B. A., 4416 Norledge.
- 37—NEW ORLEANS, LA.** 2d-4th Wed., Martin's Hall, Iberville & Exchange Place.
Wm. J. Smith, Pres. & B. A., 228 Morgan St., Algiers, La.
Lewis J. Costella, C. S., 312 S. Dupre.
Victor Escasse, F. S., 617 Allix St., Algiers, La.
- 38—OMAHA, NEB.** 1st-3d Wed. Blairlight Hall, 19th & Farnum.
M. J. McGovern, Pres., 1617 Burt.
L. G. Rankin, C. S., 2825 Cass.
J. H. Massman, F. C., 1511 Loucut.
- 39—SOUTH CHICAGO, ILL.** 2d-4th Tues., Union Headquarters, 92d St. and Erie Ave., South Chicago.
Frank Eacton, Pres., 10222 Ave. L. John Cogian, C. S. & B. A., 9944 Ave. H.
Joseph Manners, F. S., 10500 Ave. G.
- 40—LOUISVILLE, KY.** 2d-4th Wed., in Beck's Union Hall, 1st and Jefferson Sts.
Thomas Mitchell, Pres., 1422A Broadway.
R. Terrell, C. S., 308 N. 19th St.
F. J. Kiesler, F. S., 212 Collins Court.
- 41—HARLOWTON, MONT.** 2d-4th Thurs., Winer Hall.
John Dennis, Pres.
Verne Scott, C. S., Box 550.
- 42—NASHVILLE, TENN.** 2d-4th Thurs., Carpenters' Hall, 342½ 4th Ave. N.
James B. Keenan, 1006 E. Madison St., Danville, Ill.
H. R. Brown, Pres., 611½ Church.
W. T. Pentecost, C. S., 2143 Oakland Ave.
- 44—PUEBLO, COL.** Every Thurs., New Pope Bldg., Main bet. 3d and 4th Sts.
Walter M. Pitts, Pres., 631 E. 8th St.
Geo. S. Warden, C. & F. S., 1507 E 7th St.
- 45—BROOKLYN, N. Y.** Greenpoint and Manhattan Aves., 2d-4th Thurs.
Gerald A. Daly, Pres. & C. S., 676 60th St.
M. J. Callahan, F. S., 19 Jewell St.
- 46—CHEYENNE, WYO.** Union Hall, 2d-4th Wed.
Geo. R. Wallace, Pres., P. O. Box 151.
Cole, C. S., 215 E. 9th St.
- 47—DES MOINES, IA.** 1st-3d Thurs., Trades Assembly Hall.
James Gillespie, Pres., 1113 Columbus Ave.
Fritz Johnson, C. & F. S., 922 W. 1st St.
- 48—LARAMIE, WYO.** 1st-3d Tues., Moose Hall.
Jacob Claus, Pres., 114 Cedar St.
Frank M. Lepper, C. S., 360 N. 3d St.
- 50—CHARLESTON, S. C.** 1st-3d Tues., Y. M. C. A. Hall, George St.
H. J. Hartnett, Pres., 18 Anson St.
John J. Clair, C. & F. S., 186A Spring St.
- 54—FORT WAYNE, IND.** Last Wed., West Berry St.
Edward F. Siebold, Pres. & C. S., 1130 St. Mary's Ave.
O. F. Ewald, F. S., 1419 S. Calhoun.
- 55—NEWPORT NEWS, VA.** Every Wed., 8 p. m., C. L. U. Hall, 32d and Wash. Ave.
Wm. H. Healy, Pres., 3711 Huntington Ave.
D. McArthur, C. S., 211 27th.
W. Hannah, F. S., P. O. Box 430.
- 57—PORTSMOUTH, VA.** 1st-3d Thurs., C. L. U. Hall.
O. C. Hartung, Pres., 1248 Park Ave.
J. H. Parrish, F. S., 622 Clifford.
Geo. Thomas, C. S., 204 Lincoln.
- 60—PEORIA, ILL.** 1st-3d Mon., 411 Cedar St.
E. L. Thornton, Pres., 213 Faraday.
F. Hierspiel, C. S., 410 Warner Ave.
- 61—NEW HAVEN, CONN.** 1st-3d Thurs., Boardman Bldg., cor. State and Chapel Sts.
Wm. Hefferman, Pres., 95 Carlyle.
M. J. Whalen, C. & F. S., 138 Carlyle.
- 64—JACKSON, MICH.** Every Tues., Labor Hall, Main and Jackson Sts.
Geo. Bones, Pres., 140 Bates.
Ed McNamara, C. S., 619 South Pleasant St.
- 65—VICTORIA, VA.** 2d-4th Sundays, Lunenburg Hall.
J. H. Jones, Pres., Gen. Del.
W. H. Slayton, C. S., Gen. Del.
- 66—LITTLE ROCK, ARK.** 1st-3d Thurs., Brannon Hall, Markham and Cross Sts.
W. J. Flynn, Pres., 908 Denison.
E. Wortsmitth, C. & F. S., 300 W. 11th St., Argenta, Ark.
C. A. McDonald, B. A., 4416 Norledge, Kansas City, Mo.
- 67—BAY CITY, MICH.** 1st-3d Thurs., Central Trades Council Hall.
Wm. H. Benedict, Pres., 703 E. Winona Ave., W. S.
Joe Malton, V.-P., 317 S. Jackson.
Neilson Heglung, C. & F. S., 514 Adams St.
- 68—PINE BLUFF, ARK.**—2d-4th Wed., Labor Temple.
A. J. Barton, Pres., 1701 W 6th.
B. E. Shields, C. S., 622 Nebraska.
J. A. Smith, F. S., 1908 E. 8th.
- 69—LITTLE ROCK, ARK.**
John Mitchell, Pres., 1502 McGowan St.
W. A. Rooksbery, C. & F. S., 1205 W. 34th St.
- 70—SPRINGFIELD, MO.** 2d-4th Wed., Eagles' Home.
A. E. Welch, Pres., 1822 Roberson Ave.
Scott Daffer, C. & F. S., 1235 Broad St.
A. F. Bingham, B. A., 701 Lombard St.
- 72—PORTLAND, ORE.** 2d-4th Thurs., 230½ Yamhill St.
Arthur Gallon, Pres., 649 Milwaukee.
F. E. Disbrow, C. & F. S., 810 E. 11th.
Joe Reed, B. A., 507 Blismark.
- 73—TROY, N. Y.** 2d-4th Mon., Swan and Georgia Sts., Mechanics' Hall.
Huntington Ave.
John Donnelly, Pres., 23 3d St., Cohoes, N. Y.
David Boyd, C. & F. S., 319 9th St., Waterlot, N. Y.
- 74—HOUSTON, TEXAS.** 1st-3d Wed., Woodman Hall, 1823 Washington St.
D. C. Bryan, Pres., 4607 Washington.
F. C. Jackson, C. & F. S., 2119 Lublick St.
- 79—GARRETT, IND.** 1st-3d Tues., K. of P. Hall, Randolph.
Geo. Richmond, Pres., 214 E. Keyser.
J. C. Smith, C. & F. S., Box 282.
- 80—ANACONDA, MONT.** 2d-4th Wed., M. & M. Hall, Lodge Box 372.
J. C. Smith, Pres., 510 Cherry St.
James W. Hogan, C. S., 500 Birch.
- 81—SPRINGFIELD, ILL.** 2d-4th Tues., Fortunes Hall.
Ed Sellers, Pres., 130 E. Edwards.
Louis L. Mutter, C. & F. S., 1621 S. 8th.
- 82—OSAWATOMIE, KAS.** 1st-3d Mon., K. & L. Sec. Hall.
Hurb Fader, Pres.
J. E. Sturgea, C. & F. S., Box 64.
C. A. McDonald, B. A., 4416 Norledge, Kansas City, Mo.
- 83—KANSAS CITY, KAS.** 2d-4th Tues., K. P. Hall, 624 Minp. Av.
Thomas Knowles, Pres., 760 Shawnee.
Frank Stover, C. & F. S., 322 Nebraska Ave.
- 84—GRAND RAPIDS, MICH.** 1st-3d Mon., Trade & Labor Hall, 67 Monroe Ave.
Frank C. Lemke, Pres., 551 Shamrock St.
Neilson M. Warren, C. S., 127 E. Delaware St.
- 85—TOLEDO, OHIO.** 2d-4th Tues., Mitchell's Hall, cor. Walnut and Summit Sts.
J. S. Durst, Pres., 153 Gibbons St.
Ellsworth Richardson, C. S., 137 Western St.
- 86—DALLAS, TEX.** 1st-3d Mon., Broadnax Hall.
W. H. Riley, Pres., 1408 Corinth.
C. B. Stout, C. S., R. R. 10, Box 24.
- 88—JACKSON TENN.** 2d-4th Fri., Labor Hall.
B. E. Seward, Pres.
A. E. Barkdale, C. S., 119 E. Orleans St.
- 90—SUGAR CREEK, MO.** 2d-4th Thurs., Woodman's Hall.
L. Novak, Pres.
C. R. Snider, C. & F. S., 1222 W. Electric St., Independence, Mo.
- 91—ELMWOOD PLACE O.** 1st-3d Mon., Kellers Hall.
Geo. Urban, Pres., St. Bernard. O.
John Cullen, C. S., 39 Prosser Ave.
- 92—LOS ANGELES, CAL.** 2d-4th Wed., Union Labor Temple, 540 Maple Ave.
Wm. Gardiner, Pres., 2207½ E. 2nd.
H. E. Herman, C. & F. S., 529 S. Griffin Ave.
- 93—JOLIET, ILL.** 2d-4th Tues., Conner's Hall.
John Buckley, Pres., 111 Willard Ave.
Richard Farrell, F. S., 503 London Ave.
Charles Mork, C. S., 424 Landen Ave.
- 94—SACRAMENTO, CAL.** 1st-3d Thurs., Labor Temple.
J. Grabfelder, Pres., 3001 G St.
J. S. Heller, Acting C. S., 1317 19th St.
- 95—EVANSVILLE, IND.** 2d-4th Mon., Ruh's Hall.
Chas. T. Mooney, Pres., 1802 Michigan.
Ferman H. Grundman, C. & F. S., 307 Mary St.

- 96—FORT WORTH, TEX.** B. of L. F. & E. Hall, 1st-3d Thurs. J. J. Dempsey, Pres., 504 Calhoun. L. A. Freeman, C. & F. S., 2250 Jennings St.
- 99—NEWARK, OHIO.** Druid's Hall, 22½ S. 3d St., 1st-3d Sun., 9 a. m. Emil Indekofer, Pres., 76 Curtis Ave. Cecil Roberts, C. & F. S., 45½ S. Third St.
- 100—MARSHALL, TEX.** 1st-3d Tues., I. O. O. F. Hall. Smith Hayden, Pres., 514 Greenwood Ave. J. P. O'Neil, C. & F. S., 708 E. Rusk.
- 103—SALT LAKE CITY, UTAH.** Labor Temple, 3d East, bet. 1st and 2d S. St., 1st-3d Wed. Wm. H. Garrick, Pres., 416 Edith Ave. B. S. R. Harrison, C. & F. S., 862 Ouray Ave.
- 104—SEATTLE, WASH.** 1st-3d Thurs., Labor Temple, 6th and University St. Fred Counter, Pres., 2360 15th Ave., So. Dan McKillop, Sec. & B. A., 166½ 10th Ave., Phone Elliott 845W.
- 105—CINCINNATI, OHIO.** 2d-4th Thurs., Workman's Hall, Mercer and Walnut Sts. Chas. Granger, Pres., 329 Union St., Bellevue, Ky. D. L. O'Brien, C. S. & B. A., 23 Forest Ave., Ludlow, Ky. Frank Bareswilt, F. S., 1028 5th Ave., Dayton, Ky.
- 106—McGHEE, ARK.** 2d-4th Wed., K. of P. Hall. Wm. E. Crupper, Pres., Box 215. Chas. A. Stewart, C. & F. S., Box 432.
- 107—MILWAUKEE, WIS.** 1st-3d Tues., Speers Hall, Cor. National & 3d Ave. J. Hoppens, Pres., 1302 Fratney. R. Dale, Fin. Sec., 319 4th Ave. P. Sonnenberg, C. S. & B. A., 623 Greenbush.
- 108—AUGUSTA, GA.** 2d-4th Tues., Machinists' Hall, Broad. Patrick Rice, Pres., 1342 Walton Way. E. E. Bennett, C. S., 1406 Silcox.
- 109—CHADRON, NEB.** J. W. Boyd, Pres. Ed Grady, C. S., Gen. Del.
- 111—MISSOULA, MONT.** 2d-4th Tues., Eagles' Hall. H. A. Chase, Pres., Box 1304. A. Frasier, C. S., R. R. No. 1.
- 113—SEDALIA, MO.** 1st-3d Tues., Labor Temple. Chas. Hall, Pres., Gen. Del. C. A. McDonald, B. A., 4416 Norledge, Kansas City, Mo. W. H. Sims, G. S., 1306 E. 7th St.
- 116—BRAINERD, MINN.** 2d-4th Fri., Trades and Labor Hall. Henry Voight, Pres., E. Oak. Wm. B. Good, C. S., Imperial Block.
- 117—DE SOTO, MO.** 1st-3d Mon., Federation Hall. R. B. Parks, Pres. S. L. Johnson, C. & F. S., Box 248.
- 123—LIVINGSTON, MONT.** 1st-3d Thurs., Trades and Labor Hall. C. D. Cain, Pres., 204 S. K St. Theo. W. Evert, C. & F. S., P. O. Box 554.
- 124—SAGINAW, MICH.** 1st-3d Fri., Petre & Meek's Hall, Geneva Ave. John Doyle, C. & F. S., R. F. D. No. 1.
- 126—WINNIPEG, MAN.** 1st Wed. and 3d Sun., 2:30 o'clock, Labor Temple. Wm. L. Hall, Pres., 1576 Elgin Ave. I. M. Couttie, C. S., 1497 Pacific Ave. A. Cook, F. S., 1233 Slikirk Ave.
- 129—CLINTON, IOWA.** 4th Fri., Labor Temple, 214 15th Ave. Henry L. Weber, Pres., 503 Elm. Henry Qualman, C. & F. S., 231 14th Ave.
- 130—BUTTE, MONT.** 1st-3d Tues., Carpenters' Hall, cor. Granite and Montana Sts. T. F. Shulta, Pres. Harry Goodland, C. & F. S., 177 E. Center.
- 132—GALVESTON, TEX.** 2d Mon., Cooks and Waiters' Hall, 23d St. S. Naudascher, Pres., 3228 Ave. H. El T. Chester, C. & F. S., 3209 Ave. I.
- 133—WATERLOO, IOWA.** Central Labor Hall, 2d-4th Wed. E. G. Pullen, Pres., 502 Columbia St. Geo. A. McMillan, C. S., 703 Barclay St.
- 134—MONTREAL, QUE., CAN.** 1st-3d Fri., Monument National St. Lawrence and Main Sts. Stephen Craig, Pres., 1251 Mosnier. R. Chorlton, C. S., 1184 Delormier Ave.
- 135—CHILLICOTHE, O.** 1st-3d Mon., Plaecker Hall. L. J. Medert, Pres., 516 E. Water. Harry Rittinger, F. C. S., 339 S. Watt.
- 136—COLORADO CITY, COLO.** Red Men's Hall, 1st-3d Fri. H. J. Norton, Pres., care National Hotel. R. D. Wing, C. S., 12 So. 13th, Colorado Springs, Colo. J. H. Cook, F. S., 216 N. 10th.
- 137—PADUCAH, KY.** 2d-4th Sun., Central Labor Hall, 123½ N. 4th. B. C. Beadles, Pres., 1029 Madison. Wm. Black, C. & F. S., 2040 Broad St.
- 138—HARRISON, ARK.** 4th Thurs. H. C. Heppard, Pres. John G. Call, C. & F. S.
- 143—KNOXVILLE, TENN.** 319 N. Gay St., 1st-3d Tues. J. D. Krause, Pres., R. F. D. No. 1. Joe Gallaway, C. S., 1000 Broadway. W. D. Amanns, F. S., R. F. D. No. 12, Lincoln Park.
- 144—CEDAR RAPIDS, IOWA.** 1st-3d Wed., I. O. O. F. Hall, cor. 1st St. and 2nd Ave. W. Chas. T. Bowman, Pres., 816 Ellis Blvd. Frank C. Schwarz, C. & F. S., 830 G Ave., W.
- 145—MISSOURI VALLEY, IOWA.** 1st-3d Thurs., Walker's Hall. Hans Witt, Pres., Box 181. Harvey Nichols, C. S.
- 148—VALLEJO, CALIF.** 1st-3d Tues., Vallejo Temple Hall. Wm. Fountain, Pres., 225A Penn. Harry Duthie, C. & F. S., 638 Capitol.
- 149—MARSHALLTOWN, IOWA.** 1st-3d Tues., Trades and Labor Assembly Hall, Main St. Chas. Vyskocil, Pres., 9 E. Boone. W. E. Pouley, C. S., 1110 W. Cole.
- 150—CHAMPAIGN, ILL.** 1st-3d Sun., 2:30 p. m., I. C. System Fed. Hall. Thos. H. Monahan, Pres., 511 W. Washington St. A. E. Strode, C. S., 325 Hickory.
- 153—GASSAWAY, W. VA.** 20th of each month, Boone's Hall. J. E. Perkins, Pres., Little Otter, W. Va. C. S. Davis, C. & F. S., Gen. Del.
- 154—PITTSBURGH, PA.** 1st-3d Fri., Labor Temple, cor. Washington and Webster Ave. Frank Bann, Pres., 804 South Ave. N. S. Henry J. Thumel, C. & F. S., 1218 Itin St. N. S. James P. Carr, B. A., Labor Temple, Wash. and Webster Ave.
- 155—BLOOMINGTON, ILL.** 1st-3d Mon., Redmen's Hall, Main and Front Sts. H. F. Lambrecht, Pres., 1004 N. Livingston St. L. J. Metzner, C. & F. S., 1207 N. Mason.
- 161—BOONE, IOWA.** 1st-3d Mon., at Electrical Workers' Hall. Frank Whitman, Pres., 1603 Benton. H. W. Martens, C. & F. S., 1329 Meridan St.
- 163—HOBOKEN, N. J.** 2d-4th Fri., 500 Bloomfield St. Jeremiah Cahill, Pres., 38 Troy. P. L. Growney, C. S., 1019 Willow Ave.
- 165—DULUTH, MINN.** 2d-4th Sat., Irwin-Sloan Block, 20th Ave. and Superior St. James A. Graham, Pres., 5705 Grand Ave., W. Duluth, Minn. Alfred S. Nelson, C. & F. S., 5705 Grand Ave., W. Duluth, Minn.
- 169—DETROIT, MICH.** 2d-4th Thurs., 273 Gratiot Ave. Charles Komes, Pres., 31 Celaren. Chas. F. Aderholdt, C. & F. S., 9 Sylvan St.
- 170—RICHMOND, VA.** 1st-3d Wed., Labor Temple, 5th and Marshall Sts. R. L. King, Pres., 822 N. 26th St. F. C. Blount, F. S., 1101 N. 23d. E. M. Daywalt, C. S., 2203 Venable St.
- 173—RALEIGH, N. C.** B. F. Long, Pres., 218 N. McDowell. J. P. Taylor, C. & F. S., 615 W. North.
- 176—ELIZABETH, N. J.** 2d-4th Wed., Dahmen Hall, 4th and E. Jersey St. John H. Reynolds, Pres., 33 Delaware St. Samuel M. Rankin, Secy., 64 Florida. E. J. McCarthy, B. A., 67 St. Mark's Place, New York City.
- 179—DENVER, COLO.** 2d-4th Wed., Room 301 McPhee Bldg., 17th and Glenarm. Geo. Gauss, Pres., 3869 Newton. H. Shaffroth, C. & F. S., 3749 Wynkoop St.
- 180—MEMPHIS, TENN.** Italian Hall, 1st-3d Fri. E. C. Poore, Pres., 735 Arkansas Ave. Edward O'Brien, C. & F. S., 1226 S. Orleans St.
- 187—MIAMI, ARIZ.** Every Tues., Miami Hall. J. W. Landers, Pres. Frank E. Rock, C. & F. S., Box 1121.
- 191—VICTORIA, B. C.** 2d-4th Tues., 1424 Government St. A. Clyde, Pres. Sub. P. O. No. 2. A. Stewart, C. S., Box 48, Beaumont, P. O. Esquimalt, B. C.
- 193—BALTIMORE, MD.** Every Tues., Patterson Bldg., Baltimore and Gav Sts. John Shanley, Pres. James Chaney, F. S., 1419 Patapsica St. Philip Yingling, C. S., 410 F. 27th St.

- 194—VANCOUVER, B. C., CANADA. 1st-3d Mon., at Labor Temple.
A. Campbell, Pres., 17th Ave., West Vancouver.
A. Fraser, C. S., 1151 Howe St.
195—KEWANEE, ILL. 1st-3d Fri., O'Donnell's Hall, 3d St.
A. M. Powers, C. S., 614 Beach.
197—ALBANY, N. Y. 31 Green St., 2d-4th Sat.
J. H. Sullivan, Pres. & B. A., 173 2d St.
Jno. J. Leamy, C. S., 68 Livingstone Ave.
198—OGDEN, UTAH. 2d-3d Tues., Union Labor Hall on 24th St., bet. Washington and Grant.
F. S. Dunn, C. & F. S., 116 23d St.
199—HORTON, KAN. 2d-4th Mon., Carman's Hall.
E. J. McCarty, Pres.
E. S. McGinnis, C. & F. S., Box 622.
200—STATEN ISLAND, N. Y. I. O. G. T. Hall, W. Brighton, S. I., N. Y., 3rd Mon.
Robt. Duthie, Pres., 74 Simonson Ave., Ft. Richmond, S. I., N. Y.
Ethan A. Johnson, C. S., 208 Broadway, W. Brighton S. I., N. Y.
E. McCarty, B. A., 67 St. Mark's Place, N. Y. City.
201—WINONA, MINN. Labor Temple, 1st-3d Tues.
Frank Rice, Pres., 574 W. 7th St.
W. Kukowski, C. S., 178 Mankato Ave.
J. H. Buchholtz, F. S., 251 E. King.
204—HONOLULU, H. I. Waverly Hall, 2d-4th Thurs.
Frank Eaman, Pres., Majestic Hotel.
Wm. H. Lane, C. & F. S., 900C Kanoa Lane.
205—SAN FRANCISCO, CALIF. 2d-4th Tues., Rosch Hall, 15th and Mission.
Wm. P. Bowser, Pres., 507 20th.
J. M. Enright, C. S., 1431 Delores.
Walter Anderson, F. S., 607 Andover.
Wm. P. Bowser, B. A., 314 14th.
206—ALGIERS, LA. 2d-4th Fri., RENEKY Hall.
Jos. Koenig, Pres. & C. S., 825 Elmira Ave.
C. A. Reynolds, F. S., McDonoghville, La.
207—WALNUT SPRINGS, TEX. E. P. Jones, Pres.
C. W. Leigen, C. & F. S.
209—DENISON, TEXAS. 2d-4th Mon., over State Nat. Bank.
A. McDowell, Pres., 504 W. Owings St.
S. E. Harris, C. & F. S., 923 W. Morgan St.
216—EL PASO, TEXAS. 2d-4th Thurs., 215 S. Stanton.
Wm. Beeson, Pres., 807 N. El Paso.
Frank H. Balt, C. S., 215 S. Stanton St.
220—CHICAGO, ILL. 2d-4th Tues., Pusey's Hall, 901 E. 75th.
M. Casey, Pres., 6351 Drexel Ave.
A. G. Smith, C. & F. S., 7036 Harper Ave.
221—PITTSBURG, KAN. 1st-3d Tues., Red Men's Hall, W. 3d St.
E. E. Hiett, Pres., 1803 N. Grand Ave.
P. J. Hiett, C. S., 1801 N. Grand.
222—MART, TEXAS. W. O. W. Hall.
E. J. Blount, Pres.
G. W. Coates, C. & F. S.
223—UTICA, N. Y. Labor Temple, 2d Fri.
Louis Wengert, Pres., 8 Wiley St.
Edward Wengert, C. S., 43 Pass Ave.
225—ELMIRA, N. Y. 2d-4th Sun., Trades & Labor Hall, 200 E. Water St.
A. E. Stevenson, Pres., 964 McGee.
N. P. Durnin, R. & C. S., 519 Penn Ave.
226—SALISBURY, N. C. W. O. W. Hall, Innes and Main Sts., 2d-4th Fri.
J. J. Garvey, Pres., E. Spencer, N. C.
P. P. Sarratt, C. & F. S., Box 278, Spencer, N. C.
227—CHICAGO, ILL. Garfield Park Hall, 4039 W. Madison St. 2d-4th Sat.
John Seidson, Pres., 1107 Keeler Ave.
Thomas Dean, F. & C. S., 2214 W. 13th St.
229—ROCHESTER, N. Y. 2d-4th Wed., 14 N. Water St.
W. Weston, Pres., 17 Coffrey Place.
Robt. Little, C. S., 211 Garfield.
233—OAKLAND, CAL. 2d-4th Mon., cor. 7th and Peralta Sts.
H. Brown, Pres., 1003 Pine St.
Geo. Young, C. S., 1788 9th St.
235—COLUMBIA, S. C. 2d-4th Tues., Plumbers' Hall, 1623 Main St.
J. M. Fricks, Pres., 3403 College St., Colonial Hts.
J. W. Bankhead, C. & F. S., 1727 Laurel Ave.
236—MARQUETTE, MICH. 4th Thurs., E. Seigle's Hall.
Albert Bastien, Pres., 347 West Washington.
Arthur Bourgois, C. S., 817 North 3d St.
237—HARTFORD, CONN. 2d-4th Wed., at C. L. U. Hall, Central Row.
James Thornton, Pres., 52 Green.
John J. Reilly, C. S., 46 Pliny.
238—CLIFTON FORGE, VA. 1st-3d Fri., Junlor Hall.
A. J. Hauer, Pres., 34 Alleghany.
M. L. Steinbuck, C. & R. S., Box 336.
D. G. Clark, F. S., 192 Ridgeway.
239—ROCKY MOUNT, N. C. 1st-3d Mon., Machinist Hall, cor. Sunset and Main Sts.
G. T. Mathews, Jr., Pres., 620 S. Church.
J. S. Wakefield, C. S., Box 224.
H. L. Moore, F. S., 127 Pearl.
241—WASHINGTON, IND. Zinkin's Hall, 3d and Vantrees Sts., 1st-3d Tues.
J. C. Mooney, Pres., East George.
M. W. Luke, C. & F. S., 1097 W. Main.
242—SPOKANE, WASH. 2d-4th Wed., Carpenters' Hall, No. 9 Madison St.
Frank Depender, Pres., 611 E. Indiana Ave.
R. L. Mason, C. S., 212 S. Pittsburg St.
243—BELEFONTAINE, O. Last Sunday in each month, Eagles' Hall.
H. S. Dickenson, Pres., 329 Garfield.
R. E. McNeff, C. & F. S., 105 N. Elm.
244—SIoux CITY, IOWA. 3d Wed., Motor Mart Bldg.
John Ewing, Pres., 103 Alice St.
Robt. O'Hern, C. S., No. 5 14th.
245—CONCORD, N. H. 2d-4th Mon., Central Labor Union Hall.
Geo. Tanner, Pres., Hall St.
J. J. Berryman, C. S., 2 Home Ave.
J. R. New, F. S., 120 Broadway.
246—TERRE HAUTE, IND. Cor. 8th and Wabash Ave., 1st-3d Tues.
H. M. Showalter, Pres., 1410 S. 17th.
Jesse Dukes, C. S., 1561 S. 18th.
F. Wittke, F. S., 1709 N. 12th.
247—TACOMA, WASH. 1st-3d Mon., Odd Fellows' Hall, S. Tacoma.
Andrew Hansen, Pres., 5406 So. Paks St.
Wm. Polzin, C. & F. S., 5814 S. Lawrence St., So. Tacoma, Wash.
249—HUNTINGTON, W. VA. Every Wed., Thompson Bldg., cor. 20th St. and 3d Ave.
J. S. Myers, Pres., 2720 Collis Ave.
Eugene Brennan, C. & F. S., 832 23d St.
A. B. Pring, B. A., 1812 12th Ave.
250—BOSTON, MASS. Hollis Hall, 724 Washington St., 1st-3d Fri.
James Downey, Pres., 8 Cathedral.
Jeremiah Murphy, C. S. & B. A., 107 Union Park St.
J. F. Neas, F. S., 1177A Tremont, Roxbury, Mass.
254—CHICAGO HEIGHTS, ILL. 1st-3d Mon., at Trades & Labor Assembly Hall, West End Ave.
Thomas Hines, Pres., 1656 West End Ave.
Thomas Brooks, C. & F. S., 306 W. 15th Place.
256—LIMA, OHIO. 2d-4th Thurs. 334 No. Main.
A. C. Thompson, Pres., East Finley.
A. K. Grieshelmer, C. S., 329 N. Elizabeth.
Harry Gunn, F. S., 713 W. Metcalfe.
265—SMITHVILLE, TEXAS. 1st-4th Mon.
M. C. Vaughn, Pres., P. O. Box 521.
Guy Cooper, C. & F. S., P. O. Box 356.
267—MOBERLY, MO. 2nd and 4th Thurs. Painters' Hall.
J. J. Cadagin, Pres.
F. R. Lee, C. S., 601 Monroe Ave.
276—ST. LOUIS, MO. 2d-4th Fri., N. E. Cor. 11th and Locust.
Herbert Abbey, Pres., 2618 Ann Ave.
Henry Waeckerle, C. S., 2919A Miami.
Clyde Stevens, F. S., 1914 N. 21st, E. St. Louis, Ill.
278—ELKINS, W. VA. 2d-4th Thurs., Kendall Hall.
Geo. Cade, Pres., 620 Yokem.
C. H. Goodwin, C. & F. S., 3 Center St.
279—EDMONTON, ALB. CAN. 1st Mon., Calder, Edmonton.
Wm. J. Fitzmaurice, Pres., Box 2100, of E. D. & B. C. Ry.
James McLean, C. & F. S., 10236 113th St.
281—NORWOOD, MASS. 2d-4th Fri., 724 Washington St., Boston.
Amos Bennett, Pres., 135 Appleton St., Boston, Mass.
Robert Henderson, C. S., 274 Metropolitan Ave., Rosindale, Mass.
284—FREEPORT, ILL. 1st Sun., at Blust Hall.
C. J. Pontius, Pres., 26 Park Ave.
Earl Barth, Secy-Treas., 1334 20th Ave., Rockford, Ill.
286—FORT SCOTT, KAN. 1st-3d Mon., Redmen's Hall, 111 E. Wall St.
J. W. McNowen, Pres., 816 Marion J. Ave.
J. C. Bonesteel, C. S., 1213 So. National.
287—KINGSVILLE, TEXAS. M. H. Nicholson, Pres., Gen. Del. E. C. Martin, C. S., Box 162.
290—BREMERTON, WASH. 3d Tues., Hunter & Daily Bldg., Pacific Ave.
Percy Couter, Pres., Box 272, Charleston, Wash.
John Hornby, C. & F. S., Gen. Del.
292—PARSONS, KAN. 2d-4th Tues., Moose Hall.
C. Dudding, Pres., 2229 Crawford St.
E. P. Butler, C. S., 1723 Gabriel.
293—SHAWNEE, OKLA. 2d-4th Mon., Moose Hall.
Floyd Ott, Pres., 602 University Ave.
A. D. Ross, C. & F. S., 429 N. Park Ave.

- 298—PORTSMOUTH, VA. C. L. U. Hall, 2d-4th Thur.
M. A. Garris, Pres., 2226 King.
H. W. Jarrett, F. S., 1822 County.
Robt. T. Howe, C. S., 826 4th St.
- 300—WATER VALLEY, MISS. I. O. O. F. Hall, 1st-3d Thur.
C. H. Baker, Pres. and Treas.
- 301—CANTON, OHIO, 1st-3d Mon., Switzer Hall, Cherry and 8th Sts.
Joe Petch, Pres., 1119 5th St., N. E.
E. J. Gussett, C. & F. S., 1302 McKinley Ave. S. W.
- 302—MILWAUKEE, WIS. 1st-3d Sat., Lipp's Hall, 3d and Prairie.
Henry J. Murray, Pres., 113 29th
Hugh J. Fuller, C. S., 406 30th St.
John DuBrucq, F. S., 217½ 4th Ave.
John L. Callahan, B. A., 3606 Clifton Ave.
- 305—PORT ARTHUR, TEXAS. 2d-4th Tues., Labor Hall.
C. L. Bragg, Pres., Gen. Del.
T. O. Riley, C. S. & B. A., Box 683.
James Rose, F. S., Box 8.
- 309—EVANSTON, WYO. I. O. O. F. Hall, 1st-3d Wed.
John T. Whittle, Pres., County Road.
J. H. Willoughby, C. S., Box 419.
- 311—SOUTH KAUKAUNA, WIS. 2d-4th Mon., Odd Fellows' Hall.
Louis Crevier, Pres.
Chas. Robedeau, C. & R. S., P. O. Box 279.
- 312—SELMA, ALA. 1st-3d Wed., at R. R. Y. M. C. A.
J. F. Ryals, Pres.
W. P. Fawcett, C. S., 1509 Selma.
- 315—McCOMB, MISS. Central Trade and Labor Hall, 1st-3d Wed., at 7:30.
R. O. Bean, Pres. & C. S., Box 624.
- 317—RICHMOND, CALIF. 2d-4th Fri., Barnman's Hall, 19th St.
Frank Mallinson, Pres., care Randall Hotel.
Wm. Jones, C. & F. S., Box 634.
- 318—PITTSBURGH, PA. 1st-3d Mon., Haslewood Bank Bldg., cor. 3d and Haslewood.
W. Merts, Pres., Path Alley.
T. A. Hudson, F. S., 310 Johnston Ave.
- 320—MERIDAN, MISS. B. L. E. Hall, 5th St. and 40th Ave., 1st-3d Thurs.
J. A. Smitheren, Pres., 511 40th Ave.
J. E. Alexander, C. & F. S., 3817 38th St.
- 322—ST. LOUIS, MO. 1st-3d Tues., Reddy Hall, 3100 Chautau.
John Coats, Pres., 2726 Washington Ave.
W. J. Tinell, C. S., 812 Atlantic, Webster Grove, Mo.
- 323—CHICKASHA, OKLA. 2d-4th Fri., Labor Hall, 4th and Choctaw.
C. A. Chincholl, Pres., P. O. Box 502.
W. L. Harkins, C. & F. S., 528 S. 15th.
- 325—SHREVEPORT, LA. K. of P. Hall, over West End Drug Store, 3d-4th Thurs.
H. Abbott, Pres., 1542 Luchina Ave.
H. W. Huff, C. S., 1863 Texas Ave.
- 326—CUMBERLAND, MD. 1st-3d Mon., Odd Fellows' Hall.
C. C. Bowen, Pres., 107 W. 1st.
Geo. H. Little, C. S., 401 E. 1st.
J. R. Beck, F. S., 106 W. 1st.
- 324—PRINCETON, IND. 2d-4th Tues., Redmen's Hall.
Joe Myers, Pres., 1101 S. Race.
J. E. Clark, C. & F. S., 702 S. Prince.
- 325—GRAND JUNCTION, COLO. 2d-4th Fri., Eagles' Hall.
G. R. Stoll, Pres., 337 White.
E. H. Friend, C. & F. S., 208 Pitkin Ave.
- 329—SPARKS, NEV. 2d-4th Wed., Engineers' Hall.
Wm. Daseler, Pres., P. O. Box 214.
C. E. Crouch, C. S., P. O. Box 204.
- 340—HERINGTON, KAS. 1st-3d Sat., I. O. O. F. Hall.
John Olson, Pres.
J. E. Anderson, C. S., 303 N. 8th.
- 341—PHILADELPHIA, PA. 2d-4th Tues., 8 p. m., Labor Headquarters, 233 N. 9th St.
Wm. J. Boyle, Pres., 208 N. 58th St.
Chas. Heberly, C. S., 3084 Aramingo Ave.
- 344—SHEFFIELD, ALA. 1st-3d Wed. at I. O. O. F. Hall, Montgomery Ave.
W. H. Wilson, Pres., Tusculmbia, Ala.
E. T. Holland, C. S., Box 65.
- 345—SAN ANTONIO, TEXAS. Trades Council Hall, 2d-4th Thurs.
F. E. Hamilton, Pres., 2103 W. Travis.
E. H. Frick, C. & F. S., 1228 W. Traves Ave.
Delrympel, B. A., 410 River Ave.
- 346—TRENTON, MO. 1st-3d Tues., at Cutlip's Hall.
Walter Mason, Pres., 1726 Lula Ave.
Geo. W. Singer, C. & F. S., 1801 Maine St.
- 354—BROOKFIELD, MO. 1st-3d Tues., 212 N. Main St.
Martin Murphy, Pres., 291 Elm St.
J. K. Burnham, C. S., 529 S. Living Ave.
- 355—CONNEAUT, OHIO. 2d-4th Fri., Stationary Eng. Hall, Main St.
Chas. Ward, Pres., 685 Lakeview Ave.
J. M. Irish, C. S., 530 Sherman.
E. J. Dickson, F. S., 815 Main.
- 356—HAMMOND, IND. 1st-3d Wed., Long's Hall, State St.
James Boyle, Pres.
Thomas Boyle, C. S., 264 State-line St.
- 360—LAFAYETTE, IND. 1st-3d Thurs., Bartenders' Hall, 3d and Ferry Pt.
Fred Ramp, Pres., 1601 N. 12th.
Wm. Peterson, C. S., 426 Lingie.
James Goldsberry, F. S.
- 363—EAST ST. LOUIS, ILL. 1st-3d Fri., Wyant Hall, Broadway and Main.
James Roose, Pres., 318 S. 5th.
John Roche, C. & F. S., 614 Ohio Ave.
- 367—HAVRE, MONT. 3d Sat., Oxford Hall.
Kyle Cope, Pres., 1428 3rd St.
Elmer Burns, C. S., 1037 2nd St.
- 369—ALEXANDRIA, VA. 1st Thur. in month during summer months, 108 N. Patrick St.
James Moran, Pres., 1219 Duke.
M. Gemeny, R. & F. S., 1514 King.
- 371—LOWELL, MASS. 1st-3d Sat.
James Lanigan, Pres.
J. J. Cunningham, C. S., 656 Gorham.
- 377—MOLINE, ILL. 1st-3d Fri., Moline Industrial Home, cor. 14th St. and 5th Ave.
Carl Robison, Pres., 7th St., Silvis, Ill.
John Fulton, F. S., 7th St., Silvis, Ill.
- Charles McGowan, B. A., 7th St., Silvis, Ill.
C. K. Kiser, C. S., Box 581, Silvis, Ill.
Walter S. Schneider, B. A., 1317 25th St., Rock Island, Ill.
- 378—MONCTON, N. B., CAN. 2d-4th Fri., Sons of Temperance Hall.
Alex McDougall, Pres., 143 High St.
R. D. Donnelly, C. S., 69 Downing St.
- 379—McADAM JUNCTION, N. B., CAN. 2d-4th Fri., Orange Hall.
Geo. Guast, Pres.
A. J. McLaggan, C. S.
- 381—AMARILLO, TEXAS. 1007 Buchanan.
M. L. Parker, Pres., Box 407.
Joe Wilson, C. S., 1007 Buchanan.
- 382—CHILDRESS, TEXAS. 2d-4th Fri., at 7:30 p. m., in Labor Temple.
Mack Leopold, Pres., P. O. Box 825.
J. M. Neal, C. S.
- 384—PERU, IND. 2d-4th Tues., Labor Trades Hall.
Floyd W. Seitz, Pres., 164 N. Lafayette.
A. W. Johnson, C. & F. S., 159 W. 3rd.
Frank Sullivan, B. A., 133 W. 3d.
- 386—MECHANICSVILLE, N. Y. 2d and last Tues., A. O. H. Hall, North Main St.
James S. Kennedy, Pres., S. Second Ave.
Sidney Crozier, C. S., 28 Railroad.
Chas. Chapman, F. S., 112 N. 2d.
- 390—TRINIDAD, COLO. 2d-4th Wed., Labor Union Hall, East Main St.
W. F. Flynn, Pres. and C. S., 915 Arizona Ave.
- 391—DAVENPORT, IOWA. 2d-4th Fri., Danish Hall.
John Schach, Pres., 516½ W. 3d.
R. F. Stewart, C. S., 616 Tremont Ave.
W. C. Richards, F. S., 1928 Bridge Ave.
- 392—CALGARY, ALBERTA, CAN. 3d Sat., 2:30 p. m., Labor Temple.
J. Chambers, Pres., Ogden, P. O. Alb.
F. Adams, C. S., Ogden, P. O. Alb.
- 393—GOODLAND, KAS. 1st-3d Tues., Calvert & Sparks' Law Office.
S. E. Braffet, Pres.
Earl Crause, C. & F. S.
- 395—NORTH FOND DU LAC, WIS. 1st-3d Fri., Trades and Labor Hall, cor. 3d and Main.
Carl Deyer, Pres., 615 Michigan Ave.
- Jos. A. Huntzinger, C. S., 223 E. Johnson, Fond du Lac, Wis.
- 396—NORWICH, N. Y. 4th Wed. in Cook Block.
James E. Callahan, Pres., 1 Columbia St.
Jillius Schraft, C. & F. S., 13 Davis.
- 398—RIVIERE DU LOUP, QUEBEC, CANADA. 2d-4th Mon., Rioux Hall.
Mag. Bourgain, Pres., River du Loup Station.
Jos. Beaulieu, B. A., Blaisville.
Ludger Oullet, C. & F. S., Blaisville.
- 400—MIDDLETON, N. Y. 1st-3d Fri., Odd Fellows' Hall.
Wm. Springer, Pres., 55 Beattie Ave.
Wm. E. Appel, F. S., 378 North.
Chris Smith, C. S., 381 North St.
- 402—PORTSMOUTH, OHIO. 2d-4th Fri., C. L. U. Hall.
R. L. Johnson, Pres., 2949 Gallia.
E. L. Wilson, F. S., 1721 6th St.
Wm. H. Miller, C. S., 1411 Grandview Ave.

- 403—HOISINGTON, KAS. I. O. O.** F. Hall, 1st-3d Mon. Ray Bowler, Pres., P. O. Box 72. C. W. Cramer, C. & F. S., Box 494.
- 405—BLUEFIELD, W. VA.** 1st-3d Fri., Masonic Temple. E. K. Collins, Pres., Princeton Ave. E. W. Dupree, C. & F. S., Gen. Del.
- 410—SAN FRANCISCO, CAL.** 2d-4th Wed. Labor Temple, 16th and California. Ed Hanny, Pres., 2217 Howard L. Kevie, C. S., 208 Springdale Ave.
- 413—ST. THOMAS, ONTARIO, CAN.** 2d-4th Tues., Machinists' Hall, Talbot St. Frederick Brooks, Pres., 5 Maama Frank Roberts, C. S., 61 Wilson
- 414—ONEONTA, N. Y.** 1st Wed. and 3rd Sun., 2:30 p. m., Redmen's Hall. James Walsh, Pres., 51 Church. David Lawrie, C. & F. S., 73 W. Broadway.
- 415—JACKSONVILLE, ILL.** F. McKenna, C. S., 475 E. State.
- 417—NORTH BAY, ONT., CAN.** 2d-4th Mon., L. O. L. Hall. A. E. Lye, Pres., Box 799. Frank Crowther, C. S., Box 1773.
- 418—NEODESHA, KAS.** 1st-2d Sat., Baldwin Hall. Chas. Brown, Pres. E. P. Reddick, C. S., 1007 Iowa. A. F. Bingham, B. A.
- 419—SOMERSET, KY.** 1st-3d Tues., at Owen's Hall. W. C. Williams, Pres. J. S. Arnold, C. & F. S., Sta. A.
- 421—HAMILTON, ONT.** 1st-3d Fri., Labor Hall, John St. So. L. Lawton, Pres., No. 21 Tuckett. F. Honison, C. & F. S., 6 Bristol.
- 422—SANFORD, FLA.** 2d-4th Wed., Eagles' Hall. H. B. Purden, Pres. Geo. Randall, C. & F. S., Box 1194.
- 423—BIG SPRINGS, TEX.** 2d-4th Tues., I. O. O. F. Hall. D. D. Crawford, Pres., cor. Gregg and 3d. W. P. Warren, C. & F. S., 201 W. 1st.
- 424—FLORENCE, S. C.** 2d Thurs., Y. M. C. A. L. H. Mims, Pres., 222 Covington St. A. H. Dickman, C. & F. S., 609 Day St.
- 425—WAYCROSS, GA.** 1st-3d Thurs., Loot Hitch Bldg. C. M. Schultz, Pres., 37 Stephens Ave. L. J. Flohr, C. & F. S., Box 236.
- 427—SALIDA, COLO.** 2d-4th Thurs., Adilas Hall. H. F. Jones, Pres., 135 E. Sacket Ave. Wm. Dargavel, C. S., 821 E. St.
- 428—NORFOLK, VA.** 2d-4th Wed., Pythian Castle Hall. W. M. Wood, Pres., 617 Liberty St., Berkely, Va. Thos. Callahan, C. & F. S., 116 Middleton St., Berkeley, Va.
- 430—CAPE GIRARDEAU, MO.** 1st-3d Tues., Haas' Hall. Geo. Stanley, Pres., 223 Frederick St. Oscar O. Berry, F. S., 415 S. Frederick St.
- 431—BOSTON, MASS.** 2d Thurs., Naomi Hall, 724 Washington. Thos. R. Keenan, C. S., 80 W. 5th St., So. Boston.
- 434—CHICAGO, ILL.** 2d-4th Tues., Marquette Hall, 6650 Halstead St. H. Fischer, Pres., 6438 Sangamon Edward Osborn, C. S., 48 E. 43d St.
- 435—BRISTOL, TENN.** 2d-4th Fri., Sixth and Shelby Sta. M. C. Cooper, Pres., V. & S. W. Ry. Shops. J. B. Wood, C. & F. S., 27 Lancaster St., Bristol, Va.
- 436—COLUMBUS, GA.** 1st-3d Fri., Trades and Labor Assembly Hall. R. S. Barry, Pres., 911 4th Ave. E. W. McMichael, C. & F. S., 1105 21st St.
- 437—TWO HARBORS, MINN.** 2d and last Thurs., Iron Dock Grove Hall. Christ. Anderson, Pres. Charles Larson, C. & F. S., Box 298.
- 438—GALETON, PA.** 2d-4th Tues., Eagles' Hall. Charles H. Bartlett, C. S., 59 Germania.
- 439—FAIRBURY, NEB.** 4th Wed., K. of L. S. Hall. B. Z. Milliken, C. & F. S., P. O. Box 167. Fred Kurst, B. A.
- 440—BELLE PLAINE, IOWA.** 2d-4th Mon., Fireman's Hall. Charles Corns, Pres., 10th St. Warren Wheeler, C. S., P. O. Box 605.
- 442—NEW ORLEANS, LA.** 3d Tues., McMahon Hall, 1112 Drades. James Miller, Pres., 1204 So. Franklin. John Mucklin, C. & F. S., 606 S. Telemachus St.
- 444—CONNELSVILLE, PA.** J. W. Easley, C. S., 617 N. Pgh.
- 446—ALAMOSA, COLO.** 2d-4th Wed., Trades Assembly Hall. Albert Jacobson, Pres. Chas. F. Darling, C. S., Box 64.
- 447—DECATUR, ILL.** 1st-3d Tues., Ashley Hall, Mason Temple. Jas. Gray, Pres., 817 N. Broadway. Chas. J. Younger, C. & F. S., 432 E. King St.
- 448—MONTGOMERY, ALA.** 1st-3d Wed., Young's Hall. J. A. Redding, Pres., 316 Columbus. E. J. Ford, C. S., 75 Morgan Ave.
- 449—SAPULPA, OKLA.** 2d-4th Mon., Moose Hall. M. E. Lange, Pres., 913 E. Hobson. Irwin Shipman, C. S., Box 338.
- 450—WASHINGTON, D. C.** 2d-4th Wed., New Masonic Hall, 8th and F Sts., N. E. A. W. Sherler, Pres., 106 15th S. E.
- 451—WINNIPEG, MAN., CAN.** 2d-4th Fri., Labor Temple. D. Nelson, Pres., 322 Morley Ave. F. Snare, C. & F. S., 263 Bradford St., St. James.
- 452—COPPERHILL, TENN.** 1st-3d Tues., I. O. O. F. Hall. Chas. Frenz, Pres., Box 711. E. N. Hall, C. S., Box 382.
- 454—CHICAGO, ILL.** 2d-4th Thurs., Persey Hall. Walter Love, Pres., 752 E. 69th St. E. R. Dettmer, C. S., 9245 Stoney Island Ave.
- 455—SHERMAN, TEXAS.** 2d-4th Thurs., Machinists' Hall. W. K. Murray, Pres., Tucket Ave. John Plexco, C. & F. S., 424 Gribble Ave.
- 463—BALBOA, CANAL ZONE, PANAMA.** 1st-3d Fri., Ancon Lodge Hall. A. R. R. Charters, Pres., Carozal, C. Z. W. H. Keenan, C. & F. S., Box 26, Culebra, C. Z.
- 464—PALESTINE, TEXAS.** Labor Temple, 2d-4th Wed. J. S. Guinn, Pres., 635 Tenn. Ave. J. D. Mallette, C. & F. S., 503 La.
- 466—REVELSTOKE, B. C.** 3rd Sat., Selkirk Hall. M. M. Keller, Pres., Box 138. A. Harris, C. & F. S., Box 138.
- 467—PORTSMOUTH, N. H.** 2d Wed., Eagles' Hall. John Quinn, Pres., Court St. Alfred Olson, C. & F. S., 27, Kittery, Me.
- 469—TERRELL, TEXAS.** 2d-4th Fri., Trades and Labor Hall, 203 E. Moore Ave. J. R. Poston, Pres., 608 E. College St. R. E. O'Reilly, C. S., 906 E. Moore Ave.
- 471—CRISTOBAL, C. Z.** 2d-4th Thurs., Canal Lodge Hall. Alexander McKenzie, Pres. Jas. Z. Knapp, C. & F. S., Box 219.
- 473—HELPER, UTAH.** 1st-3d Wed., K. of P. Hall. Wm. R. Welsh, Pres. R. W. Smith, C. & F. S., Box 411.
- 475—GRAND ISLAND, NEB.** 1st-3d Mon., City Hall, 3d St. H. W. Hunt, Pres. Sherman Aldrich, F. S., 1014 E. 4th St.
- 476—DALHART, TEXAS.** 3d Fri., Socialist Hall. H. C. Fritche, Pres. Theo P. Nelson, C. & F. S., Box 282.
- 478—MOOSE JAW, SASKATCHEWAN, CANADA.** 2d-4th Mon., Trades and Labor Hall, Main St. Wm. Gillies, Pres., 364 Fairford St., W. Geo. Walters, C. S., 244 Iroquois.
- 479—DEVIL'S LAKE, N. DAK.** 1st Fri., Opera House Hall. J. A. Thompson, Pres., Box 324. M. J. Feeney, C. S., Box 148.
- 481—LYNDONVILLE, VT.** 1st-3d Wed., Eaton's Hall. B. A. Hinda, Pres. E. A. Phillips, C. & R. S., Box 121. Lyndon Center, Vt. J. M. Breason, B. A.
- 482—ALTON, ILL.** Schwartzbeck Hall, 3d and Ridge. 1st-3d Tues. D. Stafford, Pres., 1009 E. 5th St. Robt. Dale, C. & F. S., 3008 Edwards.
- 485—GREEN BAY, WIS.** 1st-3d Thurs. John Christianson, Pres., 822 S. Maple Ave. John Slater, C. & F. S., 425 5th St. J. L. Callahan, B. A., 2606 Clifton Ave., Milwaukee, Wis.
- 486—TYLER, TEXAS.** 1st-3d Wed., K. O. T. M. Hall. J. A. Fuller, Pres., 1116 Irvin. J. M. McCarty, C. & F. S., 216 Center Ave. C. R. Welch, B. A., 1428 N. Fannie Ave.
- 491—VALLEY JUNCTION, IOWA.** 1st-3d Tues., I. O. O. F. Hall. Frank S. Hoppe, Pres. J. C. Carroll, C. S., Box 165. Geo. W. Pring, B. A., Treas.
- 492—NEW CASTLE, PA.** Jan. 13, 1915, and every other Wed., Trades Assembly Hall. D. E. Sturdevant, Pres., 516 Waldo. David Lewis, C. & F. S., 422 Galbreath Ave.
- 495—HATTIESBURG, MISS.** 1st-3d Tues., 500 Boule St. C. W. LeBlanc, Pres., 107 Evans. A. H. Waddell, C. & F. S., 500 Boule.
- 496—HURON, SOUTH DAKOTA.** 2d Sun. and 4th Fri., Labor Hall. Peter Paluszak, Pres. C. Storkson, C. & F. S., 228 Beach St.

- 500 — EVERETT, WASH.** 2d-4th Tues., Labor Temple, 3506 Everett Ave.
Wm. Faulke, Pres., 3506½ Everett Ave.
Bert Bloomington, C. S., 3523 Smith Ave.
- 501—WACO, TEXAS.** 2d-4th Fri., Labor Hall.
Chas. Bullock, Pres., R. F. D. No. 2.
Wm. Dickerson, C. & F. S., 810 Cleveland St.
- 502—TEAGUE, TEXAS.** 1st-3d Mon., Davis Hall.
Thos. McGrath, Pres., Box 244.
J. D. Clayton, C. S.
- 503—FITZGERALD, GA.** 1st-3d Wed., I. O. O. F. Hall.
M. J. Mauns, Pres., P. O. Box 686.
A. B. Campbell, C. S.
- 504—MUSKOGEE, OKLA.** 1st-3d Wed., Carpenters' Hall.
Guy Carver, Pres., 1220 Baltimore.
W. H. Hannaford, C. & F. S., Gen. Del.
- 505—FORT WILLIAM, ONTARIO, CAN.** 1st-3d Fri., Electricians' Hall, Murphy Block, Simpson Ave.
James Duncan, Pres.
A. Cruickshank, C. S., 1007 Minn. Ave.
- 507—ATCHISON, KAS.** 1st-3d Mon., Fireman's Hall, 1521 Main St.
J. F. Coyle, Pres., 1418 Kansas Ave.
John J. Frelbott, C. & F. S., 1420 Kansas Ave.
- 509—JACKSON, OHIO.** 4th Tues., Hibernian Hall.
O. B. Reynolds, Pres., 77 High St.
Albert Edmonds, C. S., 77 Hunt St.
J. B. Fillinger, B. A. and Journal Cor., 53 Main St.
- 510—CEDARTOWN, GA.**
E. M. Kendricks, Pres.
I. C. Smith, C. S.
- 511—WHISTLER, ALA.** 1st-3d Mon., I. O. O. F. Hall.
J. B. Chestang, Pres.
C. C. Crone, C. S., 209 Bauregard, Mobile, Ala.
- 515—EAST CAMBRIDGE, MASS.** Engineers' Hall, 164 Canal St., Boston, Mass., 1st-3d Fri.
Geo. L. Parks, Pres.
John F. Grant, C. & F. S., 124 Spring.
- 517—GREENFIELD, MASS.** 2d-4th Sat., Forester Hall.
Patrick Kelley, Pres., 3 Devens.
Tim Scannell, C. & F. S., 6 Russell St.
- 518 — WICHITA, KAS.** 1st-3d Thurs., 216 N. Main St.
G. W. Thompson, Pres., 2127 University Ave.
O. E. Maze, C. S., 1933 W. Lincoln.
- 520—MILES CITY, MONT.** 2d-4th Fri., Wilboux Hall, 7th and Main.
P. J. Gallagher, Pres., 602 N. Lake St.
Chas. E. Cook, C. & F. S., 119 N. Streville.
- 521—VAN BUREN, ARK.** 1st-3d Thurs., W. O. W. Hall.
Charles Patthast, Pres.
Otto Pyles, C. S., Box 343.
C. A. McDonald, B. A., 4416 Norledge, Kansas City, Mo.
- 522—EL RENO, OKLA.** 1st-3d Tues., Redmen's Hall.
H. E. Hart, Pres., Box 624.
H. A. Mathews, C. & F. S., Box 12.
- 523—PRATT, KAS.** 2d-4th Tues., at S. T. Sample's residence.
W. F. Stephen, Pres., 624 N. Ninirscash St.
F. W. Sharpe, C. S., Box 73.
- 524—MURPHYSBORO, ILL.** 2d-4th Wed., Machinists' Hall, 107 S. 10th.
A. R. McFarland, Pres., 638 N. 8th.
E. P. Herin, C. & F. S., 2107 Wall.
- 525—HINTON, W. VA.** 1st-3d Mon., Big Four Bldg.
W. L. Taylor, Pres., 108 Grace St.
C. L. Barnette, C. & F. S. & B. A., 419 Summer Ave.
- 528—DEER LODGE, MONT.** 2d-4th Fri., I. O. O. F. Hall.
T. J. Messing, Pres.
J. H. Thomas, C. & F. S., P. O. Box 877.
- 529—WINNIPEG, MAN., CAN.** 1st Sun., Campbell Hall, Transcona, 3rd Sun., Labor Temple, Winnipeg, 3 p. m.
A. Orr, Pres., 3 Gallagher Ave., Brooklands, Man., Can.
Robt. Clark, C. & F. S., 471½ Portage Ave.
- 530—SPRINGFIELD, MO.** 3d Mon., Dengeldem's Hall.
J. W. Reddick, Pres., 817 Lincoln.
John Cain, C. & F. S., 507 Fort.
A. F. Bingham, B. A., 701 Lombard St.
- 531—CHAFFEE, MO.** 1st-3d Thurs., City Hall.
T. C. Davis, Pres.
C. P. Bourion, C. & F. S., Box 365.
- 537—COVINGTON, KY.** 2d-4th Fri., Workman Hall, 122 Pike St.
A. J. Pope, Pres. & B. A., 1817 Scott St.
John J. Fielding, C. & F. S., 1341 Holman.
- 541—BEDFORD, IND.** 2d-4th Thurs., Labor Union Hall.
Dan J. Kane, Pres., 511 N. I St.
C. J. Bordenet, C. S., 623 N. I.
- 542—COFFEYVILLE, KAS.** Labor Temple, 2d-4th Wed.
R. M. Jones, Pres., 807 W. 14th.
J. C. Morrow, C. & F. S., 613 W. 4th St.
- 543—WICHITA, KAS.** 216 N. Main St., 2d-4th Wed.
C. E. Grove, C. & F. S., 701 W. Central.
- 546—MONETT, MO.** 1st-3d Tues., K. C. Hall.
T. J. Moore, Pres., 706 Benton Ave.
John Linebarger, C. & F. S., 214 Pearl St.
- 547—CARBONDALE, PA.** Pughanas Hall, 2d-4th Fri.
E. T. Dickenson, C. & F. S., 142 Wyoming.
Wilkes Barre Representative, T. J. Cavan, 60 Chester St., Wilkes Barre, Pa.
- 548—TORONTO, CAN.** 2d-4th Wed., Labor Temple, Church Joseph P., Dobson, Pres., 280 Perth Ave.
John C. Walker, C. & F. S., 152 Gladstone Ave.
- 549—MIDDLEPORT, O.** 1st-3d Tues., Firemen's Hall.
Lester Cunningham, Pres.
Perry Cooper, C. & F. S.
- 551—PRINCETON, W. VA.** Castle Hall, 1st-3d Thurs.
J. H. Blackwell, Pres., Box 312.
J. J. Bowers, C. S., 576 Bluefield.
- 556—OKLAHOMA CITY, OKLA.** C. S. Cochran, Pres., 406 W. Frisco.
E. C. Ryan, C. & F. S., 400 West Frisco.
- 557—WILLIAMSON, W. VA.** 2d-4th Tues., Eagles' Hall, 3rd Ave.
W. H. Turner, Pres., 113 6th Ave.
H. W. Blas, C. & F. S., 124 Oak.
- 565—FALLS CITY, NEB.** 1st-3d Thurs., W. O. W. Hall.
C. W. Jonas, Pres.
E. Woodington, C. & F. S., 710 E. 16th St.
- 567—SAN ANGELO, TEX.** 1st-3d Wed., Eagles' Hall.
O. M. Seay, Pres., 321 W. Ave. 1.
R. L. Wright, C. S., 27 West Ave. 1.
- 568—TACOMA, WASH.** Maccabee Hall, 1109½ C St., 2d-4th Thurs.
Chas. Manning, Pres., 5808 S. Lawrence St.
A. W. Rickett, C. & F. S., 615 So. State.
- 570—HIGH SPRINGS, FLA.**
H. A. Smith, Pres., P. O. Box 273.
F. C. Magerstaadt, C. S.
- 571—DE PERE, WIS.** De Both Hall, 1st Sun.-3d Wed.
T. J. McDonald, Pres., Lock Box 44, W. De Pere, Wis.
A. B. Steinfeldt, R. S., P. O. Box 307.
- 573—LANSFORD, PA.**
Frank A. O'Donnell, C. S., Summit Hill.
- 575—VILLA GROVE, ILL.** 1st-3d Fri., Red Men's Hall.
James Tally, Pres.
A. Welch, C. S.
H. A. Downes, F. S.
- 576—WICHITA FALLS, TEX.** 2d-4th Thurs., Labor Hall.
J. H. Gibson, Pres., 309 Lee St.
E. A. Monahan, C. & F. S., Box 760.
C. H. Shoemaker, B. A., Box 18, Healdton, Okla.
- 577—CUMBERLAND, MD.** 1st-3d Thurs., Trades Council Hall.
E. H. Stealey, Pres., Ridgeley, W. Va.
Owen Layman, C. & F. S., Ridgeley, W. Va.
- 578—HAGERSTOWN, MD.** Moose Hall, 2d-4th Thurs.
L. J. Murray, Pres., 25 Vine St.
Fred H. Stouffer, C. S., 817 Summit Ave.
- 579—KEYSER, W. VA.** 1st-3d Tues., City Building.
W. H. Wolf, Pres., Gilmore St.
P. R. Dougan, F. S., Gilmore St.
Joseph F. Hines, C. S., Piedmont, W. Va.
- 581—MONTPELIER, O.** 1st-3d Wed., Ry. Trainmen's Hall.
S. Brown, Pres.
J. Birmingham, C. S.
- 582—BATON ROUGE, LA.** 2d-4th Thurs., Odd Fellows' Hall, 3d St.
W. P. Kidd, Pres., 302 St. Phillip St.
S. V. Acosta, C. & F. S., 918 St. Ferdinand St.
- 583—NEVADA, MO.** Socialist Hall, Hall, So. Main St., 1st-3d Thurs.
A. C. LeQuellec, Pres., 520 E. Cherry.
L. E. Whitehead, C. & F. S., R. F. D. No. 1.
C. A. McDonald, B. A., 4416 Norledge, K. C., Mo.
- 584—LUDLOW, KY.** 1st-3d Thurs., Morley Hall.
Thos. Jackson, Pres., 17 Pherry.
H. J. Stroer, C. S., 833 Main, Covington, Ky.
- 585—BOSTON, MASS.** 1st Thurs., 8 p. m., and 3d Sun., 2:30, Hemstead Hall, 724 Washington St.
Wm. E. McNabb, Pres., 263 Chelsea, E. Boston, Mass.
Daniel B. McInnes, C. S., 288 Marginal Ave., E. Boston, Mass.
Daniel N. Generson, B. A., 17 Rulard, Dorchester, Mass.
James Vincent, F. S., 77 Lavin Hill.

586—SLATER, MO. 2d-4th Mon., I. O. O. F. Hall, Chas. Crawford, Pres. Andy Phelps, C. & F. S.

587—BEAUMONT, TEX. 2d-4th Tues., Trades Assembly Hall, Geo. H. Clayton, Pres., Box 624. T. C. Maddy, C. & F. S., Box 624.

588—CHICAGO, ILL. 2d-4th Tues., Koop's Hall, California & North Ave. Thomas Godfrey, Pres., 930 E. 44th St. John McNaney, C. & F. S., 819 N. Rockwell.

589—MILWAUKEE, WIS. 2d-4th Thurs., 923 E. Water St. Frank Thinner, Pres., 729 5th. M. J. Gleason, C. & F. S., 202 Michigan St.

590—MONROE, LA. 1st Fri., 615 A St. J. W. Grant, Pres., 501 Wood St. J. J. Devereux, C. & F. S., 615 Calypso St.

591—GLENDALE, MONT. 2d-4th Fri., Noderhoff Hall. N. A. Schope, Pres., Gen. Del. V. B. O'Connor, C. & F. S., 317 Valentine.

592—TULSA, OKLA. 2d-4th Sat. 214 1/2 S. Main. J. E. Dixon, Pres.

Richard Leahy, C. & F. S., 215 Reeder Bldg.

593—CLIFTON, ARIZ. Every Sat., Carpenters' Hall. Homer Darr, Pres., Box 704. Joseph B. Hammer, C. & F. S., Box 416.

594—STANBURY, MO. 2d-4th Tues., K. of P. Hall. John Inman, Pres. E. W. McNew, C. S.

595—AVERY, IDAHO. 2d-4th Mon., Godfrey's Home, West Avery. A. Anderson, C. & F. S., Gen. Del.

596—CASPER, WYO. 2d-4th Mon. John Mulligan, Pres., 232 N. Beach. H. L. Celley, C. S., 509 S. Beach.

597—ESCANABA, MICH. 1st-3d Thurs., Lemmer Hall, Ludington St. Jos. Vickers, Pres., 506 Wells Ave. Wm. Grosnich, C. & F. S., 714 Wells Ave.

598—SALAMANCA, N. Y. 1st-3d Mon., 3 Maple St. A. G. Frey, Pres., 165 E. State St. D. J. Carpenter, C. & F. S., 3 Maple St.

599—PARAGOULD, ARK. 1st-3d Thurs., Carpenters' Hall.

J. W. Frey, Pres., 321 S. 2d St. A. Johnson, C. & F. S., 216 N. 5th Ave. C. A. McDonald, B. A., 4416 Norledge, Kansas City, Mo.

601—QUEBEC, CAN. J. Thompson, Pres., 130 3d St., Simillon. G. Dery, C. S., 153 4th St., Lamorlow, Quebec, Can.

602—GREAT FALLS, MONT. 2d-4th Tues., Musicians' Hall, over the Mint. J. L. Smith, Pres., 205 2nd Ave. North. Roy J. Preston, C. & F. S., 420 8th Ave. So.

603—OTHELLO, WASH. 1st-3d Mon., I. O. O. F. Hall. O. W. Bohusock, Pres. W. O. Clark, C. S., Box 137.

604—JOLIETTE, QUE., CAN. H. Fournier, Pres., Gen. Del. W. C. Williams, C. & F. S., Box 238.

605—TOOLE, UTAH. 2d-4th Thurs., Fraternal Hall. D. B. Sullivan, Pres. L. Forno, F. S., Box 294.

606—MORBRIDGE, S. D. 1st-3d Thurs., Moose Hall. J. P. Schmickrath, Pres., Box 721. H. L. Adams, C. & F. S., Box 166.

International Officers of the Ladies' Auxiliary

MRS. J. W. EDWARDS.....President
1234 S. 9th East St., Salt Lake City, Utah.

MRS. F. R. REINEMEYER...1st Vice-President
Tauroome Ave., Kansas City, Kans.

MRS. MOLLIE GEARY.....2nd Vice-President
6428 S. Albany St., Chicago, Ill.

MRS. A. F. BINGHAM.....Secretary-Treasurer
701 Lombard St., Springfield, Mo.

L. A. 5—SALT LAKE CITY, UTAH.
Mrs. J. W. Edwards, Pres. & C. S., 928 W. South Temple St.
Mrs. Lydia Smithen, V.-Pres., 360 West 1 South St.
Mrs. J. C. Walton, F. S.
Mrs. Jane Foreman, Treas.
Mrs. Morton, R. S., 116 Markham.

L. A. 7—SUNFLOWER, Parsons, Kas. 2d-4th Tues. aft., Kennedy Hall.
Mrs. Lillian Dudding, Pres., 2229 Crawford Ave.
Mrs. Alice Leach, Vice-Pres.
Mrs. Zita Rever, Treas.
Mrs. Lula VanVleck, C. & R. S., 2701 Clark Ave.
Mrs. Ethel Smith, Fin. Sec., 2227 Wash. Ave.
Mrs. Mary Carver, Chaplain.
Mrs. Marion Butler, Marshall.
Mrs. Ida Cormany, Conductress.
Mrs. Kate McMullen, In. Guard.
Mrs. Emma Pilkington, O. Guard.

L. A. 8—FRANKLIN, McComb, Miss., Ladies' Aux. Hall, Ave. F. East McComb, 2d-4th Thurs.
Miss Lula Hassfield, Pres., R. F. D. No. 1.
Mrs. E. Sullivan, V.-P. & Treas., 725 Ave. F.
Miss Emma Sullivan, C. S., 725 Ave. F.
Miss Lulu Hassfield, R. S.

L. A. 9—GRAND JUNCTION, COLO.
Mrs. W. H. Holeman, Past Pres., 914 S. 5th St.
Mrs. F. N. Davies, Pres. & Treas., 538 Ute Ave.
Mrs. J. W. Cox, C. & F. S. & V.-P., 925 S. 5th St.
Mrs. L. A. Turner, R. & S. T.

L. A. 10—SPRINGFIELD, MO.
Mrs. A. F. Bingham, Pres., 701 Lombard St.
Mrs. J. Gestring, Vice-Pres.
Mrs. C. S. Gilliland, C. & R. S., 1914 Johnson St.
Mrs. Wm. Specht, F. S. & T., Route 6.
Mrs. Rheaden, Chaplain.
Mrs. J. East, Conductress and Marshall.
Mrs. J. Ritterhouse, Inside Guard.
Mrs. Gestring, Mrs. Gilliland and Mrs. East, Trustees.

L. A. 11—LONE STAR, Palestine, Texas, Labor Temple, 2d-4th Tues. afternoons.
Mrs. Frances Brunson, Pres., 15 Cottage Ave.
Mrs. Helen Redus, V.-P., 106 Queen St.
Mrs. Florence Payne, R. S. & Treas., 212 Palmer Ave.
Mrs. Willie Welch, C. & F. S., 511 Green St.

L. A. 12—GARFIELD PARK, Chicago, Ill., 1st-3d Sat., 8 p. m., Garfield Park Hall, 4039 W. Madison.
Mrs. Maud Reinemeyer, Past Pres.
Mrs. Mollie Geary, Pres., 6428 S. Albany Ave.
Mrs. E. Farrell, V.-P., 4118 Carroll Ave.
Mrs. Helen Hughes, Cor. & Rec. Sec., 716 N. Avers Ave.
Mrs. Mary Driscoll, Fla., Sec. & Treas., 4135 Carroll Ave.

L. A. 14—TOLEDO, O.
Mrs. E. Richardson, Pres.
Mrs. Allen Thomson, V.-Pres.
Mrs. C. F. Haga, R. S.
Mrs. C. J. Sugrue, C. & F. S.
Mrs. Carrie Stephan, Treas.
Mrs. Louise Brown, Conductress.
Mrs. Lena Kern, Inspector.

L. A. 15—SAPULPA, OKLA.
Mrs. Cora Johnson, Pres.
Mrs. Myrtle Clifton, V.-Pres.
Mrs. Addie Allen, R. S.
Mrs. Bessie Lewis, C. S.
Mrs. Hester Chapman, F. S.
Mrs. Ethel Edwards, Treas.
Mrs. Hettie Rondon, Chaplain.
Mrs. Ferrel Wells, Conductress.
Mrs. Emma Davis, Inside Guard.
Mrs. Katie Hoover, Marshall.
Trustees—Laura Cargill, Mrs. Emma Davis, Mrs. Addie Allen.

L. A. 16—DECATUR, ILL.
Mrs. M. J. Kelly, Pres.
Mrs. Fred Reutlicher, Vice-Pres.
Mrs. H. J. McLaughlin, R. S.
Mrs. Henry Yost, C. & F. S.
Mrs. C. C. Dean, Treas.

L. A. 17—CHICAGO, ILL.
Mrs. Lizzie Person, Pres., 7450 Ingleside Ave.
Mrs. Elenora Clark V.-P., 7539 Rhoades Ave.
Mrs. Nellie Evans, R. S., 2722 E. 76th St.
Mrs. Marion Evans, C. S., 125 E. 88th St.
Mrs. Emma Shupart, F. S., 7300 Cottage Grove Ave.
Mrs. Cora E. Kelly, Treas., 9251 Stormy Island Ave.

Boilermakers' Lodges by States.

Alabama.
 Birmingham . . . 4
 Montgomery . . . 443
 Selma . . . 312
 Sheffield . . . 344
 Whistler . . . 511

Arizona.
 Clifton . . . 593
 Miami . . . 187

Arkansas.
 Harrison . . . 138
 Little Rock . . . 66
 Little Rock . . . 69
 McGhee . . . 196
 Paragould . . . 598
 Pine Bluff . . . 68
 Van Buren . . . 521

Canada.
Calgary.
 Alberta . . . 392
 Edmonton . . . 279
 Ft. William . . . 279
 Ont. 505
 Hamilton . . . 421
 Ont. 421
 Joliette, Que. . . 604
 McAdam Jct. . . 379
 Moncton, N.B. . . 378
 Montreal . . . 134
 Moose Jaw . . .
 Sask. 478
North Bay.
 Ont. 417
 Quebec . . . 601
 Revelstoke . . . 466
 Riviere du
 Loup, Que. . . 398
 St. Thomas . . .
 Ont. 413
 Toronto, Ont. . . 548
 Transcona . . .
 Man. 529
 Winnipeg, M. . . 126
 Winnipeg, M. . . 451

British Columbia.
 Vancouver . . . 184
 Victoria . . . 191

California.
 Los Angeles . . . 92
 Oakland . . . 233
 Ft. Richmond . . 317
 Sacramento . . . 94
 S. Francisco . . . 25
 S. Francisco . . . 205
 S. Francisco . . . 410
 Vallejo . . . 148

Colorado.
 Alamosa . . . 446
 Colorado . . . 136
 Denver . . . 179
 Grand Jct. . . 335
 Pueblo . . . 44
 Salida . . . 427
 Trinidad . . . 390

Connecticut.
 Hartford . . . 237
 New Haven . . . 61

Delaware.
 Dist. of Columbia
 Washington . . . 450

Florida.
 High Springs . . 570
 Jacksonville . . . 20
 St. Augustine . . 230
 Sanford . . . 422

Georgia.
 Atlanta . . . 2
 Augusta . . . 108
 Cedartown . . . 510
 Columbus . . . 426
 Fitzgerald . . . 503

Macon . . . 112
 Savannah . . . 26
 Waycross . . . 425

Idaho.
 Avery . . . 595

Illinois.
 Alton . . . 483
 Bloomington . . 155
 Chicago . . . 1
 Chicago . . . 39
 Chicago . . . 220
 Chicago . . . 227
 Chicago . . . 454
 Chicago . . . 434
 Chicago H's . . . 254
 Chicago . . . 588
 Danville . . . 22
 Decatur . . . 447
 Freeport . . . 284
 Joliet . . . 93
 Kewanee . . . 195
 Mattoon . . . 224
 Moline . . . 377
 Peoria . . . 60
 Murphysboro . . 524
 Springfield . . . 81
 E. St. Louis . . . 363
 Urbana . . . 150
 Villa Grove . . . 575

Indiana.
 Bedford . . . 541
 Evansville . . . 95
 Ft. Wayne . . . 54
 Garret . . . 79
 Hammond . . . 356
 Indianapolis . . 10
 Lafayette . . . 360
 Peru . . . 384
 Princeton . . . 334
 Terre Haute . . . 246
 Washington . . . 241

Iowa.
 Belle Plaine . . . 440
 Boone . . . 161
 Cedar Rapids . . 144
 Des Moines . . . 47
 Dubuque . . . 15
 Marshalltown . . 149
 Mo. Valley . . . 145
 Sioux City . . . 244
 Valley Jct. . . 491
 Waterloo . . . 133

Kansas.
 Atchison . . . 507
 Coffeyville . . . 542
 Ft. Scott . . . 286
 Goodland . . . 393
 Herington . . . 340
 Holington . . . 408
 Horton . . . 199
 Kansas City . . . 83
 Neodesha . . . 418
 Osawatimie . . . 82
 Parsons . . . 292
 Pittsburg . . . 221
 Pratt . . . 523
 Wichita . . . 543
 Wichita . . . 518

Kentucky.
 Covington . . . 537
 Covington . . . 364
 Louisville . . . 40
 Ludlow . . . 584
 Paducah . . . 137
 Somerset . . . 419

Louisiana.
 Baton Rouge . . 532
 New Orleans . . . 37
 New Orleans . . . 442
 Shreveport . . . 328
 Algiers . . . 206
 Monroe . . . 590

Maryland.
 Cumberland . . . 332
 Cumberland . . . 577
 Baltimore . . . 193
 Hagerstown . . . 578

Massachusetts.
 Boston . . . 250
 Boston . . . 431
 Boston . . . 585
 Cambridge . . . 515
 Greenfield . . . 517
 Lowell . . . 371
 Norwood . . . 281

Michigan.
 Bay City . . . 67
 Detroit . . . 169
 Escanaba . . . 597
 Grand Rapids . . 84
 Jackson . . . 64
 Marquette . . . 236
 Saginaw . . . 124

Minnesota.
 Brainerd . . . 116
 Duluth . . . 165
 Minneapolis . . . 11
 St. Paul . . . 3
 Two Harbors . . . 437
 Winona . . . 201

Mississippi.
 McComb City . . 315
 Meridan . . . 320
 Water Valley . . 300

Missouri.
 Brookfield . . . 354
 Cape Girar-
 deau . . . 430
 Chaffee . . . 531
 De Soto . . . 117
 Kansas City . . . 32
 Moberly . . . 267
 Monett . . . 546
 Nevada . . . 583
 Sedalla . . . 113
 Springfield . . . 70
 Springfield . . . 530
 Slater . . . 586
 St. Louis . . . 27
 St. Louis . . . 276
 St. Louis . . . 322
 St. Joseph . . . 31
 Stanbury . . . 594
 Sugar Creek . . . 90
 Trenton . . . 346

Montana.
 Anaconda . . . 80
 Deer Lodge . . . 528
 Glendive . . . 591
 Great Falls . . . 602
 Harlowton . . . 41
 Havre . . . 367
 Livingston . . . 123
 Miles City . . . 520
 Missoula . . . 111
 Butte . . . 130

Nevada.
 Sparks . . . 339

Nebraska.
 Chadron . . . 109
 Fairbury . . . 439
 Falls City . . . 565
 Grand Island . . 37
 Omaha . . . 485

New Hampshire.
 Concord . . . 245
 Portsmouth . . . 467

New Jersey.
 Elizabeth . . . 176
 Hoboken . . . 143
 Jersey City . . . 16

New York.
 Albany . . . 197
 Brooklyn . . . 46
 Buffalo . . . 7
 Elmira . . . 225
 Mechanics-
 ville . . . 388
 Middletown . . . 400
 Norwich . . . 396
 Oneonta . . . 414
 Rochester . . . 229
 Salamanca . . . 598
 Staten Island . . 200
 Troy . . . 73
 Utica . . . 223
 N. Y. City . . . 21

North Carolina.
 Raleigh . . . 173
 Rocky Mount . . 239
 Salisbury . . . 226

North Dakota.
 Devils Lake . . . 479

Oklahoma.
 Muskogee . . . 504
 Okla. City . . . 556
 Sapulpa . . . 449
 Shawnee . . . 293
 Chickasha . . . 323
 El Reno . . . 522

Ohio.
 Bellefontaine . . 243
 Canton . . . 301
 Chillicothe . . . 135
 Cincinnati . . . 105
 Cleveland . . . 5
 Columbus . . . 8
 Conneaut . . . 355
 Elmwood
 Place . . . 91
 Jackson . . . 509
 Lima . . . 259
 Middleport . . . 549
 Montpelier . . . 581
 Newark . . . 99
 Portsmouth . . . 402
 Toledo . . . 85
 Van Wert . . . 409

Oregon.
 Portland . . . 72

Panama.
 Empire, C. Z. . . 463
 Cristobal . . . 471

Pennsylvania.
 Carbondale . . . 547
 Connellsville . . 444
 Galeton . . . 438
 Lansford . . . 573
 New Castle . . . 493
 Philadelphia . . . 341
 Pittsburgh . . . 154
 Pittsburgh . . . 318
 Philadelphia . . . 19

South Carolina.
 Charleston . . . 50
 Columbia . . . 235
 Florence . . . 424

South Dakota.
 Huron . . . 496
 Mobridge . . . 606

Tennessee.
 Bristol . . . 435
 Copperhill . . . 453
 Jackson . . . 88
 Knoxville . . . 143
 Memphis . . . 180
 Nashville . . . 42
 Chattanooga . . 14

Texas.
 Amarillo . . . 331
 Beaumont . . . 587
 Big Spring . . . 423
 Childress . . . 382
 Dalhart . . . 476
 Dallas . . . 36
 Denison . . . 209
 El Paso . . . 216
 Ft. Worth . . . 96
 Galveston . . . 132
 Houston . . . 74
 Kingsville . . . 287
 Marshall . . . 100
 Mart . . . 222
 Palestine . . . 464
 Sherman . . . 458
 Port Arthur . . . 305
 Smithville . . . 265
 San Antonio . . . 345
 Teague . . . 502
 Terrell . . . 469
 Tyler . . . 486
 Waco . . . 501
 Walnut
 Springs . . . 207

Utah.
 Helper . . . 473
 Ogden . . . 198
 Salt Lake
 City . . . 103
 Tooele . . . 605

Vermont.
 Lyndonville . . . 481

Virginia.
 Alexandria . . . 369
 Clifton Forge . . 238
 Newport News . . 58
 Norfolk . . . 428
 Portsmouth . . . 298
 Portsmouth . . . 57
 Richmond . . . 170
 Roanoke . . . 30
 Roanoke . . . 29
 Virginia . . . 65

Washington.
 Bremmerton . . . 290
 Everett . . . 500
 Othello . . . 603
 Spokane . . . 242
 Seattle . . . 104
 Seattle . . . 489
 Tacoma . . . 247
 Tacoma . . . 568

West Virginia.
 Bluefield . . . 405
 Elkins . . . 278
 Gassaway . . . 153
 Hinton . . . 525
 Huntington . . . 249
 Keyser . . . 579
 Princeton . . . 551
 Williamson . . . 557

Wisconsin.
 Butler . . . 589
 De Pere . . . 571
 Green Bay . . . 485
 Milwaukee . . . 107
 Milwaukee . . . 302
 N. Fond du
 Lac . . . 395
 S. Kaukauna . . . 311

Wyoming.
 Casper . . . 594
 Cheyenne . . . 46
 Evanston . . . 309
 Laramie . . . 48

By Insisting Upon Purchasing Union Stamp Shoes



You help better shoemaking conditions.
 You get better shoes for the money.
 You help your own labor position.
 You abolish child labor.

Do not be misled by retailers who say: "This shoe does not bear the union stamp, but is made under union conditions." This is false—no shoe is union made unless it bears the union stamp.

Boot and Shoe Workers' Union

246 SUMMER STREET, BOSTON, MASS.

JOHN F. TOBIN, President.

CHAS. L. BAINE, Sec.-Treas.

THE COMMERCIAL NATIONAL BANK

of KANSAS CITY, KANSAS.

CAPITAL AND SURPLUS, \$550,000.00. DEPOSITS.....\$5,000,000.00

We cordially invite the Boiler Makers and Ship Builders of the United States who desire to transact banking business with us (which can be done readily by mail), to write to any of their officers and ask any questions they may desire to ask about our reliability and standing.

P. W. GOEBEL, President.
 A. C. FASENMYER, Vice-President.

C. L. BROKAW, Cashier.
 G. J. BISHOP, Asst. Cashier.

When Writing Advertisers

PLEASE MENTION

The Boiler Makers' Journal

Notice to Subscribers of the Journal

When members change their address, or do not receive Journal promptly, fill out the following blank and forward to the editor:

Name Reg. No. Lodge.....

Old Address, Street..... City State.....

New Address, Street..... City State.....

I have not received Journal for month of.....

KANSAS CITY, KAS., AUGUST, 1915.

THE BOILERMAKERS JOURNAL

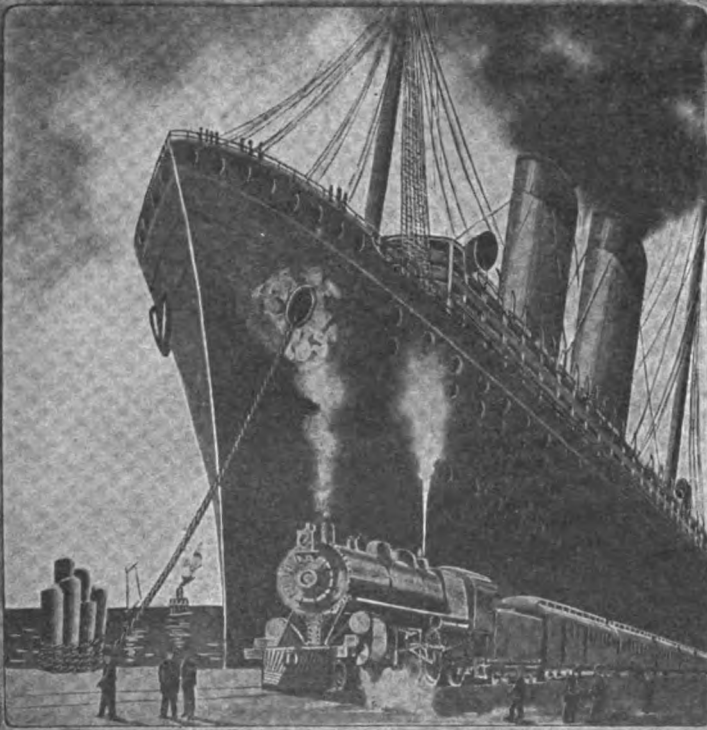

OFFICIAL ORGAN OF THE
INTERNATIONAL BROTHERHOOD
OF BOILERMAKERS, IRON SHIP BUILDERS
AND HELPERS OF AMERICA

HEADLIGHT OVERALLS

UNION MADE

Lots of cloth
through seat
and thigh
There's comfort
in every
wrinkle.



*This ticket
your guarantee*

Larned, Carter & Co.

WORLD'S GREATEST
OVERALL MAKERS

• FACTORIES •

Detroit, Port Huron, Mich.
St. Louis, Mo., Sarnia, Ont.



SECURITY SECTIONAL ARCH

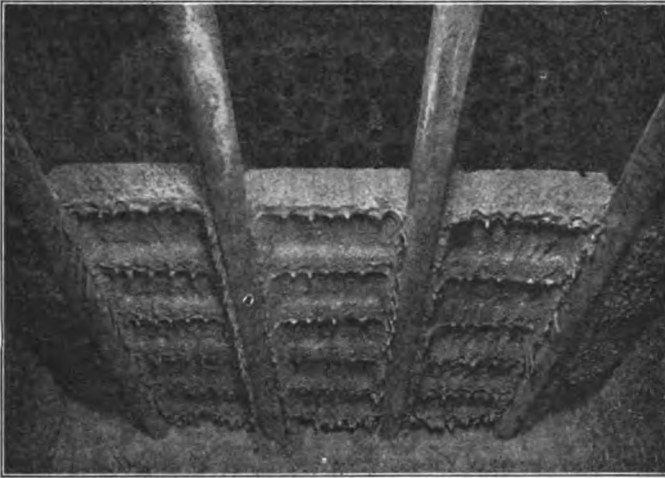

This arch is of light weight
It is built up of small sections
So made as to cool off quickly
It is easily removed for work
Made so to help the boilermaker

AMERICAN ARCH COMPANY

30 CHURCH STREET, NEW YORK

McCORMICK BUILDING, CHICAGO

You know OVERALLS,
Uniforms, Shirts, etc., are



if they have
this  mark
on the back of
the material on
the inside of the
garment.

*It's the cloth in the
garment that gives the
wear.*

Stifel's Indigo Cloth

Standard for over 75 years.
Its continuous use by three generations
of the "men of the road," factory and
field is certain proof of extraordinary
quality. Stifel Indigo wears like leather.
Every washing makes it like new.



This little mark is put
on the back of the cloth
on the inside of the gar-
ments for your protec-
tion. Look for it before you buy.

Cloth manufactured by
J. L. STIFEL & SONS
Indigo Dyers and Printers
WHEELING, W. VA.

— SALES OFFICES —

NEW YORK.....260-262 Church Street
CHICAGO.....223 W. Jackson Boulevard
SAN FRANCISCO.....Postal Telegraph Building
ST. JOSEPH, MO.....Saxton Bank Building
ST. PAUL.....238 Endicott Building
TORONTO.....14 Manchester Building

Price List of Supplies

B. M. and I. S. B. monthly due stamps, each.....	\$1.00
Helpers' monthly due stamps, each.....	.80
Apprentices' monthly due stamps, each.....	.80
B. M. and Ship Builders' initiation stamps, each.....	1.00
Helpers' initiation stamps, each.....	.50
Apprentices' initiation stamps, each.....	.50
B. M. or Iron Ship Builders' out of work stamps, each.....	.20
Helpers' out of work stamps, each.....	.10
Apprentices' out of work stamps, each.....	.10
Universal reinstatement stamps, each.....	.50
Local assessment stamps, per 100.....	.25
Subordinate Lodge or District Charters, each.....	2.00
Seals, each.....	2.75
Punch, each.....	1.00
Ledger, 400 page, each.....	2.50
Minute Books, 400 page, each.....	1.50
Journal or Day Book, 400 page, each.....	1.50
Monthly report books, each.....	1.00
Receipt book, Treasurer, each.....	.25
Warrant book, R. S., each.....	.25
Receipt book, members B. A. or F. S., each.....	.25
Rituals, each.....	.20
Duplicate due books, B. M. or H., each.....	.25
Due books, B. M. or I. S. B., each.....	.10
Due books, Helpers, each.....	.10
Constitutions, each 5c, or per dozen.....	.50
Letter heads, ruled, per 100.....	.70
Letter heads, unruled, per 100.....	.70
Envelopes, per 100.....	.60
Application blanks, B. M. or H., per doz.....	.10
Delinquent notices, B. M. or H., per doz.....	.10
Withdrawal cards, B. M. or H., each.....	.10
Clearance cards, B. M. or H., each.....	.02
Ballot boxes, each.....	1.25
Gavels, each.....	.25
Ballot balls, white or black, per doz.....	.10
Rolled gold charms, each.....	1.75
Solid gold charms, each.....	5.00
Official Emblem buttons, small size, ea.....	1.00
Official Emblem buttons, large size, ea.....	1.50
Official Ribbon Badges:	
1 badge.....	1.50
2 or more, each net.....	1.25
6 or more, each net.....	1.00
12 or more, each net.....	.75

Free.

- Labels.
- Supply Blanks.
- Grievance Blanks.
- Pedigree Blanks.
- Affidavit Blanks.
- Blank Bonds.
- Strike Rolls.
- Roster Blanks.
- Trial Blanks.
- Application for Bonds.

District Lodge.

100 Letterheads.. \$1.50	100 Envelopes.. \$1.00
200 Letterheads.. 2.25	200 Envelopes.. 1.50
300 Letterheads.. 2.50	300 Envelopes.. 1.75
400 Letterheads.. 2.75	400 Envelopes.. 2.00
500 Letterheads.. 3.00	500 Envelopes.. 2.25
600 Letterheads.. 3.25	600 Envelopes.. 2.50
District due stamps, per 100.....	.25
District assessment stamps, per 100....	.25

Secretaries must keep a duplicate of all orders on file in their Lodges.
Secretaries shall give full name and correct address and number of articles wanted in the left hand margin.

**No Supplies Sent Unless Cash
Accompanies the Order**

The Boilermakers' Journal

Official Organ of the

International Brotherhood of Boilermakers Iron Ship Builders and Helpers of America

Vol. XXVII.

KANSAS CITY, KAS., AUGUST, 1915.

No. 8.

LAWSON'S TRIAL—THE INFAMY OF IT.

Some time last year Mr. L. M. Bowers of the board of directors of the Colorado Fuel and Iron Company wrote to John D. Rockefeller Jr.:

"You will be interested to know that we have been able to secure the co-operation of all the bankers of the city, who have had three or four interviews with our little cowboy governor, agreeing to back the state and lend it all the funds necessary to maintain the militia and afford ample protection so that our miners could return to work or give protection to men who are anxious to come up here from Texas, New Mexico and Kansas, together with some states further east. Besides the bankers, the Chamber of Commerce, the Real Estate Exchange, together with a great many of the best business men, have been urging the governor to take steps to drive these vicious agitators out of the state. Another mighty power has been rounded up in behalf of the operators by the gathering together of fourteen of the editors of the most important newspapers in Denver, Pueblo, Trinidad, Walsenburg, Colorado Springs and other of the larger places in the state."

Is it not an indisputable inference from this hilarious statement to the dominating power in Colorado industries that these interests were lined up for a definite purpose? The nature of the purpose became evident in the pressure brought to bear upon the miners, forcing them to return to work for the need of bread without having secured recognition for their rights as free workers.

The purpose became more evident later. The state legislators—among those whom Mr. Bowers had "lined up"—passed a law providing for a special judicial district. Mr. Granby Hillier, who had been attorney for the Colorado Fuel and Iron Company and allied coal companies concerned in the strike, was made judge of the new district. He was to preside at the trials of strikers.

Before this tribunal of justice was brought John R. Lawson, executive board member of the United Mine Workers of America,

charged with the crime of being a leader of the miners who had struck for their rights as free workers and as citizens under the laws of the state of Colorado. Plainly it was not John R. Lawson who was on trial, but organized labor.

Let us see the further actions of some of those whom Mr. Bowers had "lined up" for the Rockefeller interests against the men who dared aid their fellow workers to obtain some consideration for their rights and interests. For instance, in Colorado, Attorney General Fred Farrar boasts that in the case of John R. Lawson he has secured the first conviction of a strike leader on the charge of being directly responsible for the death of a man who had been killed in a strike riot.

Jesse G. Northcutt, the prosecuting attorney, had formerly been attorney for the Colorado Fuel and Iron Company.

The jury, made up of men brought in from the highways and byways, was chosen by open venire instead of drawing names from the jury box. Among those jurors was W. W. Wilson, traveling salesman for the National Biscuit Company. According to general information, Mr. Wilson has exclusive right to sales in the Colorado Fuel and Iron Company district.

The bailiffs in charge of the jury were mine guards.

One of the witnesses against John R. Lawson was Lieutenant K. E. Linderfeldt. Linderfeldt! The man who killed Louis Tikas, who was tried before a military court for the death of the Greek, found guilty of unsoldierly conduct and reprimanded. John R. Lawson was tried before this specially prepared tribunal, found guilty, not of murder or violence, but because he belonged to a labor organization, the members of which were on strike and who defended themselves, their wives and children against wholesale slaughter. He was sentenced to imprisonment for life.

Does not this trial, or rather this persecution, of John R. Lawson verify the statement of Mr. Bowers that steps had been taken "to drive these vicious agitators out of the state?" What more effective method could

have been chosen than to put the leader in prison, aye in prison for life?

Is it not evident that this is part of a deliberately planned and executed scheme to get rid of labor agitators whose agitation would inevitably result in greater freedom and justice to the miners?

The organized labor movement of America will not submit to this manifest injustice and travesty of the rights of free men. And the workers must bear in mind that they will never have the rights of free men nor the opportunities of liberty until they assert their rights and make their demands effective.

Their hope for the future lies in economic organization. When that is attained, opportunity for exercise of rights and necessary activities for self-betterment is made possible.

Even the Rockefeller millions cannot block the irresistible power of free workers who know their rights and have an organization to enforce them.

Organize, miners of Colorado, and you can make effective protest against great injustice done to John R. Lawson. You can rescue this faithful leader from a living death. The labor movement of America is with you, to support your demands by co-operation and affirmation. Liberty-loving men the country over will unite to right this great wrong. Meet, protest and demand that there shall not be one law for Lawson and another for Rockefeller and other Rockefellers even of another name.

Organize for freedom and justice!

SYCOPHANCY AND CALLOUSNESS.

"The most powerful single force to effect social justice in Colorado is the conscience of young Mr. Rockefeller." Thus spake SIR Mackenzie King. And those listening to the words of the smug, self-confident Canadian baronet fairly gasped at the keen shock—an agent of the Rockefeller interests had declared all had surmised. But this self-acclaimed labor expert remained unperturbed.

For days Chairman Walsh of the Commission on Industrial Relations had been probing for the conscience of young Mr. Rockefeller—had been seeking to cut through technicalities, mechanical routine and the impersonal conduct of corporation business, in an effort to touch and establish the personal relations that entail personal responsibility. But young Mr. Rockefeller was evasive, noncommittal, cryptic; he was punctiliously precise as to immaterial details; in phraseology he was as fastidious as a hair-splitting scholastic; he cheerfully endorsed principles but either denied their application or refused to commit himself. Except when compelled by the chairman of the commission, his replies were perfectly true, perfectly general, perfectly meaningless—a finished product of Wall Street diplomacy.

And yet it was in the solution of a great human problem that young Mr. Rockefeller

was asked to co-operate. Though the problem affects the lives and welfare of millions, yet Mr. Rockefeller assumed the attitude of tolerant condescensions which apparently concealed indignation that his motives and his acts should be questioned or that he should be asked to explain. These replies were those of a skillful lawyer careful to evade self-incrimination.

He seems to believe in the impersonal nature of all business relations—capital, wealth, machinery—human beings were only "business agencies" necessary for securing results. The power, the effectiveness, the technical side of business were what interested him. The throbbing hearts of the people, the effect for weal or woe upon countless human lives, were considerations wholly without the impersonal business structure the Rockefeller millions had created. But it is the raw human life material involved that gave Mr. Rockefeller his tremendous power—power that he seeks to disclaim.

He professes that his employes and agents are free to follow their own best judgment—and yet so great is his power that his expressed wish or suggestion becomes a command. As he proved by his testimony, he rarely directed the policy to be adopted or gave a specific order to an agent, but he also proved that he has "suggestions" conveyed by other agents, thus maintaining the impersonal fiction. A suggestion from an industrial imperator is of the same force as a suggestion from a political imperator.

Mr. Rockefeller shrinks from crude human suffering and raw hurts. He testified that he read only the headlines concerning the strike breakers' attack upon unarmed strikers at Roosevelt, New Jersey; that he had not read reports of military hearings in Colorado or of the Zancanelli and Lawson trials. He refused to look at the postcard picture of a little boy killed in the Colorado strike.

Though he shrinks from personal relationships, he cannot escape responsibility for the wrongs, the wounds, the death his system inflicts upon wage earners. Though he close his eyes to the physical, the mental image must haunt him.

Is it ethically right for a man to regard only the large general relations of business and ignore those things that constitute personal relations? Ought great power to be exercised by an individual who lacks the bigness of heart and imagination to see every act illumined with meaning in terms of human life and the tremendous possibilities in even the most humble persons?

Mr. Rockefeller has now within his hands an opportunity as tremendous as was ever offered to any other person, but he will not have that opportunity indefinitely. If he will lay aside other matters of less importance than life and human justice and go to Colorado and make a whole-souled, personal investigation for the purpose of establishing justice and humanity in his re-

lations with employes in the Colorado coal mines and then use for humanity all of the skill and efficiency and power that has formerly been at the service of profits, he will have realized his full opportunity. He has committed a great wrong—his atonement must be equally great.

The well-known agents of his interests are seeking the lives and the liberty of men because they are prominent in labor unions. How can Mr. Rockefeller and his associates in the management of the mines hope justly to escape indictments?

The opportunity is now Mr. Rockefeller's, but it may pass him unheeded, and then? Well, the workers will organize though the machinations of the Rockefeller system oppose and will wrest from the powers that be the right to organize, to establish a better standard of work, of life, of justice, and of humanity.—Federationist.

LABOR'S AMENDMENTS PRESENTED TO THE NEW YORK CONSTITUTIONAL CONVENTION.

A meeting of the executive council of the New York State Federation of Labor was held in Albany, May 24-26, 1915, for the purpose of formulating amendments providing for the protection and the promotion of the interests of the wage earners in the new state constitution. The importance of this work can be appreciated when it is recalled that the group of labor men who formulated these amendments represented directly over 700,000 members of organized labor, and indirectly their families, those dependent upon them and the unorganized wage earners.

Because of their sense of grave responsibility, the executive council had the assistance of many representatives of local unions within the state, representatives of twenty-five international unions, among whom was the president of the American Federation of Labor.

Mindful of the nature of constitutional amendments and yet aware of the importance of safeguarding the fundamental rights of the wage earners, the committee prepared the following amendments. These were presented and argued by Samuel Gompers to the Constitutional Convention Industrial Relations Committee to be considered by that committee and reported upon to the Constitutional Convention.

These amendments are of more than ordinary importance because they conserve that which is of greatest importance to the state—its citizens. The welfare of millions of human beings will be protected and furthered by the incorporation of labor's amendments in the constitution of the state of New York; opportunity for human freedom, industrial and political, will follow their ratification, and human rights will be ac-

corded recognition due their importance. The amendments which constitute labor's bills of rights follow:

1. Resolved, That the constitution contain a provision as follows: "That the labor of a human being is not a commodity or article of commerce, and the Legislature shall not enact a law and the courts shall not construe a law contrary to this declaration."
2. Resolved, That any act which any person may legally and lawfully do shall be held to be legal and lawful when done by two or more in concert.
3. Proposing an amendment to Article 1 (Section 19 and new section), providing that nothing contained in the constitution shall be construed to limit the power of the Legislature to enact laws for the protection of the lives, health, safety, comfort or general welfare of employes.
4. For power to enable the state to insure workers against accidents, sickness, invalidity, old age and unemployment.
5. To provide a state fund, to insure employers against a risk of workmen's compensation, to the exclusion of every other form of compensation insurance.
6. That there shall be a Department of Labor, a Compensation Commission (function separated) provided for in the constitution.
7. Empowering the state and its several political divisions to undertake such public works and engage in such industries as they deem necessary to the public welfare for the purpose of relieving distress from unemployment or other extraordinary emergencies.
8. Abolish the power of the courts to nullify laws regularly passed by the Legislature or the voters of the state by means of referendum on the ground of alleged unconstitutionality.
9. Insure the right to trial by jury in all criminal or quasi-criminal prosecutions where the offense charged is punishable by imprisonment, including all cases of contempt of court.
10. To provide that the writ of habeas corpus shall never be suspended, and that military tribunals shall not exercise civil or criminal jurisdiction over citizens while the regularly constituted state courts are open to administer justice.
11. For the extension of popular rule and control of officials by the initiative, referendum and recall.
12. Favor election of all judges. Election to take place at time no other officer is elected. Ballots to contain no party emblem. Candidates to be grouped under title of office.
13. Resolved, That this special convention of the New York State Federation of Labor declares itself in the interest of the masses

of the citizenship of the state of New York against the abandonment of the annual sessions of the New York State Legislature.

14. Resolved, That the terms of the elective officers of the state of New York shall not be extended.

15. That the terms of the state senators shall be for a period of one year.

16. Resolved, That the delegates to constitutional conventions be elected at a time when no other state officials are to be chosen, and that no party emblems be used at such elections.

17. Resolved, With a view of having the members of the Legislature in a more independent position financially, this conference recommended to the constitutional convention the wisdom of raising the salaries of the members of the Legislature to an adequate amount.

18. To amend procedure necessary to pass a bill (now found in Section 15, Article 3) so as to take from the governor the nullifying of that section by the use of emergency messages.

19. Against the state constabulary and the employment of private armed forces in labor disputes. That the governor of the state be the commander-in-chief of the army and naval forces thereof, and that as such commander he alone be empowered to call out any portion or the whole of said forces or either of them in time of need.

20. Resolved, That this conference of the executive council and representatives of labor of the state of New York go on record in favor of the constitutional amendment as adopted by the Legislature, to be voted upon at the coming election for woman suffrage, and that all are urgently requested to support the ratification thereof.

21. Resolved, That inasmuch as the so-called "short ballot" is a proposition to vest greater powers in the hands of the chief executive of the nation, states and municipalities, it is in violation of the fundamental principles of justice, democracy and freedom. The proposition should therefore not be indorsed but condemned and opposed, and it is hereby condemned.

22. Free speech and free press.

Every person may freely speak, write or publish his sentiments on all subjects, being responsible for the abuse of that right, and no law shall be passed by the Legislature to restrain or abridge the liberty of speech or of the press. Nor shall any officer or court of the state, or officer or court of any political division of the state abridge enjoin or restrain the liberty of speech or of the press. The question as to whether the rights of freedom of speech or of the press have been abused shall be determined by a jury. In all criminal prosecution for libel, no person shall be found guilty and be punished where the matter alleged to be libelous be true unless the alleged matter was

written and published with criminal motives and for wrongful ends.

23. Eight Hours.

In all cases of employment by and on behalf of the state, or any political division thereof, or in any contract for labor or for supplies, by or on behalf of the state, or any political division thereof not more than eight hours in any twenty-four consecutive hours shall constitute a day's work.

24. Capital Punishment.

Capital punishment, that is death penalty for crime, is hereby prohibited.

—American Federationist.

TYPHOID FEVER IN CHICAGO.

An analysis of the typhoid fever situation in Chicago for the first four months of 1915 shows that there were 271 cases during that period. Investigation revealed the source of the disease in 79 cases, or 29 per cent, which was as follows: Imported, 28, or 10.33 per cent; infected by carrier, 5, or 1.85 per cent; contact from typhoid cases, 16, or 5.9 per cent; contracted from unpasteurized milk (one dealer), 30, or 11.07 per cent. The death rate per 10,000 of population during these months was 0.1430. The analysis further shows that the disease prevailed more largely in certain districts getting their water supply from lake stations the water from which shows either constantly or periodically considerable colon contamination. The report of the department laboratory containing the result of four years' examinations of the city water, also referred to in the bulletin from the department, from which the above facts are taken, shows that the water from certain of the lake stations, notably the Lake View Station and the Two-Mile Crib, are contaminated usually above the average of the city supply, although there has been a general improvement at all of the stations. Chemical treatment of the water has been begun at some stations. Sewage from north shore towns seems to be the source of contamination of the water of the north shore, as revealed by a survey made by the department in connection with the North Shore Sanitary Association.—The Journal of the American Medical Association.

FIRST TIME IN HISTORY OF NATION FOR LABOR TO BE SO RECOGNIZED.

There will shortly come from the mints of the United States Government a special gold dollar bearing the image of the face of a laborer, commemorative of the Panama-Pacific Exposition. Twenty-five thousand of the coins will be issued. They will commemorate labor's share in the building of the nation and will be a recognition of the workmen who constructed the Panama Canal. The emblem of labor will be on the obverse side and on the reverse side a representation of two dolphins, typifying the oceans. It is the first time in the history of the nation that labor has been thus recognized.—The Square Deal.

THE BOILER MAKERS' JOURNAL

Official Organ of the International Brotherhood of Boiler Makers, Iron Ship Builders and Helpers of America.

A Monthly Publication Issued the First of Each Month from Room 8, Law Building, Kansas City, Kansas.

JAMES B. CASEY, Editor and Manager.

Subscription Price.....\$1.00 Per Year in Advance

ADVERTISEMENTS.

Advertising Rates Will be Furnished Upon Application to the Editor-Manager. No Reading Space Will be Sold for Advertising Purposes Under Any Circumstances.

All New Members Must Have Their Name and Address Sent in Through the Secretary of Their Lodge. After That They May Have Changes Made in Their Address by Filling Out Blank Form in Back of Book and Forwarding to the Editor.

All Copy Must be Received by the Editor by the 15th of the Month to Insure Publication in the Following Issue.

All Contributions and Correspondence Relating to the Journal Should be Addressed to J. B. Casey, Editor, Room 8, Law Building, Kansas City, Kansas.

Entered at Postoffice, Kansas City, Kansas, as Second Class Mail Matter.

IDAHO SETS A SPLENDID EXAMPLE.

The State of Idaho has solved the problem of unemployment, and blazed the way for the other states to follow.

The recent session of the Legislature of that State passed an "emergency employment law," which requires that the County Commissioners shall furnish employment to all bona fide citizens who appear and make oath that they cannot obtain employment and that they do not own more than one thousand dollars' worth of property and that they will perform such work as may be assigned them.

This emergency work is limited to sixty days a year to any one person.

With such a law in force in all of our states, there would be a guarantee to every one who was willing to earn his bread by the sweat of his brow, that he would be given the opportunity to provide for his needs and still retain his self respect.

Such a law would have been a boon to hundreds of thousands during the past year, during which time so many sought in vain, far and wide, for work, and many were no doubt brought to the verge of starvation. With such a system in vogue, the panhandler and the moocher would have to disappear, as there would be no excuse for their existence. All who wanted work could get it and those who want to live without work should be given little consideration. Organized, professional charity, too, would cease to be a reality, with all of its defects and deficiencies.

The world is slowly but surely making for better conditions for the masses, as witnessed by the extension of our compensation laws, which are lifting the burden of industrial accidents from their shoulders and putting it on society in general; the extension of female minimum wage laws, which, while possibly not proving so efficient as they might, still have a sentiment behind them that promises better conditions for the female workers of the future, as does also the widows' pension law.

The old age pension plan is gaining in public favor and the time will soon come when it will be made a reality in all of our states. Altogether we can look forward with hope and confidence toward the future for better

conditions. Idaho has just taken a big step forward in the right direction and set a splendid example for the older states to follow.

THE IMPORTANCE OF KEEPING YOUR ADDRESS CORRECT.

As we have already received a large number of requests for back numbers of the Journal, and especially June issue, and as we cannot furnish back numbers, we desire to again try to impress upon all of our members the importance of promptly giving to the secretary of their lodge any change they may make in their address. It is much more important to notify their secretary than the Editor, for the secretaries are supposed to prepare a new list of names and addresses every quarter and unless your address is known to him, your name is liable to be left off or a wrong address given. Often after receiving complete lists from some of our lodges and our mailing list corrected according to this list, we receive a number of journals sent back by the post office officials and postage collected, because we were previously notified that journals were not being delivered to party named with this address, and we find we had a couple of months previously taken these names off the list.

While it is the duty of the secretaries to send in these lists to us, it is the duty of the members to keep him supplied with their correct address and any change they make should be promptly reported, and the best means of doing so is to secure a post card or write a letter to him and give your correct address and request him to notify this office. He may receive a number at the same time and can send all at once, and he will be sure to have your correct address for use in sending complete lists. If you wait for meeting nights you may not be able to attend meeting or forget to give same to the secretary, so it is much better to write. But no matter the way you go about it, don't let it slip your mind for five or six months and want to claim back numbers of journals, when they have been going to your old address all along, and being thrown in the post office waste basket. Act promptly.

STRIKES DECLARED OFF.

Following the action of the Executive Board of the Railway Department in declaring off the strikes on the Harriman Lines, Illinois Central and Pere Marquette railways, effective June 28th, our Executive Council called for another vote of the men involved, with a recommendation that they take a like action. The result of the vote was about four to one to call off the strike, and in accordance with the same, strikes, in so far as they affect our members, were declared at an end on and after Monday, July 5th, 1915.

Thus ended these strikes, which have been on so long and involved all of the shop trades on these roads. These strikes were inaugurated under adverse conditions—dull times, little money in the treasury to sustain the men, etc. However, they were bravely and heroically waged by the men, notwithstanding these handicaps, and many sacrifices were made by them. These efforts were worthy of a better result, and it is hard for many of those who made the heroic efforts and sacrifices to reconcile themselves to the

situation. However, under the circumstances there is nothing to do but to wipe the slate clean and commence over again. We are informed that some of the officials of some of these roads have expressed themselves as desiring to have their old men back, and we hope that as far as possible all the men will be returned to their former positions, and that both sides will forget their difference of the past and turn their faces resolutely to the future. Both sides have learned valuable lessons from these strikes, that, if heeded, will serve a good purpose in the future. The roads have found that the shop mechanics are a big factor in conducting a railroad and that it is almost impossible to secure a full corps of competent men to fill these places when they go on strike, and that it is a very expensive experiment to undertake to do so. The men have found that they have not only got to have a complete organization and a full treasury, but that industrial conditions have got to be favorable in order to win a strike; and furthermore, a strike at best is a two-edged sword that cuts as deep, if not deeper, into the slender means of the men on strike as it does into the dividends of the company. Therefore, we should exhaust every possible means to settle our troubles before engaging in a strike. Furthermore, we should weigh the possibilities of success from every standpoint, and if we find conditions against us, it would be better to work under protest until a more favorable time, than to immediately engage in a disastrous strike.

We believe the officials of the roads have found that the points of difference between themselves and the men were not such bugaboos as they thought; the main point of difference was, we believe, the recognition of the System Federation. Since these strikes have been on all of the roads in the Southeastern States have not only recognized the System Federations, but a federation of federations and all questions of difference between them have been amicably adjusted; with the light of this experience before them we believe the officials of the roads in question would act differently. If by our conduct we can convince the employers that we only ask even handed justice and they will convince us that it is not necessary to engage in strikes in order to secure this, a long advance towards solving the problems of the future will have been made.

Word was received at headquarters on the Fourth of July that Lodge 592, of Tulsa, Okla., had at its meeting the night before declared off the strikes in the oil fields of that state. A large number of men were involved and it seems that depressed industrial conditions had its effect in this strike also, notwithstanding the fact that our organization paid strike benefits to all members as long as they were entitled to them, the strike was not a success.

The difficulties surrounding this strike was worse and harder to reconcile because the contractors, backed by the Erectors' Association, declared for an open shop and terminated all agreements, and as long as they maintain this unjust attitude we cannot reconcile any differences.

However, as times get better and the demand for men increases, they will have to descend from their high position and the men will be in a position to retaliate with interest.

One of the greatest factors in helping to defeat the men sprung from a practice that was indulged in extensively in that field. It was the working of hundreds and hundreds of permit men. Most of these men were farm hands that were permitted to go to work and be broken in driving rivets by the experienced men, when no card men were available. As a kind of a recompense the lodge collected 10 per cent of their wages each week (which was the same as that paid by the experienced men). These men were not organized and did not understand the principles of organized labor, and were therefore ever ready to follow the bidding of the bosses. They got as much under open shop as union conditions, and had no concern for the organization, hardly realizing that it was due to its efforts that they were being paid high wages. These men being broken in were invaluable to the contractors when the contest came. Our members in the future should remember when they break in farm hands to do their work, they are cutting their own throats. With these strikes declared off, we have only a few small affairs left; therefore, it seems to be a good time for us to resolve to devote all our time and efforts for the next couple of years towards organizing and the building up of a strong treasury so that if afterwards we should have to engage in contest, we will have the means of sustaining our members, and the men in our organization where we can control them.

WAS THE McNAMARA GRAND JURY A HAND PICKED ONE?

Evidence has come to light recently which tends very strongly to show that the grand jury which indicted the McNamara brothers, and others in the dynamiting cases in 1910, received the indorsement of the official representative of the Merchants and Manufacturers' Association before they were definitely selected and summoned to act.

It would seem that District Attorney Earl Rodgers submitted a list of the names drawn before they were made public to F. J. Zehandelaar, secretary of the Merchants and Manufacturers' Association of Los Angeles, and the latter answered by letter, which has recently come to light, in which he O. K.'d many of them, as being personal friends, strongly with us, on our side, strongly anti-labor, etc. This letter was produced in court and used as one of the reasons why the indictment against Schmidt and Coplan should be quashed and so far we have seen no denial of its authenticity. It was further charged that District Attorney Rodgers himself was in the employ of the Merchants and Manufacturers' Association, as its attorney, until he was selected as district attorney.

If these charges are authentic, then there was no wonder that indictments were promptly returned. This corruption of the courts of justice should be strongly repudiated and condemned by all who love liberty and even handed justice.

There have been enough victims offered up to satisfy the avaricious and vindictive appetite of this vicious association, and Schmidt and Coplan should be given their liberty.

This farce of selecting a jury and rigging out a court was gone one

better in the Lawson trial in Colorado, where a venal legislature selected the attorney for the mine operators as presiding judge, and most of the jury seemingly were selected because of their supposedly being under the influence of the mine owners. One juror, with some conscience left, held out for acquittal and was finally induced to change his vote by one of the court attaches telling him his wife was dangerously sick, and his only promise of release, so that he might go to her side, was to change to a verdict of guilty. The story of her sickness was false and made to induce him to change his vote.

These detestible pollution of the springs of justice will soon destroy our rights and liberties if allowed to continue. The corruption of our jury system is worse in its effects upon our free institutions than the crime for which the McNamaras were sentenced.

BURLESON AGAIN RECOMMENDS GOVERNMENT OWNERSHIP OF WIRES.

According to a recent Washington dispatch in the daily papers Postmaster General Burleson will again recommend that the government acquire and operate all utilities for the transmission of intelligence and that these be incorporated with the Postoffice Department and be made a part thereof. Mr. Burleson appointed a commission of postoffice officials to investigate this subject and they strongly recommended government ownership, and as a result of this report he recommended in his annual report last year that this course be followed.

The experiences of the European War has greatly emphasized the importance of this matter and we cannot ignore or put off action much longer. In fact, we should have done this many years ago and not allow these companies to build up enormous monopolies at the expense of the people. Ours is the only great nation of the world that permits such slipshod, inefficient methods to exist. All other nations own their telephone and telegraph lines. Furthermore, we have found, since the European War began, that it was necessary, in order to preserve our neutrality, to take over the wireless stations, and the Navy Department is operating these through an agency. Private ownership of wires, in case of war with a foreign nation, would be absolutely dangerous, and these wires would, soon after hostilities commenced, have to be taken over, and we should not wait for a calamity of this kind to overtake us before acting, but we ought to follow promptly Postmaster General Burleson's advice and make this change now.

Such a change would mean a saving to the public of millions upon millions each year, besides a more efficient service both in telephone and telegraph. Furthermore, large amounts could be saved in the present cost of operating these lines by combining them with the postoffice, which could be applied in paying better wages to operators and the other employes.

However, we should not purchase these lines at anything like their capitalization or bonded indebtedness, but at their real value. That is what it would cost to reproduce them. Otherwise we would be saddling upon

posterity an enormous indebtedness that represents no value. Corporation capitalization and bonded indebtedness of the past and present is a stench in the nostrils of honest business.

AMERICAN EXPORTS REACH A HUGE TOTAL.

According to a recent report made by the Department of Commerce our imports for the past eleven months amounted to \$1,516,474,600, and our exports for the same time was \$2,499,592,079, thus leaving a trade balance in favor of the United States of about \$1,000,000,000. In other words, we sold to other nations one thousand million dollars worth more than we bought from them. This is by far the greatest trade balance in the history of American commerce.

Some of the larger items of export responsible for this increase are: Breadstuffs, \$400,000,000; sale of animals (horses, mules, etc.), \$60,000,000; automobiles, \$25,000,000, and increased sale of meats and dairy food products, \$45,000,000. While no statistics in reference to iron and steel products are available these will represent a large proportion of the balance of this amount. With this golden stream of wealth flowing into the lap of American commerce, dull times should pass and the wheels of commerce begin to hum again.

Many of the railroads are still holding back, working short hours with reduced forces, thus putting off making extensive and badly needed repairs. They have had to readjust their finances, large sums borrowed from Europe have fallen due in the past year and much of these obligations have been paid from the earnings; however, the worst of this situation has passed and from now on the roads should be in a position to do more repairs than they have done during the past year.

With the nations at war spending fabulous sums each day and constantly increasing these amounts they bid fair to be bankrupt at the end of hostilities.

The center of the money market of the world has already shifted from London, Paris and Berlin to New York and Washington and for a long time to come the business world will depend upon this country to finance its enterprises.

From all indications this country will enjoy an unprecedented period of prosperity, and at an early date, and an early termination of the European War would hasten it on.

A FEDERAL DISTRICT COURT WHITEWASHES THE STEEL TRUST.

Some time ago the Federal Department of Justice instituted a suit in the district court at Trenton, N. J., to dissolve the United States Steel Company (steel trust), and a vast amount of evidence pro and con was submitted, and the suit was waged under the provisions of the new anti-trust act. The court recently "handed down" a decision in favor of the steel corporation, and had the attorneys for the corporation written this decision

they could not have made it any stronger in favor of the trust than it was. The decision is a distinct disappointment to all those who firmly believe this corporation is an unlawful and vicious corporation in restraint of trade, and should be dissolved in the interests of and for the welfare of the people.

It is capitalized at \$1,402,846,000, and of this enormous amount it is said that \$600,000,000 is nothing but water, and much of the balance is badly diluted with the same kind of a liquid.

Officers of this corporation are responsible for the Gary dinners, where they would sit and eat with the few independent iron manufacturers and set the prices upon all iron and steel products. These dinners have been abandoned since the government has been prying into the affairs of this trust, but no doubt they have found some other means of arranging the price setting as before.

It seems to us this judge had to go a long ways to secure excuses to justify his action in rendering this decision, one of which was to the effect that "There is no evidence to show that a return to the old trade war system of ruinous competition would benefit the public interests." This argument is far-fetched and has nothing to do with the terms or provisions of the anti-trust laws, the intent of which seemingly was overlooked or ignored by this judge.

It is not in the province of a judge to pass upon the merits of different policies of government, but to render a decision in accordance with the terms of the law which is invoked to decide the case before the court.

This decision should be appealed and a fair decision of the matter be secured from the supreme court if necessary. Many other suits of a like nature are pending, all of which will be no doubt abandoned unless a reversal of the decision is secured.

What we need is a constitutional amendment providing for the election of federal judges. If we can secure the enactment of such a measure we will soon do away with such rank decisions. They will be more responsive to public sentiments.

AMERICAN SHIP YARDS TO HUM.

From all accounts American ship yards have before them a long period of activity in ship building. It is estimated that they now have on hand orders amounting to more than one hundred millions of dollars. This amount will likely increase rather than decrease for some time to come. In the past our foreign commerce has been carried in ships flying flags of other nations. Most of these are at war with each other, and since hostilities commenced last August, scores and scores of ships with a total capacity of hundreds of thousands of tons burden have been destroyed or sunk and most of the other ships have been either interned or commandeered by their government.

Therefore, necessity compels us to build a fleet of merchant ships to carry our commerce to the other nations of the world. Now that this period of activity is upon us, the ship builders should arouse and organize if they would reap a fair share of this prosperity. For the past ten or fifteen years

the men in the ship yards have not made much progress in organizing and as a consequence their wages have remained practically stationary during this period and they are not getting any more wages now than they did twenty years ago, notwithstanding the fact that the cost of living has nearly doubled in that time. Therefore, the average wages paid in these yards at the present time must furnish a very poor living for the men and their families.

However, no matter how low the standard of wages or how much higher the cost of living may go, there can be no adequate relief or improvement expected unless the men arouse to the importance of the matter and organize, and they cannot commence too soon for their own good. No doubt many of the old time ship builders were discouraged with the efforts to organize twenty years or so ago, and may hesitate to turn to the movement again, and there is justification for this feeling, for they are still suffering from the efforts of the hasty and ill advised strikes of the past, which not only destroyed their organization, but put the good active members on the bum also. These were in the pioneer days of organization, when too often our members had but a poor idea of the practical working of a union, and a local would no sooner be organized than the members would want to strike to see whether it was effective or not, and too often they would walk out without preparation or money in the treasury to sustain them, and as few of them were more than a couple of weeks from want they were easily defeated.

Should the men organize again it should be on saner and more conservative lines. Their policy should be a peaceable one; to exhaust every peaceable manner and to use the strike only as a court of last resort, and under no condition make any demands until two-thirds or three-fourths of all employes are organized. If they will follow along these lines and become thoroughly organized fair wages and good conditions will soon displace poor conditions and starvation wages.

AN ORGANIZED EFFORT TO EVADE THE SEAMEN'S LAW.

From various sources comes the information that ship owners, shipping interests and the Manufacturers' Association have organized for the purpose of defeating or evading the provisions of the new shipping laws, which requires humane conditions and English speaking seamen to man merchant ships with American registry.

The practice in the past has been to use Chinese to make up their crews. These work for starvation wages and the ship owners are trying by hook or crook to retain these crews, and the president of the Pacific Mail Steamship Company has even threatened to put his company out of business unless it is allowed to use these crews. This company is owned by the Southern Pacific Railway and made the same threat of going out of business when the Interstate Commerce Commission ruled that railroads must give up all ship lines owned or operated in conjunction with railroads, and that such ships could not use the Panama Canal; however, it did not go out

of business even though this order of the commission was not altered.

If American ships cannot use American crews and prosper then they should all perish. We have no sympathy for any enterprise that has to be run on such a low plane. We believe, too, the sentiment of a vast majority of our people are in line with our position.

Ship owners have insisted on the right to have their ships built in foreign ship yards and now want to man them with Chinese coolies. What advantage or benefit could such an enterprise be to our people, built upon such lines? They would be of no advantage except to a few sordid, selfish and greedy individuals that would sell their very soul for profits. Therefore, we say enforce this just and humane law, in the spirit in which it was passed by Congress.

SOME OF THE CONTRACT SHOPS OF ST. LOUIS TRY AN OPEN SHOP STUNT.

For a number of years the members of our organization in St. Louis have had agreements with all the contract shops in that city. This year owing to industrial depressions, it was decided to not ask for any changes in wages or conditions but to let the agreement, which was to expire May 1, continue on indefinitely; however, as agreements contained no continuance clause, some of the employers took advantage of industrial conditions and the Heine Safety Boiler Co., the O'Brien Boiler Co., and the Wangler Sheet Iron Co., declared for the open shop.

The Grand Lodge was appealed to and President Franklin detailed First Vice President Hinzman to assist Lodge 27 in adjusting the matter, and the Executive Council gave its sanction to resist this move, even to the extent of calling out every member of the lodge if necessary. It will be remembered the two industrial lodges in that city consolidated a short time ago and all those working in the contract shops are now in Lodge 27. At a special meeting of the lodge July 2, it was decided to vigorously resist this open shop move, and when the three above named companies tried to change some of the shop conditions, the men refused to accept the new conditions and all of our men in these shops were locked out and the shops have been closed since; however, these firms have repeatedly tried to get our members to go back to work, but without result.

There are eight or nine other shops in that city that have promised to be fair with our members, two firms have already signed up and several others will, no doubt, have done so before this reaches our members. With industrial conditions rapidly improving, the balance of the companies will be forced to sign up with the lodge, as our members there are in good shape and have a hundred per cent organization.

In the meantime all members seeking work should stay away from St. Louis, for under the circumstances there is no chance for work and their presence there would only complicate matters.

Vice President Hinzman remained in St. Louis for some time advising with the members there, interviewing the employers and trying to adjust

the matter, and informs us since his return that the prospects were bright for our members winning out with all shops at an early date.

PRESIDENT FRANKLIN'S SONS SICK.

We regret to have to announce the serious illness of President Franklin's oldest son, Virgil, who has been a clerk in the employ of the Kansas City Southern Railway for several years. A month or so ago he was suddenly seized with severe hemorrhages of the lungs and for a time his life was despaired of; however, he has since rallied and is now able to sit up and get around a little but is still very weak. One of his lungs is affected with tuberculosis and the doctor has ordered his removal to New Mexico.

As the Journal goes to press, Bro. Franklin leaves with him for Albuquerque, where it is confidently expected that he will be entirely restored to good health.

Another son, Harold, while on a visit to Pittsburg, Kansas, recently, was operated on for two or three different local ailments and was laid up for some time, but now has fully recovered and returned home.

Altogether Brother Franklin has had it pretty tough recently. The Journal extends its sympathy and hopes his luck will change for the better soon.

VISITORS AT HEADQUARTERS.

Mr. and Mrs. John Cure of Teague, Tex., and who were on a vacation trip, stopped over in Kansas City and visited headquarters recently. They report having had a fine time during their travels and expressed themselves as being well pleased with their trip. After a short stay in the city they left to visit relatives in Missouri and then to head for home.

They left with the editor, as a memento of their visit, a post card photo, which we reproduce in another part of this issue.

QUOTATIONS.

Envy is a weed that grows in all soils and climates, and is no less luxuriant in the country than in the court; is not confined to any rank of men or extent of fortune, but rages in the breasts of all degrees. Alexander was not prouder than Diogenes; and it may be, if we would endeavor to surprise it in its most gaudy dress and attire and in the exercise of its full empire and tyranny, we should find it in school masters and scholars, or in some country lady, or the knight her husband; all of which ranks of people more despise their neighbors than all the degrees of honor in which courts abound; and it rages as much in a sordid, affected dress as in all the silks and embroideries which the excess of the age and folly of youth delight to be adorned with. Since then it keeps all sorts of company, and wriggles itself into the liking of the most contrary natures and dispositions, and yet carries so much poison and venom with it that it alienates the affections from Heaven, and raises rebellion against God himself; it is worth our utmost care to watch it in all its disguises and approaches, that we may dis-

cover it in its first entrance and dislodge it before it procures a shelter or retiring place to lodge and conceal itself.—Earl of Clarendon.

Whatsoever convenience may be thought to be in falsehood and dissimulation, it is soon over; but the inconvenience of it is perpetual, because it brings a man under everlasting jealousy and suspicion, so that he is not believed when he speaks the truth, nor trusted when perhaps he means honesty. When a man has once forfeited the reputation of his integrity, he is set fast, and nothing will then serve his turn, neither truth nor falsehood.—Tillotson.

Without the permanent union of the sexes there can be no permanent families; the dissolution of nuptial ties involves the dissolution of domestic society. But domestic society is the seminary of social affections, the cradle of sensibility, where the first elements are acquired of that tenderness and humanity which cement mankind together; and were they entirely extinguished the whole fabric of social institutions would be dissolved.

Families are so many centers of attraction, which preserve mankind from being scattered and dissipated by the repulsive powers of selfishness. The order of nature is ever from particulars to general. As in the operations of intellect we proceed from the contemplation of individuals to the formation of general abstractions, so in the development of the passions, in like manner, we advance from private to public affections; from the love of parents, brothers and sisters to those more expanded regards which embrace the immense society of human kind.—Robert Hall.

It carries too great an imputation of ignorance; lightness, or folly, for men to quit and renounce their former tenets presently upon the offer of an argument which they cannot immediately answer.—Locke.

Conscience and the fear of swerving from that which is right maketh them diligent observers of circumstances, the loose regard of which is the nurse of vulgar folly.—Hooker.

STRIKES NOW IN FORCE.

- Atlantic Basin Iron Works (Shields & Moran, New York). (Strike on.)
- Hibbon & Co., contract shop, South Chicago, Ill. (Unfair.)
- Milwaukee Boiler Co., Milwaukee, Wis. (Strike on.)
- Stockton, Calif. (Metal Trades strike.)
- Des Moines Bridge & Iron Works, Des Moines, Iowa. (Erecting work at Bremerton, Wash., Valejo, Calif., and Norfolk, Va., Navy Yards.)
- Heinie Safety Boiler Co., of St. Louis, Mo. (Strike on.)
- Wangler Boiler & Sheet Iron Co., of St. Louis, Mo. (Strike on.)
- O'Brien Boiler Co., of St. Louis, Mo. (Strike on.)

Mechanical Department.

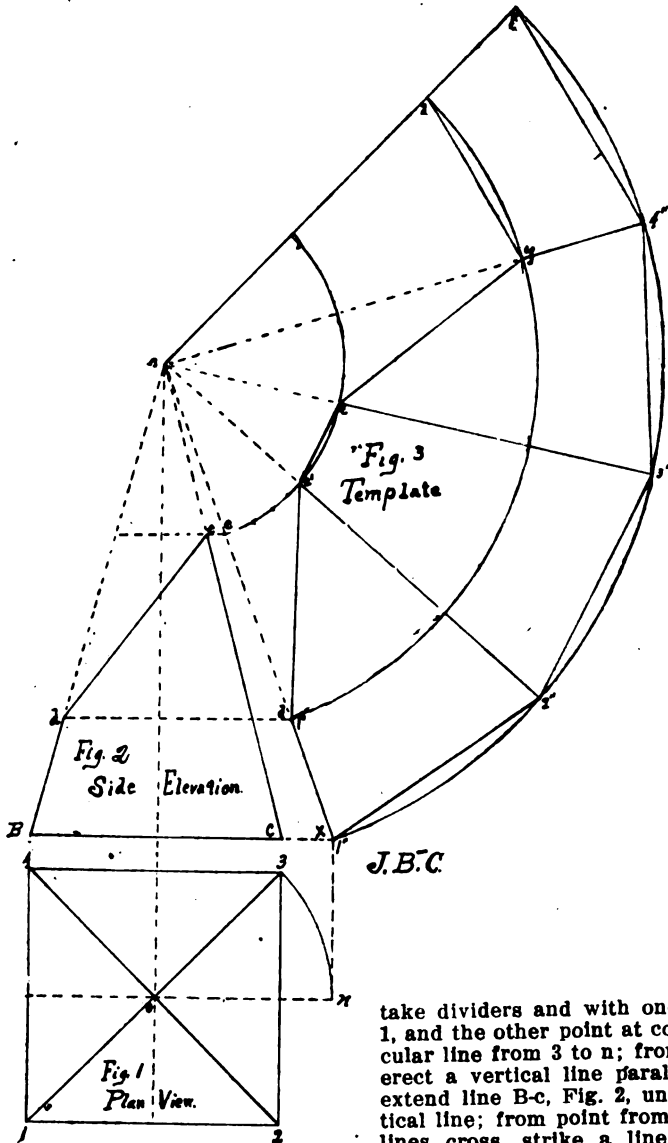

TO DEVELOP FRUSTUM OF A SQUARE PYRAMID CUT AT AN ANGLE TOP.

Fig. 1, shows the plan view, Fig. 2, the side elevation, and Fig. 3, the template.

To lay out template, first mark off plan view and side elevation the desired size and height, continue side lines of Fig. 2 on up until they cross each other at A; strike angle d-e at top of frustum and from these points (d-e), strike lines across cone, and at right angles to the center of same, extend lines out beyond side line c-e, next

take dividers and with one point at o, Fig. 1, and the other point at corner 3, strike circular line from 3 to n; from the latter point erect a vertical line parallel with line 2-3; extend line B-c, Fig. 2, until it crosses vertical line; from point from where these two lines cross, strike a line to A; this line will represent one side of template; from points e to d and x, Fig. 3, strike circular lines indefinitely. Take distance from 1 to 2, Fig. 1, and mark it from x to 2', Fig. 3. Next take distance from 2 to 3, Fig. 1, and mark it from 2' to 3, Fig. 3; continue in like manner with the other two sides and from these points strike lines to A; these will be the points for the bending. Strike straight lines from 1' to 2', 2' to 3', 3' to 4', and 4' to 1'. Next draw a line from 1 to y, Fig. 3; then from y to c, from e to e', and from e' to d. This will complete the template, add sufficient lap if desired.

International Officers' Reports.

July 20, 1915.

To the Officers and Members of All Subordinate Lodges, Greeting:

I herewith submit to you the vote taken in reference to the Illinois Central and Hariman lines and the Pere Marquette strikes:

Lodge	To Continue	To Discontinue	Lodge	Vote	Lodge	Vote	Lodge	Vote	Lodge	Vote	Lodge	Vote	Lodge	Vote	Total
4		6	4	6	6	
7	3	1	72	1	124	3	4	
22	3	1	137	1	84	1	88	1	426	1	4	
25	...	5	233	1	359	4	5	
27	...	1	363	1	1	
32	...	1	1	
38	...	15	38	15	15	
46	...	6	46	6	6	
48	4	...	48	4	4	
68	...	3	426	1	315	1	56	1	3	
70	1	3	315	1	46	1	90	1	106HD	1	4	
74	...	6	74	6	6	
80	...	4	52	3	72	1	4	
88	...	3	88	3	3	
90	...	1	1	
95	3	1	95	3	137	1	4	
96	1	1	74	1	1	
103	...	6	198	2	103	1	6	
111	...	1	11	1	1	
113	...	3	179	1	198	1	180	1	3	
116	...	4	220	1	284	1	124	1	399	1	4	
123	...	1	72	1	1	
124	2	...	124	2	2	
150	...	1	150	1	1	
161	...	2	133	2	2	
179	...	1	179	1	1	
180	1	5	180	6	6	
187	...	4	253	1	98	1	216	1	92	1	4	
198	2	...	69	1	198	1	2	
206	...	6	206	6	6	
209	...	2	166	1	74	1	2	
216	2	1	216	2	92	1	3	
220	3	7	220	9	102	1	10	
233	1	1	233	2	2	
242	1	...	553	1	1	
244	...	3	198	1	88	1	133	1	3	
246	...	2	224	2	2	
254	...	3	220	3	3	
284	3	...	284	3	3	
287	...	1	74	1	1	
293	...	4	137	3	300	1	4	
302	1	1	220	2	2	
305	...	1	300	1	1	
317	...	2	359	1	233	1	2	
322	...	2	363	1	220	1	2	
339	...	1	339	1	1	
356	...	1	356	1	1	
363	1	3	363	4	4	
364	...	1	220	1	1	
395	...	1	133	1	1	
403	...	3	137	2	253	1	3	
415	1	...	52	1	1	
422	...	1	315	1	1	
427	...	1	46	1	1	
434	...	5	220	5	5	
447	...	9	339	6	220	1	9	

Lodge	To Continue	To Discontinue	Lodge	Vote	Lodge	Vote	Lodge	Vote	Lodge	Vote	Lodge	Vote	Total	Lodge
454	...	7	102	2	220	4	7
464	...	1	74	1	1
483	...	2	189	1	46	1	2
475	...	6	475	6	6
486	...	1	408	1	1
518	1	1	52	1	74	1	2
528	3	5	94	1	201	1	474	1	555	1	359	2	198	2
541	...	2	40	1	137	1	2
567	...	1	408	1	1
568	3	3	553	2	72	2	233	1	220	1	6
588	...	3	220	3	3
595	3	...	474	2	72	1	3
599	1	2	300	1	137	1	180	1	3
605	...	3	46	1	198	1	52	1	3
606	...	1	553	1	1
Total	43	186	161	39	11	6	2	2	229					
The following is the list of votes received after June 28th, 1915:														
92	...	8	92	7	555	1	8
72	2	4	72	5	103	1	6
133	4	...	133	4	4
244	1	...	133	1	1
55	...	1	94	1	1
377	...	3	220	2	84	1	3
100	1	1	180	1	74	1	2
233	2	1	233	3	3
10	...	5	234	3	203	1	52	1	5
247	...	2	72	2	2
520	...	5	339	1	94	1	133	1	52	1	553	1	...	5
Total	10	30	30	6	2	1	1	1	40					
Total	43	186	161	39	11	6	2	2	229					
Grand	Total	53	216	191	45	13	7	3	2	269				

The above tabulation shows the votes cast by the striking members of these roads. It also shows the lodge numbers that the votes came from and the lodge number of which the members were strikers.

All votes were included up to and including July 8th, but votes received after that date are not in this tabulation.

Trusting this will be satisfactory, with best wishes, I beg to remain,
Yours fraternally,

F. P. REINEMEYER, I. S. T.

REPORT OF SECOND INTERNATIONAL VICE-PRESIDENT NOLAN.

Dear Sir and Brother:

My last report for Journal was mailed from Chattanooga, Tenn.; was there in the interest of Lodge No. 14, also co-operating with officers of various organizations in what is known as a forward labor movement, or, in other words, revival of organized labor's interests among those who became delinquent in their respective local organizations, as well as the unorganized, who don't seem to realize that the labor movement, like any other business institution, must be a continual effort, united and unflinching, until justice is secured, through the different federated departments of the American Federation of Labor.

Take, for instance, the railroad shops, operated under what is known as the appropriation plan, compelling the shop crafts

to work under reduced hours of labor, so the stockholders can get theirs, regardless of the employes and their families who must suffer in many ways, which makes it almost impossible to secure the necessities of life, without which the high ideals of American homes as well as American manhood and womanhood is reduced to a condition akin to slavery. That is why a forward labor movement becomes necessary in some sections of the country, in order to arouse the unorganized to the necessity of organization, so that working conditions may be improved and favorable legislation secured, as the men and women who are compelled to toil for a living must be organized and work through their organization to that end. Practical organized methods must be used also in order to cope with an ever elert and well financed opposition, whose methods in dealing with their em-

ployes are as cold as the frozen regions of the North Pole, which must be evident by every man who worked for a daily wage; yet there is still a woeful lack of co-operation existing, due to our negligence in not studying carefully the industrial situation as it confronts us, but still the labor movement is rapidly gaining in membership because some of the wage earners see from past experience the necessity of it.

On June 3 I attended an open meeting of Lodge No. 14, Chattanooga, Tenn., which was called to discuss many matters in connection with the International Brotherhood, as well as getting every boiler maker in the city of Chattanooga to be a member of Lodge No. 14, and I must say that through the co-operation of the officers and members of Lodge No. 14 our efforts have been successful, and trust the same interest will be continued and the good work be carried on according to the International Constitution, for Lodge No. 14 has done good work in the past, and I am confident she will do the same in the future, as we have several good workers in the labor movement of Chattanooga, tried and true to the principles which they have advocated for years, always willing to give the best that's in them for their fellow craftsmen, pleading with them as well as explaining the great necessity of co-operation and I must say that from observation of them while in Chattanooga, their work along that line has convinced many of their mistake, returned to the fold of their organization with a grim determination in the future to royally support their fellow craftsmen in their efforts for at least human conditions under which to work. May the good work go on, which means the political and industrial emancipation of the wage earners of America.

Among the old members who attended open meeting of Lodge No. 14 on June 3 was Brother Jack Gribben, the old-time member and active worker in the labor movement of Chattanooga, as well as the able scribe of Lodge 14 in the years gone by, and trust he may again grace the columns of the Journal with articles from his ever-ready pen on matters of interest to the membership, as there is none more qualified than Brother Jack Gribben of Lodge No. 14, as I have known him for years and know his ability as a writer on history, as well as on questions of interest to the labor movement. There may have been misunderstandings in the past, but they are now sunk into oblivion for the great cause we are all engaged in, the elevation and protection of every member of the Brotherhood of Boiler Makers, Iron Ship Builders and Helpers of America.

On June 5, by instruction of the International President, left Chattanooga, Tenn., for New Orleans, La., to assist the business agent, Brother Smith, to straighten out a grievance in Lodge No. 37, and also to secure an international agreement between the proprietors of the various contract boiler shops and Lodge No. 37 of New Orleans,

reaching there on the 6th and found a forward labor movement in full swing, with several officers of the international organizations already on the ground. Either open air meetings or meetings in the halls were held almost every night; in fact, on account of the number of meetings arranged by Brother Faust, the representative of the Trades and Labor Council of New Orleans, the international officers were formed into groups in order to get sufficient speakers at each meeting arranged.

The result of the forward labor movement of New Orleans has been good so far, but before the close, the good work will be plainly visible by increased membership among the local organizations of the Crescent City of the South.

I have advocated on all occasions at the Metal Trades meeting, also Brother Flanagan, Vice-Presidents of the Blacksmiths, the absolute necessity of a local Metal Trades Council in New Orleans for the purpose of securing greater co-operation among the various metal trades through united action when necessary. The result was that a charter has been applied for through Secretary-Treasurer Berres of the Metal Trades Department of the American Federation of Labor. Officers have been elected and much interest seems to be manifested among the delegates who represent the locals affiliated, and trust same will continue, as a Metal Trades Council was badly needed in New Orleans.

Brother William J. Smith, business agent of Lodge No. 37, was elected temporary president of the local Metal Trades Council while the work of organization was in progress, and rendered valuable assistance in visiting locals and securing delegates from local organizations who were eligible to affiliation in the local Metal Trades Council, but found it impossible to serve as permanent president on account of his other duties as business agent of the Brotherhood of Boiler Makers, Iron Ship Builders and Helpers of America in New Orleans, but, nevertheless, will render all possible assistance in building up a strong united Metal Trades Council and, further, in connection with the above, I desire to thank Brother Berres, Secretary-Treasurer of the Metal Trades Department, for his prompt attention to my communications, as well as information given which helped very much to organize the local council in this city.

After reaching New Orleans from Chattanooga, Tenn., held a meeting with Brother Smith, business agent of Lodge No. 37, and a committee, Brothers Vellegre and Costelle, relative to conditions in the port of New Orleans, as well as several grievances then pending between Lodge No. 37 and the boiler shop proprietors. At that meeting it was decided to call a meeting of representative delegates from the three lodges, Nos. 37, 442 and 206, which was done, and the following delegates were chosen to represent their respective lodges: Brothers Smith and Vellegre of Lodge No. 37, Broth-

ers Mocklin and Boone of Lodge No. 442, Brothers Kenny and Donewar of Lodge No. 206.

On June 16 a representative delegate meeting of the three lodges in New Orleans was held for the purpose of securing an International agreement between Lodge No. 37 and the various boiler shop proprietors of New Orleans and to abolish through an agreement the several grievances then pending, which had caused considerable trouble and friction in the past. It was, therefore, decided to notify the secretary of the Manufacturers' Association that Lodges No. 37, No. 442 and No. 206 desired a conference with a committee from his association, for the purpose of entering into negotiations for an International agreement, as well as a general discussion of many matters in connection with the shop conditions and the welfare in general of both parties in the port of New Orleans, which was agreed to by the committee, and later indorsed by Lodge No. 37 at regular meeting, and in answer to communication as outlined above, we were notified by the secretary of the Manufacturers' Association that a meeting would be held at the Chamber of Commerce on June 19, between a committee representing the above association and a committee representing the three lodges of New Orleans, Brothers Smith and Vallegre of Lodge No. 37, Brothers Mocklin and Boone of Lodge No. 442 and Brothers Kenny and Donewar of Lodge No. 206.

Conference came off as arranged, June 19, and am pleased to report that an International agreement was secured between the proprietors of the various contract boiler shops and the members of Lodge No. 37 of the International Brotherhood of Boiler Makers, Iron Ship Builders and Helpers of America, the first agreement in 21 years. Let us hope for the future benefit and recognition of our craft in the port of New Orleans, that no violation of agreement will occur, as the method of handling certain grievances is plain, such as discrimination, change in working conditions, reduction in wage as per the agreement; therefore, there is ample opportunity of adjusting grievances as mentioned under the agreement, for premature strikes will not be tolerated in the future, as the constitution of the Brotherhood, as well as the agreement entered into between the proprietors of the various boiler shops of New Orleans, must be lived up to; but should the proprietors violate it, then the situation entirely changes, which I am confident will not occur. I attended several meetings of Lodge No. 37 and found that all members were absolutely satisfied with late agreement, as well as Brothers Smith, Vallegre, Kenney, Donewar, Mocklin and Boone, who represented the New Orleans lodges during conference with the boiler shop proprietors, June 19, and, further, I desire to thank the committee from the three lodges, No. 37, No. 442 and No. 206,

for their painstaking and active co-operation given me previous to, as well as during, conference with the proprietors of the New Orleans boiler shops, when agreement was secured.

Have attended several meetings of Lodge No. 37, which has a large membership and increasing, but sorry to report that work in the port of New Orleans is pretty dull at present, and many of the members have been idle for some time, but all hope for improved conditions in the fall; let us hope so, as several boiler makers and their families have felt the effects of enforced idleness for several months.

Attended a regular meeting and smoker of Lodge No. 206 on June 11, and, as usual, almost every member was present, with that old faithful worker in the cause of his fellow craftsmen, Brother Koenig, in the chair and his secretaries on the job attending to their respective duties with promptness and dispatch, courteous and willing at all times to help their brother members with any information in order to straighten matters out according to the constitution, but the conditions are never lost sight of in conducting the business affairs of Lodge No. 206. Had the pleasure of meeting one of the real old-timers in the Brotherhood, Brother Corcoran, and despite his advanced years, he is still active in Brotherhood affairs and holds the position of layer out at the Texas Pacific shops, Algiers, La.

Several good talks were made on the past work of the Brotherhood, as well as its future prospects, and all agreed that the International Brotherhood stood at present in the front rank of the metal trades organizations of the American labor movement, both financially and otherwise, and all that is required to make it even still greater is for the entire membership to pull together according to the constitution. The principal speakers on the occasion were Brother Koenig, president of Lodge No. 206; Brother Smith, business agent of Lodge No. 37; Brother Reynolds, corresponding secretary; Brother Corcoran; Brother Berry, the faithful financial watch dog of Local No. 206, and, in conclusion, let me thank the officers and members of the Algiers lodge for the many acts of kindness shown me while in the Screscent City of the South, where hospitality is the password on entering the city, for when a stranger can show the goods, an up-to-date card of the Brotherhood, otherwise nothing doing.

June 15, attended a regular meeting of Lodge No. 442, but owing to sickness, Brother Shea was unable to be present; however, at this writing he has fully recovered and is back in his position as foreman boiler maker of the terminal shops at New Orleans; May he always have good health, is the sincere wish of the men he has been associated with for many years, the boiler makers of New Orleans and vicinity.

Promptly at 8 o'clock, meeting was called to order, with President McCabe in the

chair; several important communications were read and referred to the financial secretary, Brother Mocklin. As Brother Mocklin is from Missouri at all times, you have to show him that a request on the treasury of Lodge No. 442 is a deserving one; in fact, when the question is called on a motion duly seconded in connection with the financial affairs of Lodge No. 442, he is on the floor to find out what it's for and all about it, and if Brother Mocklin is convinced, he is there with the goods, as he is every ready to help any brother who can show him, for he is well known to the traveling brothers who butt into him in New Orleans.

All the members work at the terminal shops, with the exception of a few who work in the contract shops and at outlying points in the vicinity of New Orleans.

In my next report for the Journal, will touch on a very important matter now pending in New Orleans, in the interest of the International Brotherhood, as well as Mobile, Ala., where I spent a few days in the fore part of July.

This finishes my report for June, 1915, and trust same will be satisfactory.

Yours truly and fraternally,

THOMAS NOLAN,
International Vice-President.

REPORT OF THIRD INTERNATIONAL VICE-PRESIDENT MERRIGAN.

At the conclusion of my last report I was on my way to Hamilton to attend a regular meeting of Lodge No. 428, arriving there on the 1st, believing that there would be a meeting the following evening. However, on inquiring later I found that the members had decided to dispense with holding their regular meeting Friday night, owing to that day being Good Friday. As it was not convenient for the members to attend a meeting on short notice, and meeting places could not conveniently be obtained, a meeting was arranged for Monday evening, the 5th. Most all of the members were present, as there were some shop grievances which they desired remedied. After considering their grievances thoroughly and discussing same at length, a satisfactory solution of the difficulty was arrived at, providing same was carried out according to instructions.

April 5th I left for Ottawa to meet with the delegation from the Welland Canal, who waited on the prime minister and other ministers of the cabinet. I also had an interview with the deputy minister of labor regarding a complaint from Lodge No. 134, that members employed at the Canadian Vickers Company were not receiving a fair wage. Upon investigation of this complaint I was informed that there had been no complaint regarding wages, but there had been a complaint about aliens being employed on work being done at the Canadian Vickers Co., and that an investigation was held and later a report was submitted to the Department of Labor advising that the importation of aliens was limited to a certain class

of employment that was not obtainable in Canada. I may say that the report of the committee was correct to a certain extent, but they could have made a more exhaustive report, and should not have been so hasty in arriving at the report they submitted. For it is a fact that hundreds of aliens secured employment in preference to local men who were competent to perform the work.

The delegation, representing the trades and labor unions employed on the Welland Canal, were given a satisfactory hearing in their request that the fair wage be paid to all employes on the job.

April 7th I left for Montreal, intending to leave there within a few days to go over the line of the Intercolonial. However, on my arrival there I was informed from headquarters that Lodge No. 134 had submitted a request for me to be sent to Montreal as early as possible, and requested that I remain indefinitely. I made inquiries as to the communication which was sent to headquarters, and learned that some of the members thought it advisable for me to be in town for some time, owing to the order for ten submarines were to be built, and that there was a number of unorganized men being employed. After further inquiry at the next meeting of Lodge No. 134 I learned that it was not altogether a matter of trying to get the men employed at the Vickers plant to become members, but in general. However, I informed the meeting that if it was their intention that I should start an organizing campaign in the city they were surely requesting me to do something almost impossible, for there were so many out of employment and those who were being employed were getting very little of it. I remained at Montreal until June 10th, during which time I was after delinquents and endeavoring to have them attend open meetings. A special reinstatement fee was granted, and a fairly good number availed themselves of the opportunity. It was difficult to interest a certain element from Quincy, Mass., who are employed at the Fore River Ship Building Co. All they knew about organization was that they had a CLUB at Quincy. Others came from Cleveland, Philadelphia, New York, Brooklyn and other places in the United States where ship building is done. One thing that did not impress the local members was that the members from outside lodges failed to put in an appearance at any of the meetings while working in Montreal, nor did they deposit their cards. However, a good word can be said for those who were members of our organization, no matter where they hailed from—they were popular, and our local members have learned that organized labor will be heard from when matters are not going satisfactory.

While in Montreal I was informed that there was some tanks being built on one of the piers. Later, upon investigation, I found that a number of structural iron workers were employed on the job, and that this

job was being erected by the Petroleum Iron Works of Sharon, Pa. I got in touch with a representative of the Iron Workers' Union and called his attention to the fact that this company was unfair to organized labor, and again that the members of his union had no business placing their members on such work. He was ignorant of the latter, for while I showed him the agreement which had been entered into between their organization and ours, in their constitution and laws members were led to believe that they were justified in working on anything made of iron or steel that did not hold steam. A few gangs of our members had started on the job and I called them all off later. This included iron workers and others. The following day, owing to the representative of the iron workers not having much authority, some of the iron workers resumed work. I called his attention to this and had him get in touch with their officers at Indianapolis and explain the situation to them. I may say here that I don't think the general secretary of the iron workers keeps himself posted as to where there is any disputes which might involve their membership. If he does, then they do not desire to act in conjunction with our organization. However, I made the matter known to I. P. Franklin and had him get in touch with the president of the structural iron workers and also the secretary, with the result that a few days later the representative at Montreal was told to take their members off the job. I had dodgers and stickers printed and placed pickets on the job. Labor was abundant, and it was difficult for our pickets to impress those going to work the necessity of keeping off, as there was a strike on and that the company was unfair. It was also difficult for our pickets to get near the job, as the job was policed. None of our members, I am pleased to say, worked on the job during its erection, whether they were in good standing or delinquents. But the job was finished by those claiming to be structural iron workers and others.

While in Montreal I was called on by one of the members of Lodge No. 134, who was employed by the Canadian Pacific Railway at one of the outside points, informing me that he had been discharged and felt that he was unjustly discharged, and desired that his grievance be investigated. I endeavored to have a committee take his case before the officials of the company, but could not get any. Later I took the case in hand myself. I went to Farnham and had an interview with the locomotive foreman, who explained to me what orders he had received. I then called on the aggrieved member and brought him before the locomotive foreman and the assistant foreman and heard all sides in dispute. Nothing could be done by the locomotive foreman, in the way of reinstating the member. I returned to Montreal, and the following morning I had a meeting with the superintendent of the division, and explained my mission to him, endeavor-

ing to have our member reinstated, but without avail, as this was not the outcome of any hasty action on his part, but had been pending for some time previous. After my interview with the superintendent of the division, I arranged to have the member come to Montreal. He arrived the day following and we called on the superintendent, and had a hearing regarding his discharge. The best that could be done for the member was to transfer him to another point. To this the member consented after having a thorough understanding as to his transfer.

I may say that, apart from the work that was being done at the Canadian Vickers Company, by the Fore River Ship Building Company, that there was very little work in our line being done in Montreal. There was, however, a large order for shells and other war munitions.

During the month of May, Mr. G. N. Barnes, labor M. P., for Glasgow, visited Canada, accompanied by Mr. W. Wyndham, of the Board of Trade, to see what could be done to secure men in Canada for the manufacturing of shells in Great Britain. While in Ottawa, he addressed a big deputation of eastern and western mayors who were there to interview the Government regarding the unemployed. The mechanics required were boiler makers, sheet metal workers, fitters and turners, including others who are skilled in assembling machinery. They hoped to get 2,000 mechanics. The men recruited were to be engaged for six months, and perhaps longer. They would be given second-class passage across, and paid subsistence until they go to work, while if they worked there six months or longer their fares back would be paid by the British Government. The wages would be the standard British union rates in the best shops, so that it would afford an excellent opportunity for good mechanics to pay a visit to the Old Country and make good money at the same time, as their earnings would only be limited by their willingness to work. Messrs. Barnes and Wyndham were to stop off at all the principal cities in the Dominion from Quebec to Vancouver. Reports showed that a large number of skilled mechanics had made application.

After I had done as much as could be expected at Montreal, owing to the slackness of trade, I decided to fulfill my engagement through the Maritime Provinces. Before leaving Montreal, I was asked to call at the office of J. T. Foster, B. A., for the I. A. of M., as there was some matters he would like to discuss with me. Upon inquiry, I met Bro. McLelland, vice-president of the I. A. of M., who explained why I was asked to call at their office. Bro. McLelland, had arranged a meeting with Mr. Miller, general manager of the Canadian Vickers Company, regarding a dispute that existed at the shops. The Labor Department was made aware of this dispute while Bro. McLelland was in Ottawa, and he decided to come to Montreal, for the Labor Department, to in-

investigate the dispute. The dispute was between the company and the men employed as riveters, caulkers, chippers, holders-on, helpers and heaters. On June 7, an element employed there decided to go on strike for fifty cents per hour plus a war bonus, and a number of our members joined without consulting their organization. These men decided on their plan of action in a vacant lot near the works, and returned to work three days later less profitable than where they left off. It was regarding this dispute that I accompanied Brothers Foster and McLelland to the office of Mr. Miller. Brother McLelland explained his mission, and our interview was cordial. We discussed the dispute and the knowledge the company had of same. The company was desirous of paying the highest rate of wages for the work performed, and the conditions would be as good as elsewhere. They intended to work along the same lines as were in operation at their shops and yards in the Old Country. Mr. Miller requested that I get in touch with their shop foreman whenever convenient if I knew of any for our members out of employment as they only intended to employ men who were skilled in such work. This I will do on my return to Montreal, providing I have no other work on hand elsewhere.

After our interview, I left for Moncton, to attend the regular meeting of Lodge 378, arriving there on the 11th. Attended the regular meeting that night and addressed the meeting. There were some laws of our organization that the lodge were not clear on, and I was asked to enlighten them, which was done to their satisfaction. I was given a list of the delinquent members at outside points and advised of others who were members and asked to call on them. I had some other matters to take up with the officers and remained over until the 14th.

From Moncton I went to Truro, arriving there on the evening of the 14th. On the 15th I got in touch with all of the members employed at the roundhouse and explained matters to them. I found that all held membership and some of them complained of not having any due-book, which I took note of and reported to Lodge 378. It was also made clear to me that about all that some of them knew was, that they held membership in lodge 378. It therefore remained for me to enlighten these members on matters in connection with our organization, which was news to them.

On the 15th I left for Halifax, to meet with the men employed at the I. R. C. I found one out of four was a member. I had a talk with two others, one of whom was indifferent to organization, for a while, but later decided to reinstate. The other would fill in an application. The other man was working on the night shift, and whom I saw since and had him fill in an application.

While in Halifax during the evening with the assistance of the member employed by

the I. R. C., I got in touch with some of the men employed in the contract shops. I was fortunate in meeting one of the men, and was informed that the contract shop men had re-organized during the month of April and May, and that he was president of the lodge. He informed me later that there would be a regular meeting on the 23rd. This was good news for me. So I informed him as I had other places to visit, I would do so in the mean time and return in time to attend the meeting.

The following morning, 17th, I left for New Glasgow, to call on the men employed by the I. R. C., at Stellarton. I got in touch with them during the afternoon, and the following day and found that they had been members of Lodge 378, at one time, but claimed they could not get any satisfaction from the officers of the lodge. Their dues had been sent in accompanied by their due-books and had heard no more of them, and that they could not be expected to be members when they were unable to get any information. Later I arranged with Lodge 378 to have these men reinstated which they were quite willing to do. There was also one man who had not been a member and he filled in an application. While in New Glasgow, I endeavored to locate C. C. Dane, whom I was anxious to meet, as he was instrumental in re-organizing the contract shop men in Halifax, but could not conveniently locate him.

On the 19th I left for Sydney, arriving there during the evening, I was met by one of the members employed by the I. R. C. and remained over until the 21st, during which time four new applicants were received. This point also complained of not receiving attention from the officers of Lodge 378. However, this was brought to the attention of Lodge 378, latter on no doubt these men will be given the proper attention in the future.

On the 21st, on my return to Halifax, I stopped off at Mulgrave for a few hours with the intention of meeting a member employed there. Later I found that this member had worked during the night, and owing to the inclement weather and the time at my disposal, it was not convenient for me to meet him.

On the 22nd I left for Halifax, arriving there during the night, and made arrangements for the meeting the following night.

On the 23rd I attended the meeting of Lodge 580. There was a good attendance. I addressed the meeting which was well received. I learned that the men employed at the contract shops had decided to re-organize during the months of April and May, and had sent for new supplies and charter. At one of their meetings previous, it was decided that they would request all employers for an increase in wages, and requested a reply by July 1st. Owing to all replies not being at hand at that meeting it was decided that a committee and myself wait on the various employers the following day for an answer to their request. The fol-

lowing day, I met the committee as arranged, and proceeded to wait on the employers. We received a favorable answer from all except one. That one was at the Halifax Graving Dock. I personally interviewed the general manager. He did not have any desire to have anything to do with unions, and gave his reasons. However, I pointed out to him that the men were uneasy and desired a reply to their letter.

On the 25th I left for Moncton, to attend a meeting of Lodge 378, which I understood would be held on that date. Upon arriving there, I was informed that Lodge 378, had dispensed with one meeting. I had a meeting, however, comprising the officers and a number of members, and the dissatisfaction that existed at several of the outside points where boiler makers and helpers were employed, over which Lodge 378 had jurisdiction, and requested that this state of affairs be attended to at their next regular meeting.

The 26th I returned to Halifax, to attend a special meeting of Lodge 580, which was called for Sunday evening. This meeting was well attended. A number of new applicants were received. The report of the special committee was received. The boiler makers, ship builders and helpers in Halifax at one time were the foremost trades unionists in that city. Unfortunately, like many others, they did not use good judgement at the proper time. Nevertheless, at this time, they claim that they are going to enthuse new life into their ranks and return to where they belong. And if one can judge by the interest that is being displayed in organization at present, they will surely return to where they rightfully belong.

This will conclude my report up to July 1st, I am,

Yours fraternally,
J. P. MERRIGAN,
Third I. V.-P.

REPORT OF FOURTH INTERNATIONAL VICE-PRESIDENT WEYAND.

Cleveland, Ohio.

Dear Sir and Brother:

The following is my report for the months of May and June, 1915:

At the conclusion of my last report I was still detained in Elmira, N. Y., trying to bring about a settlement of the wage question for our members in the LaFrance Engine Company. While we had several conferences with the management of the company, we were unable to convince the management that our members were entitled to an increase in wages. As the machinists had also made their demands for an increase and after several conferences with the management, they were likewise refused any concessions on the wage question. We then decided to make it a joint proposition, and requested a joint conference with the management; the management agreed to meet a joint committee of their employes, but refused to meet the officers of the organization.

During this conference nothing was accomplished by the joint committee. So after a joint meeting of the two trades involved the members of both organizations decided to leave the services of the company on May 6. After arranging matters for our members in regard to strike benefits with the International Lodge, I arranged to go to Baltimore, Md., as per orders from President Franklin.

On May 7 I went to Baltimore. On my arrival in Baltimore I arranged to meet the officers of Lodge No. 193, Saturday, May 8. Brother Shanley, president of Lodge No. 193, and myself went to Fairfield, where I found a large refinery under construction, also a large number of delinquent members were employed. I arranged with some of the card men on the job to assist me in getting the names of all men who were in bad standing, in order that they would be given an opportunity to pay up their dues the following Saturday. I found two firms had the contract for erecting this refinery, namely, the Bartlett & Hayward Company and the Novelty Iron Works of the city of Baltimore.

The following day Brother Shanley and myself went to North Twenty-second Street, where we found a pipe line under construction; also found some delinquent members employed; also made the necessary arrangements to have them reinstated.

The following Tuesday I attended the regular meeting of Lodge No. 193. We had a very good meeting, and will say all officers and members of Lodge No. 193 assured me of their co-operation and assistance in lining up the boiler makers and helpers in the city of Baltimore. I then made regular trips to Fairfield each day to talk to those men employed at the refinery who had never belonged to the organization and gave them applications. The following Tuesday evening we had a special meeting and invited all boiler makers and helpers to attend. We had a very good meeting and received a number of applications. In carrying out this program of organization, we initiated five boiler makers and seven helpers. We also reinstated twelve boiler makers and seven helpers in Lodge No. 193, making a total of 31 members organized for the month of May.

Beginning with the first day of June, I continued to carry on the same organizing campaign by going to Fairfield every day and visiting the pipe line job about twice a week. We again called a special meeting on June 2 and received a number of new applications and some reinstatements for Lodge No. 193.

In the month of June we initiated seven boiler makers and 18 helpers. We also reinstated 12 boiler makers and six helpers, making a total of 43 men organized in Lodge No. 193 in the month of June.

As I was requested by President Franklin to go to Philadelphia and meet Vice-President Johnson of the Iron Workers, relative to some jurisdictional matter, I left

Baltimore on Monday, June 28; at this time I had about 12 more names of men who had paid half of their fees for reinstatement or initiation; this amount of money I turned over to Brother Chaney, financial secretary of Lodge 193; also collected considerable money for dues from the members of Lodge No. 193, which was also turned over to Brother Chaney. While carrying on the organizing campaign in Baltimore, our vice-president, John Schmidt, arrived in Baltimore in company with other organizers who were carrying on a campaign on the B. & O. R. R., and in justice to Brother Schmidt, I may say Brother Schmidt gave me every assistance during his stay in Baltimore.

On my arrival in Philadelphia, I met with the officers of Lodge No. 341 to take up

the complaint of the iron workers. I waited three days for Vice-President Johnson, but he failed to come. I then went to visit the job in dispute. I found the job was more than two-thirds completed and, in fact, a very small job at that. However, I realized at once that the work belonged to the iron workers and told our business agent, Brother Napier, that my decision would be in favor of the iron workers and in the future to avoid putting our members on this kind of work, as it was the intention of our organization to be fair with the iron work.

Trusting this is satisfactory, and with best wishes and regards, I am

Yours fraternally,

LOUIS WEYAND,

Fourth International Vice-President.

Correspondence.

Milwaukee, Wis.

Dear Sir and Brother:

In compliance with your request for a report as to the conditions of our trade in our district, also that the business agents on the various railroads send in a report monthly so as to keep the entire membership informed as to the general working conditions along the line, will state that I heartily approve of this plan, and I believe that this manner of reports should be carried out along the same lines as followed by the Machinist organization, which, I believe, was talked over between ourselves during my last visit to Kansas City.

Conditions along the "Milwaukee" Road are at present very poor; there is very little chance for a boiler maker to secure employment; I have been notified by our superintendent of motive power that a saving of \$35,000 per month must be made, and in order to do this all of the shops on the east end will be put on four days and eight hours, or 32 hours per week; this does not look very promising and just how long this short time will continue is going to be a question. It is predicted that the crops in the Northwest are not going to be what they should be, due to the large amount of rain in the past few months. Whether this has any affect on our working conditions is a big problem.

One of the largest questions before the boiler makers working on the C. M. & St. P. Ry. is the matter of feeding the unemployed boiler makers who are going over the line looking for work; at present there is no work to be had on the line; still there is the constant coming and going of men. Boiler makers have been known to start on the east end of the line and follow it through to the coast, stay there for a few days and then start back again; they are taken care of by the men at the various divisions, which at the present time has got to be a serious matter. The men at most all points are paying \$2 per month dues.

In connection with this, the expense to each one for meal tickets amounts to from \$3.50 to as high as \$8 per month apiece. This is quite an item and the members traveling don't want to forget that at points along the west end that these meals are costing the boiler makers at those points about 50 cents apiece. Sooner or later this will be stopped by the men, as they cannot stand for paying out so much money and also work short time.

Work throughout the Northwest is very slack, and none of the roads are putting on men. The Soo Line laid off about 50 men and the M. & St. L. closed up their shops for three weeks; this took place in Minneapolis. On the west coast there is not a job to be had and I would warn all boiler makers that it is useless to come into the Northwest looking for work, for there are plenty of men that have been laid off at all points to fill any demand that may be had for men. If boiler makers do come into this country looking for work, the boiler makers that are not working will only have to feed them and they have plenty of their own to look out for without having more come in on them.

Hoping that this will prove interesting, I am

Yours fraternally,

JOHN L. CALLAHAN,

Business Agent District No. 26.

Los Angeles, Calif., July 8, 1915.

Dear Sir and Brother:

For some time past I have been thinking of writing a little article for our Journal, to voice my opinion of some of the things that I have seen through the Southwest.

I have traveled through a good many towns in this part of the country during the last year or two, and I must say that there is something wrong with the men there now. A few years ago, the first time that I came this way, they were different. In most of the places that I have been, including Los Angeles, I find that nearly to

a man the boiler makers have been members of our Brotherhood, but now they are suspended, and when asked about it, they do not seem to be a bit interested whether they get squared up or not, and I think that herein lies one, if not the main, reason that this town and those around it have earned a scabby reputation. The towns and the jobs, since the Harriman Lines strike, are far apart, and as it is easier to get a job without a card than with one, most of them when they come to this part of the country let it go by the board, with the expectation that when they get away from here they will get straightened up, and most of them lie like the ——— and say that they did not work at the trade while around here and so could not pay their dues.

I have talked to a great many of them and find that this is almost always the case. Then when I press them to get back in, they put up an awful holler that they are not getting a square deal, that a new member can come in for whatever the local lodge sees fit, generally \$10, but they, some of them have been members in good standing for years, and they must pay \$15 to come back in on the same footing as the new man. Now I think that as these two things seem to be the greatest cause of trouble, at least in this section, that there ought to be some way to remedy both of them. This would include helpers.

I think that there ought to be some way to keep the good, honest member, who is not working and reports regularly to the proper officers, in good standing without making him take stamps that are so much different from the regular working stamp that many look with doubt upon him for keeping his book straight with them; then I think that we should bend every effort to get boiler makers into the organization that have never been in, to take them in under the badge of workers, that they are coming into protect their interests instead of simply to get a job, that every effort should be made to hold them after they get in, and that all should be penalized for dropping out and coming back in as it is convenient; in other words, they should pay this big reinstatement fee. Brother John Dick expressed my idea several years ago when he said, "Take them in for a peanut," but make it expensive to drop out.

Another thing and then I'll let someone else have some space. I think that it is time that the International office sent someone into this part of the country to stay. I do not think that one of our worthy Vice-Presidents has been down through here on anything more than a flying trip for at least 30 months, and the lodge in this city, No. 92, has almost gone out of business; when I think that it could have been a whole lot better if one of them could have been kept here all the time.

One would think, upon first coming here, that there was an incubator for scabs in this city and the Southwest, but I think that most of them come here with cards in their

pockets and then go suspended, and they make the worst enemies that we have. We are trying to bring things together here, and with a little help I think that we will succeed. What we are doing with the other trades is O. K., but not enough of it. Brother John Dick has been through here several times and wanted to stay here, and I think that he understands the fix that we are in, but of course he has been more or less tied up to his work around the bay cities and did not have much time here. I talked the matter over with him and he said that he would be glad to come here for a few months.

As this part of the country is a large place, there must be others that have found things as I have found them, and I hope that they will give their ideas to the Journal, and I for one am going to start to write up the kind that are helping to make the Southwest a breeding place, or a dumping ground for scabs.

Hoping to see this in the next issue, I am
Yours fraternally,
E. J. BUNTLER.

Jersey City, N. J.

Dear Sir and Brother:

At a regular meeting of Lodge No. 16, the following resolutions were adopted:

Whereas, It has pleased the Almighty God in His infinite wisdom to take from this world, to her reward in heaven, the dearly beloved mother, Mrs. Mary Fitzpatrick, of Brother Hugh Fitzpatrick, corresponding secretary of Lodge No. 16;

Resolved, That we, his brothers, extend to the bereaved family our heartfelt sympathy in their most sorrowful hour.

Resolved, That a copy of these resolutions be sent to the bereaved family and a copy for publication in the Boiler Makers' Journal.

THOS. J. LILLIS,
GEORGE HORANE,
JOSEPH HAYES,
Committee.

Lowell, Mass.

At our call meeting of Lodge No. 371, Lowell, Mass., June 16, 1915, the following resolutions were adopted:

Whereas, Almighty God has seen fit to take from our midst our beloved Brother John Flaherty, we realize the loss has been great to his wife and family, but our dear Master knew best. We know the lodge has lost a good, true union man. He was tender and kind, as he always had a word of cheer and comfort for all who knew him, and when killed without a moment's notice he passed away.

Resolved, That we do sincerely sympathize with his family in this their hour of sorrow, and pray that God may comfort and console them in their hour of sadness.

TIMOTHY J. DONAHUE,
WILLIAM WELLS,
ARTHUR P. MORAN,
Committee.

WHO PAYS THE DEBT.

Springfield, Mo.

Now don't it seem really funny
 When you stop and take a look,
 How some brain and lots of money
 Makes a man a political crook?
 Again, don't you feel like cussin' the starter,
 The guy who has lots of dough,
 When he rears up and says, "We want the
 charter;
 It's the thing we need, you know."

Does he stop to think who pays the debt?
 Does he know that workingman's kiddies
 and wife
 Must suffer from the fancies of the political
 vet?
 That it takes what we earn for the neces-
 saries of life?
 And when we must lay off to vote on com-
 mission
 With two Sundays a week and a holiday,
 too,
 Four days' pay has gone to perdition,
 And things like that make a fellow feel
 blue.

Mr. Banker, do you realize what it must
 cost us
 To humbly stand by with only our vote
 While you with your flurry and bobbling
 fuss
 Sweep on down the stream in your political
 boat?
 Are you not satisfied to take half of our
 earnings?
 Do you want the whole thing, you hungry
 hound?
 If you don't, then stop some of your yearn-
 ings
 And let councilmaniac law rule our town.

Now, brother workingman, let's take heed
 And get out to the polls at the next spec-
 ial call
 And do our best to whip this political breed.
 Let's kill the charter bill once and for
 all.
 If moneyed men want it, we don't need it;
 We must never side with them to give
 them a chance
 For the capitalist collar the laborer want
 They are two warring factions like Ger-
 many and France.

Still better, come to think of it, it seems
 to me
 That if we want to change our condition
 We had better let city politics be,
 And start at the head of the nation.
 Let minor affairs go as they may.
 To kill the serpent, we must chop off its
 head.
 In 1916 let's all vote the right way,
 And all such nonsense soon will be dead.
 —J. W. Galloway, Boiler Makers' Local
 No. 70.

Huntington, W. Va.

Dear Sir and Brother:

It is with great pleasure I make a second attempt to write a short article for the Journal, providing our worthy editor allows it to pass the waste basket, and I sincerely trust that the brothers at large will not criticize me as strongly as they have some of the brothers in the past, as I am of the opinion that their criticism goes a little too far at times. While Local 249 has not taken any action on either side, yet it behooves me to disclose my opinion. I hereby really think that in order to prevent all hard feelings to withhold our brotherly love it will be necessary to see that such resolutions are properly endorsed, and then let it come to a referendum vote.

We, the members of Local 249, are still on our feet, fighting harder every day. We have our Saturday afternoons off, and it seems that a number of the brothers delight in grasping the opportunity of crossing the border to obtain a little "spirit" water as one notices them looking a little down-hearted and spitting cobwebs all week.

Now I wish to say a little in regard to the way the Legislature turned down the bills that were proposed by the laboring organizations of Ohio, whereas there were several good ones among them, but as yet have not heard of any being passed which would better the conditions of the laboring class. All that I can ask is justice and "honor to him to whom honor is due," not, as one judge stated, that an employer could organize to protect his rights, but the employe would not be allowed to enjoy the same rights, which is not justice.

In conclusion I regret very much to say that Brother J. A. Kilkullen (better known as Pat), with a current card from Local 322, was very seriously injured while endeavoring to alight from a side-door Pullman at Ironton, Ohio, and his recovery is very doubtful. While the members of Local 249 have done all in their power to assist him in his misfortune, great praise is due J. A. Hannon, mayor of Ironton, Ohio, for his extreme kindness bestowed upon the brother. This shows there is something in the clothes he wears.

With best wishes to the brotherhood, I am
 Fraternally yours,

E. T. BRENNAN,
 S. L. 249.

Chicago, Ill.

Dear Sir and Brother:

Stony Island Lodge No. 17, L. A. to the I. B. of B. M. was instituted June 24 by our Second International Vice President, Mrs. Mollie Geary, with a membership of 11.

The following officers were elected and installed: Mrs Rose Ptok, president, 9015 Houston Avenue; Mrs. Cora V. Kelley, vice-president, 9251 Stony Island Avenue; Mrs. O. M. Diedrich, corresponding and recording secretary, 7436 Evans Avenue; Mrs. Eleanor

Clark, financial secretary and treasurer, 7539 Rhoades Avenue; Mrs. Katherine Murphy, chaplain, 751 East Seventy-third Street; Mrs. Anna Cullerton, conductress and marshal, 749 East Seventy-third Street.

We meet the second and fourth Mondays of each month at Pusely's Hall, corner of Seventy-fifth Street and Drexel Avenue.

While our beginning is small, we feel that a good work has been started and as we have already added one member, that we will soon have a good working lodge.

I see in your last edition of the Journal that you have a list of officers which is entirely incorrect; please correct same.

Yours fraternally,

MRS. O. M. DIEDRICH,
Secretary.

BOOST FOR YOUR FRIENDS—LISTEN!

No doubt some of your Eastern boiler makers intend to visit the fair at San Francisco and San Diego, Calif., or maybe you have a friend, or your grocer, ice man, or coal man, who is intending to make this trip. If so, wouldn't you rather patronize a fair road—the scenic line of the world, where every mile is a picture—the road where working conditions are ideal and the employes are all boosters? Get on the New Scenic Limited at St. Louis, Mo.; ride over the Missouri Pacific to Pueblo, Colo., and the Denver & Rio Grande to Salt Lake City, Utah; then the Western Pacific to San Francisco, Calif. One long grand joy ride without change of cars, over the most beautiful mountain scenery in the world. We are working for this system and would like to have you ride on it and tell your friends about it. When you buy a ticket over this system, you are helping to pay wages to first-class mechanics, as this system does not employ cheap labor or handy men. Think this over when you are taking your vacation; also tell your friends to ship their freight over these lines and help the good cause along. Spend your money on the roads that are fair to us, and boost for your friends.

R. W. SMITH,
ARCHIE ALLISON,
DONALD McIVER,

Boiler Makers' Boosters' Committee.
Local 473, Helper, Utah.

Chattanooga, Tenn.

Dear Sir and Brother:

Just a few words about a labor forward movement just pulled off in Chattanooga; it was very successful in every detail, especially the metal trades, and we attribute major portion of our success to the International Brotherhood of Boiler Makers in sending Second International Vice-President Nolan here at the time. The boiler makers had made no preparations to take any part in the forward movement. Brother Nolan came in and got what few men together that would try to hold a meeting, and got an organizing committee started out, accompanied by himself. He saw every

boiler maker in this vicinity and held several good, enthusiastic meetings; the result was that instead of four or five of the faithful trying to do business, they all turned out. The regular attendance is 30 to 40 every meeting night and every one a booster; several new applications at each meeting. Brother Nolan has laid a foundation for a good Metal Trades Council, which will be organized this month. All metal trades are in a fairly good condition, regardless of the financial depression we have had for over 18 months. Several non-union shops cut wages 10 per cent. The Casew Hedges Boiler Manufacturing Company was the first to cut wages; it is the worst non-union shop in the country. No Union shops have cut wages here and but a very few union men out of work here, but several hundred non-union men are idle and some of them have commenced to wonder, does it pay to organize.

I am glad to note your valuable Journal is keeping pace with the times and would like to urge every man working at the trade to read it through every month and give it to some non-union man to read. We hope to have Brother Nolan with us at every opportunity, as he was beneficial to all metal crafts.

Brother T. J. Garvey, president of District No. 13, paid us a visit last month and addressed a well-attended meeting of boiler makers and machinists and reports things in good shape on the Southern Railroad and along lines from an organized view or standpoint. Fraternally submitted,

TOM HALL,
Local Organizer A. F. of L.

Portsmouth, Va.

Dear Sir and Brother:

The convention of the Virginia State Federation of Labor held at Fredericksburg, Va., June 7, 8, 9, 1915, there were 200 delegates in attendance, including ten ladies representing the garment workers. The feature of this convention was that every delegate that was eligible to become a voter had to qualify himself before he could take part in this convention. Older delegates who have attended these conventions for years claim this was the best one yet. For the first time in the history of the Federation, Norfolk, Portsmouth, Newport News and Roanoke, Va., worked together as a unit, and there is a reason to believe that this convention and the business way that it was conducted has created better feelings and understanding than ever before between the tide water section of organized labor—that is the sentiment of the rank and file.

The boiler inspection bill was unanimously endorsed at the first reading, and we have every reason to believe that it will be a preferred measure at the next session of the Legislature, as we have one boilemaker on the legislative committee, the writer, and I hope that the brothers throughout the

state will appreciate this consideration that was given our craft by electing one boiler-maker out of a committee of five, therefore I hope every boilermaker of organized labor in this state will consider it is his duty to work for the endorsement of this boiler inspection bill, and not only vote for men that will support the measure of organized labor, but use your influence on others to do the same. This boiler inspection bill is the same as the Kansas bill, with a few changes. The Kansas bill reads "labor and industry commissioner;" our bill reads "labor commissioner" of Virginia. Instead of ten years' experience ours reads five years. Instead of bond approved by executive board, ours reads approved by labor commissioners. So you see I have taken your advice so far and have been successful, and if there is anything you can advise me appertaining to the future success of this bill I will appreciate the same, as I would like to get this bill before every local in the state. I have an idea, but I think you have a better one, so if I am not asking too much of your valuable time I will ask you to assist me.

Hoping this will be satisfactory, will close with best wishes for success and the welfare of the brotherhood, I am

Yours fraternally,

H. E. PHELPS, Local 57.

Springfield, Mo.

Editor of Journal,
Dear Sir and Brother:

I will be pleased to be given a little space in the next issue of the Journal, as I have two pictures which I would like to have produced with this article. These pictures show a traction engine after it had exploded on account of no inspection and being allowed to run in an unfit condition.

The accident occurred five miles north of Springfield, Missouri, July 8th. You can see in cut No. 1 that the boiler reared up and fell over on its back. In cut No. 2 you

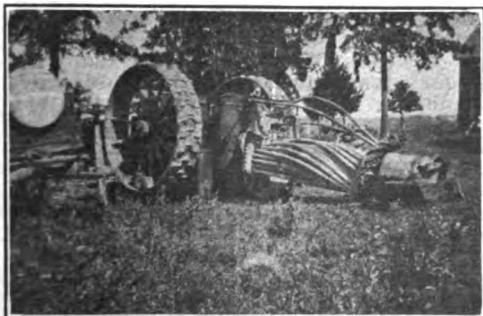

A VIEW OF A BOILER EXPLOSION.

can see the rest of the boiler laying by the side of a tree, which is two hundred yards from where the remainder of the engine is laying. The water tank was standing to the right of the engine in cut No. 1, and was blown through the end of the house,

knocking dishes from the table, the windows out and knocking the chimney down. The cause of such an explosion is the lack of a state boiler inspection law in the State of Missouri, which would require every owner of a boiler or boilers, to have them inspected to assure the safety of the public. Everybody seems to be taking a hand these days in the "Safety First" move, but for some reason our good legislature loses sight of the state boiler inspection law.

I desire to say a few words relative to conditions in my district. For the last ten months the Frisco has been working very short time; some back shops on five days per week, eight hours per day; others four days per week, eight hours per day. When a man quits, they have not been hiring a new man to take his place. However, I am pleased to say things have taken a slight change for the better. All back shops, with



ANOTHER VIEW OF THE SAME EXPLOSION.

one exception, are on six days per week and eight hours per day. I have heard of only two new boiler makers having been taken on over the entire system, still we should be thankful for small blessings and we all admit six days per week is much better than four. Business looks pretty good, but so far seems to have gotten only to the door, where it seems to have hesitated whether or not to enter. From the present outlook, I trust within a very short time, working conditions on the Frisco will be almost normal again.

I would be glad to hear through the columns of the Journal, reports from representatives in various parts of the country relative to conditions in their territories. I trust if any of you should have explosions similar to the one I have described above, you will send a picture of same to the Journal, which might have a tendency to teach the people the need of an inspection law.

Trusting I have not occupied too much space, and thanking the editor for his kindness in permitting me to converse with the members of the organization through the Journal, I am, with best wishes to all

A. F. BINGHAM,
Pres. & B. A. Dist. No. 23.

Gassaway, W. Va.

Dear Sir and Brother:

Enclosed is a picture of boilermakers and helpers employed at the Gassaway shops, which we hope, "if space permits," to see in the next issue of the Journal. It affords me pleasure to state that each one is a member of Local 135, and stands loyal to his

Take our latest issue "July," not a single article concerning our affairs except three officers' reports and only Brother Nolan's report has any dates, others as a rule are several months behind. Why?

As for your reasons for not printing correspondence concerning our affairs I want to say I have copies of the journal since



A GROUP OF THE BOILER MAKERS AND HELPERS, LODGE No. 153, GASSAWAY, WEST VIRGINIA.

brotherhood. We may not look just as nice as some well-dressed bunch among flowers and shrubbery, but look at our monthly report. That's where we make our showing.

Any one coming this way for work must be sure their card is A No. 1.

With best wishes to all I beg to remain,

Yours fraternally,

S. C. DAVIS,
C. and F. S. 153.

Washington, D. C.

Dear Sir and Brother:

I am writing a few lines in regard to our Journal which seems to be almost useless to our organization on account of the strict censorship of its pages, especially since the recent decision to eliminate all correspondence concerning the affairs of our organization. I would ask how are we to know the views of the membership unless through the pages of our Journal? We cannot communicate them any other way without violating our constitution and to wait until our next convention to exchange views it would be too late to give questions due consideration.

1903, and in many of them our members have abused each other in any but brotherly terms without a word but as soon as the abuse goes higher it is stopped. This is not fair and if such a thing happened in public affairs I don't know what would happen, I for one, and I am sure many others would like to read about the work of our organization, what is being done. I notice in the A. F. of L. report for 1914 our organization won (6) six strikes—I would like to know where they are. I never knew we won a strike, what became of 369 and many more questions I would ask if I may which would be interesting to our readers.

Trusting I may see this in the next issue and you will again open the Journal to our readers, I remain,

Fraternally,
GEO. P. SMITH,
F. S. L. 450.

A Reply by the Editor.

The writer of the above article speaks of the strict censorship maintained over the Journal, and asserts that a recent decision

was made to "eliminate all correspondence concerning the affairs of our organization." This is an erroneous statement, as no such decision was reached; therefore, arguing from false premises, the brother has reached wrong conclusions. What the editor recently decided to reject was muckraking, mud-slinging articles containing personal abuse and fault-finding. Any mutt can knock and find fault, but this does not tend to build up our organization, but, on the contrary, creates bad feeling and tends to disrupt our membership.

The above article could have been rejected, because it came under those prescribed in our recent announcement; still, as most of its criticism seems to be directed against the editor, we are reproducing it with this statement and leave it to our members to judge.

We do not fear criticism; in fact, we believe fair criticism, honestly and conservatively put, sometimes does good, as we are all human and liable to err, and these give us the other side of the question; however, before such is made, we ought to be sure we are right and the object should be to remedy a fault rather than create a disturbance.

The brother asserts that many issues of the Journal since 1903 have contained abusive articles; we fail to see how this can be used as a justification for the continuance of the practice or what can be gained by so doing.

In the latter part of the article he asks a number of questions, which would, no doubt, be promptly answered were they addressed to the executive officers in charge of these matters; however, it looks as if the brother wanted to air his opinions rather than secure the information. What the organization needs more than anything else is to eliminate this spirit of criticism and fault finding and give a helping hand to those who are helping to build it up and extend its sphere of usefulness.

THE EDITOR.

Seattle, Wash.

Dear Sir and Brother:

Brother William Shanlay, Reg. No. 1006, died on June 5. He was buried in Calvary Cemetery on June 9. He had a very nice funeral and it was very well attended by the brothers.

Leonard Parant, father of Brother George L. Parant, died on June 25 and was buried in Calvary Cemetery on June 26.

Mrs. B. Martin, mother of Brothers James and Robert Martin, died on June 22. She was buried in Calvary Cemetery on July 3.

May they all rest in peace. They were all fortified by the rites of the Holy Mother Church.

With sincere good wishes and kindest regards, I remain

Yours fraternally,

DAN P. MCKILLOP.

Chicago, Ill.

Dear Sir and Brother:

Just a few lines to all the locals of the Brotherhood of Boiler Makers, Iron Ship Builders and Helpers of America, that the Auxilliary to their Brotherhood is progressing. This letter is written with the hope that every local of the Brotherhood will put their shoulder to the wheel and have the courage and gallantry to say we, too, will have an auxilliary to our local. Brothers, we need you and you need us; just give us the helping hand and see how willing and helpful we can be in your very own struggles.

Local No. 454 deserves special mention and highly commended for their efforts in our behalf. This class of men that value and appreciate the qualification of woman-kind, assumed the initiative work by having a ladies' night at their regular meeting place and thus obtained the names of eligible women and in due course of time had their charter and all other paraphernalia for the women to go right ahead with their part of the work, and on June 24 the members of Stoney Island Lodge No. 17, Ladies Auxilliary to the Brotherhood of Local No. 454, were duly elected and installed by Sister Mollie Geary, Second International Vice-President, and assisted by Sister Rose Green, Conductress of Garfield Park Lodge No. 12. The International officers are more than pleased to see this march forward, and Chicago has an especially large field with eight Brotherhood locals. We ought to have eight auxillaries.

No doubt uninformed brothers will think and say, well, get out and do something. Now, brothers, be honest with yourself; ask and answer this question: Can any one person (with only the wages of a workingman) stand the expense of getting out and organizing? But give us your co-operation and watch our strides; with your continual guidance we can fit ourselves for the many struggles that beset the pathway of our union working people, and the credit will be all yours, and not ours.

Now a few words to the sister lodges; never be discouraged; let each officer set a good example by attending the meetings regularly, and at all times give every member something to do; impress them with an individual importance and that nothing can be well done unless each and every one will do their part to the best of her ability. Remember, sisters, there are no laurels in holding an office; the only honor is when an officer has the love and respect for harmony from every member in her lodge, and thus lighten the burden of responsibility, and when differences of opinion (and that is all it is) come up in the lodge room, remember that is one of our cherished rights to have our own opinion and to think as we please, but to say the things we think would be fatal in the cause of harmony and justice. When a question or argument is being debated, let it be based in sisterly love and

individual rights and privilege, and that majority rules.

Sisters that have had no lodge training and sisters that have should study parliamentary ruling, as the technicality of the law has saved some people from hanging. Follow the constitution and ritual in the spirit they were written; let us be the guiding star to our fellow creatures, by being unselfish and untiring in all our efforts by being charitable in thought, word and deed, to our enemies, as well as our friends, and by practicing the Golden Rule, and thus ennobling ourselves.

With the very best wishes to every brother and sister in our noble order, I remain
Yours fraternally,

MOLLIE GEARY,
Second International Vice-President.

Tacoma, Wash.

Dear Sir and Brother:

Inclosed please find picture of Foreman Strinsky and the apprentice boys of the Milwaukee shops in Tacoma; some of them

far, but there is no reason why at least two yards on the Atlantic Coast and the same number on the Pacific should not be equipped to build any of the ships needed."

"You follow this up by stating that twenty-two or twenty-three years ago some large and powerful vessels were built at the Norfolk Navy Yard, and contend that inasmuch as lots of efficient mechanics abound in that vicinity, and owing to the fact that it has increased its facilities recently argues well for it having a ship on the stocks all the time. Good for New York and Norfolk Navy Yards. All credit to them; may they always have a ship on the way. But, my dear Mr. Editor, why special mention of New York and Norfolk Navy Yards; do you fail to recognize that the navy yard that serves the needs of the country most lies midway between these two? Surely if the other yards have had the benefits for a quarter of a century, don't you think that if you are sincere in lending a helping voice to the development of navy yards you should



FOREMAN AND APPRENTICES, MILWAUKEE SHOPS, TACOMA, WASH.

look rather dark complected, but I assure you that it not their natural color. They have handed me this picture, as they would like to see it in our valuable Journal, so please have it reproduced and put in the next issue if possible.

Yours fraternally,
A. W. RICKETT, S. L. 568.

Philadelphia, Pa.

Dear Sir and Brother:

Referring to your editorial on "A Large Increase in Building Program of Navy" in June issue, we note the following phrasing in your editorial: "New York has got most of the ships built in government yards so

recognize the development of the Philadelphia Navy Yard?"

Can you think of any community that compares to Philadelphia for mechanics on marine work? We can boast of the fact that we can start and complete a ship in its entirety with the natural resources from our own state. Can the other? We think not. Now, Mr. Editor, we want you to print this in the next issue of Journal, and hereafter when the battleship subject arises, you must not fail to recognize that Philadelphia has sent to sea some of the most powerful vessels afloat, and with home labor, too, so we write you these lines to let you know that our section has as many efficient mechanics

and facilities equal to any and better than some.

With best wishes to the Brotherhood at large and especially the navy yard lodges of the country, we remain

Yours fraternally,
 PHILADELPHIA LODGE No. 19,
 R. S. HOPKINS, C. S.

P. S.—We would like to see some communication from the other navy yard lodges so as to keep in touch with one another and in this way we can become more acquainted and educated to one another's needs.—R. S. H.

In writing the article referred to, the editor broke the bounds of his editorial sanctum, and tried to imagine himself as a naval strategist and as such desired to select the two yards which, by location, would be the logical points to locate naval bases; however, he did not want to detract from the merits of Philadelphia as a ship-building center, especially as it is the home of Lodge No. 19, one of the most progressive navy yard lodges in the country. In giving out work, no doubt Legue Island will be cared for.—The Editor.

BUILDING TRADES COUNCIL IN AFFILIATION WITH BUILDING TRADES DEPARTMENT AMERICAN FEDERATION OF LABOR.

Resolution.

The following resolution has been endorsed and adopted by the Milwaukee Building Trades Department of the American Federation of Labor:

Whereas, The B. J. Johnson Soap Co. of Milwaukee, Wis., manufacturers of the following brands of soap to-wit: the Borax, Calumet, Etna, China, Ajex, Galvanic, Badger, Johnson's Naptha, Palmolive Soap, Palmolive Shampoo, Palmolive Cold Cream and the Johnson's Washing Powder, all of which is being manufactured in a building erected and constructed almost entirely by NON-UNION LABOR; and

Whereas, Every proposition to a fair and honorable adjustment of the now existing difficulty has been made by the Milwaukee Building Trades Council to the B. J. Johnson Soap Co. for them to employ UNION LABOR in the erection and construction of their new buildings; and

Whereas, The cardinal principle of ORGANIZED LABOR is that we "patronize those that patronize us;" therefore, be it

Resolved, That the American Federation of Labor and the Building Trades Department and their affiliated International Unions, State Federations of Labor, city central bodies and the membership thereof be made familiar with the true facts and at-

titude of the B. J. Johnson Soap Co., who employed NON-UNION LABOR in the erection and construction of their new buildings.

Endorsed by Boilermakers and Helpers, Local Union No. 107.

Danville, Ill.

Dear Sir and Brother:

We would like to have this notice placed in next month's Journal:

Local No. 360 won the watch that was raffled off by Local No. 22 to get Brother A. Thompson an artificial leg. No. 652 won it. We would like to thank all the lodges and brothers that helped us and this brother to get his leg; the brother gets along fine on it.

Trusting this will be satisfactory, and with best wishes to all, I beg to remain

Fraternally yours,
 WM. J. IRWIN, C. S. L. 22.



MISS GERTRUDE CURE OF DENVER, COLO., AND MR. AND MRS. JOHN CURE OF TEAGUE, TEX.

Kansas City, Mo.

Dear Sir and Brother:

This letter will acknowledge receipt of your letter dated July 9, in regard to contributing an article for the Journal each month. I believe your suggestion is a good one and should be followed up, as it will no doubt take some time to get the men interested in same. While I make a quarterly report to all locals in my district, the other locals do not get the information.

The Machinists' Journal is very progressive along this line. If there ever was a time the laboring class should stand together, it is right now, and unless we are willing to accept another brother's ideas that will benefit the labor movement, I am afraid that we are going to meet with a situation that will prevent us from improving our conditions and wages for some time to come; as I have several important matters that I must look after on my district, I will be unable to send you a report for this month, but will try and have something for the next month's issue.

With best wishes and the interests of our organization at heart, I beg to remain

Yours fraternally,
C. A. McDONALD,
B. A. Dist. No. 5.

Wilkesbarre, Pa.

Dear Sir and Brother:

Having made a study of conditions in the different labor organizations and laws of a few, I cannot help but write a few lines on same. I find in every labor constitution and by-laws a law which reads that the members shall buy goods which are union-made and which have the union label on them.

Now in making a study of this law I find that the brothers do not do their duty. It is a shame to go to some meeting and find only three or four members present which I have found in different union meetings. I think a good many who read this will agree with me that a good many members of labor unions are only what are called card men—just belong to a union for the sake of carrying a card. Never attend a meeting, buy any kind of goods or clothing, and don't care. Now you cannot be a union man at heart and buy scab-made clothing and wear them and not attend your meetings and help keep your union in business.

You are all aware of the fact that it is our duty to try and do away with child labor, sweat shops and prison labor, as true union men, and every time we get the union label on anything we buy it is a point gained, and every time we buy clothing or other articles without the union label we are helping to keep child labor, sweat shops and prison labor. Therefore it is our duty to attend our meetings, buy nothing without the union label, to be a true union man. So be a union man at heart, and not a card man.

Hoping to see this in our next edition of the Journal, I beg to remain,

Fraternally yours,
T. J. CAVAN.

East Boston, Mass.

Dear Sir and Brother:

Lodge No. 585 participated in another of the series of mass meetings held June 28th in East Boston under the auspices of the Metal Trades Council of Boston in the organizing campaign still on. Brother Daniel N. Generson of Lodge No. 585 made a ringing speech in behalf of the legitimate rights of organized labor, and International Organizer Charles Scott pointed out in no uncertain terms the expediency of a well regulated amalgamation of union workmen in the different metal trades crafts.

At our last regular meeting a representative of Boston Central Labor Union presented to the members' attention the case of the department and dry goods store, the girls of Barre, Vermont, who have been out on strike since April 1 in an effort to obtain a minimum weekly salary of \$6. Miss Emma Sevegnay of Barre made a very convincing

appeal for financial assistance for her associates, and Lodge No. 585 voted a substantial donation to the girls who have shown wonderful sagacity in conducting their righteous battle for a living wage. The action of the lodge in so doing was warmly advocated by President William McNabb, Treasurer Bernard McDonnell and Brothers William Clouter, Charles F. Smith and John Warneck.

We are pleased to hear that Brother Edward Scrivins, who has brought many new members into the lodge, is rapidly regaining his usual robust health, which was greatly impaired of late. Ed Scrivins is one of the best boys in the country and one of the most consistent union men in our organization.

Lodge No. 585 has recognized the services of Brother John Dennis on tank jobs by tendering him a rising vote of thanks. Brother Dennis has an able lieutenant in Brother Thomas De Freitas, who is known from Maine to San Francisco as the "popping-off kid." Brother De Freitas may have an elastic tongue, but its principal function consists in telling men "why" they should belong to a trade union, and he enjoys the confidence of many leading lights of our brotherhood, including that true apostle of scientific trade unionism, that chivalric knight of our organization, Sixth International Vice-President John J. Dowd.

Lodge No. 585 has heard with great regret of the passing on to the great beyond of Jeremiah Leary (father of Ex-Alderman Michael J. Leary of Boston), an old-time boilermaker and ship fitter, an old and faithful member of old Lodge No. 9 until his retirement from the business several years ago.

Our statutesque trustee, Brother Augustus E. Page, and his estimable wife are receiving the congratulations of the many friends in Greater Boston over the recent birth of handsome twins, a son and a daughter, and at last accounts mother and children were doing nicely, as the medical fraternity would say.

Our live wire president, Brother McNabb, is constantly on the alert to prevent if possible any non-union boilermakers or helpers from performing any kind of repairs or construction work in breweries which are "right," and in a future article I may have a very interesting story to tell concerning this crusade of Brother McNabb.

It is a pleasure for the writer to state that Brother John J. Farrell, although somewhat past the meridian of life, is still hale and hearty, and working at the business at the flange fire every day.

The "old reliable war horse" of boilermakers' union in this section of Boston is no figure of speech when applied to John Farrell, who has been true blue in storm and sunshine, and who, in an industrial atmosphere permeated with sycophants (who have forgotten the source of their present "revenues" and conditions) is never

ashamed to admit that he is a union man. As on former occasions members of this lodge will be seen in a live Boston Labor Day parade in their capacity as delegates to the Boston Central Labor Union, etc.

Fraternally yours,

DANIEL B. McENNIS,
S. L. No. 585.

Wichita, Kas.

Dear Sir and Brother:

At a special meeting of Lodge No. 518, International Brotherhood of Boilermakers, Iron Ship Builders and Helpers of America, the following resolutions were adopted:

Whereas, God in his infinite wisdom has removed from this world of strife and toll J. Devlin, a brother of J. M. Devlin, of Lodge No. 518;

Resolved, That we, his brothers, extend to the family our heartfelt sympathy and condolence in this sad hour of sorrow and grief; and be it further

Resolved, That a copy of these resolutions be sent to the Journal for publication, a copy to the family and a copy spread on the minutes.

W. O. WILBURN,
G. W. THOMPSON,
DICK RAMSEY,
Committee.

Kansas City, Kas.

Dear Sir and Brother:

As it has been some time since Local No. 83 has been in print, I thought I would take this opportunity of letting the brothers know we are still doing business at the same old stand.

I take great pride in informing you that one of our brother members has dropped from the ranks, but to an elevated position. Brother Theo. A. Conroy, boiler-maker, Register No. 68428, has been appointed postmaster at Buckhart, Mo. I am certainly glad to know that some of our fellow members have the progressive spirit, and while I am always sorry to lose the membership of a good brother, I congratulate him on his appointment and take this public means of telling him so and letting the other brothers know.

It is certainly something for Local No. 83 to feel proud of that we can send men to serve Uncle Sam, but I have always known our little bunch, despite their ups and downs, and generally more downs than ups for the last 12 months, would climb somewhere after awhile. I hope to see more of our members get a move on them for the better. Every man that tries to help himself in the right spirit also benefits his fellow man.

We are doing pretty well in our local these rainy days, and I hope to be able to send in some more news of a progressive nature at an early day. Congratulations to Brother Conroy from No. 83, and with best wishes to all our members,

Fraternally and respectfully,

FRANK STOVER, S. L. No. 83.

Post prize is given to Grand Junction anglers, 7 pounds, 5 ounce trout, E. H. Friend, and the prize lochlever trout caught by him in the Gunnison river. The fish weighed 7 pounds and 5 ounces after reaching Denver. A lochlover trout weighing 7



BRO. E. H. FRIEND, OF GRAND JUNCTION, COLO., AND HIS PRIZE FISH.

pounds and 5 ounces has been received by the Denver Post from E. H. Friend of 308 Pitkin avenue, Grand Junction, Colo., who caught it. Friend was awarded a prize of \$25 offered by the Post for every trout weighing over 7 pounds when weighed at Denver.

The trout was caught at Mile Post 303, near Richards' place on the Gunnison river, Saturday evening. According to Friend's statement, it weighed 8 pounds a few minutes after it was landed.

The prize winning fish was caught after a long struggle on a silver doctor fly No. 2 baited with a willow fly. The trout is being frozen in a cake of ice, and will be on exhibition in the business office of the Post within a few days. Friend is a boilermaker in the D. & R. G. shops at Grand Junction, Colo.—Denver Post.

The above clipping is from the Denver (Colorado) Post in reference to the award-

ing of a prize to Brother E. H. Friend of Grand Junction for catching a trout, and the photo shows both Brother Friend and the fish.—The Editor.

Danville, Ill.

Dear Sir and Brother:

Enclosed you will find resolutions we would like to have printed in the next issue of the Journal:

Whereas, It has pleased the Almighty God in his infinite wisdom to remove from our midst Brother Christ. Freese, be it

Resolved, That Local No. 22, Boiler-makers, Iron Shipbuilders and Helpers of America, do hereby extend our utmost sympathy to the bereaved family, and a copy of these resolutions be sent to the family, a copy sent to the local and a copy sent to the Journal for publication, and our charter be draped for 30 days.

FRANK JERGENS,
HERMAN POGGENDORF,
WILLIAM J. IRWIN,

Committee.

Des Moines, Iowa.

Dear Sir and Bro.:

I have been asked many times by traveling brothers why they never see anything in the official Journal as to the conditions on the Rock Island as it would be helpful to them in securing employment should the company be hiring men. Will say that while very few boiler makers are being hired and know of no opening at the present time due to the fact that at many points on the system they have scarcely recovered from the depression in business, which lasted for several months when release came at most points about the first of April. It was quite severe at many points, practically eliminating the shop forces and reducing the force in many round houses. Notwithstanding this fact the Rock Island has worked more boiler makers and helpers and better hours throughout the system for the past year than most roads within its territory and when the business warranted the return of men to work a special effort was made to reach men laid off, advising that their positions were again open if they desired to return, and am pleased to state that only a very few failed to keep the shop committee and officials advised of their address, when away from their local point and promptly returned to work according to their seniority of service.

A few new boiler makers have been employed at Shawnee and Chickasha, Okla. Chickasha has a rush of business at present in addition to regular up-keep of power on account of converting a number of coal burning locomotives into oil burners. We have recently obtained a letter issued by the company dealing definitely with returning men to work after being laid off and which will aid materially in handling the work and eliminating a great deal of

argument as to what is the proper thing to do as to leaving address, who will do the notifying, at a specified time to report for work. The sense of the letter as follows:

In the event of a reduction of forces of any class of shop employes covered by our schedules, the employes laid off will sign a memorandum form in the office of the master mechanic or the foreman at the point employed, giving his address where a letter or notice will reach him in the event of a resumption of work at the point at which he is laid off, the original of the memorandum to be retained by the man and a carbon filed in the office in the senior employing officer, at the point where the man is laid off.

When vacancies are filled or force increased the senior man laid off in any of the crafts will be given the opportunity, seniority be governed. The shop chairman at the point will furnish list of names of senior men desired and he will see to it that they report for duty within two weeks of the time he is served with such notice, or the position will be considered vacant.

You are always privileged to employ temporary men to fill these positions, pending the return of senior men. Men so employed should be notified that the positions are temporary. At minor points where no shop chairman is available, the employing officer will notify the senior men of the craft effected by mail, retaining a copy of the letter. In the event no word is received within fifteen days from date of mailing the letter these positions will be considered vacant.

Working conditions on the Rock Island are fair due to the interest taken by the employes to see that the contract is complied with by both the company and the men. It is not out of the ordinary for some local officials to violate the agreement when it is to their interest to do so and it is up to the men employed at the point to protest against such actions which in most cases is being done. I am very sorry to say that we have some members who do not take enough interest in their own welfare (say nothing of the welfare of others and the organization at large) to work as close to the line as they should for it is very necessary that the men hew to the line in order to be in position to properly deal with any violations that may take place from the official side of the table. The careless attitude by some of the men, I think, is brought about through lack of attending meetings regularly and in so doing they are not familiar with the business of the organization. I find throughout my territory in conversing with boiler makers through other lines that a like condition exists. We have a local federation organized at every point on the system where all crafts are employed which aids materially in handling differences, but in some cases are not attended as they should be in order to have the proper understanding of the differences that arise

and the contract covering same as they arise very frequently.

A few days ago a violation of contracts was inaugurated on the Kansas City, Mexico & Orient at Wichita, Kas. Brother Franklin asked me to investigate the trouble and adjust it if possible. On getting in the matter I found that the boiler makers' special rules in the joint agreement covered drilling of stay bolts and quite a number of new fire boxes are going to be applied at that point.

Since the signing of their agreement, Sept. 1, 1914, the company had installed a radial drill press and they propose now to revise the rule in the boiler maker special rules permitting machinist's helper to do

the drilling of stay bolts for fire boxes where the radial drill can be used, instead of boiler makers doing the work as per agreement. This simply demonstrates what our contracts are worth, not only on the Orient Railroad, but all others, who have contracts, and it is very necessary that all members working under agreements insist that they be complied with, for if we submit to the company compromising on one rule today because it happens to be to their best interest they will seek to either misinterpret, sidestep or compromise two rules tomorrow.

Yours fraternally,
GEO. W. PRING,
Gen. Chairman Boilermakers.

A Compilation of Labor News.

BY THE A F OF L NEWS SERVICE

INJUNCTION RULE IS KINGLY.

Zion City, Ill.—Secretary-Treasurer Olander of the State Federation of Labor addressed a public meeting in the interest of lace makers who have been locked out and enjoined by court orders from calling on employes of the Marshall Field lace factory "for the purpose of inducing them to leave their employment."

Secretary Olander said these injunction judges substitute a form of personal government for government by law. He showed that law courts have invariably held that peaceful picketing during a strike to be lawful, but that regardless of such rulings the equity courts forbid such picketing, and thus virtually set aside the law. The right to combine with others in the exercise of lawful personal rights, and to induce others to do likewise, is upheld in the law courts, but is denied and forbidden in many instances by the equity courts. The right of trial by jury provided by the constitutions of both the nation and the state is never denied in court of law, but the right of trial by jury is seldom, if ever, recognized by judges sitting in equity and assuming the right to themselves to act in the triple capacity of prosecutor, judge and jury. The injunction process as used against working people on strike is based upon the old Roman theory that the citizen has no rights except those accorded him by the government. This is in direct opposition to the Saxon theory, upon which American law is based, that the government may exercise only such rights as are accorded it by the people.

The speaker also pointed out that several of the acts forbidden by the injunction issued against striking lace makers are held by the United States Congress to be entirely proper and right, because these acts are specifically permitted by the Clayton act. The members of the National House of Representatives and Senate, by the passage of a law prohibiting the issuing of such injunctions by the federal courts, have specifically given their approval to the exer-

cise of the various rights which certain judges in state courts undertake to forbid.

COOLIE-MANNED SHIPS SOLD.

San Francisco.—The Dollar Steamship Co. has sold two of its vessels to parties in Vancouver, British Columbia, according to statements by Captain Dollar. This ship owner has sold vessels before, but the seamen's bill is blamed for the present disposal. Lately Captain Dollar has been in the public press almost continuously with threats to change the registry of his ships from American to British because of the seaman's act, and Editor Scharrenberg of the Coast Seaman's Journal makes this comment:

"The one consoling thought in the whole affair is the knowledge of the fact that no American will lose his job because of this transfer. The same coolie crew and the same alien officer who manned the Dollar steamers during their temporary sojourn under the Stars and Stripes will remain on those ships under the Union Jack.

"It so happens there are no Americans on these American (?) ships. So the change in registry will be exceedingly simple. It means a change of flag and nothing else. Yet Captain Dollar will continue to pose as the first shining victim of that horrid, abominable seamen's act. He will continue to tell the simple Simons from Maine to California that he could no longer compete with foreign ships because of the onerous conditions regarding the character and comforts of the crew, etc., imposed upon his ships by an ill-advised Congress.

"Yes, indeed, it is simply awful for Americans to contemplate this awful loss. But our British friends need not rejoice. Captain Dollar will keep them on the jump with frequent threats to change his vessels to Chinese registry.

"Captain Dollar will never be perfectly happy until he finds some nation which permits him to run his ships just as he pleases, without any kind of restrictions or regulations whatever."

JOHN R. LAWSON GIVEN LIFE TERM.

Trinidad, Colo.—“Fresh from the employment of the coal operators of Colorado, including the Rockefellers, who have engineered these prosecutions, yourself a coal company attorney, you were so prejudiced against me that my case in this court was a travesty on justice.”

The above is a portion of the statement read by John R. Lawson when Judge Hillier denied him a new trial and sentenced him to imprisonment for life on the charge of causing the death of John Nimmo, a mine guard, October 25, 1913.

At times Lawson's lips trembled. It was not a physical fear, but a choking emotion as the unionist recalled outrages inflicted on Colorado miners.

Lawson called Judge Hillier's attention to the fact that the state supreme court is now reviewing claims of unjudicial conduct on the part of the ex-coal company attorney.

“You refused to permit the jury,” he said, “to be drawn from the regular jury box provided by law, and you ordered an open venire. This method was exactly adapted to procure what none were surprised to discover, a hand-picked jury of coal company artisans.

“Nothing was to be permitted to stand in the way, and it is significant that even a jury so selected refused to convict me until a bailiff selected by you, according to affidavits on file in this court, tortured a jurymen with manufactured reports of the dangerous illness of the juror's wife, and as a final stroke warned the jury that under your orders that jury would have nothing further to eat until they rendered their verdict.

“Solemnly facing iron bars and prison walls, I assert my love for justice and my faith in its ultimate triumph; not a justice of theory, but of reality, extending to men, women and children, whose proper equality of opportunity it embraces.”

The sentence will be vigorously contested. Lawson's attorneys are now preparing appeal papers.

WOULD JAIL ROCKEFELLERS.

Chicago, Ill.—“If the next Congress represents the people of the United States its first act will be to cite before it John D. Mackenzie King, their tool. And if these Mackenzie King, their tool. And if these men continue to defy the nation they should be indicted for crime against the government and sent to jail.”

Frank P. Walsh, chairman of the commission on industrial relations, made this declaration before several thousand men and women at a mass meeting called to protest the trial and conviction of John R. Lawson.

The demand that the Rockefellers and their press agent be jailed was made in connection with the refusal of these men to answer certain questions put to them

while before the commission on industrial relations at Washington.

“The case of Lawson is the case of the mine operators and the mine workers,” continued the speaker. “The Colorado Fuel and Iron Company, which John D. Rockefeller rules through his son, and of which Lamont M. Bowers, chairman of the executive committee, was local representative on the ground, controls Colorado industrially and politically. Realizing they could not secure the conviction of the miners in any other way, they had a bill passed in the legislature creating a new judicial district; and the newly elected governor appointed to the new judicial position thus created a lawyer who had served in a subordinate capacity on the legal staff of the corporation. With this lawyer as judge, even then it was found necessary to pack the jury in order to obtain conviction for murder.

“In the trial of Lawson the honor and integrity of the United States judiciary is absolutely on trial.”

James Lord, president of the A. F. of L. mining department, and Mother Jones also spoke. The former declared that John D. Rockefeller directed the mine operators, and he should be tried and convicted of murder for the massacre of the innocent women and children at Ludlow and the murdering of the different leaders in the ranks of the strikers who were slain by his gunmen.”

MINERS WANT EIGHT HOURS.

Scranton, Pa.—International President White and officers and members of the United Mine Workers' Union are conducting the most extensive organizing campaign in the history of the anthracite coal fields. The campaign will continue until next Labor Day, when representatives of the three anthracite districts will meet to prepare demands of the miners for presentation to the operators.

The first of next April the present agreement expires and the miners are strengthening their lines for this event. While they are not discussing a strike at this time, the history of the miners is that of every other organization—preparation makes peace possible. President White has taken personal charge of the campaign. He is addressing one and two meetings every day. Monster parades are a feature of these gatherings. It is estimated that there are now 50,000 unaffiliated miners in the anthracite region. On this figure the organizing campaign managers base their hope for a 100 per cent organization, and have adopted as their slogan, “After fifty thousand converts.”

“Organize” is heard from every platform in the three districts. “Those who would be helped must first try to help themselves,” declared President White in one of his speeches. “Operators do not look upon the mine workers' organization as the representative of the non-affiliated miners; they only count the strength of the organization. Consequently the fellow on the outside of the union is the best friend of the operators.”

To show his faith in organization, President White makes this pledge, which is receiving hearty indorsement by the miners who know what trades unionism has accomplished:

"Give your representative a 100 per cent organization and we will secure for the men of the anthracite region the eight-hour day and other ideal conditions for which you have longed for lo these many years."

JOURNEYMEN TAILORS' UNION RESUMES A. F. OF L. AFFILIATION.

Washington.—The Journeymen Tailors' Union is in full affiliation with the bona fide trade union movement, and the label of that organization is again recognized by the American Federation of Labor.

Differences have existed between the Journeymen Tailors' Union and the American Federation of Labor because of the former's assumption of jurisdiction over other garment working trades, contrary to charter guarantees of the interested unions and the constitution of the A. F. of L., which provides for action by the convention in such cases.

As a result of decisions by the last A. F. of L. convention, the Journeymen Tailors' Union held a referendum and decided to assume their original title and jurisdiction.

The following letter from President Gompers to General Secretary Sweeney indicates that this controversy is now happily ended:

"Washington, D. C., July 10, 1915.

"Mr. Thomas Sweeney, General Secretary Journeymen Tailors' Union of America, Corner East Sixty-seventh Street and Stony Island Avenue, Chicago, Ill.:

"Dear Sir and Brother—Your favor of the 8th instant to Secretary Morrison was, by reason of the action of the executive council of the American Federation of Labor, turned over to me for reply, and I cannot adequately convey to you the great gratification which your official announcement gives that by the referendum vote of the membership of your union, the question of amalgamation, jurisdiction, title, etc., has been in full compliance with the decisions and declaration of the Philadelphia convention of the American Federation of Labor, and the direction of the executive council thereon. Therefore, in conformity with the action of the Journeymen Tailors' Union of America, and in compliance with the instructions of the executive council of the American Federation of Labor to the undersigned, the Journeymen Tailors' Union of America is recognized in full affiliation with the A. F. of L., the indorsement of the union label of the Journeymen Tailors' Union America is hereby restored, the monies forwarded by the general secretary of the American Federation of Labor in payment of per capita tax of said organization, and held in abeyance, is hereby directed to be received by the secretary of the A. F. of L. and receipt for the same forwarded to you by Secretary Morrison.

"And now, permit me, not only in my own name but in the name of the executive council and the name of the great labor movement of America, to express the gratification which we must all feel that our former good relations have been re-established, and to express the hope that great benefit shall come to the tailors, to all the workers in the garment trades, as well as to the workers of all trades and callings. Rest assured that every effort will be made by our movement to be helpful to your organization and your members.

"Permit me to say that under instructions of the Philadelphia convention I shall soon take up with you and the officers of the other unions in the garment working industry the subject matter of bringing about more harmonious relations and co-operation in the best interests of the trades in all our great movement.

"With best wishes, and hoping to hear from you often, I am,

"Fraternally yours,

"SAMUEL GOMPERS,

"President American Federation of Labor."

CAN'T COLLECT "DAMAGES."

Fort Smith, Ark.—The non-union Bache-Denman Coal Co. will not collect three times \$427,820.77 from 200 members of the United Mine Workers' Union, and this concern has lost faith in the Sherman anti-trust law as a means to destroy trades unionism.

Several months ago the company declared for the non-union shop. A strike resulted, followed by the suit for damages. International officers of the mine workers were included. Attorneys for the workers asked Judge Youmans of the United States District Court to dismiss the suit on the ground that the ownership, conduct and operation of a coal mine is not interstate commerce, and does not, therefore, come under the jurisdiction of the Sherman anti-trust law.

The judge sustained this position and threw the operators' plea for three-fold damages out of court.

Because of the court's ruling the principles of the Clayton act were not passed upon by Judge Youmans.

MOTHERS' PENSIONS URGED.

San Francisco, Cal.—In an address to the Labor Council of this city on the value of mothers' pensions Judge Henry Neil said:

"The mothers' pension system is not a charity any more than the public school is a charity. We spend money for free education because it is the economical and efficient thing to do. We know we cannot afford to have our children grow up in ignorance. But thousands of children are prevented from obtaining an education because their fathers are dead or for some reason fail to provide. The pension system provides food, clothing, shelter and care by the child's own mother, without which the free public schools cannot do their work.

"Wherever the pension system has been

tried, its results satisfy all classes. Juvenile crime and defectives are decreased at once, because the pensioned mothers are enabled to remain at home and take care of their children. If children have a good home with their own mother, juvenile crime decreases. Children raised in poverty recruit the police stations, jails, courts, penitentiaries, hospitals and asylums, because they did not get a fair start. The spending of ten million dollars this year for mothers' pensions will save the taxpayers a hundred million dollars in the coming years. The cost of courts, prisons and asylums has been increasing by leaps and bounds."

PROTECTING CHILD WORKERS.

Washington.—When a legislature has been induced to place a child labor law on its statute books, the public often assumes that its duty is ended, says the children's bureau of the Federal Department of Labor, in a report on the administration of the child labor certificate system in Connecticut. The bureau says the passage of a child labor law is only a beginning in the task of protecting children from overwork and exploitation, and that the greatest task is to see that the law is carried out. In Connecticut a child cannot go to work until he is 14 years old, and until 16 cannot work unless he has an employment certificate. Under the Connecticut system the State Board of Education dovetails the working of the compulsory education law with the child labor law. Agents of the State Board inspect conditions in the various cities and towns. The bureau announces that other states will be investigated for the purpose of discovering the best system of protecting children at work.

GOMPERS COMPELS PEACE.

New York.—The New York Times gives editorial testimony to the ability of President Gompers in molding a public opinion in behalf of industrial peace.

In the American Federationist, July issue, President Gompers criticised the Cloak, Suit and Skirt Manufacturers' Association for abrogating their agreement with the International Ladies' Garment Workers' Union. The title of the editorial was "Contract Breaking Employers."

The New York Times of July 8 publishes "The Reply to Mr. Gompers." In the editorial a criticism is indulged in of the responsibilities of unions, but the significance of the following quotation is apparent:

"A few days ago Mr. Gompers' statement to the effect that the employers were responsible for the troubles in the needlework trades was widely published. He declared that the 'chief blame' rested upon them 'without question.' No doubt that is the case in his opinion. The effect of his statement upon public opinion was such that the employers have accepted the arbitration which they had refused."

SAYS PICKETING IS LEGAL.

San Diego, Cal.—Mayor Capps has vetoed

an anti-picketing ordinance passed by the city council over a contrary ruling by the city solicitor.

In his veto message the mayor says:

"I disapprove that portion of the above section which reads as follows: 'To loiter—or to picket, act as a picket, or assist or engage in any act of picketing, for the purpose of inducing or influencing any person.'

"I believe the enforcement of the above would be an invasion of the constitutional rights of a citizen.

"The loitering or picketing referred to has been declared by almost all supreme courts in their decision as 'peaceful picketing,' and not unlawful, and it is the opinion of the city attorney that the supreme court of this state would render a like decision.

"The advocates of the passage of this ordinance have offered to defray all expenses in connection with any court proceeding which might be incurred by reason of its enforcement, but I believe it to be a very unwise proceeding for the city to incur obligations of this nature against the advice of the city attorney, which it may later be forced to meet."

MEXICAN WORKERS STRIKE.

Phoenix, Ariz.—State officials and the general public were startled by rumors of a revolt against the United States of America, started by Mexicans, with headquarters at Ray, this state.

Special detectives were loaded into automobiles and rushed to the threatened locality, whose only communication with the outside world is a telegraph line owned by the Ray Consolidated Mining Co. Failure to call for troops to repel the invaders aroused the suspicion of trades unionists, who discovered that 1,000 Mexican employes of the company had organized a temporary union and gone on strike when a wage increase was refused. Phoenix unionists called on Governor Hunt and presented the Mexicans' side of the controversy. The Labor Journal of this city warns workers to keep away from Ray. The paper charges that the company has 25 or 30 men among the strikers and are attempting to persuade them to acts of violence, and in that event "the armed guards can kill off a few Mexicans and thus drive the others back to work with no further thought of organization."

LAND FOR CITY UNEMPLOYED.

Washington.—A committee appointed by Secretary of the Interior Lane and Secretary of Labor Wilson is at work on a plan to relieve unemployment, under which the federal government would finance workers desiring to take up farm land. A complete program, with preliminary drafts of necessary legislation, is to be framed before Congress meets in December, to be proposed in connection with a rural credits bill, which, operating through the Department of Labor, would enable workers in congested cities to take up agricultural land on government

reclamation projects or public lands on easy payment loans. It is suggested that the \$10,000,000 head tax collected from immigrants might be used in financing the unemployment feature of the rural credits plan. Secretary of Labor Wilson has repeatedly called attention to this vast amount of money, which could be loaned to workers on long time and permit them to join in a genuine "back-to-the-land" movement. One of the rural credits plans will doubtless be based on this theory.

LABOR MUST COMBAT LAWSON PRECEDENT.

Worcester, Mass.—At a mass meeting of the trades unionists to protest against the Lawson verdict, Frederick W. Mansfield of Boston, the principal speaker, said:

"No element in the community has more respect for the courts and the law than the labor element. We do not wish this meeting to be misinterpreted as a protest against all law and order. But it is to protest against certain violations of law and against a perversion of justice.

"We do not make the claim that because Lawson was not present he could not be guilty of murder. Lawson might be guilty of the murder of John Mimmo or of any other person even if he were out of the state at the time if it could be proved before a fair jury and a fair trial that he had instigated the murder, if it was a murder. But there was absolutely no evidence of this character.

"There was not the slightest particle of evidence that he had ever said a word or had done any act to incite the strikers to violence. This makes him an absolutely innocent man and is the real reason why the labor men are determined to bring about his release if such a thing is legally possible.

"Labor is loath to believe that there is one kind of law in this country for Lawson, and another kind of law for Rockefeller. Investigations before the committee of which Frank Walsh is chairman, have shown that Rockefeller and his agents knew all about the conditions in Colorado, knew about the packing of the jury and the corruption of officials in high places; knew about the preparations to shoot down the miners, and in fact had guilty knowledge of the deliberate murder of many of the miners and their helpless wives and children.

"Rockefeller is allowed to remain at large. An apparently friendly capitalistic press criticised Mr. Walsh severely because of his righteous indignation exhibited in the questions that he put to Rockefeller.

"The precedent that has been established by the Colorado courts in the Lawson conviction is a most dangerous one and one which evidently is directed against labor unions. If it is allowed to become a universal doctrine in this country it would mean that every officer of a labor union would be criminally and civilly responsible for every act done by the members of the union, whether they had any personal knowl-

edge of the affair or not. It must be resisted to the utmost by organized labor everywhere."

"CLAYTON LAW REVERSES PRINCIPLES OF DECISION IN DANBURY HATTERS' CASE."

(By Ex-United States Attorney General Wickersham.)

Washington.—George W. Wickersham, United States Attorney General during President Taft's administration, agrees with organized labor that the Clayton law removes trade unions from the anti-trust act, and prohibits the issuance of injunctions in certain cases by federal courts.

Mr. Wickersham's opinion appears in the American Federationist, July issue, and is reprinted from the Alumni Register of the University of Pennsylvania with the consent of the author and of the Alumni Register.

The ex-attorney general's reference to President Gompers indicates his views of organized labor, and emphasizes the declaration of this trained lawyer that the American Federation of Labor won the world's greatest legislative victory when Congress declared that: "The labor of a human being is not a commodity or article of commerce."

Mr. Wickersham frankly states that the trade union movement has reversed the legal principles which made the hatters' decision possible, and that, as far as the federal anti-trust laws are concerned, workers can no longer be enjoined for withholding their patronage or advising others to do so. Neither can damages be recovered against them because of such actions. This, Mr. Wickersham terms "the Gompers conception of liberty"—a public notification that he is not in sympathy with declarations by Congress on this subject.

He says in part:

"But these enumerated acts include substantially all of such acts as constituted the cause of action in the Danbury hatters' case, and therefore labor organizations in the future may use the boycott as a weapon in a dispute between employer and employes without danger of interference by injunction or liability in damages by reason of the anti-trust laws of the United States. That is certainly so far as regards employers engaged in a dispute concerning terms or conditions of employment there can no longer exist under the laws of the United States a right of action on their behalf to recover damages suffered by them by reason of any individual or individuals, singly or in concert, recommending, advising or persuading their regular customers, or any other person or persons, by peaceful means, not otherwise unlawful (such for instance as might amount to extortion or libel), to withhold patronage from them.

"It is therefore apparent that the labor organizations have secured a statutory reversal of the principles of decision in the

Danbury hatters' case and the legalization of the boycott as a lawful instrument to insure the dominance of organized labor, thus substituting the Gompers conception of liberty for that of the Declaration of Independence, the Constitution of the United States and Abraham Lincoln."

"AVERAGE WAGE" IS DEFINED.

Helena, Mont.—Attorney General Poindexter has upheld the miners in their point that compensation awards should be based on weekly earnings, computed as follows:

The total wages earned during a certain period, say a year, should be divided by the exact number of days of actual employment. This sum, multiplied by six, would be the weekly wage.

Coal miners work on the piece, or ton, scale, and they do not work continuously for a year. At a conference of mine operators, miners and members of the state accident board, the question of "what is a weekly wage?" was discussed. The new compensation law is vague on the subject. All parties to the conference agreed that the working year of the coal miner averaged 240 days. On this basis the operators insisted that the average weekly wage should be determined by the following process:

Ascertain the total earning capacity of a miner for 240 days and then divide it by 52.

Attorney General Poindexter rejected this claim and supported the miners' position. He ruled:

"There are a number of cases attending the mining of coal where a fixed daily wage is paid. In such cases it would be manifestly idle, if not ridiculous, to contend, because the employment is not continuous throughout the year, that the daily wage received at the time of the injury is not the fixed amount actually paid the workman per day, but the average per diem earned in a calendar year, based upon 240 working days."

After quoting the different plans of compensation, the official concludes:

"I am, therefore, of the opinion that a construction of the law such as is contended for by the operators would be unjust to the employes and inequitable in its consequences."

ENACT CO-OPERATIVE BILL.

Springfield, Ill.—One of the most important bills passed by the recent Legislature, and now awaiting the governor's approval, is the co-operative bill, favored by the State Federation of Labor and the farmers' organizations. This act will safeguard the interests of those involved in a co-operative movement having been paved by the passage mis-use by opponents. Officers of the State Federation of Labor say:

"It is safe to assume now that the road for an effective and far-reaching co-operative movement having been paved by the passage of this act, the organized farmers as well as the trade unionists, will take advantage of the possibilities of the situation, and that

Illinois will soon be far in the lead of other states in the establishment and operation of co-operative enterprises under the direct control and management of working people. The thirty odd stores which are now in operation, and the co-operative institutions of the farmers will, under the new act, be placed upon a substantial legal footing that will mean much for their progress."

REGULATING CHILD LABOR.

Des Moines, Ia.—The new child labor law, passed by the last legislature, is now in effect. Department stores, business offices, telegraph companies, laundries and factories will have to eliminate labor by children under 14. Mines cannot employ boys under 16. Girls under 21 cannot be employed at work which requires them continuously on their feet. Eight hours is the limit for children under 16. Boys between 11 and 16 may work at street trades but must have a badge from the superintendent of schools.

STATE TEXT BOOKS.

Sacramento, Cal.—State officials say California has saved \$275,000 in one year by printing its own school text books, which is one-half the cost charged by eastern manufacturers.

CANADIAN WORKERS TO CONFER.

Ottawa, Ontario.—Officers of the Trades and Labor Congress of Canada have issued a call for the thirty-first annual convention, to be held in Vancouver, British Columbia, beginning Monday, Sept. 20.

Among the subjects scheduled for attention are:

The conditions arising from unemployment in the industrial centers in Canada.

Dominion and provincial legislation affecting labor interests.

Enforcement of the misrepresentation and monetary clauses of the immigration laws all the year around.

The proposed eight-hour labor bill.

Workmen's compensation acts in various provinces.

Amendments to the industrial disputes and investigation acts.

Fortnightly payment of wages on all railways.

Proposed amendments to Dominion elections act, including (a) the abolition of the \$200 deposit now exacted; (b) the making of election day a public holiday.

Old age pensions and all the issues that are therewith connected.

The Trades and Labor Congress is formed by delegates representing unions affiliated with the American Federation of Labor. Its function is remedial legislation in the interests of Dominion of Canada workers.

ONE KIND OF ECONOMY.

Denver, Colo.—Says the Labor Bulletin of this city:

"Governor Carlson abolished the state boiler inspection department Monday for

ninety days. By this action George B. Cossebaum, chief inspector, and deputies Joseph Humphrey and William M. Crowley are automatically fired. Governor Carlson gave as his reason for abolishing the office the administration's promise of economy. He says the work can be done well by the factory inspection department. Under the law he has the right to abolish any office for ninety days. It is understood he will continue to abolish the office every ninety days during his term of office."

RAIL FATALITIES DECREASE.

Washington.—A report by the interstate commerce commission for the first quarter ending March 31 shows that rail accidents have decreased over the like period of last year. The number this year is 65 killed and 1,972 injured. While these figures tell a ghastly story of derailments caused by defective roadways, broken wheels and broken rails, the number of fatalities has been reduced 100 per cent over last year. The number of train accidents decreased 785 during the same period.

TYPHOID TAKES 30,000 YEARLY.

Washington.—Nearly 30,000 persons die from typhoid fever each year, while 400,000 persons are incapacitated, according to a report issued by the federal public health service. In presenting these figures the health service points out that typhoid is a preventable disease, and declares that the United States "is a generation behind the times in respect to the reduction of the typhoid rate."

The health service says that American cities are hard to convince that money spent in typhoid prevention is well invested. Vaccination reduces typhoid danger 75 per cent, but sanitation also is important in the prevention of this disease, says the report.

CONCILIATORS NAMED.

New York.—Mayor Mitchell has named the following as a board of conciliation to adjust differences between the International

Ladies' Garment Workers' unions and their employers.

Felix Adler, Louis D. Brandeis, Henry C. Bruere, city chamberlain; George W. Kirchwey, former dean of Columbia law school; Walter C. Noyes, former judge United States circuit court of appeals, and Charles L. Bernheimer.

It is hoped that another protocol policy will be agreed to. The employers, last May, abrogated an agreement that had existed for five years.

MANY DISPUTES ADJUSTED.

Montreal, Canada.—Organized workers in the ladies' garment industry have been beset with numerous disputes because of discharge cases and new working systems employers would introduce for the purpose of lowering wages. The union has settled these cases satisfactorily and has also conducted a strong agitation campaign. A four days' strike against the Canada Cloak company resulted in an agreement. Another large factory, employing 200 workers, has been unionized.

WAGE BOARDS CAN'T MEET.

Melbourne, Victoria, Australia.—The European war is the reason Sir Alexander Peacock, Minister of Labor, gives for refusing to permit wage boards to meet and transact business as in normal times. These boards consist of representatives of employers and employes who adjust wage scales and working conditions. Workers are demanding that the boards be permitted to convene, as has been done in New Zealand, New South Wales and other states that have removed the embargo. The Minister of Labor refuses to yield, but has given assurance that each individual case will be considered by him, and if the workers can show a change in wage scales is necessary he will permit the board in that industry or calling to consider the same. Because of the government's negative attitude many betterments demanded by the workers will probably be postponed.

Among Our Exchanges.

FLIES AND SICK BABIES.

The Bureau of Public Health and Hygiene of the New York Association for Improving the Condition of the Poor, in cooperation with the Department of Health, has conducted an investigation into the relation between the presence of flies in houses and the occurrence of diarrhea in small children. It was desired to determine whether the house fly is the chief carrier of diarrhea or whether dirt in the home and artificial feeding are more deadly factors in this serious condition. The cases investigated were divided carefully into a fly-protected group and a fly-exposed or control group. These groups were made as similar as it was possible to make them. The infants

were visited every five days by nurses. The fly-exposed or control cases received all the instruction given in child hygiene work, but no special emphasis was laid on eliminating the house fly. In the protected group the greatest emphasis was laid on the absolute protection of the baby as far as possible from contact with flies. For the infant in the cradle, in the go-cart, on the bed and even in the arms the constant use of netting was insisted on. Over a thousand yards of netting were distributed among the protected families. Some of the results of the study are now being published in order to emphasize its lessons for the present summer. It was found that almost twice (1.9) as many infants were attacked by diarrhea among fly-exposed as among the fly-pro-

ected infants. Apart from the influence of flies, it was found that almost twice as many infants were attacked by diarrhea in dirty homes as in the clean homes. The most important factor for child mortality, however, was found to be artificial feeding. Nearly two and a half (2.4) times as many infants were attacked by diarrhea among the artificially fed as among the breast-fed infants. The influence of flies and dirt combined was found to be almost exactly equal to that of artificial feeding, even in reasonably good surroundings. Almost two and a half (2.4) times as many fly-exposed infants in dirty homes were attacked by diarrhea as were fly-protected infants in clean homes. The combination of dirt and artificial feeding made life extremely difficult for the infant. Considerably more than one out of two of them were attacked by diarrhea. Concrete studies of this kind are of great service in impressing the fact that disease among children is not a mysterious dispensation, but the result of common factors, flies, dirt and artificial feeding.—The Journal of the American Medical Association.

ACCOMPLISHING ECONOMY.

Much as has been said and written about economy, more can be said and thought with profit. That one has plenty today is no surety that there will be plenty tomorrow. Emergencies are always coming into everyone's life, and the wise man will endeavor to provide against the day of need. Many who know they should economize have no idea of how to go about it, and do not give the subject the thought it demands. It is not so simple a matter. Every man should study out the subject for himself. What is economical for me may be an extravagance for you. Buying a cheap article is not economy if one has to renew it so often that it costs more than a good, substantial article that would have outlasted three or four of the cheap ones.

Waste is one great factor in the high cost of living. Little leakages are not carefully watched, and a small leak will sink a ship. The Scotch say: "Ask thy purse what thou shouldst buy." One thing is necessary. That is never to spend more than one's income. No one should gauge his expenses by what another has done. The savings bank habit is a good one, for from saving comes having. One's never rich till he begins to keep ahead of his expenses. Carefulness of little things does not mean stinginess or meanness. Generosity is not opposed to economy. The practice of economy means more to be generous with.—The Milwaukee Journal.

MORE OFFICIAL ARROGANCE.

It appears as if government by civil service develops different degrees of tyrants. The men who issue "orders" forbidding navy yard workers from serving as officials of a labor council may be classed as petty tyrants. But the man who transmits these

orders to the victims of official arrogance and uses offensive language in so doing can be classed only as a tyrant who ought to be pitied.

F. M. Bennett, the commandant of the Mare Island navy yard, doubtless qualified as a tyrant who ought to be pitied when he formally advised several trade-unionists that they had shown themselves "unfit for the trust Uncle Sam reposes in his employes" because of their activity in furthering certain constitutional amendments favored by organized labor. The worthy commandant is evidently unable to distinguish between enlisted men serving in the navy and civilians employed in the navy yard. An enlisted man is not supposed to "talk back" when superiors write foolish letters or issue boomerang orders. But the civilian employes of our government are not muzzled—at least not yet. That grand feat has not been accomplished even though desperate attempts along these lines are being made by three political commissioners who think they control the political conscience of some 432,000 men and women classified as Civil Service employes.

Civil service was established primarily to purify politics and to secure for the government competent and efficient employes—i. e., to make appointments upon merit instead of a party basis.

Now it begins to appear as if civil service has been constructed to mean "servile service."

Against this bureaucratic endeavor the workers must protest with all their might. Government ownership has come to stay; in fact, we shall have more and more of it as the years roll by. It behooves all workers, therefore, to pay earnest attention to the case of these Mare Island navy yard workers.

Can we afford to remain silent while our fellow workers are being muzzled?

We can not, and we shall not; for silence in this instance would mean tacit approval. More than that, it would inevitably bring still further aggression upon the political rights of the workers in government service.—Coast Seamen's Journal.

NO GLORY FOR THE DEFEATED HERO.

The Railway Federationist is in receipt of several letters from men on the firing line of the Illinois Central and Harriman roads, severely criticising the officers of the Railway Employes' Department for declaring the strikes on these roads at an end.

One letter is from a local lodge of machinists not directly involved in the strike, but whose members, it is alleged, contributed more than \$10,000 in support of the strikers. In the letter submitted to the Railway Federationist it is charged that the principle of the initiative and referendum has been violated in calling off the strike, and that the officers have arrogated to themselves powers not granted them by the laws of the department.

It has been our uniform policy to make

the Railway Federationist an open forum for the discussion of principles and policies pertaining to the interests of the railway employes of this country and to serve to the best of our ability the cause of those identified with the railway shop crafts and the federated movement.

When the vote to call off these strikes was submitted last fall, we were of the opinion that a grievous mistake had been made, not because we felt the strike should be continued, but because of the manner in which the proposition was submitted.

We can not see how any good can come to the federated movement by prolonging the contest. Judging these strikes by former struggles that were continued for such a long period of time, we are forced to the conclusion that not only would it be wise and proper to discontinue them, but they should have been ended long ago.

Let us no longer deceive ourselves as to the possibility of success. Let us not be carried away by false hopes based upon the idea that something may happen that will change the tide in our favor.

Why continue a hopeless fight? Why inflict still greater suffering upon the loyal men and women who have sacrificed so much in this, the greatest labor struggle in history?

We appreciate fully that those who were most active in this strike will suffer the wrath of corporate greed. They will be victimized. They will be driven from pillar to post by corporate hirelings and even their own class will load them with dispraise. This has been the experience in the past. Those who fought to the last ditch in this conflict will be no exception.

Defeat has its glory as well as victory, but the glory of the defeated is never sung until they have been a long time dead.—Railway Federationist.

IN COLORADO.

The trial for murder and conviction of John Lawson, miner, is very far from reassuring to those who have hoped that Colorado would find a reasonably satisfactory solution of her strike tragedy and make a beginning of restoring the honor of the state. Lawson has been convicted of murder without its being proved that he killed anyone or was even present when mine guards were killed. It is definitely alleged that the whole machinery for trying the accused strikers and strike leaders has been arranged by the mine owning interests and will proceed to make terrible examples of some of them with the object of terrifying the miners into subjection.

Whether it is true or not that the indictment and conviction of Lawson and of other strikers has been framed up, it is clear that no special jury and special court provided for prosecution of cases growing out of the strikes will win any credence if only miners are convicted and the mine guards left untouched. There has been too much testimony to the kind of men employed as mine

guards and the work of terrorism that they were engaged to do for any rational person to believe that guilt was one-sided.

Colorado suffers tremendously, and not least from absentee ownership. Her greatest need is not convictions but justice. There needs no ghost come from the grave of former labor troubles to tell us that conviction of striking miners and amnesty for brutal mine guards will bring neither a solution of the difficulty nor an end of tragedy.—The Milwaukee Journal.

THE LITTLE THINGS.

Use the little things. To great minds there is nothing so small that it is unworthy of notice. Most of the men who have seen an apple fall from a tree saw only that an apple fell. Newton thought about it and discovered a great principle of nature. Many a man has seen steam lift the lid of the teakettle. Watt thought about it and applied a power that revolutionized the machinery of the world. Thinking about what one observes enlarges the mind and often leads to great results. Shakespeare told us there are sermons in stones, and Hugh Miller translated many of them for our benefit. Little differences in the color, position or nature of the rocks gave Miller his great knowledge. Little by little, a thought at a time, a fact added to a fact, made up a sum of knowledge which has been of great benefit to the world years after his death. If you would be useful to yourself and others, store up ideas. Observe what is before your eyes. Think about what you see. Do not pass by any opportunity of gaining a bit of knowledge. Be careful of the little minutes. Men have accomplished much by utilizing odd minutes that are too often wasted by the thoughtless. Blackstone wrote his commentaries in the moments while he waited for dinner. Do not despise the day of small things.—Ex.

PUBLIC SYMPATHY AS AN ASSET.

In the contest of wits that marks the struggle between capital and labor, it would seem to an onlooker that the capitalist had worsted his opponent in the plea for public sympathy. A few years ago capital felt itself so strong that it defied public opinion; while labor, realizing its weakness, appealed to the public for sympathy; and that defiance of capital and appeal of labor won the latter many victories during the growth of the trade union movement. But a change seems to have come over the situation. Capital, realizing its loss of prestige, has undertaken to make friends of the public; while organized labor, confident in its strength, is paying less regard to public opinion. In the earlier days labor pleaded for arbitration; capital declared it had nothing to arbitrate. Now capital appeals to arbitration, while labor seems to view it with distrust. This is not the universal policy of either capital or labor, but it appears to be a growing tendency.—The Public.

News of General Interest.

FINES FOR OFFENDERS FAVOR WELL-TO-DO.

In a report on "The Correctional System of Springfield, Illinois," Zenas L. Potter of the Russell Sage Foundation severely criticizes the petty fining system in general use throughout the country. He brings two main indictments against the system: First, that as a means for dealing with offenders who have confirmed delinquent tendencies fines, since they cannot remove deep-seated causes of lawlessness, are not successful in protecting the community from further law-breaking. Second, that fines are very generally unjust to persons not well-to-do, but of moderate means. On this last point the report has this to say:

"As a means for providing just punishment as between offenders the fining system is open to attack. Where petty fines are much used, as in Springfield, the general tendency is to assess them in large or small amounts in proportion to the serious-

ness of the offense, and not after taking into account the ability of the offender to pay. Speeding, for instance, will usually bring a fine of one size, carrying concealed weapons another, vagrancy another. The offense, not the means of the offender, commonly becomes the measure of the fine. The result is that as a means for punishment fines are extremely unjust. To a man of some means a fine of \$3 or even \$25 is slight punishment. But on the laborer making \$1.75 a day, and perhaps still more on his family, which is already a sufferer, even a fine of \$3 falls heavily. The offense may be the same, and the fine may be the same in two cases, and yet in the payment the poor man may suffer the rich man's penalty many times over. One hundred and sixty-eight persons in Springfield went to jail in 1913 because they were not able to

pay their fines in whole or in part, 44 being unable to meet even a fine of \$3 plus \$1.75 of costs. Many of the largest fines were assessed against vagrants who had no money at all. In such cases fines result in nothing less than sending people to jail for being poor."

A GLENN, FOUR-CYLINDER, COMPOUND LOCOMOTIVE.

By Frank C. Perkins.

The accompanying illustration shows the construction of a four-cylinder passenger engine of the Glenn type, operating on the Prussian State Railway, as designed and constructed at Grafenstadem by the Societe

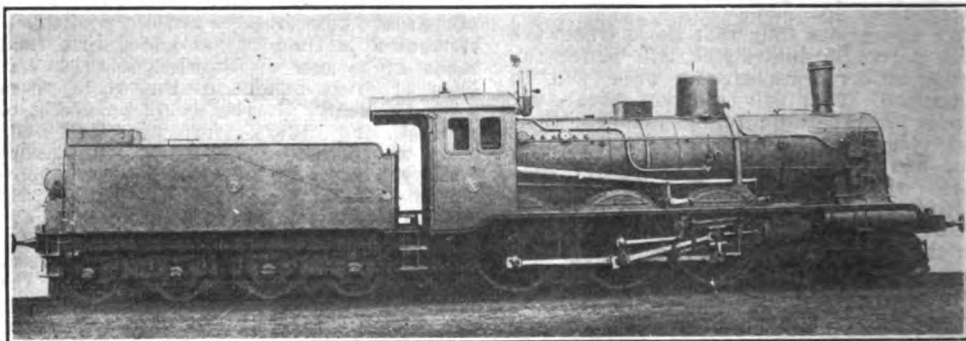

A GLENN 4-CYLINDER COMPOUND LOCOMOTIVE.

ness of the offense, and not after taking into account the ability of the offender to pay. Speeding, for instance, will usually bring a fine of one size, carrying concealed weapons another, vagrancy another. The offense, not the means of the offender, commonly becomes the measure of the fine. The result is that as a means for punishment fines are extremely unjust. To a man of some means a fine of \$3 or even \$25 is slight punishment. But on the laborer making \$1.75 a day, and perhaps still more on his family, which is already a sufferer, even a fine of \$3 falls heavily. The offense may be the same, and the fine may be the same in two cases, and yet in the payment the poor man may suffer the rich man's penalty many times over. One hundred and sixty-eight persons in Springfield went to jail in 1913 because they were not able to

Alsacienne de Constructions Mechaniques. It measures 4.3 meters in height and 10.6 meters in length and weighs 55,600 kilograms empty and 61,100 kilograms in working order. This locomotive has a water capacity in the boiler and coal on the grate weighing 5,500 kilograms, while the tender has a tank capacity of 16,000 kilograms.

The high pressure cylinders measure 350 millimeters in diameter and the low pressure cylinder 550 millimeters, while the length of stroke is 640 millimeters. The steam is supplied to the high pressure cylinder at a working pressure of 14 atmospheres from a boiler having a mean diameter of 1,464 millimeters and a total heating surface of 139.5 square meters. The boiler has 216 tubes 45 millimeters in diameter and 4.2 meters long, with a heating surface of 128.2 square meters, the heating surface of the firebox being 11.3 square meters. The loco-

motive has 6 coupled wheels 1.75 meters in diameter and a total wheel base of 7.6 meters, it being designed and constructed for a gauge of 145 millimeters.

THE CUBA FERRY.

The final link that will enable a freight car loaded to any part of the United States to be unpacked in Havana is at last completed. It has been possible for several years to send cars through to Key West over the wonderful system of viaducts planned and built by Henry M. Flagler for the Florida East Coast Railroad. Cars at this point are now to be run on board a newly completed ferry-steamer, said to be the largest in the world, and after a hundred-mile ocean trip will be landed at Havana on the Cuban Railroad system. This powerful craft, we learn from an article contributed by Harry Chapin Plummer to *The Scientific American Supplement*, bears Flagler's name and has been specially designed for its task.

Says Mr. Plummer:

"It is in the movement northward from Cuba of grapefruit, oranges, bananas, pineapples, and other products of the 'Pearl of the Antilles,' which are liable to the greatest danger of ruin or injury when transfers are made, that the new vessel must prove her worth at the outset. On her southward runs from Key West she will move trains largely laden with dressed beef and food-stuffs originating in the West and North of this country.

"Equipped with four sets of tracks of standard gage on the car deck which is 360 feet long and provides accommodation for thirty of the largest-size refrigerator-cars, the ferry-steamer is, in addition, fitted with three cargo holds. These can be loaded either direct from the cars themselves or through cargo-ports at the side of the vessel.

"The dry-cargo capacity of the boat is approximately 3,000 tons, with an additional provision in one of the forward ballast-tanks for the shipment of a bulk quantity of molasses. Each cargo-hold is served by an independent double-drum electric cargo-hoist of two tons capacity, and the necessary filling and discharging apparatus has been fitted to the tank intended for molasses.

"Ten water-tight compartments, into which the vessel is subdivided, are used for ballast purposes. These deep tanks have a capacity of 3,000 tons, and the steamer thereby can be brought down to her proper draft when no cargo is carried. A system of pipes connects the tanks, and for emptying them two 12-inch centrifugal pumps have been fitted, which have a capacity capable of clearing all the tanks within an hour and a quarter.

"The voyage of 100 miles (from dock to dock) is to be made in eight hours—at an average speed of 12½ miles per hour.

"A notable feature of the boat is the fine accommodations provided for the officers

and crew. Four individual baths are provided for the officers, while the crew's quarters are equipped with four shower-baths. Running hot and cold water is furnished for each room, and cold salt water for the showers and bath-tubs.

"The steamer, the keel of which was laid April 20 last, was built at Cramp's Ship Building Yard, Philadelphia, and launched September 22. M. C. Furstenau, consulting naval architect for the Florida East Coast Railway, designed the plans and specifications.

"The idea of quick communication with Cuba is not new, for the promoters of the Florida East Coast Railway have had it in view for many years, but the accomplishment has been slow on account of the many difficulties to be overcome. It was no small undertaking to extend the line down the sandy, marshy shore of Florida to Miami, where a long pause was made. Then came that daring engineering feat of carrying a railroad over the swampy tip of Florida, and thence by a remarkable series of embankments and concrete viaducts, using the long, curving series of keys as stepping-stones, to Key West, the outermost accessible point that can be reached in this manner.

"In building this wonderful viaduct, which is 128 miles long from Homestead, at the tip of Florida, to Key West, earth and rock embankments were used wherever the depth of the water permitted, and over fifty miles of this kind of roadbed was constructed; but in many of the intervals between the keys, of which about thirty were linked together by the undertaking, the water was too deep to permit of filling in, and moreover, many of these openings were navigable passages that could not be closed or were in such exposed positions that embankments would not stand. Here a series of massive reinforced-concrete viaducts were placed, being built with arches of 50 or 60-foot spans. Altogether these viaducts have a total length of somewhat over five and three-fourths miles, there being four separate viaducts, from 4,950 to 10,500 feet long.

"At the time the road reached Key West it built a substantial drydock, together with ample wharves, so that it was all ready when the time came to establish the hundred-mile ferry to Havana, as has now been done."—*Coast Seamen's Journal*.

GERMAN EAST AFRICAN LOCOMOTIVES.

By Frank C. Perkins.

On account of the great European war between Germany and Austria on the one side and practically all of the European countries on the other side, the accompanying illustrations, data and drawing of the modern locomotives in use in German East Africa are of special interest.

These engines were built by the Hanoversche Maschinenbau-Actien Gesellschaft, Vormals Georg Egestorff, Hanover-Lindeon. It may be stated that among the

German colonies, German East Africa occupies the premier position, both as regards size and economic importance. Its area, 389,000 square miles, is almost double that of Germany (215,134 square miles) and represents about 37.5 per cent of the entire area of Germany's colonial empire. The outward trade is very considerable and is only exceeded in value among the German colonies by the diamond mining in Southwest Africa. It is of interest to note that in the export of rubber, cotton, fibrous materials, grain, coffee, skins and ivory, East Africa holds pride of place among German protectorates.

The continuously increasing importance of the trade of this colony may be gathered from the diagram. The meter-gauge rail-

ishing colony would thus be provided with an artery of the utmost value.

It is stated that after the section from Dar-es-Salam to Pugu, 13 miles in length, it was felt great headway had been made. On January 1, 1910, the section from Dar-es-Salam to Kilossa (181 miles) was opened. On November 1 of the same year, 108 miles from Kilossa to Dodomma were opened for traffic and on July 1, 1912, 530 miles, as far as Tabora, were completed. The terminal station of Kigoma of the final section, Lake-Tabora-Tanganyika, 250 miles in length, was reached surprisingly quickly by February 1, 1914. The opening of the complete line from Dar-es-Salam to Kigoma was expected about the middle of 1914 and soon after the large steamers of the East African

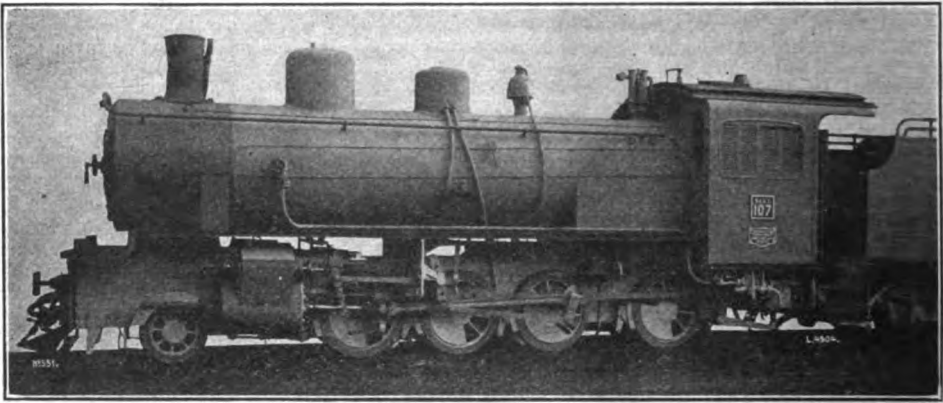

A GERMAN EAST AFRICA LOCOMOTIVE.

way owned by the East Africa Railway Company and which runs from the Port of Dar-es-Salam to Lake Tanganyika, is a very important factor in opening up this important protectorate.

It is pointed out that the immense value of this colony and its importance to trade will not make themselves fully felt until this magnificent enterprise has been completed. Regions which hold out great promise and will supply important products, such as cotton, coffee, oil seeds, for which Germany now in a large measure allows to go to foreign countries, would then be brought in close touch with the world's markets.

The importance of the Tanganyika Railway is, however, by no means limited to the traffic in the colony itself; it is intended to form a very valuable link in international trade, and when navigation on Lake Tanganyika, now in course of organization, has been opened, its chief task would be to carry on communication between the heart of Africa and the coast.

Before this great European war broke out, plans were made to convey goods from the interior of the Belgian Congo very much more quickly and cheaply than has been possible up to the present, and this flour-

Railway Company were to be plying on Lake Tanganyika.

It is claimed that the increase in the traffic has kept pace steadily with the improved means of communication. The reports of the East African Railway Company give an excellent idea of the continuously increasing importance of this enterprise.

The drawing, Fig. 1, shows that there have been many gradients of 20 to 1,000 to overcome; at Itigi the line reaches its highest point, 4,360 feet above sea-level. A good idea of the length of the Dar-es-Salam-Kigoma line, 781 miles, will be obtained by comparing it with the distance from Berlin to Milan via Bozen, which amounts to 786 miles, and the highest point of which, viz., the Brenner Pass., is only 132 feet higher than the pass at Itigi.

It is pointed out that the Tanganyika Railway had on July 1, 1914, at its disposal, rolling stock, manufactured by German works, which included 63 locomotives, 34 passenger cars, 10 mail and luggage vans, and 380 freight cars.

Of the German builders of locomotives the above-mentioned firm come first, with 24, and they are followed by Henschel & Sohn, with 19; A. Borsig of Tegel-Berlin, with 9, and Orenstein & Koppel A.-G., Berlin, with

7, while J. A. Maffel of Munich furnishes 4. It is stated that the 2-8-0-tank locomotives, of which a fair number were originally procured, rendered good service and could also be employed to great advantage in the construction of the line, but it was not long before they were found insufficient for the growing requirements of the traffic.

Therefore, the Hanover Locomotive Works were instructed to prepare designs or a very much more powerful 2-8-0 mixed train locomotive with separate eight-wheeled tender. In this connection, the first endeavor was to increase the grate area sufficiently, so as to secure adequate evaporation when using purely wood fuel. While adhering to the stipulated maximum axle pressure of 10 tons, it was possible to obtain a heating surface (inside) of 1,372 square feet and a grate surface of 28 square feet. The ratio of grate surface to heating surface, which previously was 1.52, was consequently reduced to 1.49.

It will be seen that the firebox was made broader, extending beyond the frame. The elevated position of the boiler gives ample dept of grate, absolutely necessary with

The Hanover Locomotive Works built and supplied 20 up to the end of 1913; the last three of these engines, apart from the above special equipment, were also fitted with a feed water purifier and feed water heater of the "Schnidt & Wagner" type, fitted above the boiler. With regard to the way in which these locomotives did their work, the railway management at Dar-es-Salam issued on December 6, 1912, the following statement:

"The 2-8-0 trailing locomotives have up to the present proved generally satisfactory in working and have also fulfilled the requirements as to capacity. The simple construction and the practical way in which the moveable parts have been arranged greatly simplify the working of the engine. Its smooth and jerkless running enables the staff to cover long distances (up to 160 miles) without fatigue.

"The locomotive hauls on the level a load of up to 500 tons. Over long gradients, such as, for instance, the rise on the East African 'Graben,' where constant gradients of 16-18 in 1000 are met with on a distance of about 25 miles, the weight of the train amounts

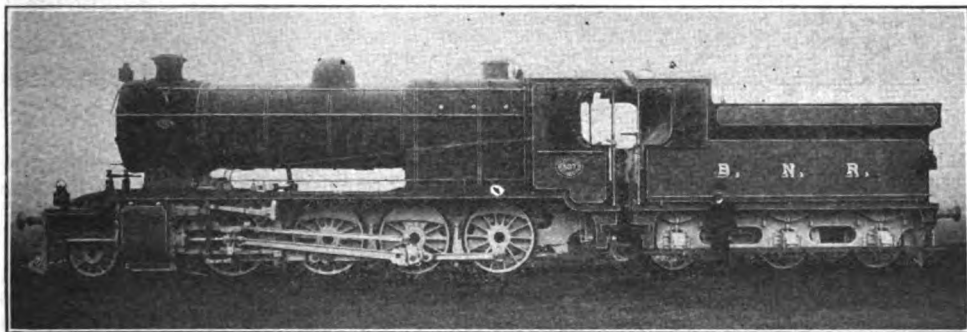

ONE STYLE OF AN ENGLISH DARLINGTON LOCOMOTIVE.

wood-fuel firing. In order to make it possible to negotiate curves of down to 260-foot radius, the second and last coupled axle were given a side play of 13-32 inch and 1 inch, respectively. The play of the Bissel axle, which has a pivoting circle of 27 9-16-inch diameter, amounts on both sides to 3 17-32 inches. It is of interest to note that the latter axle is fitted with centralizing mechanism by means of a central-pendulum support. On any deviation from the central position, a correspondingly increased load is brought to bear on the right or left-hand bearing spring by means of the oscillation of the pendulum on a ball swivel head, which spring, as soon as the curve is left behind, brings the axle back automatically to the central position.

It is said that the special equipment includes a vacuum brake, a speed indicator, sand boxes worked by hand for forward and backward running, a double cab roof, a steam separator, in the steam dome, on the Metzeltin system, a Stollerz spark arrester and a Friedmann injector.

to 260 tons. The sharpest curves met with on this line have a radius of 850 feet."

"Wood-fuel is used almost exclusively throughout the line. The dimensions of the grate and the heating surface are such that sufficient steam can always be generated."

Before the set back due to the present war conditions it was intended that locomotives of considerably greater power would have to be procured later on in addition to the above type. For through train traffic from Dar-es-Salam to Kigoma, express locomotives of larger boiler capacity would have to be adopted.

TWO ENGLISH DARLINGTON LOCOMOTIVES.

By Frank C. Perkins.

The accompanying illustrations, Figs. 1 and 2, show two English Darlington Loco-

The former was designed for a gauge of railway of 5 ft. 6 in., the cylinders being 21½-in. diameter by 26-in. stroke. It has coupled wheels 4 ft. 8 in. in diameter and a fixed wheel base of 16 ft. 0 in.

The bogie wheels are 3 ft. 0 in. in diameter and the engine has a total wheel-base of 24 ft. 2 in. The boiler has a total of 1347.5 sq. ft. of which the heating surface of the tubes is 1191 sq. ft. and of the fire-box 156.5, while the grate area measures 32 sq. ft. and the superheater elements 409.5 sq. ft.

The working pressure is 160 pounds per square inch and the tractive force 25,754 pounds. The weight on the coupled wheels is 57 tons 10 cwt., and the total weight in working order is 16 tons 18 cwt., while the maximum axle load is 14 tons 14 cwt.

The tender has wheels 3 ft. 8 in. diameter and a fixed wheel-base of 13 ft. 0 in., the

The weight in working order is 50 tons 17 cwt., the engine being 89 tons 4 cwt. and the engine and tender combined weighing 140 tons 1 cwt. The total wheel-base of the engine and tender is 56 ft. 11 $\frac{1}{4}$ in. and the length over buffers is 65 ft. 4 $\frac{1}{2}$ in. for the combined engine and tender.

INDUSTRIAL ACCIDENT STATISTICS.

The United States Bureau of Labor Statistics of the Department of Labor has just issued as Bulletin 157 a report on Industrial Accident Statistics, by Frederick L. Hoffman. The adoption of the principle of workmen's compensation by more than half of the states within the last few years em-

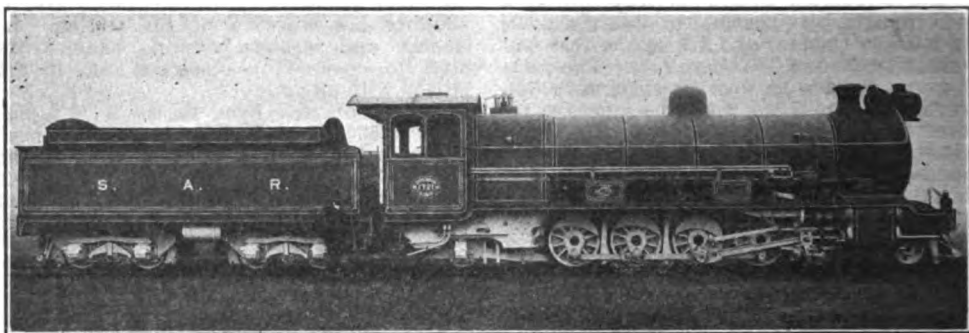

ANOTHER TYPE OF AN ENGLISH DARLINGTON LOCOMOTIVE.

total wheel base being 13 ft. 0 in. It has a tank capacity of about 310 cubic feet, while the weight in working order is 41 tons 2 cwt. and that of the engine is 66 tons 18 cwt., the engine and tender having a total weight of 108 tons 0 cwt. The total wheel-base of motives of the Robert Stephenson superheated type, constructed at Darlington, England, for the B. N. R. and S. A. R. respectively.

the engine and tender is 48 ft. 0 in. and the length over buffers is 57 ft. 4 in.

The narrow gauge engine noted in Fig. 2 was designed for a gauge of railway of 3 ft. 6 in. and the cylinders are 22 in. diameter with a 26-inch stroke. The coupled wheels are 4 ft. 0 in. diameter and the fixed wheel-base measures 12 ft. 9 in., while the total wheel-base is 80 ft. 7 in.

The boiler has a heating surface for tubes of 2211.96 sq. ft. and a firebox 149.00 sq. ft., while the total heating surface is 2360.96 sq. ft., the superheated elements 503.04 and the grate area is 36 sq. ft. The working pressure is 190 pounds per square inch and the tractive force 37,358 pounds, while the weight on the coupled wheels is 64 tons 8 cwt. and the total weight in working order is 89 tons 4 cwt., the maximum axle load being 16 tons 3 cwt.

The tender has wheels 2 ft. 9 $\frac{1}{2}$ in. diameter with a fixed wheel-base of 4 ft. 7 in. and a total wheel-base of 16 ft. 9 in. Its tank capacity is 4,250 gallons and its fuel capacity is about 400 cubic feet.

phasizes the importance of the industrial accident problem and foreshadows the time when such compensation for industrial accidents will become universal throughout the United States.

As one method of measuring this importance, the bulletin presents an estimate of the number of fatal and non-fatal industrial accidents occurring among American wage earners in a single year. The conclusion reached is that the number of fatal industrial accidents among American wage earners, including both sexes, may be conservatively estimated at 25,000, and a number of injuries involving a disability of more than four weeks, using the ratio of Austrian experience, at approximately 700,000. These numbers, impressive as they are, fail to indicate fully the number of industrial accidents, for such studies as have already been made show that of the accidents involving disabilities of one day and over at least three-fourths terminate during the first four weeks.

The industries which contribute the greatest number of fatal accidents are railroad employments and agricultural pursuits, each group being responsible for approximately 4,200 fatalities each year. Coal mining contributes more than 2,600, and building and construction work nearly 1,900. General manufacturing, while employing large numbers, produces only about 1,800 fatal accidents. When the fatality rates are considered, metal mining ranks as most hazardous, with a rate of 4.0 per 1,000, coal

mining comes next with a rate of 3.5, and fisheries and navigation following with a rate of 3.0 per 1,000. Manufacturing industries, as a whole, rank lowest, with a rate of 0.25 per 1,000, but the fact should not be overlooked that this low average rate covers manufacturing groups varying widely in hazard, including, on the one hand, boiler making and the various departments of the iron and steel industry, in some of which fatality rates as high as those in metal and coal mining have prevailed, and, on the other hand, the textile and clothing industries, in some of which the risk of fatal accident is practically negligible.

These estimates are derived from the best sources available. At the present time there are no entirely complete and trustworthy industrial accident statistics for even a single important industry in the United States. This lack of trustworthy industrial accident statistics is due to the absence of any uniform requirements in the various states as to the reports of industrial accidents. Prior to the establishment of workmen's compensation systems, no state received reports of all the accidents, or even of all the fatal accidents in its industries. With the coming into force of workmen's compensation laws, with a strong motive for careful reporting, the methods of reporting are being gradually improved, but this applies in only a few of those states where such systems have been introduced, and even in such states there is a regrettable lack of uniformity which stands in the way of comparison and combination of the statistics. Furthermore, very few of the compensation states are yet securing information at all accurate in regard to the number of employes and the period during which they are at work, information which is absolutely essential in the computation of accurate accident frequency rates.

Workmen's compensation legislation will necessarily lead to an increase in the reported number of accidents, particularly those of a less serious character, involving a comparatively short incapacity for work, but compensation legislation may also be expected to bring about notable reductions in the actual number of accidents, for wherever aggressive accident prevention work has been undertaken, it has been found that great reductions in the number of accidents have been effected, often exceeding a saving of one-half.

A large part of the bulletin is devoted to the analysis and discussion of the recent accident statistics of Illinois, Massachusetts, New York and Wisconsin, with reference to the industries in which industrial accidents are most numerous, the duration of the accident disabilities, the nature of injuries, and especially to the causes of the accidents. Much more briefly the accident experience of Great Britain, Norway, Austria and Germany is drawn upon in the effort to analyze the principal features of the industrial ac-

cident problem. Statistics of industrial diseases are also included, but official information in this country is limited to the cases which have been reported under the New York state law.

An important section of the bulletin is devoted to the progress of the movement for the standardization of the reporting, classification and tabulation of industrial accidents in the United States, initiated for the purpose of securing uniformity of practice in order that the reports of the various states may be compared and combined, and thus contribute in the largest degree to the solution of the industrial accident problem for the entire country.

CARE OF THE BABY IN SUMMER.

The Second Summer.

(Prepared by the Children's Bureau, United States Department of Labor.)

A widespread and deep-rooted belief prevails among mothers that the "second summer" is an especially perilous time for the baby, and consequently one to be greatly feared.

The facts, however, do not support this belief. Official figures show that about five times as many babies die in the first year of life as in the second, and that nearly two-thirds of the babies who die in the first year of life die in the first three months. These figures show conclusively, therefore, that the great loss of infant life takes place among very young babies, and that if a baby has survived this early period his chance of living to grow up is greatly increased.

The reason the "second summer" has acquired this partly undeserved reputation for danger lies very largely in the fact that babies are often made sick because mothers make many mistakes in feeding a baby after he is weaned and before his digestion is able to deal with ordinary family meals.

The fear of the second summer results also from the fact that the baby is getting his teeth at this time. Although the teething process sometimes is unjustly blamed for causing illness, babies are no doubt often upset by the pain of teething, and do therefore suffer more readily from mistakes in feeding.

A third reason why the second summer makes babies sick applies equally to the first summer; that is, the excessive heat affects them badly both directly and indirectly. Heat often spoils the milk and makes it unfit for the baby's use. But even a properly-fed baby may be made sick when the weather is very hot.

A long continued spell of extreme heat is very hard on babies of all ages, and the greatest care is needed to avoid other cause of illness at this time and to prevent by every possible means an attack of summer diarrhea.

The greatest safeguard which the mother can throw about her baby in the second sum-

mer is to see that he has proper food at regular intervals in suitable quantities and to keep him cool. A baby who is about 9 or 10 months old at the beginning of summer should, if possible, continue at the breast until September, because even two or three breast feedings a day may be enough to keep his digestion in good order; and in case he becomes ill to save his life. The breast milk should be supplemented with two or three bottles of cows' milk properly prepared, as directed in a former article in this series.

In addition some other food may be given, but it must always be remembered that care in feeding the baby at this age is as important as in early infancy. Changes in the diet in summer should be made very cautiously. Only one new article of food should be added at a time. It should be given at first in very small quantities, and its effect on the baby carefully watched meanwhile.

If the baby vomits, belches gas or shows looseness of the bowels the food should be greatly lessened in quantity or taken away altogether until the disturbance subsides.

For a baby from 9 months to 1 year of age the following food is recommended: Strained orange or prune juice may be given once a day after the baby is 8 or 9 months old unless his bowels have a tendency to looseness. It should be given midway between feedings; for instance, if he is fed every four hours, the juice is given two hours after a bottle feeding or nursing. It is best to begin with small amounts, say two or three teaspoonfuls, and to increase slowly till one to three tablespoonfuls are given daily.

At 9 months he may be given beef juice, beef tea or plain mutton or chicken broth once a day.

At 10 months he may have one to two tablespoonfuls of cereal once a day. Cream of wheat or farina may be used, either of which should be cooked for at least three-quarters of an hour in a double boiler.

At 10 months he may have a small piece of toast or zwieback or a crust of bread to chew immediately after his mid-day feeding.

At 12 months he may have cereal twice a day. If oatmeal is used it must be cooked for three hours and strained.

The following diet may be recommended for a child at 12 or 13 months.

- 6 a. m.—Milk, 8-10 ounces.
- 8 a. m.—Orange juice, 1-3 tablespoonfuls.
- 10 a. m.—Cereal, 1 tablespoonful with milk or stale bread and zwieback with milk, 6 to 8 ounces.
- 2 p. m.—Broth with stale bread or beef juice, 1 ounce with bread crumbs.
- 6 p. m.—Same as 10 a. m.
- 10 p. m. Milk, 8 ounces.

The principal requisite for successful feeding is that only such simple food as mentioned above be given. It is particular-

ly dangerous to give the baby of this age tastes of the family meals, for if this is done the baby is pretty sure to be given food unsuited to his digestive organs, and also to have his taste spoiled for the simple diet which should satisfy him.

Feeding the Baby During the Second Summer.

Nothing is so dangerous to a baby's health as wrong feeding; nothing so important to his healthy development as proper feeding.

For the first nine months breast milk is the only food a baby should have, except a little pure drinking water. If the breast milk is not sufficient, it may need to be supplemented, as directed in a previous article of this series, with properly prepared cows' milk given in a bottle.

For the baby between 9 and 12 months of age certain foods may be carefully added to this diet, a list of which was given in the preceding article.

For a healthy baby at the beginning of its second year the same diet may be used, and as the child grows various foods may be added. He may now take undiluted cows' milk and well-cooked cereals twice a day in addition to fruit juice, broth and dried bread.

At 15 months he may have a little rare beef or well-cooked chicken or mutton. Meat for a baby should be broiled, roasted or boiled, never fried, and should be given to the baby scraped or finely minced.

The following are sample meals for a healthy child from 18 months to 2 years old: (An ounce is two tablespoonfuls.)

- 7 a. m.—Milk, 8 to 10 ounces. Piece of zwieback, toast or dried bread.
- 9 a. m.—Orange juice, 2 ounces.
- 10 a. m.—Cereal, 2 tablespoonfuls. Cup of milk.
- 2 p. m.—Broth, 6 ounces; meat, 1 tablespoonful; vegetable (spinach), 1 tablespoonful; stale bread, 1 piece; baked apple, 1 to 2 tablespoonfuls.
- 6 p. m.—Cereal, 1½ tablespoonful; milk, 6 to 8 ounces; toast or bread.
- 10 p. m.—Milk, 8 ounces in cup (may be omitted).

The following rules for cooking and preparing certain of these articles may be helpful to mothers:

Toast: Bread one day old, cut in very thin slices; slices placed on edge in a toast rack in an oven to dry. Leave oven door partly open.

Broth: Of round steak, 1 pound; of water, 1 pint. Put the meat on in cold water and allow it to come to a boil; then lower the flame so that it barely simmers for three or four hours. Remove the meat and add enough water to make up the original amount of liquid; strain through a wire sieve and set aside to cool. When cold the fat is removed in a solid piece, leaving a clear liquid or jelly. Heat a small portion when it is time to feed the baby. Keep the jelly covered and on ice.

Meat: One tablespoonful. Take meat, round or sirloin steak, scraped with a silver spoon. When you have the desired amount shape into a pat and broil on a hot, dry spider. When done, add a little salt. Or a piece of rare round or sirloin steak, the outer part having been cut away is scraped or shredded with a knife.

Spinach: Cook spinach in salted water until tender. Pour cold water over it and drain. Rub through a fine sieve.

Baked Apple: Apple baked three-fourths of an hour. Skin and core removed; 2 tablespoonfuls of pulp strained through a fine sieve.

Cereal; Flour Preparation: Cereal preparation, three-fourths of a cup, cooked with 1 quart of water for three-fourths of an hour in a double boiler. Add enough water to keep moist.

Oatmeal: Have a pint of water boiling in the top of the double boiler; add one-half teaspoonful of salt and drop in gradually one-half cup of oatmeal flakes, stirring all the while. Cook for three hours and strain through a wire sieve. Pour on one to two ounces of milk.

Never give a baby candy, doughnuts, pastry, fresh bread, griddle cakes, syrup molasses, pork or tough meat of any kind, bananas, overripe fruits, pickles, tea, coffee, soda water, beer or tastes of foods from the family table, especially during hot weather.

Additional directions for feeding older babies and rules for cooking meat and vegetables for their use are given in a bulletin published by the Children's Bureau of the Department of Labor, Washington, D. C. This publication, "Infant Care," is sent free to all who apply for it.

Summer Complaint.

"Summer complaint," or diarrhea, is one of the most dread ills which may befall the baby.

It is the principal symptom of various forms of indigestion, some of them mild and some very serious. But any undue looseness of the baby's bowels should put the mother on guard against illness.

At the appearance of diarrhoea the city mother should take her baby to a good doctor. If she has no doctor she should go to the nearest infant welfare station, where a competent physician will advise her as to the care of the baby, and the nurses in attendance will help her carry out his directions.

In the country, where it is difficult to get the advice of a doctor, the mother has a harder problem. Because she is out of the range of infant welfare stations, hospitals and often of physicians as well, it is most important to prevent every attack of illness possible by careful attention to the baby's food and general care, as already advised in these articles.

A pamphlet which may be of help to the country mother is "Infant Care," sent free to any one mailing a request to the Chief of the Children's Bureau, United States Department of Labor, Washington, D. C. This

pamphlet contains simple directions for the care and feeding of the baby, and suggests some way of dealing with various emergencies.

The healthy baby usually has one or two bowel movements a day. If this number is increased to four or more it is time to take measures against sickness.

It is well to remember, however, that the bowel movements of a baby fed entirely at the breast are normally more frequent than those of a bottle-fed baby, and that a slight increase in the number of movements is not so serious a matter to a baby at the breast as to one artificially fed. A baby fed at the breast does not usually have diarrhea, and when such a baby shows signs of digestive disturbance it is usually because he is overfed—either he is nursed too often or at irregular intervals, or is allowed to nurse too long at one time. When he does have diarrhea the time between nursings should be increased to four hours and the time at the breast reduced to five or ten minutes. If the bowels continue loose, the breast should be withdrawn entirely for several feedings, if necessary, giving the baby instead cool drinking water at frequent intervals. In this case the mother should pump her breasts at the regular nursing times, both to keep them free from drying up and to prevent their caking.

Bottle-fed babies are the most frequent sufferers from summer diarrhea, and this fact furnishes another strong argument in favor of breast feeding. Diarrhea in a bottle-fed baby is also best treated by reducing the amount of food. The bottle should be omitted for 8, 12 or 24 hours, according to the severity of the attack, and in place of the milk should be given as much boiled and cooled water as the baby will take.

Food should not be withheld for more than 24 hours without the advice of a doctor. When the bottle is resumed the food should be much weaker than before; water should be substituted for at least half the milk previously given. The milk should be skimmed and the sugar omitted.

The return to the former feeding should be made gradually by adding a little more milk each day and beginning to add sugar. The more severe the attack has been, the more slowly should changes be made.

If the baby is on "mixed" feeding, that is, partly breast and partly bottle-fed, the bottle feedings should be omitted if diarrhea appears, and the breast given once in four or five hours, with nothing but drinking water between meals.

Diarrhea is much more frequent in July and August than in the cooler months of the year, which fact has earned for it the name of "summer complaint." Accordingly the mother should use every means in her power during the hot weather to keep the baby cool. In the heat of the day the baby should wear only a diaper, with possibly one other thin garment.

Frequent cool spongings and at least one full tub bath each day, plenty of sleep and a constant supply of fresh air will help to protect the baby from the excessive heat and keep him well. Directions for this health care of the baby in summer have already been given in this series of articles.

WHAT TUBERCULOSIS COSTS IN WAGE.

Working men are always aroused when an employer or a group of employers suggest a reduction in wages. How many of the men who read this article ever stop to think of the enormous sums of money they are losing in wages every year due to one preventable disease, TUBERCULOSIS.

A careful study of 500 Boston men who had consumption, and most of whom died with it, has revealed the fact that these 500 men alone lost over \$425,000 in wages as a result of this disease. The investigators in this study were not guessing; they actually looked up the wages that the various men had been getting when they were taken sick, the length of time they were sick, and thus the amount of money they lost could easily be figured up. Each of these men lost on an average in hard cash nearly \$1,000 in wages alone, to say nothing of the enormous loss to his family and the community and the uncomputed suffering that this disease caused. It was found that out of the 500 men, 495 had to give up their work because of tuberculosis, and that the average number of weeks of complete disability when they could do nothing ranged from 58 to 89, depending on whether the men were living or dead at the time of investigation. The average rate of wages was about \$11.50, and the total loss amounted to \$426,039.

A most conservative estimate would place the number of deaths of working men from tuberculosis last year at 50,000. If on an average, every one of them lost \$1,000 in wages, the total wage loss would amount to \$50,000,000 in one year. The actual loss is probably considerably larger than that sum, a number of writers placing it as high as \$150,000,000. It will be plain, however, to every working man from these figures that an attack of tuberculosis means a serious loss in money, happiness and health. How can this disease be warded off? Just a few suggestions may save you money. Read them carefully.

1. Live in the fresh air as much as you can. You may have to work inside, but by keeping a window open and by getting a few deep breaths of outdoor air at frequent intervals you can help to insure your health. If you are at home keep the windows open, and always sleep with plenty of fresh air circulating through the room. Outdoor play and exercise are to be preferred.

2. Eat all the good, plain food you can digest comfortably. Eat a variety of foods, not all meat or all vegetables, but some of various kinds, such as fruit, meats, fish, vegetables, milk, eggs, etc. Your stomach,

bowels, liver and other digestive organs require three things primarily nourishing foods, liquids, particularly water, and bulk. Many things you eat, such as some vegetables, do not nourish the body, but they are needed for bulk in your intestines to prevent constipation. What you eat will determine to a large extent your ability to resist attacks of tuberculosis and other diseases.

3. Rest is as necessary to health as is food or air. Some people require more rest than others, but every working man or woman should try to get at least eight hours of rest every night or day in bed. Besides this, everyone should find opportunity to rest and relax while at work or between periods of work. One may relax without stopping work simply by changing or shifting one's position or task. If you work hard with your hands during the day a certain amount of mental work at night may be a recreation. It is monotony of work, doing the same thing over and over day in and day out in the same way that kills. Anyone can break the monotony if he tries.

4. This leads us to suggest recreation or play or exercise as a part of your daily life. Don't play so that you become all tired out, for then the play is dangerous. Everyone needs some play, but not too much. You cannot work all day and dance and carouse all night and keep your health. Sooner or later the strongest constitution will break and the resistance to disease will become so low that the onset of tuberculosis or other disease cannot be avoided.

5. A hundred more rules and suggestions might be given, but enough has been said to show that the safeguarding of your health against tuberculosis depends to a large extent upon you. If you live a clean, regular life your chances of escaping tuberculosis are far better than those of the man who burns the candle of his life at both ends and who pays no attention to his greatest wealth, his own health.

Editor's Note.—This article has been prepared for the Boilermaker's Journal by the National Association for the Study and Prevention of Tuberculosis. Other articles will follow, giving more details as to what you should know about tuberculosis.

CORRECTIONAL SYSTEM OF SPRINGFIELD, ILLINOIS.

By Zenas L. Potter.

This is the first report of a comprehensive survey of a city's correctional system to be issued. Besides making a careful analysis of the Springfield situation, it contains up-to-date information about the correctional problem which confronts every American city. Judges, police officials, probation officers and those in charge of correctional institutions will find in it much of special professional interest. Lawyers, social workers and the general public will gain from it much information as to most efficient methods for dealing with law-

breakers. It will doubtless become the model for other similar investigations, and consequently is of special interest.

(This is one of nine reports making up the Springfield Survey. Price 25 cents each. Published by Department of Surveys and Exhibits, Russell Sage Foundation, 130 East Twenty-second Street, New York City.)

AN ITALIAN FOUR CYLINDER PRAIRIE LOCOMOTIVE.

By Frank C. Perkins.

A four cylinder compound prairie locomotive shown in the accompanying illustration was constructed at Milan, Italy, at the works of the Societ Italiana Ernesto Breda, and is in use by the Chemins de fer de l'etat italien.

This engine has four cylinders 420 mm.

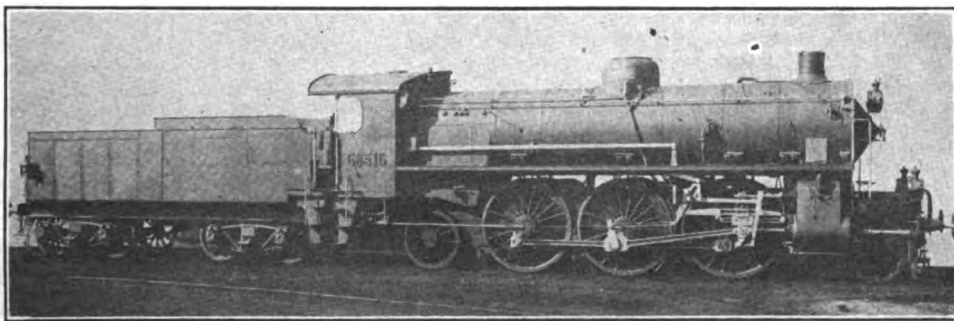

AN ITALIAN 4-CYLINDER PRAIRIE LOCOMOTIVE.

in diameter, with a stroke of 650 mm. The Diameter of the driving wheel is 1.85 meters and the fixed wheel base measures 1.95 meters, while the total is 8.45 meters.

The boiler has a coal heating surface of 242.8 square meters of which 178.2 square meters represents the heating surface of the tubes and 52.4 square meters the steam super-heater surface, while the area of the grate is 3.5 square meters, the amount utilized being 12 kilograms. This engine develops 1300 horse power and has a maximum traction effort of 10,580 kilograms.

The total weight of the engine and tender combined is 120,400 kilograms, the weight of the tender in service being 49,600 kilograms and of the locomotive 70,800.

THE LATEST AMERICAN SUBMARINES.

(By Frank C. Perkins.)

The accompanying illustration shows one of the latest types of submarine torpedo boats of the United States. It is pointed out by Herbert S. Howard, naval constructor at the United States Navy at Washington, D. C., that submarines in the present European war have come so much to the front that not only navy men, but the laymen throughout the country, have great interest in them.

He shows that submarine boats must be strongly built, as they must withstand the pressure of water when they are submerged, and for this reason the structure of sub-

marines is heavy when compared to surface vessels, and must be made of a shape capable of resisting high pressure.

It is the practice in all countries to design submarines to withstand submergence to depths of 150 to 200 feet, and beyond such depths they must not go. In order to submerge a submarine boat, water is admitted to ballast tanks, thus destroying the reserve buoyancy of the vessel. When it is desired to bring the vessel to the surface, water is pumped or blown by compressed air from these tanks. In some other types the tanks are located outside of the circular section hull, between it and a light exterior hull, more or less ship-shaped.

It may be stated that the United States submarines and those of England are practically all of the first type, while those of

Germany and France are of the latter type. When submerged, submarines ordinarily receive no fresh air, and a submarine may remain submerged for about ten hours before the air becomes too foul for breathing. In many foreign submarines devices for regenerating the air are fitted to permit them to remain submerged a much longer time, and it is worth noting that devices of this nature have been tested and are now under consideration for the submarines of our navy.

The submarine is supplied with one or more periscopes, with which it can see, provided the vessel is only a short distance below the surface. These are optical instruments with lens systems similar to those of a telescope, but with prisms at the top and bottom to turn the rays of light down, and out at the bottom. When completely submerged, however, the submarine is blind, but various forms of searchlights have been suggested for under-water vision, although so far none have promised success. The speed in submarines is a feature much sought after, according to Naval Constructor Howard of the Bureau of Construction and Repair of the United States Navy Department, but due to limitations of electric power, size of battery, the submerged speed cannot at present be brought to a high figure.

In modern submarines this varies from 9

to 11 knots, and this speed can be maintained for only one hour. If a slower speed is used the distance covered will be greater, but the maximum submerged radius of the modern submarine will probably be 100 miles at five knots. The surface speed offers greater possibilities of development and increase, and along these lines all countries are now working. For several years 14 knots has been considered about a maximum, but with development in oil engines greater speeds have been attained. Some of the English submarines in service make

modern torpedoes, speeds of from 35 to 40 knots are obtained, with ranges up to 4,000 yards or more. Submarines, however, usually fire their torpedoes at ranges of from 600 to 2,000 yards. In addition to torpedoes, submarines nowadays generally carry one or two small guns, and the use to which such guns may be put has been brought out clearly in the present war. It is often thought that a submarine is a mass of machinery, and that the life on board is simply existence in a whirl of shafts and levers. A submarine is indeed filled with machinery, and the

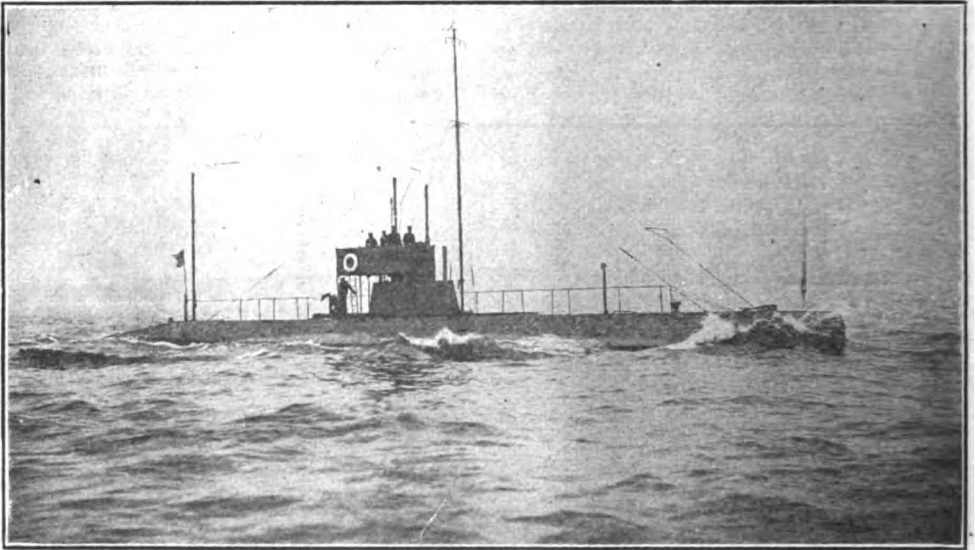

U. S. SUBMARINE TORPEDO BOAT E 2.

16 knots, and some German submarines 17 or 18 knots. At the present time, however, both in this country and abroad, there are submarines building of 20 and 21 knots speed. In such vessels steam or Diesel engines are used. None of these fast vessels are in service, so that it remains for the future to show whether they will usurp the place of the torpedo boat destroyer.

The radius of action of a modern submarine on the surface varies from 2,500 to 5,000 miles, so it may be seen that long trips are possible. All modern submarines carry torpedoes as their essential armament. In general it is foreign practice to fit two or more tubes in the bow and two in the stern, while in our navy we have adhered to a bow arrangement with two to four tubes grouped there together. To fire these torpedoes the periscope must, of course, be exposed and the vessel herself pointed at the enemy. It is not always realized, and so may be worth noting, that the torpedo itself is really a small submarine boat with high-powered engines.

The accompanying illustration shows one of the latest United States submarines, the torpedo boats running on the surface. With

crew are mechanical experts, but the quarters provided for the crew are as good as those on a torpedo boat.

All the latest appliances are provided as Naval Constructor Howard points out that electric ranges are installed for cooking food, and everything is done to make these vessels habitable and comfortable as far as possible for comparatively long cruises. For example, fuel, supplies, fresh water, can be carried by modern submarines to make a cruise of 5,000 miles.

CONGRESSMAN BUCHANAN'S VIEW OF WAR.

Since the sinking of the *Lusitania* I have seen grave danger of this country becoming involved in the European war, and whenever and wherever I have had the opportunity I have exercised my influence to create a sentiment against it. I have talked with many trade union officials and others, and find that the people are almost unanimously opposed to war.

I was officially connected with the trade unions until about nine years ago, and I am still a member of the union, associating with union men to some extent, and when I

exert my influence as I have been and am doing in the direction of peace, I feel that I am not only in accord with the sentiments, aspirations and hopes of the great wage-working masses of our country, but am also certain that I am representing their best interests. At one time I had hoped that through labor organizations of an international character there would be a sufficient degree of unity of action and solidarity among the wealth producers of the world to prevent a conflict such as has been going on in Europe for the last ten months, but it would now seem like a ghastly joke to contend that unity, solidarity and brotherly regard exist among the workers of the world. This is not a war of class against class, but of the masses against the masses.

Never before have I been so bitterly disappointed in my hopes. The best that can be said of the wage workers of Europe is that they were taken unawares; that labor organizations had no time to gather their forces and assert their principles to resist the convention prejudices and patriotic enthusiasm born of delusions many generations old. If labor had prevented the war in Europe through means of solidarity it would have won universal applause; its bitterest foes would have eulogized labor. No triumph on the battlefield would have compared with such an achievement. Of all the victories of peace in history, such a victory would have been the greatest. Above the inhumanity of crowned heads, the humanity of labor would have shone like a star. However, the war in Europe makes the idea of unity and solidarity not less desirable and beautiful, but even more appealing. Its failure in this crisis should bring forth a stronger and renewed effort on the part of the workers to meet the trials yet to come, so that the next time they will not be taken by surprise.

It is appalling when one thinks of the magnitude of this terrible conflict in Europe. It is estimated that it has cost \$17,000,000,000, with a loss of life of about 5,000,000 men, to say nothing of the destruction of property, and the loss in the stoppage of production, which no one will be able to estimate. From my point of view, the worst is yet to come, because, when the ravages of disease, due to this terrible slaughter, start running rampant over the war-stricken countries, the awful results are beyond the power of imagination.

I have seen the grave danger of this country becoming involved in war since the Lusitania was sunk and President Wilson sent his note of May 13th to Germany. The loss of innocent lives, among them women and children, appeals to any humane persons' sympathy and disapproval. But there is war in Europe, and such things demonstrate again that as General Sherman said, "War is hell." The action of Germany in the Lusitania case was brutal, but was it any more brutal than is the action of the allies in preventing Germany from securing food-

stuffs for the purpose of causing a condition of hunger and starvation, not confined to men alone, but including women and children, in order to force Germany to surrender? I disapprove of both methods. I repeat that I deply regret the loss of life and the sinking of the Lusitania, but to my way of thinking, it is no greater offense against the flag and the rights of the citizens of this country than the campaign of the Rockefeller system against the mine workers of Colorado. The mine workers were deprived of their right to go to the government post-office for their mail. Their houses were entered and robbed, and their children were beaten when their parents were away from home. Men were jailed because they dared to stand for their legal and constitutional rights. Women and children were killed by guns brought in through the instrumentality of the Colorado Fuel and Iron Company, which was directed by Mr. Rockefeller. Now we have quite a spectacle. Mr. John R. Lawson, leader of the miners, who never harmed any one, has been convicted and sentenced to life imprisonment by a lawyer of the Colorado Fuel and Iron Company, appointed judge evidently for the purpose, and by a framed-up jury consisting of gun-men and other enemies of the Miners' Union, while John D. Rockefeller Jr. is parading as an eminent business man and philanthropist; Lawson the convict—Rockefeller the saint.

I am called an ultra-radical because I denounce such methods as undemocratic and in direct conflict with a republican-democratic form of government, and I plead guilty to the charge that if that is what constitutes ultra-radicalism. I feel that I can realize in some small degree what it would mean for this country to become involved in the European war. It would mean the placing of the flower of the manhood of the working people of this country as targets for the guns and amunition of Europe (perhaps manufactured by the patriotic merchant princes and captains of industry who interpret the "general welfare" to mean the "welfare of the dollar nobility"), and perhaps the slaughtering of the toilers by the tens of thousands, together with the piling up of a war debt of several billions of dollars which would bear heavily upon the backs of the wealth producers of the country, since they would have to pay it. I can see absolutely nothing to be gained by becoming involved in this war. I have never heard anyone say that there is any conflict in Europe between democracy and bureaucracy and autocracy. No one attempts to say that this conflict on either side is being waged for the rights of men. In fact, both sides of the conflict deny responsibility for it. I am strongly convinced that the masses of people on neither side of this war know what they are fighting about.

Since I have been a member of Congress I have exercised my influence, with some degree of success, to have this government manufacture its own war munitions, not

only because it gives the workmen more work and better working conditions, but because the government also secures better supplies by such procedure, and last but not least when we stop the large profits that are now being secured by the "war munitions trust" and the "armor plate ring" we will stop one of the strongest forces that creates and fosters a military spirit, which leads to wars and is largely responsible for the awful conflict that is now on in Europe.

Some say that I am unnecessarily alarmed about the danger of this country becoming involved. I would like to point to the condition that existed last summer in regard to Mexico. War was practically declared because the dignity of a few of our enlisted men and a naval officer had been offended by Huerta. And who was Huerta? So far as this country was concerned, he had never been recognized as being anything except a brutal assassin, representing a band of cutthroats. But Huerta was required to salute the flag, get out of the country or else the United States proposed to wage war on the people of Mexico. At the time the matter was put before the House of Congress it was a question of voting for what was practically a declaration of war or voting to disapprove of the action already taken by order of the President of the United States.

Will the working people of this country, in face of the horrible object lesson being taught them in Europe's war-cursed zone, show the unity of action and solidarity necessary to prevent this country from becoming involved in a similar terrible slaughter, especially when there is nothing to be gained and everything to be lost by engaging in such questionable action? Let all who believe in peace be true to themselves and their fellow workmen, and exercise their influence to crystallize that sentiment in opposition to war, into an active force that cannot be denied and will, when the opportunity offers itself, operate to the preservation of American neutrality and bring about an equitable and peaceful termination of the present war in Europe.

I am not for "peace at any price," but I am opposed to war unless it is to prevent invasion of this country or to fight for the rights of man or democracy against autocracy. I have been and intend to continue to exercise whatever forces I can to prevent this country becoming involved in war until the danger I see has been eliminated, no matter how or by whom I am criticised for it. I feel that I owe this to the labor people of the country.

I have received all the honors that my organization has the power to extend to any one. I have received better support in campaign time from the wage earners than any man who has ever been in politics. I consider that I am only responding to the call of duty when I see grave danger confronting the masses of the people of this country, the wage-workers, and warn them

against such a danger. This I intend to do to the best of my ability, and in doing so I am only following the dictates of my conscience.

To meet the demand of the hour, organized action was essential. Labor being the one element in human society, in an efficient state of organization and in full sympathy with the preservation of peace at home and the establishment of peace abroad, was appealed to for assistance in the establishment of an institution dedicated to the attainment of universal peace. As a result of the pioneer efforts put forth, Labor's Peace Council of Chicago was brought into being and issued a general call for a Peace Congress of labor's forces to be held in the city of Washington, D. C., June 22-23, 1915.

The deliberation of the delegates assembled in the Peace Conference led to the creation of Labor's National Peace Council with the following officers:

President—Congressman Frank Buchanan, former International President of Bridge and Structural Iron Workers' Union.

First Vice-President—Milton Snellings, Washington, D. C., of Stationary and Steam Operating Engineers' International Union.

Second Vice-President—William F. Kramer, Chicago, secretary-treasurer of International Brotherhood of Blacksmiths.

Third Vice-President—Rudolph Modest, New York, Amalgamated Meat Cutters of America.

Fourth Vice-President—Jacob C. Taylor, East Orange, N. J., secretary-treasurer of Federated Central Body of the States of New York and New Jersey.

Secretary—L. P. Straube, Chicago, Ill., Commercial Portrait Artists.

Treasurer—Ernest Bohm, New York City, secretary Central Federated Union.

Sergeant-at-Arms—Fred Lohn, Chicago, Ill., Leather Workers' International Union.

General Counsel—Mr. H. Robert Fowler, Harrisburg, Ill.

The program to govern the council's further activities was based upon Resolution No. 159 adopted by the American Federation of Labor in convention assembled in Philadelphia, 1914, which read as follows:

Resolved, By the American Federation of Labor, in Thirty-fourth Annual Convention assembled, that all patent rights for arms, munitions and other equipment to be used for war purposes should be acquired by the government, and all such equipment should be manufactured in government establishments.

And in addition to the foregoing, further action calling for an extra session of Congress to immediately consider the promotion of universal peace, and the organization of local branches of Labor's National Peace Council, in not only the large metropolitan centers, but in every city, town and village that can muster a sufficient number of peace advocates to establish a local council.

Lack of space forbids going into minute details of the wonderful opportunities confronting organizations of this character in their labor of social reconstruction.

A pamphlet is being prepared that will anticipate every possible question that might arise in the minds of those honestly interested and eager to engage in a work that will earn not only the gratitude of the American nation, but also the fervent, heart-felt commendation of all neutral countries, while to the belligerents engaged in the conflict it will signify a Heaven-sent chance to end a hell-inspired slaughter that offers profit to none but the organized dollar's representative who places wealth above human lives and progress.

If you, dear reader, are interested sufficiently to aid in this work by lending your efforts to establish a local council in your home, write a letter or postal inquiry to LABOR'S NATIONAL PEACE COUNCIL, BRIGGS HOUSE, CHICAGO, ILL., and a reply will follow by return mail.

Remember, actions speak far louder than mere empty words. You are confronted with an opportunity to not only safeguard your own interest and the welfare of those you love and cherish, but also to advance world civilization. Will you help in this work or stand by with folded arms, expecting others to not only do their share, but yours as well?

No one can answer this question but yourself.

You are either for peace or war; declare yourself, for now is the time.

FRANK BUCHANAN,

President Labor's National Peace Council.

THE UNION LABEL AS A MEANS OF REDUCING THE COST OF LIVING.

By John A. Dyche, Former Secy., the Lady Garment Workers' Union.

The progress of the union label idea has been dead slow. Altho the sale of union labeled articles has increased, I doubt very much if that increase has been proportionate to the increase of the membership of the A. F. of L.

The cause of it is not far to seek. The average person in his daily purchases is looking for values rather than for ideals, and the more you talk to him of his duty to buy Union Labeled goods because of loyalty to ideals, the more you are apt to frighten him away from following your advice. The union label at present appeals to the idealist only. This inevitably results in restricted purchases and sales. A restricted sale of any given number of commodities tends to produce the following results:

1. It increases the cost of such merchandise.
2. It restricts one's freedom of selection of the class of goods one cares to purchase.
3. It cuts out a large class of would-be purchasers who happen to live in localities

where there are no stores carrying such goods.

The average unionist who in time of strike is ready to make any sacrifice for the cause, will not take kindly to the propositions which add to his cost of living and restricts his freedom of purchasing the kind of goods he likes best.

It is no wonder, therefore, that in spite of the systematic label agitation, of the strenuous and self-sacrificing effort of the label bodies, of the constant appeals of the labor press, the purchasing power of organized labor which amounts to hundreds of millions of dollars annually, still remains disorganized and scattered, and is helping to build up the fortunes of many of the enemies of union labor.

During the ten years of my secretaryship of the International Ladies' Garment Workers' Union when I was vainly trying to place our label on the market, I have had occasion to give a good deal of time and thought to the union label problem, and I came to the conclusion that the solution lies in turning our energies in the direction of finding ways and means of cheapening the cost of union labeled articles instead of hammering away at the weakness, the want of consistency of the men and women in our ranks.

I am ready to admit that at present there are a very few articles on which the use of the union label can be made the means of reducing the cost to the consumer. But a start can be made, and once you have proven to the laboring people that the label can be used as a means of lowering the cost of commodities, you have laid the foundation for a union manufacturing and trading movement which can outdistance the work of the Rochdale pioneers of England.

For this we need a combination of business abilities, with idealism and loyalty to the cause of organized labor. The men who are to handle such a proposition must understand modern business principles and methods, and must have an intimate knowledge of the class of merchandise they are going to deal with.

Organize and concentrate the purchasing power of our local union and label bodies scattered throughout the country; concentrate your efforts on a few articles, the production of which is more or less unionized, and where there is competition among union employers. Buy in large quantities and pay spot cash. Then use your local organizations as a means of distribution to reduce its cost, and the problem is solved.

From my intimate acquaintance with the women's garment industry, I am convinced that here the conditions are ripe to make a successful experiment along the lines indicated.

The price of every article contains two elements, the cost of making and the cost of distributing; that is, the cost of manufacturing and of selling the article.

What would be the effect on the price if the union label were attached to women's

garments? New York is the center of the woman garment manufacturing in this country. At the same time, at least 75 per cent of this industry in that city is unionized, where employers with the largest up-to-date plants generally run Union shops. It would be a comparatively easy matter to induce them to adopt the label if they could be assured of the purchase of a sufficient quantity of their merchandise. It is evident, therefore, that the addition of the union label in such an industry would not add to the cost of production.

Now as to the cost of distribution. The cost of selling or distributing varies in each industry. In the sale of typewriters, or pianos, for instance, the cost is considerably larger than the manufacturing.

In the woman's garment industry, the cost of distribution is from 75 to 100 per cent of the cost of production. In other words: Of every dollar you spend on a woman's garment, about one-half of it goes for the cost of producing it, and the other half for the selling of it.

It costs the manufacturers about 25 to 35 per cent to reach the retailer, and it costs the retailer (including the profits) an additional 50 or 60 per cent to sell it to the consumer.

The storekeeper spends considerable money in sending high priced buyers to New York. In stores located in large cities the rent of the shopping district and the cost of the display of his goods, the cost of newspaper advertisements, the cost of delivery and other fixed charges are the causes for the enormous cost of distribution.

In the smaller cities the cost of distribution is not less. In fact, the cost to the storekeeper in a small city who sells a smaller volume of goods than the department store proprietor is likely to be greater.

Then comes the new method of selling goods, the mail-order house. Of late the mail-order business in this country has expanded tremendously. The old concerns have grown immensely and new ones are starting up almost every day. Especially is this true in the case of women's garments. Women in this country are finding the buying of goods by mail-order more convenient than running from store to store. By means of the catalog, the store is, in effect, brought to their homes.

The present mail-order houses often give better results to the consumer than the store, which accounts for the rapid growth of the mail-order business. They have not the expense of the rents of the shopping district, no cost for the display of merchandise. Being situated in the center of the women's garment industry, the cost of buying goods in large quantities is much less than that of the storekeeper.

Still, even these mail-order houses must add from 75 to 100 per cent to the cost of their merchandise to enable them to sell at a profit. A suit which the manufacturer sells to a mail-order house for \$10 or \$12

is cataloged from \$18 to \$22. A dress for which the mail-order house pays the manufacturer \$3.25 is cataloged or sold for \$5.98. The overhead charges or the mail-order houses are not less than that of the retail store.

This is due to the heavy cost of procuring a mailing list, that is, a list of names and addresses of prospective customers to whom catalogs may be sent. The cost of printing and advertising alone in connection with the mailing list, adds from 25 to 35 per cent to the cost of the article.

Now, if by enlisting the interest and the co-operation of the various local unions, label bodies and union people generally throughout the country, by adding the label to the merchandise, union made goods could be sold in large quantities at least 35 per cent of the selling expense could be eliminated. In other words, such a plan would give the consumer goods considerably less in price than even the mail-order houses are able to do.

Every union man or woman is morally pledged to buy union made articles. Why, then, should not every local organization furnish a "mailing list" for a union catalog or mail-order house and the label agitator and promoter should become a collector of names and addresses for such a concern, and the labor press should do the advertising. If they will do so the labor union could accomplish the following:

1. A great reduction in the cost of distribution or sale of union made articles. This must result in
2. Lowering the cost of this class of merchandise, which, in its turn, must effect
3. An increase in the sale and production of union label goods.
4. It will enable union people to obtain union labeled products in localities where there are no stores for such goods.
5. By means of the mail-order system you can concentrate the whole purchasing power of the organized labor movement and their sympathizers and thereby effect economies which could not be done otherwise.

There is one other important service which such an undertaking can render. It will tend to unify the interests of the consumer and producer, which at present form two antagonistic elements in the community, neither of which cares to understand the interest of the other.

Even the co-operative societies in Europe have done little in this direction. There the co-operative societies and the unions are distinct and at times antagonistic organizations. Under the proposed plan, the unions instead of being organizations for the protection of the workers as producers only, will also become co-operative consumers' organizations.

As evidence of my faith in the soundness of my plan, I have organized a concern under the name of "standard Union Merchandise Assn., Inc.," to begin a mail-order business of union label women's wearing apparel. I

propose gradually to extend it to other classes of merchandise.

I use the term "gradually" advisedly. I shall not be in a hurry to list union labeled articles in the catalog until I am sure that I can offer better values than non-union concerns.

Just as union wages mean good wages, so union made goods must become synonymous with good values. Once our concern will become known as a large cash purchaser of union made articles, you will find this process much easier than you think.

On the other hand, when the general public will become aware that we give better values, we shall even find patronizers among people who have no love for unions or union labels.

If a sufficient response will come from the various local unions, label organizations and labor people and sympathizers generally; if they will co-operate in sending us the names and addresses of prospective buyers, to whom catalogs may be sent, we shall go to work and put the plan into execution.

The whole plan has been worked out in detail, and I have sufficient backing from union sympathizers to make this proposed undertaking a success.

By mutualizing this company, the labor unions can thus run a subsidiary concern which will do for them the purchasing and distribution of union made articles. We will then be in a position to demonstrate that by means of our organization we are able not only to raise the standard of comfort of the worker, but also lower his cost of living.—Issued by the Standard Union Merchandise Assn., Inc., 200 Fifth Ave., New York, N. Y.

FOREIGN FOOD PRICES AS AFFECTED BY THE WAR.

To show something of the effect of the European war upon cost of living following the outbreak of hostilities in August, 1914, is the purpose of Bulletin No. 170 of the Bureau of Labor Statistics, Department of Labor, just issued under the title, "Foreign Food Prices as Affected by the War." Much of the information of the report was obtained through the consular service of the Department of State, and in the main covers the period from August to December, 1914. Prices are given for 18 countries and represented by reports from over 100 cities, towns and consular districts.

The report shows that the first effect of the war was the same practically throughout Europe. Its outbreak was followed by a sharp rise in prices due mainly to panic and uncertainty. In some countries legislative measures were at once taken to check this rise. In others the governments strictly adhered to a hands-off policy, and trusted to the natural course of events for readjustment. Within a fortnight the first panic was over, and except in the actual war zone

prices began to fall. In most places, however, prices did not drop to the July level, and after an interval again took an upward turn, which has probably not yet reached its climax.

The price figures available are somewhat incomplete, but almost everywhere the upward tendency of prices appears. Potatoes was one of the few articles which showed a fall in prices in most of the more important countries. Meat, also, was another important article, which in many places increased but little in price.

Flour, on the other hand, showed decided changes. Russia is the greatest wheat exporting country of Europe, and the war practically shut off its foreign markets. It is not surprising, therefore, to find that the price of wheat flour had actually fallen in Moscow. In Germany and Austria the rise was marked, prices compared with the July level in Germany showing an increase of 25 per cent by December and 34 per cent by January. In Vienna the increase by December was 73 per cent and by January 82 per cent. In Switzerland, The Netherlands and Great Britain flour prices in December were 13 or 14 per cent above the July level, but later figures show a continued increase in February, reaching 24 per cent in the Netherlands and 33 per cent in Great Britain. Bread prices in most cases followed those of wheat flour. In Germany and Austria, however, the increases in the prices of bread were somewhat less than those in the price of wheat flour.

Sugar prices showed marked differences resulting from the war in different localities. In France the best sugar beet fields lie in the northern parts, which were early invaded, and as a result the price of sugar rose sharply. Germany and Russia are sugar exporting countries, and in Berlin and Moscow sugar showed little change in price. England imports its entire supply, and in London the price rose 70 per cent. Turkey usually imports her sugar from Russia and from Austria. The Russian supply was shut off altogether when Turkey entered the war, and the Austrian supply was reduced to what could be brought through by rail, a very uncertain dependence.

Administrative and legislative measures to check the rise in cost of necessities were very generally taken. Denmark, Egypt, Great Britain, Italy, Russia, Spain and Turkey prohibited the export of practically all food stuffs. France, Norway and Sweden listed certain articles which must not be exported, and Holland placed an embargo on butter and cheese.

Fixing maximum prices, especially for food stuffs, by some government agency was a very common measure. To some extent it was used by every country included in the bureau's report, although in Great Britain and Sweden so little of the sort was done that these countries might almost be excepted.

The methods adopted for fixing prices dif-

ferred considerably. In France, Germany, Greece, Italy, Netherlands, Russia, Spain In all these countries the municipal authorities, either alone or in co-operation with the central or military authorities, might fix maximum rates if they thought best. In most cases this right was of long standing. In all of these countries the municipal authorities have very generally made use of this right. In Bulgaria a special law was passed early in August authorizing local authorities, with the participation of financial authorities, to fix prices, both wholesale and retail. In Egypt a commission was appointed by the central government with power to fix maximum prices. Denmark, Norway and Sweden also resorted to commissions for this purpose. In Serbia the minister of the interior was charged with the duty of fixing maximum prices.

Some governments, while allowing the local authorities to fix prices on most things, issued decrees applicable to their whole territory concerning a few highly important articles. Thus Austria and Germany both prescribed the proportion of wheat or rye flour that should be used in making bread. Later both Austria and Germany fixed the wholesale price of cereals and brought the distribution and consumption of flour and bread under strict control. Turkey fixed prices for petroleum, sugar and flour. In Italy salt,

tobacco and matches are government monopolies, so that their prices were fixed by the central authority. Denmark, Holland and Switzerland limited themselves to controlling the most important breadstuff of each country.

The importance and full significance in the increases in prices which occurred would not be fairly presented without reference to the fact that increased cost of living, and especially the increase in food prices, has for several years been a question of serious concern in practically all of the European countries. The upward movement in prices prior to the war had in fact been world-wide. An inquiry of the British Board of Trade in 1912 showed increases in food prices in various countries over prices in 1900, ranging from 15 per cent in Great Britain and France to 16 per cent in Australia, to 30 per cent in Germany, to 32 per cent in Belgium and 35 per cent in Austria. In Canada and in the United States the increase shown was even greater than the highest of these figures. Thus it will be seen that the increased prices are directly due to the war, coming as the culmination of a long period of increases, are much more serious to the masses of the population than the mere figures indicate. It is obvious, too, that the increases of the first four to six months represented only the beginning of the war's effect on the cost of living.

Smiles.

ALL MADE CLEAR.

A woman missionary in China was taking tea with a mandarin's eight wives. The Chinese ladies examined her clothing, her hair, her teeth, and so on, but her feet especially amazed them.

"Why," cried one, "you can walk and run as well as a man."

"Yes, to be sure," said the missionary.

"Can you ride a horse and swim, too?"

"Yes."

"Then you must be as strong as a man!"

"I am."

"And you wouldn't let a man beat you—not even if he was your husband—would you?"

"Indeed, I wouldn't," the missionary said.

The mandarin's eight wives looked at one another, nodding their heads. Then the oldest said, softly:

"Now I understand why the foreign devil never has more than one wife. He is afraid."—Southern Women's Magazine.

SMALL CHOICE.

Pat: "Yis, sorr, wur-rk is scare, but Oi got a job last Sunday that brought me folve dollars."

Mr. Goodman: "What! you broke the Sabbath?"

Pat (apologetically): "Well, sorr, 'twas wan av us had t' be broke."—Boston Transcript.

Two men were hurrying along, and met at the corner of a street, only to collide and knock their heads.

"Why don't you look where you are going?" said one.

"I was just going to say the same," said the other, "for you made my head ring."

"Your head ring?"

"Yes."

"That shows it's empty."

"Didn't your head ring?" asked the other.

"No," was the reply.

"Then that shows it's cracked."

CATCHING UP.

The war was being discussed from all angles at the regular Saturday night meeting of the Possum Colored Gentlemen's Social Club.

"Yas, suh!" announced Pomp Dawson, with a wise look in his rolling eyes. "Dem Guhmans has got guns dat'll shoot, an shoot tuh kill, at twenty-f' miles."

"Huh?" asked Brother Jackson, cocking his head.

"Yas, suh!" went on Pomp. "Dey not on'y shoot twenty-f' miles, but dey kill at twenty-f' miles."

"Great Lawzy!" gasped Jackson. "Nigger'd run all day an' git killed 'bout supper-time, wouldn't he?"

JOKER DIDN'T COUNT.

When a man charged with disorderly conduct was arraigned by Patrolman Queen before Chief Magistrate Kempner in the Adams Street court, Brooklyn, N. Y., the court asked:

"What's your name?"

"Thomas King," was the answer.

"Ah," said the magistrate, "a Queen captures a King."

"Yes, but it wasn't a straight deal," retorted King.

"Sure it was," interrupted Queen. "This man is a four-flusher."

"What's your business?"

"I dig for a living?" answered King.

"So you are the King of Spades?" laughed the magistrate.

"Yes, but beaten by a club," answered King.

"You can come across with \$2."

"A deuce of a fine," spoke up King, "but I'll see you." He handed over the money and Clerk Hesterberg raked in the pot.

"I see a joker's no good in this game," said King, as he was leaving the court.—Exchange.

KEEPING IT GOING.

An Irish soldier on sentry duty had orders to allow no one to smoke near his post. An officer with a lighted cigar approached, whereupon Pat challenged him and ordered him to put it out at once. The officer, with a gesture of disgust, threw away his cigar, but no sooner was his back turned than Pat picked it up and retired to his sentry box. The officer, happening to look around, observed a cloud of smoke coming from the sentry box. He at once challenged Pat for smoking on duty. "Smoking, is it; sure, Bedad, and I'm only keeping it lit to show the corporal when he comes, as evidence agin you."—Ex.

THE ONLY WAY HE COULD.

A man fearfully addicted to stuttering stepped up to the ticket window at a railroad station and asked what it would cost him to go to New York by freight.

"By freight?" exclaimed the astonished ticket agent. "What in thunder do you want to go by freight for?"

"Be-c-cause," stammered the man, "I c-c-cant exp-p-press myself very w-well, c-can I?"—Suburban Electric Railway Magazine.

A BASHFUL CLERK.

A pretty young woman stepped into a music store the other day. She tripped up to the counter where a new clerk was assorting music, and in her sweetest tones asked:

"Have you 'Kissed Me in the Moonlight?'"

The clerk turned half way around; looked at her and answered:

"It must have been the man at the other counter; I have only been here a week."—National Monthly.

A private, anxious to secure leave of absence, sought his captain with a most convincing tale about a sick wife breaking her heart for his presence. The officer, familiar with the soldier's ways, replied: "I am afraid you are not telling the truth. I have received a letter from your wife urging me not to let you go home, because you get drunk, break up the furniture and maltreat her shamefully."

The private saluted and started to leave the room. He paused at the door, saying, "Sor, may I speak to you, not as an officer, but as mon to mon?"

"Yes; what is it?"

"What I am saying is this," approaching the captain and lowering his voice: "You and I are two of the most illigant liars the Lord ever made. I am not married at all."—Boise (Idaho) Gem Worker.

ORNITHOLOGICAL.

The wife of a Methodist minister in West Virginia has been married three times. Her maiden name was Partridge, her first husband was named Robins, her second Sparrow, the present Quale. There are now two young Robins, one Sparrow and three Quales in the family. One grandfather was a Swan and another a Jay, but he's dead now and a bird of Paradise. They live on Hawk Avenue, Eagleville, Canary Island, and the fellow who wrote this is a Lyre and a relative of the family.—Exchange.

FRUSTRATED.

Marie, who never knew her lessons, was speaking to one of her little schoolmates, who always stood at the head of her classes. "I should like to be the father of such a little girl," said Marie's papa, wishing to point a moral.

"No, you wouldn't, papa," said Marie.

"Why not?" asked her papa.

"Because her father has been dead for two years," said Marie.

PRACTICAL ANSWER.

Teacher: "Now, if I paid one man \$2 a day for seven days, another \$3.50 for ten days, another \$4.75 for six days—"

Reddy Backrow (whose father belongs to the union): "You'd have the durndest strike on your hands you ever saw, teacher."—Puck.

ANY TIME.

Nell: "Eliza went to an astrologer to find out when was the best time to get married."

Stell: "What did he tell her?"

Nell: "He took one look at her and told her to grab her first chance."

TWO METHODS.

"Ferdy says he is unworthy of me."

"My beau doesn't talk that way. He says I am the best girl in the world, and that the best is none too good for him."—Kansas City Journal.

CORRECT TENSE.

The teacher was explaining the tenses. "Now, Willie," she said, "suppose I should say: 'I have a million dollars.' What tense would that be?"

"That'd be pretense," answered Willie.—Boston Transcript.

WISDOM OF FATHER.

"My dad knows mor'n George Washington did," said the small boy.

"How's that?" queried the grocer.

"Las' night," continued the small boy, "when I told dad I hadn't bin skatin' he sed be know'd better, an' gimme a lickin' fer lyin'. George Washington couldn't tell a lie, but dad kin tell one th' minnit he hears it."

"As a matter of fact," said the lawyer for the defendant, trying to be sarcastic, "you were scared half to death, and don't know whether it was a motor car or something resembling a motor car that hit you."

"It resembled one all right," the plaintiff made answer. "I was forcibly struck by the resemblance."

She hung up the receiver and waited. Three times she waited, and then, exasperated, she broke into the conversation.

"Madam, I smell your beans burning," she announced crisply. A horrified scream greeted the remark, and the young lady was able to put in her call.—Christian Endeavor World.

Poetical Selections.

PURE.

A Beggar Man came hungry to my door,
I gave him bread and would have givan
more,

But Charity, astonished, bade me wait
Until her minions should investigate.
"Who knows!" said she. "This may be a
sinner,

His soul may not be worthy of a dinner!
Stay then until we try the Third Degree,
He may not be quite right," said Charity.

So all that day the twin of Gentle Hope
Put my pale beggar 'neath the microscope.
At night Fair Charity emerged aglow—
"He was all right," she said. "He died,
you know." —Exchange.

BE WHAT MOTHER THINKS YOU ARE.

Whilst walking down a crowded city street
the other day,

I heard a little urchin to a comrade turn
and say,

"Say, Chimmey, lemme tell youse, I'd be
happy as a clam

If I only was the feller dat me mudder t'inks
I am.

"She t'inks I am a wonder, an' she knows
her little lad

Could never mix wit nuttin' dat was ugly,
mean or bad.

Oh, lots o' times I sit and t'ink how nice
'twould be—gee whiz!—

If a feller was de feller dat his mudder
t'inks he is."

My friend, be yours a life of toil or un-
dilated joy,

You still can learn a lesson from this small,
unlettered boy.

Don't aim to be an earthly saint with eyes
fixed on the stars;

Just try to be the "fellow that your mother
thinks you are."

EXCELSIOR.

The shades of night were falling fast,
As through an Alpine village passed
A youth, who bore, 'mid snow and ice
A banner with the strange device,
Excelsior!

His brow was sad; his eye beneath
Flashed like a falchion from its sheath,
And like a silver clarion rung
The accents of that unknown tongue,
Excelsior!

In happy homes he saw the light
Of household fires gleam warm and bright;
Above, the spectral glaciers shone,
And from his lips escaped a groan,
Excelsior!

"Try not the pass!" the old man said;
"Dark lowers the tempest overhead,
The roaring torrent is deep and wide!"
And loud the clarion voice replied,
Excelsior!

"O stay," the maiden said, "and rest
Thy weary head upon this breast!"
A tear stood in his bright blue eye,
But still he answered with a sigh,
Excelsior!

"Beware the pine tree's withered branch!
Beware the awful avalanche!"
This was the peasant's last good-night.
A voice replied, far up the height,
Excelsior!

At break of day, as heavenward
The pious monks of Saint Bernard
Uttered the oft-repeated prayer,
A voice cried through the startled air,
Excelsior!

A traveler, by the faithful hound,
Half-buried in the snows was found,
Still grasping in his hand of ice
That banner with the strange device,
Excelsior!

There in the twilight, cold and gray,
Lifeless, but beautiful, he lay,
And from the sky, serene and far,
A voice fell, like a falling star,
Excelsior!

A CALL FOR MEN.

There's a call for men—
Courageous—sincere!
Who hate all pretense—who follow the light
With never a tho't of cringing or fear!
Men who believe in the triumph of right!
Men of conviction, honor, backbone,
Ready to stand if need be—alone!
There's a call for men—for men!

There's a call for men—
Pure-hearted and good!
Too great to be base or sordid or mean,
Who practice spirit or true brotherhood—
Men who are chivalrous, loyal and clean!
Men of principle, purity, pow'r—
True to themselves and God ev'ry hour!
There's a call for men—for men!

There's a call for men—
Large-hearted and wise!
Masters—not slaves of the things they
possess!
Willing to give till it costs sacrifice,
Who know the secret of true happiness!
Men of muscle, of heart and of brain—
Who live not for gold nor greed of gain!
There's a call for men—for men!

There's a call for men—
Far-sighted and keen!
To tackle each task—with cheer—see it
through!
Men who have vision beyond what is
seen!
Men who are eager—to dare and to do—
Men of purpose, of poise, and of pray'r—
Heroes—the burdens of life to bear—
There's a call for men—for men!
—Joseph Henry Ayres.

WHAT'S THE USE?

What's the use to worry,
You've not got long to stay—
Why not take things easy
As you pass along Life's way?
'Twill do no good to worry
If things are going wrong;
You may as well be pleasant—
Meet reverses with a smile and song.

What's the use to criticise,
What's the use to knock;

What's the use to ridicule,
Or at someone throw a rock?
Don't appoint yourself censor,
No matter what you do—
This great big world was never made
For just a chosen few.

There's none of us that's perfect,
There's few of us that stay
And never stray or wander
From the straight and narrow way.
So when you start to hammer
Some poor fool who's gone astray,
'Twill do no harm to pause and think—
You may lose your grip some day..

What's the use to kick one
Who's just about to fall?
If you do not care to help him,
Don't mention him at all.
You'll find, if you take notice,
That what I say is true;
While there may be faults in others—
There's a flaw or two in you.
—Bridgemen's Magazine.

THE MAN OF CHOICE.

Agnes wants a millionaire
With coaches and a car,
Who'll take her all around with him
And travel near and far.

Mabel wants a manly man,
Broad-shouldered, strong and tall,
While Nellie wants a stylish dude,
Who'll come at beck and call.

Sarah wants a publisher,
And lots and lots of space,
And Carrie wants a handsome man,
With a happy, smiling face.

Martha's choice a preacher is,
With hair of glossy jet,
And Nancy says she'll have to take
Whomever she can get.

Mary aims so very high,
She'll never be content
With any man upon this earth
Except the President.

I'm not sure I want to wed,
But if I do, I pray
I'll get a man who's wise enough
To let me have my way.
—Marie C. Jones.

In Memoriam

Members.

F. E. Walters, Reg. No. 101095, age 22, of
Lodge No. 447, Decatur, Ill., died June 21,
1915, of pulmonary hemorrhage. Single,
member eleven months.

Leo R. Mahoney, Reg. No. 52949, aged 25,

of Lodge 241, Washington, Ind., died April
4, 1915, from sarcoma of the neck. Single.

Relatives of Members.

Lemuel Hunt, age —, was father-in-law
of Brother William Springer, of Lodge No.

00; was born in Vernon, N. J., Aug. 4, 1840, died July 5, 1915.

Mrs. Anna B. Hartmann, age 63⁴ years, 10 months and 15 days, was mother of Brother Edward Hahl of Lodge No. 37; was born in

Germany, Aug. 11, 1851, died June 16, 1915, from inflammation of the bowels.

Mrs. Belcher, age 62 years, was mother of Brother James Belcher of Lodge No. 447, died July 1, 1915, from stomach trouble.

Lodge Notices

J. C. Dowd—Lodge No. 199. . . .

Anybody knowing the whereabouts of C. J. Dowd, Reg. No. 96128, helper, left Lodge No. 199 without a card, and also owing a board bill of \$29 and other bills. Last stamp in his book issued by Lodge No. 113. Please notify the undersigned.

E. S. MCGINNIS, S. L. 199.

W. C. Shrout—Lodge No. 82.

Any secretary taking up the card of W. C. Shrout will please hold same and correspond with the undersigned, as this brother secured transportation from Osawatomie, Kansas, to Kansas City on an unsatisfactory service letter and Lodge No. 82 had to pay for same.

A. G. EVERETT,
S. L. No. 82.

C E. Cooper—Lodge No. 528.

Any secretary taking up the card of Brother C. E. Cooper, Reg. No. 41907, will please hold same and correspond with the undersigned, as this brother left here in 1913 and left unpaid bills that Brother Ed Swanson stood good for and had to pay.

J. H. THOMAS, S. L. No. 528.

M. J. Cleary—Father.

M. J. Cleary, last heard from at Kansas City, father is very feeble and would like to hear from him. At Green Bay, Wis.

JOS. A. HAUTZINGER,
S. L. No. 395.

Quinn—McCrone.

Would like to find out address of Brother R. B. Quinn, Reg. No. 9464. Any one knowing same please notify J. McCrone, Trenton, Mo., 1008 Shanklin avenue.

Linden—Lodge No. 582.

Any secretary taking up the card of Brother C. G. Linden, helper, Reg. No. 103719, please hold same and correspond with the undersigned, as this brother left here owing a board bill for the sum of \$19.40 and a tobacco bill for \$1.30. Brother George Will stood good for this brother and got him a job and he worked up to one day before pay day and left. Brother Will will appreciate it very much if he can be located.

S. V. ACOSTA,
C. S. L. No. 582.

Brother Frederick Schultz—Lodge No. 10.

Any secretary taking up the card of Brother Frederick Schultz, Reg. No. 5235, will please hold same and correspond with the secretary of Lodge No. 10, as this brother

er left here owing a board bill of \$3 to a widow woman. WM. S. FROHLIGER,
C. S. L. No. 10.

Lost Due Book—Lakins.

The due book and card of Brother E. J. Lakins, Reg. No. 34645, was lost in Kansas City, Kan., somewhere about the 20th of June, both out of local No. 83. Any one finding same please return them to Frank Stover, Secretary Lodge No. 83.

Return of Tickets—Lodge No. 447.

Lodge No. 447 desires that all lodges that received raffle tickets for the benefit of Brother John Gray please return the tickets or send the amount for same so that No. 447 can get this matter off their hands.

CHAS. J. YOUNGER, S. L. No. 447.

Jas. A. Schofield—Lodge No. 419

Brother James A. Schofield, Reg. No. 53752, left here owing bills to members and merchants. Any secretary taking up card hold same until bills are paid.

J. S. ARNOLD, C. S. L. No. 419.

NOTICE.

Lodge No. 471 Cristobal, C. Z., desires to notify all lodges and members that the rate for boilermakers and shipbuilders in Panama is 65 cents per hour, and ask all lodges to use their best efforts in preventing any of our members from accepting employment of any branch of the trade for less than 65 cents per hour.

LIST OF MEMBERS PREVIOUSLY ADVERTISED

Stewart et al.—Lodge No. 66.

Any secretary taking up the card of Edgar Stewart, Reg. No. 21232, or Noble C. Townsend, Reg. No. 62088, will please correspond with the Secretary of No. 66, Little Rock, Ark., as these brothers misrepresented facts and secured transportation out of Little Rock and Lodge No. 56 had to pay for same.

E. WORTHSMITH,

Corresponding Secretary Lodge No. 66.
March Journal.

E. L. Chafin—Lodge No. 587.

We have suspended Brother E. L. Chafin for not paying dues or honest debts. I, myself, loaned this brother some money to bury his little child, and he will not pay it back. He also owes several bills that he won't pay.

C. C. MADDY,
Corresponding Secretary Lodge No. 587.
April Journal.

W. M. Horstmeyer—Lodge No. 381.

Any secretary taking up the card of Brother W. M. Horstmeyer, Reg. No. 9735, please hold same and correspond with Joe Wilson, secretary Lodge No. 381, Amarillo, Tex., as this brother borrowed some money from this lodge which he has forgotten to return.

JOE WILSON,
Lodge No. 381.

April Journal.

Thompson—Lodge No. 587.

F. W. Thompson, Reg. No. 20987, has been suspended by this local for non-payment of dues. He also owes about \$40 here.

T. C. MADDY,

June Journal. Secretary Lodge No. 587.

Cooper et al.—Lodge No. 491.

The following names are brothers who left Lodge No. 491 with bills unpaid: C. E. Cooper, boiler maker, bill to F. C. Krull & Co. for clothing, \$12.35. A. J. Conelly, bill to F. C. Krull & Co. for clothing, \$3.95. John Peters, Reg. No. 80223, to F. C. Krull & Co. for clothing, \$5.50. Joseph Regan, Reg. No. 95180, to F. C. Krull & Co. for clothing, \$2.40, and board and room to Sutton Sisters, \$8.83; total, \$11.23. J. M. Morgan, Reg. No. 91068, borrowed money from Local No. 491, \$2.50. Helpers: W. J. Mills, Reg. No. 98504, withdrawal card out of Local No. 145, owes F. C. Krull & Co. for clothing, \$6.40. C. A. Riley, debtor to F. C. Krull & Co. for clothing, \$4.25.

J. J. CARROLL,

June Journal. Secretary No. 491.

C. S. Burk—Lodge No. 82.

Any secretary taking up card of Brother C. S. Burk, Reg. No. 102470, will please hold same and correspond with secretary of Lodge No. 82, as this brother misrepresented facts to secure transportation to Kansas City, amounting to \$1.25, and we had to pay this bill out of the treasury of the local.

A. G. EVERETT,

June Journal. Secretary Lodge No. 82.

Robert Canton—Lodge No. 384.

Anyone knowing the whereabouts of Robert Canton, boiler maker's helper, will please notify the secretary of Lodge No. 384, as this brother left this lodge without paying his bills that the lodge went good for.

H. W. JOHNSON,

July Journal. Secretary Lodge No. 384.

W. C. Shrout—Lodge No. 82.

Any secretary taking up the card of Brother W. C. Shrout, Reg. No. 52553, will please hold same and correspond with the Secretary of Lodge No. 82, Osawatimie, Kas., as this brother left this lodge owing a \$9 board bill to Mrs. G. H. Troxell.

A. G. EVERETT,

July Journal. Secretary Lodge No. 82.

Shrout—Lodge No. 521.

Any secretary taking up the card of Brother W. C. Shrout, Reg. No. 52553, will please hold same and correspond with Sec-

retary of Lodge No. 521, as this brother misrepresented facts to secure transportation from Van Buren, Ark., to Coffeyville, Kas., amounting to \$4.95, and Local No. 521 had to pay same.

OTTY PYLES,

Corresponding Secretary Lodge No. 521.
July Journal.

Douglas et al.—Lodge No. 587.

Lodge No. 587 has suspended M. E. Douglas, Reg. No. 100307, for non-payment of dues. We have also bills aggregating to \$80 against this brother. T. C. MADDY, Secretary and Treasurer Lodge No. 587.

July Journal.

D. J. Fitzgibbons et al.—Lodge No. 99.

Any secretary taking up the card of D. J. Fitzgibbons, Reg. No. 67599, or F. G. Hayes, Reg. No. 21882, will please correspond with the Secretary of Lodge No. 99, Newark, Ohio, as these brothers borrowed money from this local which they forgot to return.

CECIL C. ROBERTS,

July Journal. Secretary Lodge No. 99.

Trials and Fines

Sullivan et al.—Lodge No. 284.

This is to certify that the following members were tried and found guilty of violating the laws of the brotherhood by working on unfair work as boiler makers at Freeport and Amboy, Ill., and are subject to a fine of \$100 and suspended, and are not entitled to recognition in any way from the officers or members of this brotherhood until such judgments are satisfied:

C. J. Sullivan, Reg. No. 15676, Lodge 284; Fred J. Cremer, Reg. No. 46438, Lodge 284, age 30; William T. Powell, Reg. No. 81196, age 57, Lodge 284; J. W. Daniels, Reg. No. 15677, age 46, Lodge 284.

CHAS. PONTIUS, Pres.

E. L. MEYERS, Cor. Sec.

Chas. Boland—Lodge No. 113.

This is to certify that Charles Boland, Register No. 13921, about 45 years, of Lodge 113, was tried by that lodge and found guilty of violating the laws of the brotherhood by working on the Illinois Central while the strike was on and was fined \$250 and is not entitled to recognition in any way from the officers or members of this brotherhood until such judgments are satisfied.

CHAS. HALL, Pres.

W. H. SIMS, Cor. Sec.

This is to certify that C. W. Brice, Reg. No. 101768, of Lodge No. 587, was tried by that lodge and found guilty of violating the laws of the brotherhood by working on unfair work as helper at Houston, Texas, July 17, 1915, and is subject to a fine of \$199 and suspended for 99 years, and is not entitled to recognition in any way from the officers or members of this brotherhood until such judgments are satisfied.

R. M. TYLER, Pres.

T. C. MADDY, Sec.

OFFICIAL ROSTER--International Officers

J. A. FRANKLIN.....International President
Room 15, Law Bldg., 721 Minnesota Ave., Kansas City, Kas.

F. P. REINEMEYER.....Int. Secretary-Treasurer
Rooms 10 to 12 Law Bldg., 721 Minnesota Ave., Kansas City, Kas.

JAMES B. CASEY.....Editor-Manager of Journal
Room 9, Law Bldg., Kansas City, Kas.

A. HINZMAN.....First Int. Vice-President
Room 15, Law Bldg., 721 Minnesota Ave., Kansas City, Kas.

MISSOURI AND MISSISSIPPI SECTION.
States of Iowa, Missouri, Kansas, Nebraska, Arkansas, Mississippi, Alab. a (other than Mobile), Tennessee, North and South Dakota, Oklahoma and Minnesota.

THOS. NOLAN.....Second Int. Vice-President
700 Court St., Portsmouth, Va.

GULF AND SOUTH ATLANTIC SECTION.
States of Texas, Louisiana, Florida, Georgia, North and South Carolina, Virginia, Maryland and Delaware, and Mobile, Ala.

J. P. MERRIGAN.....Third Int. Vice-President
91 Manufacturer St., Montreal, Que., Can.
CANADIAN SECTION.
The Dominion of Canada.

LOUIS WEYAND.....Fourth Int. Vice-President
6201 Fir Avenue, N. W., Cleveland, Ohio.
GREAT LAKES AND TERRITORY SECTION.
States of Wisconsin, Michigan, Cities of Chicago, Toledo, Cleveland and Lorain, O., Erie, Pa., State of New York (other than the City of New York).

WM. ATKINSON.....Fifth Int. Vice-President
212 South Pittsburg St., Spokane, Wash.
ROCKY MOUNTAIN AND PACIFIC COAST SECTION.

Honolulu, States of California, Oregon, Washington, Idaho, Utah, Nevada, Montana, Wyoming, Colorado, Arizona, Old Mexico, New Mexico and Canal Zone, Panama.

JOHN J. DOWD.....Sixth Int. Vice-President
133 Wegman Place, Jersey City, N. J.
EASTERN SEABOARD SECTION.

States of Maine, New Hampshire, Vermont, Massachusetts, Rhode Island, Connecticut, New Jersey and New York City.

M. A. MAHER.....Seventh Int. Vice-President
3114 Eighteenth St., Portsmouth, Ohio.
OHIO VALLEY AND TERRITORY SECTION.

States of Pennsylvania (other than the city of Erie), Ohio, West Virginia, Kentucky, Indiana and Illinois (other than the City of Chicago).

JOS. P. RYAN.....Eighth Int. Vice-President
5830 Wentworth Ave., Chicago, Ill.
Phone Wentworth 8739.

HELPERS' VICE-PRESIDENT OF WESTERN SECTION.
All states west of dividing line between Indiana and Ohio.

JOHN F. SCHMITT.....Ninth Int. Vice-President
1489 N. Fourth St., Columbus, Ohio.
HELPERS' VICE-PRESIDENT OF EASTERN SECTION.

All states east of dividing line between Indiana and Ohio.

District Lodges and Officers

DISTRICT No. 2—New York.
N. Y. Meets 1st and 3rd Wed.
Patrick T. Kennealy, President, 9 Magnolia Ave., Jersey City, N. J.

Wm. Brown, Vice-Pres. Elizabeth Ave., Elizabeth, N. J.
Gerald A. Daly, Sec.-Treas., 676 60th St., Brooklyn, N. Y.

DISTRICT No. 5—St. Louis, Mo.
Mo. Pac. and Iron Mountain R. R. Lodges represented: 32, 38, 44, 66, 82, 106, 113, 117, 286, 322, 403, 507, 521, 542, 543, 565, 583 and 599.

John C. Morrow, Pres., 613 W. 4th St., Coffeyville, Kans.

Hal. Stack, Vice-Pres., Van Buren, Ark.

John J. Murphy, Secy., 3404 Eads Ave., St. Louis, Mo.

J. N. Shirley, Treas., Box 495, Holingston, Kans.

A. E. Stewart, Member Ex. Board, 2533 Myrtle Ave., Kansas City, Mo.

A. J. Radford, Member Ex. Board, 624 Oak St., Little Rock, Ark.

Chas. A. McDonald, B. A., 4416 Norledge Ave., Kansas City, Mo.

DISTRICT No. 6—Southern Pacific R.R. Lodges represented: 32, 33, 46, 48, 52, 74, 92, 49, 98, 101, 113, 179, 193, 206, 216, 223, 239, 252, 309, 345, 339, 538, 553, 169.

S. T. Peazelle, Sec.-Treas., Gate City Hotel, Pocatello, Idaho.

DISTRICT No. 10—Davenport, Ia.
Rock Island System. Lodges represented: 377, 144, 346, 199, 340, 293, 323, 434, 439, 491, 96, 32, 66, 476, 522, 523.

Geo. W. Pring, Pres. & B. A., 677 38th St., Des Moines, Ia.

John Mitchell, V.-P., 1502 McGowan St., Little Rock, Ark.

A. T. Sample, C. & F. S., 515 N. Jackson St., Pratt, Kas.

J. J. Lynch, Treas., Box 655, Her- rington, Kas.

DISTRICT No. 12—New York.
New York Central System. Lodges represented: 5, 7, 10, 64, 67, 85, 150, 157, 189, 175, 197, 218, 223, 229, 321, 413, 492.

A. M. Anderson, Pres., 2208 Francis St., Jackson, Mich.

G. H. Gates, Vice-Pres., 148 N. Orchard St., Watertown, N. Y.

J. J. Leamy, Sec.-Treas., 68 Livingston Ave., Albany, N. Y.

Trustees—Wm. Weber, E. J. McNamara and Thomas Ranger.

DISTRICT No. 13—Birmingham, Ala.
Southern R. R. System. Organized Feb. 23, 1904. Lodges represented: 2, 4, 12, 14, 40, 50, 28, 105, 143, 170, 226, 235, 312, 320, 334, 344, 369, 419, 511, 524; H. D., 27, 111, 175, 240.

Thos. J. Garvey, Pres., 414 E. Byrd St., Richmond, Va.

A. E. Barksdale, V.-P., 543 E. Lafayette St., Jackson, Tenn.

P. E. Berney, Sec.-Treas., R. F. D. 12, Knoxville, Tenn.

DISTRICT No. 15—Chicago, Ill.
C. & N. W. R. R. Lodges represented: 38, 60, 129, 145, 161, 201, 227, 311, 395, 440, 485, 496, 539, 597.

W. F. Scholes, Pres., 1929 Ave. B., Council Bluffs, Ia.

J. W. Francis, V.-P., 534 Springfield Ave., Chicago, Ill.

T. E. Burdette, Sec.-Treas., 428 North Chesnut Ave., Green Bay, Wis.

DISTRICT No. 19—Roanoke, Va.
Norfolk & Western System. Lodges represented: 28, 402, 50, 405, 557. Meets Union Labor Hall.

C. D. Craft, Pres., 1402 Center St., Portsmouth, O.

M. F. Glenn, V.-P., 1414 McConnell Ave., Portsmouth, Ohio.

J. B. O'Brien, Treas., Roanoke, Va.

E. J. Horgan, C. & F. S., 404 7th Ave., S. E., Roanoke, Va.

DISTRICT No. 20—Ill. Cent. R.
R. Headquarters, Chicago, Ill.

Lodges represented: 56, 88, 132, 137, 40, 224, 426, 180, 220, 234, 300, 315, 363, 399, 95; H. D., 97, 108, 116, 102, 230, 174, 232, 223.

K. H. Eicker, Pres., 315 Dane St., Waterloo, Ia.

W. T. McCoid, V. P., 412 Madison St., Clinton, Ill.

E. G. Pullen, C. S. & Treas., 303 Columbia St., Waterloo, Ia.

DISTRICT No. 22—D. R. G. System.
Colorado and Utah. Meeting place, Denver, Colorado; Date meeting, 2d Monday in July, 1915; Lodges represented: 44, 103, 179, 335, 427, 446, 473.

Geo. S. Warden, Pres. & B. A. 1507 E. 7th St., Pueblo, Colo.

H. F. Jones, Vice-Pres., 135 Sackett Ave., Salida, Colo.

A. A. Duncan, Sec.-Treas., Box 611, Alamosa, Colo.

DISTRICT No. 23—Meets at St. Louis, Mo.
2d Monday in October, 1914. Lodges represented: 4, 22, 27, 70, 95, 96, 180, 286, 418, 449, 458, 530, 531, 543, 546, 565, 575.

A. F. Bingham, Pres. and B. A., 701 Lombart St., Springfield, Mo.

L. W. Lawson, V.-P., 321 N. Maxey St., Sherman, Texas.

J. W. Reddick, Financial and Recording Secretary, 817 Lincoln St., Springfield, Mo.

A. A. Denton, Cor. Sec. and Treas., 1044 W. Mt. Vernon St., Springfield, Mo.

DISTRICT No. 24—Springfield, Ill.
Wabash System. Lodges represented: 54, 81, 267, 384, 581, 594.

Edward F. Siebold, Pres., 1130 St. Mary's Ave., Ft. Wayne, Ind.

Wm. F. Furrow, Vice-Pres., 1017 E. Eldorado St., Decatur, Ill.

F. R. Lee, Secy-Treas., 601 Monroe Ave., Moberly, Mo.

DISTRICT No. 25—Livingston, Mont.
Northern Pac. R. R.

J. G. Brown, Pres., 610 N. 9th St., Brainerd, Minn.

Frank Depender, V.-P., 735 E. Nora Ave., Spokane, Wash.

Theo. W. Everett, Sec.-Treas., P. O. Box 554, Livingston, Mont.

- Trustees—A. H. Shanks, 221 N. 2nd St., Missoula, Mont.; Hugh Roberts, Gen. Del., Glendive, Mont.; G. M. Owens, 312 So. E. St., Livingston, Mont.
- DISTRICT No. 24**—Aberden, S. D. C. M. & St. P. and Puget Sound R. R. Lodges represented: 11, 15, 32, 38, 41, 104, 244, 302, 485, 520, 528, 568, 588, 595, 608, 606.
- G. H. Hawksworth, Pres., Box 817, Deer Lodge, Mont.
- F. J. O'Brien, Vice-Pres., Avery, Idaho.
- Ed. McSperritt, Secy., Gen. Del., Miles City, Mont.
- P. W. Gunn, Treas., 3316-30 Ave. South, Minneapolis, Minn.
- J. L. Callahan, B. A., 3506 Clifton St., Milwaukee, Wis.
- DISTRICT No. 27**—Int. G. N. R. R. W. O. Faulk, Pres., Palestine, Tex.
- W. K. Saddler, Vice-Pres., Mart, Texas.
- E. H. Frick, Sec.-Treas., San Antonio, Tex.
- W. B. Graham, B. A., Palestine, Tex.
- DISTRICT No. 29**—Cincinnati, O. C. H. & D. R. R.
- W. J. Redmond, Pres., 204 N. Wash. St., Indianapolis, Ind.
- A. R. Griesheimer, Vice-Pres., 329 N. Elizabeth, Lima, O.
- Wm. J. McGee, Jr., Sec.-Treas., 1255 Richmond St., Cincinnati, O.
- DISTRICT No. 30**—Canadian Pacific, District Headquarters, Winnipeg, Man. Lodges in affiliation: 126, 134, 194, 379, 392, 451, 466, 478, 505, 529, 548, 417.
- Geo. F. Chadburn, Pres. and Acting Sec.-Treas., 1585 Alexander St., Winnipeg, Man.
- J. B. Smith, V.-P., 162 Annette St., Toronto, Ont.
- R. Carawell, V.-P., 684 Home St., Winnipeg, Man.
- DISTRICT No. 31**—Cincinnati, O. B. & O. System. Lodges represented: 6, 10, 79, 99, 105, 135, 241, 259, 318, 326, 332, 444, 493, 498, 514, 579, 578.
- J. C. Smith, Pres., Box 292, Garrett, Ind.
- J. R. Cline, Vice-Pres., Cleveland, O.
- M. W. Luke, Sec.-Treas., 1007 W. Main, Washington, Ind.
- DISTRICT No. 33**—Grand Rapids, Mich., Pere Marquette System. Lodges represented: 34, 124, 413.
- DISTRICT No. 34**—Boston, Mass. Boston & Maine System. Lodges represented: 245, 371, 388, 481, 515, 517. Meets at Boston, Mass., 1st Monday in August and 2d Monday in February.
- W. H. Wells, Pres., 108 Westford St., Lowell, Mass.
- P. J. Kelley, Vice-Pres., 3 Devon St., Greenfield, Mass.
- T. J. Donahue, Sec.-Treas., 5 Fernald St., Lowell, Mass.
- DISTRICT No. 35**—Parsons, Kas. M. & T. R. R. System. Lodges represented: 292, 209, 501, 576 and 265.
- Fred Alsdorf, Pres. & B. A., 515 W. Owings St., Denison, Tex.
- C. Dudding, V.-Pres., 2229 Crawford St., Parsons, Kas.
- Robt. Rosbottom, Sec.-Treas., 600 W. Texas St., Denison, Tex.
- C. A. Denton, Rec. Sec., Parsons, Kas.
- Wm. Dickerson, Chairman Trustees, 810 Cleveland St., Waco, Tex.
- DISTRICT No. 37**—Texarkana, Tex. Cotton Belt R. R. System. Meets 3d Saturdays in January and July.
- R. M. Cummins, Pres. & B. A., 308 E. Valentine St., Tyler, Tex.
- John A. Smith, V.-P., 1908 E. 8th St., Pine Bluff, Ark.
- B. E. Shields, Sec.-Treas., 1503 E. 7th Ave., Pine Bluff, Ark.
- DISTRICT No. 38**—Atlantic Coast Line. Lodges represented: 20, 26, 289, 422, 425, 448, 576.
- A. J. Dixon, Pres., Rocky Mount, N. C.
- W. A. Cahill, Vice-Pres., Montgomery, Ala.
- E. S. Ryan, Sec.-Treas., 508 Lackawanna Ave., Jacksonville, Fla.
- DISTRICT No. 39**—Central of Georgia System. Meets 1st Friday after Thanksgiving each year at Columbus, Ga. Lodges represented: 4, 12, 28, 436, 510.
- R. J. Black, Pres., 913 2nd St., Macon, Ga.
- J. J. Dean, Vice-Pres., 226 Taylor St., Savannah, Ga.
- Chas. A. Buchhell, Sec.-Treas., 103 Gordon W., Savannah, Ga.
- E. M. Kendrick, Rec. Sec., Route 5, Cedartown, Ga.
- R. S. Barry, Cor. and Fin. Sec., 1109 5th Ave., Columbus, Ga.
- DISTRICT No. 40**—Hamlet, N. C. Seaboard Airline and leased lines. Lodges represented: 20, 26, 173, 298.
- B. M. Jewell, Pres., 727 W. Monroe St., Jacksonville, Fla.
- J. F. Brice, Vice-Pres., 204 Whitehall St., Atlanta, Ga.
- E. C. Howle, Secy-Treas., 1119 E. 32nd St., Savannah, Ga.
- DISTRICT No. 41**—Hinton, W. Va. Chesapeake & Ohio System. Lodges represented: 170, 238, 249, 364, 384, 525.
- R. L. King, Pres., 822 N. Twenty-sixth St., Richmond, Va.
- L. F. Moatz, Vice-Pres., 159 W. Third St., Peru, Ind.
- C. L. Barnett, Sec.-Treas., 419 Summers St., Hinton, W. Va.
- Trustees—M. L. Steinbuck, Box 336, Clifton Forge, Va. D. C. Duddy, 2046 7th Ave., Huntington, W. Va. A. J. Poke, 1817 Scott Ave., Covington, Ky.
- DISTRICT No. 42**—Danville, Ill. Chicago & Eastern Illinois R. R. Meets 1st Tues. in Feb., 1916. Lodges represented: 22, 95, 575.
- G. D. Davis, Pres. and B. A., 18 N. Hazel St., Danville, Ill.
- James B. Keenan, V.-P., 1006 E. Madison St., Danville, Ill.
- Office Henthorn, R. & F. S., 103 Iowa St., Danville, Ill.
- A. Welch, Cor. Sec. & Treas., Villa Grove, Ill.

Subordinate Lodges and Officers

- 1—CHICAGO, ILL.** 2d-4th Wed., Bricklayers' Hall, Monroe and Peoria Sts.
James McKiernan, Pres.
John E. Burke, C. & F. S., 3009 Archer Ave.
John Dohney, 8123 So. Peoria.
Frank Condon, B. A., 912 Monroe.
- 2—ATLANTA, GA.** 2d-4th Thurs.
A. D. Lundbon, Pres., 224 E. Fair.
John Fitcher, C. S., 406 Pullian.
- 3—ST. PAUL MINN.** 1st-3d Fri., New Odd Fellows' Home, 9th and Franklin.
Geo. Cox, Pres., 1746 Logan.
Wm. Harrington, F. S., 695 Pine.
Wm. Parranto, B. A., 400 E. Jenks.
- 4—BIRMINGHAM, ALA.** 1st-3d Tues., K. of C. Hall.
Fred Baker, Pres., 2021 1/2 3d Ave.
A. L. Carmack, F. S. & B. A., Office: 335 Hood Bldg.
- 5—CLEVELAND, OHIO.** 1st-3d Thurs., Room 3, Federation Hall, 310 Prospect.
Chas. Tongreen, Pres., Superior.
G. H. Brady, C. S. & B. A., 310 Prospect.
- 7—BUFFALO, N. Y.** 2d-4th Fri., Council Hall, 33 E. Warron.
Geo. F. Muir, Pres., 116 Goodell.
Thos. J. King, C. S., 1943 Seneca.
Frank P. O'Brien, F. S., 238 Schiller.
- 8—COLUMBUS, O.** Meets 2d-4th Thurs., F. of L. Hall.
Chas. L. Nicklaus, Pres., 473 Poplar Ave.
Adam Ruckel, C. S., 267 Liebert.
- 10—INDIANAPOLIS, IND.** 2d-4th Thurs., Labor Temple, 138 W. Washington St.
- E. P. Leopard, Pres., 206 N. Tremont Ave.
Wm. Frohlinger, C. S., 542 East Louisiana St.
L. E. Hirsch, F. S., 851 Ashland Ave.
- 11—MINNEAPOLIS, MINN.** 2d-4th Mon., Richmond Hall, 223 5th St.
H. P. Farly, Pres., 1356 Vine Place.
E. A. Conlin, C. S., 2404 Bloomington Ave.
- 12—MACON, GA.** 2d-4th Friday, Morgan's Hall, cor. Elm and Broadway.
J. T. Fenlon, Pres., 1974 Third St.
- R. J. Black, C. & F. S., 913 2d.
- 14—CHATTANOOGA, TENN.** Central Labor Hall, 8th and Cherry Sts., 2d-4th Mon.
Wm. Quigley, Pres.
Jas. B. Evans, C. & F. S., 19 Jefferson.
- 15—DUBUQUE, IOWA.** 1st-3d Tues., Union Hall, 19th and White Sts.
E. Keck, Pres., 1272 Lincoln Ave.
R. Ruof, C. & F. S., 975 Clay St.
- 16—JERSEY CITY, N. J.** 1st-3d Mon., Fischer's Hall, Newark Ave., cor. Erie St.
Patrick J. Kenneally, Pres., 209 Magnolia Ave.
Hugh Fitzpatrick, C. S., 244 York.
Ed. McCarthy, B. A.
- 19—PHILADELPHIA, PA.** 2d-4th Fridays, Bricklayers' Hall, Broad and Fairmount Ave.
Frank Goodfellow, Pres., 159 W. Palmer St.
R. S. Hopkins, C. S., 2426 S. Clarion.
- 20—JACKSONVILLE, FLA.** Meets every Tuesday, Central Labor Hall, 46 1/2 W. Bay.
E. F. Ketchey, Pres., 841 W. Monroe.
E. S. Ryan, C. & F. S., 603 Park.
- 21—NEW YORK, N. Y.** 1st-3d Mon.
John H. Sullivan, Pres., 607 W. 46th St.
James McGeney, C. S., 295 Livingston St., Brooklyn, N. Y.
Thomas Smith, F. S., 692 Henry St., Brooklyn, N. Y.
- 22—DANVILLE, ILL.** 1st-3d Mon., Trades and Labor Hall.
Ray Schenk, Pres., California St.
Wm. J. Irwin, C. S., 7 Illinois.
Frank Jergens, F. S., 418 N. Bowman Ave.
G. D. Davis, B. A., 18 N. Hazel.
- 25—SAN FRANCISCO, CALIF.** Roesch Hall, 15th and Mission Sts., 2d-4th Thurs.
John Kane, Pres., 41 Collingwood.
Thos. J. Sheridan, C. S. & Treas., 2312 24th St.
Wm. P. Bower, B. A., 314 14th.
- 26—SAVANNAH, GA.** 1st-3d Tues., Whittaker St. and Liberty Lane.
E. C. Howle, Pres., 1110 E. 32d St.
R. B. Allen, C. S., 509 E. 32d St.
27—ST. LOUIS, MO. 2d-4th Thurs., 10th and Carr.
Larry Kickham, Pres. & B. A., 5322 Vernon Ave.
James Callahan, C. S., 3408 Laclede Ave.
Henry Selkman, F. S., 1908A Madison.

- 20—ROANOKE, VA.** 2d-4th Wed. Labor Home Hall, Commerce and Salem Ave.
G. J. Lucas, Pres., 1121 2d Ave. N. W.
J. R. Anderson, C. S., 502 Campbell Ave.
- 30—ROANOKE, VA.** 2d-4th Mon. Labor Hall, cor. Commerce St. and Salem Ave.
C. E. Bades, Pres., 318 7th Ave. N. E.
B. L. Wade, C. S., 311 Jamison Ave.
- 31—ST. JOSEPH, MO.** 2d-4th Mon., Jucker Hall
B. E. Stitts, Pres., 2223 So. 6th.
Edward Knight, C. S., 2119 So. 9th St.
- 32—KANSAS CITY, MO.** 2d-4th Fri., Labor Temple, 14th and Woodland.
Chas. Lackenby, Pres., 2022 Bellview.
W. E. Dwyer, C. & F. S., 115 N. Elmwood.
Chas. McDonald, B. A., 4416 Norledge.
- 37—NEW ORLEANS LA.** 2d-4th Wed., Martin's Hall, Iberville & Exchange Place.
Wm. J. Smith, Pres. & B. A., 228 Morgan St., Algiers, La.
Lewis J. Costella, C. S., 312 S. Dupre.
Victor Escausse, F. S., 617 Alir St., Algiers, La.
- 38—OMAHA, NEB.** 1st-3d Wed., Bairright Hall., 19th & Farnum.
M. J. McGovern, Pres., 1617 Burt.
L. G. Rankin, C. S., 2825 Cass.
J. H. Massman, F. C., 1511 Locust.
- 39—SOUTH CHICAGO, ILL.** 2d-4th Tues., Union Headquarters, 92d St. and Erie Ave., South Chicago.
Frank Bacton, Pres., 10222 Ave. L.
John Cogan, C. S. & B. A., 9944 Ave. H.
Joseph Manners, F. S., 10500 Ave. G.
- 40—LOUISVILLE, KY.** 2d-4th Wed., in Beck's Union Hall, 1st and Jefferson Sts.
Thomas Mitchell, Pres., 1422A Broadway.
R. Terrell, C. S., 308 N. 19th St.
F. J. Kiesler, F. S., 212 Collins Court.
- 41—HARLOWTON, MONT.** 2d-4th Thurs., Winer Hall.
John Dennis, Pres.
Verne Scott, C. S., Box 550.
- 42—NASHVILLE, TENN.** 2d-4th Thurs., Carpenters' Hall, 342½ 4th Ave. N.
James B. Keenan, 1006 E. Madison St., Danville, Ill.
H. R. Brown, Pres., 611½ Church.
W. T. Pentecost, C. S., 2143 Oakland Ave.
- 44—PUEBLO, COL.** Every Thurs., New Pope Bk., Main bet. 3d and 4th Sts.
Walter M. Pitts, Pres., 631 E. 5th St.
Geo. S. Warden, C. & F. S., 1507 E. 7th St.
- 45—BROOKLYN, N. Y.** Greenpoint and Manhattan Aves., 2d-4th Thurs.
Gerald A. Daly, Pres. & C. S., 676 60th St.
M. J. Callahan, F. S., 19 Jewell St.
- 46—CHEYENNE, WYO.** Union Hall, 2d-4th Wed.
Geo. R. Wallace, Pres., P. O. Box 151.
W. Cole, C. S., 215 E. 9th St.
- 47—DES MOINES, IA.** 1st-3d Thurs., Trades Assembly Hall.
James Gillespie, Pres., 1113 Columbus Ave.
Fritz Johnson, C. & F. S., 922 W. 1st St.
- 48—LARAMIE, WYO.** 1st - 3d Tues., Moose Hall.
Jacob Claus, Pres., 114 Cedar St.
Frank M. Lepper, C. S., 360 N. 3d St.
- 50—CHARLESTON, S. C.** 1st-3d Tues., Y. M. C. A. Hall, George St.
H. J. Hartnett, Pres., 12 Anson St.
John J. Clair, C. & F. S., 196A Spring St.
- 54—FORT WAYNE, IND.** Last Wed., West Berry St.
Edward F. Siebold, Pres. & C. S., 1130 St. Mary's Ave.
O. F. Ewald, F. S., 1419 S. Calhoun.
- 55—NEWPORT NEWS, VA.** Every Wed., 8 p. m., C. L. U. Hall, 32d and Wash. Ave.
Wm. H. Healy, Pres., 3711 Huntington Ave.
D. McArthur, C. S., 211 37th.
W. Hannah, F. S., P. O. Box 430.
- 57—PORTSMOUTH, VA.** 1st-3d Thurs., C. L. U. Hall.
O. C. Hartung, Pres., 1248 Park Ave.
J. H. Parrish, F. S., 622 Clifford.
Geo. Thomas, C. S., 204 Lincoln.
- 60—PEORIA, ILL.** 1st-3d Mon., 411 Cedar St.
E. L. Thornton, Pres., 213 Faraday.
F. Hierspiel, C. S., 410 Warner Ave.
- 61—NEW HAVEN, CONN.** 1st-3d Thurs., Boardman Bldg., cor. State and Chapel Sts.
Wm. Hefferman, Pres., 95 Carlyle.
M. J. Whalen, C. & F. S., 138 Carlyle.
- 64—JACKSON, MICH.** Every Tues., Labor Hall, Main and Jackson Sts.
Geo. Bones, Pres., 140 Bates.
Ed McNamara, C. S., 619 South Pleasant St.
- 65—VICTORIA, VA.** 2d-4th Sundays, Lunenburg Hall.
J. H. Jones, Pres., Gen. Del.
W. H. Slayton, C. S., Gen. Del.
- 66—LITTLE ROCK, ARK.** 1st-3d Thurs., Brannon Hall., Markham and Cross Sts.
E. J. Flynn, Pres., 908 Denison.
E. Wortsmitth, C. & F. S., 300 W. 11th St., Argenta, Ark.
C. A. McDonald, B. A., 4416 Norledge, Kansas City, Mo.
- 67—BAY CITY, MICH.** 1st-3d Thurs., Central Trades Council Hall.
Wm. H. Benedict, Pres., 703 E. Winona Ave., W. S.
Joe Malton, V.-P., 817 S. Jackson.
Nelson Heglung, C. & F. S., 514 Adams St.
- 68—PINE BLUFF, ARK.**—2d-4th Wed., Labor Temple.
A. J. Barton, Pres., 1701 W. 6th.
B. E. Shields, C. S., 622 Nebraska.
J. A. Smith, F. S., 1908 E. 8th.
- 69—LITTLE ROCK, ARK.**
John Mitchell, Pres., 1502 McGowan St.
W. A. Rookshery, C. & F. S., 1205 W. 34th St.
- 70—SPRINGFIELD, MO.** 2d-4th Wed., Eagles' Home.
A. E. Welch, Pres., 1822 Roberson Ave.
Scott Daffer, C. & F. S., 1235 Broad St.
A. F. Bingham, B. A., 701 Lombard St.
- 72—PORTLAND, ORE.** 2d-4th Thurs., 230½ Yamhill St.
Arthur Gallon, Pres., 649 Milwaukee.
F. E. Disbrow, C. & F. S., 810 E. 11th.
Joe Reed, B. A., 507 Blsmark.
- 73—TROY, N. Y.** 2d-4th Mon., Swan and Georgia Sts., Mechanics' Hall.
- Huntington Ave.
John Donnelly, Pres., 23 3d St., Cohoes, N. Y.
David Boyd, C. & F. S., 319 9th St., Waterlot, N. Y.
- 74—HOUSTON, TEXAS.** 1st-3d Wed., Woodman Hall, 1833 Washington St.
D. C. Bryan, Pres., 4607 Washington.
F. C. Jackson, C. & F. S., 2119 Lublick St.
- 79—GARETTT, IND.** 1st-3d Tues., K. of P. Hall, Randolph.
Geo. Richmond, Pres., 214 E. Keyser.
J. C. Smith, C. & F. S., Box 332.
- 80—ANACONDA, MONT.** 2d-4th Wed., M. & M. Hall, Lodge Box 372.
J. C. Smith, Pres., 510 Cherry St.
James W. Hogan, C. S., 800 Birch.
- 81—SPRINGFIELD, ILL.** 2d-4th Tues., Fortunes Hall.
Ed Sellers, Pres., 130 E. Edwards.
Louis L. Mutter, C. & F. S., 1621 S. 8th.
- 82—OSAWATOMIE, KAS.** 1st-3d Mon., K. & L. Sec. Hall.
Hurb Fader, Pres.
J. E. Sturges, C. & F. S., Box 64.
C. A. McDonald, B. A., 4416 Norledge, Kansas City, Mo.
- 83—KANSAS CITY, KAS.** 2d-4th Tues., K. P. Hall, 624 Minn. Av.
Thomas Knowles, Pres., 760 Shawnee.
Frank Stover, C. & F. S., 322 Nebraska Ave.
- 84—GRAND RAPIDS, MICH.** 1st-2d Mon., Trade & Labor Hall, 67 Monroe Ave.
Frank C. Lemke, Pres., 551 Shamrock St.
Nelson M. Warren, C. S., 127 E. Delaware St.
- 85—TOLEDO, OHIO.** 2d-4th Tues., Mitchell's Hall, cor. Walnut and Summit Sts.
J. E. Durst, Pres., 153 Gibbons St.
Ellsworth Richardson, C. S., 137 Western St.
- 86—DALLAS, TEX.** 1st-3d Mon., Broadnax Hall.
W. H. Riley, Pres., 1408 Corinth.
C. B. Stout, C. S., R. R. 10, Box 64.
- 88—JACKSON TENN.** 2d-4th Fri., Labor Hall.
B. B. Seward, Pres.
A. E. Barkdale, C. S., 119 E. Orleans St.
- 90—SUGAR CREEK, MO.** 2d-4th Thurs., Woodman's Hall.
L. Novak, Pres.
C. R. Snider, C. & F. S., 1223 W. Electric St., Independence, Mo.
- 91—ELMWOOD PLACE O.** 1st-3d Mon., Kellers Hall.
Geo. Urban, Pres., St. Bernard, O.
John Cullen, C. S., 39 Prosser Ave.
- 92—LOS ANGELES, CAL.** 2d-4th Wed., Union Labor Temple, 540 Maple Ave.
Wm. Gardiner, Pres., 2207½ E. 2nd.
H. E. Herman, C. & F. S., 530 S. Griffin Ave.
- 93—JOLIET, ILL.** 2d-4th Tues., Conner's Hall.
John Buckley, Pres., 111 Willard Ave.
Richard Farrell, F. S., 503 London Ave.
Charles Mork, C. S., 424 Landen Ave.
- 94—SACRAMENTO, CAL.** 1st-3d Thurs., Labor Temple.
J. Grabfelder, Pres., 3091 G St.
J. S. Heller, Acting C. S., 1317 19th St.
- 95—EVANSVILLE, IND.** 2d-4th Mon., Ruhl's Hall.
Chas. T. Mooney, Pres., 1802 Michigan.
Herman H. Grundman, C. & F. S., 307 Mary St.

- 96—FORT WORTH, TEX.** R. of L. F. & E. Hall, 1st-3d Thurs. J. A. Dempsey, Pres., 504 Calhoun. L. A. Freeman, C. & F. S., 2250 Jennings St.
- 99—NEWARK, OHIO.** Druid's Hall, 22½ S. 3d St., 1st-3d Sun., 9 a. m. Emil Indekofer, Pres., 76 Curtis Ave. Cecil Roberts, C. & F. S., 45½ S. Third St.
- 100—MARSHALL, TEX.** 1st-3d Tues., I. O. O. F. Hall. Smith Hayden, Pres., 514 Greenwood Ave. J. P. O'Neil, C. & F. S., 703 E. Rusk.
- 103—SALT LAKE CITY, UTAH.** Labor Temple, 3d East, bet. 1st and 2d S. St., 1st-3d Wed. Wm. H. Garrick, Pres., 416 Edith Ave. B. S. R. Harrison, C. & F. S., 883 Ouray Ave.
- 104—SEATTLE, WASH.** 1st-3d Thurs., Labor Temple, 6th and University St. Fred Counter, Pres., 2260 15th Ave., So. Dan McKillop, Sec. & B. A., 166½ 10th Ave., Phone Elliott 845W.
- 105—CINCINNATI, OHIO.** 2d-4th Thurs., Workman's Hall, Mercer and Walnut Sts. Chas. Granger, Pres., 329 Union St., Bellevue, Ky. D. L. O'Brien, C. S. & B. A., 28 Forest Ave., Ludlow, Ky. Frank Bareswilt, F. S., 1023 5th Ave., Dayton, Ky.
- 106—MCGHEE, ARK.** 2d-4th Wed., K. of P. Hall. Wm. E. Crupper, Pres., Box 215. Chas. A. Stewart, C. & F. S., Box 422.
- 107—MILWAUKEE, WIS.** 1st-3d Tues., Speers Hall, Cor. National & 3d Ave. J. Hoppens, Pres., 1302 Fraternity. R. Dale, Fin. Sec., 319 4th Ave. P. Sonnenberg, C. S. & B. A., 623 Greenbush.
- 108—AUGUSTA, GA.** 2d-4th Tues., Machinists' Hall, Broad. Patrick Rice, Pres., 1342 Walton Way. E. E. Bennett, C. S., 1406 Silcox.
- 109—CHADRON, NEB.** J. W. Boyd, Pres. Ed Grady, C. S., Gen. Del.
- 111—MISSOULA, MONT.** 2d-4th Tues., Eagles' Hall. H. A. Chase, Pres., Box 1304. A. Frasier, C. S., R. No. 1.
- 112—SEDALIA, MO.** 1st-3d Tues., Labor Temple. Chas. Hall, Pres., Gen. Del. C. A. McDonald, B. A., 4416 Norledge, Kansas City, Mo. W. H. Sims, C. S., 1306 E. 7th St.
- 116—BRAINERD, MINN.** 2d-4th Fri., Trades and Labor Hall. Henry Voight, Pres., E. Oak. Wm. B. Good, C. S., Imperial Block.
- 117—DE SOTO, MO.** 1st-3d Mon., Federation Hall. R. E. Parks, Pres. S. L. Johnson, C. & F. S., Box 248.
- 123—LIVINGSTON, MONT.** 1st-3d Thurs., Trades and Labor Hall. C. D. Cain, Pres., 204 S. K St. Theo. W. Evert, C. & F. S., P. O. Box 554.
- 124—SAGINAW, MICH.** 1st-3d Fri., Petre & Meek's Hall, Genesee Ave. John Doyle, C. & F. S., R. F. D. No. 1.
- 126—WINNIPEG, MAN.** 1st Wed. and 3d Sun., 2:30 o'clock, Labor Temple. Wm. L. Hall, Pres., 1576 Elgin Ave. L. M. Couttle, C. S., 1497 Pacific Ave. A. Cook, F. S., 1233 Silkkirk Ave.
- 129—CLINTON, IOWA.** 4th Fri., Labor Temple, 214 15th Ave. Henry L. Weber, Pres., 503 Elm. Henry Qualman, C. & F. S., 231 14th Ave.
- 130—BUTTE, MONT.** 1st-3d Tues., Carpenters' Hall, cor. Granite and Montana Sts. T. F. Shulta, Pres. Harry Goodland, C. & F. S., 177 E. Center.
- 132—GALVESTON, TEX.** 2d Mon., Cooks and Waiters' Hall, 23d St. S. Nawdascher, Pres., 2222 Ave. H. El. T. Chester, C. & F. S., 2209 Ave. L.
- 133—WATERLOO, IOWA.** Central Labor Hall, 2d-4th Wed. E. G. Pullen, Pres., 502 Columbia St. Geo. A. McMillan, C. S., 702 Barclay St.
- 134—MONTREAL, QUE., CAN.** 1st-3d Fri., Monument National, St. Lawrence and Main Sts. Stephen Craig, Pres., 1251 Mossier. R. Chorlton, C. S., 1124 Delormier Ave.
- 135—CHILLICOTHE, O.** 1st-3d Mon., Flascoer Hall. L. J. Medert, Pres., 516 E. Water. Harry Rittinger, F. C. S., 339 S. Watt.
- 136—COLORADO CITY, COLO.** Red Men's Hall, 1st-3d Fri. H. J. Norton, Pres., care National Hotel. R. D. Wing, C. S., 12 So. 12th, Colorado Springs, Colo. J. H. Cook, F. S., 216 N. 10th.
- 137—PADUCAH, KY.** 2d-4th Sun., Central Labor Hall, 122½ N. 4th. B. C. Beadles, Pres., 1029 Madison. Wm. Black, C. & F. S., 2040 Broad St.
- 138—HARRISON, ARK.** 4th Thurs. H. C. Heppard, Pres. John G. Call, C. & F. S.
- 142—KNOXVILLE, TENN.** 219 N. Gay St., 1st-3d Tues. J. D. Krause, Pres., R. F. D. No. 1. Joe Galloway, C. S., 1000 Broadway. W. D. Amanna, F. S., R. F. D. No. 12, Lincoln Park.
- 144—CEDAR RAPIDS, IOWA.** 1st-3d Wed., I. O. O. F. Hall, cor. 1st St. and 2nd Ave. W. Chas. T. Bowman, Pres., 816 Ellis Blvd. Frank C. Schwarz, C. & F. S., 830 G Ave., W.
- 145—MISSOURI VALLEY, IOWA.** 1st-3d Thurs., Walker's Hall. Hans Witt, Pres., Box 181. Harvey Nichols, C. S.
- 146—VALLEJO, CALIF.** 1st-3d Tues., Vallejo Temple Hall. Wm. Fountain, Pres., 225A Penn. Harry Duthie, C. & F. S., 638 Capitol.
- 149—MARSHALLTOWN, IOWA.** 1st-3d Tues., Trades and Labor Assembly Hall, Main St. Chas. Vyskocjal, Pres., 9 E. Boone. W. E. Pouley, C. S., 1110 W. Cole.
- 150—CHAMPAIGN, ILL.** 1st-3d Sun., 2:30 p. m., I. C. System Fed. Hall. Thos. H. Monahan, Pres., 511 W. Washington St. A. E. Strode, C. S., 325 Hickory.
- 153—GASSAWAY, W. VA.** 20th of each month, Boone's Hall. J. E. Perkins, Pres., Little Otter, W. Va. C. S. Davis, C. & F. S., Gen. Del.
- 154—PITTSBURGH, PA.** 1st-3d Fri., Labor Temple, cor. Washington and Webster Ave. Frank Bann, Pres., 804 South Ave. N. S. Henry J. Thumel, C. & F. S., 1213 Itin St. N. S. James F. Carr, B. A., Labor Temple, Wash. and Webster Ave.
- 155—BLOOMINGTON, ILL.** 1st-3d Mon., Redmen's Hall, Main and Front Sts. H. F. Lambrecht, Pres., 1004 N. Livingston St. L. J. Metzner, C. & F. S., 1207 N. Mason.
- 161—BOONE, IOWA.** 1st-3d Mon., at Electrical Workers' Hall. Frank Whitman, Pres., 1603 Benton. H. W. Martens, C. & F. S., 1329 Meridian St.
- 162—HOBOKEN, N. J.** 2d-4th Fri., 500 Bloomfield St. Jeremiah Cahill, Pres., 38 Troy. P. L. Growney, C. S., 1019 Winslow Ave.
- 165—DULUTH, MINN.** 2d-4th Sat., Irwin-Sloan Block, 20th Ave. and Superior St. James A. Graham, Pres., 5705 Grand Ave., W. Duluth, Minn. Alfred S. Nelson, C. & F. S., 5705 Grand Ave., W. Duluth, Minn.
- 169—DETROIT, MICH.** 2d-4th Thurs., 272 Gratiot Ave. Charles Komes, Pres., 21 Celaren. Chas. F. Adarholdt, C. & F. S., 2 Syiven St.
- 170—RICHMOND, VA.** 1st-3d Wed., Labor Temple, 5th and Marshall Sts. R. M. King, Pres., 822 N. 26th St. F. C. Blount, F. S., 1101 N. 23d. E. M. Daywalt, C. S., 2208 Venable St.
- 172—RALEIGH, N. C.** B. F. Long, Pres., 218 N. McDowell. J. P. Taylor, C. & F. S., 615 W. North.
- 176—ELIZABETH, N. J.** 2d-4th Wed., Dahmen Hall, 4th and E. Jersey St. John H. Reynolds, Pres., 33 Delaware St. Samuel M. Rankin, Secy., 64 Florida. E. J. McCarthy, B. A., 67 St. Mark's Place, New York City.
- 179—DENVER, COLO.** 2d-4th Wed., Room 301 McPhee Bldg., 17th and Glenarm. Geo. Gauss, Pres., 3869 Newton. H. Shaffroth, C. & F. S., 3749 Wynkoop St.
- 180—MEMPHIS, TENN.** Italian Hall, 1st-3d Fri. E. C. Poore, Pres., 735 Arkansas Ave. Edward O'Brien, C. & F. S., 1226 S. Orleans St.
- 187—MIAMI, ARIZ.** Every Tues., Miami Hall. J. W. Landers, Pres. Frank E. Rock, C. & F. S., Box 1121.
- 191—VICTORIA, B. C.** 2d-4th Tues., 1424 Government St. A. Clyde, Pres. Sub. P. O. No. 2. A. Stewart, C. S., Box 48, Beaumont, P. O. Esquimalt, B. C.
- 192—BALTIMORE, MD.** Every Tues., Patterson Bldg., Baltimore and Gay Sts. John Shanley, Pres. James Chaney, F. S., 1419 Patapsica St. Phillip Yingling, C. S., 410 E. 27th St.

- 194—VANCOUVER, B. C. CANADA—1st-3d Mon., at Labor Temple.
A. Campbell, Pres., 17th Ave., West Vancouver.
- 195—KEWANEE, ILL. 1st-3d Fri., O'Donnell's Hall, 3d St.
A. M. Powers, C. S., 614 Beach.
- 197—ALBANY, N. Y. 31 Green St., 2d-4th Sat.
J. H. Sullivan, Pres. & B. A., 173 2d St.
Jno. J. Leamy, C. S., 68 Livingston Ave.
- 198—OGDEN, UTAH. 2d-3d Tues., Union Labor Hall on 24th St., bet. Washington and Grant.
F. S. Dunn, C. & F. S., 116 23d St.
- 199—HORTON, KAN. 2d-4th Mon., Carmen's Hall.
E. J. McCarty, Pres.
E. S. McGinnis, C. & F. S., Box 622.
- 200—STATEN ISLAND, N. Y. I. O. G. T. Hall, W. Brighton, S. I., N. Y., 3rd Mon.
Robt. Duthie, Pres., 74 Simonson Ave., Ft. Richmond, S. I., N. Y.
Ethan A. Johnson, C. S., 208 Broadway, W. Brighton S. I., N. Y.
E. McCarty, B. A., 67 St. Mark's Place, N. Y. City.
- 201—WINONA, MINN. Labor Temple, 1st-3d Tues.
Frank Rice, Pres., 574 W. 7th St.
W. Kukowski, C. S., 176 Mankato Ave.
J. H. Buchholtz, F. S., 251 E. King.
- 204—HONOLULU, H. I. Waverly Hall, 2d-4th Thurs.
Frank Esman, Pres., Majestic Hotel.
Wm. H. Lane, C. & F. S., 900C Kanoa Lane.
- 205—SAN FRANCISCO, CALIF. 2d-4th Tues., Rosch Hall, 15th and Mission.
Wm. P. Bowser, Pres., 507 20th.
J. M. Enright, C. S., 1431 Delores.
Walter Anderson, F. S., 607 Andover.
Wm. P. Bowser, B. A., 314 14th.
- 208—ALGIERS, LA. 2d-4th Fri., RENECKY Hall.
Jos. Koenig, Pres. & C. S., 825 Elmira Ave.
C. A. Reynolds, F. S., McDonoughville, La.
- 207—WALNUT SPRINGS, TEX. E. P. Jones, Pres.
C. W. Leigen, C. & F. S.
- 209—DENISON, TEXAS. 2d-4th Mon., over State Nat. Bank.
A. McDowell, Pres., 504 W. Owings St.
S. E. Harris, C. & F. S., 923 W. Morgan St.
- 216—EL PASO, TEXAS. 2d-4th Thurs., 215 S. Stanton.
Wm. Beeson, Pres., 307 N. El Paso.
Frank H. Bait, C. S., 215 S. Stanton St.
- 220—CHICAGO, ILL. 2d-4th Tues., Pusey's Hall, 301 E. 75th.
M. Casey, Pres., 6351 Drexel Ave.
A. G. Smith, C. & F. S., 7036 Harper Ave.
- 221—PITTSBURG, KAN. 1st-3d Tues., Red Men's Hall, W. 3d St.
E. E. Hiett, Pres., 1803 N. Grand Ave.
P. J. Hiett, C. S., 1801 N. Grand.
- 222—MART, TEXAS. W. O. W. Hall.
E. J. Blount, Pres.
G. W. Coates, C. & F. S.
- 223—UTICA, N. Y. Labor Temple, 2d Fri.
Louis Wengert, Pres., 8 Wiley St.
Edward Wengert, C. S., 43 Fass Ave.
- 225—ELMIRA, N. Y. 2d-4th Sun., Trades & Labor Hall, 200 E. Water St.
A. E. Stevenson, Pres., 964 McGee.
N. P. Durnin, R. & C. S., 519 Penn Ave.
- 226—SALISBURY, N. C. W. O. W. Hall, Innes and Main Sts., 2d-4th Fri.
J. J. Garvey, Pres., E. Spencer, N. C.
P. P. Surratt, C. & F. S., Box 278, Spencer, N. C.
- 227—CHICAGO, ILL. Garfield Park Hall, 4039 W. Madison St., 2d-4th Sat.
John Seldon, Pres., 1107 Keeler Ave.
Thomas Dean, F. & C. S., 2214 W. 13th St.
- 229—ROCHESTER, N. Y. 2d-4th Wed., 14 N. Water St.
W. Weston, Pres., 17 Coffrey Place.
Robt. Little, C. S., 211 Garfield.
- 233—OAKLAND, CAL. 2d-4th Mon., cor. 7th and Peralta Sts.
H. Brown, Pres., 1003 Pine St.
Geo. Young, C. S., 1788 9th St.
- 235—COLUMBIA, S. C. 2d-4th Tues., Plumbers' Hall, 1623 Main St.
J. M. Fricks, Pres., 3403 College St., Colonial Hts.
J. W. Bankhead, C. & F. S., 1727 Laurel Ave.
- 236—MARQUETTE, MICH. 4th Thurs., E. Seigle's Hall.
Albert Bastien, Pres., 347 West Washington.
Arthur Bourgois, C. S., 817 North 3d St.
- 237—HARTFORD, CONN. 2d-4th Wed., at C. L. U. Hall, Central Row.
James Thornton, Pres., 52 Green.
John J. Reilly, C. S., 46 Pliny.
- 238—CLIFTON FORGE, VA. 1st-3d Fri., Junior Hall.
A. J. Hauer, Pres., 34 Alleghany.
M. L. Steinbuck, C. & R. S., Box 336.
D. G. Clark, F. S., 192 Ridge-way.
- 239—ROCKY MOUNT, N. C. 1st-3d Mon., Machinist Hall, cor. Sunset and Main Sts.
G. T. Mathews, Jr., Pres., 620 S. Church.J. S. Wakefield, C. S., Box 224.
H. L. Moore, F. S., 127 Pearl.
- 241—WASHINGTON, IND. Zinkin's Hall, 3d and Vantreese Sts., 1st-3d Tues.
J. C. Mooney, Pres., East George.
M. W. Luke, C. & F. S., 1007 W. Main.
- 242—SPOKANE, WASH. 2d-4th Wed., Carpenters' Hall, No. 9 Madison St.
Frank Depender, Pres., 611 E. Indiana Ave.
R. L. Mason, C. S., 212 S. Pittsburg St.
- 243—BELLEFONTAINE, O. Last Sunday in each month, Eagles' Hall.
H. S. Dickenson, Pres., 329 Garfield.
R. E. McNeff, C. & F. S., 105 N. Elm.
- 244—SIOUX CITY, IOWA. 3d Wed., Motor Mart Bldg.
John Ewing, Pres., 103 Alice St.
Robt. O'Hern, C. S., No. 5 14th.
- 245—CONCORD, N. H. 2d-4th Mon., Central Labor Union Hall.
Geo. Tanner, Pres., Hall St.
J. J. Berryman, C. S., 2 Home Ave.
J. R. New, F. S., 120 Broadway.
- 246—TERRE HAUTE, IND. Cor. 8th and Wabash Ave., 1st-3d Tues.
H. M. Showalter, Pres., 1410 S. 17th.
Jesse Dukes, C. S., 1561 S. 18th.
F. Wittke, F. S., 1709 N. 12th.
- 247—TACOMA, WASH. 1st-3d Mon., Odd Fellows' Hall, S. Tacoma.
Andrew Hansen, Pres., 5406 So. Faks St.
Wm. Polsin, C. & F. S., 5814 S. Lawrence St., So. Tacoma, Wash.
- 249—HUNTINGTON, W. VA. Every Wed., Thompson Bldg., cor. 20th St. and 3d Ave.
J. S. Myers, Pres., 2720 Collis Ave.
Eugene Brennan, C. & F. S., 322 23d St.
A. B. Pring, B. A., 1812 12th Ave.
- 250—BOSTON, MASS. Hollis Hall, 724 Washington St., 1st-3d Fri.
James Downey, Pres., 8 Cathedral.
Jeremiah Murphy, C. S. & B. A., 107 Union Park St.
J. F. Neas, F. S., 1177A Tremont, Roxbury, Mass.
- 254—CHICAGO HEIGHTS, ILL. 1st-3d Mon. at Trades & Labor Assembly Hall, West End Ave.
Thomas Hines, Pres., 1656 West End Ave.
Thomas Brooks, C. & F. S., 306 W. 15th Place.
- 259—LIMA, OHIO. 2d-4th Thurs., 334 No. Main.
A. C. Thompson, Pres., East Finley.
A. K. Griesheimer, C. S., 329 N. Elizabeth.
Harry Gunn, F. S., 713 W. Metcalfe.
- 265—SMITHVILLE, TEXAS. 1st-4th Mon.
M. C. Vaughn, Pres., P. O. Box 521.
Guy Cooper, C. & F. S., P. O. Box 356.
- 267—MOBERLY, MO. 2nd and 4th Thurs., Painters' Hall.
J. J. Cadagin, Pres.
F. R. Lee, C. S., 601 Monroe Ave.
- 276—ST. LOUIS, MO. 2d-4th Fri., N. E. Cor. 11th and Locust.
Herbert Abbey, Pres., 2618 Ann Av.
Henry Waeckerle, C. S., 2919A Miami.
Clyde Stevens, F. S., 1914 N. 21st.
E. St. Louis, Ill.
- 278—ELKINS, W. VA. 3d-4th Thurs., Kendall Hall.
Geo. Cade, Pres., 620 Yokem.
C. H. Goodwin, C. & F. S., 3 Center St.
- 279—EDMONTON, ALB. CAN. 1st Mon., Calder, Edmonton.
Wm. J. Fitzmaurice, Pres., Box 2100, of E. D. & E. C. Ry.
Jesse McLean, C. & F. S., 10236 113th St.
- 281—NORWOOD, MASS. 2d-4th Fri., 724 Washington St., Boston.
Amos Bennett, Pres., 135 Appleton St., Boston, Mass.
Robert Henderson, C. S., 274 Metropolitan Ave., Roslindale, Mass.
- 284—FREEPORT, ILL. 1st Sun., at Blunt Hall.
C. J. Pontius, Pres., 26 Park Ave.
Earl Barth, Secy-Treas., 1334 20th Ave., Rockford, Ill.
- 286—FORT SCOTT, KAN. 1st-3d Mon., Redmen's Hall, 111 E. Wall St.
J. W. McNowen, Pres., 816 Marion Ave.
J. C. Bonesteel, C. S., 1213 So. National.
- 287—KINGSVILLE, TEXAS. M. H. Nicholson, Pres., Gen. Del. E. C. Martin, C. S., Box 162.
- 290—BREMERTON, WASH. 3d Tues., Hunter & Dally Bldg., Pacific Ave.
Percey Counter, Pres., Box 272, Charleston, Wash.
John Hornby, C. & F. S., Gen. Del.
- 292—PARSONS, KAN. 2d-4th Tues., Moose Hall.
C. Dudding, Pres., 2229 Crawford St.
E. F. Butler, C. S., 1723 Gabriel.
- 293—SHAWNEE, OKLA. 2d-4th Mon., Moose Hall.
Floyd Ott, Pres., 602 University Ave.
A. D. Ross, C. & F. S., 429 N. Park Ave.

- 298—PORTSMOUTH, VA.** C. L. U. Hall, 2d-4th Thur.
M. A. Garriss, Pres., 2226 King.
H. W. Jarrett, F. S., 1822 County.
Robt. T. Howe, C. S., 826 4th St.
- 300—WATER VALLEY, MISS. I.**
O. O. F. Hall, 1st-3d Thur.
C. H. Baker, Pres. and Treas.
- 301—CANTON, OHIO, 1st-3d**
Mon., Switzer Hall, Cherry and 8th Sts.
Joe Petch, Pres., 1119 5th St.
N. E.
E. J. Gussett, C. & F. S., 1202 McKinley Ave. S. W.
- 302—MILWAUKEE, WIS. 1st-3d**
Sat., Lipp's Hall, 3d and Prairie.
Henry J. Murray, Pres., 113 29th
Hugh J. Fuller, C. S., 406 30th St.
John DuBrucq, F. S., 217½ 4th Ave.
John L. Callahan, B. A., 3606 Clifton Ave.
- 305—PORT ARTHUR, TEXAS.**
2d-4th Tues., Labor Hall.
C. L. Bragg, Pres., Gen. Del.
T. O. Riley, C. S. & B. A., Box 683.
James Rose, F. S., Box 8.
- 309—EVANSTON, WYO. I. O.**
O. F. Hall, 1st-3d Wed.
John T. Whitfle, Pres., County Road.
J. H. Willoughby, C. S., Box 419.
- 311—SOUTH KAUKAUNA, WIS.**
2d-4th Mon., Odd Fellows' Hall.
Louis Crevier, Pres.
Chas. Robedeau, C. & R. S., P. O. Box 279.
- 312—SELMA, ALA. 1st-3d Wed.**
at R. R. Y. M. C. A.
J. F. Ryals, Pres.
W. P. Fawcett, C. S., 1509 Selma.
- 315—McCOMB, MISS.** Central Trade and Labor Hall, 1st-3d Wed. at 7:30.
R. O. Bean, Pres. & C. S., Box 684.
- 317—RICHMOND, CALIF. 2d-4th**
Fri., Barnman's Hall, 19th St.
Frank Mallinson, Pres., care Randall Hotel.
Wm. Jones, C. & F. S., Box 634.
- 318—PITTSBURGH, PA. 1st-3d**
Mon., Hazlewood Bank Bldg., cor. 2d and Hazlewood.
W. Mertz, Pres., Path Alley.
T. A. Hudson, F. S., 310 Johnston Ave.
- 320—MERIDAN, MISS. B. L. E.**
Hall, 5th St. and 40th Ave., 1st-3d Thurs.
J. A. Smitheren, Pres., 511 40th Ave.
J. E. Alexander, C. & F. S., 3817 35th St.
- 322—ST. LOUIS, MO. 1st-3d**
Tues., Reddy Hall, 3100 Chau-tau
John Coots, Pres., 2726 Wash-ington Ave.
W. J. Tinell, C. S., 812 Atlantic, Webster Grove, Mo.
- 323—CHICKASHA, OKLA. 2d-4th**
Fri., Labor Hall, 4th and Choctaw.
C. A. Chincholl, Pres., P. O. Box 502.
W. L. Harkins, C. & F. S., 523 S. 15th.
- 325—SHEVEPORT, LA. K. of**
P. Hall, over West End Drug Store, 2d-4th Thurs.
H. Abbott, Pres., 1542 Luchina Ave.
H. W. Huff, C. S., 1863 Texas Av.
- 332—CUMBERLAND, MD. 1st-3d**
Mon., Odd Fellows' Hall.
C. C. Bowen, Pres., 107 W. 1st.
Geo. H. Little, C. S., 401 E. 1st.
J. R. Beck, F. S., 106 W. 1st.
- 334—PRINCETON, IND. 2d-4th**
Tues., Redmen's Hall.
Joe Myers, Pres., 1101 S. Race.
J. E. Clark, C. & F. S., 702 S. Prince.
- 335—GRAND JUNCTION, COLO.**
2d-4th Fri., Eagles' Hall.
G. R. Stoll, Pres., 337 White.
E. H. Friend, C. & F. S., 308 Pitkin Ave.
- 339—SPARKS, NEV. 2d-4th**
Wed., Engineers' Hall.
Wm. Daseler, Pres., P. O. Box 214.
C. E. Crouch, C. S., P. O. Box 204.
- 340—HERINGTON, KAS. 1st-3d**
Sat., I. O. O. F. Hall.
John Olson, Pres.
J. E. Anderson, C. S., 303 N. 8th.
- 341—PHILADELPHIA, PA. 2d-4th**
Tues., 8 p. m., Labor Head-quarters, 322 N. 9th St.
Wm. J. Boyle, Pres., 208 N. 58th St.
Chas. Heberly, C. S., 3084 Aramingo Ave.
- 344—SHEFFIELD, ALA. 1st-3d**
Wed. at I. O. O. F. Hall, Mont-gomery Ave.
W. H. Wilson, Pres., Tuscumbia, Ala.
E. T. Holland, C. S., Box 65.
- 345—SAN ANTONIO, TEXAS.**
Trades Council Hall, 2d-4th Thurs.
F. E. Hamilton, Pres., 2103 W. Travis.
E. H. Frick, C. & F. S., 1222 W. Delrympel, B. A., 410 River Ave.
- 346—TRENTON, MO. 1st-3d**
Tues., at Cutlip's Hall.
Walter Mason, Pres., 1726 Lula Ave.
Geo. W. Singer, C. & F. S., 1801 Maine St.
- 354—BROOKFIELD, MO. 1st-3d**
Tues., 212 N. Main St.
Martin Murphy, Pres., 291 Elm St.
J. K. Burnham, C. S., 529 S. Liv-ing
- 355—CONNBAUT, OHIO. 2d-4th**
Fri., Stationary Eng. Hall, Main St.
Chas. Ward, Pres., 685 Lakeview Ave.
J. M. Irish, C. S., 530 Sherman.
E. J. Dickson, F. S., 815 Main.
- 356—HAMMOND, IND. 1st-3d**
Wed., Long's Hall, State St.
James Boyle, Pres.
Thomas Boyle, C. S., 264 State-line St.
- 360—LAFAYETTE, IND. 1st-3d**
Thurs., Bartenders' Hall, 3d and Ferry Pt.
Fred Ramp, Pres., 1601 N. 12th.
Wm. Peterson, C. S., 426 Lingle.
James Goldsberry, F. S.
- 363—EAST ST. LOUIS, ILL. 1st-3d**
Fri., Wyant Hall, Broadway and Main.
James Roose, Pres., 318 S. 5th.
John Roche, C. & F. S., 614 Ohio Ave.
- 367—HAVRE, MONT. 3d Sat.**
Oxford Hall.
- 369—ALEXANDRIA, VA. 1st**
Thur. in month during sum-mer months, 108 N. Patrick St.
James Morah, Pres., 1219 Duke.
M. Gemeny, R. & F. S., 1514 King.
- 371—LOWELL, MASS. 1st-3d**
Sat.
James Lanigan, Pres.
J. J. Cunningham, C. S., 656 Gor-ham.
- 377—MOLINE, ILL. 1st-3d**
Fri., Moline Industrial Home, cor. 14th St. and 6th Ave.
Carl Robison, Pres., 7th St., Sil-ivia, Ill.
John Fulton, F. S., 7th St., Sil-ivia, Ill.
- Charles McGowan, B. A., 7th St., Silvia, Ill.
C. R. Kiser, C. S., Box 581, Silvia, Ill.
Walter S. Schneider, B. A., 1317 25th St., Rock Island, Ill.
- 378—MONCTON, N. B., CAN.**
2d-4th Fri., Sons of Temper-ance Hall.
Alex McDougall, Pres., 143 High St.
R. D. Donnelly, C. S., 69 Down-ing St.
- 379—McADAM JUNCTION, N. B., CAN.**
2d-4th Fri., Orange Hall.
Geo. Guest, Pres.
A. J. McLaggan, C. S.
- 381—AMARILLO, TEXAS. 1007**
Buchanan.
M. L. Parker, Pres., Box 407.
Joe Wilson, C. S., 1007 Buchanan.
- 382—CHILDRESS, TEXAS. 2d-4th**
Fri., at 7:30 p. m., in Labor Temple.
Mack Leopold, Pres., P. O. Box 825.
J. M. Neal, C. S.
- 384—PERU, IND. 2d-4th**
Tues., Labor Trades Hall.
Floyd W. Seitz, Pres., 164 N. La-fayette.
A. W. Johnson, C. & F. S., 159 W. 3rd
Frank Sullivan, B. A., 133 W. 3d.
- 388—MECHANICSVILLE, N. Y.**
2d and last Tues., A. O. H. Hall, North Main St.
James S. Kennedy, Pres., S. Sec-ond Ave.
Sidney Crozier, C. S., 23 Rail-road.
Chas. Chapman, F. S., 112 N. 2d.
- 390—TRINIDAD, COLO. 2d-4th**
Wed., Labor Union Hall, East Main St.
W. F. Flynn, Pres. and C. S., 915 Arizona Ave.
- 391—DAVENPORT, IOWA. 2d-4th**
Fri., Danish Hall.
John Schach, Pres., 516½ W. 3d.
R. F. Stewart, C. S., 616 Tremont Ave.
W. C. Richards, F. S., 1938 Bridge Ave.
- 392—CALGARY, ALBERTA, CAN.**
3d Sat., 2:30 p. m., Labor Tem-ple.
J. Chambers, Pres., Ogden, P. O.
F. Adams, C. S., Ogden, P. O. Alb.
- 393—GOODLAND, KAS. 1st-3d**
Tues., Calvert & Sparks' Law Office.
S. E. Brattet, Pres.
Earl Crause, C. & F. S.
- 395—NORTH FOND DU LAC, WIS.**
1st-3d Fri., Trades and Labor Hall, cor. 3d and Main.
Carl Deyer, Pres., 615 Michigan Ave.
Jos. A. Hutzinger, C. S., 223 E. Johnson, Fond du Lac, Wis.
- 396—NORWICH, N. Y. 4th**
Wed. in Cook Block.
James E. Callahan, Pres., 1 Col-umbia St.
J. Julius Schraft, C. & F. S., 13 Davis.
- 398—RIVIERE DU LOUP, QUE-BEC, CANADA. 2d-4th**
Mon., Rioux Hall.
Mag. Bourgoin, Pres., River du Loup Station.
Jos. Beaulieu, B. A., Blaisville.
Ludger Oullet, C. & F. S., Blaisville.
- 400—MIDDLETON, N. Y. 1st-3d**
Fri., Odd Fellows' Hall.
Wm. Springer, Pres., 55 Beattie Ave.
Wm. E. Appel, F. S., 378 North.
Chris Smith, C. S., 381 North St.
- 402—PORTSMOUTH, OHIO. 2d-4th**
Fri., C. L. U. Hall.
R. L. Johnson, Pres., 2949 Galla.
E. L. Wilson, F. S., 1721 6th St.
Wm. H. Miller, C. S., 1411 Grand-view Ave.

- 403—HOISINGTON, KAS. I. O. O. F. Hall, 1st-3d Mon.
Ray Bowler, Pres., P. O. Box 72.
C. W. Cramer, C. & F. S., Box 494.
- 405—BLUEFIELD, W. VA. 1st-3d Fri., Masonic Temple.
E. K. Collins, Pres., Princeton Ave. E.
W. F. Dupree, C. & F. S., Gen. Del.
- 410—SAN FRANCISCO, CAL. 2d-4th Wed. Labor Temple, 16th and California.
Ed Hanny, Pres., 2217 Howard
L. Kevie, C. S., 208 Springdale Ave.
- 413—ST. THOMAS, ONTARIO, CAN. 2d-4th Tues., Machinists' Hall, Talbot St.
Frederick Brooks, Pres., 5 Maama
Frank Roberts, C. S., 61 Wilson
- 414—ONEONTA, N. Y. 1st Wed. and 3rd Sun., 2:30 p. m., Red-men's Hall.
James Walsh, Pres., 51 Church.
David Lawrie, C. & F. S., 73 W. Broadway.
- 415—JACKSONVILLE, ILL. F. McKenna, C. S., 475 E. State.
- 417—NORTH BAY, ONT. CAN. 2d-4th Mon., L. O. L. Hall.
A. E. Lye, Pres., Box 799.
Frank Crowther, C. S., Box 1773.
- 418—NEODESHA, KAS. 1st-3d Sat., Baldwin Hall.
Chas. Brown, Pres.
E. P. Reddick, C. S., 1007 Iowa.
A. F. Bingham, E. A.
- 419—SOMERSET, KY. 1st-3d Tues., at Owen's Hall.
W. C. Williams, Pres.
J. S. Arnold, C. & F. S., Sta. A.
- 421—HAMILTON, ONT. 1st-3d Fri., Labor Hall, John St. So.
L. Lawton, Pres., No. 21 Tuckett.
F. Honison, C. & F. S., 6 Bristol.
- 422—SANFORD, FLA. 2d-4th Wed., Eagles' Hall.
H. E. Purden, Pres.
Geo. Randall, C. & F. S., Box 1194.
- 423—BIG SPRINGS, TEX. 2d-4th Tues., I. O. O. F. Hall.
D. D. Crawford, Pres., cor. Gregg and 3d.
W. P. Warren, C. & F. S., 201 W. 1st.
- 424—FLORENCE, S. C. 2d Thurs., Y. M. C. A.
L. H. Mims, Pres., 222 Covington St.
A. H. Dickman, C. & F. S., 609 Day St.
- 425—WAYCROSS, GA. 1st-3d Thurs., Lott Hitch Bldg.
C. M. Schultz, Pres., 37 Stephens Ave.
L. J. Flohr, C. & F. S., Box 236.
- 427—SALIDA, COLO. 2d-4th Thurs., Adilas Hall.
H. F. Jones, Pres., 135 E. Sacket Ave.
Wm. Dargavel, C. S., 821 E. St.
- 428—NORFOLK, VA. 2d-4th Wed., Epythian Castle Hall.
W. M. Wood, Pres., 617 Liberty St., Berkeley, Va.
Thos. Callahan, C. & F. S., 116 Middleton St., Berkeley, Va.
- 430—CAPE GIRARDEAU, MO. 1st-3d Tues., Haas' Hall.
Geo. Stanley, Pres., 223 Frederick St.
Oscar O. Berry, F. S., 415 S. Frederick St.
- 431—BOSTON, MASS. 2d Thurs., Naomi Hall, 724 Washington.
Thos. R. Keenan, C. S., 80 W. 5th St., So. Boston.
- 434—CHICAGO, ILL. 2d-4th Tues., Marquette Hall, 6650 Halstead St.
H. Fischer, Pres., 8438 Sangamon.
Edward Osborn, C. S., 43 E. 43d St.
- 435—BRISTOL, TENN. 2d-4th Fri., Sixth and Shelby Sta.
M. C. Cooper, Pres., V. & S. W. Ry. Shops.
J. B. Wood, C. & F. S., 27 Lancaster St., Bristol, Va.
- 436—COLUMBUS, GA. 1st-3d Fri., Trades and Labor Assembly Hall.
R. S. Barry, Pres., 911 4th Ave.
E. W. McMichael, C. & F. S., 1105 21st St.
- 437—TWO HARBORS, MINN. 2d and last Thurs., Iron Dock Grove Hall.
Christ. Anderson, Pres.
Charles Larson, C. & F. S., Box 298.
- 438—GALETON, PA. 2d-4th Tues., Eagles' Hall.
Charles H. Bartlett, C. S., 59 Germania.
- 439—FAIRBURY, NEB. 4th Wed., K. of L. S. Hall.
B. Z. Milliken, C. & F. S., P. O. Box 167.
Fred Kurst, E. A.
- 440—BELLE PLAINE, IOWA. 2d-4th Mon., Fireman's Hall.
Charles Corns, Pres., 10th St.
Warren Wheeler, C. S., P. O. Box 605.
- 442—NEW ORLEANS, LA. 3d Tues., McMahon Hall, 1112 Drades.
James Miller, Pres., 1204 So. Franklin.
John Mocklin, C. & F. S., 606 S. Telemachus St.
- 444—CONNELSVILLE, PA. J. W. Easley, C. S., 517 N. Pgh. Wed., Trades Assembly Hall.
Albert Jacobson, Pres.
Chas. F. Darling, C. S., Box 64.
- 447—DECATUR, ILL. 1st-3d Tues., Ashley Hall, Mason Temple.
Jas. Gray, Pres., 817 N. Broadway.
Chas. J. Younger, C. & F. S., 432 E. King St.
- 448—MONTGOMERY, ALA. 1st-3d Wed., Young's Hall.
J. A. Redding, Pres., 316 Columbus.
E. J. Ford, C. S., 75 Morgan Ave.
- 449—SAPULPA, OKLA. 2d-4th Mon., Moose Hall.
M. E. Lange, Pres., 913 E. Hobson.
Irwin Shipman, C. S., Box 338.
- 450—WASHINGTON, D. C. 2d-4th Wed., New Masonic Hall, 8th and F Sts., N. E.
A. W. Sherier, Pres., 106 15th S. E.
- W. F. Kilroy, C. S., 11 I St., N. E.
- 451—WINNIPEG, MAN., CAN. 2d-4th Fri., Labor Temple.
D. Nelson, Pres., 322 Morley Ave.
F. Snare, C. & F. S., 263 Bradford St., St. James.
- 453—COPPERHILL, TENN. 1st-3d Tues., I. O. O. F. Hall.
Chas. Franz, Pres., Box 711.
E. N. Hall, C. S., Box 382.
- 454—CHICAGO, ILL. 2d-4th Thurs., Persey Hall.
Walter Love, Pres., 752 E. 69th St.
E. R. Dettmer, C. S., 9245 Stoney Island Ave.
- 458—SHERMAN, TEXAS. 2d-4th Thurs., Machinists' Hall.
W. K. Murray, Pres., Tucket Ave.
John Plexco, C. & F. S., 424 Gribble Ave.
- 463—BALBOA, CANAL ZONE, PANAMA. 1st-3d Fri., Ancon Lodge Hall.
A. R. R. Charters, Pres., Carozal, C. Z.
W. H. Keenan, C. & F. S., Box 26, Culebra, C. Z.
- 464—PALESTINE, TEXAS. Labor Temple, 2d-4th Wed.
J. S. Guinn, Pres., 635 Tenn. Ave.
J. D. Mallette, C. & F. S., 503 La.
- 466—REVELSTOCK, B. C. 3rd Sat., Bolkirik Hall.
M. M. Keller, Pres., Box 132.
A. Harris, C. & F. S., Box 132.
- 467—PORTSMOUTH, N. H. 2d Wed., Eagles' Hall.
John Quinn, Pres., Court St.
Alfred Olson, C. S., Box 27, Kittery, Me.
- 469—TERRELL, TEXAS. 2d-4th Fri., Trades and Labor Hall, 202 E. Moore Ave.
J. R. Poston, Pres., 608 E. College St.
R. E. O'Reilly, C. S., 906 E. Moore Ave.
- 471—CRISTOBAL, O. Z. 2d-4th Thurs., Canal Lodge Hall.
Alexander McKenzie, Pres.
Jas. Z. Knapp, C. & F. S., Box 219.
- 473—HELPER, UTAH. 1st-3d Wed., K. of P. Hall.
Wm. E. Welsh, Pres.
R. W. Smith, C. & F. S., Box 411.
- 475—GRAND ISLAND, NEB. 1st-3d Mon., City Hall, 2d St.
H. W. Hunt, Pres.
Sherman Aldrich, F. S., 1014 E. 4th St.
- 476—DALHART, TEXAS. 3d Fri., Socialist Hall.
H. C. Fritche, Pres.
Theo. P. Nelson, C. & F. S., Box 282.
- 478—MOOSE JAW, SASKATCHEWAN, CANADA. 2d-4th Mon., Trades and Labor Hall, Main St.
Wm. Gillies, Pres., 364 Fairford St., W.
Geo. Walters, C. S., 244 Iroquois.
- 479—DEVIL'S LAKE, N. DAK. 1st Fri., Opera House Hall.
- 481—LYNDONVILLE, VT. 1st-3d Wed., Eaton's Hall.
E. A. Hinds, Pres.
E. A. Phillips, C. & R. S., Box 121, Lyndon Center, Vt.
J. M. Bresson, E. A.
- 482—ALTON, ILL. Schwartzbeck Hall, 3d and Ridge. 1st-3d Tues.
D. Stafford, Pres., 1009 E. 5th St.
Robt. Dale, C. & F. S., 3008 Edwards.
- 485—GREEN BAY, WIS. 1st-3d Thurs.
John Christianson, Pres., 822 S. Maple Ave.
John Slater, C. & F. S., 425 5th St.
J. L. Callahan, B. A., 3606 Clifton Ave., Milwaukee, Wis.
- 486—TYLER, TEXAS. 1st-3d Wed., K. O. T. M. Hall.
J. A. Fuller, Pres., 1116 Irvin.
J. M. McCarty, C. & F. S., 216 Center Ave.
C. R. Welch, B. A., 1428 N. Fannie Ave.
- 491—VALLEY JUNCTION, IOWA. 1st-3d Tues., I. O. O. F. Hall.
Frank S. Hoppe, Pres.
J. C. Carroll, C. S., Box 165.
Geo. W. Pring, B. A., Treas.
- 493—NEW CASTLE, PA. Jan. 13, 1915, and every other Wed., Trades Assembly Hall.
D. E. Sturdevant, Pres., 516 Waldo.
David Lewis, C. & F. S., 422 Galbreath Ave.
- 495—HATTIESBURG, MISS. 1st-3d Tues., 500 Bouie St.
C. W. LeBlanc, Pres., 107 Evans.
A. H. Waddell, C. & F. S., 500 Bouie.
- 496—HURON, SOUTH DAKOTA. 2d Sun. and 4th Fri., Labor Hall.
Peter Paluszak, Pres.
C. Storkson, C. & F. S., 223 Beach St.

- 500 — EVERETT, WASH.** 2d-4th Tues., Labor Temple, 3506 Everett Ave
- 501—WACO, TEXAS.** 2d-4th Fri., Labor Hall. Chas. Bullock, Pres., R. F. D. No. 2. Wm. Dickerson, C. & F. S., 810 Cleveland St.
- 502—TEAGUE, TEXAS.** 1st-3d Mon., Davis Hall. Thos. McGrath, Pres., Box 244. J. D. Clayton, C. S.
- 503—FITZGERALD, GA.** 1st-3d Wed., I. O. O. F. Hall. M. J. Mauns, Pres., P. O. Box 686. A. B. Campbell, C. S.
- 504—MUSKOGEE, OKLA.** 1st-3d Wed., Carpenters' Hall. Guy Carver, Pres., 1220 Baltimore. W. H. Hannaford, C. & F. S., Gen. Del.
- 505—FORT WILLIAM, ONTARIO, CAN.** 1st-3d Fri., Electricians' Hall, Murphy Block, Simpson Ave. James Duncan, Pres. A. Cruickshank, C. S., 1007 Minn. Ave.
- 507—ATCHISON, KAS.** 1st-3d Mon., Fireman's Hall, 1521 Main St. J. F. Coyle, Pres., 1418 Kansas Ave. John J. Fretbott, C. & F. S., 1420 Kansas Ave.
- 508—JACKSON, OHIO.** 4th Tues., Hibernian Hall. O. B. Reynolds, Pres., 77 High St. Albert Edmonds, C. S., 77 Hunt St. J. B. Fillinger, B. A. and Journal Cor., 53 Main St.
- 510—CEDARTOWN, GA.** E. M. Kendrick, Pres. I. C. Smith, C. S.
- 511—WHISTLER, ALA.** 1st-3d Mon., I. O. O. F. Hall. J. B. Chestang, Pres. C. C. Crone, C. S., 209 Bauregard, Mobile, Ala.
- 515—EAST CAMBRIDGE, MASS.** Engineers' Hall, 164 Canal St., Boston, Mass., 1st-3d Fri. Geo. L. Parks, Pres. John P. Grant, C. & F. S., 124 Spring.
- 517—GREENFIELD, MASS.** 2d-4th Sat., Forester Hall. Patrick Kelley, Pres., 3 Devens. Tim Scannell, C. & F. S., 6 Russell St.
- 518 — WICHITA, KAS.** 1st-3d Thurs., 216 N. Main St. G. W. Thompson, Pres., 2127 University Ave. O. E. Maze, C. S., 1933 W. Lincoln.
- 520—MILES CITY, MONT.** 2d-4th Fri., Wilboux Hall, 7th and Main. P. J. Gallagher, Pres., 602 N. Lake St. Chas. E. Cook, C. & F. S., 119 N. Strevelle.
- 521—VAN BUREN, ARK.** 1st-3d Thurs., W. O. W. Hall. Charles Pathast, Pres. Otto Pyles, C. S., Box 343. C. A. McDonald, B. A., 4416 Norledge, Kansas City, Mo.
- 522—EL RENO, OKLA.** 1st-3d Tues., Redmen's Hall. H. E. Hart, Pres., Box 624. H. A. Mathews, C. & F. S., Box 12.
- 523—PRATT, KAS.** 2d-4th Tues., at S. T. Sample's residence. W. F. Stephen, Pres., 624 N. Ninirscach St. F. W. Sharpe, C. S., Box 73.
- 524—MURPHYSBORO, ILL.** 2d-4th Wed., Machinists' Hall, 107 S. 10th. A. R. McFarland, Pres., 638 N. 8th. E. P. Herin, C. & F. S., 2107 Wall.
- 525—HINTON, W. VA.** 1st-3d Mon., Big Four Bldg. W. L. Taylor, Pres., 108 Grace St. C. L. Barnette, C. & F. S. & B. A., 419 Summer Ave.
- 528—DEER LODGE, MONT.** 2d-4th Fri., I. O. O. F. Hall. T. J. Messing, Pres. J. H. Thomas, C. & F. S., P. O. Box 877.
- 529—WINNIPEG, MAN., CAN.** 1st Sun., Campbell Hall, Transcona, 3rd Sun., Labor Temple, Winnipeg, 3 P. M. A. Orr, Pres., 3 Gallagher Ave., Brooklands, Man., Can. Robt. Clark, C. & F. S., 471½ Portage Ave.
- 530—SPRINGFIELD, MO.** 3d Mon., Dengeidern's Hall. J. W. Reddick, Pres., 817 Lincoln. John Cain, C. & F. S., 507 Fort. A. F. Bingham, B. A., 701 Lombard St.
- 531—CHAFFEE, MO.** 1st-3d Thurs., City Hall. T. C. Davis, Pres. C. P. Bourlon, C. & F. S., Box 365.
- 537—COVINGTON, KY.** 2d-4th Fri., Workman Hall, 122 Pike St. A. J. Pope, Pres. & B. A., 1817 Scott St. John J. Fielding, C. & F. S., 1341 Holman.
- 541—BEDFORD, IND.** 2d-4th Thurs., Labor Union Hall. Dan J. Kane, Pres., 511 N. I St. C. J. Bordenet, C. S., 623 N. I.
- 542—COFFEYVILLE, KAS.** Labor Temple, 2d-4th Wed. R. M. Jones, Pres., 807 W. 14th. J. C. Morrow, C. & F. S., 613 W. 4th St.
- 543—WICHITA, KAS.** 216 N. Main St., 2d-4th Wed. C. E. Grove, C. & F. S., 701 W. Central.
- 546—MONETT, MO.** 1st-3d Tues., K. C. Hall. T. J. Moore, Pres., 706 Benton Ave. John Linebarger, C. & F. S., 214 Pearl St.
- 547—CARBONDALE, PA.** Pughanas Hall, 2d-4th Fri. E. T. Dickenson, C. & F. S., 142 Wyoming. Wilkes Barre Representative. T. J. Cavan, 50 Chester St., Wilkes Barre, Pa.
- 548—TORONTO, CAN.** 2d-4th Wed., Labor Temple, Church Perth Ave. Joseph P. Dobson, Pres., 280 John C. Walker, C. & F. S., 152 Gladstone Ave.
- 549—MIDDLEPORT, O.** 1st-3d Tues., Firemen's Hall. Lester Cunningham, Pres. Perry Cooper, C. & F. S.
- 551—PRINCETON, W. VA.** Castle Hall, 1st-3d Thurs. J. H. Blackwell, Pres., Box 312. J. H. Bowers, C. S., 576 Bluefield.
- 556—OKLAHOMA CITY, OKLA.** C. S. Cochran, Pres., 406 W. Frisco. E. F. Ryan, C. & F. S., 400 West Frisco.
- 557—WILLIAMSON, W. VA.** 2d-4th Tues., Eagles' Hall, 3rd Ave. W. H. Turner, Pres., 113 6th Ave. H. W. Blas, C. & F. S., 124 Oak.
- 565—FALLS CITY, NEB.** 1st-3d Thurs., W. O. W. H. Hall. C. W. Jonas, Pres. E. Woodington, C. & F. S., 710 E. 16th St.
- 567—SAN ANGELO, TEX.** 1st-3d Wed., Eagles' Hall. O. M. Seay, Pres., 821 W. Ave. I. R. L. Wright, C. S., 27 West Ave. L.
- 568—TACOMA, WASH.** Maccabee Hall, 1108½ C St., 2d-4th Thurs. Chas. Manning, Pres., 5808 S. Lawrence St. A. W. Rickett, C. & F. S., 615 So. State.
- 570—HIGH SPRINGS, FLA.** H. A. Smith, Pres., P. O. Box 273. F. C. Magerstaadt, C. S.
- 571—DE PERE, WIS.** De Both Hall, 1st Sun.-3d Wed. T. J. McDonald, Pres., Lock Box 44, W. De Pere, Wis. A. B. Steinfeldt, R. S., P. O. Box 297.
- 573—LANSFORD, PA.** Frank A. O'Donnell, C. S., Summit Hill.
- 575—VILLA GROVE, ILL.** 1st-3d Fri., Red Men's Hall. James Tally, Pres. A. Welch, C. S. H. A. Downes, F. S.
- 576—WICHITA FALLS, TEX.** 2d-4th Thurs., Labor Hall. J. H. Gibson, Pres., 309 Lee St. E. J. Monahan, C. & F. S., Box 760. C. H. Shoemaker, B. A., Box 18, Healdton, Okla.
- 577—CUMBERLAND, MD.** 1st-3d Thurs., Trades Council Hall. E. H. Stealey, Pres., Ridgeley, W. Va. Owen Layman, C. & F. S., Ridgeley, W. Va.
- 578—HAGERSTOWN, MD.** Moose Hall, 2d-4th Thurs. L. J. Murray, Pres., 25 Vine St. Fred H. Stouffer, C. S., 817 Summit Ave.
- 579—KEYSER, W. VA.** 1st-3d Tues., City Building. W. H. Wolf, Pres., Gilmore St. P. R. Dougan, F. S., Gilmore St. Joseph F. Hines, C. S., Piedmont, W. Va.
- 581—MONTPELIER, O.** 1st-3d Wed., Ry. Trainmen's Hall. S. Brown, Pres. J. Birmingham, C. S.
- 582—BATON ROUGE, LA.** 2d-4th Thurs., Odd Fellows' Hall, 3d St. W. P. Kidd, Pres., 302 St. Philip St. S. V. Acosta, C. & F. S., 918 St. Ferdinand St.
- 583—NEVADA, MO.** Socialist Hall, Hall, So. Main St., 1st-3d Thurs. A. C. LeQuellec, Pres., 520 E. Cherry. L. E. Whitehead, C. & F. S., R. F. D. No. 1. C. A. McDonald, B. A., 4416 Norledge, K. C., Mo.
- 584—LUDLOW, KY.** 1st-3d Thurs., Morley Hall. Thos. Jackson, Pres., 17 Pherry. H. J. Stroer, C. S., 833 Main, Covington, Ky.
- 585—BOSTON, MASS.** 1st Thurs., 3 p. m., and 3d Sun., 2:30, Hemstead Hall, 724 Washington St. Wm. E. McNabb, Pres., 263 Chelsea, E. Boston, Mass. Daniel B. McInnes, C. S., 288 Marginal Ave., E. Boston, Mass. Daniel N. Generson, B. A., 17 Rulard, Dorchester, Mass. James Vincent, F. S., 77 Lavitt Hill.

- 586—SLATER, MO.** 2d-4th Mon., I. O. O. F. Hall. Chas. Crawford, Pres. Andy Phelps, C. & F. S.
- 587—BEAUMONT, TEX.** 2d-4th Tues., Trades Assembly Hall. Geo. H. Clayton, Pres., Box 624. T. C. Muddy, C. & F. S., Box 624.
- 588—CHICAGO, ILL.** 2d-4th Tues., Koop's Hall, California & North Aves. Thomas Godfrey, Pres., 930 E. 44th St. John McNaney, C. & F. S., 819 N. Rockwell.
- 589—MILWAUKEE, WIS.** 2d-4th Thurs., 923 E. Water St. Frank Thinner, Pres., 729 5th. M. J. Gleason, C. & F. S., 202 Michigan St.
- 590—MONROE, LA.** 1st Fri., 615 A St. J. W. Grant, Pres., 501 Wood St. J. J. Devereux, C. & F. S., 615 Calypso St.
- 591—GLENVIEW, MONT.** 2d-4th Fri., Nod-rhoff Hall. N. A. Schope, Pres., Gen. Del. V. B. O'Connor, C. & F. S., 317 Valentine.
- 592—TULSA, OKLA.** 2d-4th Sat. 214 1/2 S. Main. J. E. Dixon, Pres.
- Richard Leahy, C. & F. S., 215 Reeder Bldg.
- 593—CLIFTON, ARIZ.** Every Sat., Carpenters' Hall. Homer Darr, Pres., Box 704. Joseph B. Hammer, C. & F. S., Box 416.
- 594—STANBURY, MO.** 2d-4th Tues., K. of P. Hall. John Inman, Pres. E. W. McNew, C. S.
- 595—AVERY, IDAHO.** 2d-4th Mon., Godfrey's Home, West Avery. A. Anderson, C. & F. S., Gen. Del.
- 596—CASPER, WYO.** 2d-4th Mon. John Mulligan, Pres., 232 N. Beach. H. L. Celley, C. S., 509 S. Beach.
- 597—ESCANABA, MICH.** 1st-3d Thurs., Lemmer Hall, Ludington St. Jos. Vickers, Pres., 506 Wells Ave. Wm. Groanich, C. & F. S., 714 Wells Ave.
- 598—SALAMANCA, N. Y.** 1st-3d Mon., 3 Maple St. A. G. Frey, Pres., 165 E. State St. D. J. Carpenter, C. & F. S., 3 Maple St.
- 599—PARAGOULD, ARK.** 1st-3d Thurs., Carpenters' Hall.
- J. W. Frey, Pres., 321 S. 2d St. A. Johnson, C. & F. S., 216 N. 5th Ave. C. A. McDonald, B. A., 4416 Norledge, Kansas City, Mo.
- 601—QUEBEC, CAN.** J. Thompson, Pres., 130 3d St., Simollou. G. Dery, C. S., 153 4th St., Larmorlow, Quebec, Can.
- 602—GREAT FALLS, MONT.** 2d-4th Tues., Musicians' Hall, over the Mint. J. L. Smith, Pres., 205 2nd Ave. N. North. Roy J. Preston, C. & F. S., 420 8th Ave. So.
- 603—OTHELLO, WASH.** 1st-3d Mon., I. O. O. F. Hall. O. W. Bohusock, Pres. W. O. Clark, C. S., Box 137.
- 604—JOLIETTE, QUE., CAN.** H. Fournier, Pres., Gen. Del. W. C. Williams, C. & F. S., Box 233.
- 605—TOOELE, UTAH.** 2d-4th Thurs., Fraternal Hall. D. B. Sullivan, Pres. L. Fornoff, F. S., Box 294.
- 606—MORRIDGE, S. D.** 1st-3d Thurs., Moose Hall. J. P. Schmickrath, Pres., Box 721. H. L. Adams, C. & F. S., Box 166.

International Officers of the Ladies' Auxiliary

- MRS. J. W. EDWARDS**.....President
1234 S. 9th East St., Salt Lake City, Utah.
- MRS. F. R. REINEMEYER**...1st Vice-President
Tauromee Ave., Kansas City, Kans.
- MRS. MOLLIE GEARY**.....2nd Vice-President
6423 S. Albany St., Chicago, Ill.
- MRS. A. F. BINGHAM**.....Secretary-Treasurer
701 Lombard St., Springfield, Mo.

L. A. 5—SALT LAKE CITY, UTAH.
Mrs. J. W. Edwards, Pres. & C. S., 923 W. South Temple St.
Mrs. Lydia Smithen, V.-Pres., 360 West 1 South St.
Mrs. J. C. Walton, F. S.
Mrs. Jane Foreman, Treas.
Mrs. Morton, R. S., 116 Markham.

L. A. 7—SUNFLOWER, Parsons, Kas. 2d-4th Tues. aft., Kennedy Hall.
Mrs. Lillian Dudding, Pres., 2229 Crawford Ave.
Mrs. Alice Leach, Vice-Pres.
Mrs. Zita Reyer, Treas.
Mrs. Lula VanVleck, C. & R. S., 2701 Clark Ave.
Mrs. Ethel Smith, Fin. Sec., 2227 Wash. Ave.
Mrs. Mary Carver, Chaplain.
Mrs. Marion Butler, Marshall.
Mrs. Ida Cormany, Conductress.
Mrs. Kate McMullen, In. Guard.
Mrs. Emma Pilkington, O. Guard.

L. A. 8—FRANKLIN, McComb, Miss. Ladies' Aux. Hall, Ave. F. East McComb, 2d-4th Thurs.
Miss Lula Hassfield, Pres., R. F. D. No. 1.
Mrs. E. Sullivan, V.-P. & Treas., 725 Ave. F.
Miss Emma Sullivan, C. S., 725 Ave. F.
Miss Lulu Hassfield, R. S.

L. A. 9—GRAND JUNCTION, COLO.
Mrs. W. H. Holeman, Past Pres., 914 S. 5th St.
Mrs. F. N. Davies, Pres. & Treas., 538 Ute Ave.
Mrs. J. W. Cox, C. & F. S. & V.-P., 925 S. 5th St.
Mrs. L. A. Turner, R. & S. T.

L. A. 10—SPRINGFIELD, MO.
Mrs. A. F. Bingham, Pres., 701 Lombard St.
Mrs. J. Gestring, Vice-Pres.
Mrs. C. S. Gilliland, C. & R. S., 1914 Johnson St.
Mrs. Wm. Specht, F. S. & T., Route 6.
Mrs. Rheaden, Chaplain.
Mrs. J. East, Conductress and Marshall.
Mrs. J. Ritterhouse, Inside Guard.
Mrs. Gestring, Mrs. Gilliland and Mrs. East, Trustees.

L. A. 11—LONE STAR, Palestine, Texas. Labor Temple, 2d-4th Tues. afternoons.
Mrs. Frances Brunson, Pres., 15 Cottage Ave.
Mrs. Helen Redus, V.-P., 106 Queen St.
Mrs. Florence Payne, R. S. & Treas., 212 Palmer Ave.
Mrs. Willie Welch, C. & F. S., 511 Green St.

L. A. 12—GARFIELD PARK, Chicago, Ill. 1st-3d Sat., 8 p. m., Garfield Park Hall, 4039 W. Madison.
Mrs. Maud Reinemeyer, Past Pres.
Mrs. Mollie Geary, Pres., 6423 S. Albany Ave.
Mrs. E. Farrell, V.-P., 4118 Carroll Ave.
Mrs. Helen Hughes, Cor. & Rec. Sec., 716 N. Avera Ave.
Mrs. Mary Driscoll, Fla., Sec. & Treas., 4136 Carroll Ave.

L. A. 14—TOLEDO, O.
Mrs. E. Richardson, Pres.
Mrs. Allen Thomson, V.-Pres.
Mrs. C. F. Haga, R. S.
Mrs. C. J. Sugrue, C. & F. S.
Mrs. Carrie Stephan, Treas.
Mrs. Louise Brown, Conductress.
Mrs. Lena Kern, Inspectress.

L. A. 15—SAPULPA, OKLA.
Mrs. Cora Johnson, Pres.
Mrs. Myrtle Clifton, V.-Pres.
Mrs. Addie Allen, R. S.
Mrs. Essie Lewis, C. S.
Mrs. Hester Chapman, F. S.
Mrs. Ethel Edwards, Treas.
Mrs. Hettie Rondon, Chaplain.
Mrs. Ferrel Wells, Conductress.
Mrs. Emma Davis, Inside Guard.
Mrs. Katie Hoover, Marshall.
Trustees—Laura Cargill, Mrs. Emma Davis, Mrs. Addie Allen.

L. A. 16—DECATUR, ILL.
Mrs. M. J. Kelly, Pres.
Mrs. Fred Reutcher, Vice-Pres.
Mrs. H. J. McLaughlin, R. S.
Mrs. Henry Yost, C. & F. S.
Mrs. C. C. Dean, Treas.

L. A. 17—CHICAGO, ILL.
Mrs. Lizzie Person, Pres., 7430 Ingleside Ave.
Mrs. Elenora Clark V.-P., 7539 Rhoades Ave.
Mrs. Nellie Evans, R. S., 2722 E. 76th St.
Mrs. Marion Evans, C. S., 735 E. 88th St.
Mrs. Emma Shupart, F. S., 7300 Cottage Grove Ave.
Mrs. Cora E. Kelly, Treas., 9251 Stormy Island Ave.

Boilermakers' Lodges by States.

Alabama. Birmingham . . . 4 Montgomery . . . 443 Selma . . . 312 Sheffield . . . 344 Whistler . . . 511	Macon 12 Savannah 26 Waycross 425	Maryland. Cumberland . 332 Cumberland . 577 Baltimore . . 193 Hagerstown . 578	New York. Albany 197 Brooklyn . . . 45 Buffalo 7 Elmira 225 Mechanics- ville 388 Middletown . 400 Norwich 396 Oneonta 414 Rochester . . . 229 Salamanca . 598 Staten Island. 200 Troy 73 Utica 223 N. Y. City . . . 21	Texas. Amarillo . . . 331 Beaumont . . . 587 Big Spring . . 423 Childress . . . 382 Dalhart 476 Dallas 86 Denison 209 El Paso 216 Ft. Worth . . . 96 Galveston . . . 132 Houston 74 Kingsville . . . 287 Marshall 100 Mart 222 Palestine . . . 464 Sherman 453 Port Arthur . 305 Smithville . . 265 San Antonio . 345 Teague 502 Terrell 449 Tyler 486 Waco 501 Walnut Springs . . . 207
Arizona. Clifton 593 Miami 187	Idaho. Avery 595	Massachusetts. Boston 250 Boston 431 Boston 585 Cambridge . 515 Greenfield . 517 Lowell 371 Norwood . . . 281	North Carolina. Raleigh 173 Rocky Mount. 239 Salisbury . . . 226	Utah. Helper 473 Ogden 198 Salt Lake City 103 Tooele 605
Arkansas. Harrison 138 Little Rock . . 66 Little Rock . . 69 McGhee 106 Paragould . . . 599 Pine Bluff . . . 68 Van Buren . . . 521	Illinois. Alton 483 Bloomington . 155 Chicago 1 Chicago 39 Chicago 220 Chicago 227 Chicago 454 Chicago 434 Chicago Hts. 254 Chicago 583 Danville 22 Decatur 447 Freeport 284 Joliet 93 Kewanee 195 Mattoon 224 Moline 377 Peoria 60 Murphysboro 524 Springfield . . 81 E. St. Louis . 363 Urbana 150 Villa Grove . . 575	Michigan. Bay City 67 Detroit 169 Escanaba 597 Grand Rapids 84 Jackson 64 Marquette . . . 236 Saginaw 124	North Dakota. Devils Lake . . 479	Virginia. Alexandria . . 369 Clifton Forge. 238 Newp't News. 55 Norfolk 428 Portsmouth . . 298 Portsmouth . 57 Richmond . . . 170 Roanoke 30 Roanoke 29 Victoria 65
Canada. Calgary Alberta 392 Edmonton Alb. 279 Ft. William . . . Ont. 505 Hamilton Ont. 421 Joliette, Que. 604 McAdam Jct. 379 Moncton, N.B. 378 Montreal 134 Moose Jaw Sask. 478 North Bay Ont. 417 Quebec 601 Revelstoke . . . 466 Riviere du Loup, Que. 398 St. Thomas . . . Ont. 413 Toronto, Ont. 548 Transcona Man. 529 Winnipeg, M. 126 Winnipeg, M. 451	Indiana. Bedford 541 Evansville . . . 95 Ft. Wayne . . . 54 Garrett 79 Hammond 356 Indianapolis . 10 Lafayette 360 Peru 384 Princeton 334 Terre Haute. 246 Washington . . 241	Minnesota. Brainerd 116 Duluth 165 Minneapolis . 11 St. Paul 3 Two Harbors. 437 Winona 201	Ohio. Bellefontaine. 243 Canton 301 Chillicothe . . 135 Cincinnati . . . 105 Cleveland 5 Columbus 3 Conneaut 355 Elmwood Place 91 Jackson 509 Lima 259 Middleport . . . 549 Montpelier . . . 581 Newark 99 Portsmouth . . 402 Toledo 85 Van Wert 409	Vermont. Lyndonville . . 481
British Columbia. Vancouver . . . 194 Victoria 191	Iowa. Belle Plaine . 440 Boone 161 Cedar Rapids. 144 Des Moines . . . 47 Dubuque 15 Marshalltown. 149 Mo. Valley . . . 244 Sioux City . . . 244 Valley Jct. . . . 481 Waterloo 133	Mississippi. McComb City. 315 Meridan 320 Water Valley. 300	Oregon. Portland 72	West Virginia. Bluefield 405 Elkins 278 Gassaway 153 Hinton 525 Huntington . . . 249 Keyser 579 Princeton 551 Williamston . . 557
California. Los Angeles . . 92 Oakland 233 Pt. Richmond. 317 Sacramento . . 94 S. Francisco . . 25 S. Francisco . 205 S. Francisco . 410 Vallejo 148	Kansas. Atchison 507 Coffeyville . . 542 Ft. Scott 286 Goodland 393 Herington . . . 340 Holsington . . 408 Horton 199 Kansas City . . 83 Neodesha 418 Osawatomie . . 82 Parsons 292 Pittsburg 221 Pratt 523 Wichita 543 Wichita 518	Missouri. Brookfield . . 354 Cape Girar- deau 430 Chaffee 531 De Soto 117 Kansas City . . 32 Moberly 267 Monett 548 Nevada 583 Sedalia 113 Springfield . . 70 Springfield . 530 Slater 586 St. Louis 27 St. Louis 276 St. Louis 322 St. Joseph . . . 31 Stanbury 594 Sugar Creek . . 90 Trenton 346	Panama. Empire, C. Z. 463 Cristobal 471	Washington. Bremmerton . . 290 Everett 500 Othello 603 Spokane 242 Seattle 104 Seattle 489 Tacoma 247 Tacoma 568
Colorado. Alamosa 446 Colorado 126 Denver 179 Grand Jct. . . . 325 Pueblo 44 Salida 427 Trinidad 390	Kentucky. Covington . . . 537 Covington . . . 364 Louisville . . . 40 Ludlow 584 Paducah 137 Somerset 419	Montana. Anaconda 80 Deer Lodge . . 528 Glendive 591 Great Falls. 602 Harlowton . . . 41 Havre 367 Livingston . . . 123 Miles City . . . 520 Missoula 111 Butte 130	South Carolina. Charleston . . 50 Columbia 235 Florence 424	Wisconsin. Butler 589 De Pere 571 Green Bay . . . 485 Milwaukee . . . 107 Milwaukee . . . 302 N. Fond du Lac 395 S. Kaukauna. 311
Connecticut. Hartford 237 New Haven . . . 61	Louisiana. Baton Rouge. 532 New Orleans . 37 New Orleans. 442 Shreveport . . 328 Algiers 206 Monroe 590	Nevada. Sparks 339	Pennsylvania. Carbondale . . 547 Gonnellville . 444 Galeton 438 Lansford 573 New Castle . . 493 Philadelphia . 341 Pittsburgh . . 154 Pittsburgh . . 318 Philadelphia . . 19	South Dakota. Huron 496 Mobridge 606
Delaware. Dist. of Columbia Washington . . 450	Nebraska. Chadron 109 Fairbury 439 Falls City . . . 565 Grand Island. 475 Omaha 38	New Hampshire. Concord 245 Portsmouth . . 467	Tennessee. Bristol 435 Copperhill . . 453 Jackson 88 Knoxville . . . 143 Memphis 180 Nashville 42 Chattanooga . 14	Wyoming. Casper 596 Cheyenne 46 Evansville . . . 309 Laramie 48
Florida. High Springs. 570 Jacksonville . 20 St. Augustine. 230 Sanford 422	New Jersey. Elizabeth 176 Hoboken 163 Jersey City . . 16	Georgia. Atlanta 2 Augusta 108 Cedartown . . . 510 Columbus 426 Fitzgerald . . . 503		

By Insisting Upon Purchasing Union Stamp Shoes



You help better shoemaking conditions.
You get better shoes for the money.
You help your own labor position.
You abolish child labor.

Do not be misled by retailers who say: "This shoe does not bear the union stamp, but is made under union conditions." This is false—no shoe is union made unless it bears the union stamp.

Boot and Shoe Workers' Union

246 SUMMER STREET, BOSTON, MASS.

JOHN F. TOBIN, President.

CHAS. L. BAINE, Sec.-Treas.

THE COMMERCIAL NATIONAL BANK

of KANSAS CITY, KANSAS.

CAPITAL AND SURPLUS, \$550,000.00.

DEPOSITS.....\$5,000,000.00

We cordially invite the Boiler Makers and Ship Builders of the United States who desire to transact banking business with us (which can be done readily by mail), to write to any of their officers and ask any questions they may desire to ask about our reliability and standing.

P. W. GOEBEL, President.

C. L. BROKAW, Cashier.

A. C. FASENMYER, Vice-President.

G. J. BISHOP, Asst. Cashier.

When Writing Advertisers

PLEASE MENTION

The Boiler Makers' Journal

Notice to Subscribers of the Journal

When members change their address, or do not receive Journal promptly, fill out the following blank and forward to the editor:

NameReg. No.Lodge.....

Old Address, Street.....CityState.....

New Address, Street.....CityState.....

I have not received Journal for month of.....

KANSAS CITY, KAS., SEPTEMBER, 1915.

THE BOILERMAKERS JOURNAL

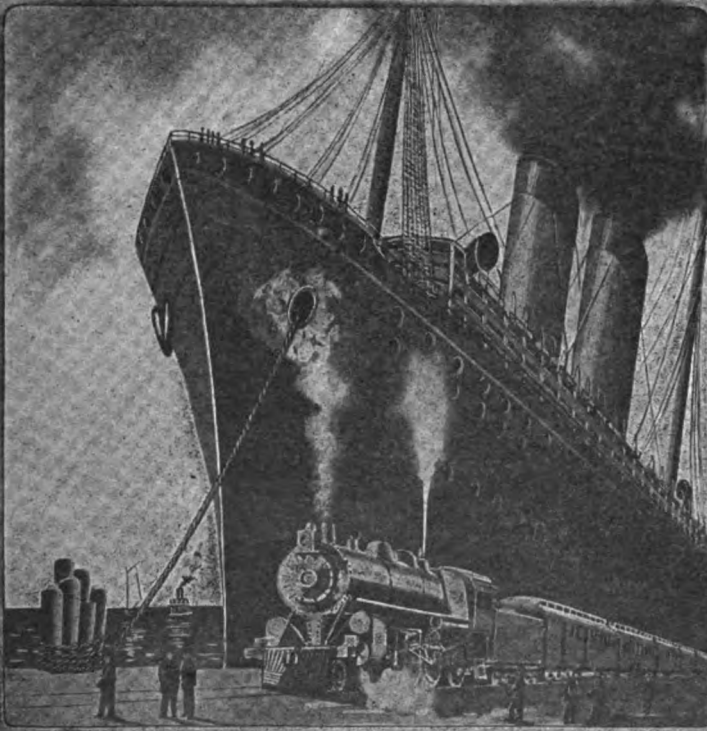

OFFICIAL ORGAN OF THE
INTERNATIONAL BROTHERHOOD
OF BOILERMAKERS, IRON SHIP BUILDERS
AND HELPERS OF AMERICA



HEADLIGHT OVERALLS

(Union Made)

"A smile of satisfaction with every pair"

LOOK FOR THIS TICKET



*Guaranteed the best overalls you ever bought - or **MONEY BACK** after 30 days' wear.*

Larned, Carter & Co., Detroit, Mich.

WORLD'S GREATEST OVERALL MAKERS

Factories: -Detroit, Port Huron, Mich.,
St. Louis, Mo. Sarnia, Ont.

SECURITY SECTIONAL ARCH

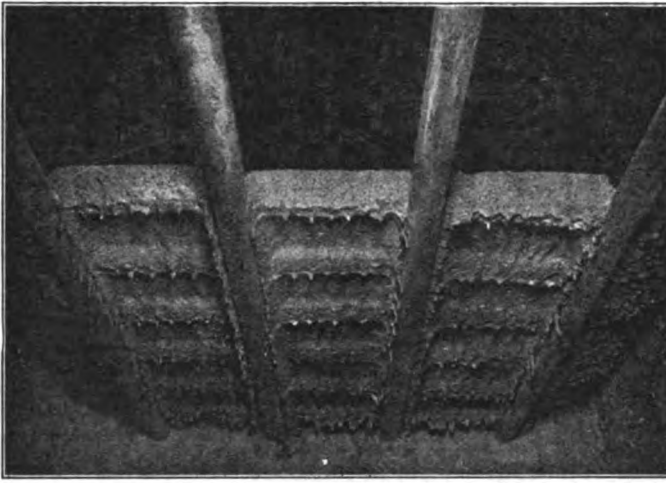

This arch is of light weight
It is built up of small sections
So made as to cool off quickly
It is easily removed for work
Made so to help the boilermaker

AMERICAN ARCH COMPANY

30 CHURCH STREET, NEW YORK

McCORMICK BUILDING, CHICAGO



Stifel's Indigo Cloth
 DATES BACK TO THE FIRST RAILROADS
 ASK FOR **OVERALLS, JUMPERS, UNIFORMS OF**
Stifel's Indigo
 STANDARD FOR OVER 75 YEARS



STIFEL'S INDIGO
 is the "fabric in-
 destructible." Will
 not fade—easy to
 wash and iron. Look
 for this trade
 mark on the back 
 of the material, on the in-
 side of garment. That's your
 guarantee of the genuine.

Cloth manufactured by

J. L. Stifel & Sons

Indigo Dyers and Printers - Wheeling, W. Va.

SALES OFFICES

- | | | | |
|-------------------------|------------------------|---------------------|----------------------------|
| New York | 260-262 Church St. | Baltimore | 114 W. Fayette St. |
| Philadelphia | 324 Market St. | St. Louis | 425 Victoria Bldg. |
| Boston | 31 Bedford St. | St. Paul | 238 Endicott Bldg. |
| Chicago | 223 West Jackson Blvd. | Toronto | 14 Manchester Bldg. |
| San Francisco | Postal Telegraph Bldg. | Winnipeg | 400 Hammond Bldg. |
| St. Joseph, Mo. | Saxton Bank Bldg. | Montreal | Room 590, 489 St. Paul St. |

The Boilermakers' Journal

Official Organ of the

**International Brotherhood of Boilermakers
Iron Ship Builders and Helpers of America**

Vol. XXVII.

KANSAS CITY, KAS., SEPTEMBER, 1915.

No. 9.

THE DEEPER UNPREPAREDNESS.

Editorial by Samuel Gompers in the
Federationist.

Now that men's minds are naturally directed towards national preparedness for self-defense, it is most fitting to consider conditions which concern national health, vigor, and development. There come to all nations, whether suddenly or with warning, those tests which prove the spirit—the power of endurance of the people.

Tests disclose weakness or strength, wisdom or folly, understanding or careless indifference. They test policies and institutions. They disclose along what lines future welfare lies. Those things which constitute preparedness for defense.

No nation can possess endurance whose citizens bear the inevitable consequences of sweat-shop labor, long workdays, low wages, insanitary conditions. Physical health and vigor affect progress along all other lines. Those who toil with their hands constitute the rank and file of the citizenship of the nations—if they are underfed, partly clothed, physically stunted, their condition is a menace to the nation whether in peace or in war. When the citizens deteriorate physically, the nation will decline. War may reveal unsuspected weakness, but that weakness will manifest itself under conditions of peace though somewhat more slowly, or worse still, less observably.

That nation whose industries exploit human workers during times of peace will be burdened by a mass of unemployable, discarded workers, and in times of war will find its existence threatened because of inability to produce supplies and because of death of fit soldiers.

Those policies and those institutions which conserve human life and which afford opportunities for the development of every citizen, constitute the greatest safeguard of the nation. The citizens must be protected, but that protection must come through their own educated initiative, so that the nation shall consist of men and women conscious of their own dignity and importance, aware of their own powers and intelligently following a course of action to promote their best interests.

Individual initiative and resourcefulness are the most valuable qualities of a nation. They must not be subordinated to the outward forms of national welfare but rather must they be the ultimate ideals of all conservation policies.

To realize these ideals the children of the nation must be assured the right to be well-born, to grow and to play. Real educational opportunities must be accessible for all and must meet the needs of all.

When maturity is reached, the individual citizens must have the right to a voice in determining the conditions under which they shall live and work and they must be assured the right to organize, to express their wills in these matters. This means that society and all its agencies must put an end to all tactics that obstruct the progress and welfare of the workers, instead of out-lawing or ostracizing labor organizations or punishing efforts of wage-earners to participate in determining conditions of work.

In war time every nation expects loyal support for its wage-earners. It expects organized co-operation in defense on the battlefield and in making munitions of war, it expects understanding of the national interests and needs. These things are equally necessary in time of peace and must be developed in times of peace; they can not be called into existence suddenly. During times of peace, workers have long demanded that their physical well-being and their labor power should be conserved and that they should be granted real freedom to organize to make these demands effective. There is not a single nation that has generously and unreservedly granted these rights to the wage-earners. By such a policy every nation assumes responsibility for national peril and foregoes its right to full and free patriotic sacrifices from its citizens.

A nation which fails to stimulate and to develop qualities which work for voluntary associated effort for the common welfare, condemns its citizens to stultifying practices and effects of compulsion. Preparedness in national resources, whether for war or peace, is secondary to the development of

national characteristics which underlie fundamental preparedness for life and growth. There must be some strong force dedicated to the cause of humanity that shall compel the incorporation of these truths in national policy—there must be industrial and humanitarian statesmanship as well as political. Even now the great industrial interests are planning to protect themselves in the convulsive shock that will come at the end of the present European war, when present currents of industry and commerce will be suddenly changed.

The citizen wage-earners of our country will be in as great need of protection as industries and commerce. Methods and policies must be devised in advance. The wage-earners are entitled to participate in determining these matters which so vitally concern them.

Will America profit from the experience of other nations and follow the highest wisdom for ensuring national preparedness and welfare?

And the men and women of labor can to a great degree answer and help to solve this vital question. They must organize, unite and federate; they must learn and practice the principles of fraternity and solidarity.

A long pull—a strong pull—a pull all together.

Now for the three million mark!

CHAIRMAN WALSH'S CHICAGO SPEECH ON THE LAWSON TRIAL.

I take the kindly spirit that prompted you to invite me here today, and this most generous and heartening reception, to be not altogether personal, of course. In fact, I hold to my heart the fact that it proceeds from the idea that I am your servant, in common with the balance of the citizens of the United States, temporarily called to fill a position that means much to the thought and welfare of this nation, small as my work may be in attempting to perform my duty in it. (Applause.)

I came here principally because this was a meeting to protest against the conviction to lifelong imprisonment of an American citizen, John R. Lawson (applause), under circumstances which must shock the conscience of every intelligent American citizen.

Many men have been convicted of murder in the first degree in this country prior and subsequent even to the conviction of John R. Lawson. The crime charged is a horrible one, the taking of human life with malice and premeditation. Apparently the courts of the country, or one, at least, has passed upon the character of that conviction, but I stand here today to present the facts in as unimpassioned a manner as the feelings of a man with red blood running through his veins permit, so that the case of John R. Lawson, beginning today, may be presented in its entirety, or as clear as may be, to the American people.

I have an official duty in connection with this matter. It was to inquire into the very heart of the cause of the situation in the State of Colorado. In order to do that, inquiry was made among those men who dug the coal; among the men who led them in their struggle for what they believed to be economic freedom and human liberty. It called upon me to demand the presence of the operators of the coal companies in the State of Colorado. The case of John R. Lawson is the case of the coal miners of Colorado and the case of the working people of America. (Applause.) The personnel of the officials of the Colorado Fuel and Iron Co. (absolute masters of the bituminous situation in the State of Colorado)—I say this advisedly, because it is declared thus over the signature of the manager of that company, L. M. Bowers, who acts for John D. Rockefeller, Jr., that "the Colorado Fuel and Iron Co. fixes the price and condition of labor in the coal mines of Colorado and every other company falls into line." The Colorado Fuel and Iron Co., dominant politically in the State of Colorado, controls not only the local coal fields, which was the theater of this great crime against John Lawson and family, but absolutely controls the votes of a supposedly sovereign people in the State of Colorado. The ruler of the Colorado Fuel and Iron Co. is John D. Rockefeller, Sr., represented by his son, John D. Rockefeller, Jr., said to be the largest investor of industrial stocks and bonds that ever lived in this world; the representative on the ground was Lamont M. Bowers, chairman of the Executive Committee of the Colorado Fuel and Iron Co. On the other side in this struggle, the United Mine Workers of America, represented by its president, Mr. White; Mr. Lord, who sits upon the platform; locally, John R. Lawson, member of the International Board; Edward L. Doyle, the secretary-treasurer in Denver, and Mr. Frank J. Hayes. I am speaking now of the largest personages that have to do with the case of John R. Lawson.

When the Commission on Industrial Relations came to the city of Denver we called upon the representatives of the Mine Workers and the representatives of the operators or presidents of all the coal companies to present to us that data which they believed would best make for a fair, honest and deep investigation of the Colorado situation. We received responses from the president of every mining company in the State of Colorado and from the representatives of the United Mine Workers of America. When Mr. Lawson and Mr. Doyle called upon me, at my hotel, they suggested that they believed that the very heart of the system existed at No. 26 Broadway, New York, and they presented to me, in person, a telegram, taken from the wire by a union operator, from John D. Rockefeller, Jr., to Jesse F. Welborn, the president of the Colorado Fuel and Iron Co., which they claimed contained

conclusive evidence that the statements given by Mr. Rockefeller before the congressional committee was incorrect and that, as a matter of fact, all of the responsibility, to the smallest executive detail, came from 26 Broadway, New York. The original of that telegram, under the power given this commission, was called forth from the manager of the Western Union Telegraph Company, and from that telegram, presented by Mr. Lawson, came the letters which this commission compelled the president of the Colorado Fuel and Iron Co. to produce. Mr. Welborn first refused to produce these letters, but after consultation with counsel they brought forth letters which called for others afterwards submitted at the New York hearing, which, in turn, gave us the data which finally brought forth the letters that told the whole story of Colorado at the last hearing of the Commission on Industrial Relations in Washington.

I believe I might truly say that I am the chief witness to the crimes for which John R. Lawson is condemned to stay in prison until God takes his soul from his body. On the face the charge is murder in the first degree. Let me state what I believe to have been the crime for which this man is convicted. After submitting this telegram he appeared on the witness stand in the city of Denver. At that time the President of our country had appointed a Board of Mediation and Conciliation, and the workers were demanding that the coal companies treat with this official body. Mr. Lawson took the stand and stated, "I have been charged with practically every crime on the calendar, ranging from violation of the Sherman anti-trust act to murder in the first degree. A commission has been appointed by the highest authority of a free people to mediate these questions that caused this deplorable situation in the State of Colorado. I, John R. Lawson, predict that the government will be defied. I have no testimony to give to this commission except this message to the government at Washington: 'Is John D. Rockefeller greater than the government? Is he higher than the law?'" That stands in the record of our Denver hearing. Again he was called to the witness stand in the City of New York. He came while the voice of the late president of Harvard still rang through the room, and for intellectual vigor, for manly conduct and for choice of expression, John R. Lawson suffered none in comparison with President Elliott. We had just heard the testimony of Mr. A. Benton Hepburn, a bank president of New York, who is one of the few men who give out the money for the Rockefeller benefactions, and member of the board of trustees of the Rockefeller Foundations, also a director in the American Agricultural Chemical Co., at that time using hired thugs to crush its workers in New Jersey. Lawson sat there and heard Tony Wiater tell his pitiful story, showing that in an industry that has prospered far

beyond any of late years the same Agricultural Chemical Co., from which perhaps a million dollars of the securities of the Rockefeller Foundations and his benefactions is taken. He heard Wiater tell his pathetic story: That working from early morning until sunset he was unable, by fourteen dollars per month, to earn enough to keep bread and butter in the mouths of his little family and clothing upon their backs. So John R. Lawson testified, perhaps with some heat of feeling. His declaration, epitomized, was this:

"The so-called great foundations of this country are not charitable in their essence. They are not distributing money honestly acquired. They are giving away the withheld wages of the American working class. Twenty thousand of my people are in the wind-swept canyons of Colorado. They have refused to accept the terms laid down by the overlords of industry, who have been testifying before you for the last few days. I have a message for Mr. Rockefeller. When I read of the giving of the \$250,000 for the establishment of a refuge for migratory birds in the South, I say, I wish to God the little children of miners of Colorado were birds. When I see again that the dollars that go to the relief of the stricken in Belgium also furnish machine guns that strike out the life of my people in Ludlow and in other cities of the mountains of Colorado; when I contemplate here, as I must, that the dollars that raise the April toll of death of children from spinal meningitis are also the dollars that bought the bullets that shot between the eyes the child of my friend, William Snyder, while he was caressing his little sister in Ludlow that day, I must cry out in protest. When I read again that an appropriation of half a million dollars is made for the investigation of the hookworm disease in China I might logically wish that my people were Chinamen instead of tolling Americans."

In my opinion, plainly and bluntly spoken, these two brave fundamental statements are the crimes for which John R. Lawson has been convicted, under the guise of a charge of murder in the first degree, in the State of Colorado.

Now, my friends, I will quote freely from the letters, the machinery for the production of which was placed in operation by John R. Lawson. They cut a great figure not only in this contest in Colorado, but as propaganda for better industrial conditions every place in America and upon the earth. I read now the famous Christmas letter of good cheer to the officials of Colorado from Mr. John D. Rockefeller, Sr., through the pen of his son. They had just been informed that non-union miners were being brought in from the East and South—from the South, of course, were the negro miners that were brought in to take the places of those men displaced by the strike in Colorado—and the response came cheerful and warm. On December 26, the day after

Christmas, this son of his father wrote that the letter was received and that he was glad to see that conditions were improving in Colorado; that his father said that he had watched with great interest all the happenings in Colorado and he expressed unusual satisfaction over the way things were going.

Now, what had happened up to that time? Nine thousand of his faithful employes had earned for him, in the comparatively few years that he controlled that company, nine million of dollars. Mark you, John D. Rockefeller, Sr., had never been there in his life and his son had been there but once. In addition to this there was added to the value of his property, according to the testimony of Mr. Rockefeller, twenty millions of dollars, which might be called unearned increment, the Rockefeller share of which would be something like nine millions of dollars. These workers who had heretofore earned for him approximately eighteen millions of dollars were in tents in the cold canyons of Colorado, where I visited with them, their wives and their children, while we were holding our hearings in the city of Denver. Jeff Fair, prior to that Christmas day, had armed a band of 400 men with firearms and explosives and turned them loose among the peaceful citizenry of the State of Colorado. He said before our commission that he didn't know these men. For all he knew, they might be red-handed murderers. Prior to the writing of the letters, Mr. Lipitt had been assassinated upon the streets of Denver, and Lee, whom they claimed to be their faithful servant and the protector of their property, had been shot from his horse while performing his duty. A child had been shot nine times through the legs, and a man killed, in the firing upon tent colonies in the coal fields; yet this man, whose son had testified that he, John D. Rockefeller, Sr., knew nothing of the situation in Colorado, that he was a retired investor that was paying no attention to business whatever, we find was shown to have had the absolute knowledge of everything that happened in Colorado and expressed unusual satisfaction to his employes on the ground.

We proceed a little toward the setting of the scenes for the day that Lawson was tried. The Rockefellers, flushed with what they believe to be their successes in Colorado, are now proceeding to wipe out union labor everywhere. This is a strong statement, but I take it from the letter to Lamont M. Bowers, that "the time is arrived to do that. Let us enlist in the cause and go forward to the campaign for the open shop in 1916, and beyond." Now, I have heard many doctrinaires, professors of political economy and so-called economists discuss the meaning of the term "open shop," but it has a definite and concrete meaning in Colorado. It means that if you are a union man you are told to go up the canyon and if you don't go you are hit over the head with a gun. So there can be no

doubt what the campaign for an open shop means when written by Lamont M. Bowers to Mr. John D. Rockefeller, Jr.

In another letter, which marks well the attitude of the Colorado Fuel and Iron Co. and the other coal companies in Colorado towards John R. Lawson and the entire industrial situation, we find reference to an article written by a Professor Stevenson of the faculty of Columbia University. We didn't go into the source of that article, whether Mr. Stevenson was paid for it or used it to get an old-age pension from the Carnegie fund. When I asked Mr. Carnegie the question as to whether or not he didn't believe that the hope for pensions on the part of the professors might warp their minds toward the economic theories of those who are going to pay the pensions, he cynically and jocularly said: "Why don't you ask Elliot? He gets one of them?" Well, I did happen to ask President Elliot, and Mr. Elliot said: "Oh, yes, they do undoubtedly influence us, but always for good."

Quoting Professor Stevenson:

"It has been said that seven hundred thousand children give up their lives annually on account of the under nourishment of themselves or their parents, due to low wages in industry. I deny," said the professor, "that the figures are correct, but assuming that they are, it proves nothing, except that the deaths of these children are a blessing. They ought never to have been born. He said further that the thing that prevents the onward march of republican institutions is the labor union, in its membership and constituency. That the members are worse than the thugs of India and are usually professional murderers. That was the kindly comment of Professor Stevenson. One month later we have a letter signed by Mr. John D. Rockefeller, Jr., addressed to Fay Lee, his publicity man, enclosing the article of Professor Stevenson and saying, "That is the soundest and most splendid presentation I ever saw of the question of capital and labor." (Laughter and applause.) "You will proceed at once to make use of it, both in the Colorado campaign and in our Union Educational Campaign."

Again, a clergyman named Newell Dwight Hillis, at present occupying Beecher's old pulpit in Brooklyn, who has this very day invited the unspeakable Carlson of Colorado to likewise preach in the Colorado situation, delivered a sermon, which has been denounced for its falsehood, first by every union man connected with the proposition, and second, by the dean of the law school, lately removed, partially on account of that, the able, aggressive and brave Professor Brewster of Colorado (applause), again by the New York Survey, and rublicly called a liar by George Creel in Harper's Weekly. In that sermon he stated that Mr. Rockefeller had offered the unions everything, even to the recognition of their union in Colorado. Mr. Rockefeller, you will re-

member, testified before the congressional commission that he was fighting for the rights of the independent American workman and that he would sacrifice every dollar of his great fortune and that of his father rather than recognize that organization. At least that is in effect what he said. Mr. Rockefeller sent this letter to Ivy Lee and asked him to make use of that in his Union Educational Campaign. Already they had published the so-called "Colorado Bulletin," setting forth the alleged facts in Colorado, which, in the main, were a collection of palpably stupid slanders upon the men that were fighting for economic freedom and the union officers who were leading their cause in the State of Colorado. After many of the lies in them had been exposed, after the president of the company had testified before the commission in Colorado as to the falsity of the bulletins, the publicity agent who wrote them was made a director in the Colorado Fuel and Iron Co., and paid six thousand dollars out of the personal account of John D. Rockefeller, Sr.

And so runs the records in Colorado. Not charged by any person connected with organized labor. Not baselessly charged by me from this platform or elsewhere, but confessed in writing by the owners and operators of the coal companies of Colorado.

Now the proof is indisputable that the Colorado Fuel and Iron Co. hired lawyers, that they controlled courts, that they controlled administrative officials such as Jeff Fair, but I want to say, my friends, that the limit of shame was reached in the Lawson case, because in that case they hired and paid for the witnesses upon whose testimony, mainly, John R. Lawson was convicted.

The chief witness in the attempt to connect John R. Lawson with the crime of murder of the deceased Mr. Nimmo were two men who, upon cross-examination, were compelled by that splendid champion of Colorado workers, Horace U. Hawkins, who is defending these men, to confess that at the time of the alleged occurrence they were pretending to be with the United Mine Workers of America, but as a matter of fact they were spies hired by the Baldwin-Feltz Detective Agency and paid by the Colorado Fuel and Iron Company and other iron companies. At the very time these cases were being prepared and were testifying, they were upon the per diem of the detective agency and were being paid for by the Colorado Fuel and Iron Co. and the other companies.

There are other matters that I might give as a background, but I have already kept you longer than I had expected. Other crimes were committed in the State of Colorado by the Colorado Fuel and Iron Co. The smothering and burning to death of women and children—all of the evidences of that terrible day at Ludlow. Why do I say

so specifically that this is a crime of the coal companies? I would hesitate to do so. Rash judgment is a bad thing. No man, especially one charged with investigatorial duty, should, in advance of his findings, or his own judgment, make such a statement. So I better tell you, as I stated before, that I speak from the letter of Lamont M. Bowers, addressed to John D. Rockefeller, Jr., telling him that they view with satisfaction the creation of another state troop that the state will not have to pay, and that, therefore, the state officials are jubilant about it. That was Troop A, consisting of the mine guards, employes and hired gunmen of the coal companies. That was the troop that, within the same week that the letter was written to John D. Rockefeller, Jr., assailed the peaceable inhabitants of Ludlow colony and committed arson, murder and robbery, and wiped certain of them from the face of the earth. That is the reason I say that that was the crime of the coal companies. Specifically, I have been criticised by Mr. Rockefeller for referring to that as the massacre of Ludlow. He pointed out that these women and children were not shot, but smothered to death. I confess that eleven of them were smothered, likewise burned, but Mr. Snyder's boy, who Monday after next is himself to be tried for murder in the first degree, was shot between the eyes by a bullet from these mine guards, while caressing his little sister; and one of the noblest of whom I have heard testimony given, Louis Likas, was slain like a dog by a hireling of the coal companies of Colorado, masquerading as a lieutenant of the state militia, although he also held a commission—K. E. Linderfelt. I call attention again to the shocking death of James Fyler, an American citizen, shot five times through the back while lying upon the ground; and the sad death of Mr. Borolotte, murdered in the presence of his wife and family, upon that same day.

It is charged, always, when facts are brought out in a field of bitter controversy, such as this contest that is now going on in industrial affairs certainly must be conceded to be, that there is something of self-interest or something of animus on the part of the investigators. God knows there has been no such feeling consciously animating my mind or moving my heart. I can not see the individuals engaged in it. I have for Mr. Rockefeller nothing but sublime pity. I read in the papers a few days ago that upon his 76th birthday he doubled the guard at Pocantico Hill; that he built a new fence inside of the old one and put a double row of barbed wire upon the top of it and proceeded to celebrate his birthday. What a pitiful situation. Another picture: Here, among her fellow citizens, maligned, charged with being a criminal, is an old lady, some 84 years old; whether right or wrong, engaged during practically all of her life in a militant contest for what she con-

scientifically believed to be right, with the love and affection of millions of her fellow citizens, free to come and go whither she will, whilst this most powerful financial potentate that ever lived upon the earth is a prisoner in a prison of his own making. I feel sorry for him, and I illustrate so that you will know that there is nothing personal in anything that has been done in this investigation, but he has been looked upon as representing the system that flouts free government, that intimidates officials, that sneers at the highest authority, as these letters show; that derides the government of a great state, and whose directors boast among themselves that they whip public officials into line and cause them to do their bidding!

I wish to close by a statement that has not been carried by the press of this nation, and that is that John D. Rockefeller, Jr., and McKenzie King, his employe, are today in open defiance of the Government of the United States. At a hearing in the city of Washington, Mr. Rockefeller was asked whether or not he wrote the statement that the press of this country carried as his testimony before the Commission on Industrial Relations. You, as the people of America, were entitled to have his testimony truthful testimony, and not the testimony of another man assuming to speak for him. McKenzie King, who was in the Colorado field, right up to the day almost of the conviction of Lawson, was asked whom he talked to and what he said and what he discovered in Colorado. He boldly refused to answer. He confessed that he had collected much data and evidence covering the situation in Colorado. He refused to tell whether that data was in Washington, New York, or the Dominion of Canada. I pressed him on all of those propositions and he point-blank refused to give that testimony to your instrumentally. We find this lapse in the law, that while the Commission on Industrial Relations has full power to compel attendance of witnesses, that yet we do not have the power to punish for contempt, and must allow these men, accompanied by Star J. Murphy, the personal attorney of Rockefeller, to throw this defiance into the very teeth of the people of the United States.

I am a believer in free institutions; I know the people have the power, if they only exercise it; I know that they have been misrepresented in the past, and you know it. Now we have a square issue made. Is the Congress of the United States representative of a sovereign people of this nation, or are they the tools and hirelings of the industrial overlords? (Applause.) If they represent the people (and I am hopeful and believe they do), then the first action of this Congress will be to cite to the bar of the House of Representatives John D. Rockefeller, Jr., John D. Rockefeller, Sr., and Mr. McKenzie King of Canada. These

questions should again be propounded to these men. They are written in our record; I have them here this afternoon. If the men refuse to answer, then they should be brought before the grand jury of the District of Columbia, as provided by the statutes of the United States, and indicted for a crime against the government and sent to jail. (Applause, shrieking and stamping of feet.)

Now, my friends, as has been said many times, better than I can say it, perhaps, as we look at the concrete case of John R. Lawson, as we read the death of an unfortunate man in one of these conflicts, our heart goes out in pity for the pain and suffering of the individual, for the miseries and woes of the wives and children of the John Lawsons, and Bortolottes and the Zancanellis of the conflict. We see there typified one case, and our attention is drawn to it, but is there not a great, dark background that ought always to loom in the consideration of these questions? Do we, as citizens, as brothers and sisters of a common humanity, do what we ought to bring about conditions from which could arise no Ludlow horror and no conviction of a Lawson? Can I imagine a system of society filled by intelligent people? May I hope, at least, for a society where every man will get what he earns, no less, and just as important, no more? That the heart-destroying, soul-shriveling, idea of production solely for dividends and profits may give way to production for the good of all mankind. (Much applause and shouts of "Hurrah!")

REPORT OF THE U. S. COMMISSION ON INDUSTRIAL RELATIONS.

(The following is a summary of recommendations contained in the first section of the Commissioners' Report, which was prepared by Mr. Basil M. Manly and approved by Commissioners Walsh, Lennon, O'Connell and Garretson.—The Editor.)

Unjust Distribution of Wealth.

The enactment of an inheritance tax so graded that while making generous provision for the support of dependents and the education of minor children, it shall leave no large accumulation of wealth to pass into hands which had no share in its production. The revenue from this tax to be reserved by the Federal Government for three principal purposes:

1. The extension of education.
2. The development of other important social services which should properly be performed by the nation which are discussed in detail elsewhere.
3. Development in co-operation with states and municipalities of great constructive works, such as road building, irrigation and reforestation, which would ma-

terially increase the efficiency and welfare of the entire nation.

There is no legislation which could be passed by Congress, the immediate and ultimate effects of which would be more salutary or would more greatly assist in tempering the existing spirit of unrest.

Unemployment and Denial of Opportunity to Earn a Living.

Certain measures for dealing with these conditions which are discussed elsewhere in the report need to be pushed forward with all possible vigor, but it may be confidently predicted that the unemployment situation will not be appreciably relieved until great advances have been made in the removal of the two prime causes—unjust distribution of wealth and monopolization of land and natural resources.

The most direct methods of dealing with the inequality of wealth have already been briefly discussed and will be considered elsewhere in the report. With respect to the land question, however, the following basic suggestions are submitted:

1. Vigorous and unrelenting prosecution to regain all land, water power and mineral rights secured from the government by fraud.

2. A general revision of our land laws, so as to apply to all future land grants the doctrine of "superior use," as in the case of water rights in California, and provision for forfeiture in case of actual non-use. In its simplest form, the doctrine of "superior use" implies merely that at the time of making the lease the purpose for which the land will be used must be taken into consideration, and the use which is of greatest social value shall be given preference.

3. The forcing of all unused land into use by making the tax on non-productive the same as on productive land of the same kind, and exempting all improvements.

The unemployed have aptly been called "the shifting sands beneath the state." Surely there is no condition which more immediately demands the attention of Congress than that of unemployment, which is annually driving hundreds of thousands of otherwise productive citizens into poverty and bitter despair, sapping the very basis of our national efficiency, and germinating the seeds of revolution.

Denial of Justice.

With full recognition of the gravity of the suggestions it seems necessary to urge the Commission to make the following recommendations:

1. That Congress should forthwith initiate an amendment to the Constitution providing in specific terms for the protection of the personal rights of every person in the United States from encroachment by the federal and state governments and by private individuals, associations and cor-

porations. The principal rights which should be thus specifically protected by the power of the federal government are the privilege of the writ of habeas corpus, the right to jury trial, free speech, peaceful assemblage, to keep and bear arms, to be free from unreasonable searches and seizures, to speedy public trial, to freedom from excessive bail, and from cruel and unusual punishments.

2. That Congress immediately enact by statute or, if deemed necessary, initiate a constitutional amendment specifically prohibiting the courts from declaring legislative acts unconstitutional.

3. That Congress enact that in all federal cases where the trial is by jury, all qualified voters in the district shall be included in the list from which jurors are selected and that they shall be drawn by the use of a wheel or other device designed to promote absolute impartiality.

4. That Congress shall drastically regulate or prohibit private detective agencies and private employment agencies doing business in more than one state, employed by a company doing an interstate business, or using the mails in connection with their business. Such regulation, if it is feasible, should include particularly the limitation of their activities to the bona fide functions of detecting crime, and adequate provision should be made for the rigid supervision of their organization and personnel.

5. That, the militia of the several states being subject to regulation by Congress, carefully drawn rules for their personnel, organization and conduct in the field should be drawn up to insure their impartiality during industrial disputes.

Denial of the Right and Opportunity to Form Effective Organizations.

1. Incorporation among the rights guaranteed by the Constitution of the unlimited right of individuals to form associations, not for the sake of profit, but for the advancement of their individual and collective interests.

2. Enactment of statutes specifically protecting this right and prohibiting the discharge of any person because of his membership in a labor organization.

3. Enactment of a statute providing that action on the part of an association of individuals not organized for profit shall not be held to be unlawful, where such action would not be unlawful in the case of an individual.

4. That the Federal Trade Commission be specifically empowered and directed by Congress in determining unfair methods of competition to take into account and specially investigate the unfair treatment of labor in all respects, with particular reference to the following points:

- (a) Refusal to permit employes to become members of labor organizations.

(b) Refusal to meet or confer with the authorized representatives of employes.

5. That the Department of Labor, through the Secretary of Labor or any other authorized official, be empowered and directed to present to the Federal Trade Commission, and to prosecute before that body, all cases of unfair competition arising out of the treatment of labor which may come to his attention.

6. That such cases, affecting as they do the lives of citizens in the humblest circumstances, as well as the profits of competitors and the peace of the community, be directed by Congress to have precedence over all other cases before the Federal Trade Commission.

Widespread existence of living and working conditions in American industry that menace the nation's welfare by denying proper standards of living to millions of its citizens, and by making them subservient to the wills of employers who control their opportunities for labor, are set forth in the final report of Basil M. Manly, Director of Research and Investigation for the United States Commission on Industrial Relations.

The Commission today made public the first section of the Manly report. The remaining sections will be made public as soon as they leave the hands of the printer, and the report in full will then be transmitted to Congress. It was accepted and ordered printed by resolution of the full Commission, and is signed by Frank P. Walsh, Chairman of the Commission, and by Commissioners John B. Lennon, James O'Connell and Austin B. Garretson.

As a paramount necessity, if the nation is to remedy the evils found to exist by the Commission's staff, the report urges action that will remove the "many existing obstacles which prevent effective organization and co-operation" by wage-earners, and that will thereby bring about a democratic organization of industry along the lines of trade union activity.

The crux of the whole question of industrial relations is declared to be "shall the workers, for the protection of their interests, be organized and represented collectively by their chosen delegates, even as the stockholders are represented by their directors and by the various grades of executive officials and bosses."

Mr. Manly's report is based on the research and field work of members of the staff, whose point of view is that of impartial investigators, and upon testimony at the public hearings conducted by the Commission in fourteen principal cities and industrial centers of the United States. These hearings occupied in all 154 days and a total of 740 witnesses were heard. Of these, 230 were affiliated with employers, 245 with labor and 265 were not affiliated with either group. Where interests are af-

fecting, statements of fact are based entirely on the testimony of those witnesses whose interests might be regarded as adversely affected.

Action Is Imperative.

In an introductory statement, Congress and the public are urged to regard the question of industrial relations as "more fundamental and of greater importance to the welfare of the nation than any other question except that of our government."

"The only hope for the solution of the tremendous problems created by industrial relationship," says the report, "lies in the effective use of our democratic institutions and the rapid extension of the principles of democracy to industry."

The immediate effects of the form and character of industrial organization are held to be "greater and closer to the lives and happiness of all classes of citizens than even the form and character of our political institutions."

"The ordinary man," it is pointed out, "whether employer or worker, has relatively little contact with the government. If he and his family are well-fed, well-housed and well-clothed, and if he can pay for the education of his children, he can exist even under an autocratic monarchy with little concern until some critical situation develops in which his own liberty is interfered with or until he is deprived of life or property by the overwhelming power of his tyrannical ruler. But his industrial relations determine every day what he and his family shall eat, what they shall wear, how many hours of his life he shall labor and in what surroundings. Under certain conditions where his individual or corporate employer owns or controls the community in which he lives, the education of his children, the character and prices of his food, clothing and house, his own actions, speech and opinions, and in some cases even his religion, are controlled and determined, insofar as the interests of the employer make it desirable for him to exercise such control. Such conditions are established and maintained not only through the dictation of all working conditions of employment by the employer, but by his usurpation or control of the functions and machinery of political government in such communities.

"In the available time it has been impossible to ascertain how general such conditions are, but it is clearly indicated by the investigations that in isolated industrial, mining or agricultural communities, which are owned or controlled by single individuals or corporations, and in which the employes are unorganized, industrial feudalism is the rule rather than the exception.

"In such communities democratic government does not as a rule exist, except in name or form, and as a consequence there now exist within the body of our republic petty industrial communities, which are vir-

small principalities, oppressive to those dependent upon them for a livelihood and a dreadful menace to the peace and welfare of the nation.

"Such conditions as these are the direct and inevitable consequence of the industrial relations which exist in such communities. Political freedom can exist only where there is industrial freedom; political democracy only where there is industrial democracy.

"Such industrial democracy has been established in a greater or less degree in certain American industries or for certain classes of employes. But between such conditions of industrial democracy and industrial feudalism, there are almost infinite gradations marking the stages of evolution which have been reached. In every case, however, investigation has shown that the degree of political freedom and democracy which exists is conditioned by the industrial status of the citizens who form the majority of the community."

Political Liberties at Stake.

"The problems of industrial relations, therefore, demand the attention of Congress, not only because they determine the life, security and happiness of the twenty-five million citizens of the United States who occupy the position of wage-earners, but because they affect for good or evil the government of localities and states, and to a smaller degree that of the nation itself. What each of these wage-earners shall eat, what he shall wear, where he shall live, and how long and under what conditions he shall labor are determined by his industrial status and by his relation individually or collectively to the person or corporation employing him. Similarly and almost as directly, this relationship determines whether the machinery of government shall be used for or against his welfare, whether his vote shall count for or against his own interest, whether he shall be tried by a jury of his peers or a jury selected in collusion with the employing company, or, under conditions of so-called martial law, by no jury whatever; whether in fact he shall be a free man or be deprived of every right guaranteed by federal and state constitutions, imprisoned without warrant for the commission of crimes of which he may be innocent, or forcibly deported from the community or state in which he has made his home. For these reasons, it seems desirable at the outset to suggest a recommendation to Congress that these problems of industrial relationship should occupy their due prominence in the deliberations of that Honorable Body, and that the entire machinery of the federal government should be utilized to the greatest possible degree for the correction of such deplorable conditions as have been found to exist.

"The lack of a proper industrial relationship and the existence of bad labor conditions is a matter of the most serious moment

during times of peace, but the events of the past year have demonstrated how enormously their menace to the welfare of a nation is increased during a period of war. The present European war is being fought on the farms and in the factories as much as in the trenches. The effective mobilization of our industrial resources is as important simply from the standpoint of war, as the mobilization of our military and naval forces.

"It is equally important that action should be taken now rather than after war is a reality.

"An attempt is made in the succeeding pages of the report to suggest some of the measures which should be adopted, with a full realization, however, that no action will be effective which does not come through an understanding by the American people of the essential facts regarding industrial conditions. Practically, however, there are only two alternatives for effective action, first, the creation of a huge system of bureaucratic paternalism such as has been developed in Germany; or action which will remove the many existing obstacles which prevent effective organization and co-operation, reserving for performance by the government only those services which cannot be effectively conducted by voluntary organizations, and those which are of such vital importance to the entire nation that they should not be left to the hazard of private enterprise."

The introductory statement closes with the following quotation from Carlyle, the Scotch historian, which, it asserts, "contains in a few eloquent sentences the very heart of the situation in American industry":

"With the working people, again, it is not so well. Unlucky. For there are from twenty to twenty-five millions of them. Whom, however, we lump together into a kind of dim compendious unity * * *, as 'the masses.' Masses indeed; and yet, singular to say, the masses consists all of units, * * *, every unit of whom has his own heart and sorrows; stands covered there with his own skin, and if you prick him he will bleed. Every unit of these masses is a miraculous man, even as thou thyself art; struggling with vision or with blindness for his infinite kingdom (this life which he has got, once only, in the middle of eternities); with a spark of the divinity, what thou callest an immortal soul, in him!

"Clearly a difficult 'point' for government, that of dealing with these masses; if indeed it be not rather the sole point and problem of government, and all other point mere accidental crotchets, superficialities, and beatings of the wind! For let charter-vests, use and wont, law common and special say what they will, the masses count to so many millions of units; made, to all

appearances, by God, whose earth this is declared to be."

That section of the report made public today deals almost entirely with the causes of industrial unrest.

Causes of Unrest.

The report finds that the causes of industrial unrest "group themselves almost without exception under four main sources which include all the others. These four are:

"1. Unjust distribution of wealth and income.

"2. Unemployment and denial of opportunity to earn a living.

"3. Denial of justice in the creation, in the adjudication and in the administration of law.

"4. Denial of the right and opportunity to form effective organizations."

Unjust Distribution.

Discussing the first of these causes, the report summarizes evidence showing that 44 families possess aggregate incomes totaling at the least fifty millions per year, while between one-fourth and one-third of male workers in factories and mines, 18 years of age and over, earn less than \$10.00 per week, and only about one-tenth earn more than \$20 per week.

Inequality in the distribution of wealth and income is set forth as follows:

"First, with regard to the adult workmen, the fathers and potential fathers, from whose earnings according to the 'American standard,' the support of the family is to be derived.

"Between one-fourth and one-third of male workers in factories and mines 18 years of age and over earn less than \$10 per week; from two-thirds to three-fourths earn less than \$15, and only about one-tenth earn more than \$20 a week. This does not take into consideration lost working time for any cause.

"Next are the women, the most portentously growing factor in the labor force, whose wages are important, not only for their own support or as the supplement of the meager earnings of their fathers and husbands, but because through the force of competition in a rapidly extending field, they threaten the whole basis of the wage scale. From two-thirds to three-fourths of women workers in factories, stores, laundries, and in industrial occupations generally, work at wages of less than \$8 a week. Approximately one-fifth earn less than \$4 and nearly one-half earn less than \$6 a week.

Plight of the Underpaid.

"Six dollars a week—what does it mean to many? Three theater tickets, gasoline for the week, or the price of a dinner for two; a pair of shoes, three pairs of gloves, or the cost of an evening at bridge. To the

girl it means that every penny must be counted, every normal desire stifled, and each basic necessity of life barely satisfied by the sacrifice of some other necessity. If more food must be had than is given with 15-cent dinners, it must be bought with what should go for clothes; if there is need for a new waist to replace the old one at which the forewoman has glanced reproachfully, or at which the girls have giggled, there can be no lunches for a week, and dinners must cost five cents less each day. Always too the room must be paid for, and back of it lies the certainty that with slack seasons will come lay-offs and discharges. If the breaking point has come, and she must have some amusement, where can it come from? Surely not out of six dollars a week.

"Last of all are the children, for whose petty addition to the stream of production the nation is paying a heavy toll in ignorance, deformity of body or mind, and premature old age. After all, does it matter much what they are paid, for all experience has shown that in the end the father's wages are reduced by about the amount that the children earn. This is the so-called 'family wage,' and examination of the wages in different industries corroborates the theory that in those industries, such as textiles, where women and children can be largely utilized, the wages of men are extremely low.

"The competitive effect of the employment of women and children upon the wages of men, can scarcely be overestimated. Surely it is hard enough to be forced to put children to work, without having to see the wages of men held down by their employment.

"This is the condition at one end of the social scale; what is at the other?

"Massed in millions, at the other end of the social scale, are fortunes of a size never before dreamt of, whose very owners do not know the extent, nor without the aid of an intelligent clerk, even the sources of their incomes. Incapable of being spent in any legitimate manner, these fortunes are burdens, which can only be squandered, hoarded, put into so-called 'benefactions,' which for the most part constitute a menace to the state, or put back into the industrial machine to pile up ever-increasing mountains of gold.

Rewards Only for Service.

"In many cases, no doubt, these huge fortunes have come in whole or in part, as the rich reward of exceptional service. None would deny or envy him who has performed such service the richest of rewards, although one may question the ideals of a nation which rewards exceptional service only by burdensome fortunes. But such reward can be claimed as a right only by those who have performed service, not by those who through relationship or mere parasitism chance to be designated as heirs.

"Legal right, of course, they have by vir-

tue of the law of inheritance, which, however, runs counter to the whole theory of American society, and which was adopted, with important variations from the English law without any conception of its ultimate results and apparently with the idea that it would prevent exactly the condition which has arisen.

Inheritance Law Condemned.

"In effect the American law of inheritance is as efficient for the establishment and maintenance of families as the English law, which has bulwarked the British aristocracy through the centuries. Every year, indeed, sees this tendency increase, as the creation of 'estates in trust' secures the ends which might be more simply reached, if there were no prohibition of 'entail.'

"According to the income tax returns for ten months of 1914, there are in the United States 1,598 fortunes yielding an income of \$100,000 per year or over. Practically all of these fortunes are so invested and hedged about with restrictions upon expenditure that they are, to all intents and purposes, perpetuities.

"An analysis of fifty of the largest American fortunes shows that nearly half have already passed to the control of heirs or to trustees (their vice regents), and that the remainder will pass to the control of heirs within 20 years upon the deaths of the 'founders.' Already, indeed, these founders have almost without exception retired from active service, leaving the management ostensibly to their heirs, but actually to executive officials upon salary.

Some Striking Figures.

"We have, according to the income tax returns, 44 families with incomes of \$1,000,000 or more, whose members perform little or no useful service, but whose aggregate incomes, totalling at the least fifty millions per year, are equivalent to the earnings of 100,000 wage earners, at the average rate of \$500.

"Between the two extremes of superfluity and poverty is the large middle class, farmers, manufacturers, merchants, professional men, skilled artisans, and salaried officials whose incomes are more or less adequate for their legitimate needs and desires, and who are rewarded more or less exactly in proportion to service. They have problems to meet in adjusting expenses to income, but the pinch of want and hunger is not felt, nor is there the deadening, devitalizing effect of superfluous, unearned wealth.

"From top to bottom of society, however, in all grades of incomes are an innumerable number of parasites of every conceivable type. They perform no useful service, but drain off from the income of the producers a sum whose total cannot be estimated.

"Beside the economic significance of these great inequalities of wealth and income, there is a social aspect which equally merits the attention of congress. It has been shown that the great fortunes of those who have profited by the enormous expansion of American industry have already or will

in a few years pass by right of inheritance to the control of heirs or to trustees who act as their 'vice regents.' They are frequently styled by our newspapers 'monarchs of industry,' and indeed occupy within our republic a position almost exactly analogous to that of feudal lords.

"These heirs, owners only by virtue of the accident of birth, control the livelihoods and have the power to dictate the happiness of more human beings than populated England in the middle ages. Their principalities, it is true, are scattered and, through the medium of stock-ownership, shared in part with others; but they are none the less real. In fact, such scattered, invisible industrial principalities are a greater menace to the welfare of the nation, than would be equal power consolidated into numerous petty kingdoms in different parts of the country. They might then be visualized and guarded against—now their influence invisibly permeates and controls every phase of life and industry.

"'The king can do no wrong' not only because he is above the law, but because every function is either performed or responsibility assumed by his ministers and agents. Similarly, our Rockefellers, Morgans, Fricks, Vanderbilts and Astors can do no industrial wrong, because all effective action and direct responsibility is shifted from them to the executive officials who manage American industry.

Quotes Rockefeller.

"The similitude, indeed, runs even to mental attitude and phase. Compare these two statements:

"John D. Rockefeller, Jr.—'My appreciation of the conditions surrounding wage-earners and my sympathy with every endeavor to better these conditions are as strong as those of any men.'

"Louis XVI.—'There is none but you and me that has the people's interest at heart.' ('Il n'y a que vous et moi qui aimons le peuple.')

"The 'families' of these industrial princes are already well established and are knit together not only by commercial alliances, but by a net work of inter-marriages which assure harmonious action whenever their common interest is threatened.

"Effective action by congress is required, therefore, not only to readjust on a basis commensurate in some measure to the service performed, the existing inequalities in the distribution of wealth and income, but also to check the growth of an hereditary aristocracy, which is not only foreign to every conception of American Government, but menacing to the welfare of the people and the existence of the nation as a democracy.

"The objects to be attained in making this readjustment are: to reduce the swollen, unearned fortunes of those who have a superfluity; to raise the underpaid masses to a level of decent and comfortable living; and at the same time to accomplish this on a basis which will, in some measure, ap-

proximate the just standard of income proportional to service."

Inheritance Tax a Remedy.

As a remedy for the unequal distribution of wealth and income, the report urges "the enactment of an inheritance tax so graded that while making generous provision for the support of dependents and the education of minor children, it shall leave no large accumulation of wealth to pass into hands which had no share in its production. The report suggests that a limit of one million dollars be fixed on the amount that shall pass to the heirs. It recommends that the revenue from this tax be reserved by the federal government for three principal purposes:

1. The extension of education.
2. The development of other important social services which should properly be performed by the nation which are discussed in detail elsewhere.
3. Development in co-operation with states and municipalities of great constructive works, such as road building, irrigation and reforestation, which would materially increase the efficiency and welfare of the entire nation.

"There is no legislation," says the report, "which could be passed by congress, the immediate and ultimate effects of which would be more salutary or would more greatly assist in tempering the existing spirit of unrest."

Denial of Opportunity.

Discussing unemployment and denial of opportunity to earn a living as the second principal cause of industrial unrest, the report makes the following recommendations:

"Certain measures for dealing with these conditions which are discussed elsewhere in the report need to be pushed forward with all possible vigor, but it may be confidently predicted that the unemployment situation will not be appreciably relieved until great advances have been made in the removal of the two prime causes—unjust distribution of wealth and monopolization of land and natural resources.

"The most direct methods of dealing with the inequality of wealth, have already been briefly discussed and will be considered elsewhere in the report. With respect to the land question, however, the following basic suggestions are submitted:

"1. Vigorous and unrelenting prosecution to regain all land, water power and mineral rights secured from the government by fraud.

"2. A general revision of our land laws, so as to apply to all future land grants the doctrine of 'superior use,' as in the case of water rights in California, and provision for forfeiture in case of actual non-use. In its simplest form the doctrine of 'superior use' implies merely that at the time of making the lease the purpose for which the land will be used must be taken into consideration, and the use which is of greatest social value shall be given preference.

"3. The forcing of all unused land into

use by making the tax on non-productive the same as on productive land of the same kind, and exempting all improvements.

"The unemployed have aptly been called 'the shifting sands beneath the state.' Sure'y there is no condition which more immediately demands the attention of congress than that of unemployment, which is annually driving hundreds of thousands of otherwise productive citizens into poverty and bitter despair, sapping the very basis of our national efficiency, and germinating the seeds of revolution."

Denial of Justice.

Under the head "Denial of Justice," found to be the third principal cause of unrest, the report cites numerous typical instances to prove the following charges:

First, with regard to the enactment of laws, it is charged that the workers have been unable to secure legislation to protect them against grievous wrongs except after exhausting struggles against overwhelming odds and against insidious influences.

Second, it is charged that after wholesome and necessary laws are passed, they are in large part nullified by the courts upon technicalities of a character which would not be held to invalidate legislation favorable to the interests of manufacturers, merchants, bankers, and other property owners, or thrown out on the broad ground of unconstitutionality through strained or illogical construction of constitution provisions.

Third, that in the administration of law, both common and statute, there is discrimination by the courts against the poor and in favor of the wealthy and powerful, and that this discrimination arises not only from the economic disabilities of the poor, but also out of the actual bias on the part of the judges in favor of the wealthy and influential.

Fourth, that courts have not only neglected or refused to protect workers in the rights guaranteed by the constitution of the United States, and of the several states, but that sections of the constitution framed primarily to protect human rights have been perverted to protect property rights only, and to deprive workers of the protection of rights secured to them by statutes.

Fifth, that the ordinary legal machinery provides no adequate means whereby laborers and other poor men can secure redress for wrongs inflicted upon them through the non-payment of wages, through overcharges at company stores, through exorbitant hospital and other fees, fines and reductions, through fraud on the part of private employment offices, loan offices and installment houses, and through the "grafting" of foremen and superintendents. The losses to wage earners from these sources are stated to amount each year to millions of dollars and to work untold hardship on a class of men who can ill afford to lose even a penny of their hard won earnings.

Sixth, that the courts, by the unwarranted

extension of their powers in the issuance of injunctions, have not only grievously injured the workers individually and collectively, upon innumerable occasions, but have also, by the contempt procedure consequent upon disobedience to such injunctions, deprived the workers of the right, fundamental to Anglo Saxon institutions, to be tried by jury.

Seventh, that laws designed for the protection of labor in workshops, mines and on railroads are not effectively enforced except in a few states.

Eighth, that in cases involving industrial questions the workers are liable to great injustice by reason of the fact that in many localities they are excluded from juries either by the qualifications prescribed (usually payment of property tax) or by the method of selection.

Ninth, that during strikes, innocent men are in many cases arrested without just cause, charged with fictitious crimes, held under excessive bail, and treated frequently with unexampled brutality for the purpose of injuring the strikers and breaking the strike.

Tenth, that in many localities during strikes not only is one of the greatest functions of the state, that of policing, turned virtually over to employers or arrogantly assumed by them, but criminals employed by detective agencies and strike breaking agencies are clothed by the process of deputization, with arbitrary power and relieved of criminal liability for their acts.

Eleventh, that during strikes in many localities the entire system of civil government is suspended and there is set up in its place a military despotism under so-called martial law.

Twelfth, that in some localities the control by the employers of the entire machinery of government is so great that lawless acts on the part of agents of the employers go unheeded and unpunished, while vindictive action against the leaders of the strike is accomplished by methods unparalleled in civilized countries.

In each instance what Mr. Manly considers convincing proof that these charges are fully justified is cited in the form of testimony before the commission setting forth specific cases, the facts of which are admitted by all concerned. Evidence gathered in the commission's investigation of the Colorado strike is cited in substantiation of the twelfth charge.

The report says regarding remedies:

"In considering the action which needs to be taken it has been urged by some that the end to be achieved is to place personal rights on a parity with property rights. It is necessary to render a firm protest and warning against the acceptance of such an ideal. The establishment of property rights and personal rights on the same level can leave only a constant and ever growing menace to our popular institutions. With the acceptance of such an ideal

our democracy is doomed to ultimate destruction. Personal rights must be recognized as supreme and of unalterable ascendancy over property rights.

"Relief from these grave evils cannot be secured by petty reforms. The action must be drastic and directed at the roots from which these evils spring.

"With full recognition of the gravity of the suggestions it seems necessary to urge the commission to make the following recommendations:

"1. That congress should forthwith initiate an amendment to the Constitution providing in specific terms for the protection of the personal rights of every person in the United States from encroachment by the federal and state governments and by private individuals, associations and corporations. The principal rights which should be thus specifically protected by the power of the federal government are the privilege of the writ of habeas corpus, the right to jury trial, free speech, peaceful assemblage, to keep and bear arms, to be free from unreasonable searches and seizures, to speedy public trial, to freedom from excessive bail, and from cruel and unusual punishments.

22. That congress immediately enact by statute or, if deemed necessary, initiate a constitutional amendment specifically prohibiting the courts from declaring legislative acts unconstitutional.

"3. That congress enact that in all federal cases where the trial is by jury all qualified voters in the district shall be included in the list from which jurors are selected and that they shall be drawn by the use of a wheel or other device designed to promote absolute impartiality.

"4. That congress should drastically regulate or prohibit private detective agencies doing business in more than one state, employed by a company doing an interstate business, or using the mails in connection with their business. Such regulation, if it is feasible, should include particularly the limitation of their activities to the bona fide functions of detecting crime, and adequate provision should be made for the rigid supervision of their organization and personnel.

"5. That, the militia of the several states being subject to regulation by congress, carefully drawn rules for their personnel, organization and conduct in the field should be drawn up to insure their impartiality during industrial disputes."

Right to Organize.

Evidence and testimony are cited showing that many employers refuse to deal with organizations of their employes or to employ men who belong to labor organizations, this denial of the right of organization being discussed as the fourth principal cause of industrial unrest. The report says:

"The previous discussion of the causes of industrial unrest has dealt with the denial of certain fundamental objects to which the workers believe they have natural and in-

alienable rights, namely, a fair distribution of the products of industry, the opportunity to earn a living, free access to unused land and natural resources, and just treatment by legislators, courts and executive officials.

"A more serious and fundamental charge is, however, contained in the allegation by the workers that, in spite of the nominal legal right which has been established by a century-long struggle, almost insurmountable obstacles are placed in the way of their using the only means by which economic and political justice can be secured, namely, by combined action through voluntary organization.

"The workers insist that this right of organization is fundamental and necessary for their freedom, and that it is inherent in the general rights guaranteed every citizen of a democracy. They insist that people can free themselves from oppression only by organized force. No people could gain or maintain their rights or liberties acting singly, and any class of citizens in the state subject to unjust burdens or oppression can gain relief only by combined action."

"The demand for organization and collective action has been misunderstood, it is claimed, because of the belief among a large number of citizens that its purpose was simply to secure better wages and better physical conditions. It has been urged, however, by a large number of witnesses before the commission that this is a complete misconception of the purpose for which workers desire to form organizations.

Not a Material Struggle.

"It has been pointed out with great force and logic that the struggle of labor for organization is not merely an attempt to secure an increased measure of the material comforts of life, but it is a part of the age-long struggle for liberty; that this struggle is sharpened by the pinch of hunger and the exhaustion of body and mind by long hours and improper working conditions; but that even if men were well fed they would still struggle to be free.

"It is not denied that the exceptional individual can secure an economic sufficiency either by the sale of his unusual ability or talent, or by sycophantic subservience to some person in authority, but it is insisted that no individual can achieve freedom by his own efforts. Similarly, while it is admitted that in some cases exceptional employers treat their employes with the greatest justice and liberality, it is held to be a social axiom that no group of workers can become free except by combined action, nor can the mass hope to achieve any material advance in their condition except by collective effort.

"Furthermore, it is urged by the representatives of labor that the efforts of individuals who are bent upon bettering their own condition without reference to their health or to the interests of others, directly injure each of their fellow workers and indirectly weaken the whole fabric of society.

Bargaining Equality Lacking.

"It is also pointed out that the evolution of modern industry has greatly increased the necessity for organization on the part of wage earners, while it is not admitted that the employer who has only one employe is on an economic equality with the person who is employed by him, because of the fact that the employer controls the means of livelihood which gives him an almost incalculable advantage in any bargain, nevertheless this condition of inequality is held to have been enormously increased by the development of corporations controlling the livelihood of hundreds of thousands of employes, and by the growth of employers' associations whose members act as a unit in questions affecting their relations with employes."

The report points out that less than half a dozen employers out of 230 employers or their agents who have testified before the commission, have denied the propriety of collective action on the part of employes, but that many maintained "what they, in accordance with common terminology, called 'open shop.'"

Meaning of "Open Shop."

Of the open shop the report says: "The theory of the 'open shop,' according to these witnesses, is that workers are employed without any reference to their membership or non-membership in trade unions; while, as a matter of fact, it was found upon investigation that these employers did not willingly or knowingly employ union men. Nevertheless, this is deemed to be a minor point. The 'open shop,' even if union men are not discriminated against, is as much a denial of the right of collective action as is the "anti-union shop." In neither is the collective action of employes permitted for the purpose of negotiating with reference to labor conditions. Both in theory and practice, in the absence of legislative regulation, the working conditions are fixed by the employer

"It is evident, therefore, that there can at best be only a benevolent despotism where collective action on the part of employes does not exist."

Discussing the attitude of employers who refuse to deal collectively with their workmen, but who do in fact grant audiences at which the grievances of their workmen may be presented, the report says:

"One is repelled rather than impressed by the insistence with which this idea has been presented. Every tyrant in history has on stated days granted audiences to which his faithful subjects might bring their complaints against his officers and agents. At these audiences, in theory at least, even the poorest widow might be heard by her sovereign in her search for justice. That justice was never secured under such conditions, except at the whim of the tyrant, is sure. It is equally sure that in industry, justice can never be attained by such a method."

The willingness of certain employers to deal with their own employes collectively, while refusing to deal with any national organization, and resenting the intrusion of any persons acting for their employes who are not members of their own labor force, is dealt with in the following:

"In practice these statements have been generally found to be specious. Such employers as a rule oppose any effective form of organization among their own employes as bitterly as they fight the national unions. The underlying motive of such statements seems to be only that as long as organizations are unsupported from outside they are ineffective and can be crushed with ease and impunity by discharging the ringleaders. Similarly, that opposition to the representation of their employes by persons outside their labor force, seems to arise wholly from the knowledge that as long as the workers' representatives are on the payroll they can be controlled, or, if they prove intractable, they can be effectually disposed of by summary dismissal.

Advance Must Be Uniform.

"To suggest that labor unions can be effective if organized on less than a national scale, seems to ignore entirely the facts and trend of present-day American business. There is no line of organized industry in which individual establishments can act independently. Ignoring for the time the centralization of control and ownership, and also the almost universal existence of employers' associations, the mere fact of competition would render any organization of employes which was limited to a single establishment totally ineffective. Advance in labor conditions must proceed with a fair degree of uniformity throughout any line of industry. This does not indeed require that all employes in an industry must belong to a national organization, for experience has shown that wherever even a considerable portion are union members, the advances which they secure are almost invariably granted by competitors, even if they do not employ union men, in order to prevent their own employes from organizing."

That political freedom cannot exist where the right to organize is denied, and that such denial therefore threatens the political institutions of the nation, is charged by Mr. Manly in concluding his discussion of this subject.

The conclusions and recommendations designed not only to prevent denial of the right to organize, but to guarantee this right are set forth as follows:

"The conclusions upon this question, however are not based upon theory, but upon a thorough investigation of typical situations in which the contrast between organization and the denial of the right of organization could best be studied. The commission has held public hearings and has made thorough investigations in such industrial communities as Paterson, New Jersey; Los Angeles, California; Lead, South

Dakota, and Colorado, where the right of collective action on the part of employers is denied. These investigations have shown that under the best possible conditions, and granting the most excellent motives on the part of employers, freedom does not exist either politically, industrially or socially, and that the fiber of manhood will inevitably be destroyed by the continuance of the existing situation.

"Investigations have proved that although the physical and material conditions may be unusually good, as, for example, in Lead, S. D., they were the price paid for the absolute submission of the employes to the will of the employing corporation. Such satisfactory conditions are, however, shown by the hearings of the commission and by the investigations of its staff to be exceptional.

Effect of "Open Shop."

Los Angeles, for example, although exceptionally endowed in location, climate and natural resources, was sharply criticised for the labor conditions which had developed during its 'open shop' regime even by Mr. Walter Drew, representing several of the largest associations which contend for the 'open shop.' It is significant that the only claim ordinarily made for the conditions in such establishments is that 'they are as good as are secured by the union.' As a matter of fact, there are few establishments which make this boast, and in the majority the conditions were found to be far below any acceptable standards.

"The commission has also, through public hearings and the investigations of its staff, made a thorough and searching investigation of the conditions in those industries and establishments where collective action through the medium of trade unions, and joint agreements, exists. It has not been found that the conditions in such industries are ideal and that friction between employers and the unions is unknown; nor has it been found that the employes in such industries have entirely achieved economic, political or industrial freedom, for these ideals cannot be gained until the fundamental changes in our political and economic structure, which have already been referred to, have in some way been accomplished.

Friction Reduced.

"It has been found, however, that the material conditions of the workers in such industries and establishments are on a generally higher plane than where workers are unorganized; that important improvements in such conditions have been achieved as the direct result of organization; that the friction which exists in such industries and establishments has been reduced rather than increased by organization; and that the workers at least have established a basis upon which their political and economic freedom may ultimately be established.

Discusses Union Evils.

"The evils of graft, 'machine politics,' factional fights and false leadership, which

have been found sometimes to exist in such organized industries, are those which are inevitable in any democratic form of organization. They are the same evils which have accompanied the development of the American nation, and of its states and municipalities. Such evils as have been found to exist are indeed to be condemned, but a study of the history of these organizations seems to show clearly that there is a tendency to eradicate them as the organizations become stronger and the membership becomes more familiar with the responsibilities and methods of democratic action.

"Furthermore, there is a fundamental principle which applies in this field as in all other lines of human activity. This principle is contained in the following contrast: In democratic organizations such evils and excesses as may arise tend to disrupt and destroy the organization and are therefore self-eradicating; while in an autocracy, evils and excesses tend inevitably to strengthen the existing autocrat and can be eradicated only in the event of a revolt on the part of those who suffer from such evils. This is the history, not only of every form of artificial association, but also of nations.

"The fundamental question for the nation to decide, for in the end public opinion will control here as elsewhere, is whether the workers shall have an effective means of adjusting their grievances, improving their condition, and securing their liberty, through negotiation with their employers, or whether they shall be driven by necessity and oppression to the extreme of revolt.

"Where men are well organized, and the power of employers and employes is fairly well balanced, agreements are nearly always reached by negotiations; but, even if this fails, the strikes or lockouts which follow are as a rule merely cessations of work until economic necessity forces the parties together again to adopt some form of compromise.

"With the unorganized, there is no hope of achieving anything except by spontaneous revolt. Too often has it been found that during the delay of attempted negotiations, the leaders are discharged, and new men are found ready to take the place of those who protest against conditions. Without strike funds or other financial support, the unorganized must achieve results at once; they cannot afford to wait for reason and compromise to come into play. Lacking strong leaders and definite organization, such revolts can only be expected to change to mob action on the slightest provocation.

Many Strikes Actual Revolutions.

"Looking back over the industrial history of the last quarter century, the industrial disputes which have attracted the attention of the country and which have been accompanied by bloodshed and violence, have been revolutions against industrial oppression, and not mere strikes for the improvement of working conditions.

"Such revolutions in fact were the rail-

way strikes of the late eighties, the Homestead strike, the bituminous coal strike of 1897, the anthracite strikes of 1900 and 1903, the strike at McKees Rocks in 1909, the Bethlehem Steel Co. strike of 1910, the strikes in the textile mills at Lawrence, Paterson and Little Falls, many of the strikes in the mining camps of Idaho and Colorado, the garment workers' strikes in New York and other cities, and the recent strikes in the mining districts of West Virginia, Westmoreland County, Pennsylvania, and Calumet, Michigan.

Action Is Urged.

"As a result, therefore, not only of fundamental considerations, but of practical investigations, the results of which are described in detail hereafter, the Commission is convinced that every means should be used to extend and strengthen organizations throughout the entire industrial field. Much attention has been devoted to the means by which this can best be accomplished, and a large number of suggestions have been received. As a result of careful consideration, it is suggested the Commission recommend the following action:

"1. Incorporation among the rights guaranteed by the Constitution of the unlimited right of individuals to form associations, not for the sake of profit, but for the advancement of their individual and collective interests.

"2. Enactment of statutes specifically protecting this right and prohibiting the discharge of any person because of his membership in a labor organization.

"3. Enactment of a statute providing that action on the part of an association of individuals not organized for profit shall not be held to be unlawful, where such action would not be unlawful in the case of an individual.

"4. That the Federal Trade Commission be specifically empowered and directed by Congress in determining unfair methods of competition to take into account and specially investigate the unfair treatment of labor in all respects, with particular reference to the following points.

"(a) Refusal to permit employes to become members of labor organizations.

"(b) Refusal to meet or confer with the authorized representatives of employes.

"5. That the Department of Labor, through the Secretary of Labor or any other authorized official, be empowered and directed to present to the Federal Trade Commission, and to prosecute before that body, all cases of unfair competition arising out of the treatment of labor which may come to his attention.

"6. That such cases, affecting, as they do, the lives of citizens in the humblest circumstances, as well as the profits of competitors and the peace of the community, be directed by Congress to have precedence over all other cases before the Federal Trade Commission."

THE BOILER MAKERS' JOURNAL

Official Organ of the International Brotherhood of Boiler Makers, Iron Ship Builders and Helpers of America.

A Monthly Publication Issued the First of Each Month from Room 8, Law Building, Kansas City, Kansas.

JAMES B. CASEY, Editor and Manager.

Subscription Price.....\$1.00 Per Year in Advance

ADVERTISEMENTS.

Advertising Rates Will be Furnished Upon Application to the Editor-Manager. No Reading Space Will be Sold for Advertising Purposes Under Any Circumstances.

All New Members Must Have Their Name and Address Sent in Through the Secretary of Their Lodge. After That They May Have Changes Made in Their Address by Filling Out Blank Form in Back of Book and Forwarding to the Editor.

All Copy Must be Received by the Editor by the 18th of the Month to Insure Publication in the Following Issue.

All Contributions and Correspondence Relating to the Journal Should be Addressed to J. B. Casey, Editor, Room 9, Law Building, Kansas City, Kansas.

Entered at Postoffice, Kansas City, Kansas, as Second Class Mail Matter.

THE EASTLAND DISASTER DUE TO INCOMPETENT INSPECTION.

While many theories have been advanced as to the cause for the awful disaster and loss of life due to the Steamship Eastland overturning along side the wharf at Chicago recently, when more than twelve hundred lives were lost, the real reason is due to the incompetency of the whole inspection system maintained by the federal government for the inspection of hulls and boilers of steamships.

To the uninformed this may sound like a broad statement made in a spirit of captious criticism, but to the more experienced it will be received as a plain statement of facts. At any rate, what we may say can be easily investigated from the records.

The inspector general, the supervising inspectors, as well as the local inspectors, were selected because of their pull and sea service rather than because of their practical knowledge of ship building or boiler making. Most, if not all, of these inspectors, from supervising inspector general down, were taken from the ranks of marine engineers. These have no practical training as ship builder or boiler makers. They start in as oilers and are gradually promoted to engineer.

When the inspection law was enacted in 1871 most of the ships' hulls were made of wood, and the problems surrounding their management were far more simple than they are today, when most of the ships are made of steel. Consequently less importance was attached to their inspection. Steam, too, as a propelling force for merchant ships, was in its infancy.

The marine engineers who were organized at the time this law was enacted helped to get it through Congress so worded that they would be selected to put it into effect. The first supervising inspector general was a marine engineer. He helped to select the supervising inspectors and they together drew up the regulations and the qualifications prescribed for the local inspector, and consequently none but marine engineers are employed. Therefore, this incompetency is fundamental and can only be removed by a com-

plete reorganization of the bureau. Unless those who supervise a service of this kind are thoroughly practical and experienced as ship builders or boiler makers they cannot prepare regulations governing the work of local inspectors or be able to tell whether they are doing the work in a competent manner or not.

An incompetent inspection system is more dangerous and fraught with more serious results than if no inspection laws were enacted, because it lulls the public into a false sense of security; believing all boats and boilers are properly inspected, when as a matter of fact they are not, because of the incompetency of the inspectors.

Had the rules governing the navigation of the ships been drawn up by a board of competent, thoroughly experienced ship builders who have made the problems surrounding the safe navigation of ships a life study, and the enforcement of these rules placed in the hands of experienced practical inspectors, it is a safe bet that the Eastland disaster would never have happened. As it is, this gastly penalty is paid by the traveling public because of this incompetent inspection. Secretary Redfield has sensed the trouble while investigating this disaster, and has, we believe, frankly expressed his belief that the whole system needs a reorganization. But even though he believes this is necessary, will he be able to bring it about or will the political influence that had these men appointed inspectors be powerful enough to effect a whitewash?

Furthermore, should a reorganization be decided on, would he, as head of the department having supervision over this inspection service, select practical ship builders and boiler makers to do this work, or will he simply reorganize with another set of incompetent supervisors and inspectors taken from the same source? We hope for the sake of the lives and limbs of the traveling public that he will decide to reorganize with practical ship builders and boiler makers to fill all of the inspectorships.

At any rate, the public is getting wise to the real cause for this appalling disaster, and it will administer a serious punishment to those responsible for the continuance of this incompetent system of inspection, as well as those responsible for its creation, if they can be found.

It is a coincident that the owners of the Eastland were among those who hollered loudest against the safety sections of the seaman's law which was enacted at the last session of Congress, and these same people will try to have this measure repealed at the next session of Congress.

STRIKE ON IN NEW ORLEANS CONTRACT SHOP.

For some time our members in New Orleans have been trying to thoroughly unionize our crafts in that city. It seems that the greatest stumbling block to the accomplishment of this task has been that some years ago some of the boiler makers there formed a local benevolent association, which is in no way affiliated with the regular labor movement, and is, to all intents and purposes, a dual organization. Our members made every overture pos-

sible to these men to come into the International Brotherhood and all but a few did so, but it seems these few refused to come to any understanding and were backed up by the management of a couple of the shops, notwithstanding the fact that all of these shops, which have an employers' organization known as the "New Orleans Metal Trades Association," recently entered into an agreement with our men.

As our members exhausted every means to settle the matter amicably and believing these dual men were a constant menace to the welfare of themselves and the trade, secured permission of the Council and went on strike July 29 at the New Orleans Boiler Works, Dussell's Boiler Works and Johnson Iron Works of Algiers, La. About forty-eight men are affected. The following firms have refused to employ any but our members, consequently there is no trouble at these places: The New Orleans Machine Works, Ferren Machine Works, Stearn's Foundry and Machine Company and L. C. Coppins. Thus it will be seen that a majority of the shops are fair to our men and we are informed that the struck firms have work upon which a time limit is placed, consequently the prospects of an early settlement looks good at this time. Our members, in seeking work, should give New Orleans a wide berth at this time, and when a settlement is reached prompt notice will be given.

We cannot understand why these dual men persist in such a short sighted, suicidal policy. They are being made cat's paws by these unfair employers, not for the men's sake, but that they may be kept divided, and the employers reap the benefit by keeping wages down to a minimum.

STRIKE AT THE KANSAS CITY TERMINAL SETTLED.

Trouble which has been brewing for some time at the Kansas City Terminal shops and round house culminated into a strike July 29, which involved blacksmiths, boiler makers, carmen, machinists, sheet metal workers and the helpers of the several trades.

The immediate cause of the strike was the failure to take back the men laid off on April 30, on a plea of economy, and the immediate bringing in of a bunch of strike breakers by the Fields Detective Agency of Chicago. This company did not employ many men until after the new Union Station was built in Kansas City, Mo., when on its completion, a new round house was built and it took over the care and repairing of the passenger engines of a number of roads entering the new station. Since that time a larger force has been employed, and last spring the men organized a shop federation and opened negotiations with the management, looking towards the securing of an agreement. The committee was led to believe such would be secured for some time, but finally an order was issued by the management terminating all negotiations, and a large number of men were discharged and strike breakers later employed to take their places.

The International officers of the unions whose members were affected took up the matter, as did also the officers of the railway department, and later on an arbitrator from the Federal Department of Labor was secured

and worked faithfully to settle the matter, but without success, as the president of the company took a very obstinate position in reference to the matter. Then all business agents whose roads run into Kansas City were called into conference, and they took the matter up with the individual directors of their company and the board of directors of the Terminal Company, and while securing promises to help they failed to get the trouble adjusted, and finally on July 29 a strike was declared and all card men at work walked out. After they were out a few days the company officials opened up negotiations with the International officers and in a few days a settlement was reached by the reinstatement of all men who walked out and the immediate reinstatement of ten of those who were previously discharged, and all others so discharged since April 30 are to be reinstated just as fast as positions can be made for them, and the management is to meet representatives of the men within sixty days for the purpose of negotiating an agreement. The men returned to work on the 10th, and we believe a date has already been set to arrange for an agreement. Mr. William Blackman was the United States conciliator, and deserves much credit for the result and the untiring manner in which he worked in helping to bring it about.

THE FEDERAL BUREAU OF LABOR ISSUES A NEW PUBLICATION.

We are in receipt of a copy of Number 1 of Volume 1 of the "Monthly Review," a new publication in magazine form issued by the Federal Bureau of Labor Statistics, and is to be issued monthly and contain results of investigations, current events, notices of labor legislation, court decisions and other matters affecting labor.

This publication will replace the bi-monthly bulletin suspended by the department three years ago.

The initial number has many articles of interest to our members and organized labor in general, and they should write to the "U. S. Bureau of Labor Statistics" and secure a copy. It is quite likely they can have their names placed on the mailing list for future issues.

REACTIONARY STANDPATTERS IN CONTROL.

From all accounts the New York state constitutional convention, which has been in session since last April, is dominated and controlled by reactionaries of the most pronounced type, and they are making an effort to abolish all social welfare laws that have been enacted in that state for the benefit of the masses, such as workmen's compensation, child labor laws, minimum wage, mothers' pension, and employers' liability laws, as well as all restrictions that have been placed on corrupt politicians.

Our members in that state should follow the proceedings of this body very carefully and study the provisions of the constitution it submits so

that they may act intelligently on it when it is presented to the voters for approval or rejection.

It seems to us it would be better for the people of New York state to continue under their present constitution, with all its imperfections, rather than to accept a constitution such as it is reported this reactionary bunch are trying to adopt and lose most of the remedial laws of the state.

PLANS A SUBMARINE BATTLE CRUISER.

From all reports there is likely to be many important and far-reaching changes made in the character of naval warfare and naval vessels, as a result of the experiences of the present war in Europe. One of the latest of these changes that we have heard of is a proposition to build a submarine battle cruiser which would be able to go at high speed on the surface of the water and when necessary could dive and proceed under water.

The daily press informs us that Commander Charles Courtney of the U. S. Navy has planned such a craft and that it has been deemed entirely feasible by those who are informed on matters of this kind.

It is not likely that so many superdreadnaughts will be built, but rather a number of swift battle cruisers, torpedo boats, torpedo boat destroyers and submarines. We believe a large number of these small crafts will be authorized. If these submarine battle cruisers are a success, no doubt others will be built.

STRIKE ON AT HALIFAX, N. S.

A short while ago our members opened up negotiations with the employers at Halifax, Nova Scotia, looking to the securing of an increase in wages. The Executive Council gave its consent for a demand for an increase.

Three firms conceded an increase. These were: A. Cox & Co., N. Evans, Limited, and A. A. Webber & Son.

Two other companies refused to grant an increase and strikes were declared. These are the Halifax Graving Dock Co., and T. Hogan & Co. The strike took effect August 1, and about sixty-five men are involved.

From all reports it is only a question of a short time until these two companies will have to come across, too, as they have failed to secure anyone to take the strikers' places and their shops are closed tight.

The pickets are doing their duty and none can get by them.

Our members everywhere should stay away from Halifax until this trouble is settled, when due notice will be given.

THE BOILER MAKERS SEEK RECOGNITION FROM THE ILLINOIS STATE FEDERATION.

Word has reached us that our members in Danville and other sections of Illinois have enthusiastically indorsed the candidacy of Brother James B.

Keenan of Danville as a member of the Executive Board of the State Federation of Labor in that state, and have decided to leave no stone unturned in their efforts to bring about his election.

Brother Keenan is a man well fitted for the position, as he has had much experience and has held many positions of importance in the labor movement, and will no doubt fill the office with credit and ability if elected. He now occupies the position of president and business agent of District Lodge No. 42.

We are always glad to see those of our members who are competent aspire to positions of prominence in the general labor movement, and we hope all of our members all over the state will rally to Brother Keenan's support and not only vote for him, but get others to do likewise, and that he may be overwhelmingly elected.

AN INDEFENSIBLE PROPOSITION.

As unity is so essential to the success of organized labor, we regret very much to see anything arise to disturb the harmony existing between individual members of the same union or between different unions composing the family of trade unions. For this reason we are slow to criticise the actions of another organization, preferring rather to pass over their shortcomings in silence. However, when the actions of officers or members of other organizations threaten the future peace and rights of our Brotherhood we feel we would not be doing our duty if we did not give notice to our members and enter our protest against such hostile action.

We have a case of this kind in mind at the present time. We refer to a constitutional amendment now before the rank and file of the Machinists for a referendum vote. According to the August issue of their journal, this amendment was proposed by a local of that organization and approved by its law committee. It reads as follows: "In localities where no local of any other metal trade exists, **those engaged in the various metal trades occupations may be organized or admitted into a mixed local of this association** in conformity with the resolutions on amalgamation adopted by referendum vote of the association in July, 1914."

We do not believe the majority of the members of the Machinists are in sympathy with such a proposition or that they will approve of it, for it is an officious and unwarranted intermeddling with the affairs of other trades that would be bound to produce trouble in short order. We have not all of the men working at our trades organized at the present time, but we hope to have them so organized at no far distant date and we believe our members would strongly resent such an unwarranted interference by another organization with those coming under our jurisdiction.

If those over zealous members of the Machinists' Union want to do any organizing they will find there are many thousands of those working at the machinists' trade yet unorganized, and they might devote their efforts to this task rather than intermeddle with the men of other trades.

If the members of the Machinists' Union desire to live at peace with the other metal trades, and we presume they do, they will turn down this vicious

amendment good and hard, as it would be a flagrant and unwarranted invasion of the rights of the other metal trades.

KANSAS FEDERATION OF LABOR HOLDS CONVENTION.

The Kansas State Federation of Labor held its annual convention at Emporia, commencing August 9, and remained in session for three days. A large and enthusiastic convention was held and many measures passed that were for the advancement of the cause of labor in Kansas.

Plans were also perfected for a campaign of organizing throughout the state, and especially in Kansas City and some of the other larger cities of the state. A closer co-operation with the Farmers' Union was decided on, and an effort will be made to have fraternal delegates exchange visits at each other's conventions.

The next session of the federation will be held at Wichita in August, 1916. The boiler makers were recognized by the placing of Brother Eugene Taylor of Wichita on the legislation committee, and the boiler inspection bill was unanimously indorsed.

A SYNOPSIS OF THE REPORT OF THE INDUSTRIAL RELATIONS COMMISSION.

The United States Industrial Relations Commission has been busily engaged in formulating its report recently and from all accounts as published in the daily papers they had a warm time of it trying to reconcile their individual opinions and the various reports submitted for consideration, and it seems they could not all agree on one report and agreed to combine their several reports into one and submit it as one report to Congress.

In the first part of this issue we are reproducing a synopsis of the report prepared by Mr. Basil M. Manly and concurred in by Chairman Walsh and Messrs. Lennon, O'Connell and Garretson. Space would not permit our publishing a synopsis of the others in this issue, but we will do so in other issues, as we believe wide publicity should be given to them and that Congress should publish them verbatim.

It is the only report of its kind so far that has made specific and far reaching recommendations for legislation in behalf of the masses of the people. Even the report written and signed by the three members representing the employers admits the importance and necessity of the working people organizing into unions for their protection.

SEND IN CORRESPONDENCE EARLY.

We would like to impress upon our members, and especially the secretaries, the importance of sending in early in the month correspondence, roster corrections and photos which they desire reproduced in the Journal. All manuscript copy is copied on the typewriter and proofed before turning same over to the printers, and the earlier it reaches us the more time we have to devote to the matter. When they reach us at the last moment before closing

Journal we have to pass upon them with haste and are liable to overlook errors.

We are especially anxious to receive all photos early, as we send them out of town to have cuts made and it requires six or seven days to get them back, so all those who contemplate sending in groups of members, Labor Day parades, etc., will please bear this in mind and, if possible, get them to me by the 14th or 15th of the month, as this is as long as we can wait for them.

THE MINERS DECIDE TO REJECT AMALGAMATION.

Some time ago, we are informed, the United Mine Workers of America and the Western Federation of Miners appointed committees to consider the matter of amalgamating the two organizations, and according to some of our exchanges, these committees recently made their report in which they unanimously recommended that amalgamation be rejected. The following is the report of the joint committee:

"After having made an exhaustive investigation of the question of amalgamation between the United Mine Workers of America and the Western Federation of Miners, and after giving full consideration to the present conditions of each organization, we are forced to the conclusion that because of the many obstacles that now present themselves, and which will be explained in the reports hereafter provided for, that any attempt to consummate an amalgamation at this time would be premature.

"While we jointly agree that to effect an amalgamation of the two organizations at this time would be impracticable, in consideration of the views expressed by the respective committees, we hereby decide that each committee prepare a separate report, stating in detail the result of their findings, and that same be submitted by each committee for the consideration of their respective organizations."

The following statement was made by the committee representing the United Mine Workers of America:

"In behalf of the United Mine Workers we wish to state that the reasons for not agreeing upon a plan for an amalgamation between our organization and the Western Federation of Miners at this time are purely reasons of policy occasioned by present circumstances affecting both organizations.

"The United Mine Workers and the Federation have for many years worked in harmony, and each organization has at all times stood ready and willing to rally to the assistance of the other in times of stress.

"Some years ago an interchange of cards was agreed upon, and a miner bearing a Federation card was accorded the same rights and privileges in the United Mine Workers' organization as though he had been a member of that union and vice versa.

"Every benefit that could accrue from kindred sympathy and unselfish co-operation has been enjoyed in the past by both coal and metal miners' organizations as a result of this policy, and we wish to emphasize the fact that while an official amalgamation has not been consummated, the same

good feeling will continue to exist as in the past, and in behalf of the United Mine Workers we pledge our support in so far as we are able to lend support to the present campaign of organization being conducted by the Western Federation."

The conclusion reached "after an exhaustive investigation" by these committees we believe are wise and will, if followed out, be for the best interests and future welfare of both organizations.

The conclusions of the committee are along the same lines we have held in reference to amalgamation. These two organizations have a Federation and are deriving all benefits of a close affiliation and co-operation, and are avoiding all of the dangers that would follow amalgamation. After an exhaustive investigation it is found unwise for these two, organizations of coal and metal miners to amalgamate, how much more so would it be for widely different trades to amalgamate.

QUOTATIONS.

We may question those learned in the mysteries of the animal and human frame, if we would learn the secret of this strange yearning after salt, which ages have not diminished, nor civilization annihilated. Salt occurs in every part of the human body. It is organized in the solids, and dissolved in the fluids; it creeps into every corner of the frame, and plays a part in all the complicated processes of life, without which the machinery would be arrested in its operation. Thus, all our nutritive food consists either of fibrin, albumen or casein, and neither of these could be assimilated, and used in building up the flesh that walls about our life, unless salt were present; neither being soluble except in a Saline fluid.—Household Words.

It is a lamentable thing that every man is full of complaints and constantly uttering sentences against the fickleness of Fortune, when people generally bring upon themselves all the calamities they fall into, and are constantly heaping up matter for their own sorrow and disappointment. That which produces the greatest part of the delusions of mankind is a false hope which people indulge with so sanguine a flattery to themselves, that their hearts are bent upon fantastical advantages which they have no reason to believe should ever have arrived to them. By this unjust measure of calculating their happiness, they often mourn with real affliction for imaginary losses.—Sir R. Steele.

Civil freedom, gentlemen, is not, as many have endeavored to persuade you, a thing that lies hid in the depth of abstract science. It is a blessing and a benefit, not an abstract speculation, and all the just reasoning that can be upon it is of so coarse a texture as perfectly to suit the ordinary capacities of those who are to enjoy and of those who are to defend it. Far from any resemblance to those propositions in geometry and metaphysics

which admit no medium, but must be true or false in all their latitude, social and civil freedom, like all other things in common life, are variously mixed and modified, enjoyed in very different degree, and shaped into an infinite diversity of forms, according to the temper and circumstances of every community.—Burke.

Tully was the first man who observed that friendship improves happiness and abates misery by the doubling of our joy and dividing our grief; a thought in which he hath been followed by all the essayers upon friendship that have written since his time. Sir Francis Bacon has finely described other advantages, or, as he calls them, fruits of friendship, and indeed there is no subject of morality which has been better handled and more exhausted than this.—Addison.

A man that is fit to make a friend of, must have conduct to manage the engagement, and resolution to maintain it. He must use freedom without roughness, and oblige without design. Cowardice will betray friendship, and covetousness will starve it. Folly will be nauseous, passion is apt to ruffle, and pride will fly out into contumely and neglect.—Jeremy Collier.

Education begins the gentleman, but reading, good company and reflection must finish him.—Locke.

Man without the protection of a superior being is secure of nothing that he enjoys, and uncertain of everything he hopes for.—Tillotson.

STRIKES NOW IN FORCE.

- Atlantic Basin Iron Works (Shields & Moran, New York). (Strike on.)
- Hibbon & Co., contract shop, South Chicago, Ill. (Unfair.)
- Milwaukee Boiler Co., Milwaukee, Wis. (Strike on.)
- Stockton, Calif. (Metal Trades strike.)
- Des Moines Bridge & Iron Works, Des Moines, Iowa. (Erecting work at Bremerton, Wash., Valejo, Calif., and Norfolk, Va., Navy Yards.)
- Heinie Safety Boiler Co., of St. Louis, Mo. (Strike on.)
- Wangler Boiler & Sheet Iron Co., of St. Louis, Mo. (Strike on.)
- O'Brien Boiler Co., St. Louis, Mo. (Strike on.)
- Halifax Graving Dock Co., Halifax, N. S., Can. (Strike on.)
- T. Hogan & Co., Halifax, N. S., Can. (Strike on.)
- New Orleans Boiler Works, New Orleans, La. (Strike on.)
- Dussell's Boiler Works, New Orleans, La. (Strike on.)
- Johnson Iron Works, Algiers, La. (Strike on.)

Mechanical Department.

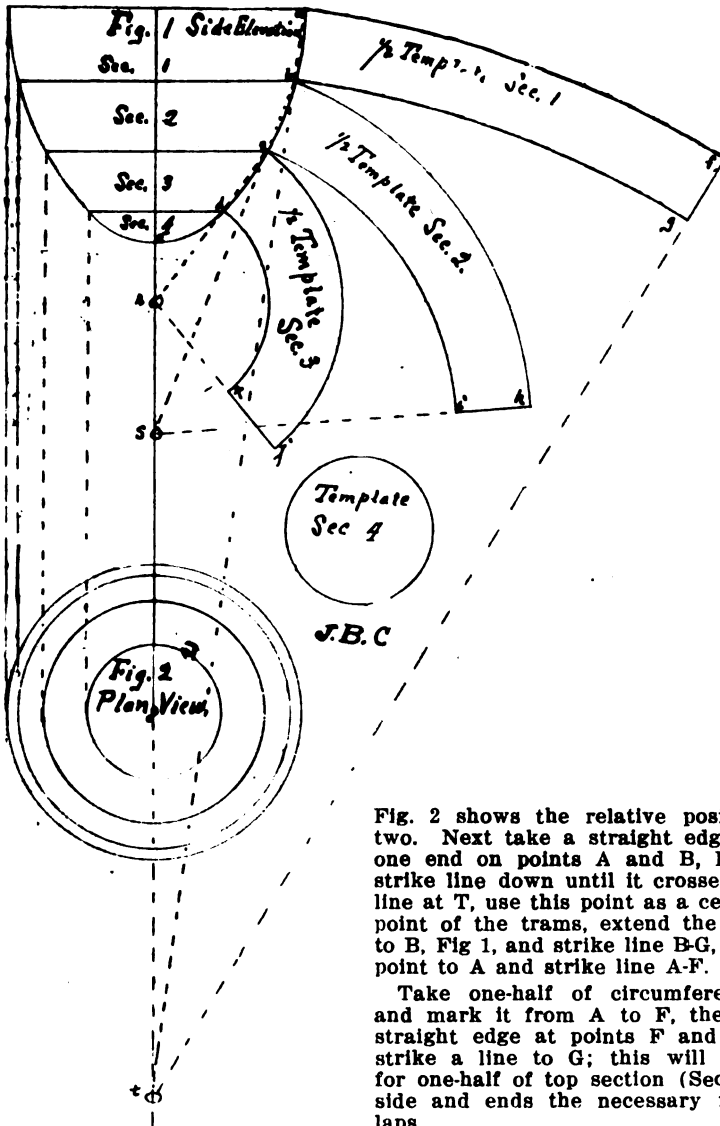

Fig. 2 shows the relative position of the two. Next take a straight edge and place one end on points A and B, Fig. 1, and strike line down until it crosses the center line at T, use this point as a center for one point of the trams, extend the other point to B, Fig 1, and strike line B-G, then extend point to A and strike line A-F.

Take one-half of circumference at top and mark it from A to F, then place the straight edge at points F and T; from F strike a line to G; this will be template for one-half of top section (Sec. 1), add to side and ends the necessary material for laps.

Section two and three are done in like manner; point S is the center for striking curve lines for Sec. 2, and point R is the center for Sec. 3. Sec. 4 is gotten out solid and dished the desired depth. All of the other sections should be also dished to conform to the curve line of the kettle in marking off the size of kettle; the mean diameter should be used, that is from the center of the metal on one side to the center of metal on the opposite side. Allow for laps on each section and also for section four, as this will draw up some in dishing; the amount of shrinkage will vary according to the way it is dished.

TO LAY OUT AN OVAL SHAPED KETTLE IN FOUR SECTIONS.

Fig. 1 shows the side elevation and Fig. 2 the plan view.

First mark off the side elevation and plan view the desired size; take one side of oval line, Fig. 1, from A to E and divide into four equal parts and from these points of division strike horizontal lines at right angles to the vertical center line. The plan view can then be divided according to the divisional lines in the side elevation. The dotted lines extending down from Fig. 1 to

International Officers' Reports.

REPORT OF SECOND INTERNATIONAL VICE-PRESIDENT NOLAN.

My last report was from New Orleans on many questions in connection with Lodge No. 37, also No. 442 and No. 206, as well as general labor conditions in the Crescent City on the Missouri River, and forward labor movement was under way for several weeks. Many well-known labor representatives of National and Internationals were there, for the purpose of organizing the unorganized men and women of New Orleans into the American labor movement and were successful in increasing the membership of many local lodges in that city.

July 1, left New Orleans for Mobile, Ala., to meet the general superintendent of motive power of the N. O. & M. C. Railroad Company, but was surprised to learn on reaching there that no conference had been arranged, nor was there any representative of the federated trades in the city; therefore, nothing could be done along that line, and turned my attention to another proposition of much importance to our craftsmen employed in the contract shops of Mobile, namely, the re-organization of Lodge No. 112; hadn't held a meeting for several months, and the result was, all the former members were delinquent, although several of them tried in every way possible to hold charter but failed, as many others have failed from time to time, due to the neglect of a local officer who should understand that he had a constitutional duty to perform in the protection of the members in the case of death or disability.

July 3, held a meeting with a few of the former active members of Lodge No. 112 and decided to call a special meeting of all boiler makers employed in the contract shops of Mobile for the purpose of re-organizing Lodge No. 112, and place it on the roster of the Brotherhood again; the result was that a number showed up, and a sufficient amount was collected to cover cost of re-organization, and temporary officers were elected and amount mailed to the International Secretary-Treasurer.

Left for New Orleans same date, night of 3rd, to attend to a very important meeting in connection with the Brotherhood, which will be given due consideration in some future report, providing I get the necessary information from Lodge No. 37, which I have failed to get so far.

July 8, left New Orleans for Baton Rouge, La., in company with Brother Smith, business agent of Lodge No. 37, to attend a meeting of Lodge No. 582, all of whose members are employed at the plant of the Standard Oil Company. It was a regular meeting and well attended, due to the fact that Lodge No. 582 has competent and capable officers,

who conduct the business of the lodge according to the constitution, and the result is an up-to-date local, because of actual co-operation of its entire membership. Brother Kidd, the president, and Brother Acosta, the corresponding and financial secretary, are live wires when the interest of the members are at stake, either at Baton Rouge or any other section which requires prompt action through correspondence or otherwise.

July 9, returned to New Orleans with Business Agent Smith to attend to several matters then pending in Lodge No. 37, also a jurisdiction mix-up between the structural iron workers and Lodge No. 37; same was adjusted by the international president by wire.

July 12, left New Orleans for Portsmouth, Va., to take up a grievance for the members of Lodge No. 57 at the Norfolk Navy Yard, but was instructed through the International office to stop over at Mobile and install the newly elected officers of Lodge No. 112, recently re-organized. After installing the officers, left on first train out of Mobile, arriving at Portsmouth, Va., evening of July 15.

July 16, visited the navy yard in order to meet the committee and get a line on the existing grievance in the boiler shop, as well as the general situation; shop committees are Bros. Thomas, Calvert and Mehan, and from information given me by the committee and others employed in the boiler shop, the conditions are not very encouraging, disrating boiler makers who have been on the first class roll, having years of navy yard experience and whose mechanical ability as boiler makers could not be questioned; yet they are disrated just the same; two cases in particular of boiler makers who had grown old in the service, giving the best years of their lives as mechanics at the Norfolk Navy Yard, turned down cold in their declining years. Surely the Navy Department cannot afford to discriminate against old and faithful employes in the service of the government; they should at least receive humane consideration in giving them such light work as they may be able to perform, not disrate or discharge them, when in the judgment of the supervising force they were not able to hit the ball in the fire room of a warship along with the young, active mechanics, and expect them to keep up the pace; surely the great majority of the American people would not approve of such a policy.

The question of disrating mechanics who have had first-class rate for years, many of them, is now before the Secretary of the Navy for investigation and hope it's only a question of time when a bill will be introduced in Congress to abolish all rates in

government navy yards, with the possible exception of first and second classes; when this is done, justice will be given the mechanics, and considerable friction will be eliminated.

July 20, had a meeting with the industrial manager of the Norfolk Navy Yard to arrange for a meeting with the boiler shop committee and secured a meeting for 12 o'clock, noon, the 21st.

At the appointed time the committee, composed of Brothers Thomas, Phelps and Mehan and men disrated, met the industrial manager and at once went into the question of disrating first class boiler makers, many of whom were on the first class roll for years. Every possible argument was used to place the disrated men back on the first class roll, but the industrial manager would not recede from his position, holding that he had the absolute right to disrate any mechanic who couldn't make good for compensation given by the government. Seeing it was absolutely useless to continue the conference, we notified the industrial manager that the matter of disrating first class boiler makers would be taken up with the Secretary of the Navy as soon as an arranged date could be secured.

July 24, attended a meeting of Lodge No. 428, whose membership is composed of boiler makers employed in railroad and contract shops. It was a fairly good meeting. Many questions came up relative to shop conditions and wage, and the writer was instructed to visit the proprietors of all contract shops in Norfolk and Berkley in order to present a new agreement and wage schedule, which was done the following day, the 25th. Brother Murdock, chairman of the wage committee, with me; the object is to get a meeting of all the proprietors and adjust all questions at issue between a committee of the men employed in the contract shops and the bosses, but so far haven't been notified as to the date of meeting.

On July 24th, a funny and somewhat peculiar incident occurred in the boiler shop of the Norfolk Navy Yard. Two more rates were introduced, which would make seven. I often wonder if the men in charge have any practical idea whatever as to the necessary qualifications required in mechanical ability. A seventh class boiler maker is a ninth class blacksmith, and so on down the line, which makes navy yards from a practical viewpoint a joke, pure and simple.

On same afternoon, July 24, a meeting was held at C. L. U. Hall, Portsmouth, Va., for the purpose of voicing their opposition and also taking the necessary steps to protest against the introduction of any additional rates in the boiler shop. The result was that a special meeting was called for Sunday, July 25, and promptly at 2:30 p. m., meeting was called to order, with Brother Phelps in the chair. The hall was packed. Brother Phelps explained the object of special meeting and expressed the hope that

every member present would express his honest opinion as to how to proceed on the grievance that confronted them in the boiler shop, and further trusted that whatever action would be taken would be a unanimous one and backed up by every boiler maker in the Norfolk Navy Yard in their efforts to adjust matters locally if possible, or through negotiations with the Secretary of the Navy if necessary to adjust the pending grievance. Good, practical addresses were made by many of the members present, and all seemed to be of the opinion that a naval federation of trades, under the jurisdiction of their respective International organizations, was absolutely necessary and essential for all navy yards, in securing better working conditions, as well as the enactment of such legislation as may remedy two glaring abuses, namely, too many classes and too many rates, as well as time and one-half time for all time worked over the regular eight-hour day which has been established by Congress. Such legislation is necessary and can be secured if all National and International Organizations co-operate along that line, providing the local organizations in the various navy yards show a little interest and some co-operation themselves. When that's done, the rest is easy; not before.

Among the principal speakers at special meeting were the Hon. Charles T. Bland, a former member of organized labor, now commonwealth attorney for the city of Portsmouth, Va.; also Brothers Thomas, Phelps, Mehan, O'Connor, Dorcey, Schultz and several others whose names I have forgotten. After all had expressed their opinions who desired to do so, a motion was made and carried that shop committees be instructed to see that the rates established by the Secretary of the Navy be carried out, and they did this all right on July 26, after which another special meeting was called to hear the report of the committee, which was all right, as the rate question was adjusted satisfactorily and the report of the committee was unanimously accepted.

July 30 called on industrial manager of Norfolk navy yard, for the purpose of getting data and other information for a committee who will later on call on the secretary of the navy yard to adjust a grievance in the boiler department of the Norfolk navy yard; same was secured and turned over to the shop committee.

This finished my report up to July 31. Hoping same is satisfactory, I am,

Yours fraternally,

THOS. NOLAN, I. V. P.

REPORT OF FOURTH INTERNATIONAL VICE-PRESIDENT WEYAND.

Baltimore, Md., Aug. 1, 1915.

Dear Sir and Brother:

The following is my report for the month of July, 1915. On July 1 I left Philadelphia for my home in Cleveland, as I had been informed in writing by the family physician

that the condition of Mrs. Weyand was serious and he would advise I make arrangements to take her to a hospital for an operation. In making the necessary arrangements in connection with this matter I was detained at my home until July 18.

Several days previous to July 18 I had received orders from headquarters to arrange to go to Elmira, N. Y., as soon as the condition of Mrs. Weyand was sufficiently improved for me to leave Cleveland. On July 19 I started for Elmira, N. Y. On my arrival in Elmira I was just in time to take some part in a conference with the officials of the American LeFrance Engine Company. A representative of the machinists, and a representative of the sheet metal workers organization, to work out a settlement of the strike in that plant. An agreement was arrived at that all men of the various trades who came out on strike would be returned to work within 30 days and that there would be no discrimination against any member who took part in the strike. Second, that the question of an increase of wages was to be taken up by the joint committee and the management of said company as soon as all men were back at work. Should the committee and the management fail to agree the wage question would be submitted to a board of arbitration for a final decision. After handling several matter with our Local Lodge No. 225 in connection with strike rolls and other matter which took several days, I made arrangements to again take up my work in Baltimore in behalf of Lodge No. 193.

July 24 I went to Baltimore to continue the organization campaign, as we have had many reinstatements and initiations the last few months in Baltimore. When I left Baltimore for Philadelphia to take up some matters with iron workers, by orders of President Franklin, I had a number of boiler makers and helpers who had paid part of their fees, so it became my duty to again visit the refinery at Fairfield and endeavor to line up the rest of the unorganized. As the work in the ship yards and dry docks is getting quite brisk we are carrying on a campaign in the city of Baltimore proper to ascertain what can be done for the ship builders and contract shop men. To date I have several more reinstatements and new applications, and hope in the near future to increase the membership in Lodge No. 193. This terminates my report for the month of July, 1915.

Trusting the same is satisfactory and with best wishes and kindest regards to the rank and file of our membership, and hoping for greater success in the interests of the Boiler Makers, Iron Ship Builders and Helpers' Organization of America.

I am yours fraternally,
LOUIS WEYAND, 4th I. V. P.

REPORT OF FIFTH VICE-PRESIDENT ATKINSON.

Billings, Mont., Aug. 14, 1915.

At the conclusion of my last report I was in Spokane, Wash., trying to get the unor-

ganized boiler makers and helpers employed at the Great Northern shops to join our organization, as the conditions the boiler makers and helpers are working under on the Great Northern are something deplorable, and I can't understand why the boiler makers and helpers will continue to work under such conditions, when they know if they will organize and stick together that they can enjoy the same condition and wages the boiler makers and helpers are receiving on other roads in this territory. While in Spokane, I received a telegram from Brother Dan McKillop, business agent of Seattle, requesting that I come to Seattle as soon as possible, as there was a grievance in one of the shops that he wanted me to investigate. A few days after arriving in Seattle, Brother McKillop and myself went over to Bremerton, to find out how the Des Moines Bridge & Iron Co. was getting along with the tanks they were putting up for the Government. Upon our arrival in Bremerton we went down to the navy yard and investigated how the work was getting along, also to find out how many men were at work on the job. As we started to leave the navy yard we were informed by one of the marines that we were under arrest and that he had received instructions to bring us up to the office. While we were being held in the office, Commandant D. W. Blamir came into the office and wanted to know if we were the two representatives of the union, and when we informed him that we were, he asked us if we did not know that we were not allowed in the navy yard. We informed him that we were not aware that we had violated any of the rules, as we had always understood that American citizens had a right to go into the navy yard, so long as he did not interfere with any of the workmen, and it is a positive fact that Brother McKillop or myself never spoke or interfered with anyone up to the time of our arrest. We were informed by Commandant Blamir that the Des Moines Bridge & Iron Co. could employ Japs or other Oriental labor to build those tanks if they saw fit to do so, and that they would be given protection by our government. After a considerable length of time, Commandant Blamir ordered one of the Marine to call up the chief of police at Bremerton and request him to come to the navy yard. After a few minutes conversation with the chief of police, Commandant Blamir informed Brother McKillop and myself that we were released, with the understanding that we would not be allowed in the navy yard again without first obtaining a special permit from the captain of the yard. This Des Moines Bridge & Iron Co. is one of the most unfair firms in the United States to organized labor. When we learned that this company had been awarded the contract to erect nine fuel oil tanks for the government, Brothers McKillop, Reed and myself did everything that was possible to be done to get this company to employ our members and pay the prevailing rate of

wages for this class of work, but without success, as they informed us that they intended to run a strictly open shop job, and I am pleased to report that from information I have received, this company is having considerable trouble in getting those tanks erected, as we have been very successful in keeping men away from the job that know anything about tank building. I have also notified the proper officials in Washington the kind of work that is being done on these tanks, and have requested that competent inspectors go over this work very carefully before it is turned over to our government. I am very pleased to report that Local Lodge No. 104, of Seattle, is getting along fine. Since the first of the year they have reinstated and obligated over one hundred members. Brother McKillop, their business agent, is doing everything he possibly can to get better conditions for the members. At their last regular meeting a motion was made that hereafter any boiler maker, ship builder or helper coming to Seattle would not be allowed to go to work without their card was up to date. So all boiler makers, ship builders and helpers take notice. From Seattle I went to Tacoma, and had the pleasure of meeting with the members of Lodge No. 247 of South Tacoma, and I am pleased to report that business is picking up a little on the N. P. While in Tacoma I also met with the members of Lodge No. 568, and am also glad to report that business is picking up a little on the Milwaukee. Most all of our members that got laid off several months ago have been put back to work. From Tacoma I went to Everett, Wash., and I am sorry to report that Local Lodge No. 500 is not getting along very well, and I am in hopes that the members of Lodge No. 500 will soon see the mistake they are making and that they will soon get back in the organization and take a little more interest in each other's welfare. Upon my return to Seattle I received a telegram from Brother J. W. Hogan, Secretary of Lodge No. 80, Anaconda, Mont., requesting me to come to Anaconda as soon as possible, as they were having trouble with the structural iron workers on account of them claiming the erection of a large stack that was about to be erected by Anaconda Copper Mining Co. I am very pleased to report that after several conferences with the officials of the company we were successful in getting the officials to agree to allow our members to erect the stack, also the foreman agreed to pay every man that works on the stack \$4.25 per day of eight hours. Mr. Mathewson, superintendent of the company, called the foreman into the office and instructed him in the presence of the committee, that hereafter he wanted the agreement we have with the iron workers carried out to the letter, and I feel sure if our members will do their part that they will not have any more trouble with the iron workers. At this time I want to thank the committee, also the president and members of Lodge No. 80, for the assistance they gave me while in Anaconda, also for

the box of cigars and dressing case they presented me with before leaving Anaconda. From Anaconda I went to Butte, met several of the members of Lodge No. 130, but did not have a meeting, as I expect to return to Butte in the very near future. From Butte I went to Livingston and held a meeting with the members of Lodge No. 123, and I am pleased to report that the officers and members of Local No. 123 are all up-to-date and first class union men, doing everything they possibly can to better the condition of their members. From Livingston I came to Billings, Mont., where several of our members are erecting a gas holder, and at this time I want to take the opportunity of thanking Brothers McClusky and Everts, of Lodge No. 123, for the good work they have done for getting this job lined up, also for getting riveters and caulkers \$6.00 per day, heaters and holderons \$5.00 per day of eight hours. This concludes my report for this month, which I hope will be satisfactory.

Will close with best wishes and kindest regards, I am

Yours fraternally,
WM. ATKINSON.

REPORT OF SEVENTH INTERNATIONAL VICE-PRESIDENT MAHER.

At the conclusion of my last report, was in Washington, Ind., where I attended a mass meeting of the B. & O. shop federation of that city and a very good meeting it was also. The meeting was called to take up the very important question of the introduction of the Emmerson efficiency system. It was decided at this meeting to refuse to accept the efficiency slips as the men realized that the introduction of this system was not for the interest of the workers. It was also decided to send a committee to Chillicothe, O., to give the views of the men at Washington on this question and also to use their best efforts to organize a shop federation at Chillicothe, O. I agreed to attend this meeting in Chillicothe with this committee, and a good committee it was, also. From Washington I went to Columbus, O., to meet the men on the Big Four as had been trying to reorganize that system. Met the men in the roundhouse at Columbus with no results.

From Columbus I went to Chillicothe, O., to attend mass meeting of men on B. & O. of that city, and a very good meeting it was, also. The committee from Washington attended this meeting, also, and we were successful in organizing a shop federation, or rather having the boiler makers and machinists agree to organize federation providing we could organize the blacksmiths. I arranged for a meeting of the blacksmiths and found that they were ready to organize and got on the wire with President Kline and Vice-President Horn. Was sent to Chillicothe and organized the blacksmiths and after several visits to Chillicothe Brother Horn and myself were able to install a local federation. Also I found the financial affairs of Local No. 135 in very

bad shape and while there I got the books in good shape and No. 135 is doing nicely and we were able to reinstate 18 members.

From Chillicothe I went to Indianapolis to try and reorganize the Beach Grove shops on the Big Four, but found after several days that the men did not seem to be ready and did not meet with any success. Perhaps later on good results can be attained on this system.

From Indianapolis I went to Lima, O., to take up grievance of Lodge No. 259 with C. H. & D. and was able to adjust matters and get men reinstated. I then worked between Lima and Newark, O., organizing, and was able to reinstate 9 at Lima and 7 at Newark, O. Brother Horn of the blacksmiths also worked those cities and met with success in Lima. While in Lima I received a wire to go to Cleveland at once to try and settle controversy of boiler makers and iron workers. I found that iron workers were doing our work. I protested to the building trades of Cleveland and the next morning met the business agent of the iron workers, also the president, Brother Carlin, of Lodge No. 5, who was also present at this meeting, and we were able to come to an understanding with the iron workers, as the work clearly belonged to us. Brother Carlin and myself then met the local manager of the B. & W. firm who were erecting the boilers in the Schlater brewery of Cleveland, but were unable to get them to agree to any proposition so refused to let our men finish the job. I had arranged a meeting in Newark, O. and went to that city for this meeting and when I returned to Cleveland found that the B. & W. had put a gang of their non-union repair men on the job in Schlater brewery and finished it at night. Brother Carlin and myself had several conferences with the B. & W. manager and the manager of the brewery with no results. I then appealed to the Building Trades and the matter was left in the hands of the grievance committee of the Cleveland Federation of Labor and the Building Trades of the City of Cleveland, and the job tied up in the brewery, also another job the B. & W. were erecting in Cleveland for the Gas company was tied up. I then returned to Newark, O., to take up the work of organizing at Newark and Lima. Myself and Brother Horn of the Blacksmiths held several meetings in the two cities with fair results. From Lima I went to Chicago and met Brother Hinzman and Brother Ryan and we met with a like committee of the Iron Workers and Sheet Metal Workers to take up the question of amalgamation. Resolutions were drawn up to be presented to the next convention of the three organizations. While in Chicago Brother Hinzman and myself went to Gibson, a shop on the C. O. & S., and believe good results will be gotten there in the near future.

From Chicago I went to Toledo, O., to assist lodge 85 in getting an agreement with the McNall Boiler Works of that city. After several conferences with the manage-

ment we were unable to reach any agreement and as I did not consider it an opportune time to enforce our demands and also advised the members of lodge 85, the matter was let drop until business was better. I then returned to Lima to take up unfinished work. From Lima I went to Portsmouth to spend a few days; from Portsmouth I went to Phoenixville, Pa., to try and organize the Heine Safety Boiler Plant but did not meet with any success. From Phoenixville I went to Pittsburgh to take up the work of organizing and found lodge 154 in very good shape with 181 members in good standing, but there are many more who should be members in good standing and I find there is plenty of work to be done here. Lodge 154 has a good live business agent and I think we can do some very good work here in the near future. While in Pittsburgh I heard that there was a chance of organizing a local at Parkersburg, W. Va. I went to Parkersburg and met the men in several shops and arranged a meeting for the next Friday. I then returned to Pittsburgh to take up the work of organizing in that city and expect good results. I again went to Parkersburg and was successful in organizing a local there of eight new members and as there were five members there in good standing we will have a local of thirteen members there with very good prospects of more in the near future. From Parkersburg I went to my home at Portsmouth to spend Sunday, from Portsmouth I went to Galeton, Pa., to try and adjust grievances of lodge 438.

Hoping that this report will meet with the approval of all and with very best wishes and regards, I remain

Fraternally,

M. A. MAHER,
7th, I. V. P.

REPORT OF EIGHTH INTERNATIONAL VICE-PRESIDENT JOSEPH P. RYAN.

New Orleans, La., Aug. 15, 1915.

Editor Journal:

At the conclusion of my last report I was engaged at Port Arthur, Tex., assisting Lodge No. 305 adjust some matters at the Gulf Refinery. The controversy arose over the Gulf Refining Company taking over a certain part of the work being erected by the Reeves Brothers Company of Alliance, O., against whom our members had been on strike for four months. Unable to adjust the proposition as we desired, we were forced to put it up to the Gulf Refining Company to either take over all the work being done for them by Reeves Brothers, or else discontinue working our members on this said work, which had been going along with scab labor. After several conferences, the Gulf Refining Company turned the work back to the Reeves Brothers Company and placed our members who had been taken from the shops, back in the shop. Such members as were hired for the work in question were laid off and at a special meeting held to take action on the matter, Lodge

No. 305 accepted the refining company's action as a solution to the trouble.

Leaving Port Arthur, I visited Houston in connection with the strike rolls of Lodge No. 74, and met with Brother Jackson, their secretary, in regard to same. Also visited Galveston and then went to Thrall, Tex., a new oil field, where the Magnolia Petroleum Company was erecting some tank work. Arriving at Thrall, Tex., I visited the job and found our members from Lodge No. 96 of Fort Worth, Tex., on the job; all members and Brother Lou Hanna as job steward. I also visited a job just completed by the P. I. W. and the site of a Warren City job, but no material had arrived for same.

Enroute from Thrall to Cushing, Okla., I stopped at Fort Worth and at Gainesville, Tex. All our members at Fort Worth I found at work, with two or three crews about to be shipped by the Magnolia Petroleum Company and the Southwestern Mechanical Company to Texas westers.

At Gainesville, Tex., the Cushing Refining Company was laying out the grounds for a new refinery, about one-half mile north of town. I learned from a Mr. Todd that the work would be done by our members, Mr. McCabe, foreman, and that as soon as the steel arrived, a crew would be brought from the Cushing field. I left for Cushing, arriving late that night.

Upon my arrival at Cushing, I was advised that Lodge No. 592 had decided in regular meeting to take a referendum ballot with regard to calling off the strike in the Oklahoma oil fields. I called a special meeting and advised with the men and having done so I remained two days with them, arranging for a complete transfer of the strike rolls, bank arrangements, etc., as Brother Richard Leahy, their secretary, had been bonded during my absence. During my stay at Cushing my attention was called to the fact that our members in Chicago were working for the Treadwell Construction Company of Midland, Pa., one of the firms we had been on strike against since January. I had previously been advised of this at Port Arthur, Tex. I had wired headquarters and was advised by wire, also letter, that our members in Chicago were not working for the Treadwell Construction Company of Midland, Pa., but a different concern, called the M. H. Treadwell Company of Illinois. I was handed a letter in Cushing by Brother Murphy of Lodge No. 592, which I herein incorporate, which he had received from the secretary of state of Illinois, as follows:

Office of Secretary of State,
Springfield, Illinois.

May 12, 1915.

Mr. James Murphy,
Cushing, Oklahoma.

In Re: The Treadwell Engineering Co.

Dear Sir:

I have your inquiry of May 10, in regard to the above company.

In reply, permit me to advise that an examination of the records of this department does not disclose a corporation, either domestic or foreign, under this particular name.

Very truly yours,

LOUIS G. STEVENSON,
Secretary of State.

I read the telegram and letter I had received from headquarters in regard to this matter and agreed to take the matter up in person on my arrival at Kansas City, which I did. I was assured by President Franklin and First International Vice-President, Brother Hinzman, that Lodge No. 39 had made every effort, also the International President's office, to ascertain if there was any relation of these two concerns, and from the information available, that there was no relation, and under this condition Lodge No. 39 was allowed to place its members on the work at the Commonwealth-Edison power plant at Chicago, Ill.

Both Lodges No. 1 and No. 39 had been instructed to remain off this work while this investigation was going on. Lodge No. 39 finally started their members, and owing to a jurisdictional dispute between the two lodges in Chicago, Lodge No. 1, with the assistance of the Chicago Building Trades Council, forced Lodge No. 39's members off the job and same were replaced by Lodge No. 1's members, and the job is being completed by them. There are two smoke stacks and some breeching work to be erected. This action between the two contract lodges of Chicago came about over violations of an agreement signed by both lodges, Lodge No. 1 refusing to allow Lodge No. 39 to do the work, once it was declared fair. The result now is Lodge No. 1's charter has been revoked for violation of the agreement in forcing Lodge No. 39's men off the job mentioned.

Having been on the road five months, I went home for a brief time and not being content with the understanding I had of the matter, I also addressed a communication to the secretary of state of Illinois. I herewith submit same and also his reply:

Chicago, Ill., June 29, 1915.

To the Honorable Secretary of State,
Statehouse, Springfield, Ill.

My Dear Sir:

Will you kindly furnish me with the following information? Is there at the present time incorporated under the laws of the state of Illinois, a firm by the name of the—

Treadwell Engineering Company.
Treadwell Construction Company.
Treadwell Manufacturing Company, or the
M. H. Treadwell Company of Illinois.

My object is to ascertain the relation of this said M. H. Treadwell Company of Illinois, so-called is to the Treadwell Engineering and Construction Company of Midland, Pa.

If there is at this time a firm incorporated under the laws of the state of Illinois, will you kindly furnish me with date of incor-

poration and names of the officers and location of its business address.

Trusting you will favor me and thanking you in advance I am

Very truly yours,

JOS. P. RYAN,

5830 Wentworth avenue, Chicago, Ill.

July 1, 1915.

Secretary of State, State of Illinois,
Springfield.

Mr. Jos. P. Ryan, 5830 Wentworth Ave.,
Chicago.

In Re: M. H. Treadwell Company of Illinois.

Dear Sir:—I have your letter of June 29, in regard to the above company.

In reply, I would advise that this company was incorporated December 5, 1907, with a capitalization of \$5,000, which was increased to \$50,000 January 8, 1908.

The subscribers to the capital stock at the date of organization were: M. H. Treadwell, H. N. Dougherty, Alex. K. Hamilton, C. B. Abbey and K. Jungles.

According to the annual report of 1915, the business address is located at 208 South LaSalle street, Chicago, and the officers are:

Alex. K. Hamilton, president, 5413 Cornell avenue, Chicago.

M. H. Treadwell, secretary, 203 W. 81st street, New York City.

An examination of the records of this office does not disclose a corporation under any of the other names submitted.

Very truly yours,

LOUIS G. STEVENSON,

Secretary of State.

I am submitting these letters, in order to give the members at large and particularly those involved in the oil field's strike, an opportunity of deriving the benefit of the information I have obtained on the case through Mr. Stevenson's hands. I also find that this Mr. Hamilton had charge of all the work formerly erected in Chicago and vicinity by the Treadwell Engineering and Construction Co. of Midland Pa. The Chicago telephone directory gives the firm's name as the Treadwell Const. Co., and it's the same address as given by the Secretary of State. There is not the slightest doubt in my mind, but that they are one and the same and the work in Chicago has been done under subterfuge pure and simple. While at my home, June 8, I was advised by the secretary of Lodge No. 592 that the referendum vote was returned in favor of continuing the strike as the vote stood 208 to continue the strike, 145 to discontinue the strike and 5 ballots were disqualified. Later on, July 6, I was advised by First International Vice-President Hinzman from headquarters that Lodge No. 592 had called the strike off by a vote at a special meeting July 3. The vote being 172 to discontinue the strike and 102 to continue the strike. Later I was advised by the secretary of Lodge No. 592 similar to Brother Hinzman's letter. I have secured a copy of the amounts paid in strike benefits to the lodges involved in the oil fields strike and I am here-

with submitting a statement of the same for the benefit of the rank and file.

To Lodge No., 37, New Orleans,
Brother L. Costella, Sec'y.....\$ 147.00

To Lodge No. 74, Houston, Tex.,
Bro. F. C. Jackson, Sec'y..... 980.00

To Lodge No. 96, Brother L. A.
Freeman, Sec'y. 616.00

To Lodge No. 305, Port Arthur,
Tex., Brother T. O. Riley, Sec'y. 6,076.00

To Lodge No. 592, to Brothers Wm.
Carey, V. P. Ryan and R. Leahy. 34,188.00

Grand total of strike benefits

paid. \$42,007.00

Of the \$34,188.00 paid to Lodge No. 592, Brother Wm. Carey, secretary, received \$2,562.00; Eighth I. V. P. Ryan, received \$29,750.00, and Brother R. Leahy, secretary, received \$1,876.00.

All of the cancelled checks have not as yet been recovered from the banks at Cushing and Tulsa, Okla., and a cash balance remains on deposit at the First National Bank of Cushing, Okla., awaiting my return to that city, at which time same will be returned to the I. S. T. as per instructions of President Franklin.

The strike in the oil fields which became effective in January and which has been terminated by the members on strike, involved about 1,000 members in all five lodges. While seven firms open shopped their work, we had the benefits of five other firms in the fields who worked union men and union wages and conditions. True, we lost a large number of our men but the environment and the conditions of the labor market from January to August in the oil fields and in fact throughout the entire country, were far from favorable in a struggle such as we have had in the fields. The strike is over. One feature of the struggle stands out and of which the writer is proud. Our international financed this strike throughout. When the brothers complied with the laws they received strike benefits. When they failed of the laws, they did not.

Since my departure from the oil fields I have been assigned to some matters pertaining to the organization at Terre Haute, Ind.; Lafayette, Ind., and finally at New Orleans. At Terre Haute I endeavored to assist Lodge No. 246 in lining up the Terre Haute Boiler Works. I met with the men employed at that shop, arranged a special meeting for them but they failed to appear. Having orders to visit LaFayette, Ind., and assist Lodge No. 360 and then proceed to New Orleans, I was forced to leave Terre Haute after a very short visit. At LaFayette I assisted Lodge No. 360 in adjusting a grievance at the Monon Railway shops which terminated satisfactorily without serious trouble.

For the past eight days I have been here in New Orleans assisting Lodges No. 37, 206 and 442 conduct a strike in the Murphy Boiler Works, Johnson Iron Works and the Dusell Boiler Works. The strike occurred July 29, has been sanctioned by the executive council and the members are receiving

regular strike benefits. There is no question of the wages, hours of labor or shop conditions involved direct. Recently our lodges here entered into an agreement with the N. O. Metal Trades Association. There are some twenty-five boiler makers in New Orleans who have an organization known as the Boiler Makers and Iron Ship Builders Benevolent Association of New Orleans. These few men have elected to remain non-union and to work in conjunction with the manufacturers. Our members have offered them every inducement to come over with us and be union men. They have elected otherwise. Our members are on strike to force them to affiliate with our International Brotherhood or get off the job. They are trying to break the present strike by remaining at work while our members are on strike. We have some shops with us and have requested a conference with the N. O. Metal Trades Association. Brothers, remain away from New Orleans while this fight is on. We are meeting daily at 10 a. m. The shops are picketed and the outlook is good. Help the members in New Orleans win this fight by remaining away from Murphy's Boiler Works, the Johnson Iron Works, at Algiers, La., and the Dussell Boiler Works of New Orleans. Riter-Conley Co., of Pittsburgh, Pa., is erecting work at Westwego near here, \$4.00 per day for caulkers. After the strike then comes the cut in wages. Reeves Brothers have a job at Avondale, La., open shop, Oklahoma scale.

Since my last report I have one reinstatement fee to report, Brother William H. Sherman, boiler maker, Reg. No. 46730, lapsed lodge, Jerome, Ariz., money to I. S. T., and I have also the pleasure of reporting

eleven more official emblem buttons sold. I herewith submit a list of the names and amounts:

Brother Sam A. Dugan, B. M., Lodge No. 132,	\$1.00 button.
Brother Major Rising, B. M., Lodge No. 305,	\$1.00 button.
Brother Carl Tezzman, B. M., Lodge No. 360,	\$1.00 button.
Brother Fred Ramp, B. M., Lodge No. 360,	\$1.00 button.
Brother R. E. Aldrich, B. M., Lodge No. 360,	\$1.00 button.
Brother Wm. H. Cassman, Appr., Lodge No. 360,	\$1.00 button.
Brother Frank L. Bongen, Appr., Lodge No. 360,	\$1.00 button.
Brother C. J. Burroughs, B. M., Lodge No. 360,	\$1.00 button.
Brother F. W. Montgomery, helper, Lodge No. 360,	\$1.00 button.
Brother John Halpin, helper, Lodge No. 360,	\$1.00 button.
Brother John Vautier, B. M., Lodge No. 582,	\$1.00 button.
Total buttons,	\$11.00.
Previously reported, buttons and charms	\$69.75
	11.00

Grand total, buttons and charms to date, Aug. 15, 1915.....\$80.75
 Watch this column grow; buy and wear a button or a charm.

Trusting this, my report will prove interesting to the rank and file and with best wishes, I am,

Fraternally yours,
 JOS. P. RYAN,
 Eighth International Vice-Pres.

Correspondence.

Pueblo, Colorado.

Dear Sir and Brother:

I am enclosing you copy of resolutions of condolence, upon the death of Brother John W. Kelley, for many years a member of this lodge. Brother Kelley died on July 9th, after a lingering illness, and was buried on July 12th in Roselawn cemetery. As Brother Kelley was a member of both the Woodmen of the World and the Boiler Makers, members of both lodges acted as flower bearers and pallbearers. Brother Kelley was employed as boiler maker at the Missouri Pacific shops here, since the year 1904. He was highly respected and honored by all who knew him.

Resolutions of Condolence.

Brother John W. Kelley, who has been an esteemed member of Pikes Peak Lodge No. 44, since June, 1904, was summoned to his last reward before the Heavenly Tribunal, Friday, July 9th. His death, while not entirely unexpected, was a severe shock to the members of this local, who will ever cherish his memory with high regard. Therefore,

Be It Resolved, That the members of this order extend to the bereaved widow and children of Brother Kelley our sincere sympathy. And be it further

Resolved, That a copy of these resolutions be sent to the bereaved family of the deceased, and that a copy be sent to the official Journal for publication, and that these resolutions be spread upon the minutes of this lodge.

DAVID WHEATLEY,
 GEORGE S. WARDEN,
 J. J. EVANS,
 Committee.

Beaumont, Texas.

Dear Sir and Brother:

We have suspended Brother Phil H. Ickles, Register No. 103180, for non-payment of dues. Now this brother was initiated January 12, 1915; now when he was initiated he claimed he got hurt, and maybe he did; anyhow the members voted him the amount of \$63.56 and I paid him this money and he paid February and March dues and left here owing Adams & Johnson Grocery

Co. \$32.55, Beaumont Fish & Oyster Co. \$20.05, Hotel Tolle \$25.00, Max Trink \$15.90, Southwestern Hotel \$3.75, Pullman Bar \$4.40.
Suspended—J. E. Ickles, non-payment dues (Register No. 102873; Wallace Burthlott (Register No. 102192); R. W. Roach (Register No. 90,131).

T. C. MADDY,
Secretary, Local 537.

Denison, Tex.

At a regular meeting of Sunset lodge No. 200 of Denison, Texas, the following resolutions were unanimously adopted:

Whereas, It has pleased the Almighty God in His infinite wisdom to remove from our midst our beloved and esteemed brother, A. C. Morgan; therefore, be it

Resolved, That we, his fellow brothers, extend to his bereaved parents our heartfelt sympathy in this their hour of sorrow, and pray that the Almighty God may comfort and console them and that they may bear their sorrow with fortitude, and be reconciled by those sweet words of "Thy will, Oh Lord, and not mine, be done"; and, be it further

Resolved, That our charter we draped for thirty days, and that a copy of these resolutions be sent to the bereaved parents, a copy be spread on our minutes and a copy be sent to our official journal for publication.

S. E. HARRIS,
W. D. RENFRO,
T. J. PRUETT,
Committee.

Hoisington, Kansas.

At a regular meeting of lodge No. 403, the following resolutions were adopted:

Whereas, Our Heavenly Father, whom we know doeth all things well, has in His infinite wisdom called to His heavenly home the beloved wife of our worthy and esteemed brother, Adam Schneider; therefore, be it

Resolved, That we extend to our brother and family our sincere and heartfelt sympathy in this their hour of sorrow.

Be it further resolved, that a copy of these resolutions be sent to the family, a copy spread on our minutes, and a copy sent our official journal for publication.

Respectfully submitted,
J. N. SHIRLEY,
FRANK HUGHES,
C. E. WHEELER,

Committee.

At a regular meeting of Hoisington lodge, No. 403, International Brotherhood of Boiler Makers, Iron Ship Builders and Helpers of America, the following resolutions were unanimously adopted:

Whereas, It has pleased Almighty God in His divine wisdom to remove from our midst the dearly beloved mother of our worthy and esteemed brother E. J. Barrett; therefore, be it

Resolved, That we, his fellow brothers, extend to our brother our heartfelt sym-

pathy in this, his hour of bereavement, and pray that the Almighty God may comfort and console him, and he will bear his trial with fortitude; be it further

Resolved, That a copy of these resolutions be spread on the minutes of our meeting, a copy be forwarded to our official journal for publication, and a copy be forwarded to our bereaved brother.

J. N. SHIRLEY,
FRANK HUGHES,
C. S. WHEELER,
Committee.

Newport News, Va.

Whereas, It has pleased the Almighty God, in his infinite wisdom and power, to take to His reward our esteemed and beloved brother, William Stevenson; therefore, be it

Resolved, That while we bow to the wish of Him above, we deeply lament the death of our worthy brother.

We, his fellow brethren, extend to his bereaved family our most profound sympathy and ask that the Divine Ruler of the universe, who giveth and taketh all things, give them the strength and Christian fortitude to bear up under this their great sorrow, the loss of the loved husband and father.

And be it further resolved, that a copy of these resolutions be sent to the bereaved family, a copy sent to the official journal for publication, a copy be spread on the minutes at our regular meeting and that our charter be draped for thirty days.

M. A. HICKEY,
W. G. HANNA,
WM. HEALY.

Tulsa, Okla.

To the Officers and Members of All Locals:

We have proof positive that Brother Willard Ellis, Register No. 96,258, who was published in the July Journal as a scab, has been working on strictly fair jobs since the 18th of January; that is, when he did work, and that the brother who reported him erred grievously. We had some trouble locating Brother Ellis, as he is known as "Heavy," hence the tardiness in making this correction.

Fraternally,
RICHARD LEAHY,
Sec. 592.

St. Louis, Mo.

On Wednesday, July 28th, at 9:00 a. m., there passed away at St. Louis, a brother well known to the greater majority of the members of the Brotherhood. This brother William J. Falk, or more familiarly known as "Dutch," had endeared himself to countless numbers of his friends through his sterling qualities, his devotion to the cause of unionism and his tender and kind heart, which was never able to stand a hard luck story of any kind without extending substantial and suitable aid.

For the past few months he was in fail-

ing health, but with the true energy which ever asserted itself in Brother Falk, he insisted on going to Newberg. He did go, but was unable to hold out, owing to his weakened condition. Returning to St. Louis, he spent several weeks at the Frisco hospital, and had only left there five days when death claimed him for its own.

With all the honors of unionism, he was laid to rest in Calvary cemetery. Many and sincere were the expressions of sorrow and regret for this termination of Brother Falk, called away in the prime of life. His union cards and books he had given to a friend, a noticeable fact and one worthy of mention, was that going back five years, each month had a stamp, not one was missing. What a grand example of union principle. Would that there were more supporters of our cause. This fact hardly surprises any one who knew very much about our late brother. This was one of his sterling qualities, of which he had quite a few.

Brother Falk has traveled over the greater part of these United States, Mexico and Panama, while in that respect his life may have been at times somewhat thorny, yet never was he known to complain. With true manhood which was ever a distinguishing feature of our departed brother, when prosperity came to him he never turned a deaf ear to one in need. He always proved a friend indeed, as many of our brothers can testify. His death will come as a shock to his many friends and brothers. We trust the columns of the Journal will publish this so that it may reach all who might not otherwise hear of Brother Falk's death. We brothers of No. 27 feel sure that our expressions of sorrow voice the sentiments of the entire Brotherhood. We mourn because we have lost a true brother, a kind friend, a firm supporter of our cause. On the pages of memory his name will be inscribed. Many there are who will never forget times when Brother Falk helped to make smooth the rocky way of life.

Once again the Silent Reaper,
Comes among us grim and stern,
Gathers in a worthy brother
One of our best union men.

Brother Falk or better still
Known to most as "Dutch",
Endeared to us as Brother Will
E'en tho' we called him such.

For many months with watching eyes
We saw him slowly sink,
Altho' he fain would e'er disguise
And try to make us think—

That he would rally and again
Regain his failing health,
And bid his sturdy manhood claim
Its heritage of wealth.

To New Berg then one sunny day
He went with hopes raised high,
Not dreaming that before the summer went
He would come back here to die.

Returning to St. Louis he rallied bravely
Consulted those with skill
Who only shook their heads gravely,
Which meant no hope for Bill.

On July 28 he passed away,
Him no mortal power could save;
On July 30th we laid him
In the cold and silent grave.

With union honors thus we gave
Him back to Mother Earth,
And as we sadly turned to leave
Paid tribute to his worth.

Altho' from us he's gone away,
In memory we'll retain
Remembrance of his kindly ways,
Until we meet again.

Now, brothers, ere you close this book,
Just stop right here and take a look;
Read these lines before you talk,
Which tells you all of Brother William J
Falk.

Read how this man, this prince of men,
Went from us when the Master called,
And now we hope forever more
Is enjoying his reward.

JAS. CALLAHAN,
Cor. Sec'y. Lodge No. 27,
St. Louis, Mo.

Knoxville, Tenn.

At a regular meeting of Marble City Lodge No. 143, the following resolutions were unanimously adopted:

Whereas, it has pleased the All Wise God to remove from our midst our dear Brother Raymond D. Grooms; and:

Whereas, Brother Grooms was loved and esteemed by all the brothers; therefore, be it

Resolved, That we, his brothers, the members of lodge No. 143, who mourn his loss, take this means of extending to the bereaved family our deepest sympathy, and we pray that the gracious Lord, who doeth all things well, may comfort, console and strengthen them in this their sad hour of sorrow and grief; and be it,

Resolved, That a copy of these resolutions be sent to the family, a copy spread on the minutes of our lodge and a copy sent to our official journal for publication and our charter be draped for ninety days.

JOE GALLOWAY,
J. C. STANSBURY,
R. W. VOGLER.

East Boston, Mass.

Dear Sir and Bro.:

Lodge No. 585 was honored at its last regular meeting on August 15, by the presence of our worthy Sixth International

Vice-President John J. Dowd, who at this writing is in Boston working in conjunction with International Organizer Chas. Scott, in trying to get an agreement with the management of a large contract boiler shop in Boston to use only union men in their brewery tank work.

Our hustling president, Brother Wm. E. McNabb, is lending his best efforts in assisting Brothers Scott and Dowd in the campaign now on in New England, for a thorough unionization of all labor at breweries. Bros. Scott, Dowd and McNabb have demonstrated to the boiler and tank manufacturers of Rhode Island and Massachusetts that the International Brotherhood of Boiler Makers and Iron Ship Builders and Helpers of America is a force to be reckoned with and a force that must be tolerated and respected.

Brother Dowd addressed the members in his usual sincere and attractive manner, again urging the boys to work in harmony with the international representatives who are doing all that human ingenuity can advise to improve the working conditions of the men of our craft in this section of the country.

At this time I feel impelled to pay a tribute of respect and admiration (in which I am sure I voice the opinion of all our members) to the sterling manhood of Brother Charles Scott, as exemplified in the great assistance he has rendered Lodge No. 585 in increasing its membership by paving the way for Brothers McNabb, DeFretis, Dennis and others to bring back delinquents to the folds and to get many out of the fold to join our organization. Conscious of the duties and responsibilities of his position, very mindful of the confidence reposed in him by his superior officer, Brother Jos. A. Franklin (who as well as Brothers Hinzman, Reinemeyer and Casey have the heartfelt appreciation of Lodge No. 585 for their good will). Brother Chas. Scott has made it known to all whom it may concern, that regularity, straightforwardness and a righteous regard and respect for constitutionality must be the maximus and the rules of conduct for all those who desire his association and his co-operation in the legitimate advancement of trade unionism in our craft.

Yours fraternally,

DANIEL B. McINNIS,

C. S. L. 585.

Middletown, N. Y.

Dear Sir and Bro.:

At a regular meeting of Lodge No. 400, International Brotherhood of Boiler Makers, Iron Ship Builders and Helpers of America, the following resolutions were adopted:

Whereas, God in His infinite wisdom has removed from this world of strife and toil Brother Michael S. Lane, of Lodge No. 400,

Resolved, That we, his fellow brothers, extend to the family our heartfelt sympathy and condolence in this sad hour of sorrow and grief, and be it further

Resolved, That a copy of these resolutions

be sent to the Journal for publication, a copy sent to the family, and a copy spread on the minutes and our charter be draped for thirty days.

CHRIST SMITH,
WM. CHOWN,
WM. E. APPEL,
Committee.

Baton Rouge, La.

Dear Sir and Bro.:

I wish to notify you of the death of Brother Burton H. Carter, Reg. No. 94093, which occurred in Baton Rouge.

Resolved, That Local No. 582, Boiler Makers, Iron Ship Builders and Helpers of America do hereby extend our utmost sympathy to the bereaved family; and be it further

Resolved, That a copy of these resolutions be sent to the family, a copy to the Journal for publication, and a copy spread on the minutes.

Fraternally,
S. V. ACOSTA, L. 582.

Rocky Mount, N. C.

Dear Sir and Bro.:

It is with some reluctance, and after careful consideration, I have decided to dwell upon a question which to my mind presents difficulties of vital importance, and may be counted upon to keep in check or subdue entirely any active effort to promote the universal understanding and guidance so necessary in the work of harmonizing the forces of the mechanical trades upon railroads, into a formidable aggregation.

That of the conniving process of weeding out in times of depression, so-called, the brother who through his zeal or endeavor happens to attract the attention of those intolerant Shylocks, by their relentless "scruples," now in command of the steering gear upon a great many of our railroads, whose favored anticipations to carry out a well-arranged program to make ineffective and defenseless organized labor, is noteworthy. Ensnared by the cunning of organized piracy, their sole inclination is wrapped up in output.

Notwithstanding general adversities, there must be declared the usual dividend, which customarily means the operating expenses must supply the deficiency. So the too well known practice of retrenchment follows, and the real burden reverts to the workers already ground down and staggering under depression. They must further extend the principles of economy, and hand up the lion's share, that there may be made possible those pleasing dividends. But the effects are far reaching and productive, and we may with assurance look forward to a militancy that will challenge those unwarranted and unjustifiable demands upon labor. In this great hue and cry for increased efficiency, the moral status of an issue is hopelessly overshadowed, and in many instances the law of limitations is unknown, subjecting willing and misguided

workers to over-exertion and apathy, which accounts in a large measure for the careless indifference toward the interests of organization, the only "constructive" weapon of defense. This phase of labor's difficulties is voluminous enough to quote indefinitely, though it is not my intention to go into an extensive illustration of this high gear or speed-up system, and its effects, but rather as I see it, to offer a possible preparatory defense to counteract those encroachments upon the principles which band us together.

There is such a well developed impression of fear amongst railroad workers of being dispensed with in times of depression, it is only necessary for some irresponsible narrow gauge to unload some little press article on the question of reduction, and though it may be the other side of the continent, there immediately follows a scurrying for cover that would do credit to a well disciplined understanding. The crust, though meager, is seemingly at stake, and the silent determination to take no chances is strictly observed, resulting very often in sacrificed prestige, otherwise unobtainable, without at least the usual formalities in working a change or departure from the customary shop practices. Now, under the present schedule upon many railroads, there is commendable reason and excuse for this not unnatural fear of the ax swinging in their direction, especially if they have shown a disposition, and still believe in organized labor having a voice in making and maintaining shop conditions, under which they alone must labor. By virtue of the fact that schedules offer scant protection to the brother who may be let down through questionable channels, not always cognizant to the surface observer, and let it be known the railroads according to their options, present practice considered in times of reduction, can so proportion those round-ups they experience little or no difficulty in reaching the desired object.

We are keenly interested in causation and effect, but it is with actualities we must grapple, and the question of relieving men from the inherent means of a livelihood at any time upon the shallow pretext of necessary retrenchment, is a menace that ought not to be tolerated under any consideration. Future schedules should be drawn sufficiently scopeful and elastic in my judgment to make it impossible for the railroads to use this means as a lever to set out undesirables.

I refer, for example, to the Atlantic Coast Line shortly following negotiations with general managers in the Southeast, which by agreement was deferred indefinitely, posting notices of a contemplated reduction, when in order to overcome, the men proposed short time on their part, a mutual sacrifice, and this same proposal being acceptable to local management where offered, was rejected by the general superintendent of motive power upon the flimsy ground the request was not general. Such a lamentable excuse, coming from an official who

brandishes honor and responsibility as a handy defense when the occasion serves, provokes curiosity. Short-sighted policies of this character will do more to close up the ranks than an extended campaign. The transportation organizations have, I believe, incorporated in most of their schedules an article which rules an employe must be out of the service twelve months before he can be returned a new man, and subjected to an examination that would approximately disqualify 35% of their working force, and this is a conservative estimate. Such a rule would in a measure serve to defeat the purposes of railroad companies in unloading the obnoxious or "so-termed" undesirables who happen to observe the line-up and refuse to fall for the bait.

The time is here now and opportune to awaken and lay aside those petty squabbles and jurisdictional differences. It will require a united effort, free from discrepancies, to effectually meet the onslaughts in store for organized labor, and we can at best ill afford to fall fighting one another, especially should we seek to avoid the pitfalls of sectional enmity, an imaginary delusion, distrustful to the core. Ours should be a work of universal co-operation toward a common cause.

The most effective and choice means of progress are employed by the industrial masters. They are at your command: Organization, education and confidence.

We have been masquerading behind the powerful influences of selfishness ingrafting the seed of enmity and distrust. Let us come out, uproot and banish from our midst those abominable oppressors of reason, thus exemplifying in truth and spirit the principle of brotherhood.

With apologies for this extended letter, and best wishes for success, I remain.

Fraternally,

A. J. DIXON,
Cor. Lodge No. 239.

Livingston, Mont.

Just a few words with our traveling brothers from Lodge No. 123, with reference to our pie-card.

Lodge No. 123 having been very liberal in the way of maintaining a pie-card at four different points along the Northern Pacific, namely Butte, Livingston, Laurel and Billings, a distance of two hundred and twenty-five miles. This card has been so conducted that we would be in a position to know who and how many meals every brother would eat at the expense of the lodge. Here are some of the figures: We have traced some of our patrons and have found that they have been our customers for three meals at each point over the road, which has cost us \$4.20. We further find that these same customers make this trip quite frequently, in fact so frequently that it terminated to this step of informing our organization of it. Lodge No. 123 does not mind of helping a brother in distress, but we even have knowledge of where some of

our customers have as much as \$1,000 in the bank on interest, who have the nerve to ask us to buy them a feed on the strength of their nerve. We also have knowledge of others quitting their job with one hundred dollars to the good, and coming right along eating at our expense, with money in their pocket. All right, brothers, keep it up, and you will succeed in putting the kibosh on it for yourselves, and then you will want to go around and talk about the tight bunch of boiler makers in the Northwest.

Up to date you have already been so good and kind that we have seen fit to limit this abuse to strictly only one meal to anyone, no matter who he is or where he comes from. And now if this will not be the solution in reducing this expense, we will just naturally have to eliminate it entirely, and all will share in suffering the consequences.

We here some make the remark that they are paying for the pie-cards; well, perhaps so, but just the same it does not work out right when we have to put on local assessments to purchase due stamps from the grand lodge. Now, brothers, just consider things a little bit and practice economy. Hoping that we will not be forced to take further action, for the best interest of all.

Fraternally submitted,

LODGE No. 123.



BROTHER JOHN KUHN OF LODGE No. 578, HAGERSTOWN, MD.

One of the Pioneer Members of the Brotherhood, Being a Charter Member of Lodge No. 22 of the Old National.

Richmond, Va.

At a regular meeting of Shubrick Lodge No. 170 the following resolutions were adopted:

Whereas: It has pleased the Almighty God in His infinite wisdom to remove from our midst the beloved mother of our esteemed brother, E. T. Truman; therefore be it

Resolved, That we, the members of Lodge No. 170, extend to our worthy brother and family our heartfelt sympathy and con-

dolence in this sad hour of bereavement, softened only by the confiding hope that her spirit departed to a better and brighter sphere where sorrow is unknown and that on the last day we shall be united; be it further

Resolved, That a copy of these resolutions be sent to our bereaved brother, a copy sent to the Journal for publication and a copy spread upon the minutes.

S. P. CRITZER,
J. C. TYLER,
J. H. HANKEY.

Livingston, Mont.

REPORT OF THEO. W. EVERT, MEMBER OF LODGE No. 123, DEPUTIZED TO LOOK AFTER WORK AT BILLINGS, MONT., ON GAS HOLDER.

Our members having become aware of the fact that there was to be erected a gas holder about August 1, at Billings, Mont., lost no time in finding out who the contractors were and giving all the information they had to Lodge No. 123, and also to the International, which terminated in the work being done by members of our organization.

Brothers Jno. Hendershot and Jos. McClosky, members of Lodge No. 123, also Brothers McFadden and DeBrail being on the scene, with the united assistance of the Billings Trades and Labor Assembly, also Mr. Roache, president of the assembly, are the ones in particular responsible and deserve all credit for having secured this work for our organization.

The members on the ground desired to know from Lodge No. 123 what would be done in regard to a steward and business agent for this work, and what the scale of wages would be, etc., and while Lodge No. 123 was not in a position to stand the expense of a representative, I wired to Brother Franklin at Kansas City and received a wire in return instructing me to go to Billings until Brother Atkinson could get to the job.

I at once went to Billings on July 27, and remained until July 31. When I arrived at Billings I found that work had already started and going along nicely, with seven of our members on the job. The scale of wages was fixed at \$6 per day for boiler makers and \$5 for helpers and heaters, eight hours constituting a day's work.

Brother Chas. Biggs was chosen as steward on the job, who is amply competent to fill the bill, while Brother Jos. McClosky was chosen to act as business agent, who is doing his share of the work in a manner unexcelled. No one is hired until they have deposited their C. C. with Brother McClosky. Brother McClosky also collects all dues and secures stamps and cards for the members on the job.

Everything was going along so nicely that I could see no use in me staying around any longer so I returned home July 31. At this writing we have about sixteen members employed on this job, and I hope that our members will have no trouble in com-

pleting the work satisfactory to all concerned.

In conclusion, I might say that it is up to our members to keep a watchful eye for this class of work, and when they know of some job coming up, lose no time in informing the nearest local, also writing to Brother J. A. Franklin, room 15, Law Bldg., Kansas City, Kas., who will only be too glad to assist in securing this class of work for members of our organization, with the undivided support of all of us, we will be more successful in keeping this work from the members of other trades, as they are applying every means possible to do this class of work.

Trusting that this will be of interest to our members, and hoping to hear that we have been successful in securing more work of this nature I beg to remain,

Fraternally yours,
THEO. W. EVERT.

Algiers, Fla.

At a regular meeting of Elmira Lodge No. 206, I. B. of B. M., I. S. B. and H. of A. the following resolutions were adopted:

Whereas, God in His infinite wisdom has removed from this world of strife the beloved wife of our esteemed brother, J. R. Crombie.

Resolved, That we, his brothers, extend to the family our heartfelt sympathy and condolence in this sad hour of sorrow and grief; be it further

Resolved, That a copy of these resolutions be sent to the Journal for publication, a copy sent to the family and a copy spread on the minutes.

C. F. KENNEY,
JNO. DONEWAR,
ED BARRY,
Committee.

Spencer, N. C.

Dear Sir:

As so much talk is going on about the notes to the belligerent nations at war, I want to suggest one thing to the men of this country, especially the organized brothers of the different crafts, quite a few are for war, but I would advise all in this matter to do one thing, namely, to write or wire the President, also all the congressmen, to submit all disagreements to the different nations for arbitration, just as this country forces us to do, namely, accept arbitration.

Why should any of the laboring people want war? Who will be the first and possibly the only ones to be called to the front? The laboring class, of course, and those affiliated with the unions will be first of those if possible, if for no other reason than to break up unionism. So brothers, vote in your lodges to write or wire the President to arbitrate the disagreements this country may have with other countries, instead of having them listening to the lobbyist and newspaper editors and others who want war on one or the other

nations that is now at war. They, the belligerents are like men in a trance. They are not really aware of what they are doing, they think they are only doing harm to their enemies. There are millions of people in this country who would have all questions or difficulties of this country straightened out by arbitration but don't know how to make their wishes known, and quite a few are in our lodges.

So now for our country's sake, for your wife's, father's, mother's, sister's, brother's and all others you love, sake, your own self included, do this as it will help keep this good old U. S. A. out of a conflict which in itself is useless without others getting into it. And now with best wishes all brothers, I am,

Yours fraternally,
WM. H. DREYER.

P. S.: Don't be satisfied with your lodges writing to the President and congressmen, but write letters yourself. It will be for your own interest as well as your Brotherhood's and country's interest.

Yours fraternally,
WM. H. DREYER.

Elkins, W. Va.

Dear Sir and Brother:

At a regular meeting of Lone Tree Lodge No. 278, the following resolutions were adopted:

Whereas, It has pleased the Almighty God in His divine wisdom to take from this world of trials and sorrow, the beloved son of our brother, J. W. Carr; therefore, be it

Resolved, That we, his fellow brothers, extend to him and family our heartfelt sympathy in this hour of sorrow, and be it further

Resolved, That these resolutions be inserted in our official Journal, recorded and transmitted to the family of the deceased.

E. P. EDMONSON,
H. N. FREDLOCK,
C. L. CASKEY,
Committee.

Chicago, Ill.

Dear Sir and Brother:

At the last regular meeting of Lodge No. 227, the following resolutions were adopted:

Whereas, Our Heavenly Father, whom we believe and know doeth all things well, has in His infinite wisdom called to his heavenly home the beloved son of our worthy and esteemed brother, M. J. Donnell; therefore, be it

Resolved, That we, his brothers, extend to the family our heartfelt sympathy and condolence in this sad hour of sorrow and grief, and be it further

Resolved, That a copy of these resolutions be sent to our official Journal for publication.

Fraternally,
WALTER SCHULTZ,
JNO. SELDON,
JNO. DWYER,
Committee.

Chicago, Ill.

Dear Sir and Brother:

At the last regular meeting of Lodge No. 227, the following resolutions were adopted:

Whereas, God in His infinite wisdom has removed from this world of strife and toil, Michael Burke, a brother of L. A. Burke of Lodge No. 227,

Resolved, That we, his brothers, extend to the family our heartfelt sympathy and condolence in this sad hour of sorrow and grief, and be it further

Resolved, That a copy of these resolutions be sent to our official Journal for publication,

Fraternally,
GEO. AMBERGER,
THOS. BERRY,
THOS. DEAN,
Committee.



A GROUP OF THE MEMBERS OF LODGE 384, EMPLOYED AT THE WABASH ROUNDHOUSE AT PERU, IND.

Portsmouth, Va.

Dear Sir and Brother:

At a regular meeting of Lodge No. 298, Portsmouth, Va., the following resolutions were adopted unanimously:

Resolved, That we sympathize with our worthy brother, Robert Young, in the loss he has sustained by the death of his mother, and those of us who have been bereaved of our parents know how severe is the blow, but our Heavenly Father knows and tempers every wind that blows, so that we may look forward to the time when they meet again, and their joy may be great after the disappointment here below, and be it further

Resolved, That a copy of these resolutions be sent to the bereaved brother, a copy be spread on the minutes of this meeting and a copy sent to the Journal for publication.

Fraternally,
ROBT. T. HOWE, C. S. L. 298.

Fairbury, Neb.

On Friday, July 16, 1915, Mrs. B. Z. Millikan passed to the Great Beyond, and at a regular meeting of Fairbury Lodge No. 439, B. of B. M. and I. S. B. and H. of A., held July 28, 1915, the following resolutions were adopted:

Whereas, Our Heavenly Father, whom we believe and know doeth all things well, has, in His infinite wisdom, called to His heavenly home, the beloved wife of our worthy and esteemed brother, B. Z. Millikan; therefore, be it

Resolved, That we extend to our brother and his family, our sincere and heartfelt sympathy in this their hour of sorrow. As the tie is broken here, there will be one to welcome them when they have reached that land where there is no parting or sorrow. Be it further

Resolved, That our character be draped in mourning for thirty days, that a copy of these resolutions be sent to the family, a copy spread on our minutes and a copy sent to our official Journal for publication.

Respectfully submitted,
H. K. LARKINS,
GEO. W. PARKER,
GEO. FRAZIER,
Committee.

Wilkes-Barre, Pa.

Dear Sir and Brother:

Having had a good many traveling brothers calling to see me of late in search of employment, I want to inform them of the conditions in this city. They are very bad at the present, very little work for boiler makers, and small wages. There is only one contract shop organized, McCullem Brothers, and at the present time they only have three boiler makers on their pay roll.

The D. & H. R. R., where organized labor gets a square deal, are not taking on any new men, as we are working short hours. You will find the same conditions in all the railroad shops in this section of the state and along the D. & H. R. R. lines, so if any of our traveling brothers are looking for employment, it is no use stopping off at Wilkes-Barre. Nevertheless, I am always glad to meet a brother and extend a helping hand.

In reading my Journal, month after month, I fail to see anything in it in regard to our local lodge, No. 547, of Carbondale, Pa., so I am going to write a few lines, if nothing more than to let the brothers know that Lodge No. 547 is still in business and I think at the present time we have a lodge we should be proud of, and by the information I received we are still getting new members under our new set of officers, and the lodge is still being run in a successful manner.

Now it only remains with the brothers to do their duty and keep the good work up and it will not be many more months until Local No. 547 will head the list in Pennsylvania.

With best wishes to all the brothers, I beg to remain

Fraternally,
THOS. J. CAVAN,
Wilkes-Barre Rep. L. 547.

Seattle, Wash.

Dear Sir and Brother:

We, the auditing committee of Lodge No. 104, Seattle, Wash., at our last regular meet-

ing on the 5th inst., were instructed to strongly protest through our official Journal, the discontinuation of the support for business agents.

We consider it very poor business methods on the part of our Grand Lodge officers.

At our last convention the receipts to the general fund were raised from 30 to 40 per cent, on the understanding that the increase would be sufficient to support business agents and district organizers. The cash receipts for the last three months were \$38,118.32; take 40 per cent of \$38,118.32 leaves \$15,247.328, which seems sufficient if judiciously handled would maintain our organization. If funds are insufficient as handled at present it would seem the right policy to discontinue the three district organizers.

According to the last quarterly report, the three district organizers have drawn \$2,006.51, while the 19 business agents drew to the amount of \$1,570. Since Local No. 104 has elected a business agent (Brother Dan McKillop), our membership has increased over 100 per cent in less than six months.

Local No. 104 "at the least" expects due stamps to the amount of the allowance for business agent.

BUD NASH.
ARCHIE NAULT.
JESSE HANSEN.

FRED COUNTER, President.

Cushing, Okla.

Dear Sir and Brother:

The Oklahoma oil fields strikes and the mistakes that caused it: .

There were four grave mistakes that caused the strikes in the greatest oil fields in the world; they were drunkenness, ignorance and conceit on the part of our members, and the cut-throat system on the part of the seven companies who were doing work in the field at that time.

Let us take the mistakes separately and quote some of the minor strikes that were brought on by one or the other. Drunkenness caused more trouble about the living and food than any other. Our members would come to eat and if the coffee did not taste good to them, they would rave and tear about the camp and call a strike for bum food, and some of our members who have pride in their low registered number would set by and listen to it all. Another mistake that was caused by the same curse was when some member wanted his time after being drunk for a couple of weeks and if the amount was not there what he thought ought to be on the check, he would walk out to the tank and wave his hand and say, "Come on off; this guy will not give me my right time." If they thought they had a certain amount of hours coming, you could not get that thought out of their heads when they were drunk, and this booze that you get here will make any man see and think some awful things.

Ignorance of our constitution caused a lot of trouble; anybody and everybody would call a strike whenever they chose and there was some of the most foolish grievances brought up that ever a human heard. I could cite thousands of cases, but it would take up too much space. If we wanted anything, we just went after it and considered nothing but what we went after. The strike for more work was the one that brought home the bacon. Just think of it, Mr. Editor, members of our organization going on strike for overtime. The producer was paying for overtime; he was willing to pay it until he got caught up with his storage, and when he wanted to cut it out, we would not let him—a shame and a disgrace to this Brotherhood, and our demands for hours for waiting for water were unreasonable, and bad holes the most damnable piece of foolishness that ever was pulled. Why, if a gang had a few bad holes in a sheet, they would call a strike until they got one hour extra for pining out holes, and who had to pay it? Why, the producer, and this is just the reason the producer was against us during the big strike.

The third mistake on our part was conceit. We heard our members tell the contractor and the producer that they could not build his tanks without us; we heard our members tell the foreman that he would do the riveting or the calking to suit himself, that he, the foreman, was only a figure-head on the job. Mr. Editor, I want to ask if this is justice and how long is any organization going to last that deals out that kind of justice; I claim not very long. The slogan was they have to have the tanks and they can't build them without us, and get what we can; to h— with the Grand Lodge and the constitution, the poor old constitution was pulled to pieces so much so that it is not fit to look at any more. Did they build any tanks without us? Well, you can tell the world they built them without the good fellow who was willing to give what he was looking for—namely, justice—but they did not build the tanks without bad holes, the water, and the big-mouthed, one-hour men, and the county and state officials. Our brave men last summer were working under a deputy last winter and I guess the deputy and his big gun made them do good work.

When we got the goods on the Ritter-Conly Company for bringing men into the state under false pretense, the county attorney told us he could not do anything for us, that the county was bankrupt, and I watched the papers and saw that the county treasurer turned over to his successor in office ninety thousand dollars, and the state labor commissioner's hands were tied. You can guess for yourself the reason. They had money enough to chain one of our members to a stake, all right, and let the scabs taunt him with a rope and guns, for which he is suing the Ritter-Conly Company for twenty-

five thousand dollars, and it looks good for him to collect. Brother David needs the money, but the poor company needs our sympathy; they did nothing, to hear them tell it; they did not tell the state labor commissioner that they had made mistakes; they did not tell him that they bribed heaters by paying them fifty cents more than the scale and a day's pay for moving from one camp to another and had an auto there to move him. They did not tell him that their crooks were selling groceries and meats, putting the cost of the camp up so that they were losing money. They did not tell him that they had autos to take all the farmers out to their jobs, and when the farmers got a good meal or two and a bed would leave the camp and then blame it on the local by saying that they were card men when the company never saw their books. They did not tell him they had men going from job to job calling strikes to get men, but they had, and we can prove it; but they did not give us the chance. They did not tell about putting a green man with an experienced man and discouraging the good man and was willing to collect the permit money for us, something that never should have been done. When the company collected that permit money they were doing the local's business.

Our permit system was very loose. members of our local could bump a permit man whenever he felt like it, and there were some good permit men bumped for members who worked a day or two and blew up. What should have been done was to issue a permit, and make the man pay for it before he went to work and allowed nobody to bump him until pay day. We applied for a charter for Drumright to try and remedy those evils; we were turned down, for what reason I do not know, but God knows we needed a charter.

Our Fourth International Vice-President, Brother Louis Weyand, was here June 1, 1914, and he saw the need of a charter, and let me say right here that our Fourth International Vice-President did not better things any by his actions; he allowed the members at the meeting that night to bluff him, and then went to the Warren City Boiler Works Company officials and told them it was impossible to control the men. Pretty poor, don't you think? We can't go to the company and beg them to eliminate the mistakes. We have learned a great lesson in this strike and we beg of the Grand Lodge and the members at large to eliminate our mistakes of the past and we will do better in the future, even if it comes to the weeding out process.

J. E. DIXON,
Past President Lodge No. 592.

Fort Worth, Tex.

Dear Sir and Brother:

There appeared in the city of Fort Worth very recently an old-time friend of the

writer and one of the old guards that is pretty well known over a good portion of the country. He called on the writer and seemed to be in a very nervous condition, although apparently perfectly sober; wanted to get acquainted with all the county officials, especially the county clerk and justice of the peace.

We led him around and did our part. After a good bit of stalling around, he departed. This morning, while things were pretty busy around the office, said party appeared with a good looking young lady (Miss Mary E. O'Connell of Batesville, Ark.), and requested that we produce a justice of the peace. This was done, and the office force of the county tax assessor witnessed the ceremony that united Miss Mary E. O'Connell and our old friend, Brother J. G. Hill, now of Lodge No. 382, in marriage. After congratulations and best wishes had been extended, the newlyweds departed on a honeymoon, after which they will be at home to their friends at Stamford, Tex., where Brother Hill is employed.

All friends here extend to Mr. and Mrs. Hill their best wishes for a long and happy wedded life.
A FRIEND.

A WORD ABOUT GOVERNMENT INSPECTION.

Why is it that some terrible calamity must happen before the people ask for an investigation? It is always a case of locking the stable after the horse is stolen. Now the clamor is for an investigation of the steamboat inspection bureau on account of its inefficiency. Can anyone expect anything but inefficiency when the manner of appointing the inspectors is considered.

Every bill offered in congress meets with a strong opposition from those who imagine their interests jeopardized. It finally comes up for passage in a compromise form. Generally as far as it goes, if carried out, it is adequate. But when it comes to filling the positions created to make it effective, all sight of the law is lost track of. It is forgotten, or ignored, and politics enter strongly. Incompetent men are appointed to fill the positions of steamboat inspectors. We have pilots or masters as inspectors of hulls and marine engineers as inspectors of boilers. These positions should be filled by practical ship builders and boiler makers.

The same practice exists in all departments of the government. Take the case of the locomotive inspection law. We have as chief inspector a locomotive fireman, and as assistant chief inspectors a locomotive engineer and a mechanical engineer.

Section three of the law reads that there shall be appointed by the president and with the advice and consent of the senate a chief inspector and two assistant chief inspectors of locomotive boilers, who shall have general superintendence of the inspectors hereinafter provided for, direct them in their duties hereby imposed upon

them, and see that the requirements of this act and the rules, regulations and instructions made or given hereunder are observed by common carriers subject hereto.

The said chief inspector and his two assistants shall be selected with reference to their practical knowledge of the construction and repairing of boilers, etc.

Not one of these men have had any practical experience in this line of work, yet they sit on the throne, giving out instructions to the men of actual mechanical experience how to do work, of which they know nothing more about than what they have read in a book. Is it to be wondered at that there is no efficiency in these departments? Still the people pay the bills.

Would anyone who had a watch broken, or wished to have it inspected, take it to the village blacksmith, or would be, if seriously sick, call in the man at the soda fountain in a drug store, or some physician's office girl? The answer is most emphatically no.

The position of inspectors belong to practically trained men in the line of work they are supposed to inspect and pass upon. Then there will be efficiency in their department.

About seventy-five per cent of the district inspectors of locomotive boilers have had no experience and practical knowledge of the construction and repairing of boilers.

If we are to have an investigation of the steamboat service, let us include the locomotive boiler inspection service and other departments, too, in which the positions are filled by men not fitted for their work.

Warren S. Stone, grand chief of the Brotherhood of the Locomotive Engineers, in his plea for the enactment of this law to Secretary Straus of the Bureau of Commerce and Labor, February 10, 1909, on page 15 of the proceedings, stated that "nothing but practical boiler makers would do for inspectors" and that "we do not expect any of our class of men (locomotive engineers) to come into the service."

Mr. Stone never spoke more truth in his life yet. As soon as the law was passed he used every effort to have these engineers appointed. He succeeded, too. This shows that among Mr. Stone's good qualifications, consistency is not included in a political matter like the inspection service law before and after its passage.

Ex-President Taft a short while ago in one of his speeches to college students, stated that the railroads were being ruined by the labor agitators who were dictating to congress. Still he is responsible for the appointment of incompetent men as chief and assistant inspectors of locomotive boilers at the dictation of Warren S. Stone. President Wilson followed directly in Mr. Taft's footsteps.

The inspection is doubtlessly as good as can be expected under the existing conditions but the law is not being carried out as intended (on account of incompetency), the inspectors cannot do well even when they are doing their very best, the Lord

will forgive them, because they know not what they do excepting when the pay check comes.

An amendment to the law will soon go into effect, which covers the inspection of the entire locomotive and tender. We will then have engineers and machinists passing judgment on boilers and boiler makers, doing the same thing on machinery and moving parts of the locomotive, each approving or condemning parts he knows nothing about. Can a bigger farce than this be imagined? If these conditions are to continue as they are, would it not be the greatest wisdom to repeal a law that is carried out in such a farcical way? If we are to have these laws, let us have competent inspectors to enforce them.

How long the people will put up with paying \$300,000 per year for this class of work and the enormous unnecessary expense required of the railroads, is a question.

FAIR PLAY.

Pueblo, Colo.

Dear Sir and Brother:

In compliance with the request made by you, that I give you an article for the Journal, showing the condition of business in this district, I am sending you a brief outline of conditions as I have found them at the various points on this system. At this particular time the D. & R. G. is doing an exceptionally good passenger business, due to the fact that two large expositions are in progress in California at this time. Also a large amount of the traffic may be due to the European war, which has had a tendency to keep the majority of our citizens within the confines of our own country the past summer. The freight business on this road has not made much material gain so far. It has had a tendency to remain quiet and I could not predict when the freight business will resume its normal condition. In the majority of shops on this road large numbers of men were laid off last January and February and in some instances these men have not yet been returned to work. In the larger shops, however, at Denver and Salt Lake City, the full force of men are at work. In further reference to the passenger traffic, which is on in full force at this time, I wish to fully concur the sentiments of Helper Lodge No. 473 and Lodge No. 103, wherein they express their gratification to the members of this Brotherhood who have made use of the "Scenic Line" in their travels to and from the expositions. We fully appreciate this patronage, realizing as we do that the D. & R. G. is the only fair road in the west at this time. It would not be amiss at this time to discuss the conditions relative to the number of hours and men worked now, as compared to a few years back, previous to the construction of the modern up-to-date locomotives. Some few years ago we were working under an agreement that provided a nine-hour work day, and it appears that we had double the number of men working then than we have

now under the eight-hour work day. Now this is not saying anything detrimental towards the eight-hour day, as we shopmen on this road are vastly proud of the fact that this road was the first to sign up with its men for an eight-hour day. I merely emphasize the fact that the large engines of today have put many of our members out of work and they also create havoc among the roadmen by reducing their working force.

We have received numerous letters in the past from our members on other roads, making inquiries regarding the eight-hour day, also in regard to the three shifts in round houses as it is worked on this road, and in answering these letters we have always aimed to boost the eight-hour day, also the three shifts in round houses. We figure that working these shifts in this manner that it should provide more men with work, and it has done so in some instances.

Trusting that I have not intruded upon too much of your valuable space and with kindest regards, I remain,

Yours fraternally,
GEORGE S. WARDEN,
 Pres. Dist. Lodge No. 22.

Clifton Forge, Va.

At the last regular meeting of Mountain Lodge No. 238, I. B. of B. M. & H. of America, the following resolutions were adopted:

Whereas, It has pleased Almighty God in His divine wisdom to remove from our midst the dearly beloved mother of our worthy and esteemed brother, M. Ruark; therefore, be it

Resolved, That we, his fellow brothers, extend to our brother, our heartfelt sympathy in this, his hour of bereavement, and pray that Almighty God may comfort and console him, and that he will bear his sorrow with fortitude; be it further

Resolved, That a copy of these resolutions be spread on the minutes of our meeting, a copy be forwarded to our esteemed brother, and a copy be forwarded to our official Journal for publication.

A. J. HAUR,
 Chairman.
J. W. LIPES,
A. R. KENT,
J. SIRLES,
 Committee.

Clifton Forge, Va.

At the last regular meeting of Mountain Lodge No. 238, I. B. of B. M. & H. of America, the following resolutions were adopted:

Whereas, It has pleased Almighty God in His divine wisdom to remove from our midst, the dearly beloved father of our worthy and esteemed brother, Charles Shepperson; therefore, be it

Resolved, That we, his fellow brothers, extend to our brother, our heartfelt sympathy in this, his hour of bereavement, and pray that Almighty God may comfort and console him, and that he will bear his sorrow with fortitude; be it further

Resolved, That a copy of these resolutions be spread on the minutes of our meeting, a copy be forwarded to our esteemed brother, and a copy be forwarded to our official Journal for publication.

A. J. HAUR,
 Chairman.
J. W. LIPES,
A. R. KENT,
J. SIRLES,
 Committee.

Clifton Forge, Va.

At the last regular meeting of Mountain Lodge No. 238, I. B. of B. M. & H. of America, the following resolutions were adopted:

Whereas, it has pleased Almighty God in His divine wisdom to remove from our midst the dearly beloved sister of our worthy and esteemed brother, S. H. Hasten; therefore, be it

Resolved, That we, his fellow brothers, extend to our brother our heartfelt sympathy in this, his hour of bereavement, and pray that Almighty God may comfort and console him, and that he will bear his sorrow with fortitude; be it further

Resolved, That a copy of these resolutions be spread on the minutes of our meeting, a copy be forwarded to our esteemed brother, and a copy be forwarded to our official Journal for publication.

A. J. HAUR,
 Chairman.
J. W. LIPES,
A. R. KENT,
J. SIRLES,
 Committee.

Clifton Forge, Va.

At the last regular meeting of Mountain Lodge No. 238, I. B. of B. M. & H. of America, the following resolutions were adopted:

Whereas, It has pleased Almighty God in His divine wisdom to remove from our midst, the dearly beloved father of our worthy and esteemed brother, J. Williamson; therefore, be it

Resolved, That we, his fellow brothers, extend to our brother our heartfelt sympathy in this, his hour of bereavement, and pray that Almighty God may comfort and console him, and that he will bear his sorrow with fortitude; be it further

Resolved, That a copy of these resolutions be spread on the minutes of our meeting, a copy be forwarded to our esteemed brother, and a copy be forwarded to our official Journal for publication.

A. J. HAUR,
 Chairman.
J. W. LIPES,
A. R. KENT,
J. SIRLES,
 Committee.

Kansas City, Mo.

To Officers and Members of all Lodges:
 The time has come when you all must stay awake and do business.

The traveling members and the secretaries that are asleep on the job better

come to time. Some of the former and some of the latter are awful. In connection with this I want to tell a little story. Not long ago a couple of traveling members arrived on the corner, a little more for booze than they ought to be, they didn't care for the brothers that were employed or the secretary of the lodge until they went broke, then they wanted money and transportation out of our city.

They got brave and bold and the chairman of the shop committee refused to leave his work and take them to the M. M. office. Why, the air was blue; then to cap the climax they, or rather one of them, pushed a brother boiler maker in the face. These two brothers names are George Hammer, Reg. No. 84378, and J. D. Dunden, Reg. No. 91850. Things like this should not happen because every time the shop committee visits the office of our M. M. things like that are told to the committee.

Another thing to my brother secretaries:

Answer letters. How long would anybody stay in business if they waited 10 days for an answer to all letters to a city not over 140 miles away? Have written letters to secretaries and business agents and members of boards of trustees this year and haven't received answers to them. Now, brother secretaries, don't let everything sleep; it only takes three or four minutes to answer a letter, unless the party would want a world of information. Do business on business lines and stay ahead of the flag. Traveling members use some judgment, don't expect the committee or the president of the local to stop his labor at any time to talk to you. That's what caused some of these fences to be placed around the different shops.

Hoping I haven't stepped on many toes, and with best wishes for union progress, I remain,

Yours fraternally,

WALTER E. DWYER, S. L. 32.

A Compilation of Labor News.

BY THE A. F. OF L. NEWS SERVICE.

TRIUMPH FOR ARBITRATION.

Chicago.—The Union Leader, official magazine of the local street car men's unions, has this to say of the recent arbitration award:

"The award restores to the street railway men of Chicago a condition they enjoyed practically since the roads started, which was taken from them by the Carter award of 1913—the straight, short-hour night car. Elective not later than January 1, 1916, all night car runs shall be straight, not more than eight hours, and they shall pay \$3 per night for eight hours or less.

"Another feature of the award is the straight Sunday run, not to exceed nine hours.

"The award is a decided victory for arbitration. It demonstrates the power of arbitration to establish just compensation and conditions when administered by fair-minded men. It has restored arbitration to its proper standing as a means of settling industrial disputes, and has given the workers renewed confidence that justice can be realized when men with courage to do the right have the opportunity of passing upon their grievances.

"The Amalgamated members of Chicago have great cause for rejoicing. As an organized body they have been struggling for thirteen years to establish adequate wage and fair working conditions. They have made gradual advances and at times have met with disappointing rebuffs. It has been a hard and long struggle, but through it all our membership has never wavered, and to this loyalty to the principles of the Amalgamated as much as any factor may be attributed the present success."

OHIO UNIONISTS OPPOSE PRIVATE COMPENSATION.

Columbus, O.—State Insurance Commissioner Taggart has ruled that liability insurance companies have a legal right to write workmen's compensation in competition with the state compensation fund.

The decision is a victory for the private insurance companies in their fight with the state industrial commission and the Ohio state federation of labor, which have insisted that the Ohio law barred all private insurance companies.

Under the decision the private companies will furnish employers with the bond they are required to post with the state industrial commission as a guarantee that he will pay the state's schedule of awards. Then the insurance company, for a certain amount, assumes the employers' risks. The industrial commission and the unionists point out that under these circumstances injured workers will not receive the prompt attention given them by the state insurance fund and the purposes of the compensation law are destroyed.

President Voll and Secretary-Treasurer Donnelly of the Ohio state federation of labor have employed counsel and will carry Insurance Commissioner Taggart's decision to the courts. It is possible unionists will initiate a constitutional amendment covering the question.

Thomas J. Duffy, ex-president of the National Brotherhood of Operative Potters, which as member of the state industrial commission, related this incident to show the methods employed by the private companies:

"A Niles man was killed and under the state compensation law, his widow was entitled to \$3,000. The employer had put up the necessary bond with the state commission and was having a liability insurance company carry his compensation for him.

"There was only one thing for the insurance company to do under the law: Pay the widow the \$3,000.

"The commission discovered, however, that agents of the insurance company had talked the widow into 'settling' for \$1,500. The commission promptly forced the company to pay her \$3,000."

THEORY OF COMPENSATION.

Indianapolis.—The state industrial board has started an educational campaign to acquaint employers and employes with the provisions of the new state compensation law. In its first bulletin—No. 1—the board, in showing the advantages of the law, says:

"It secures promptly to the injured workman, and, in case of his death, to his dependents, a certain compensation instead of the often long delayed and very uncertain final result of a lawsuit.

"The compensation, in the first instance, is made to fall upon the employer, not as a punishment, not because he was at fault, but in order to throw the burden ultimately upon those who enjoy the product and who pay the compensation, thereby render to the injured workman what is justly due him and prevent him and his dependents from becoming the objects of a most undesirable charity.

"Under the old system only a small per cent of the injuries resulting from industrial accidents were actually compensated. The premiums paid for liability insurance, and which was considered a legitimate item in the cost of production, were largely expended in defending lawsuits. This system resulted in actual waste.

"Under the compensation system it must be expected that the number of payments will be greatly increased, but the elimination of the waste incurred in the litigation of claims under the old system will certainly have a material effect in keeping the cost of compensation within reasonable limits."

DEFEND SEAMEN'S LAW, NOW.

Racine, Wis.—Says the Racine Call: "How strange it seems to read commendations for the La Follette seamen's bill. One scarcely believes his eyes when he picks up a paper which a week ago was picturing the most disastrous results to American shipping because of the new law, and finds therein strong editorial demands that the La Follette law be enforced and strengthened if need be, or criticism of government officials for not putting it into effect sooner.

"As usual, there is a scurrying for padlocks after the horse has been stolen, a terrific demand for investigation after it is too late to investigate. The probe of the Eastland disaster has shown the cause to be overloading and now comes the horrify-

ing information that federal inspectors had authorized a larger passenger list than even our present archaic laws permitted.

"If the fifteen hundred who went down in this old tub, sacrificed on the altar of personal greed, serve to arouse the nation to a sense of its duty regarding protective navigation laws, they will not have died wholly in vain. But let the dividend pirates who have fought against proper regulation carefully regard the horrible price which they have compelled the Nation to pay for such laws."

ARBITRATION IS URGED.

Boston.—The state board of conciliation and arbitration is conducting a publicity campaign to create a favorable public opinion for its work. It asks: "Why strike or lock-out, unless all legal and peaceful methods to adjust industrial disputes have failed?"

The board possesses no mandatory power, and in urging employers and employes to accept its good offices, says:

"The board will make public its conclusions and recommendations, setting forth what ought to be done or submitted to by either or both parties to adjust the controversy. A decision will be made within three weeks after the date of filing the petition, or within a reasonable time consistent with the duties imposed by a fair and impartial investigation.

"If public sentiment is of value after a strike or lockout, it surely should be respected before either takes place."

MINIMUM WAGE LAW DECLARED INVALID.

Fort Smith, Ark.—Judge Paul Little, of the circuit court, has declared the Arkansas minimum wage law for women unconstitutional.

J. B. Crowe, a laundry proprietor, was found guilty in a justice court of violating the act and on appeal to the circuit court. Judge Little upheld these four contentions of the accused:

That the bill signed by Governor Hays was not the same bill passed by the legislature; that the bill was illegal because it imposed a penalty upon an employe as well as an employer; that the bill is in conflict with section two, article two, of the state constitution; that the bill is in conflict with the fourteenth amendment of the federal constitution.

State officials announce they will appeal the case to the state supreme court.

The law was passed by the last legislature, and was intended "to regulate the hours of labor, safeguard the health and establish a minimum wage for females in the state of Arkansas."

A fifty-four hour week was provided for, and all females who had six months' practical experience in any line of industry or labor should be paid not less than \$1.25 a day. Under six months' experience a rate of not less than \$1 a day should be paid.

The law gives a commission wide powers to reduce rates "if said commission should find, after an investigation, that a lower minimum rate of wages is adequate to supply a woman or minor female worker engaged in any occupation, trade or industry the necessary cost of proper living."

RECORDS BROKEN IN STEEL.

New York.—The announcement that wages of the Bethlehem Steel Company's 17,000 employes has been increased created no surprise to those acquainted with present conditions in this industry. These conditions are most sensational, and it is agreed that concessions are necessary if non-unionism is to continue in this industry.

The remarkable turn in steel, because of war and railroad orders, is shown in the report of the United States Steel corporation for the quarter ending June 30. The earnings for this period were \$27,950,055, and is an advance of \$15,492,246 over the first quarter of the year. It is predicted that the figures for the third quarter will equal, if not exceed, the highest quarter (in 1909) ever registered by the steel corporation.

It is known that trade unionists who are scattered throughout the steel industry are quoting these figures as a reason why workers should organize and demand substantial wage increases and improved working conditions.

NEED NOT TAKE RISK.

Trenton, N. J.—Justice Kalisch of the state supreme court has ruled that a human being is not compelled to take a risk of death, however slight, in order that the money obligations created by law in a workman's favor may be minimized.

This decision was made in the case of a worker who was injured while in the employ of a railroad. A serious case of hernia developed and in the suit for damages the worker was only allowed partial compensation by the lower court, which sustained the company in its claim that an operation would cure the worker in six months.

The case was appealed to the supreme court and the railroad attorneys again quoted medical reports to show that out of 23,000 operations for hernia only 48 have proved fatal. Justice Kalisch dissented from the views of the lower court and rejected the company's position. The court ruled that even though the peril to life seems slight, the worker is not required to submit to an operation to minimize the liability of the company under the employers' liability law.

HAVE A RIGHT TO PICKET.

Jersey City, N. J.—Magistrate Dolan has ruled that strikers have the right to picket and has dismissed several girls and men employes of the Riegel Saek Company. There are about 200 girls among the strikers who have formed a union and are being assisted by A. F. of L. organizers. The work-

ers' grievances include a system of fines, "speeding up," wage reductions, and other poor working conditions. Jersey City trade unionists have joined the strikers in protests against officious police methods which has resulted in numerous arrests. The decision of Magistrate Dolan will tend to check the intimidating tactics of these guardians of the law.

WANT MINERS' MONEY.

Fort Smith, Ark.—Attorneys for the non-union Bache-Denmann Coal Company still insist that their clients are entitled to damages under the Sherman anti-trust law and have filed a second demurrer to Federal Judge Youmans' rulings.

The original suit involved about 200 union miners and their officials, who were asked to hand over three times \$427,820.77, as provided by the Sherman anti-trust law, because of alleged damages following a strike when the company placed its mines on a non-union basis.

When the suit came for trial, the miners' attorneys held that the coal company was not interstate and did not therefore come under the Sherman anti-trust law. Judge Youmans sustained this position. The company presented a demurrer to this decision, but the court refused to concur.

The company then presented a second demurrer, which the court is now considering.

Attorneys for the miners are hopeful that their succession of victories will continue.

OTIS MUST PAY DAMAGES.

Los Angeles, Cal.—After three hours' deliberation a jury awarded Joseph Scott, an attorney in this city, a verdict of \$30,000 damages against Harrison Gray Otis, and the character destroying campaign of this well-known union hater has been temporarily checked.

The attorney conducted his own case, and in pleading to the jury that Otis' attack entitled him to damages, said:

"Has it come to this in this country, that a man can't make a living, that he cannot practice his profession unless, like the serf of old, he bends his back and bows himself before the Los Angeles Times in order that he may have a chance to do it? Has it come to a place in this town that a person outside of authority, without any legal or official title to give orders, shall say to me or to you or to anybody else that we shall not make a living in this community and must go hence?"

WHY SAFETY LAW IS OPPOSED.

Washington.—"Will congress take a back track on the question of safety of life at sea and on the great lakes because greater safety means greater expense to shipowners?" asks the Washington Post, in an editorial entitled "Why Shipowners Do Not Like the Safety Law."

The Post continues:

"Under the La Follette law the Eastland would not have been permitted to carry

more than two-thirds as many passengers as were on board when she capsized. Provision would have been made for lifeboats and liferafts for all on board instead of boats and rafts for 771 out of a total of 2,500 passengers.

"The La Follette law will go into effect in November. If it had been in effect this month, the Eastland would still be afloat."

"THEORETICAL" WAGES.

Palmer, Mass.—"Theoretical" wages is the latest in this age of efficiency and invention of new terms. Superintendent Lauren, of the Wright Wire company, explained the new system to the state board of conciliation while that board was adjusting differences between the company and its striking employes. Lauren told the conciliators that when he took charge of the plant they were different wage schedules. These had now been supplanted by a piece work and bonus system, which would permit the workers to earn—theoretically—from \$15 or \$25 to \$30 a week.

The superintendent acknowledged conditions might arise whereby workers might not make "from \$15 or \$25 to \$30 a week."

In other words, there is a difference between theoretical wages and the actual cash.

ACCIDENT BOARD RULING.

Sacramento, Cal.—The state industrial commission has awarded benefits, under the compensation law, to the heirs of a worker who was suffocated in a tank, even though the worker had contributed nothing to the support of his mother and sisters during the nine months preceding his death. The board held that this was probably due to lack of employment. Benefits were awarded based upon his average contributions for three years prior to his death.

SHOW INCREASED EARNINGS.

Washington.—Railroads of this country continue to increase their earnings despite pleas that higher rates are necessary to give them proper returns.

In June last, 67 of the principal roads reported net revenues of \$406 a mile, according to an interstate commerce commission report. In June, 1914, this revenue was \$357, giving the roads an increase of \$49 a mile this year.

The operating revenues of the companies in June totaled \$105,315,869 and the operating expenses \$69,934,210, leaving net operating revenues of \$35,381,659.

UNIONISTS TO CONFER.

Newark, N. J.—Officers of the New Jersey State Federation of Labor have issued a call for the annual convention to be held in Jersey City, beginning Monday, August 16. Attention is called to the need for a full representation that the increasing activity of the Manufacturers' Association may be resisted. It is stated that this organization "seemed in control" of the last State Senate, "and not a single measure was passed of benefit to the wage earners."

LAWSON VERDICT APPEALED.

Denver.—Attorneys for John R. Lawson have filed an appeal with the state supreme court.

The appeal makes the same allegations of error that were made in the application for a new trial, recently denied by Judge Hillyer. Among the charges is included the affidavit of Grover Hall, a member of the jury, who says that he was induced to consent to a verdict of guilty by coercive measures employed by Frank Gooden, a bailiff.

The supreme court already has before it a petition for a writ of prohibition to bar Judge Granby Hillyer, who sat in the Lawson case, from presiding at future trials growing out of the miners' strike.

LOSSES IN TIMES OF PEACE.

San Francisco.—"While we stand appalled at the enormous loss of life and treasure which has been going on in Europe in the past twelve months, we should not forget the victims of the deadly conflict constantly going on in our own peaceful land," declared President Willet to the National Association of Life Underwriters, in convention in this city. "Statistics tell us that 650,000 lives are annually destroyed in the United States by diseases of the preventable class. The annual economic loss from this source is estimated at \$1,500,000,000, or six times the amount of our fire loss."

LEASE SYSTEM OPPOSED.

Montgomery, Ala.—Trade unionists, railroad brotherhoods, farmers' organizations and associations of business men have joined in an appeal to Alabama citizens to assist in the fight against convict leasing in this state. With this joint appeal is the report of the legislative investigating committee, which depicts the horrors of this system and the working of convicts in mines and in camps for commercial reasons.

LABOR LAW FORCES CHANGE.

Des Moines, Ia.—The new child labor law, which took effect last month, is forcing laundries in this state to change their working systems because of a provision that no girl under 21 years of age shall be employed at any occupation where she will be required to stand on her feet continuously.

METAL TRADES THANKED.

Washington.—Officers of the A. F. of L. metal trades department received a letter from the Panama metal trades expressing the thanks of union labor on the canal zone for assistance in securing a postponement of the order compelling payment of house rent until the canal is completed. The canal unionists ask that publicity be given this letter "so that the various organizations throughout the country may know that the efforts of the metal trades department in behalf of labor on the zone have borne fruit and are appreciated by us."

PICKETING IS LEGAL.

San Diego, Cal.—City Attorney Cosgrove's opinion on the right of workers to picket has checked those members of the city council who favored passing an ordinance that would prohibit all forms of picketing. The city attorney held that it was legal to pass laws stopping crowds from congregating, but an ordinance which attempts more is unquestionably an invasion of private rights.

MINERS "SHORT WEIGHTED."

Boulder, Colo.—Investigations by the state industrial commission again call attention to the practice of "short weighting" miners in this state, one of the causes which led to the recent strike. At one mine the commission found that workers were robbed of from 500 to nearly 1,000 pounds of coal during the first two weeks in June. This amounted to a clear wage reduction of \$13 a month.

LARGE FUND FOR EDUCATION.

Springfield, Ill.—Gov. Dunne has signed the University of Illinois bill carrying the largest sum ever appropriated by a single law to a single institution of higher learning in the United States, amounting in all to an even \$5,000,000 for the two years. The bill was supported by organized labor.

END STRIKE BY FORCE IS HINTED IN CANADA.

Vancouver, B. C.—The British Columbia Federationist, official newspaper of the Trades and Labor Council, this city, raises a warning cry against the plan of compulsory arbitration which, the public press states, is to be urged before the incoming Manitoba legislature, by W. H. Reeve, fair wage officer of that province.

The British Columbia Federationist says: "The opinion of those who have had close experience of similar legislation in Australia does not tally with the glowing approval which we understand Mr. Reeve expressed concerning it.

"We do not think that organized labor in this country will show any enthusiasm to be muzzled with such a measure. We already have on the statutes a law enforcing arbitration of industrial disputes which involve public utility enterprises. But even at that, the findings of the board of investigation cannot be enforced by law. Their acceptance by either party to the dispute is purely optional. With only that element of compulsion in it, the act has met with very strenuous criticism at the annual conventions of the Trades and Labor Congress of Canada, and from the unions separately.

"But when it comes to compelling workmen by law to submit all disputes of an industrial nature to arbitration, we feel certain there will be vigorous opposition. If it should pass, there is still the matter of enforcing the penalties for striking in face of the act. This is not so easy to do where a mass of men is involved as where it is only one or two persons. That difficulty

has already arisen in respect to the industrial disputes investigation act, in cases where the workmen in the employ of a public utility corporation have gone on strike in violation of the law as set forth in the act.

"No proceedings were taken against them by the government, doubtless because political sagacity suggested that in such a case discretion was the better part of valor. One case of this kind locally was the electrical workers in the employ of the British Columbia Telephone Company. They were well organized. They knew exactly what they wanted. And they got it in five days by going on strike."

TRADE UNION METHODS WIN.

Sydney, New South Wales, Australia.—The Newcastle correspondent to the Australian Worker, published in this city, illustrates the value of setting wages by law and by trade union methods.

The Mechanics' union, in the northern part of the country, tried the wages by law plan, and after Judge Edmunds, chairman of the wages board, heard both sides, he ruled that "the time is inopportune for the granting of any increase in pay in and about the mines."

Against this decision, the correspondent places the trade union method, employed by the Miners' union of Maitland, which ignored the wages board, and through direct conferences with employers obtained recognition of the right of the men to be paid on the basis of the price obtained for coal. A later conference paved the way for the improvement of wages of certain off-hand workers.

According to the correspondent, the miners "have expressed the opinion, personally and through their officers, that the wages board system has proved most unsatisfactory to them and that this latest decision (Judge Edmunds') is not such as to make them feel more kindly toward the system."

A STIRRING APPEAL.

Melbourne, Australia.—Under the caption "Be a Unionist, Body and Soul," the Labor Call of this city says:

"If you don't want to be trodden on, join the union.

"Do you want to be well fed, well housed, well clothed and well read? Join the union! Do you want to help your mates along? Join the union! The monopolistic press and the monopolist may tell you that such desires are vicious, but, instead, it is need of things necessary and good that makes men vicious. Where wages are highest, there will be found the most prosperous nation and the most contented people. There will education be the most generally diffused. There will morality be the purest; there will patriotism be the most profound. Help to make your country prosperous; help to liberate mankind. Join the union! Swear by the union! Work for the union!"

A WISE JUDGE.

Sydney, New South Wales, Australia.—Under the arbitration laws courts have the power to order that preference be given unionists by employers. In a recent case Judge Cusen of the arbitration court ruled:

"I give preference to unionists in this case because I am convinced that the man who gives a considerable portion of his time

each week, and a considerable portion of his earnings each week, to try to improve the conditions in which he lives, is justly entitled to more consideration than the man who remains outside and will not give a portion of his time or a fraction of his money to better the conditions of himself and those who are dependent upon his earnings."

Among Our Exchanges.

GRIEVANCES.

Some persons are always in an uncomfortable frame of mind if not downright unhappy. And this even when there is not any real cause for unhappiness or grief, but when small offenses or negligences to which no second thought should be given are magnified. The more one allows his mind to dwell on these things, the greater he finds them. He views himself as being always in the right, and recounts the favors he has bestowed. These so occupy him he forgets favors received. With this disposition, a man seldom stops at nursing his wrong thoughts in his own mind. He talks of them to others, presenting the character of one with whom he is offended in a wrong light, thereby doing an injustice. He is so filled with bitter thought of his grievance that his gloomy face and dismal tone cast gloom on those about him. He becomes so morose that his company is disagreeable. Others, observing his disposition to take offense quickly, feel that it may be their turn next to irritate him. One cannot enjoy freedom of conversation when someone is watching for slights. How much better it would be in the first place to say, "He meant no offense," or "Perhaps he has troubles of his own that make him negligent." Better first look fairly at one's own conduct and see if every work or every act will bear being weighed in the balance. Life is too short and too valuable to be wasted in useless dissension. Think the best and speak the best you can of everyone. You will be the better for it and the happier.—The Milwaukee Journal.

EVIL SPIRITS AT WORK.

A lengthy Washington news story published in several Eastern dailies, under the caption "Amendment of Seamen's Law to be Sought," contains the following significant item:

It is known, by the way, that the Seamen's law is very unpopular in the Commerce Department and, in fact, it was over their protest that the president permitted the bill to become a law.

There are just two men in the Commerce Department who would take genuine delight in spreading the impression that the new Seamen's Act is unpopular. Those two gentlemen are none others than Messrs. Chamberlain and Uhler, presiding respec-

tively over the Bureau of Navigation and the Steamboat Inspection Service.

Throughout the many years when the Seamen's bill was pending in congress these two men have never missed an opportunity to discredit the legislation embodied in the Seamen's bill. Now that the bill has become a law they are evidently unable to rid themselves of their old-time prejudice against this humane and progressive statute.

Really, it does seem unfair to place the interpreting and enforcing of an important epoch-making law of this character into the hands of men whose entire public career shows their utter inability to remain impartial when the seamen's welfare conflicts with the shipowners' interests.

The Seamen's Act is well able to stand upon its own bottom, but we may as well frankly admit that it has an awful load to carry in the persons of Messrs. Chamberlain and Uhler. Our confidence in the fundamental soundness of the Seamen's Act is so deep-seated that we feel certain of its successful operation even with this tremendous handicap. Still, may we not hope and trust that the spirit of fairness so strikingly manifested by practically all the acts of the present national administration will ere long deliver us from these twin evils?—Coast Seamen's Journal.

BUTTERMILK AND BACTERIA.

The popularity of buttermilk as a food and a beverage is attested by its widespread sale. Any drink which can succeed in invading the precincts of the saloon and compete for sale, as buttermilk now does, side by side with alcoholic beverages deserves attention. The plan of allowing milk to undergo fermentation of such a character that the products are not unpleasant or unwholesome for human consumption, yet serve as preservatives to prevent undesirable types of decomposition, is not new. The fermentation product chiefly depended on in such cases is lactic acid, although, in certain types, alcoholic fermentation may also be in evidence. Buttermilk belongs to the acid type; it usually contains from 0.6 to 0.9 per cent of acid. Strictly speaking, buttermilk is a by-product of butter-making; but with the development of the milk industries, the demand for buttermilk has frequently been met by fermenting the skin or separator milk which remains as a by-product

of the cream trade. The fermented product is not literally buttermilk, but it may be indistinguishable from the latter in composition and properties. The use of these fermented milk products has been favored, not alone for their intrinsic food value, but also for accessory reasons. The specific fermentation products have been reputed to have a "tonic" action in the digestive tract. Special virtues have been attributed to the lactic acid bacteria, particularly in relation to putrefactive changes in the alimentary tract. Aside from any alleged therapeutic virtues, there can be no doubt of the nutrient value of the beverages. With the growing attention devoted to the bacteria which milk may harbor, and the recognition of the dangers which they may entail, it is not strange that buttermilk also should demand bacteriologic consideration. Heinemann, of the Department of Bacteriology and Hygiene at the University of Chicago, has demonstrated that the presence of lactic acid in milk will destroy the germs of dysentery, typhoid, diphtheria and cholera. The slower milk sours, the greater is the danger of disease germs surviving. Acids other than lactic acid are frequently present in buttermilk. This beverage, Heinemann reminds us, should therefore be looked on with suspicion, especially if heavily polluted, unless it has been prepared from pasteurized milk. There is, however, a remnant of satisfaction to all lovers of the fermented product to learn that the chances of buttermilk becoming a carrier of infection are small.—The Journal of the American Medical Association.

FOUND THEM OUT.

The promises that the advocates of I. W. W. principles dangle before the mind's eye are like the apples of Sodom, which turned into ashes upon being put to the lips, so do the promises of these radicals become void when their dupes ask for their fulfillment.

These I. W. W. organizations are more mythical than real. They consist chiefly of a lot of hot-air merchants who have no conscience, who stir up trouble and discord for their own personal gain, having no connection whatever with any central organization. They are started by radicals, who have utterly failed in ousting reputable officers of the organization they intend to put out of commission. When they fall as they always must the innocent dupes they induced to join them are the one who suffer most.

The bunch that tried to capture the Whitaker-Glessner plants by what they thought a brilliant exploit of picketing union mills and trying to make the public believe that the real union men were scabs, and that the I. W. W.'s were the real union men have met the same fate that all false leaders must share when their real object has been discovered by those who were duped by their fair promises.

These radical leaders are now being deserted and their followers are petitioning

the Amalgamated Association lodges to reinstate and reobligate them. Yes, some of them are asking for these favors and willing to pledge their future undying fealty to the grand old Amalgamated Association.—The Amalgamated Journal.

A city man recently visited his "country cousin." The man from the city, wishing to explain the joys of metropolitan life, said: "We certainly have been having fun the last few days. Thursday we autoed to the country club and golfed until dark, then trolleyed back to town and danced until morning." The country cousin was not to be stumped in the least and began telling of some of the pleasures of the simple life. "We have had pretty good times here, too. One day we huggied out to Uncle Ned's and went out to the back lot, where we base-balled all the afternoon. In the evening we sneaked up into the attic and poked until morning." A sturdy old farmer who was listening, not to be outdone, took up the conversation at this point and said: "I was having some fun about this time myself. I muled out to the cornfield and gehawed until sundown. Then I suppered until dark and piped until 9 o'clock, after which I bedstedded until the clock fived, after which I breakfasted until it was time to go muleing again."—Montreal Journal of Commerce.

THE MIRROR AND THE WORLD.

"In the glass one sees smiles; another tears.
Same glass—why is it?"

In the same world one sees hopes; another fears.

Same world—why is it?"

The glass reflects the features of him who looks therein. Smile is returned for smile or tears for tears. With the world, as with the glass, one finds what he brings to it. Is a man suspicious and looking for evil? He will meet it on every hand. Does he seek goodness? He will find it all about him, lurking in unexpected places. The traveler intent on watching for obstacles or enemies, misses the wayside flower, the song of the bird, the music of the brook, the smile of a child. If he is on the lookout for evil, it comes to meet him and the good is unseen. Are you possessed by fear? You see danger in every shadow; you hear threats in the wind. Smile on the glass. Smile on the world. Hope and fear not. Believe in good and expect good in others and you will find it. Look for sunshine, look for joy, look for love and kindness. Do not miss the good while repining over wrongs, real or fancied. Be yourself what you would see in the mirror. Be yourself what you would find in the world.—The Milwaukee Journal.

SIGNS OF THE TIMES.

(Mrs. Mary E. Dustin in the Boston Globe.)

True, it does sometimes seem as if the world were going to the bad, if we judge from the daily news. But we must consider

the enormous increase in population, the fact that "many are running to and fro"; that there is no corner of the earth so dark or distant that the searchlight of modern enterprise does not find it out and explore it; that human nature remains unchanged amid all these changing conditions, retaining still its weaknesses and passions as well as its grand and noble impulses.

To sum it all up:

This world is not so bad a world
As some would like to make it,
But, whether good or whether bad,
Depends on how we take it!

And, taking it from the viewpoint of one feminine mind, there was never a generation better worth living in than the generation of today.

SENTENCED MINER CHARGES FRAME-UP.

Trinidad, Colo.—John R. Lawson, labor leader, convicted of murder, was denied a new trial by Judge Granby Hillyer in district court here.

Monday he was sentenced for life at hard labor in the state penitentiary. When asked by the court if he had any statement to make before judgment was pronounced, Lawson read this statement:

"In the name of the courts of my country, which I respect, I protest against your right to pass any judgment on me. It is undenied in this case that you were appointed to the bench this spring for the trial of myself and my associates.

"Fresh from the employment of the coal operators of Colorado, including the Rockefellers, who have engineered these prosecutions, yourself a coal company attorney, you were so prejudiced against me that my case in this court was a travesty on justice.

Scores Judge for Haste.

"Today the supreme court of Colorado in Denver is reviewing your conduct and yet you refuse to wait another twenty-four hours for the guidance of that court's decision. Such unseemingly haste in the exercise of such a jurisdiction to thrust me into prison should not be passed without protest."

Lawson charged that he had been the victim of a hand-picked jury.—Daily Press.

LARKIN'S SILLY PRATTLE.

Last week James Larkin, who styles himself an "Irish labor leader," delivered an address in Dreamland Rink and indulged in the Tom Mann brand of nonsense concerning unionism. His schemes are not only impracticable but are among the most dreary put forth by dreamers. He says:

"In Ireland we are building up a new form of unionism. It is on newer lines of industrial unionism. These unions are broadening their field of work.

"The economical development holds that an unskilled man on a job is entitled to the same wage as a skilled craftsman, because the family of one is just as much en-

titled to the same comforts of life as the other.

"In Ireland all union men employed in the construction of a building belong to the same general union and get the same wage."

Let us see how Larkin's reasoning would work out. He says the unskilled man is entitled to the same wage as the skilled craftsman. The skilled craftsman must spend years in acquiring his knowledge and his skill. He does not gain these things by chance, but as a direct result of application and the exercise of intelligence coupled with patient toil. If there is to be no reward for equipping himself with skill, what inducement is there to urge him on? If the unskilled man is to receive the same wage as the skilled mechanic, will we have any skilled men at all, and what will the consequences be?

We know that Larkin's statements will elicit applause and commendation from the unskilled, but nevertheless his scheme is unsound, unjust and impossible. He might just as well have gone on to state that the lazy, shiftless individual who spends his time loafing at the corner cigarstand and spitting all over the sidewalk is entitled to the same comforts of life as the industrious, busy man who spends every spare moment in equipping himself to be of service to humanity.

The unskilled worker is entitled to far more than he gets anywhere in the world at present, and should receive a wage that will enable him to support his family in comfort, but he is not entitled to the same wage as the skilled craftsman, who also should receive considerably more than he is accorded today.

Men nursing the Larkin brand of hobby do more to retard the progress of the workers than many open enemies of organized labor, because they are listened to seriously by the ignorant and illogical both in the labor movement and out of it, by both employers and employes, and as a result opposition is stirred up, time is wasted and unity is destroyed.

Of course, as the old expression has it, it takes all kinds of people to make a world, including the Larkin kind, but that does not mean that all are beneficial to the world. Some of them cause much pain and suffering and misery, and to this category, we think, James Larkin and Tom Mann and dreamers of their kind properly belong. We are not questioning their sincerity of purpose or their desire to help in lifting the human race upward, but they are laboring under delusions and nursing hobbies that drag men down and hinder progress.

Larkin may make a few converts to his plan, but he can not sway the great American labor movement from its true course. It is too well grounded and its membership too intelligent to be impressed by such irrational arguments.—The Labor Clarion.

News of General Interest.

PIPE WRENCHES WITHOUT SCREWS.

By Frank C. Perkins.

The accompanying illustration, Fig. 1, shows a novel pipe wrench without a screw, as developed at Bloomington, Ill. It will be noted that the pipe wrench operates en-

wrench does, and several things that they do not do.

There has also been designed a third angle wrench, which with its many adjustments takes the place of a quantity of different size solid "S" wrenches. By sim-

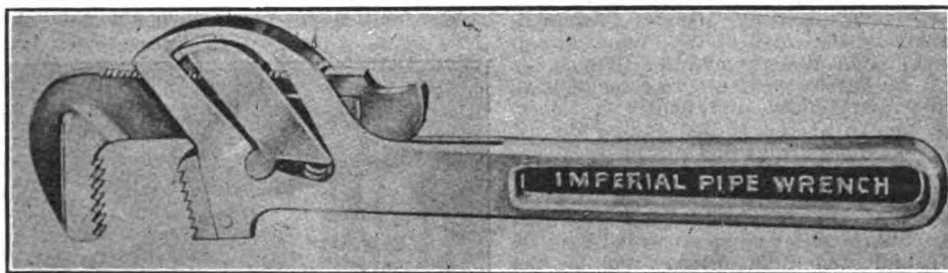

A PIPE WRENCH WITHOUT A SCREW.

tirely with the thumb, and, therefore, is quick-acting, doing away entirely with backing away, which, as everyone knows, happens on a wrench where a thumb-screw is used.

It is pointed out that the upper jaw has a much greater forward and back play than in any pipe wrench on the market, thus making it grasp much quicker and re-

ply pressing the thumb on the key, it can be ratcheted one notch at a time or all eight notches at once. The minute one releases the thumb from the key, the handle becomes perfectly solid, so that the nut can be turned either way. This wrench is made with a solid jaw, or with reversible cap, solid feature being for the mechanic, but the reversible cap feature, which makes it

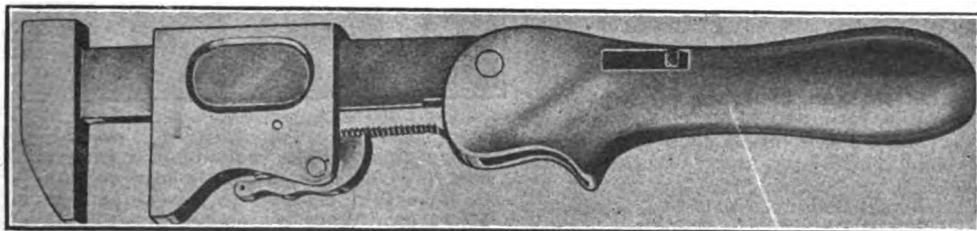

A MONKEY WRENCH WITHOUT A SCREW.

lease instantly. There are less than one-half the number of parts contained in the popular wrenches, there being only six in all in this wrench, and its construction makes it stronger than other pipe wrenches.

A monkey wrench also has been developed with a quick-acting jaw, as noted in photograph, Fig. 2, differing materially from other quick-acting jaws. It is a grip wrench, and the harder one pulls the handle, the tighter it grips the nut. Besides, it is a ratchet wrench. It does not need to be taken off the nut each time, but by merely pushing back on the handle, it automatically ratchets and grips for the next pull. The construction is very simple, and it contains no more parts than the ordinary monkey wrench and will do everything that an ordinary monkey

instantaneously a pipe wrench as well as a monkey wrench, makes it particularly adaptable to automobile owners and householders.

HISTORY OF CONTROVERSY IN THE CLOAK TRADE IN NEW YORK AND ITS SETTLEMENT.

May 20, 1915.—Cloak, Suit and Skirt Manufacturers' Protective Association abrogated Protocol three days before Board of Arbitration was to meet to consider wage increases, review of discharges and other vital disputes.

June 12, 1915.—50,000 Ladies' Garment Workers protest against abrogation of Protocol at mass-meeting at Madison Square Garden and begin preparations for general strike.

June 28, 1915.—Ultimatum sent to manufacturers by International Union and Joint Board of Cloak and Skirt Makers' Unions, demanding immediate settlement of disputes. Union offered to place their case before arbitrators headed by Mayor Mitchel or Louis D. Brandeis.

July 2, 1915.—Bosses agree to air differences before Council of Conciliation.

July 9, 1915.—Dr. Felix Adler, president of the Society of Ethical Culture; Louis D. Brandeis, Boston lawyer and economist; City Chamberlain Henry Bruere; Charles L. Bernheimer, chairman of the Committee on Arbitration of the Chamber of Commerce; George W. Kirchwey, Kent Professor of Law, Columbia University, and Walter C. Noyes, former judge of the United States Circuit Court of Appeals and one of the receivers for Greenhut & Company, named by Mayor Mitchel as Council of Conciliation.

July 23, 1915.—After 23 sessions at which arguments for union were presented by Morris Hillquit and union officers and for the employers by Julius Henry Cohen and many manufacturers, the council sustains union's demands and drafts model agreement to bring peace.

Wages Won by Week Workers.

	New Rate	Old Rate	Rate Asked
Cutters	\$27.50	\$25.00	\$30.00
Jacket Upper Pressers...	25.00	23.50	28.00
Reefer Upper Pressers...	24.00	23.50	28.00
Skirt Upper Pressers...	23.00	21.50	26.00
Skirt Under Pressers....	18.00	16.50	20.00
Jacket Under Pressers...	21.00	19.50	25.00
Reefer Under Pressers...	21.00	19.50	25.00
Sample Makers	23.00	22.00	25.00
Basters	15.00	14.00	16.00
Skirt Finishers	11.00	10.00	12.00

Wages Won by Piece Workers.

Operators granted wage of 70 cents an hour. They asked for 75 cents. The existing rate varies upward from starvation wages.

Finishers granted 50 cents. They asked for 60 cents. Present wages similar to operators.

Buttonhole makers granted prices of 90 cents to \$1.30 per hundred. They asked for \$1 to \$1.40. Present wages like operators and finishers, depending on ability of boss to force workers to accept his low wages.

Union Also Won.

Review of discharges of union members by impartial tribunal. This will protect against discrimination against union members.

Preservation of standards by protocol provisions.

Equal distribution of work during slack seasons to an extent not conflicting with efficient operation of shop.

July 28, 1915.—Bosses refuse to accept agreement without modification.

August 2, 1915.—Union vote 39,337 to 751 in favor of strike if original decision of Council is not accepted.

August 3, 1915.—Council requests union to

participate in final conference to avert general strike.

August 4, 1915.—Employers back down and accept original proposition.

NOVEL SAFETY BOILER APPLIANCES.

(By Frank C. Perkins.)

The accompanying illustration shows interesting and important boiler safety appliances developed at Everett, Wash. In this photograph it will be noted that (A) is a column connected to boiler with both water and steam connection, the same as

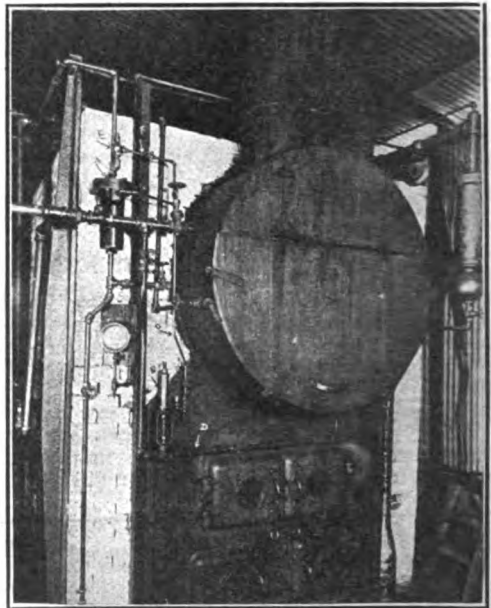

any ordinary water column and the ridge cast on column indicates where column is to be set in relation to lowest safe level of water. When water reaches this level in boiler, float in column operates a needle valve, which in turn admits steam to brass-pipe (C) and entering piston operated valve (B) opens valve (B), which admits water and steam through pipe (D) and nozzle into fire box, extinguishing fire almost instantly.

It may be stated that when water in boiler has been brought up to safe level, the needle valve shuts off and valve (B) closes, thereby letting firing be renewed with no damage or danger of any description being wrought. The small one-half inch spring encased relief valve marked (E) is for the purpose of protecting boiler from any increase in pressure. It can be installed directly on boiler shell or in main steam line or steam line to column as shown. It is a spring loaded valve and set for five pound over the set pressure of safety valve on boiler. If, for any cause, the safety valve on boiler sticks and does not release at pressure at which it is set, the valve (E) opens and admits steam to

valve (B) through brass pipe (C) and extinguishes fire in fire box the same as low water had occurred.

It is pointed out that both of these appliances can be tried out each day by simply blowing down column and noting that valve (B) operates. It is not necessary to put fire out with this operation, as valve starts moving slowly and water can be admitted to column before fire is deadened. Simply pulling lever on valve (E) operates valve (B) in the same manner as blowing down column. Valve (E) is set and locked with inspector's seal.

It is stated that when oil is used for fuel, the valve (B) is set in oil line to furnace and closes, shutting off oil supply to burners when boiler is in danger from either low water or overpressure. One of these appliances has been installed on a horizontal return tubular boiler at a plant in Everett, Wash., and is used a great many times. It has been tested out in different ways but in the majority of cases, water has been blown down in the boiler through blow-off valve while boiler was under full load and pressure with a heavy fire.

The appliance is set to operate just as water is going out of sight in water glass and fires have been put out on each occasion almost instantaneously. When appliance is installed on boiler burning fuel oil for fuel, the diaphragms or piston operated valve is then installed in the oil line to burners, and in case of appliances being made to operate from causes such as low water or overpressure the valve simply shuts off the oil to fires and does not admit steam and vapor to fire-box as now installed.

It is stated that questions have arisen as to whether or not the brick work or grates would be damaged by admitting water from boiler on to hot fires and walls. The water used being of the temperature of steam in boiler, when released to atmosphere through nozzles, flies into a heavy vapor, putting fires out and blackening walls. No damage of cracking walls or grates can occur.

It is said that some fear has been expressed that it were dangerous to take water from a boiler whose water level was already dangerously low. The amount of water required to deaden fire and hot brick work is very small and after the first discharge from nozzles it is immaterial whether all the remaining water in boiler is blown out as no damage from burning can result, and at the same time pressure is being reduced as long as valve remains open.

The valve (E) noted on the photograph is a spring encased relief valve set at or about 5 pounds over pressure at which main pop valve releases. If for any cause main pop valve stick or pressure increases so rapidly that said pop valve cannot handle it, the small valve (E) will operate and extinguish fires as in the case of low water. This appliance is superior to fusible plugs and the like, for the reason that operator

can determine at any time as to whether appliance is in working order by simply blowing down column. This is compulsory with water columns and could be made so in this case. Also no shut down of boiler is necessary, as is the case when fusible plugs burn out; for with this appliance fires can be started immediately upon safe water level being attained.

THE BABY'S VACATION.

At this time of the year the trains and boats are carrying thousands of families to the seashore, the mountains, or the farms for their annual vacations from the hot and crowded cities.

Among the host of travelers are many babies and young children. Indeed, it is chiefly on account of them that parents are willing to take all the trouble involved in the annual summer pilgrimage, the weariness of the journey, and the many inconveniences of a temporary home.

They are, however, usually repaid by the increased health of the children, and in the early weeks of September the trains are again filled with returning families of happy children whose sunburned cheeks, arms and legs, and irrepressible spirits show what tonic lingers in mountainside or country spaces.

Unfortunately, this is not always the case. Whether or not this change from city to country life is to be altogether beneficial or not depends upon the sort of living conditions into which the children will come, and upon the character of the milk supply and the drinking water.

In most cities, mothers, whether poor or rich, may have the benefit of carefully inspected milk and drinking water. In the country, it is a wise precaution to look into these matters before selecting the summer home. Flies and mosquitoes are two great enemies of the baby, affecting not merely his comfort, but endangering his health, and possibly his life. In going to the country, the mother should select, if possible, a place where the doors and windows and the porches are screened and one where water closets or some form of sanitary privy is in use. The latter improvements are not, necessarily, very expensive, and should be provided.

The prudent mother will include a bolt of cotton netting in the outfit she takes to the country in order that the baby's crib, at least, may be protected from insects.

In going to a new place with a baby all the drinking water, and the milk, also, should be boiled, if from a strange supply about the cleanliness of which the mother knows nothing.

To travel comfortably with a baby, the first thing to be considered is his food. If the baby is breast fed no trouble will be experienced. For a bottle baby enough feedings must be prepared at home to last throughout the entire journey, unless the trip takes longer than twenty-four hours.

It is best to sterilize the milk for this purpose as follows:

Stand the filled bottles in a kettle over the fire and let the water boil about them for an hour and a half. After cooling, the bottles should be gradually cooled, and then made as cold as possible by standing them in a pail of cracked ice. They may then be packed in a small portable refrigerator. Many types of these have been devised, and may be purchased. A portable ice box may be made at home as follows:

Use two covered tin pails, one an inch or two smaller than the other, so that it may stand inside the larger pail. Fill the space between the two with sawdust; put the bottles with cracked ice in the inner pail and cover both tightly, and make a canvas or flannel cover for the whole.

To warm the bottle for the baby, the mother should provide herself with an enameled ware pitcher holding a pint, which the porter will fill with warm water from the dining car. Set the bottle in it, after the water has cooled a little so that the sudden heat will not be sufficient to break the bottle.

The next most troublesome question on

traveling with children are with respect to their clothes and their food. In the hot summer weather, for a long journey, the little child should be dressed only in the sleeveless gauze shirt and diaper, with one thin outer garment. A sleeveless, low-necked slip of white china silk is best, since it is much cooler than cotton, sheds the dust and can be washed out in the basin when soiled.

It is well to change the baby's clothing as soon as the journey begins, in order to have the regular outfit clean to put on when leaving the train. The little baby may go barefooted but an older child should have barefoot sandals to protect the feet from the cinders scattered over the floor.

Mothers should observe the same regular hours for feeding their children as at home. One of the worst things she can do is to give the baby cakes, candy, bananas, sweet crackers, and the like, as so many mothers do, to keep him quiet in the train. This kind of irregular feeding, with unsuitable foods, together with the heat of the train, and the fatigue and excitement of traveling are very apt to upset the baby and make him irritable and restless.

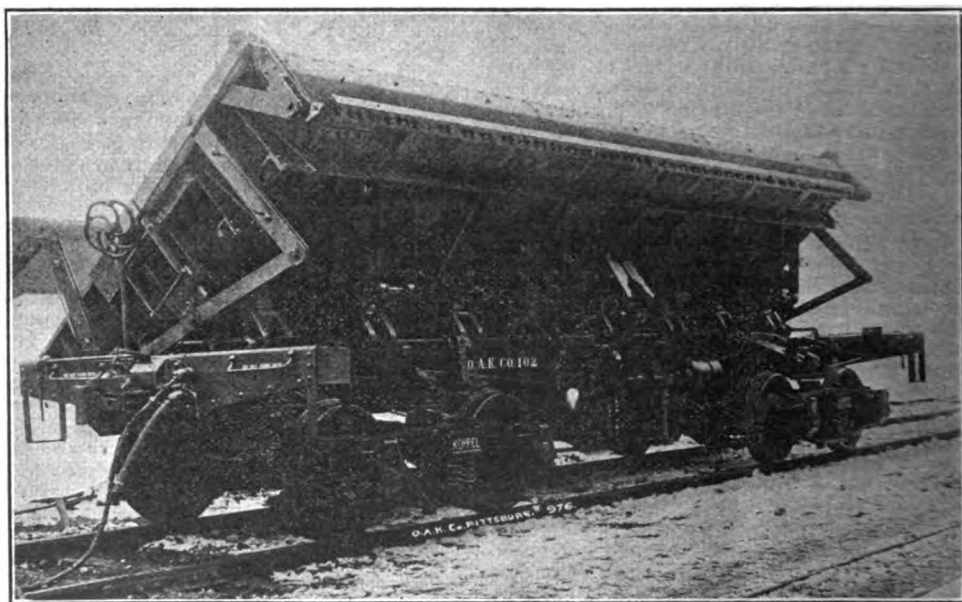

a long journey with a baby is how to take care of the diapers. A separate bag or basket lined with rubber sheeting should be provided for them, and with them may be packed a small enameled ware chamber.

For a young baby a number of inner pads of soft paper or old cloth which can be destroyed should be provided. When one of these is soiled, wrap it up tightly in a newspaper and throw it away. Wet diapers may be tightly rolled and kept in the rubber bag.

The two most common mistakes made in

A MODERN AMERICAN 20-CUBIC-YARD AIR DUMP CAR.

By Frank C. Perkins.

The accompanying illustration shows the operation of a modern air dump car of 20 cubic yards, which will easily carry a heap load of 28 cubic yards. It is operated by the locomotive; dumping and righting can be controlled from the cab of the locomotive or from the individual cars.

The cars can be dumped either right hand or left hand or alternately right and

left hand and the bodies are automatically unlocked for dumping and re-locked after dumping by compressed air. The car has a length over striking plates of 30 feet 6 inches, and a width over all of 10 feet 5½ inches, while the height top of rail to top of car measures 8 feet 1 inch, while the distance center to center trucks is 19 feet 6 inches.

It will be seen that the doors are of the iron clad type built of straight inside plate and corrugated outside plate, the inside space being filled with yellow pine. This makes a door which has no projections to be caught by the steam shovel; the wood gives the necessary elasticity to prevent buckling.

at the same time from positive means of pulling in and holding the bottom edge of the door when the body is righted. The operating of the car is performed by means of two large air pistons, one mounted on each side of the center sills. The pistons push directly against the members suspended from the floor of the body. The piston on one side dumping the car and the piston on the oppsite side righting the car.

PHOTOGRAPHS IN RAILWAY LOCOMOTIVE SMOKE ABUTMENT.

By Frank C. Perkins.

The accompanying illustrations supplied by Bureau Chief J. W. Henderson of the City of Pittsburgh Bureau of Smoke Regu-

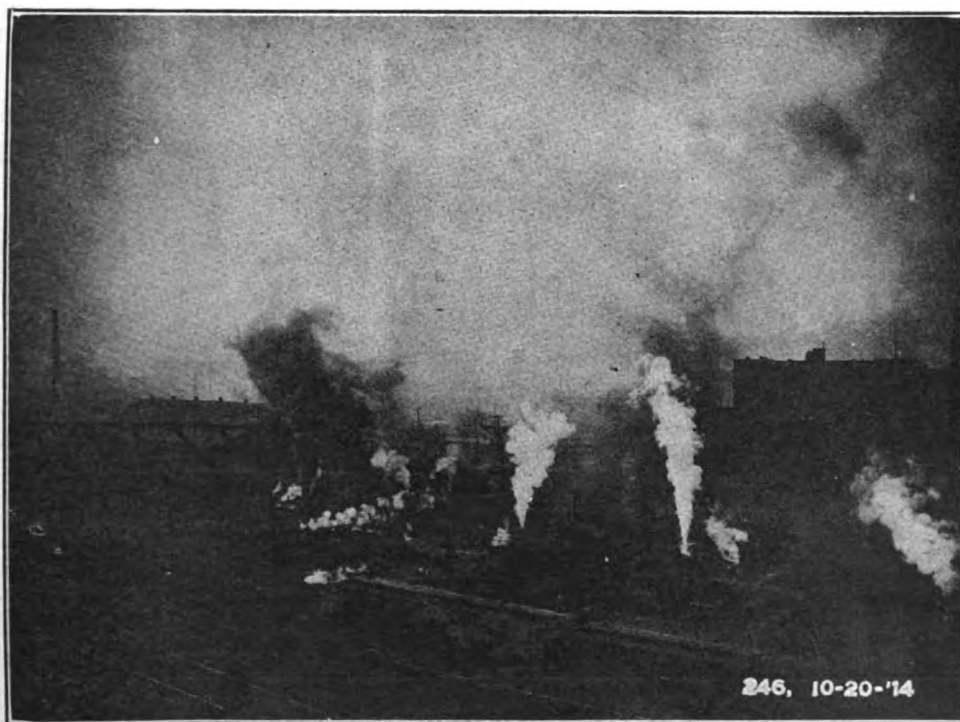

PHOTOS OF RAILWAY LOCOMOTIVE SMOKE ABATEMENT.
(Taken in October.)

The under frame consists of two longitudinal fish belly girders running full length of car while the body bolsters are of heavy built-up type, having solid webs, the end sills being of pressed steel with heavy structural frame work. The brakes are operated by Westinghouse air equipment in addition to being operated by hand brake from one end of car, while the brake mast is provided with drop over hand wheel.

The door operating gear consists of toggle door supports which push out the bottom edge of the door when dumping, considerably increasing the natural opening and

lation, Department of Public Health, give some idea of the smoke nuisance for the abatement of which an ordinance has been enacted producing excellent results by its rigid enforcement.

In this article, the regulation of railroad smoke only is considered, other industrial smoke abatement being considered later. In considering the value of photography in smoke abatement, Mr. Henderson says: "It is unnecessary for us to advise as to how locomotives burning soft coal can smoke, but can say that the taking of pictures has been a great help to this bureau. One set

of these pictures will serve to show just what was possible in the way of smoke emission from locomotives handling a single freight train previous to the railroads realizing that it was the intention to regulate railroad smoke, as well as that of the stationary plants."

"Up to this time, the railroads had abated smoke only with their mouths, but investigations in other cities proved conclusively that it was possible for the railroads to operate entirely within the limits of the ordinance, which would prove eventually to their own advantage by reason of the economy, but strange to say, these same railroads pro-

of our ordinance, which we can say they have done to such an extent that we believe Pittsburgh is as free from objectionable smoke from railroad locomotives as any city in the country, where they use bituminous coal for fuel."

The photographs were used to indicate the smoke nuisance, the later illustrations showing the dense, black smoke, eliminated, only white clouds appearing, which are largely steam and of no detriment. The recent photographs indicate the improvement made in the railroad yards, where they are now even building fires in these locomotives without producing objectionable

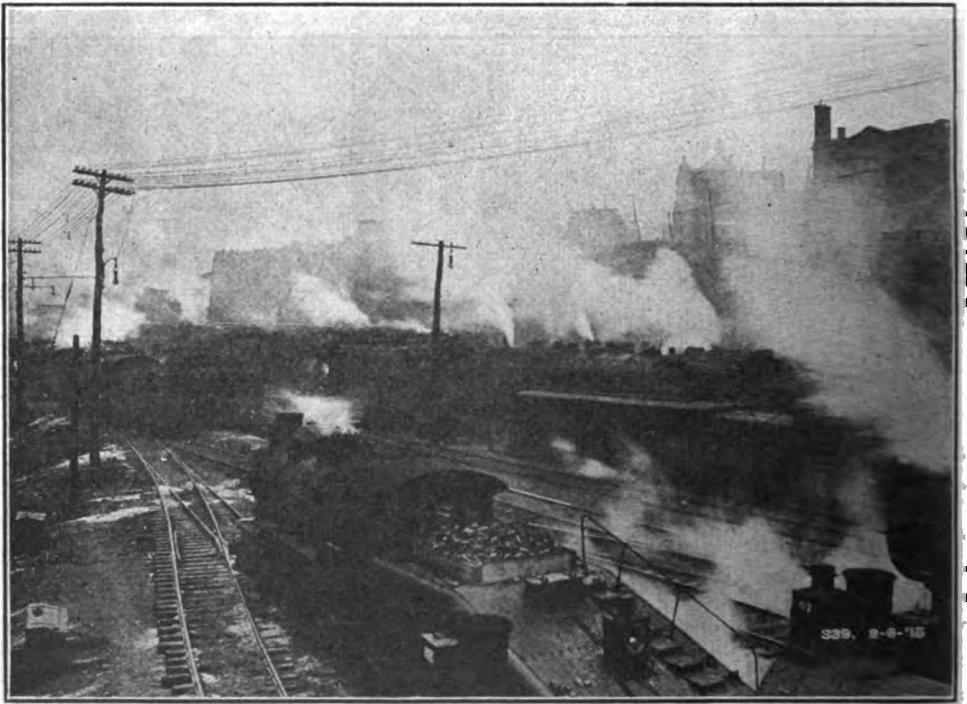

PHOTOS IN LOCOMOTIVE SMOKE ABATEMENT.
(Taken in February this year in the the same yard.)

fessed not to know what their own company was doing in this regard in other cities." Mr. Henderson further states that: "Realizing what a hard proposition the railroads are to deal with and finding that our arguments with them were not productive of results, it became necessary for the council of this city to threaten enactment of any ordinance, requiring that the railroads discontinue the use of bituminous coal on their locomotives, within the corporate limits of the city of Pittsburgh.

"Upon realizing that they were up against something, they soon signified a willingness to demonstrate that it was entirely possible for them to meet the requirements

smoke. Further, Bureau Chief Henderson declares that the railroads have all put on inspectors of their own, and each inspector sends a daily report of the operation of all locomotives under his jurisdiction; while some of them send photographs, as well, of locomotive operations.

It is claimed that the elimination of the railroad smoke has been a very material factor in the production of a clearer atmosphere, and is a great help to the Department of Health in Pittsburgh, but the Bureau of Smoke Regulation finds that in order to keep up this good work, it is necessary to keep after the violators relentlessly. Strange to say that the railroads have been

able to do away with their smoke without the addition of any stoking or other appliance. They have simply put it up to the men, holding the engineer equally responsible with the man on the end of the shovel; and a violation of the law means a reprimand in the first instance and a suspension of from 2 to 10 days for both members of the engine crew, for any repetition. The infliction of this penalty a few times had a very wholesome effect on the attitude of the men regarding the violations of the smoke ordinance, but, of course, they did not take to it kindly, at first.

The Pittsburgh ordinance, No. 257, reads as follows:

Section 2. The production or emission within the city, of smoke, the density or

The Ringlemann smoke chart is placed sufficient distance from the eyes to cause the lines to merge similar to appearance of smoke to compare with the density of the smoke under observation. Ordinance No. 257 provides penalties for the production or emission of smoke equal to, or of greater density than, scale number three of the Ringlemann Chart. The lines of the chart merge at from fifteen to twenty feet from the eye.

The recent report of the Pittsburgh Bureau of Smoke Regulation points out that the achievement of smoke regulation is an economic proposition. This is a fact, because smoke and its accompanying products of combustion affect health, cost of cleaning, permanence and appearance of build-

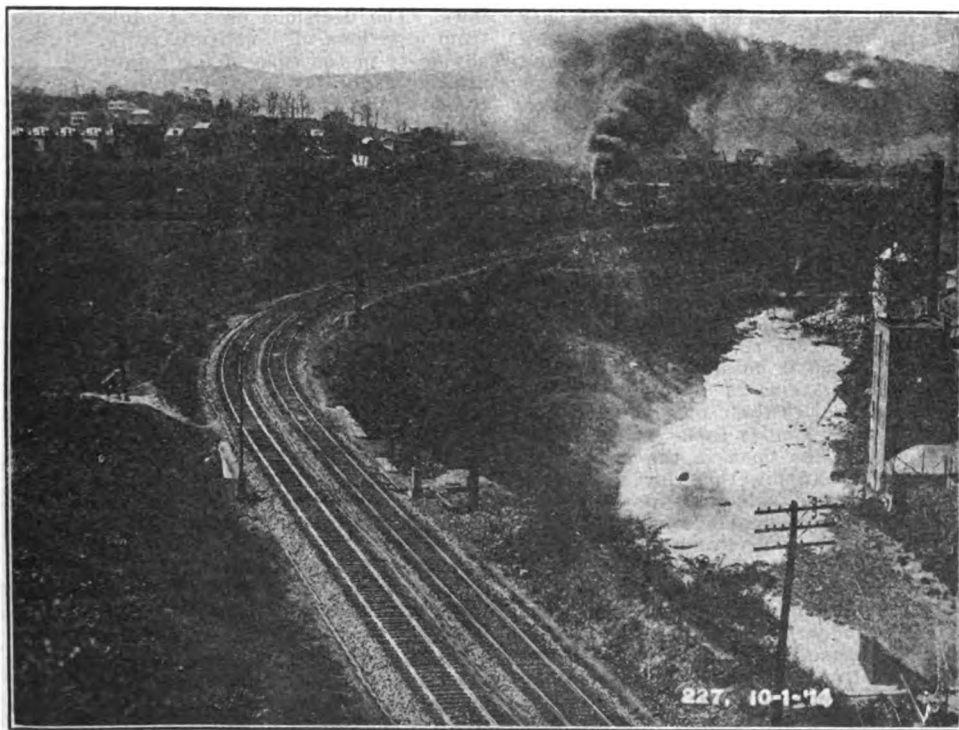

PHOTOS OF RAILWAY LOCOMOTIVE SMOKE ABATEMENT.

shade of which is equal to, or greater than, Number Three of the Ringlemann Chart, from any stack, except that a locomotive or steamboat, for a period or for periods aggregating two minutes or more in any period of fifteen minutes, and the emission of such smoke from any locomotive or steamboat for a period of periods aggregating one minute or more in any period of eight minutes, except for a period not to exceed twenty consecutive minutes, not to exceed once a day, while a new fire is being built therein, is hereby prohibited.

ing and household materials and the growth of vegetation. Its emission from "stacks" is, generally, an indication of inefficiency and an exhibition of fuel waste.

The total of all the items of cost amounts to something like \$20 per year for every man, woman and child in Pittsburgh. A report by the United States government states that smoke causes more than \$500,000,000 damage each year in the destruction to merchandise, the defacement of buildings, tarnishing of metals, injury to human and plant life, the great increased labor and

cost of housekeeping, and the losses to manufacturers, due to imperfect combustion of coal. This means a per capita loss of \$17 to every man, woman and child who lives in the great and middle-sized cities.

The report states that a saving in laundry bills only, of an average of a little less than four cents per week per inhabitant of Pittsburgh, equals more than \$1,100,000 saved per year. It may readily be conceived this has been accomplished. Careful investigation will indicate even more than this. In fact, the proportion of smoke elimination from railroad operations alone might account for a saving of about \$2 per person per year, or \$1,100,000 in the aggregate.

Utility demands abbreviation of reports of this character. Should we disregard this requirement, it would still be difficult to make known, in detail, the elimination of smoke from the "stacks" within the city limits, during the year 1914, alone, as a result of action urged upon the owners and operators of locomotives, boiler furnaces and other furnaces connected with stacks.

In Pittsburgh it is stated that there is scarcely a single case of even one isolated "stack" that has not had, during the year, personal attention with a view of furthering smoke elimination therefrom.

It is pointed out that the regulation of the production and emission of smoke from locomotives operating within the city limits, has been brought about by the railroads and others operating such equipment, to an extent that deserves recognition. The railroads have found it possible to accomplish smokeless operation of locomotives for Pittsburgh, equal to their best performance anywhere, using similar fuel. The most effective change has been in the method of firing. Accompanying this, for smokeless operation, is the selection of the fuel. These two factors, together with keeping the locomotives up to standard otherwise, make smokeless operations possible within the limits provided in the city ordinance.

It is claimed by the bureau chief that brick arches, superheaters and other devices applied to locomotives here do not in themselves constitute the means for compliance with the provisions of the city ordinance. Stokers eliminate the "human element" and make smokeless operation easily possible. Such locomotives, however, with cold boilers, are more difficult to start new fires in without excessive smoke, than is the case without the mechanical stoker.

DECISIONS OF COURTS AFFECTING LABOR.

The United States Bureau of Labor Statistics has just issued its annual review of court decisions affecting labor as its Bulletin No. 169. Approximately 265 decisions are summarized, dealing with the application and construction of the laws, or with the application of the principles of the common law to the rights and relations of the worker.

Decisions of outstanding importance which

are reviewed in this bulletin include the final opinions of the appellate and supreme courts of the United States in the famous Danbury Hatters' Case, holding members of unions personally liable for damage from boycotts; the dissolution of the famous injunction in the case of John Mitchell against the Hitchman Coal & Coke Company of West Virginia, and holding labor unions legal; and the Supreme Court's opinion in the Coppage case, overthrowing the law of Kansas which undertook to protect workmen in their membership in labor organizations. In the last named case, the dissenting opinion, which defended the constitutionality of the act, is also given.

The largest group of cases on a single subject is that relating to the new form of legislation known as workmen's compensation laws. The decisions on this subject range from questions of constitutionality, decided adversely in the case of the Kentucky statute and favorably in other state courts, to the determination of definitions or of single points of dispute. In considering occupational diseases, for instance, the Massachusetts courts hold lead poisoning to be within the state act, providing for compensation for "personal injuries arising out of and in the course of employment," while the Michigan courts, under the provisions of a state law similarly expressed, hold that a case of lead poisoning is not entitled to compensation. An optic neuritis induced by inhaling poisonous gases was also compensated in Massachusetts, while in New Jersey the court disallowed a claim on account of eczema said to be caused by acids used in a bleachery. Other decisions relate to the mode of computing benefits, the definition of the term "casual employment," what constitutes dependency, willful act, incapacity, etc. Taken in connection with an earlier bulletin on the same general subject, the Bureau of Labor Statistics has here presented one of the most complete collections of cases on American compensation laws in existence.

Another important group of decisions in a related field is of those determining the application of the Federal liability statute to different classes of railroad employments. Several cases are found which turn on the nature of the employment of the injured person, i. e., whether in interstate commerce or not. The courts are not uniform in their construction of this statute, but among the employments found to be within the act were those of a blacksmith repairing cars used in interstate commerce, a telegraph lineman engaged in repair work, workmen installing block signal systems, a carpenter building an addition to a freight shed, a laborer carrying coal to heat a shop in which interstate cars were being repaired, etc. Employments, which according to the decisions were excluded, were workmen constructing cut-offs for shortening interstate trackage, a hostler killed by the explosion of the boiler of a loco-

motive whose last run was intrastate, and a switch engine fireman who was at the moment handling only intrastate cars, though his work regularly involved the handling of both classes of commerce indiscriminately.

Other classes of Federal laws that received considerable attention in the court decisions are those limiting the hours of service of railroad employes, and requiring the supply and maintenance of safety appliances.

Other interesting cases are one that grew out of the textile workers' strike in Massachusetts, in which the accountability of the collectors of a fund intended for the relief of strikers' families was affirmed; one connected with the bridge workers' campaign against non-union employers, involving the transportation of explosives in interstate trains; a murder trial growing out of the incitement of a strike leader urging his followers to prevent arrests in the hop pickers' strike in California, and a question of the validity of a sentence of a military court during the disturbance among the miners of Silver Bow County, Mont.

The power of an employers' association to enforce its rules is maintained in a case in which such an association was held by the court to be entitled to recover from one of its members the sum of \$5,000 as damages for his defection in a struggle against closed shop contracts. In connection with this may be mentioned a case deciding the illegality of a combination in restraint of trade undertaken and carried on by an association of retail lumber dealers by blacklisting wholesale dealers who sold directly to the consumer.

The minimum wage law of Oregon is noted in this bulletin as the first law of this class to receive judicial consideration, being upheld by the supreme court of that state. From this decision an appeal has since been taken to the United States Supreme Court.

LABOR ORGANIZATION IN CANADA, 1914.

The fourth annual report on labor organization in Canada, containing 238 pages, embodying statistics, etc., for the calendar year 1914, has been issued by the Department of Labor.

Many will find a special interest in the chapter containing a discussion of the bearing of the European war on various aspects of trade unionism, which includes also the text of deliverances of representative labor organizations in different countries with respect to war in general or having special reference to the present war. Figures are printed showing the number of members of trade unions, who to the close of the year 1914, have as recruits or reservists gone to the front from Canada. The trade unions furnished in all 3,498 recruits and 417 reservists, these figures not including recruits joining the forces since January, 1915.

The standing of the chief cities from this point of view is shown in the following statement:

Cities	No. of Enlistments	No. of Reservists
Toronto	579	89
Winnipeg.	402	52
Montreal.	289	42
Vancouver.	222	22
Calgary.	154	9
Edmonton.	153	2
Victoria.	125	14
Ottawa.	85	7
Regina.	79	8
Quebec.	77	14
Hamilton.	76	8
Saskatoon.	66	10
Moosejaw.	55	3
London.	43	4
St. John.	38	3
Lethbridge.	30	2
Medicine Hat	30	1
Peterborough.	27	
Brandon.	24	2
Halifax.	23	1
New Westminster	22	
St. Catharines	20	1
Fort William	19	5
Kingston.	18	1
All others	842	111
Total.	3,498	417

The effect of the war on Canadian trade union growth is shown in a decrease of membership, the loss being 9,636. The estimated numerical strength of organized labor in Canada at the close of 1914 stood approximately at 166,163. The membership for each of the past four years, as reported to the department, has been as follows:

1911.	133,132
1912.	160,120
1913.	175,799
1914.	166,163

The membership for 1914 of international organizations operating in Canada was 140,482, members of non-international bodies numbered 20,935, and 4,746 belonged to independent unions.

The decrease in international membership was 9,095, and in independent unions of 1,261, while the non-international membership shows a gain of 720. At the close of the year 1914 there were 2,003 local branch unions in Canada, 1,174 owing allegiance to international organizations, 196 affiliated with non-international bodies and 33 independent unions. These figures show a reduction of 18 in local branches of international organizations, a loss of one in dependent units, and a gain of five in non-international branches, making a total decrease of 14 in the number of local union branches in the Dominion.

Organized Labor in Canadian Cities.

In twenty-five of the cities more than one-half of the local unions of the country are located, and among them they comprise nearly 40 per cent of the entire trade union membership in the Dominion. Montreal stands in first place as to the number of local branches, but Toronto reports much

the largest membership. The following summary gives the names of the cities, number of unions in locality, number of unions reporting membership, and the membership reported:

	Number of Unions	Number reporting of Unio's member- in locality ship	Number of Mem's. report'd
Montreal	126	43	8,439
Toronto	123	62	14,781
Winnipeg	80	40	6,693
Vancouver	69	34	5,165
Ottawa	59	33	3,262
Hamilton	53	32	2,684
Edmonton	44	23	2,037
London	43	17	1,587
Calgary	43	26	2,524
Quebec	40	17	2,630
Victoria	40	25	1,589
Fort William	30	14	775
St. John	29	14	980
Saskatoon	28	20	852
Halifax	27	11	1,386
St. Thomas	26	14	1,377
Regina	25	19	955
Moncton	24	12	1,640
Moosejaw	24	13	944
Brandon	23	16	677
Lethbridge	23	17	862
Brantford	22	9	403
Windsor	22	7	178
Peterborough	21	10	427
Nelson	20	9	300
Totals	1,064	537	63,147

Benefits Paid by Central Labor Bodies.

A table is furnished showing the expenditure during the year 1914 on account of operating in Canada. Of the 102 international bodies whose activities extend into the Dominion 79 have benefit features on a varying scale. The total disbursements during 1914 by the various international organizations amounted to \$12,837,987, being divided for each class of benefit as follows:

Death benefits	\$8,864,631
Strike benefits	1,953,350
Sick benefits	963,353
Accident benefits	635,580
Old age pensions	266,395
Unemployed benefits	97,392
Traveling benefits	47,286

Of the non-international bodies three reported having made payments on account of benefits, the total disbursements amounting to \$8,266.75.

General Features of the Report.

The report follows closely along the lines of former reports, the various phases of the general scheme of organization which have been developed being given due consideration.

A chapter is devoted to a discussion of some of the leading features of the organizations composed of workmen employed in the mining industry, including a brief history of their development and difficulties. The report serves as a directory of trade unions for the Dominion for 1915, including as it does particulars not only of every

known local trade union in Canada, but also a list of all international and non-international central organizing bodies, together with the names and addresses of the chief executive officers.

DESTROY THE FLY.

When the modern mother sings "Baby-bye, here's a fly" to her infant, she changes the second line of the old nursery song to read "Let us swat him, you and I." The common house-fly is no longer an object of tolerant interest, but has become an object of hatred and distrust. He is known to be the principal factor in the distribution of the germs of typhoid.

Especially is he regarded as the enemy of the baby, as there is reason to believe that he carries about the germs of summer diarrhea and leaves them behind him, with other filth, when he lights on the nipple of the feeding bottle, or crawls over the saucer of cereal, or falls in the milk. Thus he is a real danger, not only to the baby but to the whole family, and every effort should be made to do away with him.

Flies may be kept out of the house to a considerable extent by using screens at the doors and windows, and those that get inside may be trapped, poisoned, or swatted. But better than any of these methods is to destroy the flies in the larval stage, and thus prevent them from hatching. The following information is furnished by the Department of Agriculture:

"A safe and effective weapon against the typhoid or house-fly has been found in powdered hellebore by scientists of the Department of Agriculture. Flies lay their eggs chiefly in stable manure. Powdered hellebore mixed with water and sprinkled over the manure, will destroy the larvae which are hatched from the eggs. Since powdered hellebore is readily obtainable, this puts in the hands of everyone a remedy for one of the pests that has been found dangerous as well as troublesome. Powdered hellebore, however, will not kill adult flies, which must be swatted or trapped.

"It has long been known that flies breed in manure but previous methods of destroying the larvae there by the use of strong chemicals have been open to the objection that the treatment under some conditions lessened the fertilizing value of the manure or actually injured vegetation. This is not true of powdered hellebore. Government experiments have shown that the hellebore is entirely decomposed in the course of the fermentation of the manure and that even in excessive quantities it does no harm except to the larvae it is intended to destroy. Chickens picking in manure treated with it suffer no ill effects.

"One-half pound of powdered hellebore mixed with 10 gallons of water is sufficient to kill the larvae in 8 bushels, or 10 cubic feet, of manure. The mixture should be sprinkled carefully over the pile, especial attention being paid to the outer edges. In most places hellebore is obtainable in 100-pound lots at a cost of 11 cents a pound.

This makes the cost of the treatment a little less than seven-tenths of a cent per bushel of manure. A liberal estimate of the output of manure is two bushels a day per horse. The money involved is, therefore, trifling in comparison with the benefits to the individual and the community from the practical elimination of the disease-spreading fly.

"Although fresh manure is the favorite breeding spot, flies lay their eggs in other places as well, such as outhouses, refuse piles, etc. In these places, from which no manure is taken to spread on the fields, considerable saving may be effected through the substitution of borax for powdered hellebore. Applied at the rate of 0.62 pounds per 8 bushels of manure, borax is as effective as powdered hellebore in killing the larvae, but costs less than half a cent for each bushel of manure treated. In larger quantities, however, or when the manure itself is spread at a greater rate than 15 tons to the acre, some damage to crops may result. Large quantities of manure are often used by market gardeners and others, and there is always danger of carelessness in applying the borax. The use of the more expensive but safer hellebore is therefore

recommended for the treatment of manure. Borax is recommended for all other refuse in which flies may lay eggs.

"Scientists who have been working for years to eliminate the fly are convinced that the use of one or the other of these simple measures is a public duty wherever manure and refuse exist. Sanitarians, however, strongly advise the removal of refuse heaps or other unnecessary rubbish or breeding places for flies. In breeding places which cannot be thus disposed of—such as manure or stable—the daily use of powdered hellebore will keep the flies from breeding in these favorite breeding grounds. The best results are obtainable in a community where everyone cleans up his premises, traps or kills the flies, and systematically treats the manure and other breeding places with powdered hellebore.

"The fly is not only a nuisance to human beings and live stock; it spreads disease and filth and is a menace to public health which cannot be tolerated in the face of a demonstrated remedy. Details of the experiments with other information on the subject are contained in a professional paper, Bulletin 245 of the United States Department of Agriculture."

Smiles.

A civil engineer, who was building a railway in Mexico, was trying to show a native how much the new railway would benefit the country.

"How long does it take you to carry your produce to market at present?" he said.

"With a mule it takes three days."

"There you are!" exclaimed the engineer. "When the new railway is in operation you will be able to take your produce to market and return home the same day!"

"Very good, señor," was the placid reply, "but what shall I do with the other two days?"—Kansas City Star.

A Texas sheriff, visiting New York to take a prisoner back to the South, was turned over to an inspector who was to be his amusement guide. They wound up at an East Side ball where there were a few dips present.

After a half hour the inspector called one of the crooks to one side and said:

"See that tall man with the sombrero?"

"Yes, what about him?"

"He's a Texas bull I'm showing around and I think it would be a fancy idea if you could nick him for his ticket."

"Nix, you're trying to put me in bad."

"Nothing like it—purely a joke, that's all. To show you I'm on the level I give you my word that you won't get in trouble and I'll give you a \$5 note for his watch."

"All right, here it is."—From the Chicago Post.

WHY SHE WOUDN'T PAY.

"You'll have to pay for that little boy," said the conductor on a Michigan Central train the other day.

"I guess not," said the lady, firmly.

"Have you ever had to buy a ticket for him?"

"No, I have not, and I will not begin now."

"You will have to pay his fare this time."

"No, I shall not pay his fare. That is settled, Mr. Conductor."

"If you don't pay his fare I cannot let him occupy a seat. I will stop the train and put him off."

"Stop the train and put him off if you like. He's not my little boy. I never saw him before."—Detroit News.

The old man in the rear car seemed greatly agitated at not being able to find his ticket when the conductor came through. Finally that official, with a hearty laugh, informed him that he had found it in his mouth, which he seemed surprised to find true, and handed it over. After the conductor had passed into the next car the old fellow's companion started to make fun of him for having the ticket in his mouth and not being able to find it, whereupon he responded:

"He who laughs last, me lad, laughs best. I knew it was in me mouth the whole time, but the ticket was an old one, and I was chewing the date off it."—Ex.

Poetical Selections.

FIVE DOLLARS A WEEK!

Thus it is down on Beelzebub's books;
 "August the seventeenth—Isabel Brooks;
 Home in the country; folks, decent but
 poor;
 Character excellent; morals still pure;
 Came to the city today and found work;
 Wages five dollars; department store
 clerk."

Wages five dollars! To last seven days!
 Three for a miserable hall-room she pays;
 Two nickels daily the subway receives;
 One dollar-forty for eating, that leaves—
 One-forty has such a long way to reach—
 Twenty-one banquets at seven cents each.

There! Every penny of wage has been
 spent—
 Squandered for feasting and riding and
 rent!
 Spendthrift! She doesn't remember life's
 ills.
 How in the world will she pay doctor's
 bills?
 What if she's furloughed (there's always
 a chance);
 Isabel ought to save up in advance.

Hold! We've not mentioned her clothes;
 she must wear
 Dresses, hats, shoes, stockings, ribbons for
 hair—
 How shall she get them? Suppose that we
 stop;
 Perhaps it's as well if we let the thing drop.
 You good mathematicians may figure it
 out
 (It's a matter of figures or figure no doubt).

Carry this picture, it's better, I'm sure;
 "Character excellent; morals still pure."
 What else is written we won't try to see;
 Beelzebub thinks much the same way as
 we.

Why, as I live, there's a tear in his eye!
 Now, what in _____ can make old Satan
 cry?

Surely the Devil is feeling his age;
 Look what he's writing on Isabel's page:
 "Virtue's a luxury hard to afford
 When a girl hasn't money enough for her
 board."

—Herbert Kaufman. From "Poems" by
 Herbert Kaufman.

"THEY SAY"

"They say!"—ah, well, suppose they do!
 But can they prove the story true?
 Why count yourself among the "they"
 Who whisper what they dare not say?
 Suspicion may arise from naught
 But malice, envy, want of thought.

"They say!"—but why the tale rehearse,
 And help to make the matter worse?

No good can possibly accrue
 From telling what may be untrue,
 And is it not a nobler plan
 To speak of all the best you can?

"They say!"—well, if it should be so,
 Why need you tell the tale of woe?
 Will it the bitter wrong redress,
 Or make one pang of sorrow less?
 Will it the erring one restore,
 Henceforth to "go and sin no more"?

"They say!"—Oh, pause and look within,
 See how thy heart inclines to sin;
 And lest in dark temptation's hour
 Thou, too, shouldst sink beneath its power,
 Pity the frail, weep o'er their fall,
 But speak of good or not at all.

—The Pathfinder.

WELCOME.

Let us open wide the portals
 To the men who marched with Lee,
 And followed Stonewall Jackson
 Who bore the tattered banner,
 And waved its folds on high,
 And shed their blood for freedom
 'Neath the starry Southern sky.

We have read in song and story
 Of the heroes who have fought
 To uphold their country's honor
 And the miracles they wrought;
 But the valor of our soldiers
 Who wore Confederate gray
 Will go ringing down the ages,
 Making glorious the day.

See the long, thin line come marching,
 With the proud and martial tread,
 To greet their living comrades
 And bivouac with their dead;
 Strew their path with fragrant roses,
 Hail them with a loud acclaim,
 Battle-scarred and bent and hoary,
 Yet undying is their fame.

For, though lost, our cause is grander;
 Though conquered, we are free;
 We have placed on history's pages
 The name of R. E. Lee;
 And ages yet unborn
 Beneath the Southern stars,
 In the sunny land of Dixie,
 Will revere the Stars and Bars,

Then welcome, yes, thrice welcome
 To the brave old boys in gray;
 They are sacred, they are holy,
 And united we will pray
 That when our country needs us
 We will march as blithe and gay,
 With Old Flory flying o'er us
 As our sires who wore the gray.
 —MARY ROSALIND LE MASURIER.

In Memoriam

Mrs. Lela Ida Blount, age 52 years, mother of Brother E. Y. Blount, president of Lodge No. 222. Deceased was born February 24, 1863, died August 6, 1915, at Mart, Texas.

Mrs. Willie Hammett, age 43 years, mother of Brother J. T. Baggett, of Lodge No. 222. Deceased was born in 1872 and passed from this earthly habitation May 28, 1915, at Mart, Texas.

N. W. Alford, age 77 years, father-in-law of Brother G. M. Johnson of Lodge No. 222. Deceased after having passed the three-quarter century mark of life's pathway, passed away August 7, 1915, at Groesbeck, Texas.

Lost and Found

Lost Due Book—Wehman.

The due book and clearance card of Aug-Wehman, Reg. No. 66160, issued from Lodge No. 592, Tulsa, Okla., was lost some time in June. Anyone finding same please return to the undersigned.

AUG. WEHMAN,
P. O. Box 41, Hebron, Ind.

Lost Due Book—Cory.

Anyone finding due book of Joe Cory, Reg. No. 100848, will confer a favor by returning to the undersigned. Book was issued by Lodge No. 83. Lost between Kansas City and Port Arthur, Tex.

T. O. RILEY, S. L. 305.

Lost Due Book—McDermott.

The due book of Brother John McDermott, Reg. No. 104029, of Lodge No. 16, was lost. Anyone finding same will please return to the undersigned.

HUGH FITZPATRICK, S. L. 16.

Lodge Notices

Gleason-Kinley.

Would like to find out address of J. R. Gleason, anyone knowing same please notify F. L. Kinley, 217 N. Beard street, Shawnee, Okla.

McBryde—Lodge No. 20.

Any local taking up the card of J. C. McBryde, Reg. No. 16467, will please correspond with secretary of Local No. 20. Business of importance.

E. S. RYAN Sec. L. 20.

Rawlings-Hinzman.

Anyone knowing the whereabouts of Harold C. Rawlings, Reg. No. 63397, will please communicate with the undersigned. Secre-

aries are requested to take up and hold book and card. Write this office for further instructions.

A. HINZMAN.
First I. V. P.

Trials and Fines

Adams, et als.—Lodge No. 592.

This is to certify that the following members were tried by Lodge No. 592 and found guilty of violating the laws of the Brotherhood by working on unfair work as boiler makers, riveters and helpers in the Oklahoma oil fields of Oklahoma from January 2 to July 3, 1915, and are subject to a fine of one thousand dollars (\$1,000.00) and suspended for fifty years, and are not entitled to recognition in any way from the officers or members of this Brotherhood until such judgments are satisfied: Frank Adams, Reg. No. 100539; Kelly Breeding, Reg. No. 98043; John Beyers, Reg. No. 98420; John Carlson, Reg. No. 91218; James Doke, Reg. No. 101344; Stephen Gilchrist, Reg. No. 90485; L. R. Galbreath, Reg. No. 96653; Phillip Hartman, Reg. No. 54518; Eddie Hood, Reg. No. 91634, from New Orleans; N. A. Jennings, Reg. No. 97031; W. R. Johnson, Reg. No. 100151; Harry (Whitie) Kain of Chicago, Reg. No. 58103; Sam Lyons, Reg. No. 89152; Al Moon, Reg. No. 14975, has C. C. from 592; Geo. Mason, Reg. No. 100328; Claude Reed, Reg. No. 100836; A. L. Walker, Reg. No. 84079; Geo. Worrall, Reg. No. 69553; Elmer Winstal, Reg. No. 99830; S. C. Delay, Reg. No. 97731; Joe Ledett, Reg. No. 101676; John Willamson, Reg. No. 99450.

ERNEST DIXON, President.
RICHARD LEAHY, Cor. Sec.

Hazlett et al.—Lodge No. 39.

This is to certify that the following members were tried by Lodge No. 39 and found guilty of violating the laws of the Brotherhood by working on unfair work. Hazlett, at Lockport, Ill., before July 3, and Leahy for John Maher & Son, Gary, Ind., both as boiler makers, and are subject to a fine of one hundred dollars and suspended for 99 years, and are not entitled to recognition in any way from the officers or members of this Brotherhood until such judgments are satisfied.

Alex. Hazlett, age 33 years, Reg. No. 42771, and John J. Leahy, Reg. No. 62253, age 45.

FRANK BACTON, President.
JOHN S. COGHLAN, Cor. Sec.

Marosky—Lodge No. 377.

This is to certify that Vorcile Marosky, Reg. No. 94021, about 30 years, of Lodge No. 377, was tried by that lodge and found guilty of violating the laws of the Brotherhood by stealing a wood plane from a brother workman at the C., R. I. & P. R. R. shop, at Silvis, Ill., July 10, 1915, and his card was revoked for 99 years.

CARL ROBINSON, President.
C. R. KIZER, Cor. Sec.

OFFICIAL ROSTER—International Officers

J. A. FRANKLIN.....International President
Room 15, Law Bldg., 721 Minnesota Ave., Kansas City, Kas.

F. P. REINEMEYER.....Int. Secretary-Treasurer
Rooms 10 to 12 Law Bldg., 721 Minnesota Ave., Kansas City, Kas.

JAMES B. CASEY.....Editor-Manager of Journal
Room 9, Law Bldg., Kansas City, Kas.

A. HINZMAN.....First Int. Vice-President
Room 15, Law Bldg., 721 Minnesota Ave., Kansas City, Kas.

MISSOURI AND MISSISSIPPI SECTION.
States of Iowa, Missouri, Kansas, Nebraska, Arkansas, Mississippi, Alala a (other than Mobile), Tennessee, North and South Dakota, Oklahoma and Minnesota.

THOS. NOLAN.....Second Int. Vice-President
700 Court St., Portsmouth, Va.
GULF AND SOUTH ATLANTIC SECTION.
States of Texas, Louisiana, Florida, Georgia, North and South Carolina, Virginia, Maryland and Delaware, and Mobile, Ala.

J. P. MERRIGAN.....Third Int. Vice-President
91 Manufacturer St., Montreal, Que., Can.
CANADIAN SECTION.
The Dominion of Canada.

LOUIS WEYAND.....Fourth Int. Vice-President
6201 Fir Avenue, N. W., Cleveland, Ohio.
GREAT LAKES AND TERRITORY SECTION.
States of Wisconsin, Michigan, Cities of Chicago, Toledo, Cleveland and Lorain, O., Erie, Pa., State of New York (other than the City of New York).

WM. ATKINSON.....Fifth Int. Vice-President
212 South Pittsburg St., Spokane, Wash.
ROCKY MOUNTAIN AND PACIFIC COAST SECTION.

Honolulu, States of California, Oregon, Washington, Idaho, Utah, Nevada, Montana, Wyoming, Colorado, Arizona, Old Mexico, New Mexico and Canal Zone, Panama.

JOHN J. DOWD.....Sixth Int. Vice-President
133 Wegman Place, Jersey City, N. J.
EASTERN SEABOARD SECTION.
States of Maine, New Hampshire, Vermont, Massachusetts, Rhode Island, Connecticut, New Jersey and New York City.

M. A. MAHER.....Seventh Int. Vice-President
2114 Eighteenth St., Portsmouth, Ohio.
OHIO VALLEY AND TERRITORY SECTION.
States of Pennsylvania (other than the city of Erie), Ohio, West Virginia, Kentucky, Indiana and Illinois (other than the City of Chicago).

JOS. P. RYAN.....Eighth Int. Vice-President
7533 Vernon Ave., Chicago, Ill.
HELPERS' VICE-PRESIDENT OF WESTERN SECTION.
All states west of dividing line between Indiana and Ohio.

JOHN F. SCHMITT.....Ninth Int. Vice-President
1489 N. Fourth St., Columbus, Ohio.
HELPERS' VICE-PRESIDENT OF EASTERN SECTION.
All states east of dividing line between Indiana and Ohio.

District Lodges and Officers

DISTRICT No. 5—St. Louis, Mo.
Mo. Pac. and Iron Mountain R. R. Lodges represented: 32, 38, 44, 66, 82, 106, 113, 117, 286, 322, 403, 507, 521, 542, 543, 565, 583 and 599.

John C. Morrow, Pres., 613 W. 4th St., Coffeyville, Kas.

Hal. Stack, Vice-Pres., Van Buren, Ark.

John J. Murphy, Secy., 3404 Eads Ave., St. Louis, Mo.

J. N. Shirley, Treas., Box 485, Holington, Kas.

A. E. Stewart, Member Ex. Board, 2533 Myrtle Ave., Kansas City, Mo.

A. J. Radford, Member Ex. Board, 624 Oak St., Little Rock, Ark.

Chas. A. McDonald, B. A., 4416 Norledge Ave., Kansas City, Mo.

DISTRICT No. 10—Davenport, Ia.
Rock Island System. Lodges represented: 377, 144, 346, 199, 340, 293, 323, 434, 439, 491, 96, 32, 69, 393, 476, 522, 523.

Geo. W. Pring, Pres. & B. A., 677 38th St., Des Moines, Ia.

John Mitchell, V.-P., 1502 McGowan St., Little Rock, Ark.

S. T. Sample, C. & F. S., 515 N. Jackson St., Pratt, Kas.

J. J. Lynch, Treas., Box 655, Herrington, Kas.

DISTRICT No. 12—New York
New York Central System. Lodges represented: 5, 7, 10, 64, 67, 85, 150, 157, 169, 175, 197, 218, 223, 229, 321, 413, 492.

A. M. Anderson, Pres., 2208 Francis St., Jackson, Mich.

G. H. Gates, Vice-Pres., 148 N. Orchard St., Watertown, N. Y.

J. J. Leamy, Sec.-Treas., 68 Livingston Ave., Albany, N. Y.

Trustees—Wm. Weber, E. J. McNamara and Thomas Ranger.

DISTRICT No. 13—Birmingham, Ala.
Southern R. R. System. Organized Feb. 23, 1904. Lodges represented: 2, 4, 12, 14, 40, 50, 88, 143, 170, 226, 235, 312, 320, 334, 344, 363, 369, 419, 435, 511, 524, 584, 590.

Thos. J. Garvey, Pres., 414 E. Byrd St., Richmond, Va.

A. E. Barksdale, Vice-Pres., 119 E. Orleans St., Jackson, Tenn.

P. E. Berney, Sec.-Treas., R. F. D. 12, Knoxville, Tenn.

DISTRICT No. 15—Chicago, Ill.
C. & N. W. R. R. Lodges represented: 38, 60, 129, 145, 161, 201, 227, 311, 395, 440, 485, 496, 539, 597.

W. F. Scholes, Pres., 1929 Ave. B., Council Bluffs, Ia.

J. W. Francis, V.-P., 534 Springfield Ave., Chicago, Ill.

T. E. Burdette, Sec.-Treas., 428 North Chesnut Ave., Green Bay, Wis.

DISTRICT No. 19—Roanoke, Va.
Norfolk & Western System. Lodges represented: 29, 402, 30, 405, 557.

E. J. Horgan, Pres., 404 7th Av., N. E. Roanoke, Va.

H. D. Mauck, Secy., 519 10th St., S. W. Roanoke, Va.

J. B. O'Brien, Treas., 412 3d Ave., N. E. Roanoke, Va.

DISTRICT No. 22—D. R. G. System, Colorado and Utah.
Meeting place, Denver, Colorado; Date meeting, 2d Monday in July, 1915; Lodges represented: 44, 103, 179, 335, 427, 446, 473.

Geo. S. Warden, Pres. & B. A., 1507 E. 7th St., Pueblo, Colo.

H. F. Jones, Vice-Pres., 135 Sackett Ave., Salida, Colo.

A. A. Duncan, Sec.-Treas., Box 611, Alamosa, Colo.

DISTRICT No. 23—Meets at St. Louis, Mo., 2d Monday in October, 1914.
Lodges represented: 4, 70, 86, 180, 286, 418, 449, 458, 580, 581, 543, 546, 556, 322.

A. F. Bingham, Pres. and B. A., 701 Lombart St., Springfield, Mo.

L. W. Lawson, V.-P., 821 N. Maxey St., Sherman, Texas.

J. W. Reddick, Financial and Recording Secretary, 817 Lincoln St., Springfield, Mo.

A. A. Denton, Cor. Sec. and Treas., 1044 W. Mt. Vernon St., Springfield, Mo.

DISTRICT No. 24—Springfield, Ill.
Wabash System. Lodges represented: 54, 81, 85, 169, 267, 384, 447, 581, 594.

Edward F. Siebold, Pres., 1130 St. Mary's Ave., Ft. Wayne, Ind.

Wm. F. Furrow, Vice-Pres., 1017 E. Eldorado St., Decatur, Ill.

F. R. Lee, Secy.-Treas., 601 Monroe Ave., Moberly, Mo.

DISTRICT No. 25—Livingston, Mont.
Northern Pac. R. R. Lodges represented: 3, 104, 111, 116, 123, 130, 165, 242, 247, 591.

J. G. Brown, Pres., 610 N. 9th St., Brainerd, Minn.

Frank Depender, V.-P., 735 E. Nora Ave., Spokane, Wash.

Theo. W. Everett, Sec.-Treas., P. O. Box 554, Livingston, Mont.

Trustees—A. H. Shanks, 221 N. 2nd St., Missoula, Mont.; Hugh Roberts, Gen. Del., Glendive, Mont.; G. M. Owens, 312 So. E. St., Livingston, Mont.

DISTRICT No. 26—Aberden, S. D.
C. M. & St. P. and Puget Sound R. Rs. Lodges represented: 11, 15, 32, 38, 41, 104, 244, 302, 485, 520, 528, 568, 588, 595, 603, 606.

G. H. Hawksworth, Pres., Box 817, Deer Lodge, Mont.

F. J. O'Brien, Vice-Pres., Avery, Idaho.

Ed. McSperritt, Secy., Gen. Del., Miles City, Mont.

P. W. Gunn, Treas., 3316-30 Ave. South, Minneapolis, Minn.

J. L. Callahan, B. A., 3606 Chilton St., Milwaukee, Wis.

DISTRICT No. 27—Int. G. N. R. R. W. O. Faulk, Pres., Palestine, Tex. Lodges represented: 222, 345, 464.

W. K. Saddler, Vice-Pres., Mart, Texas.
E. H. Frick, Sec.-Treas., San Antonio, Tex.

W. B. Graham, B. A., Palestine, Tex.

DISTRICT No. 28—Cincinnati, O. C. H. & D. R. R. Lodges represented: 10, 85, 91, 259.

W. J. Redmond, Pres., 204 N. Wash. St., Indianapolis, Ind.

A. R. Griesheimer, Vice-Pres., 329 N. Elizabeth, Lima, O.

Wm. J. McGee, Jr., Sec.-Treas., 1255 Richmond St., Cincinnati, O.

DISTRICT No. 30—Canadian Pacific District Headquarters, Winnipeg, Man. Lodges in affiliation: 126, 134, 194, 379, 392, 466, 478, 505, 548, 417.

Geo. F. Chadburn, Pres. and Acting Sec.-Treas., 1585 Alexander St., Winnipeg, Man.

J. B. Smith, V.-P., 162 Annette St., Toronto, Ont.

R. Carswell, V.-P., 684 Home St., Winnipeg, Man.

DISTRICT No. 31—Cincinnati, O. B. & O. System. Lodges represented: 5, 10, 79, 99, 105, 135, 241, 259, 318, 326, 332, 444, 493, 498, 514, 579, 577.

J. C. Smith, Pres., Box 292, Garrett, Ind.

J. R. Cline, Vice-Pres., Cleveland, O.

M. W. Luke, Sec.-Treas., 1007 W. Main, Washington, Ind.

DISTRICT No. 34—Boston, Mass. Boston & Maine System. Lodges represented: 245, 371, 388, 481, 515, 517. Meets at Boston, Mass., 1st Monday in August and 2d Monday in February.

W. H. Wells, Pres., 108 Westford St., Lowell, Mass.

P. J. Kelley, Vice-Pres., 3 Devon St., Greenfield, Mass.

T. J. Donahue, Sec.-Treas., 5 Fernald St., Lowell, Mass.

DISTRICT No. 35—Parsons, Kas. M. K. & T. R. R. System. Lodges represented: 292, 209, 501, 576, 265, 32, 113, 207.

Fred Alsdorf, Pres. & B. A., 515 W. Owings St., Denison, Tex.

C. Dudding, V.-Pres., 2229 Crawford St., Parsons, Kas.

Robt. Rosbottom, Sec.-Treas., 600 W. Texas St., Denison, Tex.

C. A. Denton, Rec. Sec., Parsons, Kas.

Wm. Dickerson, Chairman Trustees, 810 Cleveland St., Waco, Tex.

DISTRICT No. 37—Texarkana, Tex. Cotton Belt R. R. System. Meets 3d Saturdays in January and July. Lodges represented: 68, 486.

R. M. Cummins, Pres. & B. A., 308 E. Valentine St., Tyler, Tex.

John A. Smith, V.-P., 1908 E. 8th St., Pine Bluff, Ark.

B. E. Shields, Sec.-Treas., 1503 E. 7th Ave., Pine Bluff, Ark.

DISTRICT No. 38—Atlantic Coast Line. Lodges represented: 20, 26, 239, 422, 424, 425, 448, 570.

A. J. Dixon, Pres., Rocky Mount, N. C.

W. A. Cahill, Vice-Pres., Montgomery, Ala.

E. S. Rvan, Sec.-Treas., 508 Lackawana Ave., Jacksonville, Fla.

DISTRICT No. 39—Central of Georgia System. Meets 1st Friday after Thanksgiving each

year at Columbus, Ga. Lodges represented: 4, 13, 26, 436, 510.

R. J. Black, Pres., 913 2nd St., Macon, Ga.

J. J. Dean, Vice-Pres., 226 Taylor St., Savannah, Ga.

Chas. A. Buchhell, Sec.-Treas., 103 Gordon W., Savannah, Ga.

E. M. Kendrick, Rec. Sec., Route 5, Cedartown, Ga.

R. S. Barry, Cor. and Fin. Sec., 1109 5th Ave., Columbus, Ga.

DISTRICT No. 40—Hamlet, N. C. Seaboard Airline and leased lines. Lodges represented: 2, 20, 26, 173, 298.

B. M. Jewell, Pres., 727 W. Monroe St., Jacksonville, Fla.

J. F. Brice, Vice-Pres., 204 Whitehall St., Atlanta, Ga.

E. C. Howle, Secy-Treas., 1119 E. 32nd St., Savannah, Ga.

DISTRICT No. 41—Hinton, W. Va. Chesapeake & Ohio System. Lodges represented: 55, 170, 238, 249, 356, 384, 525, 537.

R. L. King, Pres., 822 N. Twenty-sixth St., Richmond, Va.

L. F. Moatz, Vice-Pres., 159 W. Third St., Peru, Ind.

C. L. Barnett, Sec.-Treas., 419 Summers St., Hinton, W. Va.

Trustees—M. L. Steinbuck, Box 336, Clifton Forge, Va. D. C. Dowdy, 2046 7th Ave., Huntington, W. Va., A. J. Poke, 1817 Scott Ave., Covington, Ky.

DISTRICT No. 42—Danville, Ill. Chicago & Eastern Illinois R. R. Meets 1st Tues. in Feb., 1916. Lodges represented: 22, 95, 576.

Jas. B. Keenan, Pres. and B. A., 122 Indiana Ave., Danville, Ill.

Office Henthorn, R. & F. S., 102 Iowa St., Danville, Ill.

A. Welch, Cor. Sec. & Treas., Villa Grove, Ill.

Subordinate Lodges and Officers

2—ATLANTA, GA. 2d-4th Thurs A. D. Lundbon, Pres., 224 E. Fair. John Fletcher, C. S., 406 Pullian.

3—ST. PAUL MINN. 1st-3d Fri., New Odd Fellows' Home, 9th and Franklin.

Geo. Cox, Pres., 1746 Logan. Wm. Harrington, F. S., 695 Pine. Wm. Parranto, B. A., 400 E. Jenks.

4—BIRMINGHAM, ALA. 1st-3d Tues., K. of C. Hall.

Fred Baker, Pres., 2021½ 3d Ave. A. L. Carmack, F. S. & B. A., Office: 335 Hood Bldg.

5—CLEVELAND, OHIO. 1st-3d Thurs., Room 3, Federation Hall, 310 Prospect.

Chas. Tongreen, Pres., Superior. G. H. Brady, C. S. & B. A., 310 Prospect.

7—BUFFALO, N. Y. 2d-4th Fri., Council Hall, 33 E. Warron.

Geo. F. Muir, Pres., 116 Goodell. Thos. J. King, C. S., 1943 Seneca. Frank P. O'Brien, F. S., 238 Schiller.

8—COLUMBUS, O. Meets 2d-4th Thurs., F. of L. Hall.

Chas. L. Nicklaus, Pres., 473 Poplar Ave. Adam Ruckel, C. S., 267 Liebert.

10—INDIANAPOLIS, IND. 2d-4th Thurs., Labor Temple, 138 W. Washington St.

E. P. Leopard, Pres., 206 N. Tremont Ave.

Wm. Frohlinger, C. S., 542 East Louisiana St.

L. E. Hirsch, F. S., 851 Ashland Ave.

11—MINNEAPOLIS, MINN. 2d-4th Mon., Richmond Hall, 223 5th St.

H. P. Farly, Pres., 1356 Vine Place.

E. A. Conlin, C. S., 2404 Bloomington Ave.

12—MACON, GA. 2d-4th Friday, Morgan's Hall, cor. Elm and Broadway.

J. T. Fenlon, Pres., 1974 Third St. R. J. Black, C. & F. S., 913 2d.

14—CHATTANOOGA, TENN. Central Labor Hall, 8th and Cherrie Sts., 2d-4th Mon.

Wm. Quigley, Pres.

Jas. E. Evans, C. & F. S., 19 Jefferson.

15—DUBUQUE, IOWA. 1st-3d Tues., Union Hall, 19th and White Sts.

E. Keck, Pres., 1272 Lincoln Ave. R. Ruof, C. & F. S., 975 Clay St.

16—JERSEY CITY, N. J. 1st-3d Mon., Fischer's Hall, Newark Ave., cor. Erie St.

Patrick J. Kenneally, Pres., 209 Magnolia Ave.

Hugh Fitzpatrick, C. S., 244 York. Ed. McCarthy, B. A.

19—PHILADELPHIA, PA. 2d-4th Fridays, Bricklayers' Hall, Broad and Fairmount Ave.

Frank Goodfellow, Pres., 159 W. Palmer St.

R. S. Hopkins, C. S., 2426 S. Clarion.

20—JACKSONVILLE, FLA. Meets every Tuesday, Central Labor Hall, 46½ W. Bay.

E. F. Ketchey, Pres., 841 W. Monroe.

E. S. Ryan, C. & F. S., 603 Park.

21—NEW YORK, N. Y. 1st-3d Mon., 201 Williams St.

James H. Sullivan, Pres., 607 W. 46th St.

James McGeney, C. S., 295 Livingston St., Brooklyn, N. Y.

Harry Davis, F. S., 351 5th Ave., Brooklyn, N. Y.

22—DANVILLE, ILL. 1st-3d Mon., Trades and Labor Hall.

Ray Schenk, Pres., California St. Wm. J. Irwin, C. S., 7 Illinois.

Frank Jergens, F. S., 418 N. Bowman Ave.

G. D. Davis, B. A., 18 N. Hazel.

25—SAN FRANCISCO, CALIF. Roesch Hall, 15th and Mission Sts., 2d-4th Thurs.

John Kane, Pres., 41 Collingwood.

Thos. J. Sheridan, C. S. & Treas., 2312 24th St.

Wm. P. Bowser, B. A., 314 14th.

26—SAVANNAH, GA. 1st-3d Tues., Whittaker St. and Liberty Lane.

E. C. Howle, Pres., 1110 E. 32d St.

R. B. Allen, C. S., 509 E. 32d St.

27—ST. LOUIS, MO. 2d-4th Thurs., 10th and Carr.

Larry Kichham, Pres. & B. A., 5322 Vernon Ave.

James Callahan, C. S., 3408 Laclede Ave.

Henry Seikmann, F. S., 1908A Madison.

- 29—**ROANOKE, VA.** 2d-4th Wed., Labor Home Hall, Commerce and Salem Ave.
G. J. Lucas, Pres., 1121 3d Ave. N. W.
J. R. Anderson, C. S., 502 Campbell Ave.
- 30—**ROANOKE, VA.** 2d-4th Mon., Labor Hall, cor. Commerce St. and Salem Ave.
C. E. Eades, Pres., 318 7th Ave. N. E.
B. I. Wade, C. S., 311 Jamison Ave.
- 31—**ST. JOSEPH, MO.** 2d-4th Mon., Jucker Hall.
B. E. Stitta, Pres., 2228 So. 6th.
Edward Knight, C. S., 2119 So. 9th St.
- 32—**KANSAS CITY, MO.** 2d-4th Fri., Labor Temple, 14th and Woodland.
Chas. Lackenby, Pres., 2022 Bellview.
W. E. Dwyer, C. & F. S., 115 N. Elmwood.
Chas. McDonald, B. A., 4416 Norledge.
- 37—**NEW ORLEANS LA.** 2d-4th Wed., Martin's Hall, Iberville & Exchange Place.
Wm. J. Smith, Pres. & B. A., 228 Morgan St., Algiers, La.
Lewis J. Costella, C. S., 312 S. Dupre.
Victor Escasse, F. S., 617 Alix St., Algiers, La.
- 38—**OMAHA, NEB.** 1st-3d Wed., Blairright Hall, 19th & Farnum.
M. J. McGovern, Pres., 2247 N 19.
L. G. Rankin, C. S., 2225 Cass.
J. H. Massman, F. C., 1511 Locust.
- 39—**SOUTH CHICAGO, ILL.** 2d-4th Tues, Union Headquarters, 92d St. and Erie Ave., South Chicago.
Frank Bacton, Pres., 10222 Ave. L.
John Coglan, C. S. & B. A., 9944 Ave. H.
Joseph Manners, F. S., 10500 Ave. G.
- 40—**LOUISVILLE, KY.** 2d-4th Wed., in Beck's Union Hall, 1st and Jefferson Sts.
Thomas Mitchell, Pres., 1422A Broadway.
R. Terrill, C. S., 308 N. 19th St.
F. J. Kessler, F. S., 212 Collins Court.
- 41—**HARLOWTON, MONT.** 2d-4th Thurs., Winer Hall.
John Dennis, Pres.
Verne Scott, C. S., Box 550.
- 42—**NASHVILLE, TENN.** 2d-4th Thurs., Carpenters' Hall, 342½ 4th Ave. N.
James B. Keenan, 1006 E. Madison St., Danville, Ill.
H. R. Brown, Pres., 611½ Church.
W. T. Pentecost, C. S., 2143 Oakland Ave.
- 44—**PUEBLO, COL.** Every Wed., Trades Assembly Hall, Cor 3rd St., and Santa Fe Ave.
Geo. D. Hilbert, Pres., 1140 Claremont Ave.
Geo. S. Warden, C. & F. S., 1507 E 7th St.
- 45—**BROOKLYN, N. Y.** Greenpoint and Manhattan Aves., 2d-4th Thurs.
Gerald A. Daly, Pres. & C. S., 676 6th St.
M. J. Callahan, F. S., 19 Jewell St.
- 46—**CHEYENNE, WYO.** Union Hall, 2d-4th Wed.
Geo. R. Wallace, Pres., P. O. Box 151.
E. Cole, C. S., 215 E. 9th St.
- 47—**DES MOINES, IA.** 1st-2d Thurs., Trades Assembly Hall.
James Gillespie, Pres., 1113 Columbus Ave.
Fritz Johnson, C. & F. S., 922 W. 1st St.
- 48—**LARAMIE, WYO.** 1st-3d Tues., Moose Hall.
Jacob Claus, Pres., 114 Cedar St.
- Frank M. Lepper, C. S., 360 N. 3d St.
- 50—**CHARLESTON, S. C.** 1st-3d Tues., Y. M. C. A. Hall, George St.
H. J. Hartnett, Pres., 13 Anson St.
John J. Clair, C. & F. S., 196A Spring St.
- 54—**FORT WAYNE, IND.** Last Wed., West Berry St.
Edward F. Siebold, Pres. & C. S., 1130 St. Mary's Ave.
O. P. Ewald, F. S., 1419 S. Calhoun.
- 55—**NEWPORT NEWS, VA.** Every Wed., 8 p. m., C. L. U. Hall, 32d and Wash. Ave.
Wm. H. Healy, Pres., 3711 Huntington Ave.
D. McArthur, C. S., 211 37th.
W. Hannah, F. S., P. O. Box 430.
- 57—**PORTSMOUTH, VA.** 1st-3d Thurs., C. L. U. Hall.
O. C. Hartung, Pres., 1248 Park Ave.
J. H. Parrish, F. S., 622 Clifford.
Geo. Thomas, C. S., 204 Lincoln.
- 60—**PEORIA, ILL.** 1st-3d Mon., 411 Cedar St.
E. L. Thornton, Pres., 213 Faraday.
F. Hierspiel, C. S., 410 Warner Ave.
- 61—**NEW HAVEN, CONN.** 1st-3d Thurs., Boardman Bldg., cor. State and Chapel Sts.
Wm. Hefferman, Pres., 95 Carlyle.
M. J. Whalen, C. & F. S., 138 Carlyle.
- 64—**JACKSON, MICH.** Every Tues., Labor Hall, Main and Jackson Sts.
Geo. Bones, Pres., 140 Bates.
Ed. McNamara, C. S., 619 South Pleasant St.
- 65—**VICTORIA, VA.** 2d-4th Sundays, Lunenburg Hall.
J. H. Jones, Pres., Gen. Del.
W. E. Slayton, C. S., Gen. Del.
- 66—**LITTLE ROCK, ARK.** 1st-3d Thurs., Brannon Hall, Markham and Cross Sts.
W. J. Flynn, Pres., 908 Denton.
E. W. Smith, C. & F. S., 300 W. 11th St., Argenta, Ark.
C. A. McDonald, B. A., 4416 Norledge, Kansas City, Mo.
- 67—**BAY CITY, MICH.** 1st-3d Thurs., Central Trades Council Hall.
Wm. H. Benedict, Pres., 703 E. Winona Ave., W. S.
Joe Malton, V. P., 317 S. Jackson.
Nelson Heglung, C. & F. S., 614 Adams St.
- 68—**FINE BLUFF, ARK.**—2d-4th Wed., Labor Temple.
A. J. Barton, Pres., 1701 W 6th.
B. E. Shields, C. S., 622 Nebraska.
J. A. Smith, F. S., 1908 E. 8th.
- 69—**LITTLE ROCK, ARK.** 2d-4th Fri., Kerst Hall, 910½ Main St.
John Mitchell, Pres., 1502 McGowan.
W. A. Rooksberry, C. & F. S., 212 Pulaski.
Geo. W. Pring, B. A.
- 70—**SPRINGFIELD, MO.** 2d-4th Wed., Eagles' Home.
A. E. Welch, Pres., 1822 Roberson Ave.
Scott Daffer, C. & F. S., 1235 Broad St.
A. F. Bingham, B. A., 701 Lombard St.
- 72—**PORTLAND, ORE.** 2d-4th Thurs., 230½ Yamhill St.
Arthur Gallon, Pres., 649 Milwaukee.
H. N. Cooper, C. & F. S., 733 Rodney Ave.
F. E. Disbrow, C. S., 810 E. 11th.
Joe Reed, B. A., 507 Bismark.
- 73—**TROY, N. Y.** 2d-4th Mon., Swan and Georgia Sts., Mechanics' Hall.
Huntington Ave.
- John Donnelly, Pres., 23 3d St., Cohoes, N. Y.
David Boyd, C. & F. S., 219 9th St., Watervliet, N. Y.
- 74—**HOUSTON, TEXAS.** 1st-3d Wed., Woodman Hall, 1823 Washington St.
D. C. Bryan, Pres., 4607 Washington.
F. C. Jackson, C. & F. S., 2119 Lublick St.
- 79—**GARETT, IND.** 1st-3d Tues., K. of P. Hall, Randolph.
Geo. Richmond, Pres., 214 E. Keyser.
- J. C. Smith, C. & F. S., Box 282.
- 80—**ANACONDA, MONT.** 2d-4th Wed., M. & M. Hall, Lodge Box 372.
J. C. Smith, Pres., 510 Cherry St.
James W. Hogan, C. S., 800 Birch.
- 81—**SPRINGFIELD, ILL.** 2d-4th Tues., Fortunes Hall.
C. F. Mutter, Pres., 1528 E. Capitol Ave.
Louis L. Mutter, C. & F. S., 1621 S. 8th.
- 82—**OSAWATOMIE, KAS.** 1st-3d Mon., K. & L. Sec. Hall.
Hurb Sader, Pres.
A. G. Everett, C. & F. S., Box 636.
C. A. McDonald, B. A., 4416 Norledge, Kansas City, Mo.
- 83—**KANSAS CITY, KAS.** 2d-4th Tues., K. P. Hall, 624 Minn. Av.
Thomas Knowles, Pres., 760 Shawnee.
Frank Stever, C. & F. S., 322 Nebraska Ave.
- 84—**GRAND RAPIDS, MICH.** 2d and 4th Thurs., Campau Hall, 949 Division Ave.
Frank C. Lemke, Pres., 551 Shamrock St.
Nelson M. Warren, C. S., 127 E. Delaware St.
- 85—**TOLEDO, OHIO.** 2d-4th Tues., Mitchell's Hall, cor. Walnut and Summit Sts.
J. S. Durst, Pres., 153 Gibbons St.
Ellsworth Richardson, C. S., 1137 Western St.
- 86—**DALLAS, TEX.** 1st-3d Mon., Broadnax Hall.
W. H. Riley, Pres., 1408 Corinth.
C. B. Stout, C. S., R. R. 10, Box 64.
- 88—**JACKSON TENN.** 2d-4th Fri., Labor Hall.
B. B. Seward, Pres.
A. E. Barkdale, C. S., 119 E. Orleans St.
- 90—**SUGAR CREEK, MO.** 2d-4th Thurs., Woodman's Hall.
L. Novak, Pres.
C. R. Snider, C. & F. S., 1222 W. Electric St., Independence, Mo.
- 91—**ELMWOOD PLACE O.** 1st-3d Mon., Kellers Hall.
Geo. Urban, Pres., St. Bernard, O.
John Cullen, C. S., 39 Prosser Ave.
- 92—**LOS ANGELES, CAL.** 2d-4th Wed., Union Labor Temple, 540 Maple Ave.
Wm. Gardner, Pres., 2207½ E. 2nd.
H. E. Herman, C. & F. S., 520 S. Griffin Ave.
- 93—**JOLIET, ILL.** 2d-4th Tues., Conner's Hall.
John Buckley, Pres., 111 Willard Ave.
Richard Farrell, F. S., 503 London Ave.
Charles Mork, C. S., 424 Landan Ave.
- 94—**SACRAMENTO, CAL.** 1st-3d Thurs., Labor Temple.
John Grabfelder, Pres. & C. S., 3001 G. St.
J. S. Hiller, F. S. & Treas., 1723 26th St.
- 95—**EVANSVILLE, IND.** 2d-4th Mon., Ruhl's Hall.
Chas. T. Mooney, Pres., 1802 Michigan.
Herman H. Grundman, C. & F. S., 307 Mary St.

- 86-FORT WORTH, TEX.** B. of L. F. & E. Hall, 1st-3d Thurs. J. J. Dempsey, Pres., 504 Calhoun. L. A. Freeman, C. & F. S., 2250 Jennings St.
- 99-NEWARK, OHIO.** Druid's Hall, 2 1/2 S. 3d St., 1st-3d Sun., 9 a. m. Emil Indlekofer, Pres., 76 Curtis Ave. Harry Feldner, C. S., 56 German.
- 100-MARSHALL, TEX.** 1st-3d Tues., I. O. O. F. Hall. Smith Hayden, Pres., 514 Greenwood Ave. J. P. O'Neil, C. & F. S., 708 E. Rusk.
- 102-SALT LAKE CITY, UTAH.** Labor Temple, 3d East, bet. 1st and 2d S. St., 1st-3d Wed. Wm. H. Garrick, Pres., 416 Edith Ave. B. S. R. Harrison, C. & F. S., 862 Ouray Ave.
- 104-SEATTLE, WASH.** 1st-3d Thurs., Labor Temple, 6th and University St. Fred Counter, Pres., 2360 15th Ave. So. Dan McKillop, Sec. & B. A., 166 1/2 10th Ave., Phone Elliott 845W.
- 105-CINCINNATI, OHIO.** 2d-4th Thurs., Workman's Hall, Mercer and Walnut Sts. Chas. Granger, Pres., 329 Union St., Bellevue, Ky. D. L. O'Brien, C. S. & B. A., 23 Forest Ave., Ludlow, Ky. Frank Bareswilt, F. S., 1022 5th Ave., Dayton, Ky.
- 106-McGHEE, ARK.** 2d-4th Wed., K. of P. Hall. Wm. E. Crupper, Pres., Box 215. Chas. A. Stewart, C. & F. S., Box 422.
- 107-MILWAUKEE, WIS.** 1st-3d Tues., Speers Hall, Cor. National & 3d Ave. J. Hoppens, Pres., 1302 Fratney. R. Dale, Fin. Sec., 319 4th Ave. P. Sonnenberg, C. S. & B. A., 623 Greenburg.
- 108-AUGUSTA, GA.** 2d-4th Tues., Machinists' Hall, Broad. Patrick Rice, Pres., 1342 Walton Way. E. E. Bennett, C. S., 1406 Silcox.
- 109-CHADRON, NEB.** J. W. Boyd, Pres. John F. Paulson, C. & F. S., Box 347.
- 111-MISSOULA, MONT.** 2d-4th Tues., Eagles' Hall. H. A. Chase, Pres., Box 1304. A. H. Shanks, C. S., 221 N. 2d.
- 112-MOBILE, ALA.** Trade Council Hall, 1-3 Mon. J. A. Moore, Pres., 119 So. Conception. G. A. Sloum, C. & F. S., 956 Wash. Ave.
- 113-SEDALIA, MO.** 1st-3d Tues., Labor Temple. Chas. Hall, Pres., Gen. Del. C. A. McDonald, B. A., 4416 Norledge, Kansas City, Mo. W. H. Sims, C. S., 1306 E. 7th St.
- 116-BRAINERD, MINN.** 2d-4th Fri., Trades and Labor Hall. Henry Volght, Pres., E. Oak. Wm. B. Good, C. S., Imperial Block.
- 117-DE SOTO, MO.** 1st-3d Mon., Federation Hall. R. B. Parks, Pres. S. L. Johnson, C. & F. S., Box 248.
- 122-LIVINGSTON, MONT.** 1st-3d Thurs., Trades and Labor Hall. C. D. Cain, Pres., 204 S. K St. Theo. W. Evert, C. & F. S., P. O. Box 554.
- 124-SAGINAW, MICH.** 1st-3d Fri., Petre & Meck's Hall, Genesee Ave. John Doyle, C. & F. S., R. F. D. No. 1.
- 126-WINNIPEG, MAN.** 1st Wed. and 3d Sun., 2:30 o'clock, Labor Temple. Wm. L. Hall, Pres., 1576 Elgin Ave. I. M. Couttie, C. S., 1497 Pacific Ave. A. Cook, F. S., 1233 Silkirk Ave.
- 129-CLINTON, IOWA.** 4th Fri., Labor Temple, 211 15th Ave. Henry L. Weber, Pres., 503 Elm. Henry Qualman, C. & F. S., 231 14th Ave.
- 130-BUTTE, MONT.** 1st-3d Tues., Carpenters' Hall, cor. Granite and Montana Sts. T. F. Shulta, Pres., Box 779. Harry Goodland, C. & F. S., 177 E. Center.
- 132-GALVESTON, TEX.** 2d Mon., Cooks and Waiters' Hall, 23d St. S. Naudascher, Pres., 3228 Ave. H. E. T. Chester, C. & F. S., 3209 Ave. I.
- 133-WATERLOO, IOWA.** Central Labor Hall, 2d-4th Wed. E. G. Pullen, Pres., 502 Columbia St. Geo. A. McMillan, C. S., 702 Barclay St.
- 134-MONTREAL, QUE., CAN.** 1st-3d Fri., Monument National, St. Lawrence and Main Sts. Stephen Craig, Pres., 1251 Mossier. R. Chorlton, C. S., 1184 Delormier Ave.
- 135-CHILLICOTHE, O.** 1st-3d Mon., Flaeger Hall. L. J. Medert, Pres., 516 E. Water. Harry Rittinger, F. C. S., 339 S. Watt.
- 136-COLORADO CITY, COLO.** Red Men's Hall, 1st-3d Fri. H. J. Norton, Pres., care National Hotel. R. D. Wing, C. S., 12 So. 12th, Colorado Springs, Colo. J. H. Cook, F. S., 216 N. 10th.
- 137-PADUCAH, KY.** 2d-4th Sun., Central Labor Hall, 122 1/2 N. 4th. B. C. Beadles, Pres., 1029 Madison. Wm. Black, C. & F. S., 2040 Broad St.
- 138-HARRISON, ARK.** 4th Thurs. H. C. Heppard, Pres. John G. Call, C. & F. S.
- 143-KNOXVILLE, TENN.** 319 N. Gay St., 1st-3d Tues. J. D. Krause, Pres., R. F. D. No. 1. Joe Gallaway, C. S., 1000 Broadway. W. D. Amanns, F. S., R. F. D. No. 12, Lincoln Park.
- 144-CEDAR RAPIDS, IOWA.** 1st-3d Wed., I. O. O. F. Hall, cor. 1st St. and 2nd Ave. W. Chas. T. Bowman, Pres., 816 Ellis Blvd. Frank C. Schwarz, C. & F. S., 830 G Ave., W.
- 145-MISSOURI VALLEY, IOWA.** 1st-3d Thurs., Walker's Hall. Hans Witt, Pres., Box 181. Harvey Nichols, C. S.
- 148-VALLEJO, CALIF.** 1st-3d Tues., Vallejo Temple Hall. Wm. Fountain, Pres., 225A Penn. J. M. Kelly, C. S., 1008 York.
- 149-MARSHALLTOWN, IOWA.** 1st-3d Tues., Trades and Labor Assembly Hall, Main St. Chas. Vyskocial, Pres., 9 E. Boone. Ernest L. Burt, C. & F. S., 203 E. Linn.
- 150-CHAMPAIGN, ILL.** 1st-3d Sun., 2:30 p. m., I. C. System Fed. Hall. Thos. H. Monahan, Pres., 511 W. Washington St. A. E. Strode, C. S., 325 Hickory.
- 153-GASSAWAY, W. VA.** 20th of each month, Boone's Hall. J. E. Perkins, Pres., Little Otter, W. Va. C. S. Davis, C. & F. S., Gen. Del.
- 154-PITTSBURGH, PA.** 1st-3d Fri., Labor Temple, cor. Washington and Webster Ave. Frank Bann, Pres., 804 South Ave. N. S. Henry J. Thumel, C. & F. S., 1218 Ithin St. N. S. James J. Carr, B. A., Labor Temple, Wash and Webster Ave.
- 155-BLOOMINGTON, ILL.** 1st-3d Mon., Redmen's Hall, Main and Front Sts. H. F. Lambrecht, Pres., 1004 N. Livingston St. L. J. Metzner, C. & F. S., 1207 N. Mason.
- 161-BOONE, IOWA.** 1st-3d Mon., at Electrical Workers' Hall. Frank Whitman, Pres., 1602 Benton. H. W. Martens, C. & F. S., 1329 Meridan St.
- 163-HOBOKEN, N. J.** 2d-4th Fri., 507, Bloomfield St. Jeremiah Cahill, Pres., 38 Troy. P. L. Growney, C. S., 1019 Willow Ave.
- 165-DULUTH, MINN.** 2d-4th Sat., Irwin-Sloan Block, 20th Ave. and Superior St. James A. Graham, Pres., 5705 Grand Ave., W. Duluth, Minn. Alfred S. Nelson, C. & F. S., 5705 Grand Ave., W. Duluth, Minn.
- 169-DETROIT, MICH.** 2d-4th Thurs., 273 Gratiot Ave. Charles Komes, Pres., 31 Celaren. Chas. F. Aderholdt, C. & F. S., 9 Fviven St.
- 170-RICHMOND, VA.** 1st-3d Wed., Labor Temple, 5th and Marshall Sts. R. L. King, Pres., 822 N. 26th St. F. C. Blount, F. S., 1101 N. 28d. E. M. Daywalt, C. S., 2208 Venable St.
- 172-RALEIGH, N. C.** B. F. Long, Pres., 218 N. McDowell. J. P. Taylor, C. & F. S., 615 W. North.
- 176-ELIZABETH, N. J.** 2d-4th Wed., Dahmen Hall, 4th and E. Jersey St. John H. Reynolds, Pres., 32 Delaware St. Samuel M. Rankin, Secy., 64 Florida. E. J. McCarthy, B. A., 67 St. Mark's Place, New York City.
- 179-DENVER, COLO.** 2d-4th Wed., Room 301 McPhee Bldg., 17th and Glenarm. Geo. Gauss, Pres., 3869 Newton. H. Shaffroth, C. & F. S., 3749 Wynkoop St.
- 180-MEMPHIS, TENN.** Italian Hall, 1st-3d Fri. E. C. Poore, Pres., 735 Arkansas Ave. Edward O'Brien, C. & F. S., 1226 S. Orleans St.
- 187-MIAMI, ARIZ.** Every Tues., Miami Hall. J. W. Landers, Pres. Frank E. Rock, C. & F. S., Box 1121.
- 191-VICTORIA, B. C.** 2d-4th Tues., 1424 Government St. Joe Lang, Pres., Esquimalt, P. O., B. C. A. Stewart, C. S., Box 43, Beaumont, P. O. Esquimalt, B. C.
- 193-BALTIMORE, MD.** Every Tues., Patterson Bldg., Baltimore and Gay Sts. John Shanley, Pres. James Chaney, F. S., 1419 Patapsica St. Phillip Yingling, C. S., 410 E. 27th St.

- 194—VANCOUVER, B. C. CAN-
ADA. 1st-3d Mon., at Labor
Temple.
A. Campbell, Pres., 17th Ave.,
West Vancouver.
A. Fraser, C. S., 1151 Howe St.
195—KEWANEE, ILL. 1st-3d
Frl., O'Donnell's Hall, 3d St.
A. M. Powers, C. S., 614 Beach.
197—ALBANY, N. Y. 31 Green
St., 2d-4th Sat.
J. H. Sullivan, Pres. & B. A., 173
2d St.
Jno. J. Leamy, C. S., 68 Living-
ton Ave.
198—OGDEN, UTAH. 2d-3d
Tues., Union Labor Hall on
24th St., bet. Washington and
Grant.
F. S. Dunn, C. & F. S., 116 23d St.
199—HORTON, KAS. 2d-4th
Mon., Carmen's Hall.
E. J. McCarty, Pres.
E. S. McGinnis, C. & F. S., Box
622.
200—STATEN ISLAND, N. Y.
I. O. G. T. Hall, W. Brighton,
S. L., N. Y., 3rd Mon.
Robt. Duthie, Pres., 74 Simonsen
Ave., Pt. Richmond, S. I., N. Y.
Ethan A. Johnson, C. S., 208
Broadway, W. Brighton S. I.,
N. Y.
E. McCarty, B. A., 67 St. Mark's
Place, N. Y. City.
201—WINONA, MINN. Labor
Temple, 1st-3d Tues.
Frank Rice, Pres., 574 W. 7th St.
W. Kukowaki, C. S., 176 Mankato
Ave.
J. H. Buchholz, F. S., 251 E.
King.
204—MONOLULU, H. I. Waverly
Hall, 2d-4th Thura.
Frank Esman, Pres., Majestic Hot-
tel.
Wm. H. Lane, C. & F. S., 900C
Kanoa Lane.
205—SAN FRANCISCO, CALIF.
2d-4th Tues., Rosch Hall, 15th
and Mission.
Wm. P. Bowser, Pres., 507 20th.
J. M. Enright, C. S., 1431 Delores.
Walter Anderson, F. S., 607 And-
over.
Wm. P. Bowser, B. A., 314 14th.
206—ALGIERS, LA. 2d-4th Frl.,
Renecky Hall.
Jos. Koelnig, Pres. & C. S., 325
Elmira Ave.
C. A. Reynolds, F. S., McDonogh-
ville, La.
207—WALNUT SPRINGS, TEX.
E. P. Jones, Pres.
C. W. Leiger, C. & F. S.
209—DENISON, TEXAS. 2d-4th
Mon., over State Nat. Bank.
A. McDowell, Pres., 504 W. Ow-
ings St.
S. E. Harris, C. & F. S., 923 W.
Morgan St.
216—EL PASO, TEXAS. 2d-4th
Thurs., 215 S. Stanton.
Wm. Beeson, Pres., 807 N. El
Paso.
Frank H. Balt, C. S., 215 S. Stan-
ton St.
220—CHICAGO, ILL. 2d-4th
Tues., Pusey's Hall, 901 E. 75th.
Thos. P. Smith, Pres., 315 W. 51
Place.
A. G. Smith, C. & F. S., 7036 Har-
per Ave.
221—PITTSBURG, KAS. 1st-3d
Tues., Red Men's Hall, W. 3d St.
E. E. Hiett, Pres., 1803 N. Grand
Ave.
P. J. Hiett, C. S., 1801 N. Grand.
222—MART, TEXAS. W. O. W.
Hall.
E. J. Blount, Pres.
G. W. Coates, C. & F. S.
223—UTICA, N. Y. Labor Tem-
ple, 2d Frl.
Louis Wengert, Pres., 8 Wiley St.
Edward Wengert, C. S., 43 Fass
Ave.
225—ELMIRA, N. Y. 2d-4th Sun.,
Trades & Labor Hall, 200 E.
Water St.
A. E. Stevenson, Pres., 964 McGee.
N. P. Durnin, R. & C. S., 519 Penn
Ave.
226—SALISBURY, N. C. W. O.
W. Hall, Innes and Main Sts.,
1st-3rd Frl.
J. J. Garvey, Pres., E. Spencer,
N. C.
P. P. Surratt, C. & F. S., Box 278,
Spencer, N. C.
227—CHICAGO, ILL. Garfield
Park Hall, 4039 W. Madison St.
2d-4th Sat.
John Seldon, Pres., 1107 Keeler
Ave.
Thomas Dean, F. & C. S., 2214 W.
13th St.
229—ROCHESTER, N. Y. 2d-4th
Wed., 14 N. Water St.
W. Weston, Pres., 17 Coffrey
Place.
Robt. Little, C. S., 211 Garfield.
232—OAKLAND, CAL. 2d-4th
Mon., cor. 7th and Peralta Sts.
H. Brown, Pres., 1003 Pine St.
Geo. Young, C. S., 1788 9th St.
233—COLUMBIA, S. C. 2d-4th
Tues., Plumbers' Hall, 1623
Main St.
J. M. Fricks, Pres., 3403 College
St., Colonial Hts.
J. W. Bankhead, C. & F. S., 1727
Laurel Ave.
236—MARQUETTE, MICH. 4th
Thurs., E. Seigle's Hall.
Albert Bastien, Pres., 347 West
Washington.
Arthur Bourgois, C. S., 817 North
3d St.
237—HARTFORD, CONN. 2d-4th
Wed., at C. L. U. Hall, Central
Row.
James Thornton, Pres., 52 Green.
John J. Reilly, C. S., 46 Pliny.
238—CLIFTON FORGE, VA. 1st-
3d Frl., Junior Hall.
A. J. Hauer, Pres., 34 Alleghany.
M. L. Steinbuck, C. & R. S., Box
336.
D. G. Clark, F. S., 192 Ridge-
way.
239—ROCKY MOUNT, N. C. 1st-
3d Mon., Machinist Hall, cor.
Sunset and Main Sts.
G. T. Mathews, Jr., Pres., 620 S.
Church.
J. S. Wakefield, C. S., Box 224.
H. L. Moore, F. S., 197 Pearl.
241—WASHINGTON, IND. Zin-
kin's Hall, 3d and Vantrees
Sts., 1st-3d Tues.
J. C. Mooney, Pres., East George.
M. W. Luke, C. & F. S., 1097 W.
Main.
242—SPOKANE, WASH. 2d-4th
Wed., Carpenters' Hall, No. 9
Madison St.
Frank Depender, Pres., 611 E.
Indiana Ave.
R. L. Mason, C. S., 212 S. Pitts-
burg St.
243—BELLEFONTAINE, O. Last
Sunday in each month, Eagles'
Hall.
H. S. Dickenson, Pres., 329 Gar-
field.
R. E. McNeff, C. & F. S., 105 N.
Elm.
244—SIOUX CITY, IOWA. 3d
Wed., Motor Mart Bldg.
John Ewing, Pres., 103 Alice St.
Robt. O'Hern, C. S., No. 5 14th.
245—CONCORD, N. H. 2d-4th
Mon., Central Labor Union Hall.
Geo. Tanner, Pres., Hall St.
J. J. Berryman, C. S., 2 Home Ave.
J. R. New, F. S., 120 Broadway.
246—TERRE HAUTE, IND. Cor.
8th and Wabash Ave., 1st-3d
Tues.
H. M. Showalter, Pres., 1410 S.
17th.
Jesse Dukes, C. S., 1561 S. 18th.
F. Wittke, F. S., 1709 N. 12th.
247—TACOMA, WASH. 1st-3d
Mon., Odd Fellows' Hall, S. Ta-
coma.
Andrew Hansen, Pres., 5406 So.
Paks St.
Wm. Polzin, C. & F. S., 1727 So.
56.
248—HUNTINGTON, W. VA. Ev-
ery Wed., Thompson Bldg., cor.
20th St. and 3d Ave.
J. S. Myers, Pres., 1720 Collis Ave.
Eugene Brennan, C. & F. S., 532
23d St.
A. E. Pring, B. A., 1812 13th Ave.
250—BOSTON, MASS. Hollis Hall,
724 Washington St., 1st-3d Frl.
James Downey, Pres., 3 Cathed-
ral.
Jeremiah Murphy, C. S. & B. A.,
107 Union Park St.
J. F. Neas, F. S., 1177A Tremont,
Roxbury, Mass.
254—CHICAGO HEIGHTS, ILL.
1st-3d Mon., at Trades & Labor
Assembly Hall, West End Ave.
Thomas Hines, Pres., 1656 West
End Ave.
Thomas Brooks, C. & F. S., 306
W. 15th Place.
259—LIMA, OHIO. 2d-4th Thura.
334 No. Main.
A. C. Thompson, Pres., East Flin-
ley.
A. K. Griesheimer, C. S., 329 N.
Elizabeth.
Harry Gunn, F. S., 713 W. Met-
calfe.
265—SMITHVILLE, TEXAS. 1st-
4th Mon.
M. C. Vaughn, Pres., P. O. Box
521.
Guy Hooper, C. & F. S., P. O.
Box 356.
267—MOBERLY, MO. 2nd and 4th
Thurs., Painters' Hall.
J. J. Cadagin, Pres.
F. R. Lee, C. S., 601 Monroe Ave.
276—ST. LOUIS, MO. 2d-4th Frl.,
N. E. Cor. 11th and Locust.
Herbert Abbey, Pres., 2618 Ann Av.
Henry Waackler, C. S., 2919A Mi-
ami.
Clyde Stevens, F. S., 1914 N. 21st.
E. St. Louis, Ill.
278—ELKINS, W. VA. 2d-4th
Thura., Kendall Hall.
Geo. Cadw, Pres., 620 Yokem.
C. H. Goodwin, C. & F. S., 3 Cen-
ter St.
279—EDMONTON, ALB. CAN. 1st
Mon., Calder, Edmonton.
Wm. J. Fitzmaurice, Pres., Box
2100, of E. D. & B. C. Ry.
James McLean, C. & F. S., 10236
113th St.
281—NORWOOD, MASS. 2d-4th
Frl., 724 Washington St., Bos-
ton.
Amos Bennett, Pres., 130 Dart-
mouth, Boston, Mass.
Robert Henderson, C. S., 274 Met-
ropolitan Ave., Roslindale, Mass.
284—FREEPORT, ILL. 1st Sun.,
at Blust Hall.
C. J. Pontius, Pres., 26 Park Ave.
Earl Barth, Secy-Treas., 1334 20th
Ave., Rockford, Ill.
286—FORT SCOTT, KAS. 1st-3d
Mon., Redmen's Hall, 111 E.
Wall St.
J. W. McNow, Pres., 816 Marion
Ave.
J. C. Bonesteel, C. S., 1213 So.
National.
287—KINGSVILLE, TEXAS.
M. H. Nicholson, Pres., Gen. Del.
E. C. Martin, C. S., Box 162.
290—BREMERTON, WASH. 3d
Tues., Hunter & Daily Bldg.,
Pacific Ave.
Percy Counter, Pres., Box 572,
Charleston, Wash.
John Hornby, C. & F. S., Gen.
Del.
292—PARSONS, KAS. 2d-4th
Tues., Moose Hall.
Frank Thompson, Pres., 2318
Crawford.
E. P. Butler, C. S., 1723 Gabriel.
293—SHAWNEE, OKLA. 2d-4th
Mon., Moose Hall.
Floyd Ott, Pres., 602 University
Ave.
A. D. Ross, C. & F. S., 429 N.
Park Ave.

- 299—PORTSMOUTH, VA.** C. L. U. Hall, 2d-4th Thur. M. A. Garris, Pres., 2226 King. H. W. Jarrett, F. S., 1822 County. Robt. T. Howe, C. S., 826 4th St.
- 300—WATER VALLEY, MISS.** I. O. F. Hall, 1st-3d Thur. C. H. Baker, Pres. and Treas.
- 301—CANTON, OHIO,** 1st-3d Mon., Switzer Hall, Cherry and 8th Sts. Joe Petch, Pres., 1119 5th St., N. E. B. J. Gussett, C. & F. S., 1202 McKinley Ave., S. W.
- 302—MILWAUKEE, WIS.** 1st-3d Sat., Lipp's Hall, 3d and Prairie. Henry J. Murray, Pres., 118 29th. Hugh J. Fuller, C. S., 406 30th. John DuBrucq, F. S., 217 1/2 4th Ave. John L. Callahan, B. A., 3606 Clifton Ave.
- 305—FORT ARTHUR, TEXAS.** 2d-4th Tues., Labor Hall. C. L. Bragg, Pres., Gen. Del. T. O. Riley, C. S. & B. A., Box 683. James Ross, F. S., Box 2.
- 306—EVANSTON, WYO.** I. O. O. F. Hall, 1st-3d Wed. John T. Whittle, Pres., County Road. J. H. Willoughby, C. S., Box 419.
- 311—SOUTH KAUKAUNA, WIS.** 2d-4th Mon., Odd Fellows' Hall. Louis Crevier, Pres. Chas. Robedeau, C. & R. S., P. O. Box 279.
- 312—SELMA, ALA.** 1st-3d Wed., at R. R. Y. M. C. A. J. F. Ryals, Pres. W. P. Fawcett, C. S., 1509 Selma.
- 315—McCOMB, MISS.** Central Trade and Labor Hall, 1st-3d Wed. at 7:30. R. O. Bean, Pres. & C. S., Box 684.
- 317—RICHMOND, CALIF.** 2d-4th Fri., Barnman's Hall, 19th St. Frank Mallinson, Pres., care Randall Hotel. Wm. Jones, C. & F. S., Box 634.
- 318—PITTSBURGH, PA.** 1st-3d Mon., Hazlewood Bank Bldg., cor. 2d and Hazlewood. W. Mertz, Pres., Path Alley. T. A. Hudson, F. S., 310 Johnston Ave.
- 320—MERIDAN, MISS.** B. L. E. Hall, 5th St. and 40th Ave., 1st-3d Thurs. J. A. Smitheren, Pres., 511 40th Ave. J. E. Alexander, C. & F. S., 3817 38th St.
- 322—ST. LOUIS, MO.** 1st-3d Tues., Reddy Hall, 3100 Chautau. John Coats, Pres., 2726 Washington Ave. W. J. Tinell, C. S., 812 Atlantic, Webster Grove, Mo.
- 323—CHICKASHA, OKLA.** 2d-4th Fri., Labor Hall, 4th and Choctaw. C. A. Chincholl, Pres., P. O. Box 562. W. L. Harkins, C. & F. S., 528 S. 15th.
- 328—SHREVEPORT, LA.** K. of P. Hall, over West End Drug Store, 2d-4th Thurs. H. Abbott, Pres., 1543 Luchina Ave. H. W. Huff, C. S., 1863 Texas Av.
- 332—CUMBERLAND, MD.** 1st-3d Mon., Odd Fellows' Hall. C. C. Bowen, Pres., 107 W. 1st. Geo. H. Little, C. S., 401 E. 1st. J. R. Beck, F. S., 106 W. 1st.
- 334—PRINCETON, IND.** 2d-4th Tues., Redmen's Hall. Joe Myers, Pres., 1101 S. Race. Fred Day, C. S., 617 Gibson.
- 335—GRAND JUNCTION, COLO.** 2d-4th Fri., Eagles' Hall. G. R. Stoll, Pres., 337 White. E. H. Friend, C. & F. S., 308 Pitkin Ave.
- 339—SPARKS, NEV.** 2d-4th Wed., Engineers' Hall. Wm. Daseier, Pres., P. O. Box 214. C. E. Crouch, C. S., P. O. Box 204.
- 340—HERINGTON, KAS.** 1st-3d Sat., I. O. O. F. Hall. John Olson, Pres. J. E. Anderson, C. S., 303 N. 8th.
- 341—PHILADELPHIA, PA.** 2d-4th Tues., 8 p. m., Labor Headquarters, 232 N. 9th St. Wm. J. Boyle, Pres., 208 N. 58th St. Chas. Heberly, C. S., 3084 Aramingo Ave.
- 344—SHEFFIELD, ALA.** 1st-3d Wed. at I. O. O. F. Hall, Montgomery Ave. W. H. Wilson, Pres., Tuscomb, Ala. E. T. Holland, C. S., Box 65.
- 345—SAN ANTONIO, TEXAS.** Trades Council Hall, 2d-4th Thurs. F. E. Hamilton, Pres., 2103 W. Travis. E. H. Frick, C. & F. S., 1223 W. Traves Ave. Delrympel, E. A., 410 River Ave.
- 348—TRENTON, MO.** 1st-3d Tues., at Cutlip's Hall. Walter Mason, Pres., 1726 Lula Ave. Geo. W. Singer, C. & F. S., 1801 Maine St.
- 354—BROOKFIELD, MO.** 1st-3d Tues., 212 N. Main St. Martin Murphy, Pres., 291 Elm St. J. K. Burnham, C. S., 529 S. Living.
- 355—CONNEAUT, OHIO.** 2d-4th Fri., Stationary Eng. Hall, Main St. Chas. Ward, Pres., 685 Lakeview Ave. W. J. Brockett, C. S., 539 Blair. E. J. Dickson, F. S., 815 Main.
- 356—HAMMOND, IND.** 1st-3d Wed., Long's Hall, State St. James Boyle, Pres. Thomas Boyle, C. S., 264 State-line St.
- 360—LAFAYETTE, IND.** 1st-3d Thurs., Bartenders' Hall, 3d and Ferry Pt. Fred Ramp, Pres., 1601 N. 12th. Wm. Peterson, C. S., 426 Lingie. James Goldsberry, F. S.
- 363—EAST ST. LOUIS, ILL.** 1st-3d Fri., Wyant Hall, Broadway and Main. James Roose, Pres., 318 S. 5th. John Roche, C. & F. S., 614 Ohio Ave.
- 367—HAVRE, MONT.** 3d Sat., Oxford Hall.
- 369—ALEXANDRIA, VA.** 1st Thur. in month during summer months. 108 N. Patrick St. R. B. Craddock, Pres., 809 Cameron. M. Gemeny, R. & F. S., 1305 Prince.
- 371—LOWELL, MASS.** 2d-4th Wed., 32 Middle St. James Lanigan, Pres., 48 Blossom. J. J. Cunningham, C. S., 656 Gorham.
- 377—MOLINE, ILL.** 1st-3d Fri., Moline Industrial Home, cor. 14th St. and 5th Ave. Carl Robison, Pres., 7th St., Silvis, Ill. John Fulton, F. S., 7th St., Silvis, Ill.
- Charles McGowan, B. A., 7th St., Silvis, Ill. C. R. Kiser, C. S.; Box 581, Silvis, Ill. Walter S. Schneider, B. A., 1317 25th St., Rock Island, Ill.
- 378—MONCTON, N. B., CAN.** 2d-4th Fri., Sons of Temperance Hall. Alex McDougall, Pres., 143 High St. R. D. Donnelly, C. S., 69 Downing St.
- 379—McADAM JUNCTION, N. B., CAN.** 2d-4th Fri., Orange Hall. Geo. Guest, Pres. A. J. McLaggan, C. S.
- 381—AMARILLO, TEXAS.** 1007 Buchanan. M. L. Parker, Pres., Box 407. Joe Wilson, C. S., 1907 Buchanan.
- 382—CHILDRESS, TEXAS.** 2d-4th Fri., at 7:30 p. m., in Labor Temple. Mack. Leopold, Pres., P. O. Box 835. J. M. Neal, C. S.
- 384—PERU, IND.** 2d-4th Tues., Labor Trades Hall. Floyd W. Seitz, Pres., 164 N. Lafayette. A. W. Johnson, C. & F. S., 159 W. 3rd. Frank Sullivan, B. A., 133 W. 3d.
- 386—MECHANICSVILLE, N. Y.** 2d and last Tues., A. O. H. Hall, North Main St. James S. Kennedy, Pres., S. Second Ave. Sidney Crozier, C. S., 28 Railroad. Chas. Chapman, F. S., 112 N. 2d.
- 390—TRINIDAD, COLO.** 2d-4th Wed., Labor Union Hall, East Main St. W. F. Flynn, Pres. and C. S., 915 Arizona Ave.
- 391—DAVENPORT, IOWA.** 2d-4th Fri., Danish Hall. John Schach, Pres., 516 1/2 W. 3d. R. F. Stewart, C. S., 616 Tremont Ave. W. C. Richards, F. S., 1938 Bridge Ave.
- 392—CALGARY, ALBERTA, CAN.** 3d Sat., 2:30 p. m., Labor Temple. J. Chambers, Pres., Ogden, P. O. Perry, Willis, C. S., 1614 11th Ave.
- 393—GOODLAND, KAS.** 1st-3d Tues., Calvert & Sparks' Law Office. S. E. Braffet, Pres. Earl Crause, C. & F. S.
- 395—NORTH FOND DU LAC, WIS.** 1st-3d Fri., Trades and Labor Hall, cor. 3d and Main. Carl Deyer, Pres., 615 Michigan Ave. Jos. A. Hantzinger, C. S., 223 E. Johnson, Fond du Lac, Wis.
- 396—NORWICH, N. Y.** 4th Wed. in Cook Block. James E. Callahan, Pres., 1 Columbia St. Julius Schraft, C. & F. S., 13 Davis.
- 397—RIVIERE DU LOUP, QUEBEC, CANADA.** 2d-4th Mon., Rioux Hall. Mag. Bourgoin, Pres., River du Loup Station. Jos. Beaulieu, E. A., Blaisville. Ludger Oullet, C. & F. S., Blaisville.
- 400—MIDDLETON, N. Y.** 1st-3d Fri., Odd Fellows' Hall. Wm. Springer, Pres., 55 Beattie Ave. Wm. E. Appel, F. S., 378 North. Chris Smith, C. S., 381 North St.
- 402—PORTSMOUTH, OHIO.** 2d-4th Fri., C. L. U. Hall. R. L. Johnson, Pres., 2949 Gallia. E. L. Wilson, F. S., 1721 6th St. Wm. H. Miller, C. S., 1411 Grandview Ave.

- 406—HOBINGTON, KAN. I. O. O. F. Hall, 1st-3d Mon.
Ray Bowler, Pres., P. O. Box 72.
C. W. Cramer, C. & F. S., Box 494.
- 406—BLUEFIELD, W. VA. 1st-3d Fri., Masonic Temple.
E. K. Collins, Pres., Princeton Ave. E.
W. F. Dupree, C. & F. S., Gen. Del.
406—CLARKDALE, ARIZ. Carl Reblman, C. S., Box 191.
- 410—SAN FRANCISCO, CAL. 2d-4th Wed. Labor Temple, 16th and California.
Ed Hanny, Pres., 2217 Howard
L. Kevie, C. S., 208 Springdale Ave.
- 415—ST. THOMAS, ONTARIO, CAN. 2d-4th Tues., Machinists' Hall, Talbot St.
Frederick Brooks, Pres., 5 Maama
Frank Roberts, C. S., 61 Wilson
- 416—ONEONTA, N. Y. 1st Wed. and 3rd Sun., 2:30 p. m., Redmen's Hall.
James Walsh, Pres., 51 Church.
David Lawrie, C. & F. S., 73 W. Broadway.
- 415—JACKSONVILLE, ILL. F. McKenna, C. S., 476 E. State.
- 417—NORTH BAY, ONT., CAN. 2d-4th Mon., L. O. L. Hall.
A. E. Lye, Pres., Box 799.
Fred S. Gardner, C. & F. S., Box 1262.
- 418—NEODESHA, KAN. 1st-3d Sat., Baldwin Hall.
Chas. Brown, Pres.
E. P. Reddick, C. S., 1007 Iowa.
A. F. Bingham, B. A.
- 419—SOMERSET, KY. 1st-3d Tues., at Owen's Hall.
W. C. Williams, Pres.
J. S. Arnold, C. & F. S., Sta. A.
- 421—HAMILTON, ONT. 1st-3d Fri., Labor Hall, John St. So.
L. Lawton, Pres., No. 31 Tuckett.
F. Honson, C. & F. S., 6 Bristol.
- 423—SANFORD, FLA. 3d-4th Wed., Eagles Hall.
H. E. Furden, Pres.
Geo. Randall, C. & F. S., Box 1194.
- 423—BIG SPRINGS, TEX. 2d-4th Tues., I. O. O. F. Hall.
D. D. Crawford, Pres., cor. Gregg and 3d.
W. P. Warren, C. & F. S., 201 W. 1st.
- 424—FLORENCE, S. C. 2d Thurs., Y. M. C. A.
L. H. Mims, Pres., 223 Covington St.
- A. H. Dickman, C. & F. S., 609 Day St.
- 425—WAYCROSS, GA. 1st-3d Thurs., Loot Hitch Bldg.
C. M. Schultz, Pres., 37 Stephens Ave.
L. J. Fiohr, C. & F. S., Box 236.
- 427—SALIDA, COLO. 3d-4th Thurs., Adlas Hall.
H. F. Jones, Pres., 135 E. Sacket Ave.
Wm. Dargavel, C. S., 821 E. St.
- 428—NORFOLK, VA. 2d-4th Wed., Pythian Castle Hall.
W. M. Wood, Pres., 617 Liberty St., Berkely, Va.
Thos. Callahan, C. & F. S., 116 Middleton St., Berkeley, Va.
- 430—CAPE GIRARDEAU, MO. 1st-3d Tues., Haas' Hall.
Geo. Stanley, Pres., 223 Frederick St.
Oscar O. Berry, F. S., 415 S. Frederick St.
- 431—BOSTON, MASS. 2d Thurs., Naomi Hall, 724 Washington.
Thos. R. Keenan, C. S., 80 W. 8th St., So. Boston.
- 434—CHICAGO, ILL. 3d-4th Tues., Marquette Hall, 6650 Halstead St.
H. Fischer, Pres., 6438 Sangamon
Edward Osborn, C. S., 48 E. 43d St.
- 435—BRISTOL, TENN. 2d-4th Fri., Sixth and Shelby Sta.
M. C. Cooper, Pres., V. & S. W. Ry. Shops.
J. B. Wood, C. & F. S., 27 Lancaster St., Bristol, Va.
- 436—COLUMBUS, GA. 1st-3d Fri., Trades and Labor Assembly Hall.
R. S. Barry, Pres., 911 4th Ave.
H. W. McMichael, C. & F. S., 1105 21st St.
- 437—TWO HARBORS, MINN. 2d and last Thurs., Iron Dock Grove Hall.
Christ. Anderson, Pres.
Charles Larson, C. & F. S., Box 298.
- 438—GALETON, PA. 2d-4th Tues., Eagles' Hall.
J. M. Parker, C. S., 10 Williams St.
- 439—FAIRBURY, NEB. 4th Wed., K. of L. S. Hall.
B. Z. Milliken, C. & F. S., P. O. Box 167.
Fred Kurst, B. A.
- 440—BELLE PLAINE, IOWA. 2d-4th Mon., Fireman's Hall.
Charles Corns, Pres., 10th St.
Warren Wheeler, C. S., P. O. Box 606.
- 442—NEW ORLEANS, LA. 3d Tues., McMahon Hall, 1112 Drades.
James Miller, Pres., 1204 So. Franklin.
John Mocklin, C. & F. S., 606 S. Telemachus St.
- 444—CONNELSVILLE, PA. J. W. Easley, C. S., 517 N. Pgh.
- 446—ALAMOSA, COLO. 3d-4th Wed., Trades Assembly Hall.
Albert Jacobson, Pres.
Chas. F. Darling, C. S., Box 84.
- 447—DECATUR, ILL. 1st-3d Tues., Ashley Hall, Mason Temple.
Jas. Gray, Pres., 317 N. Broadway.
Chas. J. Younger, C. & F. S., 432 E. King St.
- 448—MONTGOMERY, ALA. 1st-3d Wed., Youn's Hall.
J. A. Redding, Pres., 316 Columbus.
E. J. Ford, C. S., 75 Morgan Ave.
- 449—SAPTULA, OKLA. 2d-4th Mon., Moose Hall.
M. E. Lange, Pres., 913 E. Hobson.
Irwin Shipman, C. S., Box 338.
- 450—WASHINGTON, D. C. 2d-4th Wed., New Masonic Hall, 8th and F Sta., N. E.
A. W. Sherier, Pres., 106 15th S. E.
- W. F. Kilroy, C. S., 11 I St., N. E.
- 451—WINNIPEG, MAN., CAN. 3d Fri., Labor Temple.
D. Nelson, Pres., 469 Hetherington Ave.
- F. Snare, C. & F. S., 263 Bradford St., St. James.
- 453—COPPERHILL, TENN. 1st-3d Tues., I. O. O. F. Hall.
Chas. Frenz, Pres., Box 711.
E. N. Hall, C. S., Box 332.
- 454—CHICAGO, ILL. 2d-4th Thurs., Persey Hall.
Walter Love, Pres., 752 E. 69th St.
E. R. Dettmer, C. S., 9245 Stoney Island Ave.
- 455—SHERMAN, TEXAS, 2d-4th Thurs., Machinists' Hall.
W. K. Murray, Pres., Tucket Ave.
John Plexco, C. & F. S., 424 Gribble Ave.
- 462—BALBOA, CANAL ZONE, PANAMA. 1st-3d Fri., Ancon Lodge Hall.
A. R. R. Charters, Pres., Carozal, C. Z.
W. H. Keenan, C. & F. S., Box 76, Balboa, C. Z.
- 464—PALESTINE, TEXAS, Labor Temple, 2d-4th Wed.
J. S. Gulinn, Pres., 635 Tenn. Ave.
J. D. Mallette, C. & F. S., P. O. Box 133.
- 466—REVELSTOKE, B. C. 3rd Sat., Selkirk Hall.
M. M. Keller, Pres., Box 138.
A. McMahon, C. S., Box 138.
- 467—PORTSMOUTH, N. H. 3d Wed., Magies Hall.
John Quinn, Pres., Court St.
Alfred Olson, C. A., Box 37, Kittery, Me.
- 469—TERRELL, TEXAS, 2d-4th Fri., Trades and Labor Hall, 302 E. Moore Ave.
J. R. Poston, Pres., 608 E. College St.
R. E. O'Reilly, C. S., 906 E. Moore Ave.
- 471—CRISTOBAL, C. Z. 2d-4th Thurs., Canal Lodge Hall.
Alexander McKenzie, Pres.
Jas. Z. Knapp, C. & F. S., Box 219.
- 472—HELPER, UTAH. 1st-3d Wed., K. of P. Hall.
Wm. R. Welsh, Pres.
R. W. Smith, C. & F. S., Box 411.
- 476—GRAND ISLAND, NEB. 1st-3d Mon., City Hall, 2d St.
H. W. Hunt, Pres.
Sherman Aldrich, F. S., 1014 E. 4th St.
- 476—DALHART, TEXAS, 3d Fri., Socialist Hall.
H. C. Fritche, Pres.
Theo. P. Nelson, C. & F. S., Box 282.
- 478—MOOSE JAW, SASKATCHEWAN, CANADA. 2d-4th Mon., Trades and Labor Hall, Main St.
Wm. Gillies, Pres., 364 Fairford St., W.
W. G. Vaughan, Secy.-Treas., Box 352.
- 479—DEVIL'S LAKE, N. DAK. 1st Fri., Opera House Hall.
- 481—LYNDONVILLE, VT. 1st-3d Wed., Eaton's Hall.
E. A. Hinds, Pres.
E. A. Phillips, C. & R. S., Box 121, Lyndon Center, Vt.
J. M. Bresson, B. A.
- 482—ALTON, ILL. Schwartzbeck Hall, 3d and Ridge. 1st-3d Tues.
D. Stafford, Pres., 1009 E. 5th St.
Robt. Dale, C. & F. S., 3003 Edwards.
- 485—GREEN BAY, WIS. 1st-3d Thurs.
John Christianson, Pres., 322 S. Maple Ave.
John Slater, C. & F. S., 425 5th St.
J. L. Callahan, B. A., 3606 Clifton Ave., Milwaukee, Wis.
- 486—TYLER, TEXAS, 1st-3d Wed., K. O. T. M. Hall.
J. A. Fuller, Pres., 1116 Irvin.
J. M. McCarty, C. & F. S., 216 Center Ave.
C. R. Welch, B. A., 1428 N. Fannie Ave.
- 491—VALLEY JUNCTION, IOWA. 1st-3d Tues., I. O. O. F. Hall.
Frank S. Hoppe, Pres.
J. C. Carroll, C. S., Box 165.
Geo. W. Fring, B. A., Treas.
- 492—NEW CASTLE, PA. Jan. 13, 1915, and every other Wed., Trades Assembly Hall.
D. E. Sturdevant, Pres., 516 Waldo.
David Lewis, C. & F. S., 422 Galbreath Ave.
- 495—HATTIESBURG, MISS. 1st-3d Tues., 500 Boule St.
C. W. LeBlanc, Pres., 107 Evans.
A. H. Waddell, C. & F. S., 509 Boule.
- 498—HURON, SOUTH DAKOTA. 2d Sun. and 4th Fri., Labor Hall.
Peter Paluszak, Pres.
C. Storkson, C. & F. S., 223 Beach St.

500 - EVERETT, WASH. 2d-4th Tues., Labor Temple, 3506 Everett Ave.

501 - WACO, TEXAS. 2d-4th Fri., Labor Hall.
Chas. Bullock, Pres., R. F. D. No. 2.
Wm. Dickerson, C. & F. S., 514 N. 15th.

502 - TRAGUE, TEXAS. 1st-3d Mon., Davis Hall.
Thos. McGrath, Pres., Box 344.
O. D. Clayton, C. S.

503 - FITZGERALD, GA. 1st-3d Wed., I. O. O. F. Hall.
M. J. Mauns, Pres., P. O. Box 686.
A. B. Campbell, C. S.

504 - MUSKOGEE, OKLA. 1st-3d Wed., Carpenters' Hall.
Guy Carver, Pres., 1220 Baltimore.
W. H. Hannaford, C. & F. S., Gen. Del.

505 - FORT WILLIAM, ONTARIO, CAN. 1st-3d Fri., Electricians' Hall, Murphy Block, Simpson Ave.
James Duncan, Pres.
A. Cruickshank, C. S., 1007 Minn. Ave.

507 - ATCHISON, KAS. 1st-3d Mon., Fireman's Hall, 1521 Main St.
J. F. Coyle, Pres., 1418 Kansas Ave.
John J. Freibott, C. & F. S., 1420 Kansas Ave.

509 - JACKSON, OHIO. 4th Tues., Hibernian Hall.
O. B. Reynolds, Pres., 77 High St.
Albert Edmonds, C. S., 77 Hunt St.
J. B. Fillinger, B. A. and Journal Cor., 53 Main St.

510 - CEDARTOWN, GA.
E. M. Kendricks, Pres.
I. C. Smith, C. S.

511 - WHISTLER, ALA. 1st-3d Mon., I. O. O. F. Hall.
J. B. Chestang, Pres.
C. C. Crone, C. S., 209 Bauregard, Mobile, Ala.

515 - EAST CAMBRIDGE, MASS. Engineers' Hall, 164 Canal St., Boston, Mass., 1st-3d Fri.
Geo. L. Parks, Pres.
John P. Grant, C. & F. S., 124 Spring.

517 - GREENFIELD, MASS. 2d-4th Sat., Forester Hall.
Patrick Kelley, Pres., 3 Devens.
Tim Scannell, C. & F. S., 6 Russell St.

518 - WICHITA, KAS. 1st-3d Thurs., 216 N. Main St.
G. W. Thompson, Pres., 2127 University Ave.
O. E. Maze, C. S., 1415 W. Maple.

520 - MILES CITY, MONT. 2d-4th Fri., Wilboux Hall, 7th and Main.
P. J. Gallagher, Pres., 602 N. Lake St.
Chas. E. Cook, C. & F. S., 119 N. Strevelle.

521 - VAN BUREN, ARK. 1st-3d Tues., Federation Hall.
Hal. Stack, Pres.
C. Montgomery, C. S., Box 343.
C. A. McDonald, B. A., 4416 Norledge, Kansas City, Mo.

522 - EL RENO, OKLA. 1st-3d Tues., Redmen's Hall.
H. E. Hart, Pres., Box 624.
H. A. Mathews, C. & F. S., Box 12.

523 - PRATT, KAS. 2d-4th Tues., at S. T. Sample's residence.
W. F. Stephen, Pres., 624 N. Ninir-sah St.
F. W. Sharpe, C. S., Box 23.

524 - MURPHYSBORO, ILL. 2d-4th Wed., Machinists' Hall, 107 S. 10th.
A. R. McFarland, Pres., 638 N. 8th.

E. P. Heria, C. & F. S., 2107 Wall.

525 - HINTON, W. VA. 1st-3d Mon., Big Four Bldg.
W. L. Taylor, Pres., 108 Grace St.
C. L. Barnett, C. & F. S. & B. A., 619 Summer Ave.

528 - DEER LODGE, MONT. 2d-4th Fri., I. O. O. F. Hall.
T. J. Messing, Pres.
J. H. Thomas, C. & F. S., P. O. Box 377.

529 - WINNIPEG, MAN., CAN. 1st Sun., Campbell Hall, Transcona, 3rd Sun., Labor Temple, Winnipeg, 3 p. m.
A. Orr Pres., James St., East.
James Hawthorn, C. & F. S., 869 Boyd Ave.

530 - SPRINGFIELD, MO. 2d Mon., Densgeldem's Hall.
J. W. Reddick, Pres., 817 Lincoln.
John Cain, C. & F. S., 507 Fort.
A. F. Bingham, B. A., 701 Lombard St.

531 - CHAFFEE, MO. 1st-3d Thurs., City Hall.
T. C. Davis, Pres.
C. P. Bourion, C. & F. S., Box 365.

537 - COVINGTON, KY. 2d-4th Fri., Workman Hall, 122 Pike St.
A. J. Pope, Pres. & B. A., 1817 Scott St.
John J. Fielding, C. & F. S., 1341 Holman.

541 - BEDFORD, IND. 2d-4th Thurs., Labor Union Hall.
Dan J. Kane, Pres., 511 N. I. St.
C. J. Bordenet, C. S., 623 N. I.

542 - COFFEYVILLE, KAS. Labor Temple, 2d-4th Wed.
R. M. Jones, Pres., 807 W. 14th.
J. C. Morrow, C. & F. S., 613 W. 4th St.

543 - WICHITA, KAS. 216 N. Main St., 2d-4th Wed.
C. E. Grove, C. & F. S., 701 W. Central.

546 - MONETT, MO. 1st-3d Tues., K. C. Hall.
T. J. Moore, Pres., 706 Benton Ave.
John Linebarger, C. & F. S., 214 Pearl St.

547 - CARBONDALE, PA. Pugh-anas Hall, 2d-4th Fri.
E. T. Dickenson, C. & F. S., 142 Wyoming.
Wilkes-Barre Representative, T. J. Cavan, 60 Chester St., Wilkes-Barre, Pa.

548 - TORONTO, CAN. 2d-4th Wed., Labor Temple, Church Joseph P. Dobson, Pres., 280 Perth Ave.
John C. Walker, C. & F. S., 152 Gladstone Ave.

549 - MIDDLEPORT, O. 1st-3d Tues., Firemen's Hall.
Lester Cunningham, Pres.
Ferry Cooper, C. & F. S.

551 - PRINCETON, W. VA. Castle Hall, 1st-3d Thurs.
J. H. Blackwell, Pres., Box 212.
J. J. Bowers, C. S., 516 Bluefield.

556 - OKLAHOMA CITY, OKLA. C. S. Cochran, Pres., 406 W. Frisco.
El. F. Ryan, C. & F. S., 400 West Frisco.

557 - WILLIAMSON, W. VA. 2d-4th Tues., Eagles' Hall, 3rd Ave.
W. H. Turner, Pres., 113 6th Ave.
H. W. Bias, C. & F. S., 124 Oak.

564 - PARISO, C. Z.
W. H. Kirby, Pres.
P. H. Dowell, C. & F. S. La Boca, C. Z.

565 - FALLS CITY, NEB. 1st-3d Thurs., W. O. W. Hall.
C. W. Jones, Pres.
E. Woodington, C. & F. S., 710 E. 16th St.

567 - SAN ANGELO, TEX. 1st-3d Wed., Eagles' Hall.
R. W. Berry, Pres., 23 W. Ave. I.
R. L. Wright, C. S., 27 West Ave. I.

568 - TACOMA, WASH. Maacabee Hall, 1109 1/2 C St., 2d-4th Thurs.
Chas. Manning, Pres., 5808 S. Lawrence St.
A. W. Rickett, C. & F. S., 615 So. State.

570 - HIGH SPRINGS, FLA.
H. A. Smith, Pres., P. O. Box 273.
F. C. Magerstaadt, C. S.

571 - DE PERE, WIS. De Both Hall, 1st Sun.-3d Wed.
T. J. McDonald, Pres., Lock Box 44, W. De Pere, Wis.
A. B. Steinfeldt, R. S., P. O. Box 207.

573 - LANSFORD, PA.
Frank A. O'Donnell, C. S., Summit Hill.

575 - VILLA GROVE, ILL. 1st-3d Fri., Red Men's Hall.
James Tally, Pres.
A. Welch, C. S.
H. A. Downes, F. S.

576 - WICHITA FALLS, TEX. 2d-4th Thurs., Labor Hall.
J. H. Gibson, Pres., 309 Lee St.
E. A. Monahan, C. & F. S., Box 760.
C. H. Shoemaker, B. A., Box 18, Healdton, Okla.

577 - CUMBERLAND, MD. 1st-3d Thurs., Trade Council Hall.
E. H. Stealey, Pres., Ridgeley, W. Va.
Owen Layman, C. & F. S., Ridgeley, W. Va.

578 - HAGERSTOWN, MD. Moose Hall, 2d-4th Thurs.
J. S. Bussard, Pres., 215 Ridge Ave.
F. H. Stouffer, F. S., 817 Summit Ave.
C. F. Martz, C. S., Boulevard and Cedar St.

579 - KEYSER, W. VA. 1st-3d Tues., City Building.
W. H. Wolf, Pres., Gilmore St.
P. R. Dougan, F. S., Gilmore St.
Joseph F. Hines, C. S., Piedmont, W. Va.

580 - HALIFAX, N. S. CAN. 1st-3d Wed.
Thomas Burns, Pres., Star St.

581 - MONTELEONE, O. 1st-3d Wed., Ry. Trainmen's Hall.
S. Brown, Pres.
J. Birmingham, C. S.

582 - BATON ROUGE, LA. 2d-4th Thurs., Odd Fellows' Hall, 3d St.
W. P. Kidd, Pres., 303 St. Philip St.
S. V. Acosta, C. & F. S., 218 St. Ferdinand St.

583 - NEVADA, MO. Socialist Hall, Hall, So. Main St., 1st-3d Thurs.
A. C. LeQuellec, Pres., 520 E. Cherry.
L. E. Whitehead, C. & F. S., R. F. D. No. 1.
C. A. McDonald, B. A., 4416 Norledge, K. C., Mo.

584 - LUDLOW, KY. 1st-3d Thurs., Morley Hall.
Thos. Jackson, Pres., 17 Pherry.
H. J. Stroer, C. S., 833 Main, Covington, Ky.

585 - BOSTON, MASS. 1st Thurs., 8 p. m., and 3d Sun., 2:30, Hemstead Hall, 724 Washington St.
Wm. E. McNabb, Pres., 263 Chelsea, B. Boston, Mass.
Daniel E. McInnes, C. S., 283 Marginal Ave., E. Boston, Mass.
Daniel N. Generson, B. A., 17 Bul-lard, Dorchester, Mass.
James Vincent, F. S., 77 Lavh Hill.

586—SLATER, MO. 2d-4th Mon.,
I. O. O. F. Hall.
Chas. Crawford, Pres.
Andy Phelps, C. & F. S.

587—BEAUMONT, TEX. 2d-4th
Tues., Trades' Assembly Hall.
Geo. H. Clayton, Pres., Box 624.
T. C. Maddy, C. & F. S., Box
624.

588—CHICAGO, ILL. 2d-4th
Tues., Koop's Hall, California &
North Aves.
Thomas Godfrey, Pres., 930 E.
44th St.
John McNaney, C. & F. S., 819 N.
Rockwell.

589—MILWAUKEE, WIS. 2d-4th
Thurs., 923 E. Water St.
Frank Thinner, Pres., 729 5th.
M. J. Gleason, C. & F. S., 203
Michigan St.

590—MONROE, LA. 1st Fri., 615
A. St.
J. W. Grant, Pres., 501 Wood St.
J. J. Deversux, C. & F. S., 615
Calypso St.

591—GLENDALE, MONT. 2d-4th
Fri., Noderhoff Hall.
N. A. Schoppe, Pres., Gen. Del.
V. E. O'Connor, C. & F. S., 317
Valentine.

592—TULSA, OKLA. 2d-4th Sat.
214 1/2 S. Main.
J. E. Dixon, Pres.
Richard Leach, C. & F. S., 215
Reeder Bldg.

593—CLIFTON, ARIZ. Every
Sat., Carpenters' Hall.
Homer Darr, Pres., Box 704.
Joseph B. Hammer, C. & F. S.,
Box 191.

594—STANBURY, MO. 2d-4th
Tues., K. of P. Hall.
John Inman, Pres.
E. W. McNew, C. S.

595—AVERY, IDAHO. 2d-4th
Mon., Godfrey's Home, West
Avery.
A. Anderson, C. & F. S., Gen. Del.

596—CASPER, WYO. 2d-4th Mon.
John Mulligan, Pres., 232 N.
Beach.
H. L. Celley, C. S., 509 S. Beach.

597—ESCANABA, MICH. 1st-3d
Thurs., Lemmer Hall, Luding-
ton St.
Jos. Vickers, Pres., 506 Wells Ave.
Wm. Grosnich, C. & F. S., 714
Wells Ave.

598—SALAMANCA, N. Y. 1st-3d
Mon., 3 Maple St.
A. G. Frey, Pres., 165 E. State St.
D. J. Carpenter, C. & F. S., 3
Maple St.

599—PARAGOULD, ARK. 1st-3d
Thurs., Carpenters' Hall.
J. W. Frey, Pres., 221 S. 2d St.
A. Johnson, C. & F. S., 216 N.
5th Ave.

C. A. McDonald, B. A., 4476 Nor-
ledge, Kansas City, Mo.

601—QUEBEC, CAN.
A. Bourget, Pres., 197 3rd St.,
Limolow.
G. Dery, C. S., 153 4th St., Li-
morlow, Quebec, Can.

602—GREAT FALLS, MONT. 2d-
4th Tues., Musicians' Hall, over
the Mint.
J. L. Smith, Pres., 205 2nd Ave.
North.
Roy J. Preston, C. & F. S., 420
8th Ave. So.

603—OTHELLO, WASH. 1st-3d
Mon., I. O. O. F. Hall.
O. W. Bohusock, Pres.
W. O. Clark, C. S., Box 137.

604—JOLIETTE, QUE., CAN.
H. Fournier, Pres., Gen. Del.
E. Duval, C. S., Gen. Del.
G. Lahaye, F. S., Gen. Del.

605—TOOELE, UTAH. 2d-4th
Thurs., Fraternal Hall.
D. B. Sullivan, Pres.
L. Forno, F. S., Box 294.

606—MORBRIDGE, S. D. 1st-3d
Thurs., Moose Hall.
J. P. Schmickrath, Pres., Box 721.
H. L. Adams, C. & F. S., Box 168.

607—BAYONNE, N. Y.
Thomas F. Richardson, C. & F. S.,
30 W 15th St.

International Officers of the Ladies' Auxiliary

MRS. J. W. EDWARDS.....President
1234 S. 9th East St., Salt Lake
City, Utah.

MRS. F. R. REINEMEYER...1st Vice-President
Tauromee Ave., Kansas City, Kan.

MRS. MOLLIE GEARY.....2nd Vice-President
6428 S. Albany St., Chicago, Ill.

MRS. A. F. BINGHAM.....Secretary-Treasurer
701 Lombard St., Springfield, Mo.

L. A. 5—SALT LAKE CITY, UTAH.
Mrs. J. W. Edwards, Pres. & C. S., 928 W. South Temple St.
Mrs. Lydia Smithen, V.-Pres., 360 West 1 South St.
Mrs. J. C. Walton, F. S.
Mrs. Jane Foreman, Treas.
Mrs. Morton, R. S., 116 Markham.

L. A. 7—SUNFLOWER, Parsons, Kas. 2d-4th Tues. aft., Kennedy Hall.
Mrs. Lillian Dudding, Pres., 2229 Crawford Ave.
Mrs. Alice Leach, Vice-Pres.
Mrs. Zita Rever, Treas.
Mrs. Lula VanVleck, C. & R. S., 2701 Clark Ave.
Mrs. Ethel Smith, Fin. Sec., 2227 Wash. Ave.
Mrs. Mary Carver, Chaplain.
Mrs. Marion Butler, Marshall.
Mrs. Ida Cormany, Conductress.
Mrs. Kate McMullen, In. Guard.
Mrs. Emma Pilkington, O. Guard.

L. A. 8—FRANKLIN, McComb, Miss. Ladies' Aux. Hall, Ave. F. East McComb, 2d-4th Thurs.
Miss Luia Hassfield, Pres., R. F. D. No. 1.
Mrs. E. Sullivan, V.-P. & Treas., 725 Ave. F.
Miss Emma Sullivan, C. S., 735 Ave. F.
Miss Lulu Hassfield, R. S.

L. A. 9—GRAND JUNCTION, COLO.
Mrs. W. H. Holzman, Past Pres., 314 S. 5th St.
Mrs. F. N. Davies, Pres. & Treas., 538 Ute Ave.
Mrs. J. W. Cox, C. & F. S. & V.-P., 925 S. 5th St.
Mrs. L. A. Turner, R. & S. T.

L. A. 10—SPRINGFIELD, MO.
Mrs. A. F. Bingham, Pres., 701 Lombard St.
Mrs. J. Gestring, Vice-Pres.
Mrs. C. S. Gilliland, C. & R. S., 1914 Johnson St.
Mrs. Wm. Specht, F. S. & T., Route 6.
Mrs. Rheaden, Chaplain.
Mrs. J. East, Conductress and Marshall.
Mrs. J. Ritterhouse, Inside Guard.
Mrs. Gestring, Mrs. Gilliland and Mrs. East, Trustees.

L. A. 11—LONE STAR, Palestine, Texas. Labor Temple, 2d-4th Tues. afternoons.
Mrs. Frances Brunson, Pres., 15 Cottage Ave.
Mrs. Helen Redus, V.-P., 106 Queen St.
Mrs. Florence Payne, R. S. & Treas., 212 Palmer Ave.
Mrs. Willie Welch, C. & F. S., 511 Green St.

L. A. 12—GARFIELD PARK, Chicago, Ill. 2d-4th Thurs. 8 p. m. Garfield Park Hall, 4039 W. Madison.
Mrs. Maud Reinemeyer, Past Pres.
Mrs. Mollie Geary, Pres., 6428 S. Albany Ave.
Mrs. E. Farrell, V.-P., 4118 Carroll Ave.
Mrs. Helen Hughes, Cor. & Rec. Sec., 716 N. Avers Ave.
Mrs. Mary Driscoll, Fin. Sec. & Treas., 4135 Carroll Ave.

L. A. 14—TOLEDO, O.
Mrs. E. Richardson, Pres.
Mrs. Allen Thomson, V.-Pres.
Mrs. C. F. Hags, R. S.
Mrs. C. J. Sugas, C. & F. S.
Mrs. Gattie Stephan, Treas.
Mrs. Louise Brown, Conductress.
Mrs. Lena Kern, Inspectress.

L. A. 15—SAPULPA, OLKA.
Mrs. Cora Johnson, Pres.
Mrs. Myrtle Clifton, V.-Pres.
Mrs. Addie Allen, R. S.
Mrs. Bessie Lewis, C. S.
Mrs. Hester Chapman, F. S.
Mrs. Ethel Edwards, Treas.
Mrs. Hettie Rondon, Chaplain.
Mrs. Ferrel Wells, Conductress.
Mrs. Emma Davis, Inside Guard.
Mrs. Katie Hoover, Marshall.
Trustees—Laura Cargill, Mrs. Emma Davis, Mrs. Addie Allen.

L. A. 16—DECATUR, ILL.
Mrs. M. J. Kelly, Pres.
Mrs. Fred Reutlicher, Vice-Pres.
Mrs. H. J. McLaughlin, R. S.
Mrs. Henry Yost, C. & F. S.
Mrs. C. C. Dean, Treas.

L. A. 17—CHICAGO, ILL. 2d-4th Mon., Puseys Hall, 75 St and Drexel Ave.
Mrs. Rose Ptok, Pres., 9015 Houston Ave.
Mrs. Cora Kelley, Vice-Pres., 9251 Stoney Island Ave.
Mrs. O. M. Diedrich, Cor. & R. S., 7436 Evans Ave.
Mrs. Eleanor Clark, F. S. & Treas., 7539 Rhodes Ave.
Mrs. Katherine Murphy, Chaplain, 751 E 73rd St.
Mrs. Anna Callerton, C. and M., 749 E. 73rd St.

Boilermakers' Lodges by States.

Alabama.
 Birmingham . . . 4
 Mobile . . . 112
 Montgomery . . . 443
 Selma . . . 312
 Sheffield . . . 344
 Whistler . . . 511

Arizona.
 Clarksdale . . . 406
 Clifton . . . 593
 Miami . . . 187

Arkansas.
 Harrison . . . 138
 Little Rock . . . 66
 Little Rock . . . 69
 McGhee . . . 106
 Paragould . . . 599
 Pine Bluff . . . 68
 Van Buren . . . 521

Canada.
 Calgary.
 Alberta . . . 392
 Edmonton,
 Alb. . . . 279
 Ft. William,
 Ont. . . . 505
 Halifax, N. S. 580
 Hamilton,
 Ont. . . . 421
 Joliette, Que. 604
 McAdam Jct. 379
 Moncton, N.B. 378
 Montreal . . . 134
 Moose Jaw,
 Sask. . . . 478
 North Bay,
 Ont. . . . 417
 Quebec . . . 601
 Revelstoke . . 466
 Riviere du
 Loup, Que. 398
 St. Thomas,
 Ont. . . . 413
 Toronto, Ont. 548
 Transcona,
 Man. . . . 529
 Winnipeg, M. 126
 Winnipeg, M. 451

British Columbia.
 Vancouver . . . 194
 Victoria . . . 191

California.
 Los Angeles . . 92
 Oakland . . . 238
 Pt. Richmond. 317
 Sacramento . . 94
 S. Francisco . . 25
 S. Francisco . . 205
 S. Francisco . . 410
 Vallejo . . . 148

Colorado.
 Alamosa . . . 446
 Colorado . . . 136
 Denver . . . 179
 Grand Jct. . . 335
 Pueblo . . . 44
 Salida . . . 427
 Trinidad . . . 390

Connecticut.
 Hartford . . . 237
 New Haven . . . 61

Delaware.
 Dist. of Columbia
 Washington . . 450

Florida.
 High Springs. 570
 Jacksonville . . 20
 St. Augustine. 230
 Sanford . . . 422

Georgia.
 Atlanta . . . 2
 Augusta . . . 108

Cedartown . . . 510
 Columbus . . . 426
 Fitzgerald . . . 593
 Macon . . . 12
 Savannah . . . 26
 Waycross . . . 425

Idaho.
 Avery . . . 595

Illinois.
 Alton . . . 483
 Bloomington . 155
 Chicago . . . 220
 Chicago . . . 220
 Chicago . . . 227
 Chicago . . . 454
 Chicago . . . 434
 Chicago Hts. 254
 Chicago . . . 588
 Danville . . . 22
 Decatur . . . 447
 Freeport . . . 284
 Joliet . . . 93
 Kewanee . . . 195
 Moline . . . 377
 Peoria . . . 60
 Murphysboro 524
 Springfield . . 81
 E. St. Louis. 363
 Urbana . . . 150
 Villa Grove. 576

Indiana.
 Bedford . . . 541
 Evansville . . . 95
 Ft. Wayne . . . 54
 Garrett . . . 79
 Hammond . . . 358
 Indianapolis . 10
 Lafayette . . . 360
 Peru . . . 384
 Princeton . . . 324
 Terre Haute. 246
 Washington . 241

Iowa.
 Belle Plaine . . 440
 Boone . . . 161
 Cedar Rapids. 144
 Des Moines . . 47
 Dubuque . . . 15
 Marshalltown. 149
 Mo. Valley . . 145
 Sioux City . . 244
 Valley Jct. . . 491
 Waterloo . . . 133

Kansas.
 Atchison . . . 507
 Coffeyville . . 542
 Ft. Scott . . . 236
 Goodland . . . 393
 Herington . . . 340
 Hoisington . . 408
 Horton . . . 199
 Kansas City . . 83
 Neodesha . . . 418
 Osawatomie . . 82
 Parsons . . . 292
 Pittsburg . . . 221
 Pratt . . . 523
 Wichita . . . 543
 Wichita . . . 518

Kentucky.
 Covington . . . 537
 Louisville . . . 40
 Ludlow . . . 584
 Paducah . . . 137
 Somerset . . . 419

Louisiana.
 Baton Rouge. 532
 New Orleans. 37
 New Orleans. 442
 Shreveport . . 328
 Algiers . . . 206
 Monroe . . . 590

Maryland.
 Cumberland. . 332
 Cumberland . . 577
 Baltimore . . . 193
 Hagerstown . . 578

Massachusetts.
 Boston . . . 250
 Boston . . . 431
 Boston . . . 585
 Cambridge . . 515
 Greenfield . . . 517
 Lowell . . . 371
 Norwood . . . 231

Michigan.
 Bay City . . . 67
 Detroit . . . 169
 Escanaba . . . 597
 Grand Rapids 84
 Jackson . . . 64
 Marquette . . . 236
 Saginaw . . . 124

Minnesota.
 Brainerd . . . 116
 Duluth . . . 165
 Minneapolis . . 11
 St. Paul . . . 8
 Two Harbors. 437
 Winona . . . 201

Mississippi.
 McComb City. 315
 Meridan . . . 320
 Water Valley. 300

Missouri.
 Brookfield . . . 354
 Cape Girar-
 deau . . . 430
 Chaffee . . . 531
 De Soto . . . 117
 Kansas City . . 32
 Moberly . . . 267
 Monett . . . 546
 Nevada . . . 583
 Sedalia . . . 113
 Springfield . . . 70
 Springfield . . 530
 Slater . . . 536
 St. Louis . . . 27
 St. Louis . . . 276
 St. Louis . . . 322
 St. Joseph . . . 31
 Stanbury . . . 594
 Sugar Creek . . 90
 Trenton . . . 346

Montana.
 Anaconda . . . 80
 Deer Lodge . . . 528
 Glendive . . . 591
 Great Falls. . 602
 Harlowton . . . 41
 Havre . . . 367
 Livingston . . . 123
 Miles City . . . 520
 Missoula . . . 111
 Butte . . . 130

Nevada.
 Sparks . . . 339

Nebraska.
 Chadron . . . 109
 Fairbury . . . 439
 Falls City . . . 565
 Grand Island. 475
 Omaha . . . 38

New Hampshire.
 Concord . . . 245
 Portsmouth . . 467

New Jersey.
 Bayonne . . . 607
 Elizabeth . . . 176
 Hoboken . . . 163
 Jersey City . . 16

New York.
 Albany . . . 197
 Brooklyn . . . 45
 Buffalo . . . 7
 Elmira . . . 225
 Mechanics-
 ville . . . 388
 Middletown . . 400
 Norwich . . . 396
 Oneonta . . . 414
 Rochester . . . 229
 Salamanca . . . 598
 Staten Island. 200
 Troy . . . 73
 Utica . . . 223
 N. Y. City . . . 21

North Carolina.
 Raleigh . . . 173
 Rocky Mount. 239
 Salisbury . . . 226

North Dakota.
 Devils Lake. 479

Oklahoma.
 Muskogee . . . 504
 Okla. City . . . 556
 Sapulpa . . . 449
 Shawnee . . . 293
 Chickasha . . . 323
 El Reno . . . 522

Ohio.
 Bellefontaine. 243
 Canton . . . 301
 Chillicothe . . 135
 Cincinnati . . . 105
 Cleveland . . . 5
 Columbus . . . 8
 Conneaut . . . 355
 Elmwood
 Place . . . 91
 Jackson . . . 609
 Lima . . . 259
 Middleport . . . 549
 Montpelier . . . 581
 Newark . . . 99
 Portsmouth . . . 402
 Toledo . . . 85
 Van Wert . . . 409

Oregon.
 Portland . . . 72

Panama.
 Cristobal . . . 471
 Empire C. Z. 463
 Paraiso . . . 564

Pennsylvania.
 Carbondale . . 547
 Connellville . . 444
 Galeton . . . 438
 Lansford . . . 572
 New Castle. 493
 Philadelphia . . 341
 Pittsburgh . . . 154
 Pittsburgh . . . 318
 Philadelphia. 19

South Carolina.
 Charleston . . . 50
 Columbia . . . 235
 Florence . . . 424

South Dakota.
 Huron . . . 496
 Moberidge . . . 606

Tennessee.
 Bristol . . . 435
 Copperhill . . . 453
 Jackson . . . 83
 Knoxville . . . 142
 Memphis . . . 180
 Nashville . . . 42
 Chattanooga. 14

Texas.
 Amarillo . . . 331
 Beaumont . . . 587
 Big Spring . . . 423
 Childress . . . 382
 Dalhart . . . 476
 Dallas . . . 86
 Denison . . . 209
 El Paso . . . 216
 Ft. Worth . . . 96
 Galveston . . . 132
 Houston . . . 74
 Kingsville . . . 287
 Marshall . . . 100
 Mart . . . 222
 Palestine . . . 484
 Sherman . . . 458
 Port Arthur. 305
 Smithville . . . 265
 San Antonio. 345
 Teague . . . 502
 Terrell . . . 469
 Tyler . . . 486
 Waco . . . 501
 Walnut
 Springs . . . 207

Utah.
 Helper . . . 473
 Ogden . . . 198
 Salt Lake
 City . . . 103
 Tooele . . . 605

Vermont.
 Lyndonville. 481

Virginia.
 Alexandria . . . 369
 Clifton Forge. 238
 Newport News. 55
 Norfolk . . . 428
 Portsmouth . . . 298
 Portsmouth . . . 57
 Richmond . . . 170
 Roanoke . . . 30
 Roanoke . . . 29
 Victoria . . . 65

Washington.
 Bremmerton . . 290
 Everett . . . 500
 Othello . . . 603
 Spokane . . . 242
 Seattle . . . 104
 Seattle . . . 489
 Tacoma . . . 247
 Tacoma . . . 568

West Virginia.
 Bluefield . . . 405
 Elkins . . . 278
 Gassaway . . . 153
 Hinton . . . 525
 Huntington . . 249
 Keyser . . . 579
 Princeton . . . 551
 Williamston . . 557

Wisconsin.
 Butler . . . 589
 De Pere . . . 571
 Green Bay . . . 485
 Milwaukee . . . 107
 Milwaukee . . . 302
 N. Fond du
 Lac . . . 395
 S. Kaukauna. 311

Wyoming.
 Casper . . . 596
 Cheyenne . . . 46
 Evanston . . . 309
 Laramie . . . 48

By Insisting Upon Purchasing Union Stamp Shoes



You help better shoemaking conditions.
 You get better shoes for the money.
 You help your own labor position.
 You abolish child labor.

Do not be misled by retailers who say: "This shoe does not bear the union stamp, but is made under union conditions." This is false—no shoe is union made unless it bears the union stamp.

Boot and Shoe Workers' Union
 246 SUMMER STREET, BOSTON, MASS.
 JOHN F. TOBIN, President. CHAS. L. BAINE, Sec.-Treas.

THE COMMERCIAL NATIONAL BANK
 of KANSAS CITY, KANSAS.

CAPITAL AND SURPLUS, \$550,000.00. DEPOSITS.....\$5,000,000.00

We cordially invite the Boiler Makers and Ship Builders of the United States who desire to transact banking business with us (which can be done readily by mail), to write to any of their officers and ask any questions they may desire to ask about our reliability and standing.

P. W. GOEBEL, President. C. L. BROKAW, Cashier.
 A. C. FASENMYER, Vice-President. G. J. BISHOP, Asst. Cashier.

WANTED
 To know the address of
WILLIAM S. MANGAN
Important Business
 Box 426 Okmulgee, Okla.

When writing Advertisers
 please mention
THE
Boilermakers Journal

Notice to Subscribers of the Journal

When members change their address, or do not receive Journal promptly, fill out the following blank and forward to the editor:

Name Reg. No. Lodge

Old Address, Street City State

New Address, Street City State

I have not received Journal for month of

KANSAS CITY, KAS., OCTOBER, 1915.

THE BOILERMAKERS JOURNAL

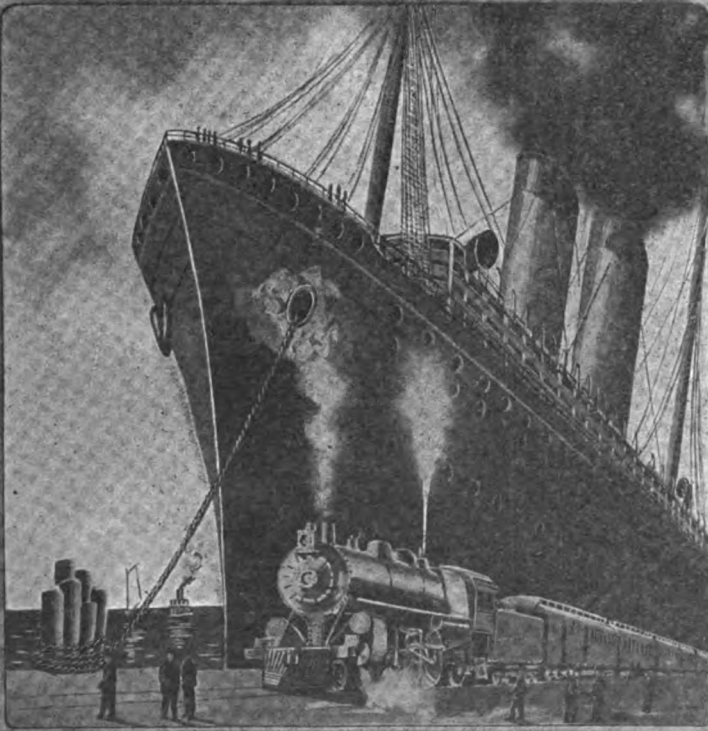

OFFICIAL ORGAN OF THE
INTERNATIONAL BROTHERHOOD
OF BOILERMAKERS, IRON SHIP BUILDERS
AND HELPERS OF AMERICA

HEADLIGHT OVERALLS

(Union Made)

*"A smile of
satisfaction
with every
pair"*

LOOK FOR THIS TICKET



*Guaranteed the best overalls
you ever bought - or MONEY BACK
after 30 days' wear.*

Larned, Carter & Co.,
Detroit, Mich.

WORLD'S GREATEST OVERALL MAKERS

Factories:- Detroit, Port Huron, Mich.,
St. Louis, Mo. Sarnia, Ont.



SECURITY SECTIONAL ARCH

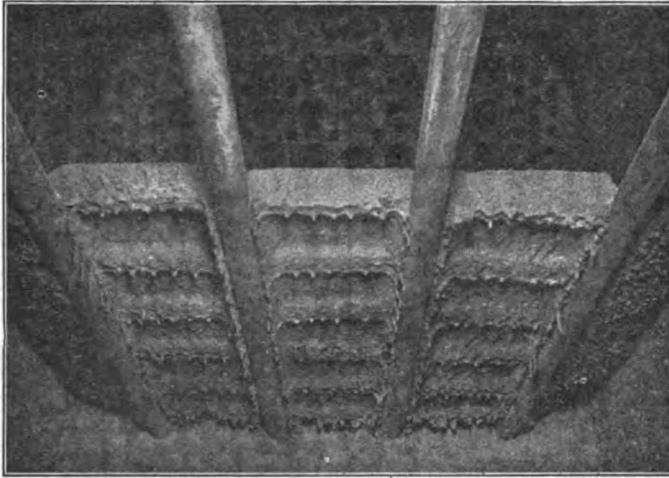

This arch is of light weight
It is built up of small sections
So made as to cool off quickly
It is easily removed for work
Made so to help the boilermaker

AMERICAN ARCH COMPANY

30 CHURCH STREET, NEW YORK

McCORMICK BUILDING, CHICAGO

ALL ABOUT BOILERMAKING

The best, most interesting and timely information about the Boiler Making Industry is published every month in the magazine — THE BOILER MAKER.

This magazine is devoted exclusively to YOUR interests and prints everything worth knowing about Boiler Designing, Building and Repairing. THE BOILER MAKER would be a big help to you in your work and keep you in touch with all the new methods and improvements.

Fill in the coupon below, mail it to us and we will send you a copy FREE.

THE BOILER MAKER
17 BATTERY PLACE NEW YORK

COUPON

The Boiler Maker,
17 Battery Place, New York City.

Gentlemen:

Please send me a copy of THE
BOILER MAKER FREE.

Name.....

Address.....

Occupation.....

Since before the Telegraph was invented

STIFEL'S Indigo Cloth

Has been the standard
cloth for

Overalls, Uniforms and Jumpers

Look for the trade mark
 on the back of the
cloth on the in-
side of the garments to be
sure you get the one and
only *Stifel's Indigo*.



It wears
like leather
and its color
is "everlasting."

*Standard for
over 75 Years.*

Cloth manufactured by

J. L. Stifel & Son

Indigo Printers and Dyers - WHEELING, W. VA.

SALES OFFICES

New York, 260-262 Church St.	Baltimore, 114 W. Fayette St.
Philadelphia . 324 Market St.	St. Louis . 425 Victoria Bldg.
Boston . 31 Bedford St.	St. Paul . 238 Endicott Bldg.
Chicago, 223 W. Jackson Bldg.	Toronto . 14 Manchester Bldg.
San Francisco	Winnipeg, 400 Hammond Bldg.
Postal Telegraph Bldg.	Montreal
St. Joseph, Mo.,	Room 500, 489 St. Paul St.
Saxton Bank Bldg.	

The Boilermakers' Journal

Official Organ of the International Brotherhood of Boilermakers Iron Ship Builders and Helpers of America

Vol. XXVII.

KANSAS CITY KAS., OCTOBER, 1915.

No. 10.

SYNOPSIS OF REPORT OF UNITED STATES COMMISSION ON INDUSTRIAL RELATIONS.

Signed by Mrs. Florence J. Harriman and John R. Commons. And with certain exceptions explained in a separate report by Harris Weinstock, S. Thruston Ballard and Richard H. Aishton.

Breakdown of Labor Laws.

The greatest cause of industrial unrest is the breakdown in the administration of labor laws and the distrust of our municipal, state and national governments on the part of a large portion of our people, according to the report signed by Professor John R. Commons and Mrs. J. Borden Harriman of the United States Commission on Industrial Relations and concurred in with some exceptions by Harris Weinstock, S. Thruston Ballard and R. H. Aishton, the employers' representatives on the Commission.

Recommendations for additional legislation would be futile, says the report, until methods are provided for making enforceable the laws now on the statute books, through the creation of administrative machinery that will be entirely removed from political influences.

To remedy the conditions criticised, the report recommends the creation of a Federal Fund for Social Welfare, maintained by an inheritance tax on large fortunes, and administered by a Commission on Industrial Relations aided by an Advisory Council composed of representatives of employers and employes.

Industrial Commission and Advisory Council.

The most important step in the creation of the Commission on Industrial Relations is the formation of the advisory council, which shall advise the Commission on all matters pertaining to the relations between labor and capital. This advisory council would, if the plan is adopted, be composed of ten persons representing the different associations of employers and farmers in the country; ten representing organized labor, and the Secretary of Commerce and the Sec-

retary of Labor to be members ex-officio. The Industrial Commission in addition to the twenty persons thus selected, may appoint ten additional members interested in social legislation and industrial education.

The members of the advisory council are to be appointed by the President from names submitted to him by the associations interested, and they shall serve without compensation other than actual expenses.

The Industrial Commission, it is recommended, shall be composed of three persons, appointed by the President and confirmed by the United States Senate. The Commission shall have full power to administer all labor laws, but shall not interfere with the duties of the Department of Labor in making investigations and recommending legislation.

While the functions of the Industrial Commission are to be solely administrative, it will have power to conduct such investigations as may be necessary to obtain correct information on subjects relating to the laws it is required to enforce. It will co-operate with state industrial commissions and minimum wage boards, with the idea of securing uniformity so far as possible.

Mediation of Industrial Disputes.

One of the most important functions of the proposed Industrial Commission would be to deal with industrial disputes between employers and employes. It would take over all the functions now exercised by the conciliation and mediation bureau of the Department of Labor and also the Mediation Board created under the Newlands Act. The provisions of the Newlands Act, now confined to railroad operation in interstate commerce, would be extended to all industry of an interstate character.

For the purpose of adjusting labor disputes the Industrial Commission is to appoint a chief mediator and such assistant mediators as may be necessary. These mediators and all other employes of the Commission are to be appointed from eligible lists, prepared after civil service examina-

tions. The advisory council is to assist in conducting such examinations, so as to guard against political influence of any kind and assure the selection of the most competent persons.

When a labor dispute arises, the chief mediator personally, or through any of his assistants, shall have power to mediate in all cases where in his judgment the interests of the public are affected. If mediation and conciliation fail, the mediator may suggest arbitration, and if both sides are agreeable he may assist them in naming an arbitration board. If arbitration is rejected and both sides agree, the mediator may assist in naming a joint board of investigation and publish the facts in the controversy. No public investigation or publication of the findings can be made by the mediator, except with the consent of both parties to the dispute.

Boycotts and Damage Suits.

On the question of boycotts and damage suits, the report indorses the provisions of the Clayton act, but in view of the doubtful constitutionality of that measure, it recommends the application of the British Trades Dispute act. The report holds that as employers now have practical immunity from punishment for maintaining blacklists, labor should have the right to institute boycotts, either primary or secondary, without being liable to prosecution.

Federal Fund for Social Welfare.

To provide funds for the maintenance of the Industrial Commission and further social welfare, without increasing taxation of the people, the report recommends an inheritance tax on large fortunes. The rate of the inheritance tax is graduated from 1 per cent on the excess of \$25,000 fortunes left to direct heirs, to 15 per cent on fortunes over \$1,000,000. The tax on estates going to distant heirs is greater.

An inheritance tax proposed would be collected by the federal government through existing machinery that collects the income tax, and a portion would be turned over to each state. The various states now collect a sum equal to about \$25,000,000 in inheritance taxes, but the rate is low in some states. By increasing the rate as proposed, it is estimated that a fund of \$200,000,000 a year would be collected, of which \$50,000,000 would be returned to the various states.

The principal of this fund it is proposed to invest in homes for workingmen, hospitals, rural credits for farmers and such other purposes of a social nature as would insure an income.

The income from the fund, which would be administered by the Industrial Commission, would be used to meet the expenses of the Commission; to promote the social well-being in the shape of establishing sickness and unemployment insurance, old age pensions, the establishments of employment offices, the promotion of industrial education through subsidies paid to the various states

and enabling tenant farmers to acquire possession of their farms.

Employment Offices.

Another recommendation in the report is the establishment of a system of national and state employment offices, under the control of the federal and state industrial commissions, co-operating with employers and labor unions. The various state employment offices would be brought under the Federal Industrial Commission, through subsidies granted them for complying with certain standards which the Commission would establish.

Industrial Education.

On matters pertaining to industrial education, the Industrial Commission would appoint on the advisory council representative educators and persons interested in the promotion of industrial education, so that in fixing standards for the payment of federal subsidies, all interests would be represented.

Immigration.

The report points out the great difficulties which the labor unions have in disciplining the foreign element in their ranks. It points out that the labor unions are the greatest Americanizing agencies in the country, and recommends very substantial restrictions in immigration, in addition to the restrictions now in effect.

In addition to the work of the trade unions in Americanizing immigrants, the report recommends the use of our public schools as social centers and commends the work already accomplished by them as a socializing influence.

As immigration is an important issue between labor and capital, the report recommends that the administration of all immigration laws be turned over to the Industrial Commission. It points out that a trade unionist, holding a political position, was compelled virtually to nullify the law pertaining to the deportation of Chinese, smuggled into the country. This would be impossible, the report says, under the advisory council proposed, whose members would not be dependent on the government for their salaries.

State Industrial Commissions.

Similar recommendations are made in the report for the creation of state industrial commissions in all states where workmen's compensation laws and minimum wage boards are in operation. Such state commissions to have power to issue rules and regulations dealing with standards of safety, sanitation and such matters, under general standards laid down by the various state legislatures. The report indorses workmen's compensation and minimum wage legislation for women and children.

Foundations.

On the question of foundations the report says that while some may warrant investigation and public exposure of methods, still in

many instances they have furnished the national and state governments with the incentive to promote education and other matters for the social welfare. It states that no legislation should be enacted that would abolish privately endowed institutions, unless a substitute is provided. It points out that the proposed Federal Fund for Social Welfare would provide the means for doing many of the things being done, or attempted by endowed foundations, and would be much more social and democratic.

To improve conditions in agricultural communities the report recommends a combination of the Irish and Australasian land laws. Under the plan proposed the government would extend credit to enable tenant farmers to become land owners, after the actual value of the land had been determined by a competent commission. The Federal Fund for Social Welfare would be partially invested in furthering this object.

Corporation Control of Politics and Labor.

On the Colorado situation the report says that a condition of feudalism exists in the mining regions, but it decries any attempt to hold responsible any single individual. It emphasizes the fact that the whole situation in Colorado, West Virginia and other places where industrial warfare has existed, is due to a system which can not be remedied by the public abuse of an individual. It recommends that corporations and labor unions alike be removed from the control of politics and says that the Industrial Commission, with its advisory council and civil service rules; the initiative, referendum and limited recall, proportional representation, direct primaries and anti-lobbying legislation would accomplish this purpose which is essential before any permanent remedy can be effected.

Collective Bargaining.

The report strongly indorses the organization of labor and the principle of collective bargaining and in recommending the application of the British Trades Dispute act urges that the workers of the country be given absolute freedom to organize and work out their own salvation.

Investigations.

In giving reasons for disregarding the reports of investigators for the Commission, the report says that its signers do not consider that the investigations were complete, as they were not submitted to all parties in interest to be checked up as to facts. It points out that the whole idea of the permanent Industrial Commission recommended and the advisory council, is that all parties interested in industrial disputes and the enforcement of labor laws are represented on the council and that it would deal in facts rather than in one-sided conclusions.

Unreliable reports and statistics, it says, are a cause of the feeling of distrust with which employers and employes now view each other, and it proposes to remedy this

condition by having all parties in interest agree on any action to be taken. The Industrial Commission which it is proposed to create can take no official action or make any official publication without first submitting it to the advisory council, with opportunity of any member of the council to publish his dissent along with the published report. This will not only insure accuracy but will remove suspicion and distrust and go far toward establishing a better understanding between employers and employes.

Police and Community Liability.

Among the other recommendations made in the report are that private detective agencies and private employment agencies doing an interstate business be regulated under license from the Industrial Commission; that rules for the conduct of the state militia be drawn up by the War Department and the advisory council of the Commission; that corporations should call upon public authorities for police protection and that local communities should be held liable in damages for the violation of constitutional rights of workers and labor organizers, as well as for failure to protect the property of employers.

Abstract of Report of Commissioners Weinstock, Aishton and Ballard.

We dissent from the recommendation that the secondary boycott should be legalized. We regard the secondary boycott as unjust, inequitable, and vicious, in that it subjects third and innocent parties to injury and, at times, to great loss, if not ruin. We are, therefore, as much opposed to it as we are to the blacklist.

We further dissent from said report in its limitations to public inquiry in labor disputes only to cases where both sides invite such inquiry.

We find that the alleged findings of fact and, in a general way, the comments thereon made in the report of the staff of this Commission, under the direction of Mr. Basil M. Manly, which has been made a part of the records of this Commission, without the indorsement, however, of the Commission, so manifestly partisan and unfair that we cannot give them our indorsement.

Despite the fact that we have been appointed to represent, on this Commission, the employers of the nation, we are free to admit that the investigations made by the Commission, and the testimony brought forth at our public hearings, have made it plain that employers, some of them, have been guilty of much wrongdoing, and have caused the workers to have their fullest grievances against many employers. There has been an abundance of testimony submitted to prove to our satisfaction that some employers have resorted to questionable methods to prevent their workers from organizing in their own self-interest; that they have attempted to defeat democracy by more or less successfully controlling courts and legislatures; that

some have resorted to all sorts of methods to prevent the enactment of remedial industrial legislation; that some have employed gunmen in strikes, who were disreputable characters, and who assaulted innocent people and committed other crimes most reprehensible in character; that some have paid lower wages than competitive conditions warranted, worked their people long hours, and under insanitary and dangerous conditions; that some have exploited prison labor at the expense of free labor; that some have been contract-breakers with labor; that some have at times attempted, through the authorities, to suppress free speech and the right of peaceful assembly, and that some have deliberately, for selfish ends, bribed representatives of labor. All these things, we find, tend to produce industrial unrest, with all its consequent and far-reaching ills.

There is, therefore, no gainsaying the fact that labor has had many grievances, and that it is thoroughly justified in organizing and in spreading organization in order better to protect itself against exploitation and oppression.

On the other hand, in justice to employers generally, it must be said that there has been much evidence to show that there is an awakening among the enlightened employers of the nation, who have taken a deeper personal interest in the welfare of their workers than ever before in industrial history; that such enlightened employers are growing in number and are more and more realizing that, if for no other reason, it is in their own self-interest to seek the welfare of their workers, and earnestly to strive to better their conditions. Employers, on their own initiative, have created sick funds and pension funds; have expended vast sums of money to insure greater safety to their workers; have, as compared with conditions of the past, greatly improved their methods of sanitation, have done much to regularize employment; have increased wages, and in every way have endeavored to lighten the burdens of their workers.

Organized labor points out that there are many employers' associations that are organized not to deal with, but to fight, unionism, and that this, in many instances, and more especially in the larger industrial enterprises, presents a very serious obstacle for organized labor to meet and to overcome.

Representing as we do, on this Commission, the employers' side, we are at one with the other members of our Federal Commission who represent the general public, and also with those representing organized labor, in believing that under modern industrial conditions, collective bargaining, when fairly and properly conducted, is conducive to the best good of the employer, the worker and society. We find that there are many enlightened employers who concur in this

view, who in the past recognized and dealt with organized labor, but who now refuse to do so, and who, under proper conditions, would willingly continue to engage in collective bargaining. With good cause, in our opinion, they place the responsibility for their refusing to do so at the door of organized labor. There is an abundance of available testimony in our records to show that many employers are frightened off from recognizing or dealing with organized labor for fear that to do so means to put their heads in the noose and to invite the probability of seriously injuring, if not ruining, their business.

The prime objections that such employers have to recognizing and dealing with organized labor is the fear of:

- (a) Sympathetic strikes.
- (b) Jurisdictional disputes.
- (c) Labor union politics.
- (d) Contract breaking.
- (e) Restriction of output.
- (f) Prohibition of the use of non-union made tools and materials.
- (g) Closed shop.
- (h) Contest for supremacy between rival unions.
- (i) Acts of violence against non-union workers and the properties of employers.
- (j) Apprenticeship rules.

The employer contends, and we find ourselves in sympathy with his contention, that it is a rank injustice to subject him to a strike of his employes who have absolutely no grievance, to stop work because some other group of workers, possibly at a remote point, have a real or fancied grievance against their own employer, especially when such stoppage of work may not only inflict a very serious loss, but may mean ruin to the enterprise of the innocent employer, thus making it, in violation of all the equities, a clear case of punishing the many innocent for the one or the few who may be guilty, who were party to the original dispute.

The employer further points out that not only is his business liable to be ruined by the sympathetic strike, but more especially in the building trades, is he likely to become an innocent victim of jurisdictional disputes for which he is in no wise responsible, and over which he has absolutely no control.

Labor Union Politics.

The third objection of employers to recognizing and dealing with organized labor is the risk they run, especially in the building trades, where power to declare a strike is concentrated in the hands of a business agent, of finding themselves at the mercy of either a corrupt business agent, or one who, for the sake of union politics, is endeavoring, in order to perpetuate himself in office, to make capital at the expense of

the innocent employer by making unwarranted and unreasonable demands against the employer.

Contract Breaking.

The fourth reason offered by the employers for refusing to recognize or to deal with organized labor, is its increasing unreliability in keeping trade agreements.

Restriction of Output.

Not least among the reasons given by fair-minded employers for refusing to recognize or deal with labor unions, is the fact that many unions stand for a limited output, thus making among their workers for the dead level, and thereby making it impossible for the union employer successfully to compete with the non-union employer, who is not faced with such handicap.

Prohibition of Use of Non-Union Made Tools and Materials.

The sixth reason offered by employers for refusing to recognize or to deal with organized labor, is that when they do so they are often not permitted to use non-union made tools or materials, thus placing upon themselves a burden and a hardship from which non-union employers are free, and thus also laying themselves liable to get into all sorts of controversies with the union, which are vexatious, annoying, time-losing, and, frequently, most costly, as they sometimes lead to grave and serious strikes.

Closed Shop.

The seventh reason why many employers refuse to recognize or to deal with organized labor (and among these may be mentioned the employers of large bodies of workers who have previously had trade agreements with organized labor), is the matter of the closed shop.

It may be held that unionists working under an open shop agreement or understanding, always reserve to themselves the right, for any reason or for no reason, to cease to work alongside of non-union men, and that they further reserve the right to determine the psychological moment at which it is in their interest to cease work or to go on a strike because they will not work alongside of non-union men. It is the fear of the likelihood of their doing this that frightens off many employers from recognizing or dealing with organized labor. They feel that even when they are operating under an open shop agreement or understanding, which does not deny them the right to employ non-union men so long as they work under union conditions, that they are working with a sword suspended over their heads by a slender thread, which may break at any moment, and that they are liable to have a strike on their hands at the most critical time, which may spell ruin for their business. Employers, as a

rule, do not deem it a good business policy to invite such risks.

Contests for Supremacy Between Rival Unions.

Testimony has been given before this Commission indicating, in more than one instance, that contests between rival unions or factions of the same union, have led to strikes causing industrial unrest from which the worker as well as the employer, has suffered harm and loss.

Acts of Violence Against Non-Union Workers and the Properties of the Employer.

The ninth objection raised on the part of employers against unionism, which has been substantiated abundantly by investigation and by testimony taken by the Commission, is the resort on the part of unionists to violence in labor troubles, and to the fact that unionists condone such violence when committed in the alleged interest of labor.

The most notable case, of course, in modern industrial history, is that of the Structural Iron Workers, which resulted in the plea of guilty on the part of the McNamara brothers, for the blowing up of the Los Angeles Times building, killing over twenty innocent people, and which further resulted in Frank Ryan, the President of the Structural Iron Workers' National Union, and a group of other labor union officials, being convicted and sentenced to prison.

In conclusion, it is our desire to point out that organized labor is chargeable with its fullest share of creating causes of industrial unrest, because of its sympathetic strikes, its jurisdictional disputes, its labor union politics, its contract breaking, its resort to violence in time of trouble, its policy of limited output, and its closed shop policy.

These various policies have brought about their fullest share among the workers, to say nothing of the injury inflicted on employers and on society, of poverty, suffering, wretchedness, misery, discontent, and crime. Organized labor will never come into its own, and will indefinitely postpone the day when its many commendable objects will be achieved in the broadest sense, until it will cut out of its program sympathetic strikes, until it can prevent cessation of work in jurisdictional disputes, until it can more successfully prevent labor union politics, until it can teach many in its rank and file to regard more sacredly their trade agreements, until it can penalize its members for resorting to violence in labor disputes, and can make it a labor union offense to limit output.

If these evils are eliminated by organized labor from its program, much will have been done to stimulate collective bargaining and to minimize the existing causes of industrial unrest. The remedies for all these evils do not lie with the employer; they rest wholly and solely with unionists. The responsibility for the growth of these evils, in

our opinion, rests primarily with unionists who neglect their union duties, and who are as unmindful of their duties as union men, as are many voters of their civic duty who remain at home on election day.

We say frankly that if we were wage earners we would be unionists, and as unionists we would feel the keen responsibility of giving the same attention to our trade union duties as to our civic duties.

The ideal day in the industrial world will be reached when all labor disputes will be settled as a result of reason, and not as a result of force. This ideal day can be hastened if the employers, on the one hand, will earnestly strive to place themselves in the position of the worker, and look at the conditions not only through the eye of the employer, but also through the eye of the worker; and if the worker will strive to place himself in the position of the employer, and look at the conditions not only through the eye of the worker, but also through the eye of the employer.

This, of course, means the strongest kind of organization on both sides. It means that employers must drive out of the ranks of their associations the law breaker, the labor contract breaker, and the exploiters of labor. It also means that, in the interest of fairness, every Board of Directors of an industrial enterprise should have within its organization a committee for the special purpose of keeping the Board of Directors advised as to the condition of their workers. And it finally means that trade unions must, in order to minimize the causes of industrial unrest, among other things remove the weak spots in unionism set forth herein, thereby hastening the day when employers will not longer fear to recognize and deal with unions, and when collective bargaining shall thus become the common condition.

Press abstract of second section of report of Basil M. Manly, director of research and investigation, containing findings of fact and recommendations of the staff.

Report in full accepted and ordered printed by resolution of Commission. Adopted by Commissioners Frank P. Walsh, John B. Lennon, James O'Connell and Austin B. Garretson.

Also full copy of supplemental findings and recommendations by Commissioners John B. Lennon and James O'Connell.

For the convenience of editors the following summary of recommendations contained in the second section of this report has been prepared by the Commission:

The second section of the final report of Director Basil M. Manly, embodying the findings of fact and conclusions of the staff of the United States Commission on Industrial Relations, was made public by the Commission today.

Its principal feature is a vivid portrayal of living and working conditions that prevail

in American industry today. Evidence is presented at great length in support of the report's findings to the effect that industrial unrest is caused by the payment of wages too low to provide a decent standard of living, and in support of the report's further conclusion that this situation is a direct result of the lack of strong labor organizations by which wage earners could force the payment of living wages.

The section made public today also recommends many remedial measures.

Among the recommendations is a strong argument urging equal political rights for women as one of the means by which women in industry may obtain living wages.

Other parts of the report deal with women and children in industry, with conditions of employment in the telephone service, the telegraph service, the Pullman Company, and the railroads.

One of the most striking findings presented today concerns the existence of many typical industrial communities that are declared to present every aspect of a state of feudalism, with employers controlling the social and political life and abridging the fundamental rights of citizens.

Past Conditions No Criterion.

Discussing the question of whether or not labor conditions in the country's principal industries are satisfactory, the report repudiates the view that these conditions should be judged by comparison with the past. It asserts that conditions should be judged "only by comparing conditions as they actually exist with what knowledge and experience show that they might easily be made during the immediate future, if proper action were taken to utilize the resources of our nation sufficiently and distribute the products equitably."

"The crux of the question," says the report, "is: Have the workers received a fair share of the enormous increase in wealth which has taken place in this country during the past quarter century as a result largely of their labors? The answer is emphatically—No!

"The wealth of the country between 1890 and 1912 increased from 65 to 187 billions, or 188 per cent, whereas the aggregate income of wage earners in manufacturing, mining and transportation has risen between 1889 and 1909 only 95 per cent, from 2,516 millions in 1889 to 4,916 millions in 1909. Furthermore, the wage earners' share of the net product of industry in the case of manufacturers was only 40.2 per cent in 1909, as compared with 44.9 per cent in 1889.

Foreign Conditions Not Pertinent.

"Similarly, the attempt to dismiss deplorable labor conditions in the United States by arguments that they are better than in

European countries is repugnant. To say that conditions are better than in Great Britain, for example, is simply to say that somewhat less than one-third of the population are in a state of absolute poverty, for that was the condition reported by the last British Commission. It should be a matter of shame also to boast that the condition of American laborers is better than that of laborers in the 'black bread belt' of Germany.

"That they are, as a matter of fact, but little better is proved conclusively by the almost complete cessation of immigration from Germany, England and France. No better proof of miserable condition of the mass of American workers can be sought than the fact that in recent years laborers in large numbers have come to this country only from Russia, Italy, Austria-Hungary and the backward and impoverished nations of Southern and Eastern Europe.

"With the inexhaustible natural resources of the United States, her tremendous mechanical achievements, and the genius of her people for organization and industry, there can be no natural reason to prevent every able bodied man of our present population from being well fed, well housed, comfortably clothed, and from rearing a family of moderate size in comfort, health and security. How far this ideal is actually achieved is discussed in some detail in the following pages.

"It is evident both from the investigations of this Commission and from the reports of all recent governmental bodies that a large part of our industrial population are, as a result of the combination of low wages and unemployment, living in a condition of actual poverty."

At Least One-third in Poverty.

How large this proportion is cannot be exactly determined, but it is certain that at least one-third and possibly one-half of the families of wage earners employed in manufacturing and mining earn in the course of the year less than enough to support them in anything like a comfortable and decent condition. The detailed evidence is presented in a separate report which is submitted for transmittal to Congress. At this point it is sufficient to call attention to the results of the most exhaustive and sweeping official investigation of recent years, that of the Immigration Commission, which reported to Congress in 1909. This investigation secured detailed information regarding the daily or weekly earnings of 619,595 employes of all classes in our basic manufacturing industries and in coal mining, and information regarding income and living conditions for 15,726 families.

"It was found that the annual incomes of almost two-thirds of these families (64 per cent) were less than \$750 per year and for almost one-third (31 per cent) were less

than \$500, the average for all being \$721. The average size of these families was 5.6 members. Elaborate studies of the cost of living made in all parts of the country at the same time have shown that the very least that a family of five persons can live upon in anything approaching decency is \$700. It is probable that owing to the fact that the families investigated by the Immigration Commission were, to a large extent, foreign born, the incomes are lower than for the average of the entire working population; nevertheless, even when every allowance is made for that fact, the figures show conclusively that between one-half and two-thirds of these families were living below the standards of decent subsistence, while about one-third were living in a state which can be described only as abject poverty.

"American society was founded and for a long period existed upon the theory that the family should derive its support from the earnings of the fathers. How far we have departed from this condition is shown by the fact that 78 per cent of the fathers of these families earned less than \$700 per year. In brief, only one-fourth of these fathers could have supported their families on the barest subsistence level without the earnings of other members of the family or income from outside sources.

"Other facts collected in this investigation show conclusively that a very large proportion of these families did not live in decency and comfort. Thirty per cent kept boarders and lodgers, a condition repugnant to every ideal of American family life, especially in the crowded tenements or tiny cottages in which the wage earners of America characteristically live. Furthermore, in 77 per cent of the families two or more persons occupied each sleeping room, in 37 per cent three or more persons, and in 15 per cent 4 or more persons."

Pauper Burials.

"The most striking evidence of poverty is the proportion of pauper burials. The repugnance of all classes of wage earners of all races to pauper burial is such that everything will be sacrificed and heavy debts incurred rather than permit any member of the family to lie in the 'potters' field'; nevertheless, in New York City one out of every twelve corpses is buried at the expense of the city or turned over to physicians for dissection.

"The terrible effects of such poverty may be outlined in a few paragraphs, but their far-reaching consequences could not be adequately shown in a volume.

"Children are the basis of the state; as they live or die, as they thrive or are ill-nourished, as they are intelligent or ignorant, so fares the state. How do the children of American workers fare?

"It has been proved by studies here and abroad that there is a direct relation between poverty and the death rate of babies; but the frightful rate at which poverty kills was not known, at least for this country, until last year, when through a study made by the Federal Children's Bureau in Johnstown, Pa., it was shown that the babies whose fathers earned less than \$10 per week died during the first year at the appalling rate of 256 per 1,000. On the other hand, those whose fathers earned \$25 per week or more died at the rate of only 84 per 1,000. The babies of the poor died three times as fast as those who were in fairly well-to-do families. The tremendous significance of these figures will be appreciated when it is known that one-third of all the adult workmen reported by the Immigration Commission earned less than \$10 per week. On the showing of Johnstown these workmen may expect one out of four of their babies to die during the first year of life."

Children Go Hungry.

"The last of the family to go hungry are the children, yet statistics show that in six of our largest cities from 12 to 20 per cent of the children are noticeably underfed and ill-nourished.

"The minimum amount of education which any child should receive is certainly the grammar school course, yet statistics show that only one-third of the children in our public schools complete the grammar school course, and only 10 per cent finish high school. Those who leave are almost entirely the children of the workers, who, as soon as they reach working age, are thrown, immature, ill-trained and with no practical knowledge, into the complexities of industrial life. In four industrial towns studied by the Bureau of Labor Statistics 75 per cent of the children quit school before reaching the seventh grade.

"The great seriousness of this condition is even more acutely realized when it is known that in the families of the workers 37 per cent of the mothers are at work and consequently unable to give the children more than scant attention. Of these mothers 30 per cent keep boarders and lodgers and 7 per cent work outside the home.

"As a picture of American industry, this presentation is undeniably gloomy and depressing, but as a diagnosis of what is wrong with American labor conditions it is true and exact. There are of course many bright spots in American industry, where workmen are well paid and regularly employed under good working conditions in the determination of which they have some share. But, even as the physician pays little attention to the good eyes and sound teeth of a patient whose vital organs are diseased, so impressive is the need for attention to the diseased spots in industry, it is felt unnecessary to waste time in word pictures

of conditions which are all right or which may be depended upon to right themselves."

Farm Workers Also.

"In agriculture, there is no array of exact figures which can be quoted to show the condition of labor. But, speaking generally, the available evidence indicates clearly that while in some sections agricultural laborers are well paid and fairly treated, the condition of the mass is very much like that of the industrial workers.

"Moreover, there is a peculiar condition in agriculture, which merits a brief but strong statement at this point as a preface to a more detailed discussion later. The most alarming fact in American agriculture is the rapid growth of tenancy. In 1910 there were 37 tenant-operated farms out of each 100 farms in the United States as compared with 28 in 1890, an increase of 32 per cent during 20 years. No nation-wide investigation of the condition of tenant farmers has ever been made, but in Texas where the investigations of this Commission were thorough and conclusive, it was found not only that the economic condition of the tenant was extremely bad, but also that he was far from being free, whereas his future was regarded as hopeless. Badly housed, ill-nourished, uneducated, and hopeless, these tenants continue year after year to eke out a bare living, moving frequently from one farm to another in the hope that something will turn up.

"Without a large family, the tenant cannot hope to succeed or break even, so in each tenant family numerous children are being reared to a future which under present conditions will be no better, if as good, as that of their parents. The wife of a typical tenant farmer, the mother of eleven children, stated in her testimony before the Commission that in addition to the rearing of children and the work of the house, she always helped with the crops, and during all the years of her married life she had had no ready-made dresses and only three hats.

"The investigations of this Commission in that rich and generally prosperous section of the country only confirm and accentuate the statements of the Federal Industrial Commission which reported in 1902: 'The result of this system (share tenancy) is that the renters rarely ever succeed in laying by a surplus. On the contrary, their experiences are so discouraging that they seldom remain on the same farm for more than a year. They are not only unable to lay by any money, but their children remain uneducated and half clothed. The system is apparently one of the most undesirable, so far as its effect on the community is concerned.'"

Corporations and Wage Earners.

Discussing existing relations between em-

ployers and employes, the report points out that the typical form of industrial organization is the corporation.

"In transportation," says Mr. Manly, "approximately 100 per cent of the wage earners are employed by corporations; in mining, 90 per cent, and in manufacturing, 75 per cent. Moreover, it is under this form that the great problems of industrial relations have developed."

After analyzing the elements that go to make up a typical corporation Mr. Manly says:

"The ordinary stockholder in a large corporation actually occupies a less direct relationship to the corporation in which he is interested, has less knowledge of its actual operations, and less control over its management than the ordinary citizen has over local, state and national governments.

"Boards of directors in theory are responsible for and would naturally be expected to maintain supervision over every phase of the corporation's management, but, as a matter of fact, we know that such supervision is maintained only over the financial phase of the business, controlling the acquisition of money to operate the business, and distributing the profits. Actual direction generally exists only through the removal of executive officials who fail to deliver the expected profits, and through the appointment of their successors.

"Upon the testimony of financiers representing, as directors, hundreds of corporations, the typical director of large corporations is not only totally ignorant of the actual operation of such corporations, whose properties he seldom, if ever, visits, but feels and exercises no responsibility for anything beyond the financial condition and the selection of executive officials. Upon their own statements, these directors know nothing and care nothing about the quality of the product, the condition and treatment of the workers from whose labor they derive their income, or the general management of the business.

"So far as operation and actual management are concerned, the executive officials are practically supreme. Upon their orders production is increased or decreased, plants are operated or shut down, and upon their recommendations wages are raised or lowered. But even they have little direct contact with the actual establishment of working conditions, and no relation at all with the rank and file of the workers. They act upon the recommendations of superintendents, whose information comes from their assistants and foremen and from the elaborate statistics of modern business, which account for every piece of material and product, show the disposition of every penny that comes and goes, but ignore, as though they did not exist, the men and women

whose labor drives the whole mechanism of business."

The Big Question.

"Here, then, is the field of industrial relations: Masses of workers on the one side dealing in some manner with foremen and superintendents on the other, behind whom is an organization of executive officials, representing in turn the board of directors, who are chosen representatives of the stockholders.

"The crux of the whole question of industrial relations is: Shall the workers for the protection of their interests be organized and represented collectively by their chosen delegates, even as the stockholders are represented by their directors and by the various grades of executive officials and bosses?

"In considering this issue the first question that presents itself is: Why should such representation be demanded as a necessity? The executive officials, superintendents and bosses, some witnesses have urged before the Commission, are not only for the most part humane and well-intentioned men, but they know that the interests of the business depend upon the welfare of the workers, and, if unhindered, will pay the best wages and create the best working conditions that the business can afford. Organization and representation are therefore argued to be unnecessary and tending only to promote friction and interfere with the management of the business.

"Let us grant the higher character and good intentions of officials, and consider the statement of the workers in reply. They say that in modern corporate business the actions of officials are governed not by their personal intentions, but by the inexorable demands for interest and dividends, and are driven not by their desire to create a permanently successful business with a contented labor force, but by the never-relaxed spur of the comparative cost-sheet.

Managers Cannot Effect Reforms.

"The constant demand is for high production at low cost, not through improvements and good conditions which might give them next year, but this very month. In the high pressure of business, every superintendent knows that if his plant is at the bottom of the comparative scale for two months his position topples, and, if for three months, it is virtually gone. He cannot afford to experiment with changes that will not give immediate results. If he were his own master he might take a chance, knowing that the loss of this year would be compensated by gains under better conditions next year, but the monthly cost-sheet does not wait for next year; it demands results now.

"But it may be said that, if he cannot improve conditions himself, he can at least

recommend them to his superiors to be transmitted to the board of directors for approval. This might indeed be done, and with the extension of an understanding among managers that low production costs may be secured with high wages, probably would be to an increasing extent, except that boards of directors scorn such abstractions as the high-wage-low-cost theory, and habitually insist that managers shall buy labor, as they buy material, in the cheapest market.

As to Directors.

"Moreover, raising wages is traditionally unpopular among stockholders and directors, and recommendations for better conditions, particularly if they involve new capital, are frowned upon. Neither the stockholders nor the directors have to live on wages or work in the existing surroundings, and profits deferred are considered profits lost.

"The workers, therefore, deny the potency of even good intentions on the part of managers, and point to labor history which they allege shows that at best only isolated cases can be pointed out where marked improvements have taken place except in response to repeated demands from the workers, or to forestall the growth of threatened organization. They point also to such facts as that children of 12 years or younger were not only kept in the factories (as they still are in some states where there has been little aggressive agitation), but almost without exception they were insisted upon by the employers as a necessity.

Organization Required.

"The evidence of this character, which is summarized elsewhere, seems to be conclusive of the necessity for organization and representation under modern business conditions. But even if it were not necessary, it is difficult to see any reason why what is demanded and required by stockholders should be denied to workers. It would be as illogical for stockholders individually to attempt to deal with the representatives of the unions, as it is for the individual worker to attempt to deal with executive officials, representing the organized stockholders."

Conclusions and recommendations relating to living and working conditions of labor are stated as follows:

Wages.

"As a result of the investigations which have been made the following conclusions are justified:

1. The welfare of the state demands that the useful labor of every able-bodied workman should as a minimum be compensated by sufficient income to support in comfort

himself, a wife, and at least three minor children, and in addition to provide for sickness, old age and disability. Under no other conditions can a strong, contented and efficient citizenship be developed.

2. Under existing conditions such an income is not received by fully one-half of the wage earners employed in industry.

3. The natural resources of the United States are such that an industrial population properly educated and efficiently organized can produce enough to achieve this standard of living.

4. It is probable that even at present the national agricultural and industrial output is sufficient to permit the establishment of such a standard.

5. The problem is therefore essentially one of distribution.

6. The fixing of the wages of adult workmen by legal enactment is not practicable nor desirable as a general policy, except for public employes.

7. A just standard of wages in any industry or occupation can best be reached by collective bargaining between employers and employes for the purpose of forming voluntary joint agreements. The success and justice of such joint agreements is, however, dependent upon the essential equality of the two parties and cannot be attained unless effective organization exists.

"It is suggested that the Commission make the following recommendations:

1. In order that the public may be kept fully informed with regard to labor conditions, and that a proper basis of facts should exist for negotiation and arbitration, the federal government should enact the necessary legislation to provide for the collection, through the Bureau of Labor Statistics or otherwise, of the full and exact facts regarding wages, hours of labor, and extent of unemployment for every industry. Every employer should be required by law to file with the proper authority a sworn statement of these facts according to a prescribed form. These statistics should be published annually, and the full data regarding any industry or plant should be accessible to any mediator or any other responsible citizen.

2. Uniform statutes should be passed by the legislatures of all states requiring that wages be paid at least semi-monthly and in cash, except where by joint agreement other methods are agreed upon."

Hours of Labor.

"As a result of investigation the following conclusions are justified:

1. The physical well-being, mental development and recreational needs of every

class of population demand that under normal circumstances the working day should not exceed eight hours.

2. A very large percentage of the workmen in manufactures, transportation and mining work more than eight hours per day.

3. This is in marked contrast to the condition of those whose economic position enables them to define the length of their own working days.

4. Practical experience has shown that the reduction of working hours is in the interest not only of the worker and the community generally, but of the employer.

5. The regulation by legal enactment of working hours of adult workmen is not generally practicable nor desirable, except for public employes.

It is suggested that the Commission recommend:

1. That in the so-called continuous occupations, other than the movement of trains, requiring work during both the day and the night for six or seven days per week, the state and federal governments should directly intervene, so that the working hours should not exceed eight per day nor extend to more than six days per week."

Safety and Sanitation.

"The investigations which have been made warrant the following conclusions:

1. Great progress has been made during recent years in promoting safety and sanitation in manufacturing, mining and transportation.

2. The progress has been most rapid in direction of safeguarding workers from industrial accidents.

3. Progress in safety has been in part the result of continued agitation and education, but has proceeded most rapidly and satisfactorily since the enactment of workmen's compensation laws which render unsafe working conditions expensive to the employer.

4. The movement has also been largely promoted by the formation of safety committees composed of officials and workmen, and by the creation of joint conferences of employers and employes to assist and advise state officials in the administration of the law and in the formulation of safety rules.

5. The campaign for safety needs, however, to be greatly extended as rapidly as possible. The annual list of accidents, approximately 35,000 fatalities and 700,000 injuries involving disability of over four weeks, can not be regarded complacently. From one-third to one-half of these accidents have been estimated by competent authorities to be preventable by proper safeguards, inspection and control.

6. The advance in the sanitation of work shops has been less rapid, because not only are the dangers less obvious, but there is no financial liability for disease or deaths occurring as the result of improper sanitation. Future progress in sanitation demands attention not only to cleanliness and ventilation, but to occupational diseases.

7. The most direct incentive for the promotion of sanitation would be the adoption of a proper system of sickness insurance.

It is suggested that the Commission recommend:

1. The creation of a bureau of industrial safety (except that the section providing a museum of safety is not indorsed). Proper steps should be taken to provide for the co-ordination of the work of all federal bureaus whose work is concerned with industrial safety.

2. The appropriations of the public health service for the investigation and promotion of industrial sanitation should be increased."

Housing.

"It has been found in the course of the Commission's investigations:

1. The present provisions for the housing of workmen are generally bad, not only in the large cities, but in industrial communities of every size and in rural districts.

2. Not only are the houses and tenements which are available for workers largely insanitary and unfit for habitation, but they are inadequate, resulting in high rents, overcrowding and congestion.

3. Such conditions make not only for discomfort and unhappiness, but for disease and degeneration.

4. The ordinary method of supplying houses through their erection by private capitalists for investment and speculation has rarely if ever been adequate.

5. Excellent plans for the housing of workmen have been put into effect by a number of firms and corporations, but such measures have not at all affected the general situation, and being dependent upon the volition of individuals can not be regarded as likely to greatly influence progress.

6. The tenement-house acts, as well as the health ordinances and building regulations of municipalities, while generally productive of good effects, are at best surface remedies and can never cure the evils of the present housing situation.

7. In every important European country government aid and direct intervention to curb speculation have proved to be necessary for the promotion of any real progress.

8. Governmental action in Europe has chiefly taken the following forms:

a. Extension of credit to voluntary non-profit-making associations.

b. Construction by the Government of buildings which are leased for long periods on easy terms.

c. Exemption from taxation and other subsidies for homes constructed for occupancy by their owners.

d. Legislation designed to prevent the holding of land out of use and to secure for the government a part of the "unearned increment."

It is suggested that the Commission recommend:

1. The Federal and State Governments should institute investigations directed not so much to ascertaining existing housing conditions, as to formulating constructive methods by which direct support and encouragement to the promotion of improved housing can be given. Actual experiment in the promotion of housing should proceed as rapidly as proper plans can be drafted.

2. Special attention should be given to taxation, in order that land should as far as possible be forced into use and the burden of taxation be removed from home owners.

3. The municipalities should be relieved from all state restrictions which now prevent them from undertaking the operation of adequate housing schemes and from engaging in other necessary municipal enterprises."

Women and Children in Industry.

"The investigations and hearings of the Commission justify the conclusions:

1. As a result of their unprotected condition, women and children are exploited in industry, trade, domestic service, and agriculture, to an extent which threatens their health and welfare and menaces the well-being of future generations.

2. The competition of women and children is a direct menace to the wage and salary standards of men.

3. Under present conditions, children are permitted by their parents to go to work largely because their earnings are necessary for the support of the rest of the family. The restrictive legislation of the past quarter-century, although admirable in purpose and ultimate results, has thrown a heavy burden upon their fathers and mothers, who, at existing wages, have been barely able to support their families. The evidence shows that the burden of child labor legislation has rested upon the wage earners rather than upon the employers. It is the testimony of enlightened employers that the employment of children is unprofitable, and that the effect of excluding children from factories has been to increase rather than decrease profits. In the interests of society as a whole, further restrictions on the employment of immature children are neces-

sary, but it is important that they should be made with an understanding that the burden will rest primarily upon the wage earners, whose self-sacrifice should be fully recognized.

4. The increasing employment of women has been due to two primary causes: First, the low wages of men, which have made the earnings of women necessary for the support of the family, and, second, the inducement to employers to substitute women for men because they will accept lower wages and are less likely to protest against conditions. The substitution of women for men has been greatly assisted by the introduction of improved machinery, which makes strength and technical skill unnecessary.

5. The increased employment of women, under present working conditions, is a serious menace to their own health and well-being, to the wages of their husbands and brothers, and to the ideals of family life upon which American civilization has been established.

6. The conditions under which women are employed in domestic service and in agriculture, merit the attention of the Nation no less than does their employment in manufacturing and trade. Not only is the economic condition of women employed in agriculture and domestic service a matter of grave concern, but they are subject to overwork, unreasonable hours, and personal abuse of various kinds, from which they have been largely relieved in factories and stores through agitation and legislation.

7. The position of women in industry has been rendered doubly hard by reason of their lack of training for industrial work, by the oversupply of such labor and the consequent competition, by their traditional position of their dependence and by their disfranchisement.

8. A very thorough investigation in the New England states failed to show a single manufacturer who had left a state as a result of restrictive factory legislation. On the contrary, the majority of manufacturers expressed the opinion that the legislation regulating conditions for women and children had been advantageous to the industry as a whole, particularly because it placed all competitors upon the same footing. Similarly, an investigation of the effects of minimum-wage legislation failed to show any calculable effects upon the cost of production, or upon the employment of women, after a sufficient period had elapsed to allow the necessary readjustments to be made.

9. Nevertheless, there is a strong and increasing demand on the part of manufacturers in the most progressive states that regulation of factory conditions should be undertaken by the federal government, in order that competitors in all parts of the country should be placed upon an equal footing in this respect. The same demand comes

also from the representatives of labor,⁶ not only because the argument of "interstate competition" is creating strong opposition to progressive legislation, but because of the great economy of effort which would result from having to make the fight for better legislation only at the National Capital instead of in 45 states."

"It is suggested that the Commission recommend:

1. The recognition both by public opinion and in such legislation as may be enacted, of the principle that women should receive the same compensation as men for the same service.

2. Until this principle is recognized, and women are accorded equal political rights, the extension of state protection of women through legislation regulating working conditions, hours of service, and minimum wages, is highly desirable.

3. The increased organization of working women for self-protection and the improvement of their industrial conditions.

4. The inclusion of all women working for wages, whether in industry, trade, domestic service, or agriculture, under future legislation regulating their wages, hours, or working conditions.

5. The extension of the principle of state protection of children and the rapid increase of facilities for their education as outlined elsewhere.

6. The enactment by Congress of legislation embodying the principles contained in the so-called Palmer-Owen bill, which was before Congress at the last session."

Public Utilities.

The report discusses conditions of employment in the two principal telegraph companies, in the telephone service, in the service of the Pullman Company and on the railroads. It says:

"The investigations of the Commission show:

1. The scope of the Newlands Act, which applies only to employes engaged in the operation of interstate railroads, is too narrow and leaves the public service in the transmission of intelligence and in the handling of interstate commerce likely to be interrupted by labor disputes without any adequate legal provision either for mediation and conciliation or for making the facts involved in the dispute known to the public.

2. Even as applied to train service employes, the Newlands Act provides no means of bringing the facts before the public, except when both sides agree to arbitration.

3. The selection of impartial members of arbitration boards has almost without exception devolved upon the Board of Mediation and Conciliation, owing to the inability of the parties to agree. This not only imposes an unpleasant and burdensome task upon the Board of Mediation and Conciliation, but tends greatly to weaken its influence. The experience in Great Britain shows that agreement can be reached by joint conference of employers and employes during a period of industrial peace for the selection of a panel of impartial persons from which arbitrators can be selected when they are needed, and seems to indicate that in the United States the inability of the parties to agree upon impartial arbitrators is due in part at least to the fact that they are always selected during the heat of the conflict.

"It is suggested that the Commission recommend:

1. The extension of the Newlands Act to cover not only all classes of railroad employes, but all employes of public service corporations which are engaged in interstate commerce.

2. The functions of the Board of Mediation and Conciliation under the Newlands Act should be extended to provide for the creation of Boards of Investigation, to be formed only by consent of both parties and to make a report of facts and recommendations which will not be binding upon either side.

3. The Board of Mediation and Conciliation should be authorized by Congress to create an advisory council, composed of equal numbers of employers and employes, for the purpose of creating a panel of names from which impartial arbitrators may be chosen by the Board of Mediation and Conciliation."

Telegraph.

"The investigations and hearings of the Commission justify the following conclusions:

1. The workers employed by the two principal telegraph companies (the Western Union Telegraph and the Postal Telegraph-Cable), are not only underpaid, as admitted by the highest officials in their testimony before the Commission,⁷ but subject to many abuses, such as the denial of proper periods of relief while on duty, the establishment of arbitrary speed rates, which frequently result in overstrain, the arbitrary discharge of employes without notice for any cause or no cause, the employment of young boys for messenger service under conditions which result only in their moral corruption, and the employment of women for telegraph service at night.

⁶Mr. Newcomb Carlton, president of the Western Union Telegraph Company, testified as follows:

"I do not cite any of these things as a substitute for wages, because there is no substitute for proper pay. I believe that the telegraphers are underpaid."

2. Such conditions have existed practically without change at least since 1884, in spite of the facts having been made public by three government investigations.

3. The workers are practically unable to improve their condition because these two companies, which control practically the entire industry, deny them the right of organization. The suppression of organization is effectively carried out by the discharge of all known to be union men or union sympathizers, by the use of spies who fraudulently secure the confidence of employees and report all known to be union members or sympathizers, by the use of an effective system of blacklisting, and by the control even of the personnel of the operators upon leased wires in the offices of brokers and other private individuals.

4. The two companies have a monopoly of the transmission of telegrams, and no effective competition exists between them. These companies are performing a service in the transmission of intelligence which has been held by the Federal Supreme Court to have been reserved by the constitution specifically to the Federal Government.

5. The telegraph companies are enormously overcapitalized, and their rates, which are graded to pay dividends upon large amounts of stock which do not represent investment of cash, are very much higher than the cost of service warrants.

6. Owing to the duplication of offices on the part of the two companies and the maintenance of branch offices which are idle for a large part of the time, this service is being performed inefficiently and at an unusually high cost in spite of the low wages paid the operators.

"It is suggested that the Commission recommend:

1. The property of the telegraph companies or such part of their equipment as may be necessary for the efficient operation of a National telegraph system, should be purchased by the federal government after proper valuation and placed under the general jurisdiction of the post office department for operation. In transferring the service to the federal government all employees, including officials and other persons, necessary for successful operation, should be retained, and those whom the elimination of the duplicate service of the two companies renders unnecessary for the national system, should be absorbed into other branches of the federal service as far as practicable.

2. At the time of the transfer to the federal service a special commission should be appointed to revise the salary ratings and other working conditions and place them upon a proper basis."

Telephone.

"The investigations of the Commission are the basis for the following statements:

1. The condition of the telephone operators in both interstate and local service is subject to grave criticism. The wages paid even in the cities having the highest standards are insufficient to provide decently for women who have no other means of support. The requirements and nervous strain incident to the service are so very severe that experienced physicians have testified that operators should work not more than five hours per day, whereas the regular working hours are from seven to nine per day. The operators, who are principally girls and young women, are required to work at night, going to and returning from their work at hours when they are subject to grave menace. The policy of the companies in general provides for sanitary and reasonably comfortable working places, and for attention to the recreation and physical needs of the operators, but in a number of cities the conditions even in these respects are subject to severe criticism.

2. The telephone operators are unable to secure reasonable conditions for themselves, because of their youth and the fact that they ordinarily remain in the service only a short time.

3. The organization of employees for their own protection is effectively resisted by the employing companies.

4. The American Telephone and Telegraph Company, with its subsidiary and affiliated corporations, controls more than 70 per cent of the total telephone business of the country. The American Telephone and Telegraph Company has been enormously profitable and is well able to afford the necessary improvements in working conditions. The American Telephone and Telegraph Company has increased its capitalization enormously without the investment of new capital.

5. The transaction by which the American Telephone and Telegraph Company, which had been a subsidiary of the American Bell Telephone Company, absorbed the parent company in 1899 was not only designed to evade the legal limitations contained in the Massachusetts charter of the American Bell Telephone Company, but resulted in the increase of the capitalization of the combination from \$25,886,300 to \$75,276,600 without the addition of any new capital.

6. The transmission of intelligence is a function which is specially reserved by the constitution to the federal government, but which in the telephone field has been permitted to become the practical monopoly of a single corporation.

"It is suggested that the Commission recommend:

1. The purchase by the federal government, after proper valuation, of the property of the interstate and local telephone companies, or such part of their equipment

as may be necessary for the efficient operation of a National telephone system.

2. The transfer of all employes, including officials, necessary for the efficient operation of the National telephone system, to the federal service as far as possible, and the absorption, as far as practicable, of all employes who are not necessary for the telephone system into other branches of the federal service.

3. When such employes are transferred to the federal service, the creation of a special commission to establish salary ratings and other working conditions on a proper basis.

4. In the meantime provision should be made by Congress for the creation of a minimum wage board to fix minimum wage standards for women employes who are engaged in the transmission of messages in interstate commerce. The board should be authorized to differentiate between localities in fixing minima; if on due consideration such differential rates should be deemed advisable.

5. The creation of minimum wage boards in the several states to fix minimum wages for all women employes engaged in service within the state."

The Pullman Company.

"The investigations and hearings of the Commission developed the following facts:

1. The conductors and porters employed in the car service of the Pullman Company are employed under conditions which seem to require radical readjustment. Both classes of employes are admitted by officials of the company to be underpaid.

The standard salary of the porters (\$27.50 per month) is such that the porters are obliged to secure tips from the public in order to live. The Pullman Company is admitted by the chairman of the Board of Directors to be the direct beneficiary of the tips from the public to the extent of the difference between a fair wage and that which is now paid.

The hours of service are extremely long, the regulations of the company allowing porters and conductors when in service only four hours' sleep per night and penalizing them severely if they sleep while on duty. Employes of the Pullman Company are subject to many other abuses, among which may be mentioned the arbitrary deduction from their salaries for such time as they may not be needed for the actual service of the company, although they are required to report at the office each morning and are sometimes compelled to wait the greater part of the day without compensation; the requirement that porters shall furnish blacking although they are not permitted to charge passengers for the service of shoe cleaning; the system of arbitrary penalties for the infraction of multitudinous rules; the requirement that all employes shall purchase

their uniforms from one mercantile establishment, the owners of which are largely interested in the Pullman Company; and the lack of proper provision of sleeping quarters for employes when away from their home stations.

2. The Pullman Company has a bonus system, by which employes who have a "clean record" for the year receive an extra month's salary. This system serves to increase the earnings of those who receive the bonus, and is unquestionably appreciated by them. Nevertheless, it is inequitable in penalizing with extra severity any infractions of rules which occur during the latter half of the year, and puts into the hands of officials and inspectors a means of discrimination which can be arbitrarily exercised.

3. The effect of the tipping system is not only to degrade those who are obliged by their economic conditions to accept tips, but to promote discrimination in the service of the public.

4. The employes of the Pullman Company are unable to improve their condition through organization, as employes known to be members of labor unions are discharged and through the means of an effective system of espionage employes are deterred from affiliating with labor unions.

5. The company is tremendously overcapitalized, having increased its capitalization from \$36,000,000 in 1893 to \$120,000,000 in 1915, without the investment of a single dollar on the part of the stockholders. Upon the basis of actual cash paid in, the annual dividends of the company are not less than twenty-nine per cent. During the history of the company the stockholders have received cash dividends amounting to at least \$167,000,000 and special stock dividends of \$64,000,000, making a total of \$231,000,000 on an actual investment of \$32,601,238.

6. The company enjoys a practical monopoly of the sleeping car service.

"It is suggested that the Commission recommend:

1. The enactment by Congress of a statute prohibiting the tipping of any employe of a public service corporation engaged in interstate commerce, and providing a proper fine for both the giver and the recipient of the tip.

2. The amendment of the existing law regulating the hours of service of train employes to include the employes engaged in the Pullman service.

3. The extension of the Newlands Act, as already suggested, to cover the Pullman Company."

Railroads.

"The investigations of the Commission with regard to railroads have been too limited to permit of general findings or recommendations. Enough evidence has, however, come before the Commission with regard to three points to warrant attention.

1. The railroad construction camps are largely insanitary, overcrowded and improperly equipped for the health and comfort of the employes. In addition there are many abuses, such as overcharging at the commissary and grafting by foremen.

2. The so-called voluntary benefit associations of a number of the railroads constitute, under the present system of management, a great injustice to employes. These funds, which are contributed almost entirely by the employes, the management as a rule paying only the cost of administration, until recently were generally used to relieve the companies from liability for accident, employes being required to sign a release in favor of the company at the time that they become members of the benefit association. In some cases, even, the membership is compulsory. Nevertheless the employes have no voice in the management and receive no equity when they are discharged. Finally, such associations, under their present management, serve to exert an undue influence over employes, since the members, if they quit the service for any period or for any cause, sacrifice to the company all that has been paid in.

3. Under the authority granted by the several states the railroads maintain a force of police, and some, at least, have established large arsenals of arms and ammunition. This armed force, when augmented by recruits from detective agencies and employment agencies, as seems to be the general practice during industrial disputes, constitutes a private army clothed with a degree of authority which should be exercised only by public officials; these armed bodies, usurping the supreme functions of the state and oftentimes encroaching on the rights of the citizens, are a distinct menace to public welfare.

"It is suggested that the Commission recommend:

1. Thorough investigation by the public health service of railroad construction camps as well as other labor camps, and the preparation of definite plans for such camps and a standard code of sanitary regulations.

2. The enactment by Congress of a statute expressly prohibiting corporations engaged in interstate commerce from inducing or compelling their employes to sign releases of liability for accidents.

3. Congress should enact a statute prohibiting interstate employers from requiring their employes to contribute to benefit funds, and providing for the participation of employes engaged in interstate commerce in the management of all benefit funds and other funds to which they contribute.

4. The regulation by federal statute of the employment of police on interstate railroads. The statute should not only provide for the organization, personnel and powers of such police, but should definitely provide that dur-

ing labor disputes such police should be subject to the proper civil authorities and paid out of the public treasury. The statute should also provide that such corporations should be permitted to have firearms only under license, requiring that a definite record be maintained showing the character of each firearm and to whom it is issued.

5. The assumption by the states of full responsibility and definite provision not only for protecting the property of railroads, but for preventing trespass upon their property."

Industrial Conditions in Isolated Communities.

One of the most striking features of the report is the finding that many typical industrial communities present every aspect of state of feudalism. The report says:

"The investigations and hearings of the Commission are the basis for the following statements:

1. The conditions existing in typical industrial communities which are either wholly or in large part owned or controlled by a single corporation or individual employer, present every aspect of a state of feudalism except the recognition of specific duties on the part of the employer. The employes in such communities are dependent on a single corporation, or employer, for their livelihood. Furthermore, the employer in many cases controls the social and political life of such communities, either by the complete absorption of local political powers or by domination of the local authorities.

2. The fundamental rights of citizens in such communities are, as a general rule, seriously abridged if not actually denied. Among the rights most seriously violated are the right of free speech and assemblage and the right of public highways.

In some cases, as for example in Colorado, employers in such communities have assumed to usurp the functions of the federal government itself in the issuance of money orders, and have not only denied employes access to the post office when located in their company stores but have opened and otherwise interfered with the mail directed to the employes.

Such feudalistic conditions tend to develop principally in connection with the private exploitation of natural resources, being most frequently found in mining camps, lumber camps (including turpentine camps) and large plantations. There are, however, striking examples even in the case of manufacturers, as, for example, the textile towns and steel towns.

3. The most extreme form of domination and control exists in what are known as "closed camps," where the employer owns all the land upon which such camps are located and, because of this private ownership, not only exercises control over the local government, but dictates arbitrarily

who shall be permitted to come into or pass through such communities. It has frequently been argued that such communities are simply the inevitable accompaniment of the development of new country and will be eliminated with time. This is not true, however, as the Commission's investigations have disclosed a large number of "closed camps" which have been in existence for more than a generation.

"It is suggested that the Commission recommend:

1. The enactment of appropriate state legislation providing that where communities develop, even upon privately owned land, the powers of the civil government shall not be interfered with, nor shall the rights of access to the residence of any person be restricted, nor shall the rights of persons to come and go unmolested, to speak freely and to assemble peacefully, be interfered with or considered to stand upon a different basis from the rights of persons in other communities.

2. In the case of public lands containing timber or minerals, which are now or may hereafter come into the possession of the federal government, it should be provided by statute that neither the lands nor the mineral rights should under any circumstances be sold, but should be used only upon lease for a limited term, such lease to contain as a part of the contract the conditions with regard to the rights of inhabitants as recited above and such lease to be forfeitable without recourse in case of the infraction of said conditions.

3. The Post Office Department should be directed to report to Congress all communities in which the post office is in any company's store or other building operated by an employer or in which the postmaster is a private employer or the agent of an employer. The report should show the facts separately for those communities in which the employer or corporation operates an industry upon which any large number of inhabitants are dependent.

4. Congress and the state legislatures should enact statutes providing that any attempt on the part of an employer to influence his employes either directly or indirectly in connection with any federal election either for or against any particular candidate, shall constitute intimidation; and further specifying that it shall constitute intimidation for any employer to give notice to his workmen that in the event of the election of any particular candidate, the establishment will not be operated."

Agriculture.

Today's section also urges action to improve the condition of farm labor and to stop the increase in farm tenancy by aiding farm owners. It says:

"It was obviously impossible for the Commission to attempt a detailed investigation of agricultural conditions; but, because of

the very immediate bearing of the land question on industrial unrest, it was felt necessary to make as thorough investigation as possible of the phases which seemed to have the most direct bearing on our general problem. The phases selected for discussion were first, the concentration of land ownership as shown by existing statistics; second, the problem of seasonal and casual agricultural labor; third, the increase and change in the character of farm tenancy; and fourth, the introduction of industrial methods into agriculture through the development of corporations operating large tracts of land. The findings and recommendations with reference to the concentration of ownership and the problems of seasonal labor are set forth elsewhere. At this point, it is desired to present the results of the investigations of tenancy and agricultural corporations.

"The investigation of these problems was confined practically to the Southwest, because it is in this region that the systems have become most fully developed and their results in the form of the acute unrest of a militant tenant movement are most easily studied. The investigations in this region, however, were very thorough, consisting of detailed studies and reports by field investigators, which were later confirmed by a public hearing.

"As a result of these investigations the following conclusions are fully justified:

1. Tenancy in the Southwestern states is already the prevailing method of cultivation and is increasing at a very rapid rate. In 1880, Texas had 65,468 tenant families, comprising 37.6 per cent of all farms in the state. In 1910, tenant farmers had increased to 219,571, and operated 53 per cent of all farms in the state. Reckoning on the same ratio of increase that was maintained between 1900 and 1910, there should be in Texas in the present year (1915) at least 236,000 tenant farmers. A more intensive study of the field, however, shows that in the eighty-two counties of the state where tenancy is highest, the average percentage of tenants will approximate sixty.

For Oklahoma we have not adequate census figures so far back, but at the present time the percentage of farm tenancy in the state is 54.8 and for the 47 counties where the tenancy is highest the percentage of tenancy is 68.13.

2. Tenancy, while inferior in every way to farm ownership from a social standpoint, is not necessarily an evil if conducted under a system which protects the tenants and assures cultivation of the soil under proper and economical methods, but where tenancy exists under such conditions as are prevalent in the Southwest, its increase can be regarded only as a menace to the Nation.

3. The prevailing system of tenancy in Southwest is share-tenancy, under which the tenant furnishes his own seed, tools and teams, and pays to the landlord one-third of

the grain and one-fourth of the cotton. There is, however, a constant tendency to increase the landlord's share, through the payment either of cash bonuses or of a higher percentage of the product. Under this system tenants as a class earn only a bare living through the work of themselves and their entire families. Few of the tenants ever succeed in laying by a surplus. On the contrary, their experiences are so discouraging that they seldom remain on the same farm for more than a year, and they move from one farm to the next in the constant hope of being able to better their condition. Without the labor of the entire family the tenant farmer is helpless. As a result, not only is his wife prematurely broken down, but the children remain uneducated and without the hope of any condition better than that of their parents. The tenants having no interest in the results beyond the crops of a single year, the soil is being rapidly exhausted, and the conditions therefore tend to become steadily worse. Even at present a very large proportion of the tenants' families are insufficiently clothed, badly housed, and underfed. Practically all of the white tenants are native born. As a result of these conditions, however, they are deteriorating rapidly, each generation being less efficient and more hopeless than the one preceding.

4. A very large proportion of the tenants are hopelessly in debt and are charged exorbitant rates of interest. Over ninety-five per cent of the tenants borrow from some source and about seventy-five per cent borrow regularly year after year. The average interest rate on all farm loans is 10 per cent, while small tenants in Texas pay 15 per cent or more. In Oklahoma the conditions are even worse, in spite of the enactment of laws against usury. Furthermore, over eighty per cent of the tenants are regularly in debt to the stores from which they secure their supplies, and pay exorbitantly for this credit. The average rate of interest on store credit is conservatively put at 20 per cent and in many cases ranges as high as 60 per cent.

5. The leases are largely in the form of oral contracts which run for only one year and which make no provision for compensation to the tenant for any improvements which may be made upon the property. As a result, tenants are restrained from making improvements and in many cases do not properly provide for the upkeep of the property.

6. Furthermore, the tenants are in some instances the victims of oppression on the part of landlords. This oppression takes the form of dictation of character and amount of crops, eviction without due notice, and discrimination because of personal and political convictions. The existing law provides no recourse against such abuses.

7. As a result both of the evils inherent in the tenant system and of the occasional oppression by landlords, a state of acute

unrest is developing among the tenants and there are clear indications of the beginning of organized resistance which may result in civil disturbances of a serious character.

8. The situation is being accentuated by the increasing tendency of the landlords to move to the towns and cities, relieving themselves of not only from all productive labor but from direct responsibility for the conditions which develop. Furthermore, as a result of the increasing expenses incident to urban life, there is a marked tendency to demand from the tenant a greater share of the products of his labor.

9. The responsibility for the existing conditions rests not upon the landlords, but upon the system itself. The principal causes are to be found in the system of short leases, the system of private credit at exorbitant rates, the lack of a proper system of marketing, the absence of educational facilities, and last, but not least, the prevalence of land speculation.

10. A new factor is being introduced into the agricultural situation through the development of huge estates, owned by corporations and operated by salaried managers upon a purely industrial system. The labor conditions on such estates are subject to grave criticism. The wages are extremely low, 80 cents per day being the prevailing rate on one large estate which was thoroughly investigated; arbitrary deductions from wages are made for various purposes; and a considerable part of the wages themselves are paid in the form of coupons, which are, in all essential particulars, the same as "scrip" which has been the source of such great abuse. Furthermore, the communities existing on these large estates are subject to the complete control of the land-owning corporation, which may regulate the lives of citizens to almost any extent. There is an apparent tendency toward the increase of these large estates and the greatest abuses may be expected if they are allowed to develop unchecked.

11. Prompt and effective action on the part of the states and the nation is necessary if any alleviation of the conditions which have been described is to be achieved.

"It is suggested that the Commission recommend:

1. The development through legislation of a system of long-time leases, providing that the tenant shall be compensated for all improvements made upon the property, and also providing for cropping systems which will maintain the fertility of the soil.

2. The establishment of national and state farm bureaus for the following purposes:

a. To act as an agent between landlords and tenants in the distribution of tenant labor.

b. To act as an agent between landlords and tenants in the preparation of equitable contracts.

c. To act as an information agency to assist homeseeking farmers.

d. To assist in the distribution of seasoned labor.

3. The development of better credit facilities through the assistance of the government and co-operative organization of farmers and tenants. No single measure can be recommended; the results must be achieved through the development of a sound rural credit system, the development of land banks, mortgage associations and credit unions. Foreign experience shows that through these means the rate of interest can be greatly reduced and the security of both borrower and the lender can be increased.

4. The general introduction of modernized rural schools and compulsory education of children. The functions of the school system should extend beyond education to the social service of the entire rural community, assisting in the organization of farmers and tenants for co-operative purposes, and promoting other measures looking to the community's welfare.

5. The revision of the taxation system so as to exempt from taxation all improvements and tax unused land at its full rental value."

Supplemental Findings and Recommendations of Commissioners Lennon and O'Connell.

The Commission on Industrial Relations today made public the supplemental findings and recommendations by Commissioners John B. Lennon and James O'Connell.

The Commissioners protest against the claim that the faults that may exist in trade union organizations can properly be considered among the causes of industrial unrest, and assert that such faults disappear as soon as trade unions are recognized and permitted to grow strong.

They urge strong labor organizations as the paramount remedy for industrial unrest.

The supplemental report dissents from the recommendation that a new federal industrial commission be created for the administration of all labor laws. It urges that instead of creating new machinery, the Department of Labor be developed and given ample funds for carrying on its work.

The supplemental report is signed by Commissioners A. B. Garretson and Frank Walsh, chairman of the Commission.

"Our signatures are appended to the report of Mr. Basil M. Manly, director of Research and Investigation of the United States Commission on Industrial Relations submitted to the Commission at its session held in Chicago during the months of July and August, 1915, except that portion of the report recommending a system of mediation, conciliation, investigation and arbitration, applicable to both state and nation, which proposes to create a commission of three mem-

bers, together with an advisory council of 20 members, 10 representing employers and 10 representing employes. The entire plan is set forth in the report of the staff as submitted to the Commission on Industrial Relations; also in a report to the Commission by Professor George E. Barnett, and in the report of Commissioner John C. Commons. From these recommendations we dissent for reasons assigned in this statement.

"The evidence submitted to the Commission at public hearings, together with the evidence secured by special investigators, has been fairly set forth in Mr. Manly's report and with even justice to all, whether employers, employes or the public.

Criticisms Not Justified.

"Our fellow Commissioners who are representative of the employers, contend in their statement that the report of Mr. Basil M. Manly for the staff is deficient in that it does not properly present an indictment against labor on the grounds of fostering and promoting violence in trade disputes, jurisdictional disputes accompanied by strikes, limitation of output, sympathetic strikes, contract breaking, apprenticeship rules, refusal to use non-union materials, alleged graft and so forth, and that it does not include these things among the fundamental causes of industrial unrest. All the evidence submitted to the Commission, as we understand and interpret it, proves that these things in so far as they do exist are in no sense causes of industrial unrest, but, on the contrary, are evidences of existing industrial unrest and are evils that are incidental to a situation wherein labor has at times been forced to fight with such weapons as it could command for advantages and rights that in justice should be freely accorded to the wage earners. So long as labor organizations are forced by employers to fight for the mere right to exist, and so long as wages paid to labor are so low that the unorganized wage earner often sees no choice except that between resorting to such weapons or seeing himself and his family sink below the poverty line, just so long will these evils at times manifest themselves as symptoms of the worker's desperation. The union, fighting for its right to live, is sometimes forced to tolerate acts would not be countenanced if its entity were secure and its energies were not absorbed in fighting for existence.

Strong Organizations the Cure.

"Experience shows that the evils complained of rapidly disappear in labor organizations as soon as the organization prevails over the opposition of the employers and establishes its right to organize. Strong unions mean decent wages, and decent wages raise wage earners to a plane of thought and action where all their acts and mental processes must no longer be directed toward a desperate struggle for the very right of themselves and families to live.

"Organized labor fully realizes how unfortunate it is that labor in its struggle for existence has occasionally been driven to consider its immediate advantage at the expense of the true economic principles that must govern in the long run. All the energies of organized labor's representatives have been exerted to minimize or eliminate any tendency toward limitation of output or jurisdictional disputes, but, at the same times organized labor insists that these tendencies where they exist are the logical and inevitable outgrowths of evils in industry that can be removed only by trade union action by the wage earners. We could cite evidence at great length to show that the tendencies complained of so far as they exist at all have grown out of the hard necessities with which labor has been confronted. It is enough here to quote briefly from the testimony of the distinguished economist, Professor Jacob H. Hollander of Johns Hopkins University, given before this Commission in New York City on January 20, 1915. Professor Hollander in discussing the limitation of output said:

"We lose sight of the fact that trade unions and unionists are not soldiering in the matter, but they are animated by a very high degree of fraternity in the matter, that they are willing to adopt the same principle if it is a matter of piece work instead of time work, that the endeavor of society should be to bring back industrial conditions from that unwholesome mess into which they have slumped, from this abnormal disproportionate allotment of workers to particular fields in excess of the requirements in those fields. We must without deviating one iota from the proposition which you have stated that it is socially unsound that workmen should do less than they properly could—society should seek to bring about conditions where they will do what they can without involving displacement and unemployment on the part of their fellow workmen."

"We hold that the report of Mr. Manly contains no statement that is unworthy of credence and that will not bear careful investigation. The conclusions and recommendations are warranted by the statement of facts and the accumulated evidence in the hands of the Commission."

The Evidence.

"All evidence accumulated, whether by special investigators or at public hearings, will be submitted to Congress, and we trust the people of our country will demand that it be published in full, particularly the following, which are well worth the most careful study by all persons interested in human uplift. The reports cited below have been prepared by competent investigators and were submitted to the Commission after careful investigation and verification by Director Basil M. Manly and by members of the Commission, and are the latest informa-

tion upon the various subjects covered by them.

Evidence Taken at All Public Hearings.

"Causes of Industrial Unrest, by W. J. Lauck.

Violence in Labor Disputes, by Mr. Luke Grant.

"Structural Iron Workers, by Mr. Luke Grant.

"Sickness Prevention and Insurance, by Dr. B. S. Warren.

Mediation, Arbitration and Investigation, by Prof. George E. Barnett.

"Condition of Labor in Principal Industries, by Mr. Edgar Sydenstriker.

"Efficiency Systems in Industry, by Prof. Robert F. Hoxie, Mr. John P. Frey and Mr. Robert G. Valentine.

"Industrial Education, by Commissioner John B. Lennon.

"Labor Complaints and Claims, by Mr. P. A. Speak.

"Trade Union Law, by Mr. J. W. Bryan.

"Colorado Situation, by Mr. George P. West.

"The Telephone and Telegraph Industry, by Mr. Christopher T. Chenery.

"Labor Conditions in Porto Rico, by Mr. Christopher T. Chenery.

"Labor Conditions in the Black Hills, by Mr. William P. Harvey.

"Labor Conditions in Los Angeles, by Mr. William P. Harvey.

"Preliminary Report on the Land Question, by Mr. Charles W. Holman.

"Agricultural Labor and Tenancy, by Mr. John L. Coulter.

"Unemployment, by Mr. William M. Leiserson.

"Extent and Growth of Labor Organizations, by Mr. Lee Wolman.

"Injunctions in Labor Disputes, by Mr. Edwin E. Witte.

"The Inferior Courts and Police of Paterson, N. J., by Mr. Redmond S. Brennan and Mr. Patrick F. Gill.

"Chinese Exclusion, by Mr. Edward A. Fitzpatrick.

Extent of Unrest.

"The principal duty imposed, under the law creating the Commission, was to seek to ascertain the causes of industrial unrest and offer such recommendations as we believe might alleviate that unrest. There can be no question but that unrest exists, in some instances, to an alarming extent. Thousands and tens of thousands of our people feel that they are deprived, under existing conditions in industry, of an opportunity to secure for themselves and their families a standard of living commensurate with the best ideals of manhood, womanhood and childhood. They resent the fact that the existing system of the distribution

of wealth which creates at one end of our industrial scale a few multi-millionaires and at the other end thousands and tens of thousands of men, women and children who are at all times in a situation where they are uncertain as to where their next meal will come from. Hungry, poorly clothed and without the opportunities that a fully rounded life requires, they become filled with a sullen resentment that bodes no good for the future of our republic.

"We have found men and women who are inclined to ascribe this condition to the fact that the government exercises no power of mandatory character to prevent strikes and lockouts. Many have been the propositions submitted to us for compulsory arbitration or, at least, compulsory investigation with power to recommend a settlement. Some have proposed an elaborate machinery to be set up by the general government, and of a similar character by the states, providing for conciliation, mediation, arbitration and investigation, all of which, while without definite compulsory features, establish a legal machinery that must of necessity exercise an influence in that direction.

"The plan for the creation of an industrial commission, both national and state, proposes to assign to a commission of three members the administration of all labor laws of either state or nation, giving to them powers far in excess of those exercised by the President of the United States, or the governor of any state. This we believe to be bureaucracy run mad, and a subversion of democracy dangerous to the civil and social liberty of all citizens. We hold that all power should be in the final analysis with the people, and we, therefore, dissent from any such plan."

New Governmental Machinery Unwise.

"The activities of such a Commission supplemented by the proposed advisory committees of employers and labor representatives would be so balanced as to prevent substantial progress, and tend to perpetuate present conditions. Such a plan conceives of labor and capital as static forces and of the relations between them as always to remain unchanging.

"We believe that the work now being done by the Department of Labor in industry generally, and by the Board of Mediation and Conciliation, dealing with interstate public utilities, is better than any that could be expected of any additional board that has been suggested to this Commission. We believe that the Department of Labor, with further experience and larger appropriations, will develop a high state of efficiency in adjusting labor disputes that are capable of being adjusted by any one other than the parties directly interested, and will adequately carry on the work provided by the law creating the Department of Labor, to-wit:

"Section 1. The purpose of the Department of Labor shall be to foster, promote and develop the welfare of the wage earners in the United States, to improve their working conditions and to advance their opportunities for profitable employment.

"Section 8. The Secretary of Labor shall have power to act as mediator and to appoint commissioners of conciliation in labor disputes whenever in his judgment the interests of industrial peace require it to be done."

"We favor the extension of the Newlands Act to cover all employes engaged in interstate commerce, such as the railroad telegraphers, the shop and track men employed by railroads, the employes of express companies, of the Pullman Company, of commercial telegraph and telephone companies, and other public utilities performing interstate service that, in the interest of the nation, must be continuous.

"The evidence submitted to this Commission is substantially to the effect that where trade union organization exists among the workers, there, at the same time, exists the least amount of industrial unrest of a character that is dangerous to the peace and welfare of our nation. It is true that the union men and women are not satisfied with their conditions; they are not, however, despondent as to the possibility of securing better conditions; they know what the unions have accomplished, and they have an abiding faith that their further desires can be attained.

"Instead of any elaborate machinery for the prevention of strikes or lockouts we are convinced, from the testimony gathered by this Commission, that the most effectual course that can be pursued to bring about general contentment among our people, based upon a human standard of living, is the promotion of labor organization. The most casual investigator will soon discover that in those lines of industry where organization of labor is the strongest, there is the least danger of industrial revolt that would endanger the fundamental principles of our government and the maintenance of a nation with respect for law and order. Where organization is lacking, dangerous discontent is found on every hand; low wages and long hours prevail; exploitation in every direction is practiced; the people become sullen, have no regard for law or government and are, in reality, a latent volcano, as dangerous to society as are the volcanoes of nature to the landscape surrounding them.

The One True Remedy.

We, therefore, urge as the great remedy for such unnecessary industrial unrest as we have found, more, and more, and still more, organization of labor and of the employers in each industry as well. The education of

the trade unions has been conducive to a higher and better citizenship. In recent years there have come to our assistance scores and hundreds and thousands of people outside the ranks of unionists—ministers, professors, journalists, professional men of all kinds—who have reached the conclusion that is herein stated, that the most efficient cure for such industrial unrest as should be cured, is union organization.

"We hold that efforts to stay the organization of labor or to restrict the right of employes to organize should not be tolerated, but that the opposite policy should prevail and the organization of the trade unions and of the employers' organizations should be promoted, not, however, for the sole purpose of fighting each other, but for the commendable purpose of collective bargaining and the establishing of industrial good will. Organizations of employers that have no object in view except to prevent labor having a voice in fixing the conditions of industry under which it is employed, have no excuse for existence, as they are a bar to social tranquility and a detriment to the economic progress of our country. The evidence before the Commission shows that organized labor has no desire, nor has it attempted, to control the business of the employer. It insists that it has a right to a voice, and a potent voice, in determining the conditions under which it shall work. This attitude, we are sure, will be continued in spite of the opposition of any so-called employers' organizations. This country is no longer a field for slavery, and where men and women are compelled, in order that they may live, to work under conditions in determining which they have no voice, they are not far removed from a condition existing under feudalism or slavery.

"In emphasizing with all the force at our command the necessity of collective action by wage earners through strong organizations, if the problem of industrial unrest is to be solved, we wish again to quote from testimony of Professor Hollander. He undertook to sum up for this Commission those conclusions regarding the solution of this problem that have been reached not only by himself, but by the great body of economists in this country and abroad. He said:

"The opinion of political economists insofar as I can voice it is that social unrest, which is manifest not only in this country but in every industrial country, is due to the existence of economic want or poverty, if by that we understand not on the one hand pauperism or on the other economic inequality. By poverty I mean the existence of large areas of industrial society in receipt of incomes less than enough to maintain themselves and those dependent upon them in decent existence. We believe that is the consequence, not of any absolute dearth—that the world produces enough to go around, that it is therefore not a question of insufficient production, but of defects

in distribution. * * * There is a view among economists that there is nothing in any current theory of wages that precludes the laborer from obtaining a sufficient wage, and that if he fails it must be in consequence of the fact that he enters into the wage contract on a plane of inequality. The wage contract, in short, is the result of a bargain between the employer and the employe, and if the employer is in a superior competitive position by reason of combination and the laborer is unorganized, he is at a bargaining disadvantage which is certain to redound to his hurt.

"I think political economists accordingly then are in agreement that trade unionism is essential as a means of bringing the workmen into industrial bargaining on a plane of equality.

* * *

"You have asked specifically what the remedy (for poverty) is. It means a very decided revulsion of opinion as to trade unionism. The general attitude among employers of labor is often open and decided opposition to organized labor. Until society recognizes the unwisdom of that attitude and demands that the laborer must enter into his wage bargain on a plane of competitive equality, society has not lifted its finger to remedy that evil."

The Public's Duty.

"We submit the report of Mr. Basil M. Manly as our report, asking for it the fullest possible consideration by the men and women of our country who are interested in the social and moral uplift of humanity.

"Labor must work out its own salvation. Wage workers can attain that degree of well-being to which they are entitled only by their own efforts. The general public can not be expected to do for them what they fail to do for themselves, nor would it be desirable that those rights and benefits to which they are entitled should be handed down to them by the government or by organized society as grace from above. But the general public is vitally interested in the efforts of wage workers to win for themselves equal justice and such a degree of material well-being as will enable them to maintain themselves and their families in comfort, security and health. Society's interest in the triumph of labor's cause should spring not only from the love of justice and the human sympathy that animates every good citizen, but from a realization that industrial and social evils menacing large groups of the population can not continue without eventually bringing disaster to society as a whole. While inviting the aid of every good citizen, we, as representatives of organized labor, urge that this aid be directed not solely to seeking new legislation or new governmental machinery designed as a cure-all, but to giving moral support to labor's own efforts, and insisting that trade unions be fostered and encouraged as the most effective agencies making for the wage workers' progress.

THE BOILER MAKERS' JOURNAL

Official Organ of the International Brotherhood of Boiler Makers, Iron Ship Builders and Helpers of America.

A Monthly Publication Issued the First of Each Month from Room 8, Law Building, Kansas City, Kansas.

JAMES B. CASEY, Editor and Manager.

Subscription Price.....\$1.00 Per Year in Advance

ADVERTISEMENTS.

Advertising Rates Will be Furnished Upon Application to the Editor-Manager. No Reading Space Will be Sold for Advertising Purposes Under Any Circumstances.

All New Members Must Have Their Name and Address Sent in Through the Secretary of Their Lodge. After That They May Have Changes Made in Their Address by Filling Out Blank Form in Back of Book and Forwarding to the Editor.

All Copy Must be Received by the Editor by the 15th of the Month to Insure Publication in the Following Issue.

All Contributions and Correspondence Relating to the Journal Should be Addressed to J. B. Casey, Editor, Room 8, Law Building, Kansas City, Kansas.

Entered at Postoffice, Kansas City, Kansas, as Second Class Mail Matter.

LEGAL NOTICE REQUIRED BY LAW.

Statement of the ownership, management, circulation, etc., of the Boiler Makers' Journal, published monthly at Kansas City, Kas., required by the Act of August 24, 1912.

Names of Stockholders: None.

Name of editor, James B. Casey. Postoffice address, Kansas City, Kas. Business manager, James B. Casey, Kansas City, Kas. Publisher, International Brotherhood of Boiler Makers, Iron Ship Builders and Helpers of America. Names of owners, The International Brotherhood of Boiler Makers, Iron Ship Builders and Helpers of America.

(Signed)

JAMES B. CASEY,
Editor and Business Manager.

Sworn and subscribed before me this 20th day of March, 1915.

(Seal)

A. G. DENGEL,
Notary Public.

(My commission expires March 20, 1916.)

LABOR DAY UNIVERSALLY CELEBRATED.

From all reports Labor Day was more generally and enthusiastically celebrated this year than ever before.

While in many cities the usual parade was dispensed with, in many others long lines of enthusiastic union men paraded in honor of the day.

Picnics, speaking and athletic sports were almost universally indulged in. In some cities rain interfered with the festivities of the day, in fact this holiday is becoming known as a decidedly wet one. Here in Kansas City it has rained five out of six past Labor Days. It interfered this year with the Central Labor Union celebration at City Park. The speaking, which was to have taken place from a large band wagon placed at the foot of a shady, grass covered hill side, had to be abandoned because of the rain. However,

dancing, racing and other amusements were indulged in by a good sized crowd during the afternoon and evening.

The working people in common with all other citizens of the United States have much to celebrate and rejoice over. First we are at peace with the world, while the whole of Europe is aflame with war, as it has been for more than a year. Again we should be thankful that we have at last passed through one of the worst industrial depressions this country ever witnessed and that we are now entering into a period of prosperity. Let us hope that ere another Labor Day comes around the European war will have ceased, so that the workers of Europe, too, may be able to join with us in celebrating labor's greatest holiday and the blessings of peace.

PRESIDENT GOMPERS ADVISES THAT STRIKES BE USED SPARINGLY.

In addressing a gathering of union men in the East not long ago, President Gompers is reported as having advised his hearers to use the strike sparingly and to remember that employers also have rights, however, he insisted that our free and untrammled right to strike is a paramount one.

We fully agree with President Gompers in the wisdom of sparingly using the strike as a weapon of offense. With organized labor it should be a court of last resort when all other means of redressing wrongs or grievances are tried and fail.

It is the reverse of wisdom for any one or body of men to "go around with a chip on their shoulder"; the strong man, confident of his strength, is willing to work temporarily under unjust conditions so that he may use all means at his command to effect a peaceable adjustment of the matter.

The real strength and advantage of labor is not gained by the actual participation in a strike, but by their being fully organized and equipped with men and finances to engage in a strike if necessary. This unused, stored up strength and resources, is what counts and secures a respectful hearing and generally a satisfactory adjustment. One of the requisites of preparedness is the thorough organization of all men working at the trade, so that we may control the supply of competent men and prevent them from taking the place of those who may be called out.

Suppose we had all the men working at boiler making and ship building in this country in our organization and that we had sufficient money in our treasury to pay each member two weeks' strike benefit. We would have more than 100,000 members and somewheres near \$1,500,000. With such a body of men thoroughly trained to discipline, ready and willing to respond to the call of their chosen leaders and backed by the above resources, it would not be necessary to strike in order to secure fair conditions and wages.

Under such conditions, instead of our members going on strike, they would remain at work and their representatives would go forth and speedily adjust grievances and make agreements. Shall we strive to reach this goal? It is no idle dream or impossible proposition. The necessary number of

men are available if we can only arouse them to their own interests and their duty towards organized labor.

As for resources, they would be easy to raise if we had anything like the membership mentioned. The boiler makers and ship builders of Great Britain and Ireland have fully as much in their treasury now, and with scarcely more than half of the number of members mentioned.

What we need is the arousing of our members to a proper sense of their duty to their organization so that they may go forth and help preach the gospel of trade unionism to the unorganized. They cannot expect the few salaried men to be able to effectively accomplish this task, besides adjusting the countless grievances, large and small, that are continually arising.

In years gone by every member was an active organizer and we should endeavor to revive this practical exemplification of trade unionism so that we may reach the goal of a complete organization, and then we can with ease and profit follow President Gompers' advice to use the strike sparingly and at the same time secure even handed justice for all working at our trades.

PHYSICAL EXAMINATIONS AN UNJUST REQUIREMENT FOR EMPLOYMENT.

The question of physical examinations is becoming a serious one to many of our members, as some employers, from one pretext or another, have adopted it. One of the principal excuses offered for it is that the company has inaugurated some kind of sick or disability benefit scheme. The motive for the inauguration of all such is supposed to be for the benefit of the employes, but if it is to be in reality a bar to employment for all those who are unfortunate enough to fall a victim to some disease, which was quite likely contracted through long years of employment at the work, which physical examinations would bar them, then these beneficent schemes are of a questionable merit.

Nearly every trade or calling tend to develop some diseases or ailment in all those who follow the same class of work for a long period of time.

The earnings of the average employe in the industrial world is little if any above that which is required to purchase the necessaries of life for himself and family, even if they are constantly employed, which is the exception instead of the rule, and we submit that it is unjust to require a physical examination and refuse work to those who may have contracted some ailment. They have not been able to accumulate enough to live on for the balance of their lives, and if they have contracted any ailment or disease work becomes more necessary than ever. To refuse men employment because of physical defects is to be far more cruel to a fellow being than is the average owner of an old worn out horse. When a horse becomes too old to work it is given pasturage, food and shelter from the winter's blast and allowed to take it easy because of its past usefulness. Humanity and christianity demands that at least as good treatment will be accorded to those who, through old age or disease, have ceased to be able to earn a

living. Society in general should provide for their wants in their declining days.

There is only one excuse for physical examinations and that is when they are used by the health authorities as a preliminary for furnishing medicine and expert treatment by the state or municipality for the purpose of eradicating disease.

However, the most serious objection to physical examination as a condition to employment, is that it is often used by the employer as a form of black list to reject or get rid of those they may hold a grudge against because of their activity in behalf of their trade union and their fellow employe.

Organized labor will continue to fight physical examinations as a condition to employment until it is banished forever from the industrial field. These sick and accident benefits, used as a pretext for these examinations, should be administered by the state.

The only requirement an employer should ask of an applicant for employment is the ability to make good at the employment sought.

WILL THE SHIP BUILDERS AWAKE?

While some of our oldest, most zealous and hard working members are ship builders and a number of our lodges are composed almost, if not entirely, of those working in the ship yards, still the number of organized ship builders in the United States compared to the number of unorganized men is very small. It seems that the great mass of ship builders in this country have been taking a Rip Van Winkle sleep for the past twenty years, and during this period have made little if any progress or even effort to improve their condition. In some places wages or conditions for the ship builders are not as good as they were two decades ago. The average rate of wages paid in some yards is not sufficient to provide the necessities of life according to our American standards of living, even though the most rigid economy is practiced, and it will not compare favorably with hod carriers and other laborers in communities where the latter are organized.

For the past several months the ship yards have been very busy, a long era of prosperity has opened for them, hundreds of millions of dollars worth of contracts have been booked and the prospects are that this activity will continue for a number of years.

With this promising condition before us we are curious to know if the men on the ways are going to make an effort to share in this prosperity beyond mere employment at such wages as the employers choose to give? If so then it is time they awoke from their sleep and took council with themselves. If they really desire to improve their conditions, there are no great problems to solve, or difficulties to overcome. All they have got to do is to organize and pool their interests, and resolve to stand unitedly and determinedly for a fair share of the wealth they produce. If they will set about this task in an intelligent business-like way, under the banner of this brotherhood, and with its assistance, the task will be easy of accomplishment.

Already we see signs of this awakening, which promises better things

for the men who build the great leviathan of sea, the tran-Atlantic lines, battleship, cruisers, freighters, tugs and yachts. We extend these men a hearty welcome into our ranks and promise them every assistance possible for our organization to give in helping them organize and march onward to better conditions.

THE COLORADO SUPREME COURT REPUDIATES JUDGE HILLYER.

Judge Hillyer, formerly counsel for the coal trust of Colorado and a specially appointed judge to try the striking mine workers of that state, and who shamelessly helped to railroad John R. Lawson, the union mine workers' official, to a sentence of life imprisonment, has been completely repudiated by the Supreme Court of that state. It granted a review of the case as well as a writ of supersedeas and barred Judge Hillyer from presiding at any other trial of mine workers. The trial and conviction of Lawson was one of the most shameless perversions of justice that has ever been witnessed in this country. Justice was outraged and the fair name of Colorado put to shame, however, the recent action of the Supreme Court is a good start towards removing this stain and it promises a complete reversal of this farce trial and conviction of a man that was unquestionably innocent of the crime trumped up against him.

We must, however, continue to fight for Lawson's complete vindication, for to allow any part of this diabolical conspiracy to stand as a precedent for other venal judges to seize hold of as an excuse to railroad other representatives of labor to prison in the future would endanger the whole labor movement.

ARE RAILROAD EMPLOYEES PAYING THE FREIGHT?

According to a recent report of the Interstate Commerce Commission, the revenue of the railroads of the United States, during the month of June, was seven dollars per mile less than it was for June, 1914, but the operating expenses for June were fifty-nine dollars per mile less than for the same month of 1914, making a net increase for the month of fifty-two dollars.

For the first six months of this year the operating revenues were eight hundred and forty-two dollars per mile less than for the same period, still the net revenues increased sixty-five dollars per mile over that for the first half of 1914 because the operating expenses were reduced nine hundred and seven dollars per mile below what they were for the first half of 1914.

The largest item of saving was taken from wages that would ordinarily have been paid to employes, therefore to accomplish this saving many thousands of employes were discharged and most of those remaining were put on short hours.

Therefore it would seem that as far as most of the railroads are concerned the employes have had to bear the whole burden of dull times.

TO USE ELECTRICITY FOR PROPELLING BATTLESHIPS.

An important and far reaching experiment in connection with the motive power of battleships, has been decided upon by the Navy Department. It has been decided to use electricity as motive power on the new Battleship California and contracts has been let for the necessary machinery.

We are told that if this proves to be a success that all future ships built will be so equipped.

It is claimed that electricity is more economical of fuel and that it will take up less room on the ships and the weight will be very much less.

The experiment will be watched with interest, for if successful, it will revolutionize motive power on warships and eventually all classes of merchant ships. Electricity is a strong competitor against the boiler in all industrial pursuits and is even invading the railroads to a marked extent, several roads having started using it to a limited extent. However, the steam locomotive has not by any means survived its usefulness, but will be with us for a long time yet.

THE EXECUTIVE COUNCIL TO CONVENE.

President Franklin has issued a call for the regular annual meeting of the Executive Council of our Brotherhood, and the members are requested to assemble at headquarters Monday morning, October 4.

While no great or momentous matters are pending still a large number of routine matters of more or less importance to our members accumulate during the year and will have to be acted upon by the council and it is usually in session for two weeks or more.

SOUVENIR PUBLICATIONS.

We are in receipt of copy of a souvenir publication entitled picturesque Honolulu and Hawaii. It is profusely illustrated with views of beautiful scenery of the Islands and of palatial and imposing buildings which shows the great progress and prosperity of the people of those beautiful mid-Pacific Islands. The book is a fine specimen of the printers' and engravers' art.

Many special editions of labor papers and souvenir programs of Labor Day celebrations have reached our table so far and they are in many respects more elaborate than ever before.

One of the nicest and most elaborate souvenir programs that we have so far seen this year was gotten out by the trade unions of St. Joseph, Mo. It is a 72-page magazine, artistically gotten up; it is profusely illustrated with photos of the union men and officers of that city and has a large number of historical sketches of the organizations having locals there and much other information of value to the union men of that city. This souvenir reflects much credit on the enterprise and push of those having charge of the matter.

PERSONAL MENTION.

Mr. and Mrs. R. A. Lines and daughter of Springfield, Mo., were recent visitors to headquarters.

Brother Lines was on his way to the Missouri State Federation of Labor convention at Moberly as a delegate from the Central Body of Springfield. Among other matters of interest to our members, he had a boiler inspection bill under his arm which he anticipates having the convention endorse and present to the next session of the Legislature of Missouri for adoption.

WITH OUR ADVERTISERS.

We desire to call the attention of our members to the advertisements that appear in the Journal each issue. These advertisers show by their patronage their friendliness towards our organization, and our members should show their appreciation by patronizing their goods whenever possible and says a good word in their behalf when the opportunity presents itself.

The first of our advertisers that we see on opening the Journal is that of Larned, Carter & Co., manufacturers of the celebrated "Headlight" brand of union made overalls that are worn by working men in all parts of America. This company is our oldest advertiser, having had its ad in the Journal for several years.

Next is the ad of the American Arch Co. This Company inaugurated a reform in arch brick making that was a life saver for our members; its bricks are made in small hollow sections that are easily handled and placed in position.

Twenty-five years ago the use of these bricks was a new idea and they were made in heavy, large sections and it was an awful job handling and placing them in position.

This reform is no doubt appreciated by our members who have the handling and placing of arch brick.

The next advertiser is that of J. L. Stifel & Sons, manufacturers of the well-known brand of Stifels Indigo union made overalls. This is one of the pioneer companies to engage extensively in overall making.

The next ad is that of the label of the Shoe Workers' Union. Our members should insist on this label being stamped on the soles of all shoes they purchase, as a matter of principle; it is a guarantee of the shoe being made under fair conditions and by union labor. It calls for no sacrifice on the part of the purchaser and means much to the shoe workers.

Next comes the Commercial National Bank of this city, one of the largest financial institutions in Kansas, and it is the bank where all of our financial affairs are transacted and the surplus funds of our Brotherhood kept. Our members are invited to transact their banking business with this bank.

The next advertiser is "The Boiler Maker," one of the very few magazines devoted to the boiler making industry in this country. It furnishes drawings and various other matters of a technical nature.

Most, if not all, of our members are familiar with it. It is published at its office in New York City. The last ad appearing on the back cover page is that of Mr. J. L. Eckert, foreman boiler maker of Chattanooga, Tenn. Mr. Eckert

is the author of a new book on inspection called "The Boiler Inspector." It is gotten up to aid those who are contemplating fitting themselves as inspectors. It contains many practical questions and answers on this subject, which has become a very important one.

Those of our members who desire more information should write to Mr. Eckert in reference to the contents of his book. We believe they will find the information it contains is well worth the amount asked for it.

QUOTATIONS.

To be thrown upon one's own resources is to be cast in the very lap of fortune, for our faculties then undergo a development, and display an energy, of which they were previously unsusceptible.—B. Franklin.

True courage has so little to do with anger, that there lies always the strongest suspicion against it, where this passion is highest. True courage is cool and calm. The bravest of men have the least of brutal bullying insolence, and in the very time of danger are found the most serene, pleasant and free. Rage, we know, can make a coward forget himself and fight. But what is done in fury or anger can never be placed to the account of courage.—Shaftesbury.

He that can only converse upon questions about which only a small part of mankind has knowledge sufficient to make them curious, must lose his days in unsocial silence, and live in the crowd of life without companion. He that can only be useful on great occasions, may die without exerting his abilities, and stand a helpless inspector of a thousand vexations which fret away happiness, and which nothing is required to remove but a little dexterity of conduct and readiness of expedients.—Dr. S. Johnson.

STRIKES NOW IN FORCE.

- Atlantic Basin Iron Works (Shields & Moran, New York). (Strike on.)
- Hibbon & Co., contract shop, South Chicago, Ill. (Unfair.)
- Milwaukee Boiler Co., Milwaukee, Wis. (Strike on.)
- Stockton, Calif. (Metal Trades strike.)
- Des Moines Bridge & Iron Works, Des Moines, Iowa. (Erecting work in Bremerton, Wash., Valejo, Calif., and Norfolk, Va., Navy Yards.)
- Heinie Safety Boiler Co., of St. Louis, Mo. (Strike on.)
- Wangler Boiler & Sheet Iron Co., of St. Louis, Mo. (Strike on.)
- O'Brien Boiler Co., St. Louis, Mo. (Strike on.)
- Halifax Graving Dock Co., Halifax, N. S., Can. (Strike on.)
- T. Hogan & Co., Halifax, N. S., Can. (Strike on.)
- New Orleans Boiler Works, New Orleans, La. (Strike on.)
- Dussell's Boiler Works, New Orleans, La. (Strike on.)
- Johnson Iron Works, Algiers, La. (Strike on.)
- The Arizona Copper Co., Clifton, Ariz. (Strike on.)
- Detroit Copper Co., Clifton, Ariz. (Strike on.)
- A. & N. M. Railroad. (Strike on.)

Mechanical Department.

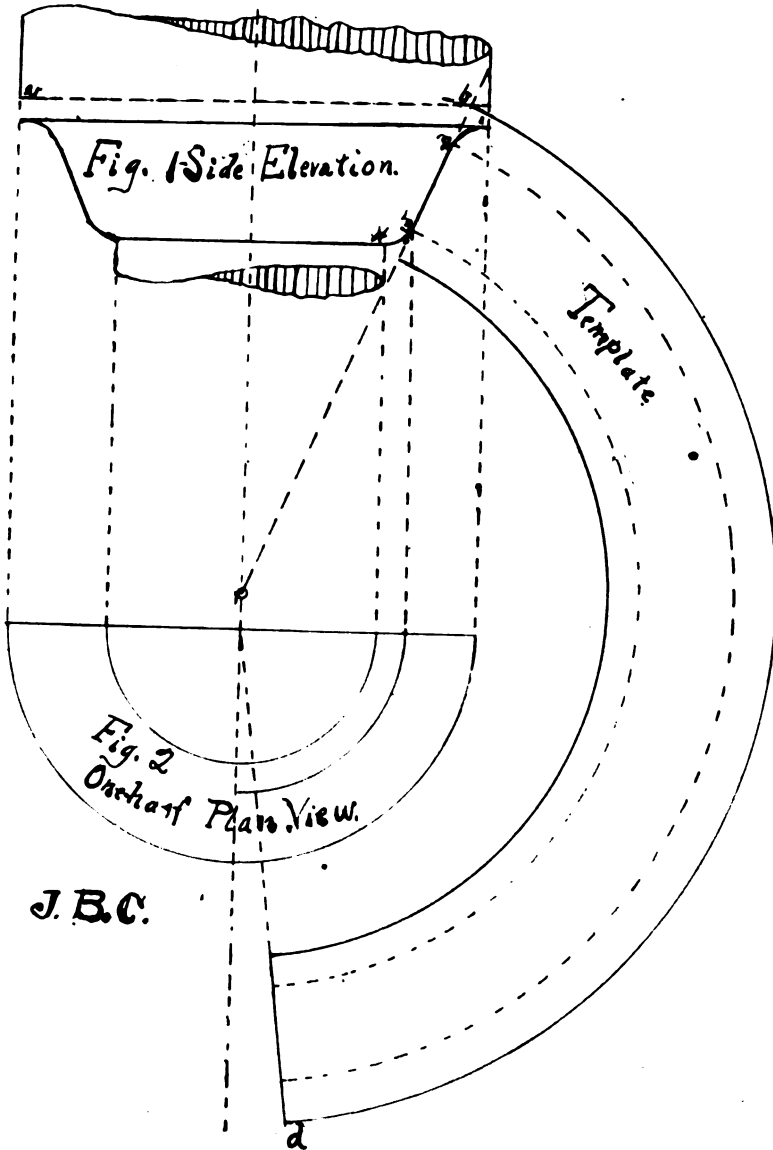

TO LAY OUT A CONICAL SHAPED SECTION WITH AN OGEE TOP AND BOTTOM.

Fig. 1 shows the side elevation and Fig. 2 shows one-half of plan view. First produce Figs. 1 and 2 the desired size, place straight edge on side line of Fig. 1, from points 2 to 3 and strike a line down until it cuts the center line at *o*, with this as a center for one point of dividers, strike circular

lines for template. Allow a little for loss by stretch out at top.

Take distance from *a* to *b*, Fig. 1, as a diameter and calculate circumference, mark this on the largest circular line from *b* to *d*, from *d* strike a line to *o*, this will complete the template, when using heavy iron use the mean diameter, when calculating the diameter.

After the template is rolled up and seam riveted the top will have to be flared out and the bottom worked in to suit the ogee.

International Officers' Reports.

REPORT OF SECOND INTERNATIONAL VICE-PRESIDENT NOLAN.

Portsmouth, Virginia.

The following is my report for August, 1915, in connection with many matters in the Southeast District:

August 1st, left Portsmouth, Va., for Washington, D. C., to meet Senator Martin also Mr. Berres of the Metal Trades Department, in connection with an arranged conference with the Secretary of the Navy on a grievance in the boiler shop at the Norfolk Navy Yard.

Meeting came off as arranged August 3rd, but nothing much was accomplished in the way of restoring the former rates to the boilermakers who had been disrated, only to assure the committee that the question at issue would be given a full investigation of the Department, but at this writing haven't heard of any investigation, at least the committee have not been notified, although I inquired at the Department, latter part of August, to find out if any investigation had taken place.

August 4th by instruction of Vice-President Hinzman left for Savannah, Ga., to investigate and settle if possible a controversy between the boilermakers and blacksmiths over the jurisdiction of Angle Iron work in one of the contract shops in Savannah. Arriving there August 5th, same date met a committee from Lodge 26, composed of Brothers Black, Howle and Dillon, who fully explained cause of grievance on the part of the blacksmiths' committee, claiming all Angle Iron work formerly done by boilermakers. A special meeting of Lodge 26 was called and an invitation was extended to the blacksmiths' committee to be present in order to meet a similar committee representing the boilermakers of Savannah so as to settle for once and for all any jurisdictional controversy between the two organizations, but the blacksmiths' committee failed to respond although, invited to do so.

Therefore the committee representing Lodge 26 were instructed to take up pending grievance with Mr. Wilkinson, proprietor of shop, the following morning, August 6th, which was carried out, as the committee Brothers Black, Howle, also the writer with them at 10:00 a. m. and after a short controversy lasting about an hour the jurisdictional squabble was settled satisfactory, as a letter on the boilermakers' jurisdiction over all Angle Iron works required in the construction and repairing of boilers and the other work generally done by boilermakers, with the exception of welding which belongs to blacksmiths was handed the committee by Mr. Wilkinson over his signature, a copy of which was mailed the International office, and desire to thank the committee, Brothers Black and Howle, as they were on the job all right, but absolutely fair on the jurisdiction of blacksmiths' work.

August 7th, left Savannah for Charleston, S. C., to look over general conditions there, contract shops and navy yard, and on arriving there found that a convention of the South Carolina State Federation of Labor would convene at the Isle of Palms, August 9th, at 10 a. m.

August 9th, attended the above convention as a guest, with other International officers, the convention was the first held in the state of South Carolina, and I must say was largely represented by delegates from almost every section of that state. The American Federation of Labor and also several International organizations were represented by officers who were representing their respective organizations and show their appreciation of the onward march of the organized labor movement of South Carolina as well as the uniting efforts of the men of labor of the state to secure a state convention, the first in its history. Many able addresses were made and several prominent public men who have been friendly to organized labor were present on the occasion as invited guests.

During convention many important questions were introduced and discussed in the interests of the wage earners of South Carolina, as well as necessary legislation required for their future protection, which the legislative committee were instructed to present to the next legislature.

In conclusion let me say that the convention was a credit to the officers and delegates, not a particle of friction, all working together with one object in view, the betterment of the wage workers of the old state of South Carolina, which has a brilliant record, past and present, in the vital affairs of the Nation.

August 11th, visited the Charleston Navy Yard and talked with several of the members of Lodge No. 50 on questions affecting local conditions there, among others were Brother Clair, secretary of Lodge No. 50, and arranged for future work in that city providing the officers and members deem it necessary or conditions would justify it.

While at the Navy Yard, I called on the Commandant, Captain Bryan, formerly director of U. S. Navy Yards with headquarters at Washington, D. C., was sorry to see him leave Washington as there was many matters coming up from time to time that Captain Bryan could give the desired information without having to call on the Secretary of the Navy.

On the night of August 11th, left Charleston, S. C., for Portsmouth, Va., reaching there the following morning. Attended a meeting on the 12th of the Navy Yard Federation of trades at which many existing grievances were discussed. Among others, was the question of too many rates in Uncle Sam's workshop for any practical mechanic knows from experience that all rates over

first and second class rates is an injustice to the government and the men also, it's unnecessary to waste time and paper discussing the fallacy, or in other words the foolish mismanagement under such a rate system and a concerted effort should be made by all Internationals to bring about a change as there are too many classes now in vogue and should be abolished by an act of Congress if necessary.

August 13th, attended a meeting of Lodge 428, the question of an increase in wage, also an agreement is still pending, awaiting a conference with the shop proprietors at this writing; if some of the boilermakers employed in the contract shops of Norfolk would only realize their position and become members of the International Brotherhood, there wouldn't be much trouble in securing an increase in wage, or recognition in the shape of an agreement, but no, they want the other fellow to get results and allow him to pay the cost. Brothers Halstead and Murdock with a few others does all the work in the interest of the contract shop boilermakers of the city of Norfolk, Va., while the balance sits on the fence and looks wise and then we claim to be intelligent American citizens. Same date August 13th, called on the Industrial Manager Norfolk Navy Yard to secure necessary data, which was turned over to chairman of committee Brother Phillips for future reference and use before the Department, is necessary.

August 14th, by instructions of Vice-President Hinzman left Portsmouth for Gassaway, West Va., on a grievance existing at the shops of the Coal & Coke Railroad Company, arriving there on the 16th; on reaching Gassaway I at once went to the shops of the company in order to get a line on grievance among the federated crafts. Had the pleasure of meeting Brother Davis who was a delegate to the St. Louis Convention of the International Brotherhood, same day, 16th, a representative of the Labor Department from Washington, D. C., arrived on the ground to co-operate with the Federated Trades in bringing about a settlement of pending trouble. As no officer of the affiliated crafts was present the commissioner of conciliation, Brother A. L. Faulkner, and I discussed the situation at Gassaway from every angle in hopes of bringing about a satisfactory adjustment of grievance for the Federated Trades at the Coal & Coke Company shops at Gassaway. That night, 16th, held a meeting with the Executive Board of the Federation on the system; Brother Faulkner, the commissioner put a proposition before them to accept, which he believed would bring about a satisfactory settlement pending improved conditions on the system; there was quite a long discussion on the part of the federated committee on proposition suggested by the commissioner; however, a vote was taken and the proposition as suggested was adopted (which was in part as follows): "Company agreed to meet Federated Trades on or about August 19th, to take up question of better shop conditions,

also an increase in wage will be considered when conditions of county and Coal & Coke railroad justify it, which was signed later on by I. K. Dye, general manager, Coal & Coke Railroad Company, also commissioner of conciliation, Brother A. L. Faulkner.

August 18th, left Gassaway, W. Va., for Portsmouth, Va., arriving there following day, attended a meeting of Navy Yard Federation same night.

August 20th, received instructions by wire from First Vice-President Hinzman to proceed to Wilmington, Del., as there was an opportunity of organizing a lodge of the brotherhood in that city; on arriving there I called on the official representative of the machinists, Brother Ago, who gave me all possible information and co-operation in getting a meeting of the boilermakers and shipbuilders.

August 22nd, attended an open meeting of the machinists who were on strike for the eight hour day, and prospects look bright for a victory in all machine shops at Wilmington, Del.

August 23rd, attended an open meeting of shipbuilders employed at the Harlin & Hollinsworth shipbuilding plant; no organization was effected at that meeting; however, a motion was made and carried to call another meeting on August 30th.

August 24th, left Washington, D. C., to meet President Franklin on a question then pending before the Metal Trades Department, in connection with the Federation of Navy Yards and Arsenal employes. Returning to Wilmington, Del., on the 26th to attend an open meeting of shipbuilders there as previously arranged at which some progress was made to organize a lodge, but adjourned for final action until August 31st.

August 27th, left for Philadelphia in company with President Franklin, whom I met on train at Wilmington, en route for Philadelphia. Attended a meeting of Lodge 19 with Brother Franklin which was without doubt well attended and the way matters were handled during meeting reflects much credit on the officers and members of Lodge 19. Under the head of new business Brother Franklin delivered an address on matter in general connection with the International Brotherhood, also on a Navy Yard question of much importance to the members at this particular time, giving his opinion as how to proceed in order to get what rightfully belongs to them, granted by one authorized representative body of the Navy Department and refused by another; Lodge 19 desires to place the proposition before the Secretary of the Navy through a committee believing that case is a just one, and therefore are confident that the wage increase which was granted them by the wage board will be approved by the Secretary of the Navy, when conference takes place at Washington, D. C.

August 29th, left Philadelphia, Pa., for Wilmington, Del., to attend open meeting of boilermakers, shipbuilders and helpers on the 31st, and am pleased to report that the

old Wilmington local was reorganized, while not a large one numerically, yet there is a good prospect for a large lodge later on when the local gets in running shape, as there are at least four hundred craftsmen eligible to become members of the Brotherhood in Wilmington, Del., and why such a condition exists is a puzzle, and among craftsmen who should know better as there never was a better opportunity to secure conditions all around than in that particular industry at this time. When every ship yard is over run with contracts and more signed up almost every day.

Those who know the absolute necessity of organization and the benefits derived from it yet and then look at the awful conditions existing in many industrial centers, from lack of organization it should be an object lesson. It's strange in these times, when progress and co-operation should be the watch-word, in order that the high ideals of American manhood and citizenship may be not only protected but advanced through organization, so as to prepare for a new era predicted by many great economists in which justice will be the dominant force only and secured through intelligent co-operation of organized labor forces, so that the toilers of America can stand erect as American trades unionists, no longer stooping in cringing fear for the future, but on the contrary, with American courage coupled with honest hopes and ambition as well as eyes unclouded by many blighting memories of the past, which have been forced on the organized workers from time to time in their efforts to uphold human rights and justice and that effort will go on and on regardless of pin-headed oppressions of honest labor, until justice is re-enthroned in the land of the free for this world is filled with men of curious notions who think they know it all, even in a hovel and always on the throne with nice deceiving explanations that unionism is wrong—of course ideas for reasons of their own and the more we get to know them, their true colors we will find, for shining under cover, is that old familiar sucker, a personal axe to grind.

Fraternally,

THOS. NOLAN, I. V. P.

A Correction.

In writing my report for August issue of the official journal on matters then under investigation in the Boiler Department, Norfolk Navy Yard, I failed through oversight on my part to give full credit to Brother Harry E. Phillips who is an active member of the shop committee, as well as chairman of it, also the Navy Yard Federation of Trades.

REPORT OF THIRD INTERNATIONAL VICE-PRESIDENT MERRIGAN.

June 30 I left Halifax to attend the semi-annual meeting of New Brunswick Federation of Labor, which was held at Moncton, July 1 and 2 in the W. C. T. U. Hall.

The following is a synopsis of the meeting: The meeting opened promptly at 11

a. m., with Brother D. J. McGillivray in the chair. His worship, Mayor L. W. McAnn, in the course of a splendid address, welcomed the delegates to the city, which is an especially suitable place in view of the large number of union men resident and working there. Dr. O. B. Price, M. P. P., also addressed the delegates at some length, referring to the recent dispute between the C. B. of R. E., and the international unions. He pointed out that the only way in which progress can be made is in working together so far as possible.

The convention then opened for business with Brother J. L. Sugrue in the chair. Brothers Kemp, Smith, McGee, Hughes and McGillivray were appointed a committee on credentials.

The following committees were appointed by the convention: Resolutions, ways and means, audit, constitution and law, union label and officers' reports.

President Sugrue and Secretary Ayer submitted lengthy reports, showing a most encouraging rally of the labor unionists of the province to the support of the federation.

Brother J. A. McLelland of the I. A. of M., and the writer addressed the convention briefly at the opening. Brother Scott of the painters and decorators addressed the convention later.

Brother J. L. Sugrue, the president, who was also the lobbyist at the session of the N. B. legislature, submitted a lengthy report, covering his activities during the past six months, which resulted in the adoption by the government of a number of desirable amendments to existing legislation so far as labor is concerned. The president also reported having obtained a promise from the government to introduce an improved Workmen's Compensation Act at its next session. It is hoped that an act will be obtained in line with that now in force in Nova Scotia or Ontario.

Brother P. D. Ayer, the secretary of the federation, presented his report, which showed nineteen organizations at present affiliated with the federation, representing a membership of 1,620 organized men. In this report it was noted with satisfaction that while the province has not suffered to nearly as great an extent from unemployment as some of the sister provinces in the western section of the Dominion that considerable was to be met with, particularly in the city of St. John, where conditions brought about through the war had caused a number of locals to fall behind in membership. In many cases the heavy enlistment of union men for overseas service has had the effect of seriously depleting the ranks of organized labor and impairing the efficiency of the unions.

The following delegates were present: George Crawford, Fredricton Labor Council; J. L. Sugrue, St. John Trades and Labor Council; D. J. McGillivray and M. Hourihan, Moncton Trades and Labor Council;

Charles E. Fox and G. B. Wallace, Local 460, I. B. Blacksmiths and Helpers, Moncton; J. J. Hughes, U. A. Plumbers and Steam Fitters, St. John; Seymour Powell and John Delay, I. B. Boiler Makers and Helpers, Moncton; S. Mackay, N. B. Brick Layers, Masons and Plasterers, Fredricton; J. C. Smith and R. J. Baxter, U. B. Carpenters and Joiners, Fredricton; C. H. Stevens and John Kemp Cigar Makers, St. John; B. Haines, U. A. Plumbers and Steam Fitters, Moncton; H. W. Chapman, Iron Moulders Union, Sackville; John J. McGillivray, I. B. Maintenance of Way Employes, St. John; W. M. Halliday, Painters and Decorators, St. John; C. H. Cameron, S. Gordon, William McNavin and C. A. Melanson, I. A. of Machinists, Moncton; D. Magee, I. B. Maintenance of Way Employes, Moncton.

On Thursday evening the delegates were entertained at a "smoker" by the local Trades and Labor Council.

The following officers were elected: President, J. L. Sugrue (re-elected); vice-president, C. M. Melanson, Moncton; recorder, M. Hourihan, Moncton; secretary, P. D. Ayer, Moncton (re-elected); vice-president for Moncton, B. Haines; vice-president for St. John, C. H. Stevens; vice-president for Sackville, H. W. Chapman; vice-president for Fredricton, R. J. Baxter. Executive will select the next meeting place.

On July 3 I returned to Halifax and remained until August 30, in the interest of Lodge No. 580, who had made a request for an increase in wages of the five employers at Halifax and Dartmouth. The increase requested was from 28 to 35 cents per hour and 20 to 25 cents per hour for boiler makers and ship builders and helpers respectively. At a regular meeting July 7 the members of Lodge No. 580 decided to modify their request and reduced the rates to 32 cents for boiler makers and ship builders and helpers 23 cents per hour, same to go into effect August 1. The employers were notified of this change, and a reply was requested for July 20. Replies were received from three of the employers up to the 21st, meeting night. The writer and Brother T. M. Burns, president Lodge No. 580, waited on the employers and received a favorable reply from four of them. Later the writer waited on four of the employers personally regarding the agreement and rates of pay, and explained the demands of the men.

On July 19 a special meeting was called, owing to the discharge of one of the members employed at the Halifax Graving Dock for being an agent of the union, as they put it. The member who had been discharged for his activities did not care to have the lodge take any drastic action at the time. However, ample precaution was taken in case another member should be discharged under the same circumstances.

On July 21, at the regular meeting, the report of the committee and the writer was heard. As the replies were not quite satis-

factory to the members, the writer interviewed four of the employers regarding the increase.

Owing to August 1 not being far distant a special meeting of Lodge 580 was held later to ascertain whether or not the members would continue or discontinue work under the former rules and rates. At the meeting it was decided almost unanimous that the members of Lodge 580 would discontinue work at midnight July 31 if their request was not acceded. Committees were appointed for each shop to wait on the employers for a final reply. The T. Hogan & Co. informed us that they could not meet our request in any way. The Halifax Graving Dock Company informed the committee to get out of the yard and to get their money. In the meantime the foremen had a busy time going about the works consulting those employed at our line of work, whether they were members, and to their great surprise found that 95 per cent of them were members. The company endeavored to enlighten the public that there was a lockout and later when a lockout did not sound good, the public was informed that a few men had been laid off, owing to slackness of work. Up to Saturday evening the following firms agreed to our request: A. Cox & Co., N. Evans, Ltd., and A. A. Webber & Son.

On Monday, August 2, there were about three men working at the Halifax Graving Dock, and none at the T. Hogan & Co. shops.

The first meeting of the members on strike was held at 10 a. m., Monday, August 2. Officers were elected and the necessary pickets appointed. An effective system of picketing was established, and good results were accomplished. The strikers held meetings daily, which were enthusiastic and orderly. Every member conducted himself as a member should, and was commended on all sides on the manner in which the strike was being conducted.

The Halifax Graving Dock Company made several attempts to induce some of the men back to work. But these same men have learned sufficient not to be led astray. Past experience is sufficient for them. No question but what the T. Hogan & Co. are a tool for the Halifax Graving Dock Company. Up to the eleventh hour this firm was agreeable to our request, and suddenly changed. However, the T. Hogan & Co. is not receiving the support that they expected from the Halifax Graving Dock Company. The Halifax Graving Dock Company has long since been hostile to organized labor, and this was evident to all who were employed from time to time. An open shop without a doubt. The members on strike know that this fight has got to be won, and will do everything in their power for a victory. Unless the latter is accomplished there will be little hope for the man working at the trade ever receiving what has been long due to them—a fair wage and

better conditions. The members of Lodge 580 who are on strike are receiving strike benefits weekly. They have not the obstacle that many others had to face, such as unemployment and the importation of strike breakers. Everything seems to be in their favor, and by displaying the same enthusiasm through the strike there is no doubt but what victory will crown their efforts.

I remained in Halifax until August 30, rendering as much assistance as possible, and then I found it difficult to keep other engagements.

On August 30 I left for Moncton to meet with Brother D. J. McGillivray, president System Federation I. R. C., regarding the federated agreement and other matters pertaining to the welfare of the movement. I left later for Quebec to meet with the members of Lodge 601. Arriving there on Tuesday afternoon I arranged with the officers to hold a meeting on September 2. During my visit to Quebec I met with a former member of Lodge 604, who had made use of the funds of the lodge for his own purpose, and who was given a certain length of time to repay the amount. On investigation I found that our friend had not made good his former promise. He had paid part of it and possibly was of the belief that nothing more would be mentioned about the balance. However, this ex-member was informed of his past actions, and will now repay the balance in monthly payments or no work.

On the 3rd I left for Montreal, arriving the following morning. Attended meeting of Lodge 134. Preparations for Labor Day parade were being attended to and other matters of importance. From the 4th to the 10th I remained in Montreal on work in connection with this office. Trade is slack, and no immediate prospects of anything better. Railroad employes on short time and contract shops doing very little work. With the result that a number of our members are idle.

Organized labor was well represented in the Labor Day parade at Montreal. During the current year several new crafts had been organized, which lengthened the line of the parade on Labor Day. Fine weather prevailed throughout the day, and the picnics and games were well patronized.

On the 10th I went to Joliette to have a meeting with the members of Lodge 604, as there were some matters in connection with the lodge that had to be attended to. From Joliette I returned to Montreal, and from the latter place I went to Ottawa to take up some matters with the Departments of Railways and Canals and the Naval Department.

September 15 finds me in Ottawa and leaving for Hamilton, and other points west thereof. I am,

Yours fraternally,

J. P. MERRIGAN,

Third International Vice-President.

REPORT OF FOURTH INTERNATIONAL VICE-PRESIDENT WEYAND.

Dear Sir and Brother:

The following is my report for the month of August:

At the conclusion of my last report I was in Baltimore, Md., carrying on an organizing campaign in the interest of Lodge No. 193. On Sunday morning August 1, I received a call by phone to come at once to the home of Mr. E. Crowe, No. 1645 Belt Avenue, City of Baltimore. On my arrival I was informed that a brother member by the name of J. A. Kilcullen had died at the home of Mr. Crowe. After getting whatever data I could in connection with his standing from Mr. and Mrs. Crowe I went to the home of Secretary Chaney of Lodge No. 193, and advised him to get in touch with the officers of Lodge No. 193 and arrange for a committee to assist in arranging for the burial of the deceased brother, also had considerable correspondence in connection with the death claim, and made many trips to the home of Mr. Crowe.

On August 4th, I attended the regular meeting of Lodge No. 193, and requested the co-operation of our members in order to get the unorganized boiler makers and helpers of the contract shops and ship yards organized. I also continued my trips to Fairfield to keep in touch with the work being erected at the refinery. Made several trips to the Curtis Bay as we have information that a large distillery is about to be erected within the next few weeks which will mean considerable work for our members. About August 12th, I received a telegram from the International President's office that the system federation of shop trades with their representatives were going to meet the management on August 16th, and for me to arrange my work in Baltimore so that I can be in Albany to assist the men on the Delaware & Hudson Railroad with a new agreement. On August 15th, I went to Albany, N. Y. The following week we had regular meetings with delegates representing the shop trades on the D. & H. R. R. and drew up a new agreement, presented same to the management and went into conference with the superintendent of motive power on Wednesday, August 18. We found from the beginning of our conference with the officials that they were opposed to giving an increase in wages at this time and had prepared a great amount of data to prove that the D. & H. was paying better wages than the roads running parallel with them. After several days in conference with Mr. Manning, superintendent of motive power, on the wage question, Mr. Manning informed us that unless the men on the system withdrew their demands for an increase in wages that he could not go any further in the matter and that we had a right to appeal to their general manager, Mr. Sims. The question of an increase was then submitted to the delegates of the federation and discussed and taking into consideration all data and facts in connection with the money question on

the D. & H. R. R., the delegates decided to drop the money question for the time being. Owing to the fact that they had received an increase in wages every year the last four years it would be good policy to use good judgment and endeavor to get a good set of working rules at this time. On August 20th I was requested to attend the regular meeting of the machinists of Green Island and explain the situation on the D. & H. R. R., relative to the wage question. Had a very large meeting and in the absence of their representative who had to leave for a few days on other business, I endeavored to explain to them the situation as I saw it, and gave them all the information necessary to convince them that it was good policy to drop the wage question at this time. We then went back to Mr. Manning and informed him that the men would agree to drop the wage question, provided they could get satisfactory shop conditions. After a great deal of discussion on the working conditions, I feel the men got a very good working agreement and will have a better opportunity to get an increase in wages one year hence. We signed up with the management the following Monday, which was August 23. The same evening I attended a special meeting of Lodge No. 173 of Green Island and the largest point on the system, and I may say the boiler makers and helpers have one hundred per cent organization. We had a very good meeting and I explained in detail the settlement made on the system which was satisfactory to the men. The following day I returned to Baltimore to again take up the organizing work in the interest of Lodge No. 193. August 30 I went to Fairfield to look up several delinquent members and arrange to send five card men to a job which was reported to me.

Before closing my report for this month I may say there is lots of work to be done in this part of the country and I trust in due time our Brotherhood will be in a position to put more organizers in the field in order to build up a very large membership in the near future.

Trusting this is satisfactory and with best wishes and kindest regards, I am,

Yours fraternally,

LOUIS WEYAND,
Fourth Int. V.-P.

REPORT OF SIXTH INTERNATIONAL VICE-PRESIDENT DOWD.

To the Officers and Members of the Brotherhood, Greetings.

Following is my report from April 15th to September 12th. In Port of New York attending to matters in the interest of the Brothers of District No. 2. Visiting the various shops and work under erection in the buildings and in the fields. I visited the Edison Co. plants seeking information in regard to some tanks this company was having erected at Birmingham, Ala. I did not get this information requested by Brother Carmack of Lodge No. 4 as it was impossible to get same. Also had conferences

with Mr. Hunter, representative of the Metal Trades Association, in regards to getting an agreement with his association.

Also visited work under construction at 59th St. Power House and the B. R. T. Power House at Brooklyn, N. Y.

Visited Iron Steamboat shops and got promise from some of the men employed there that they would get re-instated in Lodge No. 21.

Also made visits to Newark, N. J., and visited the boiler shops in that city.

Went to Waverly, N. J., to look up some tank work there.

Attended meetings of Lodge No. 176 at Elizabeth, N. J.

Also visited tank job being erected by the R. D. Wood Co. at the Standard Oil plant at Bayonne, N. J.

After talking with the foreman in charge of this work, trying to get him to pay the prevailing scale of wages and grant an eight hour day, as this work was being erected under open shop conditions, nine hour day and wages from \$2.25 to \$3.75 per day. The foreman requested me to visit their home office at Camden, N. J., which I did but could not see the general manager as he was out of the city.

Also located a big tank job at the sugar house in Brooklyn which was to be done by the Lebanon Steel Works, also located a tank job this company was erecting at Shadyside, N. J., with non-union men and working nine hours and a half a day, paying \$2.75 for boilermakers, \$2.00 for holder-ons, and helpers. I stopped these men and after a conference with the foreman placed members of our organization on this job at \$4.25 for boilermakers, \$3.50 for holder-ons, and helpers, and eight hours a day.

I had a conference with Seemon and Wenzell Welding Company in regards to men in their employment who were members of Lodge No. 163 and who were in arrears for dues. Mr. Seemon assured me he would attend to this matter.

I made a trip to the Northport Power House at Long Island and located a large steel stock which was to be erected by the Connery Boiler Works of Philadelphia, Pa.

I also had a conference with the management of the Mexican Petroleum Company at their office in New York. This company is to erect a new plant at Warners, N. J., which is expected to start next fall and several tanks and stills and condensers are to be erected as from the information I have this is to be a new refinery.

I also attended meetings of Lodges 16, 21, 45, 163, 176 and 200.

May 16th—June 15th.

Visited the office of District No. 2 daily.

Visited a job at the power house at Marion, N. J., also Tiejn and Langs dry dock at Hoboken, N. J., and Fletcher Boiler Works and visited several buildings looking up work that belonged to our organization and placing our members on same.

May 24th. Left New York for Albany, attended a conference of the Executive

Board of the New York State Federation of Labor, by orders of Vice-President Hinzman. President Gompers was also present at this conference. The purpose of this conference was to get the views of the various organizations as to the changes desired in the State Constitution.

May 25th. Left Albany for New York.

Visited the office of Bartlett, Haywood Company in regards to repair work in Brooklyn.

Visited McWilliams dry dock at Staten Island and the Verdons ship yard, Staten Island Shipbuilding Company, and talked to the men employed in these shops in regards to getting re-instated in their respective lodges. Also attended regular meeting of District No. 2.

I also visited various shops in the City of New York, Brooklyn, Greenpoint, Hoboken, Newark, N. J., and Jersey City, talking to the delinquent members in regards to them being reinstated. I also collected some reinstatement and initiation fees and held a meeting of boilermakers and helpers employed at the Standard Oil Company at Bayonne, N. J., in regards to organizing the men of our craft employed by the above company.

June 14th. Left New York for Boston, Mass., at the request of Lodge No. 585 and attended a mass meeting held by the Metal Trades Council of that city for the purpose of trying to organize the unorganized men who are employed in the metal trades industry.

They had a very nice meeting for the first one and I believe meetings of this kind will do some good. The following speakers addressed the meeting: John Connolly, B. 9 of the Machinists, Frank Tully, president of the Metal Trades, Representatives of the Engineers and the Sheet Metal Workers, Brother Dan Generson of Lodge No. 585, Brother Scott, I. D. O., and myself.

June 16th. Left Boston for Providence, R. I., in company with Brother Chas. Scott, I. D. O., we visited the P. I. W. tank job and talked with the men working there and informed them that we would arrange a meeting for them. Also talked with the foreman in charge of this work, Mr. Jack Weaver, then returned to Boston.

June 17th. Went to Providence and visited the jobs being erected by the P. I. W. Company and requested all the men to attend meeting which was held on this date. Brother Scott and myself addressed the meeting which was attended by twenty-eight boilermakers and helpers, some of these men had paid up cards and some were suspended members. After talking the situation over with them and giving them the full particulars of the battle members of our Brotherhood were fighting against this company in the Oklahoma oil fields we got them to strike the two jobs being erected by this company that night. We then returned to Boston.

June 18th. Attended a conference at Boston with the representatives of the Railway

Department of the A. F. of L., who were at Boston. We talked over matters pertaining to the N. Y. N. H. and H. R. R., Boston and Maine and the Maine Central Railroads.

In the evening I left for New York.

June 19-20. In New York. Visited office of District No. 2 and some of the shops.

June 21st. Left New York for Middletown, N. Y. Attended a meeting of the N. Y. Q. and W. Federation. Vice-President Conlen of the Machinists, Vice-President Tobin of the Blacksmiths and I. O. D. Brother Collins Brotherhood of Carmen were present at this meeting. After this meeting we had a conference with the following officials: Mr. Florie, superintendent of Motive Power, Mr. Pohlman, M. M. and Mr. Mitchell, M. M., and opened up negotiations for a new agreement and a general increase of 5c per hour for all crafts.

Brother Chas. Pollock of Lodge No. 400 and Brother Julius Schraft of Lodge No. 396 and myself represented our Brotherhood.

After going over the agreement of the machinists, blacksmiths and boilermakers, Mr. Florie refused to consider the agreement of the Brotherhood of Carmen claiming he had just signed up an agreement with the railroad workers covering the car department, but we got him to agree that if we could show him that the Brotherhood of Carmen represented the majority of men employed in the car department that he would repudiate the agreement signed with the railroad workers. After these conferences we held a meeting of the Federation and decided that the delegates return home to their respective points and canvass the men in the car department to ascertain if the Brotherhood of Carmen had the majority of members.

June 23rd. Left Middletown for New York.

June 24th to July 2nd. Found me at New York visiting the office of District No. 2 daily visiting the shops and works under erection. Also attended meeting of Lodge No. 163; visited sugar house job in Brooklyn where the Lebanon Steel Works are erecting sixteen crystalizers. Talked with men on the job also foreman, Mr. Joe Roberts of Baltimore. Also visited shops at Newark, N. J.

July 3rd. Left New York for Philadelphia, Pa., to meet Vice-President Johnson of the Structural Iron Workers. I met Brother Napier, B. A. of Lodge No. 341, and he gave me full particulars of the work the iron workers were claiming and also informed me that Vice-President Weyand had been in Philadelphia, Pa., trying to locate Vice-President Johnson. I had a talk with Brother M. Canaan, B. A. of the Structural Iron Workers and he did not know where I could locate Vice-President Johnson. I then returned to New York.

July 6th, 7th and 8th. Visited office of District No. 2. Made a visit to Orange, N. J., also Patterson, N. J., in company with Brother Kenneally of Lodge No. 16 trying to locate some work that we were informed was being

erected in both cities. I also attended a regular meeting of District No. 2, and owing to the condition of the various lodges in the district the delegates decided to disband the district lodge temporary, which was done.

July 9th. Left New York for Middletown, N. Y. Attended conference with the officials of the O. & W. Railroad and the vice-presidents who participated in the former conference for the new agreement. After we had Mr. Florie approve of the agreements with the exception of the increase of wages asked for and he also agreed to repudiate the agreement he had with the Richardson's organization and post a set of shop rules which would govern all men employed in the car department. We then requested him to arrange a conference for our committee with Mr. Kerr, president of the O. & W. Railroad, which he did, and we took up the question of increase in wages with Mr. Kerr at his office, New York City.

July 12th. Mr. Canfield, general superintendent of Motive Power, was with Mr. Kerr when we met him and after we had discussed the question of an increase in wages for the men the best we could get Mr. Kerr to do was to agree to have Mr. Florie adjust the rates of wages of the men of the various crafts at the different points this proposition we informed Mr. Kerr we would put up to the men and if they accepted it we would then notify Mr. Florie and arrange for the adjustment of rates.

July 13th. Left New York for Norwich, N. Y., with other officers. Held a joint meeting. Vice-President Tobin who was chairman of our committee placed Mr. Kerr's proposition of an adjustment of rates with some changes in the agreement before the men and the proposition was accepted unanimously.

July 14th. Left Norwich, N. Y., for Middletown, N. Y. Held a joint meeting same as we held at Norwich, N. Y., and Mr. Kerr's proposition was accepted by the men employed at the Middletown shops. We met the officials in conference July 16th.

Those who were present were Mr. Florie, superintendent of Motive Power; Mr. Daly, M. M., Norwich, N. Y.; Mr. Berry, M. M., Mayfield, Pa.; Mr. Mitchell and Mr. Pohlman, M. M., at Middletown, N. Y. After discussing the adjustments in wages which some members of our organization were benefited by an increase in wages from 2c an hour and 3c an hour. Members of the other organization affiliated with the Federation were also benefited. Each committee signed up agreements for one year with the understanding that if conditions warranted a general increase in wages within ninety days that we could serve notice on Mr. Kerr who would gladly open up agreements. Copy of this agreement will be found in this issue of our Journal. While at Middletown I attended a regular meeting of Lodge No. 400. I also visited the O. & W. shops and talked to a boilermaker employed there in regards

to him becoming a member of Lodge No. 400, which he promised me he would.

In the evening of the 16th left Middletown for New York.

July 17th-31st. Found me working in and around District No. 2, Port of New York, visiting the shops and tank jobs under erection and visiting the buildings where our men are employed. Also visited the office of District No. 2 daily. Made several trips to Bayonne, N. J., where the employes of the Standard Oil Company were on strike for a general increase of fifteen per cent. There were about three hundred boilermakers involved in this strike. I tried to organize these men but because of the striking employes returning to work and accepting the companies proposition of an increase from five to twelve per cent, it was impossible to organize these men but some of them, I am glad to say, became members of Lodge No. 607. On July 23rd I installed the officers and obligated members of Lodge No. 607 of Bayonne, N. J., with a membership of thirty-eight, twenty-seven boilermakers and eleven boilermakers' helpers. While holding meetings with the above members of No. 607 we elected temporary officers at one of the meetings and these brothers were all employed by the Standard Oil Company at Bayonne, and am sorry to say they were all discharged, but what else could be expected from the officials of this corporation; and I am glad to report that these brothers secured employment in other shops in this district, and were elected permanent officers of this lodge and there is a great deal of credit due to these brothers for the way they worked to organize Lodge No. 607 in the city of Bayonne.

I also want to thank the members of Lodge No. 176 of Elizabethport, N. J., who assisted me in the installation of officers. I also visited the Warren City tank job at Edgewater, N. J., also visited the shops at Newark, N. J. Attended a meeting at Van Ness, N. Y., of the Electrical Workers at the request of Brother Henderson of Lodge No. 281. Attended meeting of Lodge No. 21. Visited Bartlett, Heywood Company's jobs at 45th St., 65th St. and 207th St.

August 1st. Left New York for Boston, Mass., by request of I. D. O. Brother Chas. Scott.

August 2nd-6th. Found me at Boston assisting Brother Scott and our members who have a tank job tied up at the Boylston Brewery at Jamaica Plains. This Brewery is owned by a Mr. Heffenreifer and the brewer's architect gave a contract for a large tank to the Daniel Russell Boiler Company, who did not employ any members of our organization and who is considered an absolutely unfair shop and Brother Scott refused to permit this company to install this tank in the above named brewery. We had a conference with Mr. Smith, attorney for Mr. Russell, but got no satisfaction from him. We also had conference with Mr. Heffenreifer. We made the following proposition to the Daniel Russell Boiler Company, that

if he would sign an agreement for one year to hire members of our Brotherhood, we would then arrange to adjust the trouble on the Brewery job. I also talked this matter over with Brother Thos. R. Keenan, president of Lodge No. 431 and Brother Hansen, treasurer of Lodge No. 431. I also attended a regular meeting of Lodge No. 585 with Brother Scott and discussed this situation with the members of this lodge. Nine new members were obligated at this meeting and Lodge No. 585 is progressing. Brother William McNabb is B. A. for this lodge and is doing very good work. On the evening of the 6th, left Boston for New York.

August 7th-11th. Found me at New York visiting the shops in District No. 2. Also visited tank job being erected by the Graver Tank Company at Jersey City. This was a strictly union job. Mr. Schumacher was foreman of this work. Also made a trip to Dunnellen, N. J., with a brother member to look up a tank job that I was informed was to be erected at this city. We located a small job that had recently been finished by a Philadelphia company.

On the evening of the 11th, left New York for Boston for the purpose of attending a regular meeting of Lodge No. 431, which was held on August 12th. Brother Scott, I. O. D., also attended this meeting. We discussed the tank job at the Heffenreifer Brewery and the members of this lodge promised us they would not work on this tank. While at Boston Brother Scott, Brother McNabb, B. A. and myself done everything within our power to try and straighten out this situation and inasmuch as Brother Scott has been in charge of situation in Boston I left this matter in his hands.

On the evening of the 17th I left Boston for New York.

August 18th-31st. Found me in Port of New York visiting the various tank jobs under erection and the various shops both marine and contract, talking to delinquent members, prevailing on them to get reinstated in the lodges they were former members of, and I got the promise from several that they would get reinstated, and I am also glad to report that all the members of the various lodges in the Port of New York are working full time and I hope that this will continue as our members have lost considerable time during the past winter. Also visited Public Service power house job at Harrison, N. J., and arranged with the companies who employ our men to pay 20c a day car fare to our members who come from New York, and 10c a day who come from Newark, N. J. Also visited Thompson Press Company at Long Island and stopped four men who were working there for the W. and A. Fletcher Company of Hoboken, N. J., on a repair job. These men were receiving \$3.25 a day for boilermakers and \$1.75 a day for helpers. I had a conference with Mr. Andrew Fletcher and after talking the matter over he agreed to pay these men the outside scale of \$4.25 for boilermakers and \$3.50 for helpers, from the time they started

on the job. I then informed the men to this effect and they returned to work the following morning. I also went to Empire Oil Company plant at Long Island, the P. I. W. Company have one tank to erect there but the iron is not there yet. Also made a visit to Peekskill, N. Y., to try and locate a pipe line job, but was unable to do so as the brother who informed me of this job must have been misinformed himself. I also attended a regular meeting of Lodges No. 45, No. 163 and No. 176.

Also met President Franklin and Brother Scott, I. O. D., at the Continental Hotel and we discussed the situation of the New England states in regards to our Brotherhood. I also visited tank job at the Texas Oil Company at the request of Lodge No. 607, and talked to Superintendent Mr. Wissner, in regards to the grievance the members had and were on strike. Mr. Wissner wanted the men to work all day on Saturday. The rules of this District are that if our members work on Saturday afternoon they must receive double time. This Mr. Wissner would not pay. Brother Martin Gallagher of Lodge No. 607 is the steward on this job and after he, Mr. Wissner and myself had a conference, superintendent agreed to wire office of Ryder Conley Company, Pittsburgh, Pa., who is doing the work and on receiving reply promised to advise us.

On the 31st, President Franklin and myself went to New Haven, Conn., and addressed an open meeting of Lodge No. 61, which was well attended, and I am satisfied that the members of Lodge No. 61 were well pleased with our visit.

September 1st. Returned to New York. Went to Bayonne, N. J., to the Texas Oil Company. Met Mr. Wissner of the Ryder Conley Company and informed me that he was going to grant the half holiday on Saturday and advised all men to return to work.

September 2nd. Received wire from President Franklin to return to New Haven, Conn., which I did and attend a Federation meeting of the N. Y. N. H. & H. R. R. shop employes. The committee had a conference with Mr. Weldon of the Mechanical Department. Mr. Wiley, vice-president of the N. Y. N. H. & H. R. R. At the meeting held after the conference the committee reported that Mr. Weldon and Mr. Wiley requested them to wait a few days and after they had made an investigation they would write Brother Henderson, secretary of Federation, and advise him as to what date they would hold their next conference. The following Vice-Presidents, Conlon of the Machinists; Ryan, Sheet Metal Workers; Bolon, Blacksmiths; Knight, Brotherhood of Carmen, and myself attended the Federation meeting. In the evening left New Haven for New York.

September 3rd to 12th. Within this time I visited several shops in District No. 2, Port of New York, trying to organize the unorganized men employed in these shops and I am glad to say I am making some progress and expect to do better. Visited Power House job at Harrison, N. J., and appointed

Brother John Doyle steward of this job. I also attended special meeting of Lodge No. 16 and Lodge No. 21. Visited tank job Empire State Dairy Company. Also visited office of District No. 2 daily. Visited Bartlett Haywood job at Flushing, L. I., where they have a one million gas holder to build. I placed two stewards on this job at once. Also visited B. & H. Company jobs at W. 65th St. and W. 45th St., and appointed stewards to look after the interests of our Brotherhood on this work. Also attended meeting of the Hudson County Central Labor Union in company with Brother Kenneally. Also attended regular meeting of Lodge No. 607 at Bayonne, N. J. This lodge is progressing nicely; seven new members were initiated. I also wish to report that Standard Oil Company has posted notices in all of their refineries in New Jersey that on September 15th all employes will be given eight hour work day without any reduction in pay. This proves that the recent strike in Bayonne, N. J., at the Standard Oil Company plant was a great help in bringing about the above concessions. The Bartlett Haywood Company are also erecting a gas holder at Hempstead, L. I. and the Dover Boiler Works have several tanks to erect in Park Place, Newark, N. J., this work will start the latter part of this month. The Mexican Petroleum Company's new plant at Warner, N. J. There are several tanks to be erected here as above stated in my report. I am advised that this work will start about the 15th of October. There is, at the present time, quite some work in the marine and contract shops in the Port of New York and we are doing everything to take advantage of this trying to build up and strengthen our organization in this district.

This concludes my report to September 12th, and trust it will be interesting to the rank and file of our Brotherhood. With best wishes and kindest regards to one and all, I remain,

Yours Fraternally,
JOHN J. DOWD,
Sixth I. V. P.

REPORT OF EIGHTH INTERNATIONAL VICE-PRESIDENT JOS. P. RYAN.

Editor Journal:

At the conclusion of my last report, I was engaged in assisting our members on strike at New Orleans, La., in the contract shops, which has been in effect since July 29, 1915. From August 16 to 31 my time was spent in assisting our members on strike, attending meetings daily, also regular meetings of Lodges No. 37, 206 and 442, Metal Trades Council and Central Trades and Labor Council. In connection with above assisted by the local officers, I made several attempts to secure a conference with the New Orleans, Metal Trades Association through communications, to which I received one reply of an evasive nature, and unsatisfactory. Owing to the fact that the president of the N. O. M. T. Association has been out of the city, I am advised no definite action was taken

in regard to our requests for a conference.

August 31, I received two telegrams requesting me to come to Baton Rouge, La., at once. I wired Brother Hinzman for instructions as the newspapers reported a strike of our members at Baton Rouge, La. On that date Brother Hinzman wired me to go at once to Baton Rouge, La., and take charge of the situation. I done so, arriving there Wednesday, September 1. I found that the boiler maker foreman had discharged four of our members claiming they were laying down on their work. He was demanding 275 seven-eights machine drove rivets for a day's work. The work in question was being done on stills under day work arrangement. Two men on a riveting machine. I am advised that our members are handicapped in performing this class of work, as they must build their own scaffold and considerable time is consumed in so doing. Also in fitting up, laying up the iron and preparing the work for riveting. The four men in question have been employed at the refinery for a long time. The youngest in service being six months, the oldest in service five and one-half years. All members of Lodge No. 582.

The four men were discharged Tuesday morning, August 31, shortly after 7 a. m. A committee took the matter up with the officials and the general manager, Mr. Weller, requested two days' time to adjust same. This reply was not in accord with the demands of the men who wanted the four discharged brothers returned to work at once and at 10:30 all of the men walked off the plant, 312 all told. Of this number 100 are members of Lodge No. 582. I attended a special meeting of the strikers Wednesday evening, September 1, at the city hall. Open session, owing to the fact that two-thirds of the men involved were not members of our organization. I arranged with the men for a joint committee and after adjournment I held a regular meeting with our members of Lodge No. 582.

Thursday morning, September 2, the joint committee and myself made arrangements for a conference with General Manager Mr. Weller. He declined to meet with me and in order to place no obstacle in the way of a settlement I agreed to remain off the committee when in conference. The company issued a statement that if the men were not at work Thursday morning, September 2, the plant would be closed. This was not done, however. Thursday evening the joint committee met General Manager Weller, Secretary-Treasurer Gordon and Mr. Moreno, attorney for the company, at the Istrouma Hotel, but were unable to make a satisfactory adjustment. Upon reporting to me of their efforts and being divided as to opinion, I dictated in writing a question as to the four discharged members being returned to work.

Two members of the committee returned to Mr. Weller, but his reply was not satisfactory, as he took the position that their

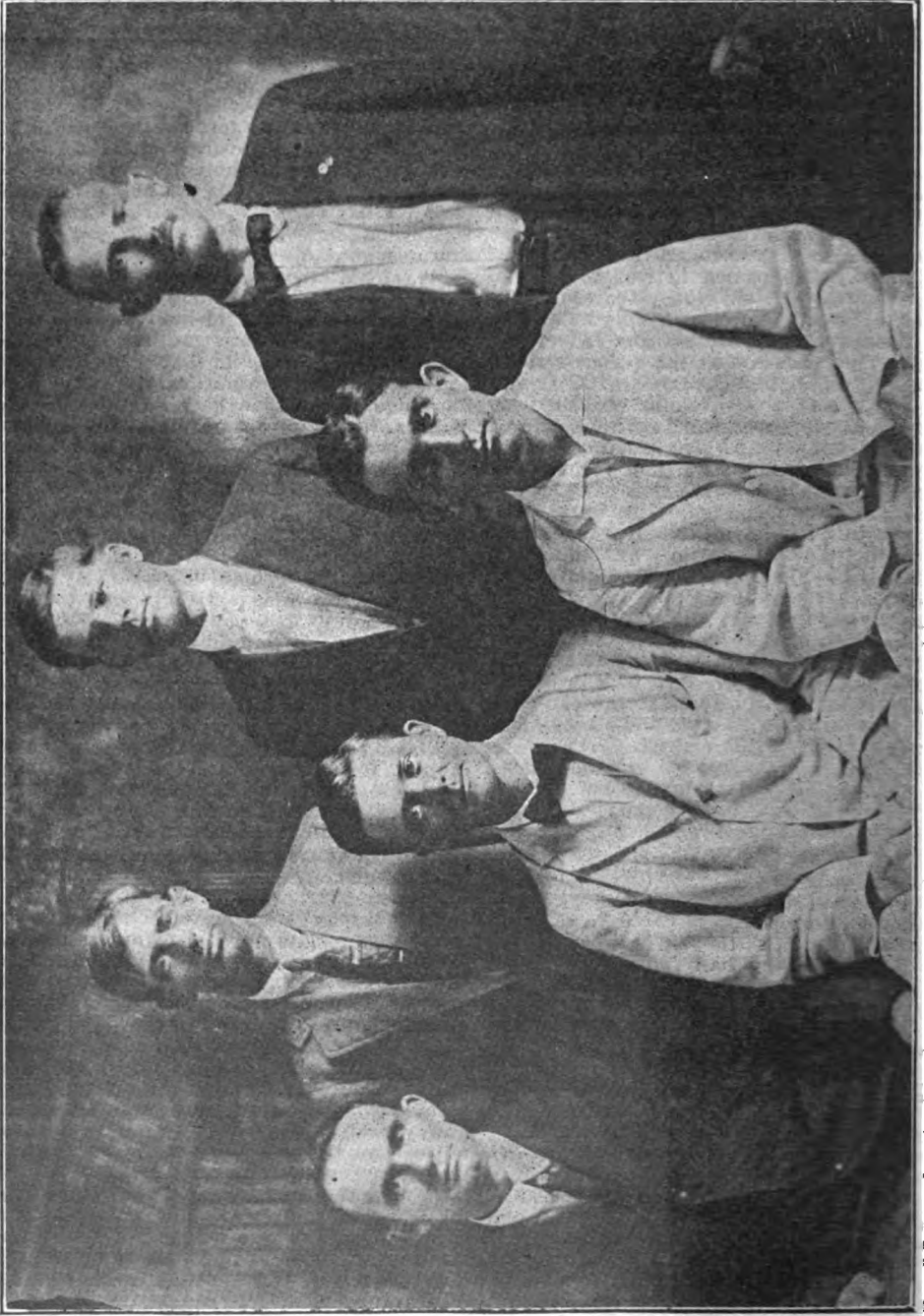

STRIKE ADJUSTMENT COMMITTEE, BATON ROUGE, LA.
Standing, left to right—C. D. Wolff, C. J. Rupp, Geo. A. Wills,
Sitting, left to right—Robt. Phillipa, Dudley L. Weber, Chairman, E. V. Acosta.

cases was a matter that must be left to the company for adjustment. In connection with this he requested that the committee be given full power to act as he had full power to act for the company. On Friday, September 3, at an open meeting the committee reported and their being a sentiment in favor of returning to work, a secret ballot was taken, after considerable discussion. Mr. Weber argued for the return of the men, myself arguing for a rejection of the company's proposition, which I claimed unconditional surrender, and that better concessions would be secured by remaining firm and continuing the strike.

I am pleased to state there were 216 votes cast. We agreed that plain majority would govern. Open meeting, all strikers having equal voting power, organized and unorganized. Tellers and a judge were selected. President Kidd of Lodge No. 582 as judge. Mr. Weber and myself as tellers. The result of the vote was 76 in favor of returning to work under the company's proposition and 140 against and in favor of remaining on strike until more satisfactory concessions were granted. I then submitted in writing two propositions for settlement and the committee returned to Mr. Weller with same and having full power to settle on either proposition. Friday night, or rather 1 o'clock a. m. Saturday, the company posted a notice that beginning September 15, 1915, the refinery would be placed on the eight hour basis with no reduction in wages. The process men to work three shifts, 7 to 3, 3 to 11 and 11 to 7 o'clock, instead of 12 hours as is the present custom. Just prior to this notice being posted a meeting of the process men were held and I addressed them on organization. Tentative plans were agreed on to bring this about. I had also wired machinists' and blacksmiths' headquarters and Brothers Flanagan of the Blacksmiths and McMahon of the Machinists were enroute to Baton Rouge.

On Saturday, September 4, the joint committee again met with General Manager Weller and proposed to discuss the two propositions for settlement. He asked the committee if they had full power to act. They advised him they had as far as they were instructed. Mr. Weller declined to discuss the matter further unless committee were fully empowered to settle the trouble. Again the committee endeavored to get Mr. Weller to permit me to be present, calling his attention to the fact that the company was represented by legal counsel. Mr. Weller refused to meet with me, but agreed to omit Mr. Moreno from the conference, or to allow the committee to have legal counsel with them. At Saturday's meeting, committee reported and in order to remove all obstacles, I recommended to the meeting that committee be given full power to settle with Mr. Weller, inasmuch as he had full power to act for the company. This was done. Nothing was done Sunday and on Labor Day the committee again met with Mr. Weller and Mr. Gordon at the Istroma

Hotel and were in conference three hours. I had previously instructed the committee to stand firm on the four discharged men, as all other grievances were to be adjusted upon the return of the men to work as agreed by Mr. Weller and the committee.

At this conference it was agreed that the cases of the four men would be given thorough investigation by Mr. Weller and that they would be given a chance to appear before him and state their side of the trouble. All other grievances to be taken up after the men returned to work. The committee presented to Mr. Weller copies of agreements which our members enjoy at the Standard Oil refineries at Sugar Creek, Mo., and at Casper, Wyo. Mr. Weller has agreed to investigate same and we are of the opinion that similar agreements can be secured with Mr. Weller at Baton Rouge. Labor Day evening we again met at the city hall in open meeting. On motion the newspaper men were allowed to remain. The committee reported and I was asked to state my views as to accepting or rejecting the committee's report. Realizing the conditions under which the strike occurred and the fact that Mr. Weller had requested two days' time to make adjustment, which was refused him by the men, also the fact that our members had acted hastily and not in accordance with the laws of the Brotherhood in walking off the job, without due process in regard to strikes and owing to the fact that out of 312 men on strike only 109 were members of our organization and taking into consideration the concession granted by the company as to the four men discharged and the granting of the eight-hour work day with nine hours' pay, I recommended to the meeting that the committee's report be concurred in and that all men return to work Tuesday morning, September 7, 1915, and that all grievances be then taken up for adjustment with General Manager Weller.

This was unanimously concurred in and all men returned to work on Tuesday, September 7, 1915. I remained at Baton Rouge until Friday morning. On that date the four discharged members were returned to work by Mr. Weller. On Thursday evening, September 9, I attended a regular meeting of Lodge No. 582 and had the pleasure of obligating twelve new members. Prospects are good for one hundred new members and reinstatements. I requested a special dispensation from the Executive Council for a period of 30 days. Same has been granted Lodge No. 582. Here is what we have gained: Eight hours with nine hours' pay, making the hourly rate 53½ cents for boiler makers, 50 cents for riveters and 37½ cents for helpers. All grievances to be adjusted. Prospects of an agreement similar to Sugar Creek and Casper, Wyo., plants, and a greater organization at Baton Rouge, La. The strike was in effect six calendar days. Went into effect August 31, 1915. Settled Labor Day, September 6, 1915.

I desire at this time to express my appreciation through the Journal, to the men

at Baton Rouge, both members and unorganized, for the manly way they conducted their strike, and for their co-operation with me. I have never met a finer class of men. I also wish to thank the press of Baton Rouge, La., who have been unusually fair in presenting both sides of the strike to the public. I wish to thank Mayor Grouchy and his associate officials for the many courtesies extended, including the use of the city hall for our meetings. The Istrouma Hotel for the courtesy of the conference room, etc. Mr. Weber, who was chairman of the committee deserves the thanks of our entire Brotherhood for the manly and straightforward manner he co-operated with your International vice-president in bringing this to a successful termination. To him and his committee, I extend the thanks of the entire organization.

Brothers, in reading this report, I trust you will see the unusual circumstance. We have been engaged in many strikes during the life of our grand organization. Has there ever been a time when the union men of our movement have received such loyal support from the unorganized worker? The odds being two to one. Yet the unorganized men who struck August 31, at Baton Rouge, La., stood shoulder to shoulder with our members of Lodge No. 582 to right a wrong done four of our brothers, remained on strike with us and returned to work with us, united, bonded together to secure just treatment for union men, unjustly dealt with, firmly united in a COMMON CAUSE. Truly, organized labor's slogan—UNITED WE STAND, DIVIDED WE FALL, was made manifest at Baton Rouge, La., on last LABOR DAY.

On Friday, September 10, I returned to New Orleans and have been engaged assisting our members here since that time. With Brothers Flanagan of the Blacksmiths and McMahon of the Machinists, I have interviewed Mr. Stevans of the New Orleans Metal Trades Association as to securing a conference. We have also seen Mr. Dussell of the Dussell Iron Works. Prospects are that we will soon be granted a conference with the New Orleans Metal Trades Association to discuss terms for a settlement of the present strike here in New Orleans.

There have been NO DESERTIONS from our ranks since my last report and our meetings are well attended and enthusiastic. The members on strike are receiving regular strike benefits and the pickets are doing good work. One of our pickets was recently shot by one of the scabes, but not seriously wounded. We have notified some forty local lodges and district lodges by letter of our trouble here and we again ask that you assist the brothers of Lodges 37, 206 and 442 by keeping our members away from New Orleans and the contract shops. The strike is still on at Murphy's, Dussell's and the Johnson Iron Works in Algiers, La.

In conclusion, I desire to thank the Metal Trades Council, Central Labor Union and Brothers Flanagan of the Blacksmiths and McMahon of the Machinists for their assist-

ance and co-operation tendered your international vice-president, and trusting that my report will prove interesting to the rank and file and with best wishes, I am,

Fraternally yours,

JOS. P. RYAN,

Eighth I. V.-P.

New Orleans, La., Sept. 13, 1915.

REPORT OF NINTH INTERNATIONAL VICE-PRESIDENT SCHMITT.

Herewith submit a general resume of my work:

On March 1 left Louisville for Indianapolis, where I met Brother Frohlinger, and we took up with the officials of the iron workers the question of their members doing the tank work on the Ford Building, also an office building. We were informed that the men had been instructed to get off of the job, but refused to obey the orders, and we were informed that charges would be preferred against the local for insubordination, and seeing that there was nothing that could be done at this time in regard to this work, left for Lima, O., to take up organization work there with the men in the Lima Locomotive Works. After several efforts failed to get the men interested, on Sunday had a meeting of Lodge 259, at which several of the members who were delinquent agreed to pay up.

On the 8th left for Louisville, Ky., to attend a meeting of the Central Labor Council, at which the report of the executive board was to be made as to their findings of the charges against the business agent, who had advised a proprietor of a brewery that it would be all right for him to have boilers built by the Voght Machine Company, providing the same would be erected and installed by union men at the plant. I had secured an affidavit to this effect from the proprietor of the brewery, and other positive evidence, but in the face of this the business agent was exonerated by the executive board and was sustained by the council. The Voght Machine Company being one of the most unfair firms in the city of Louisville.

I then left for Alton, Ill., where I attended a meeting of Lodge 483. At this meeting the question of an agreement with the Wood River Refinery was taken up, and arrangements for a conference with the superintendent. At this conference a working schedule was agreed to, the same to be put into effect by letter from the superintendent to Lodge 483, effective April 1. Owing to the business conditions throughout the country we were unable to get an increase in wages, but were assured that just as soon as the business conditions warranted this would be taken up.

On the 18th left for Detroit, Mich., to join an organizing crew of the railway department to start to work to try to organize and federate the shop crafts on the Michigan Central Railroad. On my arrival met Vice-President Ames of the machinists, Vice-President Van Dornes of the black-

smiths, and Vice-President Ronemus of the railway carmen. We exercised every honorable means possible to get the men interested, and after endeavoring to hold several meetings in Detroit and Jackson we found that it was useless any further. The tactics employed by the company in getting the piece work installed caused distrust and dissension among the men, most of the men falling for the old game for which in time they will pay for dearly, and in the meantime the company will reap the benefit. The organizing crew, therefore, recommended that we be withdrawn from this system, it being the opinion of the organizing crew that from information at hand that the time was opportune to try and organize the B. & O. and B. & O. S. W. system. This recommendation was made to the department, and we received instructions to take up the work on this system. During our time at Detroit we learned that there was introduced in the state legislature a bill to increase the passenger rates. We had several conferences with Attorney Attenza, who agreed to get us a conference with Receiver King of the Pere Marquette R. R., who was the prime mover behind the railroad increase rate bill. We went to Lansing, Mich., the capital of the state, and through the efforts of Attorney Attenza we were promised a conference with General Manager Alfred. We returned to Detroit and prepared for this conference, which was to take place at 2 p. m. April 2, at noon, in an extra edition of a Detroit paper appeared an interview by Receiver King, vilifying us to the limit, which proved to us that we had been double-crossed by Mr. King. We then got out a circular letter to the public and one to all the Central Bodies and locals in the state, urging them to write and wire their respective senators and representatives to oppose the railroad rate increase bill. The letters were indorsed by the Detroit Federation of Labor, and through our efforts the bill was defeated by eight votes, which in figures given out by the officials of the Pere Marquette meant a loss of \$600,000 per year to this unfair road.

On the 9th I left for my home, and on the 12th received instructions to attend a meeting of the Nickel Plate R. R. shopmen at Conneaut, O., on the 13th. Vice-President Horn of the Blacksmiths, Vice-President Ronemus of the Carmen and Deputy Organizer Malloy of the Machinists also were present at this meeting, in which much interest was displayed by the men. I then left for Baltimore, Vice-President Van Dorne having preceded me there, where a meeting that had been arranged by the local men of the Mt. Clare shops had been arranged for the 12th. Vice-President Weyand being in Baltimore attended this meeting; also Vice-President Anderson of the Machinists, a call having been sent out for a meeting of the districts of machinists and boiler makers to be held in Baltimore, to take up

the Emerson system, which was being introduced in some of the shops on the system.

We held a joint meeting and informed the brothers of our plans of work on this system as to organizing a system federation, which met with their approval and assured us of their co-operation, and at this meeting formed a temporary federation. Brother Ronemus of the Carmen also was present at these meetings, and we endeavored to get in touch with the men of the various departments of the Mt. Clare shops, and in spite of the deplorable working conditions, the men did not have the moral courage to exercise their rights as American citizens, and we were unable to do anything in Baltimore, as hirelings of the company went among the men and threatened to discharge men who would attend a meeting, and spotters were around the hotel continually, and men would not come near us, and we decided to work the west end of the system and then return to the east end with an organization, if possible. In a few days we left for Cumberland, Md., to start work there.

While in Baltimore I attended meeting of Lodge No. 193 and assisted Vice-President Weyand in his work of organizing the men at Fairfield, where a new refinery is being built, and quite a number were added to the membership of Lodge No. 193.

On our arrival at Cumberland we proceeded to get in touch with the secretaries of all the locals on the system, sending them forms to fill out for information as to the number of organized men at each point; also the names of the unorganized. The brothers were prompt in getting this information to us, and as we received the lists of names we would send them literature explaining the workings of the Railway Department, and through this plan several lodges increased their membership, as well as new lodges being formed of the various crafts. Through our efforts, we were able to increase the general organization of the shopmen at Cumberland from 15 per cent to about 90 per cent in the face of the strenuous opposition of the company officials, the local of No. 332 being increased from 16 members to 46 members, there being five in the organizing crew, and we at times divided up and held meetings at Conneville, Pa., and Keyser, W. Va., and members were added to all the locals at these points, and as we had sufficient organization at Cumberland we organized a local federation, and we then moved to Keyser, where the largest car repairing shops on the system are located, and on account of the attitude of the company hirelings we were unable to hold any open meetings and were compelled to do work among the men individually and holding meetings with a few men outside of the shops in some vacant space, and special efforts on the part of the company were to keep the carmen from organizing, but the work is being

pushed as rapidly as conditions will permit, and soon hope to be able to visit all points on the system. We also held meetings with the men employed on the Western Maryland R. R.; also attended their system federation meeting and advised with them.

On August 19 I received instructions that if it was possible to proceed to Rocky Mount, N. C., to look after some affairs concerning Local No. 239, without jeopardizing our interests on the B. & O. for days, and as our work was in such shape I left for Rocky Mount after holding two meetings and seeing most all the brothers individually, was able to get the affairs of the local straightened out, and believe that the local will, under the guidance of its officers, do good business.

On the 21st received instructions to attend a mass meeting of the navy yard employes on the 22nd. I left Rocky Mount, Sunday morning, and attended this meeting, which was held in the opera house, and while the band played the house began to fill, and a fair representation of the 3,000 navy yard employes was in attendance. The following crafts had representatives present: Blacksmiths, machinists, boiler makers, carpenters, electricians, plumbers and Sec.-Treas. Berres of the Metal Trades Department. Brother Wilson presided over the meeting. He, in his able manner, introduced Mayor Hope of Portsmouth and the various representatives in turn, who addressed the meeting. Too much praise cannot be given the brothers of the various crafts for their untiring efforts in making this meeting a success, and the results of that meeting in arousing the spirit of organization that for many moons has lain dormant. Since this meeting the ship carpenters, asbestos workers, blacksmiths, riggers and two federal labor locals have been organized, besides added membership to the already organized locals. A meeting of the helpers in the boiler shop was held on last Monday evening, the 13th, and 18 applications were filled out and several more have been secured since, which will mean quite an increase to the membership of 57.

Attended meetings of Lodges No. 57 and No. 428, and pleased to note the progressiveness of the brothers and the manner in which they conduct their business. On account of the Norfolk Southern Federation meeting, did not get to attend a meeting of Lodge No. 298. On Labor Day the three lodges turned out in the Labor Day parade in Norfolk, each lodge having a float, and they made a fine showing and did themselves proud, and was very much pleased to be in line with them.

Upon instructions, I took up work in behalf of Lodge No. 428 that had some few weeks previous presented an agreement to the shop owners of the water front, with Brother Halstead visited all the employers and arranged for a meeting, which was arranged for Thursday afternoon. At the time

set for this meeting only four of the employers were present, and they would not enter into a conference unless all were present. It was agreed that they arrange a meeting, which they did for Friday evening. At this meeting not all were present, but those absent agreed to abide by what was done, and all that they would grant was an increase of 25 cents per day and to continue the present system of working double time for overtime, including holidays and Sundays. On account of having less than half of the shops organized, we were not in a position to force the issue, and the brothers accepted the increase with the intention of trying to organize these shops thoroughly so they will be better fortified the next time they go after an agreement. Also held meetings with men of the chippers, caulkers and fitters of the navy yard, endeavoring to get them interested in organization, and it is to be hoped that in the near future these departments will be thoroughly organized.

There is another feature that I feel I must not neglect saying something about, and that is the commissariat that is being conducted by members of organized labor of Portsmouth. This has been in operation for some time and has proven to be all that is claimed for it, and only members in good standing in their respective organizations can be served, and from information that I have been given, the brothers are able to save about 20 per cent on all purchases made, which amounts to more than twice the amount of dues paid per month in savings, and, further, they are able to get any line of goods that are manufactured bearing the label. If this feature was given more attention, it would be the means of reducing the cost of living, and further would be the means of maintaining and increasing the membership of organized labor.

This concludes my report up to September 16, and having completed my work here, will leave for my home, when I will again take up the work with other representatives on the B. & O.

Respectfully submitted,

J. F. SCHMITT,

International Vice-President.

REPORT OF INTERNATIONAL DEPUTY ORGANIZER JOHN DICK.

Dear Sir and Brother:

I am sending you a report for publication in our official Journal to give the rank and file an idea of the conditions in the Western country as I find them. I am very sorry to say that work has been very slack in California for nine months, and am glad to say it is getting better but very slowly, the only job of importance that has been going on has been at Martinez, where the Dutch Shell Company is building a new oil refinery. There are four companies doing the tank work at present—Lacy Brothers; Lewellen from Los Angeles; the Western Pipe and Steel from Richmond, working

nine hours, and the P. I. W. from Pennsylvania, who are working eight hours. It is very hard to get conditions that we ought to have, as there have been so many idle men around willing to do almost anything the boss wants them to do.

It was reported that I was going to cause a strike on all jobs and in a few days the scabs were coming in on all trains ready for the fray. I thought it would be very foolish to have any trouble, as I knew it would be only throwing a good many of our members out of work and have the scabs take their places. The jobs are wide open for men that will do a good day's work and then some, but you must not talk about the conditions; the boss will allow you to say, "I have a good job, also a good boarding house and the boss is a good fellow." He likes his men so well that he puts up beautiful sleeping quarters; he charges \$1.00 per day for board, and all he will ask you is to have your own blankets. I have seen as many as fifty of our members in Martinez out of work at one time; most of them broke, no place to go to look for work with any chance to get a job at anything; raining every day for weeks at a time. The men who had work were lucky if they had enough to get a shave after the boss got his board money. Lodge No. 317 was very good to the homeless brothers, as they spent \$50 on jungle feeds, also have a meal ticket at Tom Kenny's Hotel, the friend of the boiler makers. Any traveling brother can get a few meals, also one drink, if in good standing; all are made welcome.

Conditions in San Francisco are very bad, also, but picking up. Brother Bowser had his hands full looking after the traveling brothers. From what I hear, he has done good work. I find him a man who is willing to do all he can. I have known him to go out of the city when he thought he could do any good, and pay his own expenses.

Los Angeles is the worst place I have seen in regard to organized labor; all crafts much the same. There are a few good men in Lodge No. 92, doing all they can to better the conditions, but it's a hard proposition, as the workmen are in a peaceful slumber. I don't know if the German army could wake them up. The boss must be throwing gas in their faces when they leave the shops when their day's work is done, to keep them from thinking about their conditions until the whistle blows in the morning. It is very hard to get them interested in unionism.

I was ordered to go to Miami, Ariz., as Lodge No. 187 had considerable trouble with the structural iron workers. When I arrived in Miami I attended a meeting and I am glad to report the trouble was settled in favor of the B. M. & H. Before the meeting was over, the president wanted to know what my expenses were. I didn't know what they meant, but they soon gave me an education on unionism. They claimed as they sent for me they should pay the bill. I could

not see it that way, but I thanked them for their kind offer. I stayed in town a few days, investigating the work that had been done by the structural iron workers. I found they had done a good deal of our work; they had erected two large smokestacks; breeching for a battery of boilers; one water tower; also a few tanks; all of which should be done by members of our organization. I took the grievance up with their acting business agent and he agreed with me, and if the members will do as he thought they should, I look for more harmony between both organizations. It's hard enough to be fighting the boss, but when you have to fight your fellow man we might as well join the trenches and forget it until we are at peace with one another.

The members of Lodge No. 187 were very anxious that I should make a trip to all the mining camps to try and get the men interested in our organization. I went to all the places where I knew there were any boiler makers or helpers employed, and I found a good many ex-members who were only too willing to get reinstated; also a few young boiler makers who were very anxious to join our organization. I did good business and the trip was very successful. I received all the help I needed from the members, also the ex-members. I found conditions good, but I also found in some of the camps that the bosses are very bitter towards organized labor; therefore, I had to be very careful in what I did do. In one place the Mexican miners went out on strike for a raise in wages; the company promised to give them the raise if they didn't organize in that camp.

While in Arizona I found a good many boiler makers on the water wagon. I never saw one take a drink; never saw one throwing distress signals—something unusual for me. One old timer had two bank books. He told me he never had one before; another one told me that a few days after pay day were legal holidays for him, but now he has worked a few months, seven days a week, without missing one day, but at that I would not care to bring them in from Arizona into a wet state to work on a brewery if I was in a hurry to get the job finished, as they can tell some very interesting stories about the capacity they had for beer. I don't want anyone to think that I am preaching temperance, but what I saw in Arizona. I must say the dry proposition is a grand success for the working class.

I received a telegram from Brother Hinzman, advising me to go to Honolulu, as there was considerable work going on and having trouble on all jobs. The Standard Oil Company had built a few tanks, but were finished when I arrived. The company had sent four men from San Francisco, members of Lodge No. 317. They failed to get a C. C. when leaving Richmond; a committee from lodge 204 went to see if they were union

men and when told they were, they wanted to know if they had their C. C. with them. The men, or a couple of them, told the committee they didn't have time to get C. C. The members of Lodge No. 204 didn't think it was right for them to come to Honolulu the way they did. No one can blame them, for that; they are old timers and know better. Two of them were looking for me one day before they sailed to get due stamps. I wasn't in town. They started to see Brother Jones, secretary of Lodge No. 317, but I guess they made a few stops on the way—a boiler maker's fault—and failed to see him. Their intentions were all right. There was some trouble when the job started, as the boss wanted to pay them \$4, when the scale is \$5. It seems the boss told them he would pay the scale, the boss being a member of No. 317. The members thought there would not be any trouble in regard to the conditions. After working a couple of weeks he paid them at the \$4 rate. Brothers John Stack and Fred Douglas quit, but later went back to work at the \$5 rate; in the meantime they had sent for their C. C. and are still members of Lodge No. 204, as they got another job at Hillo, two months' work, \$5 per day. There is one thing I want to let all concerned know: That it's no fault of Brother Jones, secretary of No. 317, as some of them sent him money and he sent it back. At this writing everything is satisfactory.

The government is building a navy yard, including a large dry dock, a good deal of our work going on, but none of our members working on the job. A committee from No. 204 waited on the superintendent, and he told them he would give them the work and pay the scale. There wasn't any boiler makers idle, so it was impossible for No. 204 to furnish the men. The superintendent started to hire anyone that came along. At this time has seven gangs of machine riveters and one caulker. An organizer for the Structural Iron Workers has been here for a few months trying to get control of his work; they have built a few large buildings, including a boiler shop, machine and molding shop, etc., all up-to-date machinery. It looks to me as if there will be a few boiler makers employed when ready, but I think it will be some time before the shop will be running. Most of these shops were put up with cheap labor. A good many Japs were employed. The organizer for the Structural Iron Workers got busy and organized a good many of the handy men and claimed some of our work. The superintendent refused to deal with them. Now the job is unfair. This all happened before I arrived. Brother Lane and myself waited on the foreman, also the superintendent, to see if he would put some of the men to work, as there were a few idle. The superintendent told us to come back in a few days. The next day there was trouble; one of the unfair men got hit. They arrested the or-

ganizer. If they can put him away, I guess they will; but they haven't proved it yet. I and Brother Lane met the superintendent again and he was very angry on account of the trouble. He told us it was impossible for him to do anything until the case was settled.

The conditions for boiler makers are very good; as for the helpers, they are very bad, mostly natives; I find them a quiet race of people; some of them are very bright. What they need is education in unionism. I am trying to get the best of them in our organization, and the boiler makers in the shops are talking to them, so at the next meeting I am satisfied there will be a few for initiation.

I want to say for the benefit of the brothers in the States that the members of No. 204 are willing and doing all they can to get the helpers organized, also they are doing all they can to get control of the outside work in all its branches. It is very hard to get the men to fill up a job when it starts up such as a tank job, but I think No. 204 will be able to overcome it in the future. Brother Lane spent two weeks with me; every day he did all in his power to help me and give me some good information. I got here in time to attend a meeting where they had refreshments. Brother Tommy Murry thought he was making so much money that he invested in a house and lot, also a partner for life; he bought the beer, not in kegs but in bags. I thought it was coal they were bringing in. We all had a nice time. I wish them all the happiness, etc., but I hope he doesn't raise his boy to be a boiler maker.

The boys are getting ready to have a good time Labor Day and I believe it will be a grand affair, as at this writing there are eight boiler makers from San Francisco who were shipped down under very good conditions, first class passage, traveling time both ways; expect to be here a few months; all had clearance cards. They are a fine bunch of fellows and are having a good time.

I want to thank the officers and members of Lodge No. 204 for the good treatment I have received; also the brothers I have met in Arizona, also California.

Just a few words about myself. I am very glad to say I am a member of our organization for twenty-five years. I have paid all dues and assessments and I know it's the best investment I have ever made. I was always an organizer and I hope and intend to be one as long as I am able to get around. I would like to see more organizers in the rank and file; if the members would only do a little bit it would not take very long before we would have all the boiler makers, iron ship builders and helpers organized. Then we would be able to get what belonged to us.

With best wishes, I remain
Yours fraternally,

JOHN DICK.

Agreements

AGREEMENT BETWEEN THE SAVANNAH & NORTHWESTERN RAILROAD COMPANY AND ITS BOILER MAKERS AND APPRENTICES, MACHINISTS AND APPRENTICES, CARMEN AND APPRENTICES.

Rule No. 1. Nine hours shall constitute a standard day's work.

Rule No. 2. All time worked in excess of nine hours shall be paid for at the rate of time and one half. Sundays and legal holidays shall be paid for at time and one-half, when men are required to work. Legal holidays shall consist of New Year's, Washington's Birthday, Memorial Day, July Fourth, Labor Day, Thanksgiving Day and Christmas. When the shops are working short time the men will be paid time and one-half if required to work after bulletin hours.

Rule No. 3. If a mechanic is called to work overtime, he shall be paid not less than five hours, equal to three hours and twenty minutes straight time and shall only be required to do the job for which he was called.

Rule No. 4. Apprentices will not be sent out on the road to work unless accompanied by a mechanic of his craft.

Rule No. 5. When overtime work is required and the work is such that some mechanic of that craft is regularly assigned thereto or has commenced work thereon, this same man shall continue at or be called for this work when available.

Rule No. 6. General overtime will be divided as nearly equally as possible among the mechanics of that craft.

Rule No. 7. No mechanic will be laid off any hour of the regular time to equalize time on account of having worked overtime.

Rule No. 8. In case overtime work is required, the foreman in charge will give due consideration to men who may have sickness or important engagements and in such cases will try to afford relief.

Rule No. 9. When mechanics are sent out on the road to work they shall be paid at the rate of time and one-half from the time they are due to leave their home station until they return. They shall pay their own expenses. Wreck crew shall receive day's wages and expenses.

Rule No. 10. Mechanics attending court for the company will be paid a standard day's wage for each day away from their work and including Sundays and holidays and will be allowed \$1.50 per day for expenses.

Rule No. 11. Any mechanic or apprentice believing himself to have been unfairly treated shall first make an effort to have his grievance corrected by personal appeal to his foreman. Failing in this, he may present his case through the local representative to the master mechanic. Failing in this, he may have his case handled by a committee with the highest officials of the company.

Rule No. 12. No mechanic shall be discriminated against who from time to time represented the men on investigating committees or shop committees when duly authorized by the men.

Rule No. 13. There will be no objection to the committee, when adjusting a grievance, having present their chairman of Adjusting Board with the master mechanic, said chairman being an acceptable representative to the company. There will also be no objection to the chairman of the committee having a few minutes' conversation with the foreman or master mechanic in regards to the shop management.

Rule No. 14. There may be one apprentice in each craft for the shop and not more than one for each five mechanics employed.

Rule No. 15—Ice water shall be furnished during the entire day during such parts of the year as may be necessary.

Rule No. 16. Should a vacancy in a foremanship occur, it shall be filled by seniority from among the employes if competent.

Rule No. 17. Should a mechanic be discharged and afterward found to have been unjustly discharged he shall be reinstated and paid for all time lost.

Rule No. 18. Should it become necessary to reduce expenses, the time will be reduced until forty hours per week are reached. Any further reduction that may be necessary will be made by reducing the force, in which case the last man employed shall be the first one laid off. Men laid off shall be given preference in re-employment. When reduction is made the working hours will be reduced from the last hour in the work day. Vacancies occurring when working under reduced time may be filled by re-employing men laid off. Apprentices will be laid off to preserve the ratio.

Rule No. 19. Helpers will not be allowed to do mechanics' work.

Rule No. 20. Boilers will only be inspected by boiler makers.

Rule No. 21. Rates of pay shall be as follows:

	Per Hour
Boiler Makers	\$0.32½
Machinist35
Coach Carpenters27½
Car Inspectors27½
Car Repairers22½
Car Repairers17½

Rule No. 22. Above rules and regulations affecting shop mechanics effective March 15, 1915, and in vogue until September 15, 1915, a period of six months.

Signed: C. E. GAY, JR.,
V. M. P. & G. M., For Savannah & Northwestern Railway.

Signed: H. L. MORSE,
Chairman,
C. W. HODGE,
J. DARNSDORFF,
Committee.

AGREEMENT BETWEEN I. A. OF MACHINISTS AND HELPERS, B. OF BLACKSMITHS AND HELPERS, I. B. OF BOILERMAKERS, THEIR HELPERS AND APPRENTICES, AND THE NEW YORK, ONTARIO AND WESTERN RAILWAY.

Article I.

Nine hours shall constitute a day or night's work for all men covered by this agreement, except roundhouse men.

Article II.

Section 1. All overtime shall be paid for at the rate of time and one-half, this to include Sundays and all National holidays. National holidays to consist of New Year's Day, Washington's Birthday, Decoration Day, Christmas, and all those holidays in Pennsylvania observed heretofore shall be observed in future.

When a holiday falls on Sunday, the following day to be observed, this to include men working at night. Men detained one and one-half hours during the week (excepting Saturday) and on Saturday one hour after regular working hours, shall receive not less than five (5) hours for time worked up to three hours and twenty minutes. Men called after regular working hours shall receive not less than five (5) hours for all time worked up to three hours and twenty minutes.

Twelve (12) hours shall constitute a night's work for all roundhouse men. Men shall not be compelled to lose time to equalize overtime.

Sec. 2. An employees' bulletin board shall be erected in each department.

Article III.

There may be one apprentice to each shop regardless of the number of journeymen mechanics and not more than one apprentice to each five journeymen mechanics. The ages of apprentices shall be between the ages of sixteen and twenty-one years of age. The railroad company shall furnish proper opportunities for apprentices to serve varied and complete experience during their apprenticeship.

Article IV.

All employees and those depending on them for support will enjoy the same privileges in connection with free transportation that are granted to the Transportation Department.

Article V.

The company will in no way discriminate against any committeemen who from time to time are elected to represent them.

Article VI.

Sec. 1. Should it become necessary to reduce expenses, the present men shall be retained and reduction made in working hours until the hours have reached forty hours per

week. Should any further reduction become necessary, the forces shall be reduced and the last men employed shall be the first laid off. Laid off men shall be given preference of re-employment. Seniority to prevail. The company will not increase hours until all men laid off are re-employed, if available, same ratio of apprentices to be maintained. The company shall not increase the force until schedule of working hours are restored.

Sec. 2. Twenty-four (24) hours notice will be posted in shops and roundhouses of the company before any reduction in the force or hours become effective.

Article VII.

The mechanics sent out on the road shall receive full time and overtime according to regular hours at home stations, and in addition all necessary expenses.

Article VIII.

If circumstances require that the company shall reduce the regular working hours, overtime shall commence at the expiration of the hours designated by the company.

Article IX.

Sec. 1. A suitable place shall be provided in each department for drinking purposes and sufficient ice shall be provided for cooling same. All closets and pits shall be kept in a clean and sanitary condition. Also to have an opening at some convenient place to allow men to go to and from work.

Sec. 2. Five minutes shall be allowed previous to quitting time for purpose of making out time cards.

Article X.

It is understood that all the crafts at any back shop shall commence work at the same time, and all the crafts at the roundhouse shall commence work at the same time, but it is not necessary that the back shop and roundhouse start at the same time. This to apply to day and night shifts.

Article XI.

All men placed on a job paying a higher rate than his regular job for ten (10) days or longer shall receive the rate of pay of the higher rated job from the time of starting.

BOILERMAKERS' SHOP RULES.

Article XII.

Sec. 1. All work such as cutting apart, marking off, or laying out any work pertaining to steam, air, water and oil tight boilers and tanks, laying out and building up any sheet iron or steel gauge No. 16 and upwards, boiler inspection and testing, flanging, patching, riveting, chipping, caulking, electric and acetylene cutting and welding, putting in and taking out flues, taking out, tapping and putting staybolts and driving them, run all pneumatic hammers and do all drilling for patches, repair ashpan, remove and replace caps on flexible staybolts, ex-

cept the hoppers and cast iron work on ash-pans to remain the same as before; all the above work to be performed by boilermakers or apprentices. Spark arrestors to remain the same.

Sec. 2. One boilermaker and one apprentice or helper shall propel each long stroke pneumatic hammer in all riveting of rivets and bolts $\frac{1}{4}$ stock and upwards, on steam, air, water and oil tight work.

Sec. 3. All road work shall be done by boilermakers or flue rollers.

Article XIII.

The company shall not discriminate against any boilermaker or helper who from time to time represent other boilermakers or helpers as committeemen, and will grant them leave of absence, and will furnish them transportation over its lines should they be delegated to go before the management to adjust grievance. In the event of a workman having a grievance, he shall make an effort on his own part to adjust the same with his foreman, and in the event this decision is unsatisfactory, an appeal will be made through the shop committee to the succeeding higher official.

Article XIV.

An apprentice engaging himself to learn the boilermaker's trade must be between the ages of sixteen and twenty-one (21) years (except helper apprentices and their ages will be between sixteen and thirty) and shall serve a term of four (4) years of two hundred and ninety (290) days per year, and shall be given an opportunity to learn branches of the trade, and shall not be kept on any one class of work more than six months at any one time. At the expiration of this time, he shall receive the minimum rate of pay at the place of employment.

Boilermakers having served in the company's service three (3) months, or more upon leaving the service shall be given a clearance. Boilermakers' apprentices, completing a full term, or leaving the service by reduction of forces, shall be given a clearance. If within the first six (6) months an apprentice shows no aptitude to learn the trade, the company shall have the privilege of dismissing him.

Article XV.

Should a boilermaker, helper or apprentice believe he has been unjustly suspended or dismissed, he shall within five (5) days, in proper order, present his case to the company and if it is then found that he has been unjustly dealt with, he shall be reinstated and allowed full pay for time lost; grievances to be adjusted on the company's time.

Article XVI.

Sec. 1. Overtime to be divided equally between boilermakers and helpers, and a list to be placed in foreman's office. Men to take their turn in rotation as far as possible.

Sec. 2. Boilermakers working overtime shall retain their regular helpers.

Article XVII.

Fifty per cent (50%) of the apprentices are to be taken from the helpers who have been employed in the boiler shop for two (2) years or more. Helpers promoted to apprenticeship shall receive helper's pay for the first six (6) months, and if he shows no aptitude to learn, he shall be placed back in his former position. If retained as an apprentice, he shall receive two cents (2c) per hour increase for the following six (6) months, and be advanced each year two cents (2c) per hour until the end of four (4) years, and if retained in the service of the company, shall receive the minimum rate of wages.

Article XVIII.

Helpers and laborers shall not be permitted to do boilermaker's work or to be advanced to the detriment of the apprentice or boilermaker. Roundhouse boilermaker's helpers shall receive minimum rate of wages that is received by helpers in the boiler department.

Article XIX.

The apprentices rate per hour shall be as follows:

First year, 12c	Third year, 17c
Second year, 14c	Fourth year, 21c

After the expiration of four (4) years, they will receive the minimum rate of wages.

Article XX.

If any changes should occur in shop forces, the oldest men are to have the preference.

Article XXI.

Boilermakers who, by their long and faithful service in the employ of this company, have become unable to handle the heavy work to advantage, shall be given preference of such light work as they are competent to handle.

Article XXII.

These rules and regulations shall take effect July 16, 1915, and remain in force until revised. Should any change be desired by either the management or mechanics, thirty (30) days' written notice is to be given.

Article XXIII.

The minimum rate of wages for boilermakers shall be not less than 31c; no boilermaker to be employed for the minimum rate of wages. The minimum rate of wages for boilermaker's helpers shall be not less than 19c per hour.

Article XXIV.

The Representative of the International Brotherhood of Boilermakers, Iron Shipbuilders, and Helpers of America, will be recognized as committees by the officials of the New York, Ontario & Western Railway Company.

B. F. FLORY,
Supt. of Motive Power.

John J. Dowd, 6th I. V. P.
Julius Schraft,
Luke Holland,
Chas. H. Pollock.

Correspondence.

Springfield, Mo.

Dear Sir and Brother:

I wish to write a few lines for publication in the Journal, on account of having been asked, with other districts and locals that have been receiving support from the Grand Lodge, by Local Lodge No. 25 of San Francisco, Calif., to contribute an article for this month's Journal, protesting against the way in which the Grand Lodge is using our money.

I am glad and take great pleasure in writing this article on the manner in which our International officers are handling the financial part of their business and keeping things moving along smoothly and nicely, regardless of the depressing conditions generally throughout the country. But I am afraid No. 25 will be disappointed in the few words I am saying, as I have no complaint or protest to make, as I and District No. 23 believe in living up to and abiding by our Grand Lodge constitution and by-laws, just as our International officers, by their actions, prove they do.

When you take into consideration the conditions of the country now and a year ago; see what our membership is now and what it was a year ago; also take note of the number of out of work stamps that have been purchased within the past year; the number of strikes that have been prevented by our Grand Lodge officers at points where there never has been a business agent, it seems to me we cannot help but take our hats off to our worthy International officers and congratulate them upon their ability to do the most good possible with the funds obtainable. I will also ask Lodge No. 25 to kindly look into the number of reinstatements that the International Deputy Organizers have received, as well as the number of agreements they have signed up, and the many grievances they have settled.

I believe in all of us living up to the constitution and by-laws that were made and adopted by delegates to the convention until we hold another convention, and I hardly think it practical, just because some individual or local is dissatisfied over the failure of getting some resolution through at the convention, that the whole organization should be disrupted, the Grand Lodge officers taken off their jobs, and the whole thing reorganized and rearranged, to please those who voted the minority vote at the convention. I am sorry No. 25 looks at this inconvenience to the few districts whose support from the Grand Lodge has been discontinued for two months, in such a light as to deem it necessary to write letters to all districts thus affected, asking for remonstrances. While District No. 23 appreciates the support coming from the Grand Lodge, we feel that our International offi-

cers are conscientiously using all moneys in a manner which they deem will do the most good to the largest number of the members of our Brotherhood, and we appreciate their position at the present time when funds are getting low, and will do everything within our power to help along the good work which they have been and are doing. We realize the fact that one good "boost" is worth a dozen "kicks" and District No. 23 would much prefer being placed in the ranks of the boosters than the knockers.

I will close by saying that my district intends to stand back of the Grand Lodge officers and give them every little boost they can, so long as they continue in the way they have been going, and I trust No. 25, after thinking over the question and considering it from every angle, will reconsider and come over and join the "boosters" ranks and help build up our organization and encourage our worthy superior officers.

Thanking you for the space you have given me, I am

Yours fraternally,
A. F. BINGHAM,
Pres. & B. A. Dist. No. 23.

Vinita, Okla.

Dear Sir and Brother:

In regard to the oil field strike in Cushing, Okla., last winter and the reasons that Brother Dixon gave in regard to drink being one of the causes for a whole lot of the trouble: That part is all so, but in regard to ignorance I might say that we had a bunch of brothers for officers that were supposed not to be drinking men. They made a new law every time they had a meeting, and in two weeks' time turned around and did the opposite and then, of course, the drink was the blame for the whole thing.

Now in regard to us drunks, myself included, I will say that when these men that don't call themselves drinking men were in Chicago and St. Louis working for about \$3.75 to \$4 per day, we drunks were riding from Oklahoma to Louisiana on freight trains, trying to get the wages up to where they are now, and what was the outcome? They got just as much benefit out of it as we did and are doing so now, which, of course, is their privilege.

Now let us take the mistake in regard to the coffee and food. If the coffee and food didn't suit, there would be a strike, and, of course, the drunks would have to do it, for the men that didn't drink were afraid to say a word, but when it was all over they would come and pat the drunks on the shoulder and say, "Good for you; we are getting better grub since we pulled the strike."

Now take it on the hand in regard to going on strike for overtime on a job. When

that would be done and they got it, we drunks didn't get any benefit out of it. We got fired and made it good for the brothers from elsewhere that don't drink at all. Now, Mr. Editor, I know just what I am talking about, for I was running a crew all last summer and have one now, and all good card brothers on it, too, and one more thing about them—they are all A No. 1 good boozehisters.

Hoping to see this in your next month's Journal, I beg to remain

Fraternally,

GEO. O'BRIEN, L. 592.

The barbecue consisted of 1,500 pounds of roast beef, one ox roasted on the grounds. The Fairbury Tea and Coffee Company served the coffee, using two hundred fifty pounds.

The speakers of the day were George W. Pring of Dea Moines, Ia., president and business agent of District Lodge No. 10, who spoke on labor to a crowd of 6,000 people. Brother Pring was also one of the judges of the floats and was instrumental in awarding the boiler makers first prize on the best mechanical float.

S. R. McKelvie, ex-lieutenant governor and

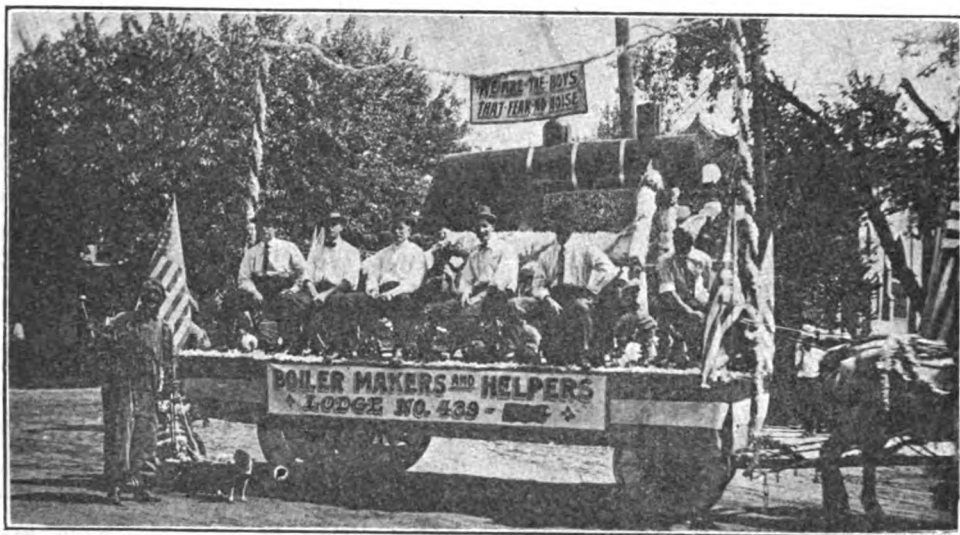

FLOAT AND GROUP OF THE MEMBERS OF LODGE NO. 439, FAIRBURY, NEB., LABOR DAY, 1915, WHICH CAPTURED FIRST PRIZE IN THE PARADE.

Fairbury, Neb.

Editor Boiler Makers' Journal,
Kansas City, Kas.

Dear Sir and Brother:

Inclosed you will find the picture of boiler makers' and helpers' float which captured first prize at the Labor and Fraternal Picnic, Labor Day, September 6, 1915.

The members of No. 439 all feel proud of the float and worked hard in the building and decorating of it.

The following members shown on the picture from left to right are: O. W. Newkirk, Floyd Ellsworth, Fred Cutbirth, P. F. Mad-den and B. Z. Millikan.

The fellow with the dog and cart shown in the picture has a sign on his back representing the machinists of Fairbury.

The parade was like a circus parade, a little late in starting and well worth seeing, with numbers of mechanical and fraternal floats, including horseback riders, clowns and funny stunts, extended for a distance of several blocks and was headed by the Fairbury Band.

publisher of the Nebraska Farmer, was the speaker for the evening program.

Hoping you will have space to publish this in the Journal, with kind regards, I beg leave to remain

Yours fraternally,

B. Z. MILLIKAN,
Secretary Lodge No. 439.

Deer Lodge, Mont.

Dear Sir and Brother: This is to inform you that our Vice-President Brother Frank Brown, received the sad news of the death of his dear mother who resided in San Luis Obispo, Cal. The death of Brother Brown's mother was a shock to him I am sure, as I am informed it was rather unexpected. The officers and members of Mount Powell Lodge No. 528 extend to Brother Brown their heartfelt sympathy in this his hour of sorrow.

Fraternally,

C. P. HOZIEA,
LAWRENCE DE PORTER,
Committee.

Shawnee, Okla.

Dear Sir and Brother: Allow me to present you some pictures of our Labor Day celebration in Shawnee, Okla., for the Journal. The pictures were taken by Brother Ira J. Hunt. The boilermakers, helpers and ap-

the boilermakers made a noise is putting it mild, they surely woke up the town. Next in line came the brothers in line of march in uniforms of dark pants, white shirts and black hats with badges and canes and they made a grand appearance.



A GROUP OF MEMBERS OF LODGE NO. 293, SHAWNEE, OKLA., IN LABOR DAY PARADE.

prentices with our Worthy President Floyd Ott, as marshal and Brothers E. C. Hall, L. W. Hanna, E. J. Vandever and Charlie Siler, as committee on arrangements. Our division consisted of Brother Warren Davis and G. C. Cooper, carrying Lodge No. 293 banner.

The night force of boilermakers and helpers followed in automobiles decorated with flags and bunting with Brother Ike Pasley at the wheel. The parade was a grand success.

After dinner we went to Benson Park

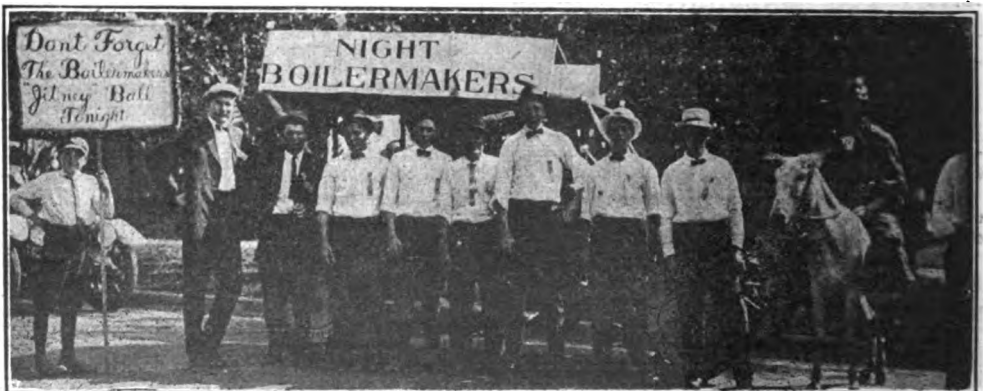

NIGHT BOILER MAKERS' LODGE NO. 293, SHAWNEE, OKLA., IN LABOR DAY PARADE.

Float with Brothers E. C. Hall, A. D. Ross, Jessie Logan, James Millet, Lew Hanna, Victor Perry, Harry Lindsay and Rivet Boy.

We had two gangs of riveters and one gang of caulkers, and Brother E. C. Hall operating actelyene welder and forge. A regular boiler shop on the float and to say

where there was all kinds of amusements and a basket picnic and fireworks at night and a sham naval battle on the river and all our members and families enjoyed the good time. After supper we gave a jitney ball at Chrisney Hall, which was something new for Shawnee and was a fitting and

novel entertainment to end Labor Day. The dance was participated in by many of the brothers, their families, sweethearts and friends. Each dance cost five cents and there was 30 dances and almost every dance called for an encore. Mrs. Brown at the piano and Mr. Cunningham, drummer furnished music for the evening. Much credit was due for the success of the affair to the entertainment committee, Brothers E. C. Hall, L. G. Hanna, Jas. Vandever, A. L. Horne and Floyd Ott. The brothers of Lodge No. 293 feel justly proud of the showing we all made in the day's celebration. United we stand and united we march in honor of Labor Day.

With best wishes, for our present and future success, I am,

Fraternally yours,
A. D. ROSS, S. 293.

San Francisco, Cal.

Dear Sirs and Brothers: At a regular meeting of Lodge No. 25, I. B. B. M. & I. S. B. of A., the following resolution was unanimously adopted; and an order was made that a copy of the same be sent to the Editor of the Journal, so that the same can be published in our Official Journal.

Whereas, our Executive Council has withdrawn the support of the Business Agents of the nineteen cities that had these Business Agents; and,

Whereas, in summarizing the expense account of the Second Quarter, 1915, we find that our International Officers, excluding the International Secretary-Treasurer has received the total of \$6,983.47, or an average of \$232.78 per month for each International Officer; and the International Deputy Organizers have received \$2,006.51, an average of \$222.95 per month each; and the Special Deputy Organizers have received \$375.49, making a full total of \$9,365.47 paid to these Officers in (3) three months; and,

Whereas, we find that the nineteen Business Agents received \$1,570.00 for three months, or an average of \$27.54 per month; and,

Whereas, these Business Agents can accomplish 100 per cent better results in their own locality, than any International Officer can accomplish; and,

Whereas, the money paid to International Officers as shown above, would pay the sum of \$50.00 per month to sixty-two Business Agents, and would therefore increase our membership 300 per cent; and,

Whereas, San Francisco has 525 Organized Members, and our Executive Council has seen fit to withdraw the \$50.00 per month support to our Business Agent, which only amounts to \$.095 per month on the whole membership of San Francisco; therefore, be it resolved, by San Francisco Lodge No. 25, I. B. B. M. & I. S. B. & H. of A. that if our Executive Council does not curtail its expenses, and if they do not restore the support of the Business Agent, and pay the money that is due to us, that we shall invoke the Referendum, and endeavor to

abolish some of the International Officers, and then pay Business Agents in cities having 200 or more members, and thereby build up our Organization.

Anxiously awaiting this publication in the Journal, we remain,

Yours fraternally,

THOS. J. SHERIDAN,
Secretary-Treasurer.

San Francisco Lodge No. 25.



A PROMISING YOUNG SON OF BRO. A. E. STRODE, COR. SEC'Y OF LODGE NO. 150, CHAMPAIGN, ILL.

Pueblo, Colo.

Whereas, It has pleased the Heavenly Father, in His infinite wisdom, to remove from our midst, the dearly beloved mother of our worthy and esteemed brother, Peter Winters; therefore, be it

Resolved, That we, his fellow brothers, extend to our worthy brother our heartfelt sympathy in this sad hour of bereavement, and pray that God may sustain him under this heavy affliction; and be it further

Resolved, That a copy of these resolutions be spread on the minutes of our meeting and a copy be sent to our bereaved brother, and a copy be forwarded to our official Journal for publication.

GEORGE S. WARDEN,
GEORGE D. HILBERT,
GEORGE R. HICKS,
Committee.

Kansas City, Kas.

Dear Sir and Brother:

This is to inform the brothers of the locals over the country that contributed to the raffle held for the benefit of Brother Albert Stone that the drawing took place in our lodge room September 14. The lucky number was 1253, held by a member of Lodge 340 of Herington, Kas. His name is Harry Sanguin. We congratulate the brother, as the watch is a good one. We also tender a vote of thanks to every local who contributed to this cause, and also the brothers at large. With many thanks to all and with best wishes, I am,

Fraternally,

FRANK STOVER,
C. F. S., L. 83.

make out a report, every month as to conditions in his territory, how business is, as we have nine international vice-presidents and not half of them send in reports to the Journal, every month which I think they ought to do, as they are on a salary and it would not take much of their time.

I don't know how many business agents there are throughout the country, if just half of them would send a report to the Journal about the conditions as they are in their jurisdiction once in a while it would be better for all of us, and especially to the traveling brothers to keep them posted about the conditions as they are. All the railroads that are organized have a business agent, and if they send a report to the Journal once every two months it would be a great help

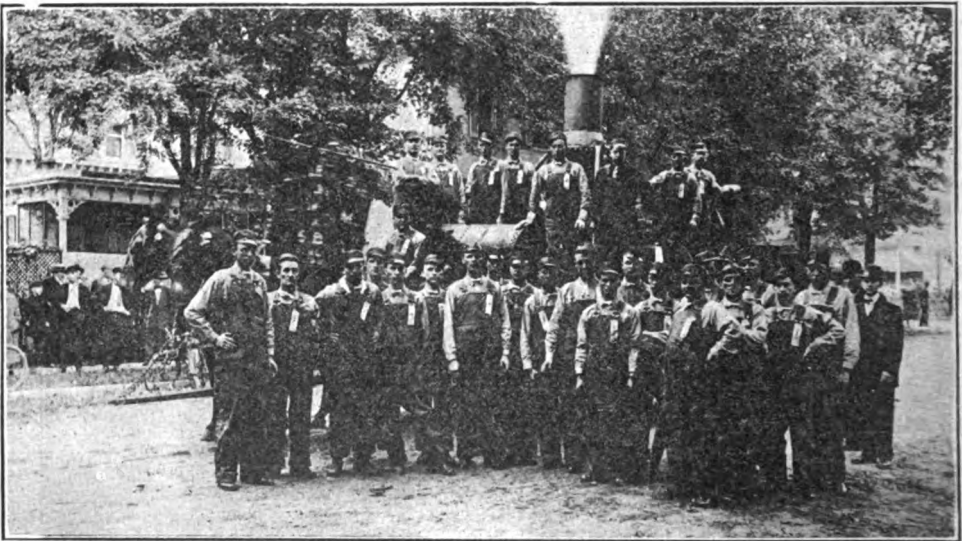

A GROUP OF THE MEMBERS OF LODGE NO. 384, PERU, IND., IN LABOR DAY PARADE, SEPT. 6, 1915.

Grand Rapids, Michigan.

The following resolutions were adopted by Grand River Lodge No. 84:

Whereas, it has pleased Almighty God, in His Divine wisdom, to remove from our midst the beloved Husband, Father and Brother, Frank Zindal.

Resolved, that we, his fellow brethren, extend our heartfelt sympathy in their sad hour of bereavement, and pray that God may comfort and console them.

Resolved, that a copy be sent to the family, one to the Journal for publication, and one be spread on our minutes of our meetings.

NELSON M. WARREN,
FRANK LEMKE,
JOS. SUTCLIFFE,

Committee.

Atchison, Kans.

Dear Sir and Brother: I thought I would write a few words in regard to our Journal. I think that each vice-president should

to traveling brothers, as I think the boomers are a great help to get conditions all over the country, but the home-guards have to hold them, so give them both their rights, as it is said a setting hen never gets fat and a rolling stone never gathers no moss.

The boomer jumps out of a box car one day and the next day he is talking seniority in the shop, that is if he lands a job, it is a round table but a square game. I am on the Missouri Pacific here at Atchison, and business is poor, four B. M. and five B. M. helpers at this point, have been on 7 hours per day for the last two years with poor prospects for anything better very soon, but a loaf is better than no bread at all as there are a great many brothers worse off than we are here, so let us be thankful for what we have. I remain,

Yours fraternally,

JOHN J. FREIBOTT,
C. S. L. 507.

Fairbury, Neb.

Dear Sir and Brother:

Will you please have the attached newspaper clipping in regard to Brother George W. Pring's speech Labor Day published in the Journal, and oblige,

Yours fraternally,

B. Z. MILLIKAN, S. L. 439.

Mr. Pring's Speech.

The speech of George W. Pring, Vice-President of the Railway Department of the American Federation of Labor, at the tabernacle on Labor Day, has been the subject of considerable comment among the large number of Rock Island employes, as well as others, who were fortunate enough to hear his talk. For the past six or seven years, Mr. Pring, in the capacity of general chairman of the Rock Island boiler makers, has been a frequent visitor at the Rock Island shops at Fairbury and, therefore, he had a large circle of acquaintances who looked forward to his talk with great interest.

Mr. Pring devoted his speech to labor and told of the benefit of organization and the advancement and dignity of labor in the last few years. He brought out a number of remarkable facts, which his listeners have been discussing this week.

Mr. Pring made a favorable impression here. The Rock Island boiler makers and helpers are strong for Mr. Pring, as they realize he is their friend and champion in every just cause and has won a great many victories for organized labor. He was formerly a boiler maker in the Rock Island shops at Valley Junction, Ia., but now confines his entire time and attention to looking after committee work for the Rock Island boiler makers and helpers. Mr. Pring is clean, energetic and absolutely fearless in his cause.

The Rock Island boiler makers and helpers had the distinction of walking away with the \$5 prize for the best mechanical float exhibited in the Labor Day parade. The miniature boiler shown on the float was a dandy.

Decatur, Ill.

Dear Sir and Brother: Lodge No. 447 would like space enough for a few words in the Journal lest our brothers might think we are out of business, but they will find No. 447 doing business at the same old stand, Decatur, Ill., and if you don't believe it, come this way with a bad card and book and you will sure be up against it.

We held our regular meeting September 7th, without president in the chair, after spending the summer in the mountains of Colorado, looking for bears and fishing for crappie. We have a loyal bunch of members as there is in the country anywhere; Brother McLaughlin was present, his first meeting since convalescent from a serious operation for stomach trouble, in the month of June. While recuperating he spent part of his time at his parents' home in Pennsylvania from where he has just returned. He

gave us a good talk on the assurance of the appreciation of assistance the brothers had given himself and family and their attention given him while in the hospital. We are very sorry to state, one of our oldest boilermakers is seriously ill in the hospital and is expected to pass away any time. When our meeting was well under way the information was conveyed to the lodge room that the Ladies' Auxiliary No. 16 were in the dining room and wished the lodge to adjourn. Their request was complied with as soon as possible and we found the ladies had taken the lodge by surprise and slipped in with well filled baskets and the tables loaded with plenty to eat and drink. All sure had an enjoyable time and when one stops to think the affair reminds one of the piece of poetry that reads something like this:

If with pleasure you are viewing any work
a woman is doing,
If you like her, tell her now
Don't withhold your approbation, till the
parson makes oration
As she lies with snowy lillies on her brow;
For no matter how loud you shout it, she
won't really care about it,
And she won't know how many tear drops
you have shed;
If you think some praise is due her, now is
the time to tell her,
For she cannot read her tombstone when
she is dead.

More than fame, and more than money are
these comments kind and sunny,
And the hearty warm approval of a friend.
And it gives her heart and spirit to the end;
If she earns your praise bestow; if you like
her let her know it,
Do not wait until life is over, and she is
underneath the clover,
For she cannot read her tombstone when
she is dead.

In conclusion, we all retired to our homes at a late hour hoping that a repetition of the same thing will happen in the near future and we feel that after all organized labor is worth while even if the pessimist and fault-finder don't see fit to come to lodge and enjoy themselves.

CHAS. J. YOUNGER,
Secretary 447.

Spencer, N. C.

Dear Sir and Brother: I thank you for promising to publish in the columns of our good "Official Organ," our Journal, the advice and requests I sent you last month.

Now in conclusion, I ask that you publish the following:

To all members of the International Brotherhood of Boiler Makers, Iron Ship Builders and all other members of the American Federation of Labor.

Brothers in the September Journal I asked that all of the trades write to President Wilson of U. S. A., and demand that the questions of Submarine Warfare and other questions that has caused trouble for this coun-

try between England and Germany and the other belligerents be settled by arbitration as our troubles are forced to be done.

Now after this is done we should do one other thing, that is to find out if we want war or if this country as a whole wants war or just the capitalists who shout to us to be patriotic which means nothing more than for us to be "idiotic." What good does a war do the laboring class? Whether it is with our country or not, that can be answered with one word. "None or No." But again what good does it do for our real enemies, the capitalists? It also can be answered with the one word, everything. It helps them and hurts by thinning out our ranks by death from want as well as bullets and shells, leaving less of us to fight our own cause here for our right, for home and happiness which we have now only moderately. So again I ask do we want war, or not. If not find out who is right by international arbitration and then ascertain who and how many want war by vote. Each man wanting war vote for war signing his name with address attached and those who do not want war vote against war, signing his name with their addresses attached. Then if two-thirds want war then let it be war, and those wanting war be called to the front first, they having signed their names and addresses to the vote for war. Then you will see that the papers, editors and others who want war will soon dry up and will not find so much trouble as they see now. Also the capitalists once and for all, will be more or less quieted on the question of wanting war so that they can get rid of us, and gain more territory to be used to enrich them, and given them, and give them more power to fight us with where as it is they are losing what they have now and fast at that.

If all the congressmen, legislators and other law makers were only honest and true to both sides, capitalists and labor alike would never dream of trouble. But the capitalists want more land, more ports, more money, more poor people to compel them to do their bidding for little or nothing and they get behind the law makers and cause some of them to be law breakers of the worse kind. The capitalists want war to get the aforementioned things and more. They will tell the law makers so and back it up with a lot of what they won't give us for honest work, namely, money, then Mr. Law Maker turns to Mr. Law Breaker and says he, too, thinks war would be best. Why? Because he won't, as a so-called law maker, have to go to the front to fight, neither will Mr. Capitalist, he will have to stay back and gobble up all the needful things for himself. That is why I say make "those who want war" go first. So now brothers now is the time, a little later may be too late to act. We as a whole do not want war with any of the European belligerents, not with Mexico nor any other place in the world. No not even with our own enemies the capitalists, and would not have any if they would only be "fair with laboring people." Now let's all

not only ask for arbitration of questions and the rights to decide whether there should be war by vote, but let us singly and in our lodges draw up resolutions demanding a right to vote for the answers of whether we want war or not.

And now hoping all brothers will understand this important question of who is to go to war if there is any, and why there should be a vote to determine whether there is to be war or not.

I beg to remain,

Yours fraternally,

WM. H. DREYER.

Shawnee, Okla.

Dear Sir and Brother: Enclosed please find set of resolutions on Railroad Educational Bureau of Omaha, Nebr., which was unanimously passed at our regular meeting, September, 13, 1915, and I was instructed by vote of the lodge to send you a copy for publication in the Boiler Makers' Journal.

With best wishes, I remain,

Fraternally,

A. D. ROSS,

S. L. 293.

Shawnee, Okla., Sept, 13, 1915.

Mr. T. H. Beacom, General Manager,
Third District, Rock Island Lines,
Oklahoma City, Okla.

Dear Sir: We wish to express our appreciation of your having made arrangements with the Railway Educational Bureau, of Omaha, Nebraska, to extend the privileges of the Bureau to the members of the International Brotherhood of Boiler Makers, Iron Ship Builders and Helpers of America who are employes of the Chicago, Rock Island & Pacific Railway Co.

The fact that the courses of study are not difficult nor complicated and that the Bureau is furnishing the service on a fair and square plan and at a reasonable price has caused a large majority of our members to sign up for this service.

It has always been the policy of the International Brotherhood of Boiler Makers, Iron Ship Builders and Helpers of America to encourage any movement that will give its members an opportunity to increase their efficiency and to further their knowledge of practical railroad work.

Respectfully,

International Brotherhood of Boiler Makers,
Iron Ship Builders and Helpers of America.

FLOYD OTT, President,

ALEX. D. ROSS, C. Secretary.

Kickapoo Local No. 293.

ROCK ISLAND LINES.

H. U. Mudge, Jacob M. Dickinson, Receivers
of the Chicago, Rock Island & Pacific
Railway Company.

To All Employes—First, Second and Third
Districts:

Arrangements have been made with The
Railway Educational Bureau, of Omaha, Ne-
braska, to extend the privileges of the

Bureau to our employes. The aim of this Educational Bureau is to offer those who may care to take up the course and apply themselves to the study of the lessons, an opportunity to increase their knowledge with reference to railroad operation, to fit themselves to assume greater responsibilities, and to place themselves in line for promotion.

This announcement is being printed in one of the Railway Educational Bureau's Progress Bulletins. A careful reading of this Progress Bulletin will give you a better idea of the merits and the benefits to be derived from a study of the courses put out by the Bureau. The cost per year will not exceed \$12.00, and payments can be made to suit the employe.

The courses of study are not difficult nor complicated and any employe can, with comparatively little effort or expense, make himself more competent and fit himself for a better position, in addition to securing a better knowledge of practical railroad work.

Authorized representatives of the Bureau will be permitted to solicit business among our employes.

Employes can either pay the tuition fee in cash or have it deducted from their wages. Collections will be made in favor of the Bureau in accordance with written deduction orders.

This work is in charge of Mr. D. C. Buell of Omaha, Nebraska, and Mr. Buell will be

In the morning, the members together with thousands of other good men, showed their firm faith in the labor movement by participating in the record parade, under the auspices of the Lowell Trades & Labor Council. Under the direction of Bro. Moran, the Boiler Makers and Helpers marched like a crack organization of well drilled men.

Lodge 371 appreciated the highest honor of having President Franklin march in our ranks, and the pleasure of having him speak to us in the hall after the parade. We realize our good fortune, and we hope that in the future we may be favored again and under such happy circumstances.

Words cannot express our pleasure and gladness at the presence of Deputy Organizer Brother Charles Scott in our parade and open meeting. Brother Scott has done sterling work in this section and we are always glad to see him.

A very welcome addition to our ranks on that day was President Parks and eight brothers from Lodge 515, a true group of union men and we were favored by their coming.

After the parade refreshments were served at the old Odd Fellows' hall. We then listened to some splendid and appropriate remarks by President Franklin, which were greeted with much applause and rousing cheers. In the same manner we received good words of cheer from Organizer Brother Chas. Scott, District President Brother Wil-

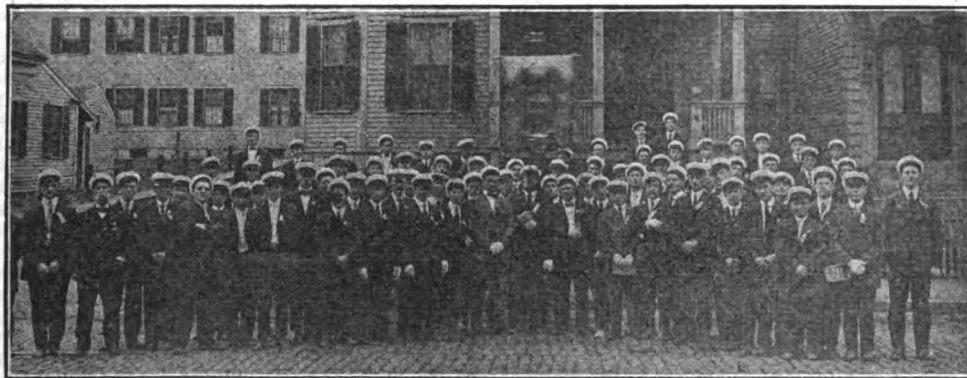

A GROUP OF THE MEMBERS OF LODGE NO. 371, LOWELL, MASS., LABOR DAY, 1915.

very glad to furnish any further information desired.

C. W. JONES,
General Manager, First District.
A. E. SWEET,
General Manager, Second District.
T. H. BEACOM,
General Manager, Third District.

Lowell, Mass.

Dear Sir and Brother:

The observance of Labor Day, 1915, will go down as the most successful in the history of Lodge 371.

William H. Wells and President Parks of Lodge 515.

Musical numbers by Brothers James Crawley, James Crown, George Nichols and J. Shaughnessy were rendered in their usual high manner and were much appreciated.

The thanks of the members of Lodge 371 is extended our committee, Brothers Slatery and Ward, for their untiring efforts to make the day a success.

Under separate cover, please find a picture which we should be glad to have you print in the Journal. Brother Qualey, ban-

ner bearer, stands in the center, and on one side of him can be seen President Franklin and on the other side Brother Charles Scott.
J. J. CUNNINGHAM, C. S.

Milwaukee, Wis.

Dear Sir and Brother:

Since my last report as to the conditions in District 26 there has been a wonderful improvement. The hours in the Minneapolis and Dubuque shops have been increased to 9 hours per day, formerly working 32 hours per week. Boiler makers have been put on at these points also at the Milwaukee shop and in the round houses along the line, the hours have been increased from 32 to 48 hours and has done wonders towards putting a different feeling in our members. All points have been on short time for over two years, there has also been a number of reductions in force. This has also gone a long way towards discouraging men. It is hoped that with this increase in time that our members will also adopt a little of that "get together" spirit that the roads are trying to promote and use towards bettering our conditions.

In the West everything is in good working order. All points are working eight hours per day, six days a week. Men have been put on in some of the round houses, also in the shops at Miles City, Deer Lodge and Tacoma. The railroads are looking to a large year, and it's expected that this fall will be the best that the "Milwaukee" has yet known. The grain crop in the West is the best in years and if it is moved it will mean good business for our craft in that country.

In my trips over the line, I find considerable interest displayed by members over various articles sent by members of our organization to the Journal. One in particular was the report of Vice-President Nolan in referring to Brother A. C. Dixon of Rocky Mount, N. C., who was laid off and later refused employment because he could not come up to the physical test required by the road. Numbers of our members have asked as to what was done for Brother Dixon and whether he was reinstated, also as to some means to overcome this examination as required by the various roads. I was informed recently that Brother Dixon has been placed back at his former position, but am not sure, it would be better for some of our members to write up this case so that members of roads making this examination may know what was done, and also what to expect.

In going over the rules and by-laws of what is known as the Milwaukee Hospital Association I find that they have a law in their constitution compelling an examination, but to date I have no knowledge on one being made of any one, but we can never tell when it is liable to be put into effect.

My attention has been called at times by our members to the poor mechanics that are going to work and calling themselves boiler makers. Some action should be taken by the entire membership towards taking the

men into our organization and "wishing a card on them." It seems that we are losing sight of the fact that "a man's card proves his qualification." Let us bear this in mind and the next time we have an application for membership into our organization as a boiler maker, investigate it in the manner it should be. This will bring our organization to a higher standard, character, reputation and ability should be thoroughly considered.

The article published by J. E. Dixon, past president of Lodge 592, in the September Journal, is a very worthy article and is one that should be given considerable study and thought by every member of the organization. What is wanted is a little more harmony and good fellowship among our members. We have got to cut out the rough stuff if we are to succeed.

Hoping that this will be of interest and with best wishes, I am,

Yours Fraternaly,

JOHN L. CALLAHAN,
R. A., District 26.

New Castle, Australia.

August 20, 1915.

To Jas. B. Casey, Esq., Editor-Manager International Brotherhood Boiler Makers, Etc., of America.

Dear Sir and Brother:

I am in receipt of your letter dated July 7, which reached me on the 18 inst., and I note that you received our emblem and badge in good order and I note your kind remarks on the matter presented in the emblem.

I also desire to acknowledge, with thanks, the badge of your Brotherhood which you were kind enough to send me. I regard it as being a beautiful emblem and I must admit that it is far in advance of ours. I had no gold ones on hand when I sent you the badge but I shall forward you one at an early date for yourself. I shall take a pride in treasuring your badge as a remembrance of our short friendship which has been established between our kindred organizations.

Your Journals have reached me regularly, the last issue being that of July.

I forwarded you a copy of our second issue of report which is somewhat in advance of its predecessor. I hope to continue improving it as we go along. I get the whole thing out myself and as I have had no journalistic training it may be full of faults, but it seems to meet with the approval of our members and after all that is all that counts.

I shall avail myself of your kind offer to allow me to reproduce articles from your Journal as opportunity permits.

I have read your Journals with keen interest and have noted your difficulties in keeping the strikes going successfully in view of the slackness of trade generally throughout America. We have not felt the pinch at all so far, except at the very inception of the war, when a little panic was shown, but this soon quietened and matters have gone along with a swing ever since. In all probability the pinch will come after

the war when the financial markets will be "tight" with their loan moneys which we are compelled to resort to in this country to carry on our large public works.

I notice the proposal to amalgamate your organization with the bridge and structural iron workers and with the sheet metal workers. This combination, should it be brought to a successful issue, should be something to be reckoned with in the Industrial world. In this country the boiler makers do all the structural work which, of course, has not reached the dimensions that it has done in America. The sheet metal workers have an organization here but the boiler makers have certain arrangements with them whereby we do all work over 10 gauge of iron, or approximately one-eighth of an inch in thickness, so that we get along with them O. K.

I shall reproduce your letter in our next Journal and will be glad at all times to hear from you on trade matters in America.

Again thanking you for your courtesy at all times and with fraternal greetings from Australia, I am,

Yours fraternally,
JNO. O'TOOLE,
Federal Council Sec'y.

St. Louis, Mo.

Dear Sir and Bro.:

Inclosed you will find roster change of Brother Jas. Callahan's address, also partly filled list with names for Journal.

Well, brother, the strike in St. Louis is about the same; three shops are still holding out but expect to get them soon; the men are doing good picket duty and we have not lost a man, except two former members that were foremen, and they are now taking our place, one of them by the name of Thos. McBride, and the other by the name of Chas. Riddleman, but we expect to win and then those two men, or rather two snakes, will be out in the cold.

Now I don't know of anything more I could write at this time but will send you a report the latter part of this week in regards to the strike, so I will close, with best wishes and kindest regards from all the boys of No. 27, I beg to remain

Fraternally yours,
HENRY SIEKMAN, F. S. L. 27.

East St. Louis, Ill.

Dear Sir and Bro.:

Whereas, it has pleased the Almighty God in his wisdom to remove from this earthly sphere our late brother and fellow worker, Adam Mahes.

Resolved, That Lodge 363 of the International Brotherhood of B. M. I. S. B. & H. of America having learned of the sad event in session on this date is filled with sorrow at the announcement, and tenders to his bereaved widow and relatives their heartfelt sympathy in their day of sorrow; and be it

Resolved, That while we realize that it is destined for all that live to die, and while all must submit to the decree of Him who we are told "doeth all things for the best,"

it is with regret that we realize that never, on this worldly abode can we clasp his hand in honest friendship, or hear again the sound of his cheerful voice; be it

Resolved, That out of respect to our late brother, our charter remain draped for the space of thirty days and while we realize that he has gone from our midst, entering into that eternal slumber that men call death, the secrets of which remain encased in the awful mysteries of divine wisdom.

Resolved, That it is our hope based on the consoling precepts of Christianity that tell us that the body may fade away, but the soul of man as an emanation of the divine essence must live forever, that some day in God's own time, parted ties and severed friendships will be reunited when all those who have followed the guidance of Him who in the resurrection in the Kingdom of God elect.

JAS. WITHMORE,
O. C. MASSEY,
JNO. ROCHE,
Committee.

East Boston, Mass.

Dear Sir and Bro.:

Lodge 585 held an open mass meeting on the night of September 1, at Armory Hall, East Boston, for the purpose of endeavoring to induce former members to come back to the fold, and to give the boys a chance to pay their respects to our worthy International President, Brother Jos. A. Franklin, who was in Boston at the time.

The president of Lodge 585, Brother Wm. E. McNabb, in introducing Brother Franklin, stated it gave him great pleasure to present to the assemblage the honored head of our organization, who is trying hard to build up the Brotherhood in Massachusetts.

President Franklin gave a lengthy and interesting talk, touching upon every phase of the labor question, pointing out the necessity of organization and the absolute helpless condition of the worker without organization and dwelling particularly upon the conditions existing in Boston and vicinity, showing the comparison between conditions in the union shop and under the so-called "open shop policy."

President Franklin impressed upon the minds of those present the fact that any organization will be just what the membership makes it and the degree of success of an organization will depend upon the support and loyalty of its members.

In closing, President Franklin assured us that if the members of the organization and the men employed at our trade in Boston and vicinity desired to advance their conditions and would manifest an honest desire to help themselves, that he would assure us that he would do all in his power to be helpful.

Brother Franklin's pointed remarks were warmly applauded and created a profound impression on his auditors, who felt that he, as a true exponent of the life essence of trade unionism, had expounded to them

the sound doctrine of organization, in a manner that left no room for misunderstanding or equivocation.

International Organizer Brother Chas. F. Scott heartily indorsed the remarks of Brother Franklin, saying in part:

"You men of Boston have been accorded an unusual opportunity to receive advice from the head of our organization whose life work is striving to advance, socially, intelligently and financially, the men working at our craft. Ponder well on what he has told you. He has uttered great truths, which you men will know. I don't believe there is a lodge in the country in a worse condition than Lodge 515 when we took hold of it some months ago, but today it is booming and the railroad shops over which "515" has jurisdiction are 100 per cent organized. There must be some mysterious reason why Lodge 585 is in the condition it now presents, and it is our mission to try to find out what is the trouble and try to settle it. Our organization has with the assistance of kindred trades, etc., in Boston made the D. Russell boiler concern feel that our organization amounts to something after all, so help us along by increasing your membership and thereby further your own interests."

Brother Scott who since he came to Boston has gained a reputation for honesty and straightforwardness of the "Omega" standard, gave way to Brother Wm. E. McNabb, the live wire president of Lodge 585, who announced that he was ready to receive applications and render all assistance in his power to all those who wished to be enrolled under the banner of our Brotherhood. After which the meeting adjourned.

Among the members of Lodge 585 present were President Wm. E. McNabb, Vice-President Thos. J. Farmer, Secretary D. B. McInnes, Treasurer Bernard McDonnell, Trustee James J. Kerrigan and Bros. Thos. Carns, John J. Farrell, Augustus Page, Harry Hegan, Wm. Clouter, John A. Hankard, Wm. Hankard, Thos. Defretas, Thos. Jordon, Chas. Jenkins, Chas. F. Smith, Joe Cameron, Martin J. Nolan, Wm. Warnock, Jno. J. Kerrigan and Lodge 515 was represented by President Geo. Parks and Bro. John F. Brady.

Another of the old-time boiler makers of this city, John Leahy, has joined the silent majority, and although sickness and lack of work caused his suspension, he was always a good union man at heart and was never found wanting when the test came, and the old reliable war horse of Lodge No. 585, Brother John J. Farrell made up his mind that "Jack" Leahy, who left no insurance, would receive proper Christian burial. Brother Farrell did noble work in collecting the necessary funds, ably assisted by the president of Lodge No. 585, Brother William E. McNabb, and those two brothers along with Brothers Thomas Cairns and John B. Gahen represented Lodge No. 585 at poor Jack's funeral.

It is with exceeding regret that I announce that Brother John Warnock, one of our most faithful members, is at the eye and ear infirmary, as a result of an injury to one of his eyes, which was terribly bruised some weeks ago by being struck by a flying fragment of a pin. The injured optic has been operated on three times and the surgeons are doing all they can to save the eye, and we hope they will succeed, for a "whiter" man than John Warnock (who suffered torments of pain with admirable patience) never lived.

I also regret to announce that Brother Bernard McDonnell, who has, in his official capacity as treasurer, been faithful to every trust imposed and has been a veritable watch dog of the treasury, has after three years of efficient service resigned as treasurer. Brother Thomas J. Farmer has been elected treasurer in his stead, and Brother Thomas DeFreitas has been elected as vice-president to succeed Brother Farmer. Both of these boys are good workers and their hundreds of friends all over the country will be glad to hear of their advancement.

Brother Augustus E. Page and his estimable wife have the sympathy of all the members of Lodge No. 585 in the recent death of their infant son, Leslie Linnell Page.

Brother Joseph Schadraver also has the sincere sympathy of all the members in the recent death of his wife. A beautiful floral tribute was sent by the lodge which was represented at the funeral by a delegation of our members.

Lodge No. 585 was represented in Boston Labor Day parade, by Brothers Bernard McDonnell, D. B. McInnes and Charles McDonnell, who appeared in line as delegates of the Boston Central Labor Union.

Yours fraternally,
DANIEL B. MCINNES, C. S. L. 585.

Salt Lake City, Utah.

Dear Sir and Brother:

The gold watch raffle for the benefit of brother boiler makers, H. P. Pratt and R. P. Wilkinson: Drawing took place at regular meeting of Lodge No. 103, Wednesday, September 15, 1915. Number of ticket winning the watch was 2838, won by E. E. Dunham, Lodge No. 602, Great Falls, Mont. Winner, communicate with B. S. R. Harrison.

Secretary Lodge No. 103.

Danville, Ill.

Dear Sir and Brother:

At a regular meeting of Buffalo Lodge No. 7, I. B. B. M., I. S. B. & H. of America, the following resolutions were unanimously adopted:

Whereas, It has pleased the Almighty God in His divine wisdom, to remove from our midst the dearly beloved father of our worthy and esteemed brother, George F. Muir; therefore be it

Resolved, That we, his fellow brothers, extend to our brother our heartfelt sym-

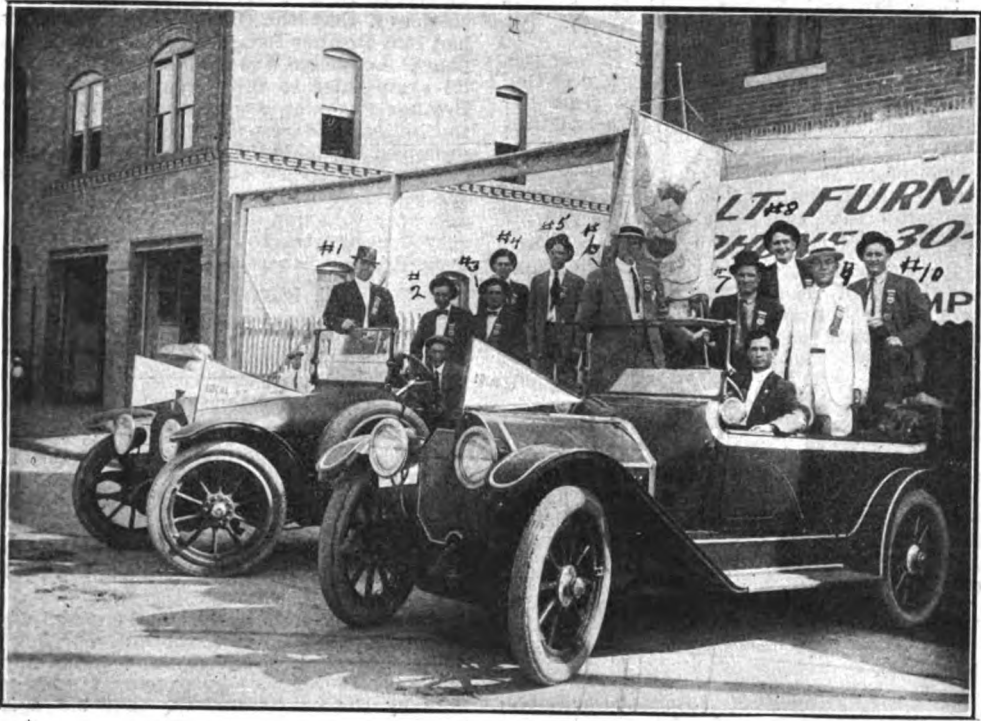

LODGE NO. 216, EL PASO, TEXAS, LABOR DAY, 1915.

1—Frank H. Bolt. 2—Wm. Dehlinger. 3—Thos. O'Connors. 4—Otto Hintze. 5—Harry Still. 6—Pres. F. E. Perry. 7—Johnnie Lauders. 8—J. M. Morgan. 9—Fred Butterfield. 10—Thos. J. Cotter.

pathy in this his hour of bereavement, and pray that the Almighty God may comfort and console him, that he will bear this trial with fortitude; be is further

Resolved, That a copy of these resolutions be spread on the minutes of our meeting and a copy be forwarded to our bereaved brother, and a copy forwarded to our official Journal for publication.

JOSEPH ERNST,
THOMAS J. KING,
BENJAMIN GAU,
Committee.

Chicago, Ill.

Dear Sir and Brother: Resolutions of Lodge No. 25, San Francisco, Cal., was unanimously endorsed by Lodge No. 39 regarding certain International Officers expense and restoring support to Business Agents, with pay for back months due to us. Otherwise provisions of resolutions of Lodge 25 be carried into effect.

Hoping this will appear with resolutions of Lodge No. 25 in next issue of Journal, and with best wishes for the success of our Organization.

Fraternally yours,
JOHN S. COGLAN.

Newport News Va.

Dear Sir and Bro.:

I have been instructed to write you and ask you to have it published in the Journal that E. Stewart who was published through the Journal by Lodge 66 and asking for his card to be held by the secretary of any lodge that had it. Brother E. Stewart, Reg. No. 21232, deposited his card with Lodge 55 and was with us until the charge was made against him and as he was only helping here at that time he had to find other employment and at present he is in Washington, D. C., and he sent a check to Brother W. Healy to clear all his accounts which has been done. I would like to say that the members of Lodge 55 had every good faith in Brother E. Stewart. The debt claimed by Lodge 66 for the railway company has been sent on to Brother E. Wortsmith (\$2.90). Brother E. Stewart has asked for a clearance card and his due book which has been sent to him in Washington, D. C., as we find no debt standing against him and all his debts have been paid.

With best wishes, I am,

Yours fraternally,
DAVID McARTHUR, C. S.

Brainard, Minn.

Dear Sir and Brother: At the regular meeting of Pine City Lodge No. 116, the following resolutions were adopted:

Whereas, it has pleased the Almighty God in His Divine wisdom to remove from our midst our dearly beloved Brother, Andrew Wilmar;

Therefore be it Resolved, that we extend our heartfelt sympathy to his beloved ones and pray that God Almighty will console them in their bereavement;

Resolved, that a copy of these resolutions be placed in the minutes and a copy be sent to the bereaved ones, also a copy sent to our Journal for publication.

MARTIN KICKLAND,
WALTER BUTKA,
RALPH HASTINGS,

Note.—The death of Brother Wilmar took place in Norway, where he went some time ago for his health. The Secretary of Lodge No. 116, in reporting his death speaks in high praise of his record as a union man. His brother John Wilmar, is still a member of Lodge No. 116.

THE EDITOR.

Denison, Tex.

At a regular meeting of Sunset Lodge No. 209, of Denison, Tex., the following resolutions were adopted:

Whereas, It has pleased the Almighty God in His infinite wisdom to take unto Himself the little infant boy and also the little six-year-old girl, Bulah, the son and daughter of our worthy and esteemed brother, J. H. Gee; therefore, be it

Resolved, That we, his fellow brothers, extend to him our heartfelt sympathy in this his sad hour of bereavement, and pray that the Almighty God may comfort and console him, that he may be able to bear this double burden with fortitude; and be it further

Resolved, That we drape our character for thirty days, that a copy of these resolutions be sent to our worthy brother, a copy be sent to our official Journal, and a copy be spread on our minutes.

S. E. HARRIS,
CHAS. F. PETET,
O. O. MATTHEWS,
Committee.

Tulsa, Okla.

Dear Sir and Brother:

Please publish in the next Journal issue the following:

On September 1 we received a telegram from Mr. S. H. Crane of Hornell, N. Y., that Brother Albert Seaquist, Reg. No. 10299, was killed by a train enroute from Chicago to

New York City. On September 9 we were in receipt of a letter from Brother James McGeney that the Loyal Order of Moose had laid Brother Seaquist in his last resting place. Lodge No. 592 is sincere in extending its sympathies to the bereaved brothers of Brother Seaquist, as we found him true to the beliefs and principles that we have all promised to uphold. We found him a thoroughly good fellow and a man among men. We again extend our heartfelt sympathies and pray that our brother members may be spared a like tragic death that was visited upon Brother Albert Seaquist.

C. DIXON, President.

RICHARD LEAHY, C. & F. S.
Lodge No. 592.

Portsmouth, Va.

Dear Sir and Brother:

At a regular meeting of Lodge 298 the following resolutions were adopted:

Whereas, It has pleased the Almighty God in His infinite wisdom to remove from our midst the beloved father-in-law of our esteemed brother, George Miller; therefore, be it

Resolved, That we, the members of Lodge 298, extend to our worthy brother and family our heartfelt sympathy and condolence, in their sad hour of bereavement softened only by the confiding hope that his spirit has departed to a better and brighter sphere where sorrow is unknown; and be it further

Resolved, That a copy of these resolutions be sent to our bereaved brother and a copy to our official Journal for publication, and a copy be spread on the minutes of our meeting.

Fraternally,

ROBT T. HOWE.

Newport News, Va.

Dear Sir and Bro.:

Will you have the following resolutions inserted in the Journal:

Whereas, It has pleased the Almighty God in his divine wisdom to remove from our midst the dearly beloved wife of our worthy and esteemed brother, Robert Anderson; therefore, be it

Resolved, That we, his fellow brothers, extend to him our heartfelt sympathy in his sad hour of bereavement and pray that the Almighty God may comfort and console him, that he may bear his trial with fortitude; and be it further

Resolved, That our charter be draped for thirty days, a copy of these resolutions be spread on the minutes of our meeting, and a copy be forwarded to our bereaved brother, also a copy to our official Journal for publication.

Yours fraternally,

DAVID McARTHUR, C. S.

A Compilation of Labor News.

BY THE A. F. OF L. NEWS SERVICE.

HOPE OF U. S. IS EDUCATION.

San Francisco.—"I was neither judge nor jurymen. A man who is endeavoring to develop the truth from some witnesses—some unwilling—is not a judicial officer. That is what I mean when I say so frequently that 'judicial poise' has no place in my field," said Frank P. Walsh, ex-chairman of the Commission on Industrial Relations, to a representative of the Evening Bulletin.

"The facts which were assembled by the Commission and by me as chairman must stand for themselves—and let this sink in—every fact presented in the report is undisputed. Only those were presented which were agreed upon as truth by both the workers and the employers," said the ex-federal prober.

"When I accepted the appointment I conceived that the duty and the task set before me was to obtain undisputed facts for all the people, for the man who has invested his millions and for the man who has invested his labor and his life. I saw the great working, hoping, striving millions of men and women, God's creatures, in every avenue of industry. The act of Congress which created the Commission declared that there was unrest and bitterness in the land. There were clashes between the men who labored—and those who hired them. There were hatred and outbursts of passion, strikes, lockouts, injunctions, gunmen, militia and riots.

"The people asked why. For the people paid. They paid in the cost of the things they ate and wore. They paid in taxes for the burden of government—and the people meant not the laborer nor the capitalist, but both of these, and all others, all the people, not a part.

"I went to this Commission as a lawyer, determined to bring out all the facts, to present only the undisputed facts to the people so that they may judge—and find the remedy.

"I am not a doctrinaire, not a political economist. I have no panacea for the ills. I have no bottled justice which may be taken at a dose.

"The remedies proposed have been offered to Congress for what they are worth. No one could have a panacea for industrial ills. The inquiry, in its essence, involves the study of life itself. You cannot card-index the hopes, aspirations, happiness, miseries, laughter and tears of the human family. I construed my job to be an assembling of the facts as they actually existed.

"The hope of right conditions is through education. The circle of knowledge is widening. The people are learning to de-

fect sham. They are fooled less by those who exploit them. More and more men with good minds and ideals of justice are working for the common good.

"The people—the jury—now have the facts. They now observe how capital is becoming more highly concentrated daily; how the natural resources of the country, the heritage of all of us, have been seized by a few, and are exploited to the hurt of the rest of us. The people have a growing sense of their power to overthrow this injustice over night if they but will it so.

"When enough of us get the idea, it may be done between days."

LOCOMOTIVE INSPECTION RULES.

Washington, D. C.—At a recent conference held in the office of the Chief Inspector of Locomotive Boilers, working rules were adopted in behalf of safe and suitable operation of locomotives and tenders engaged in interstate commerce. All of the largest railroad systems were represented by their superintendents and master mechanics.

The organizations of labor were represented by Herman E. Wills of the Brotherhood of Locomotive Engineers; A. O. Wharton, President of the Railway Employees' Department of the American Federation of Labor; William H. Johnston, President and the members of the Executive Board of the International Association of Machinists, and Arthur E. Holder, Legislative Committee of the American Federation of Labor.

The rules agreed to at this conference and the proposed rules contested by the carriers are now in the hands of the members of the Interstate Commerce Commission for final disposition. The new law governing locomotive inspection went into effect September 4.

ALTGELD'S MEMORY HONORED IN CHICAGO.

Chicago.—Organized labor joined with federal and state officials, Labor Day, in paying honor to the memory of John Peter Altgeld, former governor of Illinois, by unveiling a statue of this champion of common rights.

"Altgeld was a friend of the common people and never feared to take a stand with them," Governor Dunne said. "Pre-eminently he had the courage of his convictions. He upheld the right and denounced the wrong at all times, under all circumstances, and in every place.

"He believed the conviction of the anarchists was the result of the mob's demand, although the mob was clothed in purple and fine linen. When he was elected governor he had the courage to do what was a most

unpopular thing at that time—to pardon the anarchists then confined at Joliet. In so doing he gave his reasons, and the doing startled the whole community.

"His moral courage was again displayed when President Cleveland, without request from governor, legislature, or mayor, sent federal troops into this city for the purpose of suppressing riot. He protested, and protested vigorously.

"Devotion to public interest compelled him to neglect his private business and during his term of office he became seriously embarrassed financially. But in spite of this, this man had the resolute honesty and iron-like integrity which made him refuse a bribe of half a million dollars. I know of no man who was more devoted to the cause of human liberty, whether it was in his own land or in the land of strangers."

VICTORIOUS LONGSHOREMEN.

New York.—General Organizer Hugh Frayne reports that the International Longshoremen's Association, through President O'Connor, has secured the first agreement that has ever been made with any of the steamship agents or the stevedores in the port of New York City. They have succeeded in writing union shop agreements with practically every one of the employing longshoremen in the port of New York and as a result, 3,000 additional members have been taken into the locals of the International Longshoremen's Association. One of the oldest independent longshoremen's organizations has gone out of existence and affiliated its members with the international. Conditions in the agreement call for 35 cents per hour, day work; 50 cents per hour, night work; 50 cents per hour for ordinary holidays, and 60 cents per hour for Sundays, Christmas Day and Fourth of July. When longshoremen are required to work on Good Friday on the Jersey shore, 60 cents per hour will be the rate. Double time will be paid for men handling explosives and munitions of war. Standard methods of voluntary arbitration were included in the agreement for the settling of minor grievances that may arise.

PREFERENCE TO UNIONISTS.

Brisbane, Queensland, Australia.—Preference to unionists in Australia is necessary to encourage organization of workers, that the compulsory arbitration laws and wages boards declarations may be enforced, declares the Worker, of this city, in a leading editorial.

Many employers are opposing the theory that unionists should be given preference, and the Worker says:

"Preference to unionists!

"To Australia's employing class the phrase is like unto a rag to a bull. Thus it is not surprising that during the debate on the address-in-reply in the legislative council several crusted Tories should jump hurriedly to their feet and express horror at its

proposed advent in the Queensland statute book.

"Our national parliament and every state legislature have passed laws for the settlement of industrial disputes by, in some cases, compulsory arbitration, in others by wages boards and industrial courts. Individuals can do nothing in such tribunals. Without organization by the workers, the laws and courts should be meaningless and valueless, since there would be nothing and no one to set the machinery of arbitration in motion.

"Unionism is an absolute essential to the working of such legislation, be it state or commonwealth. Since this is so, it should be a natural correlation that members of unions should be given the preference."

RAILROAD'S VAST EARNINGS.

Philadelphia.—Last winter the Pennsylvania Railroad led the fight to repeal this state's full crew law, which is intended to protect the lives of trainmen. Legislators were assured that railroads in this state are nearly at the "breaking point" because of such "unnecessary legislation."

The bill was repealed, but the repealer was vetoed by the governor.

With these facts in mind, trade unionists are pointing to this announcement, made recently:

"For July the operating profits of the Pennsylvania Railroad System show an increase of \$1,905,036. That increase nearly equals the gain for the whole first half of the year, which was \$2,102,089.

"For July the railway operating income, or, stated otherwise, the profit on operations, was \$9,797,177. For seven months of the year it was \$38,546,492.

"The Pennsylvania Railroad System is now doing a gross business at the rate of \$400,000,000 per annum. The greatest system gross earnings were for 1913, being for that year \$392,436,000. For July the total revenue was \$33,197,016, or \$1,132,382 more than for that month last year."

ROCKEFELLER REDUCES HOURS.

New York.—Mr. Rockefeller, philanthropist and benefactor, announces a reduction of working hours from ten to eight in his refineries at Bayonne, N. J., and elsewhere.

The announcement says:

"In accordance with the policies of this company to keep its wages and working conditions equal to, or in advance of, the wages and working conditions of other men doing a similar class of work, it has been decided to adopt the eight-hour day. This change will be made without loss to the men."

This decision is received with much pleasure by Bayonne workers, who now agree with trade unionists that "no strike was ever lost."

The decision benefits Mr. Rockefeller, also, as it will weaken contrary claims as to his

company's policies at Bayonne, made by the Commission on Industrial Relations, and it will check any agitation toward further investigation of the bad conditions under which oil refinery workers labor.

TESTING DISPUTES ACT.

Vancouver, B. C.—The Canadian Industrial Disputes Act is undergoing a practical test in Vancouver. The electrical workers are determined to see whether any justice can be obtained for the workers under it. The working agreement the electrical workers had with the British Columbia Electrical Company expired June 30. The men requested a renewal of the old agreement. The company offered 10 per cent reduction and unsatisfactory working conditions. Pending the negotiations, the company discharged a number of electricians and the men believe that Section 56 of the Industrial Disputes Act has therefore been violated, in which it provides that it shall be unlawful for any employer to declare or cause a lockout on account of any dispute prior to or during the reference of such dispute to a board of conciliation under the provisions of the act." Judge Shaw of Vancouver dismissed the case in favor of the company. The electricians will carry the case to a higher court.

UNCLE SAM'S FREE LAND.

Washington.—The annual report of the General Land Office will show that the government owns 279,544,400 acres of land "unappropriated and unreserved, of which 172,987,912 acres are surveyed and the rest unsurveyed."

All this is in the twenty-five public land states and in addition to this enormous area there are approximately 300,000,000 acres in Alaska which will be available to American citizens.

Nevada is shown to have the most public land, 55,417,745 acres, of which almost 30,000,000 acres are already surveyed, and Missouri, with only 923 acres, reports the least. Michigan has 76,030 acres subject to entry; Kansas, 75,214 acres; North Dakota, 493,667 acres, and South Dakota 2,880,828 acres surveyed and 53,781 unsurveyed.

More than 11,200,000 acres of land were eliminated from the public domain during the last fiscal year by homestead and other entries and sales to individuals.

TO DISTRIBUTE EASTLAND FUND.

Chicago.—The Eastland relief fund, contributed by Chicago citizens, is now being distributed. The fund approximates \$360,000. It was found that the funeral expenses alone of the 816 victims totaled about \$200,000. In one case a funeral director, who had a bill for \$2,100, cut off \$700 at the suggestion of the committee. The relief funds of the Western Electric Company cut the amount expended for funerals more than half.

The distribution of the remaining fund will affect 3,500 persons, including nearly 200 widows. It was found that twenty-five families were entirely wiped out in the disaster—mother, father and children drowned. In some cases where a young wife was left absolutely penniless and helpless, with two or three small children, the largest allotments will be made. In the case of widows and minor children the fund will be held in trust or investment and paid out in installments, both principal and interest.

WANT RIGHT OF APPEAL.

San Francisco.—A civil service court of appeals is urged in a resolution passed by the convention of the National Federation of Postoffice Clerks, which has been in session this week. At the present time a postal employe has no appeal from wrongful discharge, except to those who caused his dismissal. The clerks will ask the American Federation of Labor, with whom they are affiliated, to assist in securing the right to have appeal cases heard by an unbiased tribunal, the details to be worked out by congress when it passes the proposed legislation.

The convention also declared for the following additional legislation: Retirement for aged postal clerks, a higher salary classification, an adequate compensation-for-injury law and elimination of the stop watch in speeding the clerks to more work.

IMMENSE SHIP PROFITS.

New York.—A statement issued by the bondholders' committee of the International Mercantile Marine Company shows that for the six months ending June 30 last the profits were in excess of \$11,000,000, after deducting depreciation charges of about \$2,750,000.

A subsidiary of this concern recently purchased five steamships of the Pacific Mail. The immense profits of the Mercantile Marine, if thoroughly understood by the American people, would weaken the claims of vessel owners that the seamen's law "will drive the American flag off the seas."

MACHINISTS' NEW EDITOR.

Washington.—Mr. Fred Hewitt, formerly assistant secretary of the International Association of Machinists, has been elected under the referendum, as editor of the Machinists' Journal to succeed the late D. Douglas Wilson. His opponent was Thomas L. Wilson, a former vice-president of the international association.

SCORE ORGANIZED CHARITY.

Spokane, Wash.—Organized charity opposes mothers' pensions and has found a way to hamstring this legislation was the charge made by Judge Henry Neil of Chicago in a speech to churchmen in this city. Judge Neil is known as the originator of mothers' pension law. He said:

"In New York, Illinois, Minnesota and nearly all the other mothers' pension states," said the speaker, "organized charity has induced the legislatures to prevent deserted mothers getting pensions on the plea that pensions to such mothers would increase desertions.

"It is a well demonstrated fact that charity gets most of its funds by appeals based on the destitution and suffering of innocent children, so if all poor children were taken care of by the mothers' pension system, publicly administered, there would be little suffering left.

"Now, when a mother and her children are deserted, organized charity sends out begging letters telling of their great distress and asking rich people to send money to help relieve the distress, deploring the fact that these mothers cannot get a pension, when charity itself went to the legislature and prevented her getting a pension.

"Surely, charity does not claim that it provides the same amount as the pensions, for then there would be no reason for charity preventing the destitute deserted mother and her children getting the pension, except to get the 75 per cent rake-off. I ask, why pauperize the deserted mother? Will some expert please answer why?"

AUSTRALIAN UNIONS GAIN.

Melbourne, Victoria.—In a report by the commonwealth statistician it is shown that the number of Australian unions in 1914 was 712, compared with 700 at the end of 1913, while the membership increased from

497,925 to 523,271. The figures for the previous year (1912) were 621 unions with 433,224 members.

UNIONISM MOST EFFECTIVE.

Little Rock, Ark.—"We do not wish to decry the importance of unions trying to secure all of the labor legislation possible," says the Union Labor Bulletin, "but we do warn them against placing too much dependence upon reform by law and too little upon organization.

"It is as true today as ever, 'that those who live by the sword shall die by the sword.' Those who seek and gain legislative victories today will hold them only so long as they maintain their political strength, and tomorrow may see their power wane and an opposing influence repeal previous legislation.

"Of course this does not hold good with laws that greatly benefit the general public, but it does apply to legislation that benefits more directly only one class of people, even where the indirect benefit extends to many others."

MERCHANT MARINE INCREASES.

Washington.—Figures issued by the federal department of commerce do not support the claim that "the American flag is disappearing from the seas." It is stated that 363 ships, with a gross tonnage of 737,623 tons, were added to United States registry during the past fiscal year, and that this is three times the gain made in any previous year.

Among Our Exchanges.

MISLEADING ISSUES.

The parrot cry for "industrial unionism" is, as a general rule, misleading, calculated to divert attention of the organized workers from the issues which are the most pressing. This catch-word is re-echoed in variations and for various reasons, some of which could not stand the test of investigation and publicity by an impartial trades union tribunal. So-called leaders clamoring for applause and popularity are constantly on the lookout for catchwords which are likely to appeal to the imagination of the inexperienced and emotional worker. Some hail "industrial unionism" as the panacea for failures in strikes; other clamor for a "general strike" in all industries as an infallible remedy for lost strikes in the past. The advocates of these specific remedies are very closely related, and are inspired by the same motives—the minimizing of all past achievements of the trade union movement. Both are anxious to put the history of the movement in a bad light, and to create doubts in the minds of the masses in reference to action based upon past experience.

The advocates of "industrial unionism" and the "general strike" have so far failed to prove their contention; they failed to

prove the advantages to be gained by a change of system and tactics; they failed to offer convincing arguments in favor of a new departure.

"Industrial unionism," so-called, is not a new experiment by any means. It has been known in Great Britain for over sixty years under the name of "amalgamation." The Amalgamated Society of Engineers, organized in 1851, is a so-called industrial union, composed of machinists, millwrights, patternmakers, laborers, etc. This society had as many failures in the shape of strikes and lockouts as the unions organized on craft lines.

The so-called "industrial unionist" and the champion of a "general strike" in all industries, ignore the most pressing issue which confronts the American trade union movement. The problem of financing protracted strikes and lockouts is of more importance than all other issues which might be helpful in wage disputes.

It is true we need a more complete organization, a better discipline and a loyal devotion to trade union laws and regulation. But the financial question, the ability to render assistance if necessary to the bitter end, overshadows all other issues in importance.

Constant appeals for voluntary contributions are at the best, uncertain and cannot be depended upon when mostly needed and the clamor for support is the loudest. It is the guarantee of the weekly pay which inspires confidence and helps to strengthen the backbone of the timid worker.

The most powerful weapon of a corporation is to hold out until the employes are starved into submission. When a corporation knows that the trade union funds cannot be exhausted and that the workers cannot be starved into submission, this powerful weapon is rendered absolutely useless. The corporation is then compelled to arbitrate the difference, and the recognition of the union follows as a matter of fact. We again reiterate the most important and pressing issue is the solution of the financial problem in the near future. All other issues are insignificant in comparison and should not be countenanced for a moment.—George W. Perkins, in *Cigarmakers' Journal*.

TREACHERY UNMASKED.

Every body, organization or group of men has had its Judas. Somehow, this sort of person prefers deceit, duplicity, treachery, treason, to honesty and the love of his fellows. Aside from a money consideration, such natures love the work of the double-crosser. Not always does he work openly where an honest enemy can meet and conquer him and his devilish schemes. His methods are insidious and various; he drops mysterious hints of ambiguous meaning against his people or class; he plays his cards under the table, and carries in his sleeve a duplicate ace; he stacks them against his friends. All these things have been uncovered and noted previously, but, behold this class of person has developed a new attack on his people.

In the labor movement, the latest attempt, apparently, to discredit the leaders is to proclaim openly and maliciously that they are not worth their salary paid by the different organizations to represent them—or that they are receiving princely salaries and belittling the work they give in return for same.

The Labor Tribune was asked about this the past week, and we desire to say here that there is no princely salary connected with the labor movement. Men now in this field are competent workers in their crafts, and could earn more by merely working at their trade and be with their families at night, instead of traveling about over the country, meeting all sorts of calumny and slander in the work of uplifting the masses. And it ill becomes a man supposedly in the labor movement to stab him in the back.

We believe this belittling of head officers of any organization or body by one in the ranks is about the foulest method yet devised to destroy the foundation of the labor movement. The bird that befouls its own nest is hardly worth while, however.—The Joplin (Mo.) Labor Tribune.

UNIONS AND WAGES.

The packing house testimony before the Industrial Commission, to the effect that 20,000 employes of one company average \$500 to \$650 a year, or \$9 to \$12 a week, makes it easy to understand the pronounced objection of this company's president to unionism. He asserts that a company handling perishable products cannot tolerate the vicious delays of unionism, which would endanger the sale of products in good condition. Big Business magnates, whether they deal in metal products or perishable meats, usually find an excuse for fighting the organization of workmen.

Contrast the recent fight of Chicago carpenters for an increase from 60 to 70 cents an hour with the non-union packing wage of 15 to 20 cents an hour. And carpenter contractors are just as commercial, no doubt, as the packing chiefs. If the carpenters could have been kept down they would be receiving 15 to 20 cents an hour, but now these men are getting \$5 to \$6 a day.

The truth is that as a general rule in the mechanical trade men get the wages that they can extract from reluctant employers. An employer very rarely "feels able" to pay higher wages until forced to, even if the company's treasury is bulging with a surplus of millions. It is no wonder that Big Business in the United States is very largely lined up against the unions. Wherever the unions have flourished the men have prospered and the employer has been compelled to pay a living wage. Granted that unions have been unreasonable; in the long run, the good that guilty of excesses, that they are sometimes they do far outbalances the harm. A little union treatment of the packing wage would have prevented the disgraceful \$9 and \$12 weekly wages. It is not hard to understand why packing heads refuse to discuss the justice of the \$12 wage. It is past defense. A discussion of it in 1915 is sadly out of place.—The Milwaukee Journal.

THE SAVING HABIT.

There is a grand army of fools in this country who seem to be forever thinking of easy money. A certain percentage of these people go out after some of that easy money and as a rule they land in the penitentiary. Sooner or later they are found out, and that easy money becomes the hardest kind of money.

There is but one kind of real easy money, and that is the money that is honestly earned by honest labor of muscle or of brain.

But for the very many of those who get it honestly, there is great difficulty in keeping a little of it for the rainy day, which is sure to come. Some never learn it. And some begin only late in life to learn the art of living on a little less than they earn. When, however, the man or woman who has the habit begins to lay aside some of the earnings in a safe place and then watches it grow there is a legitimate pleasure in that

operation which well repays them for so-called pleasures or extravagances which have to be foregone.

While it is not good that economy should be pursued to the point of parsimony, it is sure to be rewarded by the riches of peace, prosperity and perhaps plenty.

Get the habit; it soon becomes a genuine pleasure.—*Labor Advocate, El Paso, Tex.*

WEARINESS.

You are weary, you say. What has wearied you? Is it the rush and struggle of business? The fight for gain? Pause a moment. Why should you so strive for wealth that you lose the ability to enjoy? Why feed your mind on one topic only? Why let your soul shrivel till you know not what happiness means? Every man wishes a competence, provision for himself and family against accident, sickness and age. More than that is likely to be dearly bought. Are you weary with hard toil? Be glad that you have work and are able to do it. Work is one of the blessings of life. You are working for a purpose. Keep that in view. Do your work worthily and it will bring a certain satisfaction to you. But do not degrade your work into drudgery. Are you weary of the hollowness of artificial life? The posing for effect? The mockery of a conventional society, where glitter and show count for more than character? Why strive for place among those who have souls no higher than to seek these things? This strife to keep up appearances make you distrustful of sincerity in man. Be sincere yourself and you will have reason to believe in the sincerity of others. Seek your pleasure in real things. The more you seek the true and kind, the more you will find, and the more joy will enter your heart—joy that glitter cannot give.—*The Milwaukee Journal.*

A MARE ISLAND INDICTMENT OF THE SPEEDING-UP SYSTEM.

"Speeding-up" systems are sufficient to upset the mind of an ordinary individual and produce insanity.

This is what the solicitor of the United States Department of Labor at Washington thinks of the stop-watch system of production.

The department has sustained this view, which is included in an opinion by its legal adviser that a worker injured because of a strain from working under a "speeding-up" system is entitled to relief under the Federal workmen's compensation act.

The decision was made in the case of D. C. Manning, sailmaker at the Mare Island Yard, who worked for twenty years without losing a day from illness. A time-card system was introduced, and his plea for compensation Manning brought out these points:

"Under this time-card system you had to give an account of every minute you were on the job, and we were given to understand that the men who did the most work should

hold their jobs the longest. Later the Halsey system was introduced. Under this plan a time man, equipped with tablet, lead pencil and stop-watch, sat in front of the worker to find out how long it takes to do a certain piece of work. The report to headquarters was your future standard for that class of work.

"The Halsey system is designed to get out of the man employed under it the greatest amount of work he can do in a given time, with the fear ever hanging over his head that a failure to keep up the standard will cause him to lose his job."

Manning was engaged in making coaling bags, which are 42 inches long and 8 feet in circumference. It is the hardest work in sail-making.

Between the physical strength necessary in this work and the mental strain caused by every move being "tabbed," Manning collapsed, and asked for relief under the compensation act because of "a strain from rushing work under the Halsey system." Physicians reported that he would be disabled for life and that he was "suffering from incurable heart condition."

The attending physician reported that Manning was "an unusually vigorous man, as well as an energetic workman."

In endorsing the statement of claimant that he was entitled to compensation, the solicitor of the Department of Labor declared that the treatment accorded Manning was enough to produce insanity. The official said:

"Here is a strong, hearty, hard-working employe, who, for about twenty years, had been regularly employed by the government, and whose rating was first class. After putting in all these years of service and retaining his health, strength and vigor, a new system was installed in the government establishment by which the employe was kept under the highest nerve-racking tension by reason of the fact that a man sat watching his every movement during every minute of an eight-hour day. In addition to this it will be observed from claimant's letter, above quoted, that the work he was performing was one of the heaviest and hardest kind to be performed in his occupation. Under such circumstances it is not a matter of surprise that his health should be injured and shattered, for it certainly seems that such treatment of a man engaged in heavy manual labor necessitating also the use of the intellect, would be sufficient to upset the mind of an ordinary individual and produce insanity."

The ruling of the Department of Labor is in line with the views of the last Congress, which passed the Detrick bill, outlawing all forms of "speeding-up" in government arsenals and navy yards. The passage of this bill was the result of a long campaign by union labor. Opponents of the bill insisted that these "speeding-up" systems really benefited the employe, who was thereby paid "according to his worth."—*Alameda County Workman.*

News of General Interest.

THE "AEROTUG" DRIVEN BY AN ENGLISH CRUDE OIL ENGINE.

By Frank C. Perkins.

The accompanying illustration shows the design and construction of the "Aerotug,"

tor instead of an air hammer. It was devised by F. W. Frank of Rocky Mount, N. C. The expanding elements are of the usual prosser type, which are forced out against the tube wall by a tapered mandrel. Instead

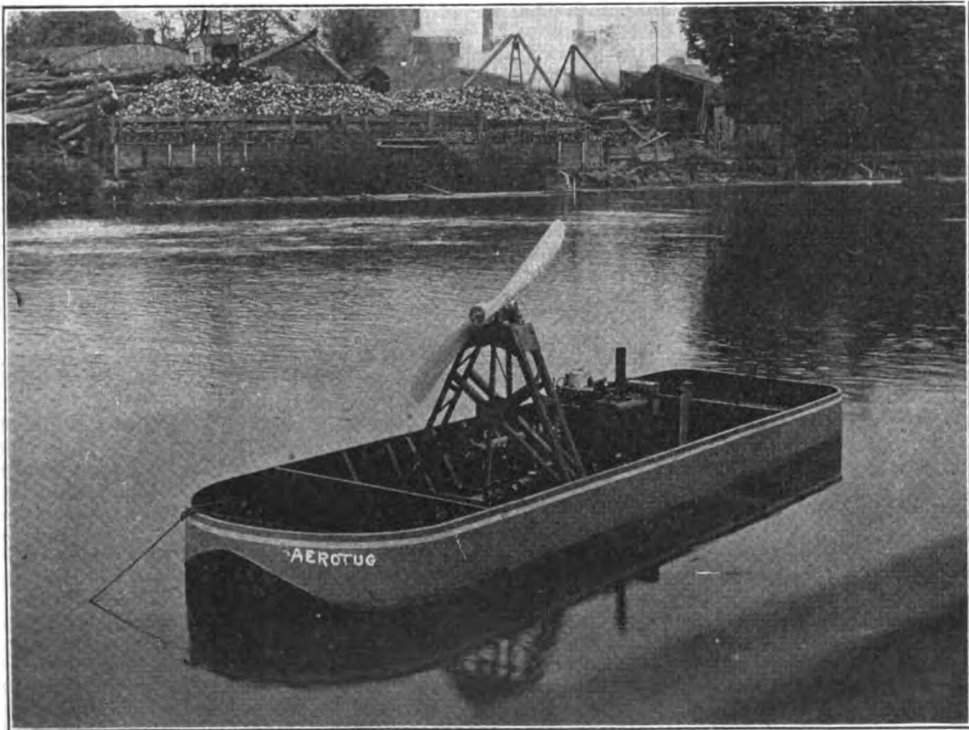

"A NOVEL MOTOR TUG."

a novel craft, which recently successfully underwent her trials on the River Thames.

The Aerotug was built by James Pollock, Sons & Co., Ltd., and was equipped with one of Bolinder's crude oil engines. It has a length of 30 feet and a breadth of 8 feet molded with a draft fore and aft of 8½ inches. It is a light draft punt with flat bottom and upright sides, constructed throughout of Siemens Martin steel. The internal combustion motor used for propulsion by driving an air propeller is a 15 B. H.P., single cylinder, Bolinder crude oil, direct reversible engine. This "Aerotug" was designed and engined for service in British Guiana, where it will be employed in towing.

A NOVEL SAFETY SECTIONAL BOILER FLUE EXPANDER.

By Frank C. Perkins.

The accompanying drawing shows a unique safety sectional boiler flue expander, which is operated with a reversible air mo-

tor instead of an air hammer. It was devised by F. W. Frank of Rocky Mount, N. C. The expanding elements are of the usual prosser type, which are forced out against the tube wall by a tapered mandrel. Instead

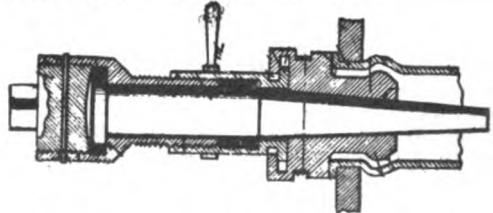

"A SELF-FEEDING SECTIONAL FLUE EXPANDER."

is forced into the expander by a threaded sleeve, which is turned by a reversible motor.

There is a shoulder on the end of the mandrel, which engages with a shoulder on the threaded sleeve and serves to extricate the mandrel when the motor is reversed. With this tool only one man is required for

expanding the flues, and all the flues are expanded exactly alike. The danger of flying steel by the breakage of the mandrel is eliminated, while it is maintained that the work is much more easily performed than is the case with a long-stroke air hammer.

ELECTRIC SPOT WELDERS.

By Frank C. Perkins.

The accompanying drawing, Fig. 1. shows some special electric welding die points used with the electric spot welder noted in photograph, Fig. 2, as developed at Cincinnati, O.

This electric welder was designed to rivet without punching holes or using rivets and spot welding, as indicated by the name, is the method they used in joining metal sheets electrically together at any desired point by a "spot" the size of a rivet. It is done by fusing or melting the metal at the point desired, and at the same instant applying sufficient pressure to force the particles of molten metal together. The theory

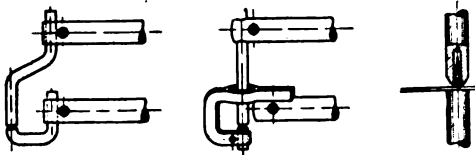

SPECIAL ELECTRICAL WELDING DIE POINTS.

is as simple as its application; it is a well-known principle that a poor conductor of electricity will offer so much resistance to the flow of the current that it will heat, the degree of heat depending on the amount of current and the resistance of the conductor.

It may be stated that the copper conductors carry the current with very little resistance and by placing a piece of iron in the circuit, not being so good a conductor as the copper, it will heat. If the volume of current is large and the iron conductor much smaller in diameter than the copper, the iron will quickly become hot enough to melt. An incandescent lamp offers a good illustration of this principle. The copper wires leading to the lamp are good conductors and remain cool. The carbon filament, being a poor conductor, becomes white hot and reaches a state of incandescence.

It is pointed out that in "spot" welding, a large volume of current at such low voltage or pressure that it cannot be felt by the bare hand passes through a pair of copper die-points; two or more pieces of sheet steel are placed between these die-points which press firmly on the stock. The current is turned "on" and the steel offers so much resistance to the flow of the current that it instantly begins to heat. The hotter the steel becomes the greater is the resistance to the passage of the electric current.

When the welding temperature is reached, the current is switched "off" and at the same time pressure is applied to force the molecules of molten metal together, and the pieces are perfectly united. The operations of turning the current "on" and "off" and getting the final squeeze to force the melted stock together after the current is switched "off" is done automatically with electric welding machines.

It will be noted that there is a limit to the thickness of sheet metal that it is ordinarily practicable to spot weld, due to two causes. First, the fact that the copper rods which conduct the electric current can only carry a certain quantity of current without excessive heating. When sufficient current is carried over these copper rods, or die-points, to bring very heavy bodies of metal up to the welding temperature, the copper rods will become so hot they will soften, and the points will wear away quite rapidly. Second, it is necessary to have the two pieces of sheet steel touch each other at the point where the weld is made. With very heavy stock, a slight kink or buckling of the metal will prevent the flat surfaces from touching each other and making good contact.

It may be stated that special machines have been designed, however, to overcome the difficulties referred to, but they were necessarily more expensive than the ordinary type of welding machines. Light gauges of sheet steel can be welded to heavy gauges or to solid bars of steel. It is not possible to weld two pieces of cast-iron, owing to the crystalline structure of the metal. Sheet steel can be welded to cast-iron, but can easily be pulled apart, the sheet steel tearing out small particles of cast-iron.

It is claimed that malleable iron of good quality can be welded to sheet steel, but will not stand as much strain as rolled steel or iron. Galvanized iron can be welded, although it will burn off the zinc at the spot where the weld is made. We do not advise electric welding for the very light gauges of galvanized iron, as there is no body of metal to work on. By the time the zinc is burned off there is nothing left. Twenty-eight gauge galvanized and heavier can be welded without any difficulty. Tin can be welded to tin or to sheet iron, but the stock will be discolored at the weld. Welding of crossed wires is an ideal job for a welding machine.

It is maintained that sheet brass and bronze can be welded to sheet brass or to sheet steel, but there is a little "knack" in work of this kind, and it takes a little experimenting to get just the right heat and pressure. German silver, Monel metal, zinc, nickel and alloys of many kinds are easily welded. Some grades of sheet aluminum can be spot-welded, although it will leave a slightly roughened and pitted surface where the die-points come together. It is more difficult to weld sheet copper to sheet copper, as this metal is such a good conductor

of the electric current that there is practically no resistance offered by the metal.

It is of interest to note that rivets of any size can be heated after the rivet is set in the rivet hole, and headed and pressed in place at one operation by the use of a welder. This process can be used to advantage in many places. Heat has no effect on the electric weld, and for this reason the welding process is largely used by stove manufacturers in making sheet-steel ranges and similar work. Regarding the current required, it is pointed out that a single-phase alternating current must be used in electric welding. This can usually be obtained from the local lighting company. If not, a 220-volt A. C. belted generator, or a motor gen-

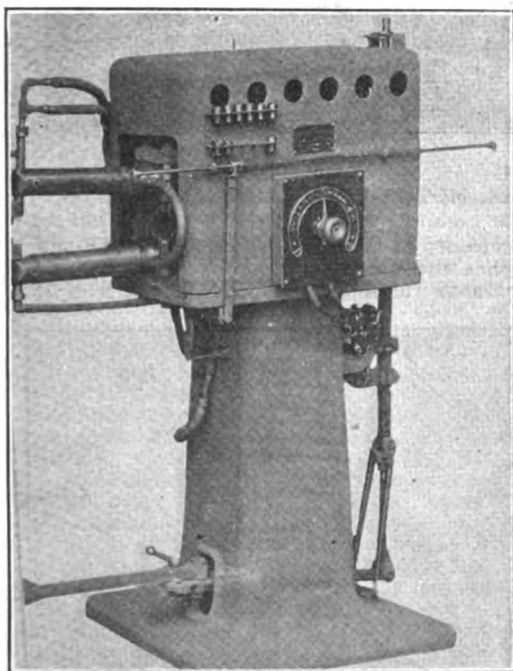

FIG. 1.
AN ELECTRICAL SPOT WELDING
MACHINE.

erator set, can be installed to operate the welding machine, and where 2 or 3-phase current is available, only 1 phase of the multiphase system is used. Any voltage from 110 to 600 can be utilized, but 220 or 440 is preferred. Any frequency from 25-cycle to 60-cycle can be used. Inside the welder, and part of it, is a special transformer to reduce this outside current to the 3 to 5 volts used in making the welds. This is so low it cannot be felt by the bare hand, and explains why it is absolutely safe for the operator, as he cannot by any possibility feel the current at the welding points.

The foot-operated machines shown in the illustration, Fig. 2, was designed for welding comparatively light stock. The regulator shown on the side of the machine allows the operator to adjust the amount of current, or the "heat," to the work he is doing. It doesn't require as much heat to weld two pieces of 30-gauge as it does to weld two pieces of 10-gauge, and he has this heat absolutely under his control. Once adjusted, it will never vary, so that he will always get uniform results with no danger of burning or overheating the stock. The operation of the machine is practically automatic. The operator places the stock between the copper die-points and presses on the foot treadle; that brings the points firmly down on the work, and then the current is automatically turned on.

It may be stated that the stock is instantly brought up to the welding temperature; the foot treadle is pushed down a little further, the current is cut off and the pressure given immediately after the current is shut off forces the semi-molten metal together and it "sets" by the time the pressure is released. It's all done automatically with a special switch, without any attention from the operator. Releasing the foot pressure and the die-points open and the switch sets itself ready for the next weld. In welding heavy gauges of stock where it is badly buckled, the adjacent surfaces will not touch. In cases of this kind, the foot pressure used to force the uneven surfaces together would trip the switch before a weld could be made. To take care of this condition, a hand-operated switch-closing push rod is placed on the side of the machines.

A locking device on the upper part of the back bar is quickly pushed in position—this prevents the spring and switch from acting, but allows a direct foot leverage on the work. When sufficient pressure is applied to force the parts together, the current is turned "on" by pressing the push rod with the hand, and turned "off" when the rod is released. With this device, it is possible to do work that could not be done with the regular foot-operated machine. The machines are so simple any girl or boy can operate them, and they are absolutely safe. The operator can't get the slightest shock if he tries.

Another type of electric welder has been designed for welding iron and steel up to $\frac{1}{2}$ -inch round; also copper $\frac{1}{4}$ -inch, and brass $\frac{3}{8}$ -inch round. This machine occupies a floor space 18 inches by 21 inches and is 50 $\frac{1}{4}$ inches high. The height to center of clamping jaws is 42 inches and the distance from frame to center of dies is 1 $\frac{1}{4}$ inches. The maximum die opening is 1 inch high, 1 $\frac{1}{4}$ inches wide with solid copper dies, 1 $\frac{1}{4}$ inches wide and 1 $\frac{1}{2}$ inches long, and 1 inch deep. The maximum power required is 8 K. W. (12 K. V. A.), 12 H. P., and it has a weight of 800 pounds. The regulator is mounted on side of welder and it has water cooled dies.

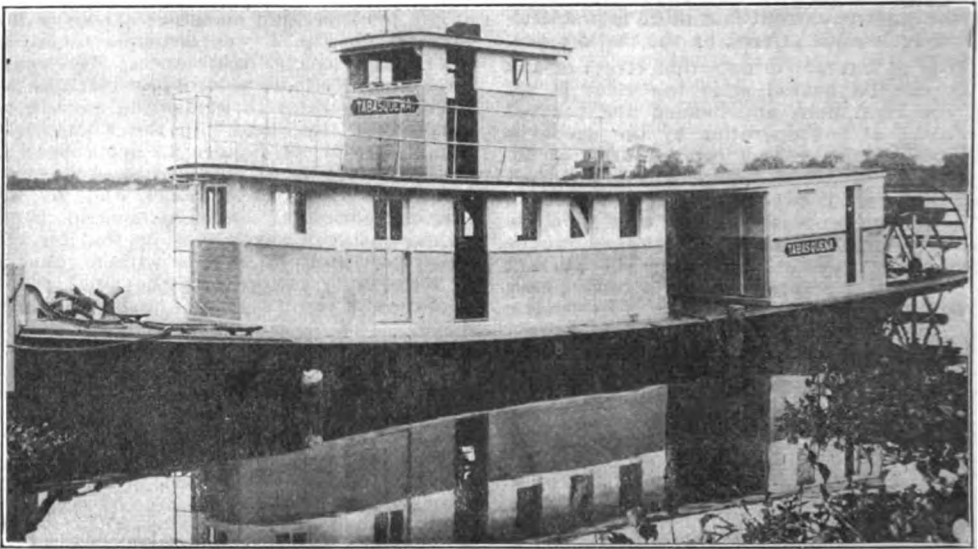

FIG. 1.
THE STERN WHEEL PUSH AND PULL MOTOR TUG "TABASQUENA."

This electric welder is mounted on legs and the clamping jaws are operated by a foot treadle, that makes it more convenient to operate. The output of the machine is only limited by the number of pieces an operator can handle in a day. The expense for current stops the instant the weld is made and the operator can weld wire frames at the rate of 3,800 per day.

THE UNIQUE STERN WHEEL PUSH AND PULL MOTOR TUG "TABASQUENA."

By Frank C. Perkins.

The accompanying illustrations show the design of a peculiar gasoline stern wheel push and pull motor tug, "Tabasquena," placed in service by Engineer Percy Stout of Frontera, Mexico. It has a length of hull of fifty feet and a length over all of sixty feet, the beam molded being twelve feet and the beam over all measuring 12 feet, 7 inches.

The shoal depth is 2 feet, 9 inches, and the draft even keel is 20 inches, while the running draft forward is 22 inches, the running draft aft being 18 inches. The displacement on working draft is 20½ tons, approximately. The power plant consists of a 6-cylinder Buffalo gasoline engine, with air starting and dual high tension ignition of Bosch & Delco type. The transmission consists of bevel gears running in oil-tight case and chain and sprocket, the ration of reduction being 13 3-10 to 1.

The paddle wheel consists of a 10-arm wheel, split with 20 buckets, the outside diameter of wheel being 8 feet, six inches, and the wheel speed being 35 R. P. M. The fuel is gasoline and is carried in two tanks below deck in sealed compartment. The

capacity of tanks is 400 gallons, which supplies the necessary fuel for 50 hours' continuous running at full speed, which is 12



FIG. 2.
"THE TABASQUENA ON THE STOCKS."

statute miles per hour. This boat is operated by the Atlantic Fruit Company on the Grijalva, Tacotalpa, Mexcalapa and Sierra Rivers in the state of Tabasco, Mexico. Its work is to handle fruit barges against a 3¼-

mile current, making 21-mile trips in 5 hours flat.

It is stated that the 6-cylinder, 7 by 7-inch gasoline engine at 375 R. P. M. consumed 6 8-10 gallons per hour, and at full speed, 500 R. P. M., taking 7 6-10 gallons. This is decidedly economic in comparison with other tugs of the same power in this district.

CONVENTION CALL. Labor Omnia Vincit.

American Federation of Labor Headquarters,
801-809 G Street N. W., Wash-
ington, D. C.

September 13, 1915.

To All Affiliated Unions, Greeting:

You are hereby notified that, in pursuance of the Constitution of the American Federation of Labor, the thirty-fifth annual convention of the American Federation of Labor will be held at Eagles' Hall, San Francisco, Cal., beginning 10 o'clock, Monday morning, November 8, 1915, and will continue in session from day to day until the business of the convention has been completed.

Representation.

Representation in the convention will be on the following basis: From National or International Unions, for less than 4,000 members, one delegate; 4,000 or more, two delegates; 8,000 or more, three delegates; 16,000 or more, four delegates; 32,000 or more, five delegates; 64,000 or more, six delegates; 128,000 or more, seven delegates, and so on; and from Central Bodies and State Federations, and from local trade unions not having a National or International Union, and from Federal Labor Unions, one delegate.

Organizations to be entitled to representation must have obtained a certificate of affiliation (charter), at least one month prior to the convention; and no person will be recognized as a delegate who is not a member in good standing of the organization he is elected to represent.

Only bona fide wage-workers, who are not members, of, or eligible to membership in other trade unions, are eligible as delegates from Federal Labor Unions.

Delegates must be selected at least two weeks previous to the convention, and their names forwarded to the Secretary of the American Federation of Labor immediately after their election.

Delegates are not entitled to seats in the convention unless the tax of their organization has been paid in full to September 30, 1915.

It is, of course, entirely unnecessary here to enumerate the important subjects with which our forthcoming convention will concern itself, but the reminder is not at all amiss that every effort must be made to broaden the field and means for the organization of the yet unorganized workers, to strive to bring about more effectually than ever a better day in the lives and homes of the toilers, to defend and maintain by

every honorable means in our power the right to organize for our common defense and advancement, for the exercise of our normal and constitutional activities to protect and promote the rights and interests of the workers; and to assert at any risk the freedom of speech and of the press and the equal rights before the law of every worker with every other citizen; the tremendous conflict now being waged in Europe and its possible consequences and results, not only upon the people of European countries but upon the people of America, as well as on the whole civilized world, must of necessity receive the deepest solicitous consideration of the working people of America. How and what further action can be taken by the American labor movement to help bring about an early peace among the warring nations of Europe; how that peace can be secured with the establishment and maintenance of justice, freedom, and brotherhood the world over. These and other great questions of equal importance will, of necessity, occupy the attention of the San Francisco convention.

Therefore the importance of our movement, the duty of the hour and for the future, demand that every organization entitled to representation shall send its full quota of delegates to the San Francisco convention, November 8, 1915.

Do not allow favoritism to influence you in selecting your delegates. Be fully represented.

Be represented by your ablest, best, most experienced and faithful members.

Credentials.

Credentials in duplicate are forwarded to all affiliated unions. The original credential must be given to the delegate-elect and the duplicate forwarded to the American Federation of Labor office, 801-809 G Street Northwest, Washington, D. C.

The Committee on Credentials will meet at the headquarters of the American Federation of Labor six days previous to the opening of the convention, and will report immediately upon the opening thereof at San Francisco; hence secretaries will observe the necessity of mailing the duplicate credentials of their respective delegates at the earliest possible moment to Washington, D. C.

Grievances.

Under the law no grievance can be considered by the convention which has been decided by a previous convention, except upon the recommendation of the Executive Council, nor will any grievance be considered where the parties thereto have not themselves previously held conference and attempted to adjust the same.

Railroad Rates.

Application was made for a reduced railroad rate on account of our convention, and in answer to same, we were advised of the special excursion fares to the Pacific Coast in connection with the Exposition that obtain for 1915, these being the best rates that could be granted.

Hotel Rates.

Hotel Sutter, corner Kearny and Sutter streets—56 rooms without bath, single, \$1.50 per day; double, \$2.00 per day.

Seven rooms with bath, single, \$2.00 per day; double, \$2.50 per day.

Thirty-six rooms with bath—Single, \$3.00 per day; double \$4.00 per day, European plan.

Ninety-eight rooms with bath, single, \$2.50 per day; double, \$3.50 per day.

Twenty-one rooms with bath—Single, \$2.00 per day; double, \$3.00 per day.

Hotel Argonaut, Fourth street, near Market—\$1.00 to \$4.00 per day for each person, European plan.

Hotel Lankershim, Fifth street, near Market—Single, \$1.00 per day, up; double, \$1.50 per day, up, European plan; single, with bath, \$1.50 per day, up; double, with bath, \$2.00 per day, up, European plan.

Reservations in any of the above hotels may be made by addressing Mr. John A. O'Connell, secretary of the San Francisco Labor Council, Labor Temple, Sixteenth and Capp streets, San Francisco.

Headquarters of Executive Council will be Hotel Sutter.

Delegates should notify John A. O'Connell, in advance, of the time of their arrival in San Francisco, and over which road they will travel.

If there be any further information regarding the convention, or arrangements for the convenience of the delegates, it will be communicated in a later circular or through the American Federationist.

Faternally yours,

SAML. GOMPERS,

President.

Attest:

FRANK MORRISON,

Secretary.

JAMES DUNCAN, 1st Vice-Pres.

JAMES O'CONNELL, 2nd Vice-Pres.

D. A. MAYES, 3rd Vice-Pres.

JOS. F. VALENTINE, 4th Vice-Pres.

JOHN R. ALPINE, 5th Vice-Pres.

H. B. PERHAM, 6th Vice-Pres.

FRANK DUFFY, 7th Vice-Pres.

WILLIAM GREEN, 8th Vice-Pres.

JOHN B. LENNON, Treasurer.

Executive Council, American Federation of Labor.

Secretaries will please read this call at first meeting of their organization. Labor and reform press please copy.

Poetical Selections.

THE SECRET.

The way to reach the man who toils
Amid the dingy workings
Is not by stratagems and spoils
Or oily smiles and smirking.
You give him model homes and such,
Or clubs in which to revel.
You still will find yourself in "Dutch,"
Unless you're on the level.

It isn't coddling that he likes,
Or lordly condescension;
Such methods will not stop his strikes
Or banish all contention.
You must be fair and square and just,
A man among your brothers,
Before old doubtings turn to trust
Or ancient hatred smother.

Whatever motives yours may be,
In times be sure to find it.
He looks through every deed to see
The spirit that's behind it.
And though he may misunderstand,
Repel, at first, and doubt you,
He'd warmly grasp the proffered hand
When he is sure about you.

The boys within the breaker shed,
The miners deep below them,
Are slow of faith and hard of head;
You've simply got to show them,
And prove your varied aims and ends
Are not those of the devil—
For man and master can be friends—
If both are on the level.

—Selected.

THE OTHER FELLOW'S JOB.

The farmer looks discouraged,
He hates the rake and hoe;
He wants to try the city,
Where money seems to grow.
The other fellow gets the grain,
And leaves for him the cob,
So in his heart he covets
The other fellow's job.

The business man is worried,
Both ends will scarcely meet;
Last month he lost a million
Upon a deal in wheat.
He looks with longing to the farm,
And drops a tearful sob;
It seems to him like heaven—
The other fellow's job.

The doctor notes with envy
The lawyer's bouncing roll,
And wishes he had studied
With Blackstone as his goal.
The clerk is far from satisfied,
He sees the artist's daub,
And cries, "Oh, how much better!
The other fellow's job."

'Tis quite the style to grumble
And sigh for other stars,
To wish we were transported
To somewhere, even Mars;
And if we reach the Happy Land
This though the joy will rob,
For some will surely covet
The other fellow's job.

In Memoriam

Relatives of Members.

Wm. H. King, age 82, father of Brothers N. A. and E. B. King, of Lodge No. 100. Was born in Washington Parish, La., March 28, 1836, died August 9, 1915, from inflammation of stomach, at Marshall, Texas.

Lodge Notices

Sheldon—Lodge No. 493.

Any secretary taking up the card of Ben B. Sheldon, Reg. No. 52579, will please hold same and correspond with the undersigned, as this brother's card mysteriously disappeared from here some time ago.

DAVID LEWIS, S. L. 493.

Seigler—Lodge No. 549.

Any secretary taking up the card of Brother E. R. Seigler, Reg. No. 68353, please hold same and correspond with secretary of Lodge No. 549, as this brother left here owing a bill of \$3.00, which a brother stood for.

PERRY COOPER, S. L. 549.

McGrath and Steinhaus—Lodge No. 302.

Brothers Wm. McGrath, Reg. No. 17382, and August Steinhaus, Reg. No. 81321, are requested to correspond with the secretary of Lodge No. 302 and explain how they secured certain meal tickets. They are accused by members of Lodge No. 302, with forgery of them.

HUGH J. FULLER, S. L. 302.

Walsh—Lodge No. 209.

If Brother M. D. Walsh, Reg. No. 48400, will correspond with the secretary of Lodge No. 209 he will learn something of value to himself.

S. E. HARRIS, S. L. 209.

Looney—Lodge No. 209.

Any secretary taking up the card of Brother Robt. T. Looney, Reg. No. 85224, will please hold same and correspond with the secretary of Lodge No. 209.

S. E. HARRIS, Sec'y.

Notice.

To Whom It May Concern:

Harry Hand, unfair boiler maker, from Pere Marquette shop of Grand Rapids, Mich., whose register number was 72040, is now working as demonstrator for Prestolite Welding Co. This man went back to work and worked during entire length of strike. All organized labor, especially in closed shops, should watch out for this man and try to have him prevented from doing any demonstrating or any work of any kind in connection with it.

J. B. BEENEN,
JOS. W. SUTCLIFFE,
NELSON M. WARREN,

Heath—Daughter.

Anyone knowing the whereabouts of James H. Heath, once of Ottumwa, Ia., will

please notify the undersigned, his daughter.
EDITH M. HEATH,
Ft. Benton, Mont.

Ennis—Lodge No. 346.

Any secretary taking up the clearance card of J. J. Ennis, Reg. No. 24751, will please hold same and correspond with the secretary of Lodge No. 346, as this brother left here owing some bills he misrepresented.

GEO. W. SINGER, S. L. 346.

Hiell—Lodge No. 588.

Any secretary taking up the card of Brother F. S. Hiell, Reg. No. 43811, will please hold same and correspond with the secretary of Lodge No. 588, as this brother borrowed money. Last stamps and clearance card issued by Lodge No. 70.

JOHN McNANEY, S. L. 588.

Kelley—Lodge No. 222.

Any secretary taking up the card of Brother J. R. Kelley, boiler maker helper, Reg. No. 102852, will please hold same and notify secretary of Lodge No. 222, account debt due lodge.

G. W. COATES, Sec'y. 222.

Jeffries—Magoon.

Anyone knowing the whereabouts of W. J. Jeffries, formerly of Cedar Rapids, Ia., will please notify the undersigned. His wife is dangerously ill.

C. H. MAGOON,
610 Sixth Avenue East, Cedar Rapids, Ia.
Care Mrs. Munn.

Farley—O'Neil.

Anyone knowing the whereabouts of Frank Farley, recently from Mexico, between 35 and 40 years of age, who speaks fluent Spanish, please notify me at once.

J. P. O'NEIL,
708 E. Rusk St., Marshall, Tex.

LIST OF MEMBERS PREVIOUSLY ADVERTISED

E. L. Chaffin—Lodge No. 587.

We have suspended Brother E. L. Chaffin for not paying dues or honest debts. I, myself, loaned this brother some money to bury his little child, and he will not pay it back. He also owes several bills that he won't pay.

C. C. MADDY,
Corresponding Secretary Lodge No. 587.
April Journal.

W. M. Horstmeyer—Lodge No. 381.

Any secretary taking up the card of Brother W. M. Horstmeyer, Reg. No. 9735, please hold same and correspond with Joe Wilson, secretary Lodge No. 381, Amarillo, Tex., as this brother borrowed some money from this lodge which he has forgotten to return.

JOE WILSON,
April Journal. Lodge No. 381.

Thompson—Lodge No. 587.

F. W. Thompson, Reg. No. 20987, has been suspended by this local for non-payment of dues. He also owes about \$40 here.

T. C. MADDY,
June Journal. Secretary Lodge No. 587.

Cooper et al.—Lodge No. 491.

The following names are brothers who left Lodge No. 491 with bills unpaid: C. E. Cooper, boiler maker, bill to F. C. Krull & Co. for clothing, \$12.35. A. J. Conelly, bill to F. C. Krull & Co. for clothing, \$3.95. John Peters, Reg. No. 80223, to F. C. Krull & Co. for clothing, \$5.50. Joseph Regan, Reg. No. 95180, to F. C. Krull & Co. for clothing, \$2.40, and board and room to Sutton Sisters, \$8.83; total, \$11.23. J. M. Morgan, Reg. No. 91068, borrowed money from Local No. 491, \$2.50. Helpers: W. J. Mills, Reg. No. 98504, withdrawal card out of Local No. 145, owes F. C. Krull & Co. for clothing, \$6.40. C. A. Riley, debtor to F. C. Krull & Co. for clothing, \$4.25.

J. J. CARROLL,
June Journal. Secretary No. 491.

C. S. Burk—Lodge No. 82.

Any secretary taking up card of Brother C. S. Burk, Reg. No. 102470, will please hold same and correspond with secretary of Lodge No. 82, as this brother misrepresented facts to secure transportation to Kansas City, amounting to \$1.25, and we had to pay this bill out of the treasury of the local.

A. G. EVERETT,
June Journal. Secretary Lodge No. 82.

Robert Canton—Lodge No. 384.

Anyone knowing the whereabouts of Robert Canton, boiler maker's helper, will please notify the secretary of Lodge No. 384, as this brother left this lodge without paying his bills that the lodge went good for.

H. W. JOHNSON,
July Journal. Secretary Lodge No. 384.

W. C. Shrout—Lodge No. 82.

Any secretary taking up the card of Brother W. C. Shrout, Reg. No. 52553, will please hold same and correspond with the Secretary of Lodge No. 82, Osawatomie, Kas., as this brother left this lodge owing a \$9 board bill to Mrs. G. H. Troxell,

A. G. EVERETT,
July Journal. Secretary Lodge No. 82.

Shrout—Lodge No. 521.

Any secretary taking up the card of Brother W. C. Shrout, Reg. No. 52553, will please hold same and correspond with secretary of Lodge No. 521, as this brother misrepresented facts to secure transportation from Van Buren, Ark., to Coffeyville, Kas., amounting to \$4.95, and Local No. 521 had to pay same.

OTTY PYLES,
Corresponding Secretary Lodge No. 521.
July Journal.

Douglas et al.—Lodge No. 587.

Lodge No. 587 has suspended M. E. Douglas, Reg. No. 100307, for non-payment of dues. We have also bills aggregating to

\$80 against this brother. T. C. MADDY,
Secretary and Treasurer Lodge No. 587.
July Journal.

D. J. Fitzgibbons et al.—Lodge No. 99.

Any secretary taking up the card of D. J. Fitzgibbons, Reg. No. 67599, or F. G. Hayes, Reg. No. 21882, will please correspond with the secretary of Lodge No. 99, Newark, Ohio, as these brothers borrowed money from this local which they forgot to return.

CECIL C. ROBERTS,
July Journal. Secretary Lodge No. 99.

C. J. Dowd—Lodge No. 199.

Anybody knowing the whereabouts of C. J. Dowd, Reg. No. 96128, helper, left Lodge No. 199 without a card, and also owing a board bill of \$29 and other bills. Last stamp in his book issued by Lodge No. 113. Please notify the undersigned.

Aug. Journal. E. S. MCGINNIS, S. L. 199.

W. C. Shrout—Lodge No. 82.

Any secretary taking up the card of W. C. Shrout will please hold same and correspond with the undersigned, as this brother secured transportation from Osawatomie, Kas., to Kansas City on an unsatisfactory service letter and Lodge No. 82 had to pay for some.

A. G. EVERETT,
Aug. Journal. S. L. No. 82.

C. E. Cooper—Lodge No. 528.

Any secretary taking up the card of Brother C. E. Cooper, Reg. No. 41907, will please hold same and correspond with the undersigned, as this brother left here in 1913 and left unpaid bills that Brother Ed Swanson stood good for and had to pay.

J. H. THOMAS, S. L. No. 528.
Aug. Journal.

Linden—Lodge No. 582.

Any secretary taking up the card of Brother C. G. Linden, helper, Reg. No. 103719, please hold same and correspond with the undersigned, as this brother left here owing a board bill for the sum of \$19.40 and a tobacco bill for \$1.30. Brother George Will stood good for this brother and got him a job and he worked up to one day before pay day and left. Brother Will will appreciate it very much if he can be located.

S. V. ACOSTA, C. S. L. No. 582.
August Journal.

Brother Frederick Schultz—Lodge No. 10.

Any secretary taking up the card of Brother Frederick Schultz, Reg. No. 5235, will please hold same and correspond with the secretary of Lodge No. 10.

Aug. Journal.

Jas. A. Schofield—Lodge No. 419.

Brother James A. Schofield, Reg. No. 53752, left here owing bills to members and merchants. Any secretary taking up card hold same until bills are paid.

J. S. ARNOLD, C. S. L. No. 419.
Aug. Journal.

KANSAS CITY, KAS., NOVEMBER, 1915.

THE BOILERMAKERS JOURNAL



OFFICIAL ORGAN OF THE
INTERNATIONAL BROTHERHOOD
OF BOILERMAKERS, IRON SHIP BUILDERS
AND HELPERS OF AMERICA



*"A smile of
satisfaction
with every
pair."*

HEADLIGHT OVERALLS

(Union Made)

There's roominess and comfort in Headlights that you don't get in other overalls.

Better materials—fuller cut—better workmanship. Will outwear two pairs of the ordinary kind.

Guaranteed the best overalls you ever bought or money back after 30 days' wear

Look for this ticket

Larned, Carter & Co., Detroit
World's Greatest Overall Makers

Factories: Detroit and Port Huron, Mich.,
St. Louis, Mo., San Francisco, Cal.
Canadian Factory: Sarnia, Ont.



SECURITY SECTIONAL ARCH

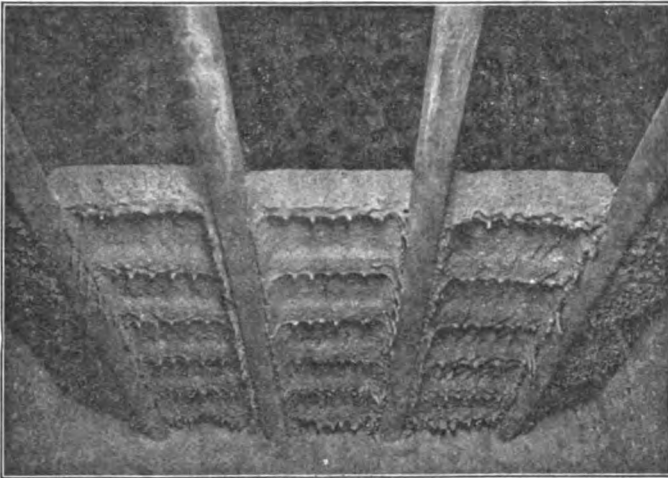

This arch is of light weight
It is built up of small sections
So made as to cool off quickly
It is easily removed for work
Made so to help the boilermaker

AMERICAN ARCH COMPANY

30 CHURCH STREET, NEW YORK

McCORMICK BUILDING, CHICAGO



Stifel's Indigo Cloth

DATES BACK TO THE FIRST RAILROADS
ASK FOR OVERALLS, JUMPERS, UNIFORMS OF
Stifel's Indigo
STANDARD FOR OVER 75 YEARS

STIFEL'S INDIGO
is the "fabric indestructible." Will not fade—easy to wash and iron. Look for this trade mark on the back of the material, on the inside of garment. That's your guarantee of the genuine.



Cloth manufactured by

J. L. Stifel & Sons

Indigo Dyers and Printers - Wheeling, W. Va.

SALES OFFICES

- | | | | |
|-------------------------|------------------------|---------------------|-----------------------|
| New York | 260-262 Church St. | Baltimore | 114 W. Fayette St. |
| Philadelphia | 324 Market St. | St. Louis | 425 Victoria Bldg. |
| Boston | 31 Bedford St. | St. Paul | 238 Endicott Bldg. |
| Chicago | 223 West Jackson Blvd. | Toronto | 14 Manchester Bldg. |
| San Francisco | Postal Telegraph Bldg. | Winnipeg | 400 Hammond Bldg. |
| St. Joseph, Mo. | Sutton Bank Bldg. | Montreal | 400-402 St. James St. |

The Boilermakers' Journal

Official Organ of the
**International Brotherhood of Boilermakers
Iron Ship Builders and Helpers of America**

Vol. XXVII.

KANSAS CITY, KAS., NOVEMBER, 1915.

No. 11.

THIRD SECTION OF REPORT OF BASIL M. MANLY, DIRECTOR OF RESEARCH AND INVESTIGATION, CONTAINING FINDINGS OF FACT AND RECOMMENDATIONS OF THE STAFF.

Report in full accepted and ordered printed by resolution of commission. Adopted by Commissioners Frank P. Walsh, John B. Lennon, James O'Connell and Austin B. Garretson.

Evidence in support of the statement that the lives of millions of wage earners are subject to the dictation of a relatively small number of men, is cited at length in the third and final section, made public today, of the report of Basil M. Manly, director of Research and Investigation for the United States Commission on Industrial Relations.

The following allegations are made as statements of fact based on the testimony and evidence in the hands of the commission.

"Except, perhaps, for improvements in safety and sanitation, the labor conditions of corporation-controlled industries are subject to grave criticism and are a menace to the welfare of the nation.

"In order to prevent the organization of employees for the improvement of working conditions, elaborate systems of espionage are maintained by the larger corporations which refuse to deal with labor unions, and employees suspected of union affiliation are discharged.

"The domination by the men in whose hands the final control of a large part of American industry rests is not limited to their employes, but is being rapidly extended to control the education and 'social service' of the Nation.

"This control is being extended largely through the creation of enormous privately managed funds for indefinite purposes, hereinafter designated 'foundations,' by the endowment of colleges and universities, by the creation of funds for the pensioning of teachers, by contributions to private charities as well as through controlling or influencing the public press."

The Rockefeller Foundation's entrance into the field of industrial relations, through the creation of a special division, it is declared, "constitutes a menace to the national

welfare to which the attention not only of Congress, but of the entire country, should be directed. Backed by the \$100,000,000 of the Rockefeller Foundation, this movement has the power to influence the entire country in the determination of its most vital policy."

Mr. Rockefeller is charged with planning to utilize literature which was known to him at the time to be untrue and misleading in a so-called "Union educational campaign."

There is developing, says the report, a degree of control over the teaching of professors in our colleges and universities, which constitutes a most serious menace.

Urges Congress to Act.

Congress is urged to enact a statute providing that all incorporated non-profit-making bodies, whose present charters empower them to perform more than a single specific function and whose funds exceed \$100,000,000, shall be compelled to secure a Federal charter.

The charter, it is urged, should contain provision limiting the funds, definitely and exactly specifying the powers, providing rigid inspection of finance, providing complete publicity, and providing that no line of work not specifically mentioned in the articles of incorporation shall be entered upon without the unanimous consent and approval of the Board of Trustees nor unless Congress is directly informed of such intention.

Congress is further urged to make provision for a thorough investigation of all endowed institutions both secular and religious, whose property holdings or income exceeds a moderate amount.

The third recommendation touching upon the work of foundations is that Governmental activity along the lines of education and social service should be increased as the only effective means of counteracting the influence of the foundations as long as they are permitted to exist.

The report says in full regarding concentration of wealth:

"The evidence developed by the hearings and investigations of the Commission is the basis for the following statements:

1. The control of manufacturing, mining and transportation industries is to an in-

creasing degree passing into the hands of great corporations through stock ownership, and control of credit is centralized in a comparatively small number of enormously powerful financial institutions. These financial institutions are in turn dominated by a very small number of powerful financiers.

2. The final control of American industry rests, therefore, in the hands of a small number of wealthy and powerful financiers.

3. The concentration of ownership and control is greatest in the basic industries upon which the welfare of the country must finally rest.

4. With few exceptions each of the great basic industries is dominated by a single large corporation, and where this is not true, the control of the industry through stock ownership is supposedly independent corporations and through credit is almost, if not quite, as potent.

5. In such corporations, in spite of the large number of stockholders, the control through actual stock ownership rests with a very small number of persons. For example, in the United States Steel Corporation, which had in 1911 approximately 100,000 shareholders, 1.5 per cent of the stockholders held 57 per cent of the stock, while the final control rested with a simple private banking house.

Similarly in the American Tobacco Co., before the dissolution, 10 stockholders owned 60 per cent of the stock.

6. Almost without exception the employes of the large corporations are unorganized, as a result of the active and aggressive "nonunion" policy of the corporation managements.

Furthermore, the labor policy of the large corporations almost inevitably determines the labor policy of the entire industry."

Extent of Control.

7. "A careful and conservative study shows that the corporations controlled by six financial groups and affiliated interests employ 2,651,684 wage earners and have a total capitalization of \$19,875,200,000. These six financial groups control 28 per cent of the total number of wage earners engaged in the industries covered by the report of our investigation. The Morgan-First National Bank group alone controls corporations employing 785,499 wage earners. That this control is effective is shown by the following telegram from J. P. Morgan to E. H. Gary:

Aix les Bains.

E. H. Gary, New York.

Have received your cable of yesterday. My own views are in accordance with those of the financial committee in New York. Certainly until question of wages has been settled by the coal and railroads, which still in abeyance but settlement seems imminent. Whole question wages should be settled simultaneously by all interests is possible. Going Paris Wednesday. Will see there H. C. F., P. A. B. W., and will cable you result of interview. If possible and meets your approval, think better wait until after inter-

view. Perfectly delightful here. Weather superb.

J. P. M.

8. The lives of millions of wage earners are, therefore, subject to the dictation of a relatively small number of men.

9. These industrial dictators for the most part are totally ignorant of every aspect of the industries which they control, except the finances, and are totally unconcerned with regard to the working and living conditions of the employes in those industries. Even if they were deeply concerned, the position of the employes would be merely that of the subjects of benevolent industrial despots.

10. Except, perhaps, for improvements in safety and sanitation, the labor conditions of these corporation-controlled industries are subject to grave criticism, and are a menace to the welfare of the Nation.

11. In order to prevent the organization of employes for the improvement of working conditions, elaborate systems of espionage are maintained by the large corporations which refuse to deal with labor unions, and employes suspected of union affiliation are discharged.

12. The domination by the men in whose hands the final control of a large part of American industry rests is not limited to their employes, but is being rapidly extended to control the education and "social service" of the Nation.

13. This control is being extended largely through the creation of enormous privately managed funds for indefinite purposes, hereinafter designated "foundations," by the endowment of colleges and universities, by the creation of funds for the pensioning of teachers, by contributions to private charities, as well as through controlling or influencing the public press.

14. Two groups of the "foundations", namely, the Rockefeller and Carnegie Foundations, together have funds amounting to at least \$250,000,000, yielding an annual revenue of at least \$13,500,000, which is at least twice as great as the appropriations of the Federal Government for similar purposes, namely, education and social service.

15. The funds of these foundations are exempt from taxation, yet during the lives of the founders are subject to their dictation for any purpose other than commercial profit. In the case of the Rockefeller group of foundations, the absolute control of the funds and of the activities of the institutions now and in perpetuity rests with Mr. Rockefeller, his son, and whomsoever they may appoint as their successors."

The Rockefeller Foundation.

16. "The control of these funds has been widely published as being in the hands of eminent educators and public-spirited citizens. In the case of the Rockefeller foundations, however, not only is the control in the hands of Mr. John D. Rockefeller, Jr., and two of the members of the personal staff of Mr. John D. Rockefeller, Sr., who

constitute the finance committee, but the majority of the trustees of the fund are salaried employes of Mr. Rockefeller or the foundations, who are subject to personal dictation and may be removed at any moment.

17. The funds of these foundations are largely invested in securities of corporations dominant in American industry, whose position has been analyzed under the early headings of this section. The policies of these foundations must inevitably be colored, if not controlled, to conform to the policies of such corporations.

18. The funds of the foundations represent largely the results either of the exploitation of American workers through the payment of low wages or of the exploitation of the American public through the exaction of high prices. The funds, therefore, by every right, belong to the American people.

19. The powers of these foundations are practically unlimited, except that they may not directly engage in business for profit. In the words of President Schurman of Cornell, himself a trustee of the Carnegie Foundation:

20. The charters of these foundations, with their almost unlimited powers, were granted under conditions of such laxity that it has been testified by an eminent legal authority who made an extensive investigation that those granted by New York State are legally defective and unconstitutional. Furthermore, evidence developed by the hearings of the Commission showed that in increasing the number of its trustees without complying with the requirements of the law governing corporations, the Rockefeller Foundation has already been guilty of a breach of the law.

21. These foundations are subject to no public control, and their powers can be curbed only by the difficult process of amending or revoking their charters. Past experience, as, for example, in the case of the insurance companies, indicates that the public can be aroused only when the abuses have become so great as to constitute a scandal.

22. The entrance of the foundations into the field of industrial relations, through the creation of a special division by the Rockefeller Foundation, constitutes a menace to the national welfare to which the attention not only of Congress but of the entire country should be directed. Backed by the \$100,000,000 of the Rockefeller Foundation, this movement has the power to influence the entire country in the determination of its most vital policy."

Basis Not Social.

23. "The documentary evidence in the possession of the Commission indicates:

(a) That the so-called "investigation of industrial relations" has not, as is claimed, either a scientific or a social basis, but originated to promote the industrial interests of Mr. Rockefeller. The original letter inviting Mr. W. L. Mackenzie King to asso-

ciate himself with the Rockefellers stated that Mr. Rockefeller and Mr. Greene in "their purely corporate capacity as owners and directors of large industries" desired his aid.

(b) That the investigation forms part of what Mr. Rockefeller, in a letter to Mr. Ivy L. Lee (the press agent of the Colorado operators), called the "union educational campaign", which is referred to by Mr. Bowers as "the fight for the open shop", the results of which are clearly manifested in the conditions existing in the camps of the Colorado Fuel & Iron Company, conducted on the "open shop" principle.

(c) That Mr. Rockefeller planned to utilize in this campaign literature containing statements which were known to him at the time to be untrue and misleading (as for example the numerous misstatements in the "Sermon to Young Men" of Dr. Newell Dwight Hillis, including the statement that the Colorado operators offered to recognize the miners' union), and also literature containing statements which constituted a malicious libel upon a large body of American citizens—for example, the following statement of Prof. John J. Stevenson: "Labor unions defy the law but are every ready to demand its protection; their principles are no better than those of the India Thugs, who practiced robbery and murder in the name of the goddess Cal."

(d) That the investigation of industrial relations is not being made in good faith, inasmuch as its director states that he will not now nor hereafter make public his findings regarding a most important part of his investigation, namely, the investigation in Colorado.

24. The purpose of Mr. Rockefeller to influence the public press is clearly shown by the employment of an experienced publicity expert as a member of his personal staff, and is indicated by his evident interest in the ownership or control of a number of publications, of which we have records dating from the inquiry of his secretary regarding the Pueblo Star Journal in May, 1913, to the extensive conferences regarding a loan of \$125,000 to finance The Nation's Business, the organ of the National Chamber of Commerce, which was established and given a semi-official status through the instrumentalities of the Secretary of Commerce and Labor with the sanction of a former president of the United States."

Extent of Influence.

25. "The extent of the possible influence of these foundations and private endowments of institutions for education and public service is shown by a large amount of evidence in the possession of the Commission. The following examples may be cited:

(a) The adoption of a definite line of policy by the Bureau of Municipal Research of New York to meet the conditions imposed by Mr. Rockefeller in connection with proposed contributions.

(b) The abandonment by several colleges and universities of sectarian affiliations and charter clauses relating to religion in order to secure endowments from the Carnegie Corporation and pensions for professors from the Carnegie Foundation for the Advancement of Teaching. It would seem conclusive that if an institution will willingly abandon its religious affiliations through the influence of these foundations, it will even more easily conform to their will any other part of its organization or teaching."

Control of Colleges.

26. "Apart from these foundations there is developing a degree of control over the teachings of professors in our colleges and universities which constitutes a most serious menace. In June of this year two professors, known throughout their professions as men of great talent and high character, were dropped from the positions they had occupied and no valid reason for such action was made public. Both were witnesses before the Commission, and made statements based upon their own expert knowledge and experience which were given wide publicity. One was a professor of law in a state university, who had acted as counsel for the strikers in Colorado; the other a professor of economics, who had not only been active in fights in behalf of child labor legislation and other progressive measures but had recently published a work comparing the income paid for property ownership with the income paid for all classes of service.

In the case of the state university we know that the coal operators in conjunction with other business interests had gained the ascendancy and exercised a great degree of control over the former Governor of the State, that the coal operators were bitterly opposed to the professor in question, and that the dismissal of the professor had been publicly urged by the operators upon numerous occasions, and we have the uncontroverted statement of the professor that he had been warned that if he testified before the Commission he would not be reappointed. In the case of the professor in the other university (which, though privately endowed, receives large appropriations from the State) we know that its trustees are interested in corporations which have bitterly opposed progressive legislation, and are men whose incomes are derived from property ownership and not from service.

In the face of such an enormous problem one can only frankly confess inability to suggest measures which will protect the Nation from the grave dangers described. It is believed, however, that if Congress will enact the measures already recommended, providing for a heavy tax on large inheritances with a rigid limitation on the total amount of the bequest, for the reclamation by the Federal Government of all parts of the public domain (including mineral rights) which have been secured by fraud, and for

a tax on nonproductive land and natural resources, a great step in the right direction will have been taken.

As regards the "foundations" created for unlimited general purposes and endowed with enormous resources, their ultimate possibilities are so grave a menace, not only as regards their own activities and influence but also the benumbing effect which they have on private citizens and public bodies, that if they could be clearly differentiated from other forms of voluntary altruistic effort, it would be desirable to recommend their abolition. It is not possible, however, at this time to devise any clear-cut definition upon which they can be differentiated."

Recommendations.

"As the basis for effective action, it is suggested that the Commission recommend:

1. The enactment by Congress of a statute providing that all incorporated non-profit-making bodies whose present charters empower them to perform more than a single specific function and whose funds exceed one million dollars, shall be required to secure a Federal charter.

The Federal charter should contain the following provisions:

- (a) Definite limitation of the funds to be held by any organization, at least not to exceed the largest amount held by any at the time of the passage of the act.

- (b) Definite and exact specifications of the powers and functions which the organization is empowered to exercise, with provision for heavy penalties if its corporate powers are exceeded.

- (c) Specific provision against the accumulation of funds by the compounding of unexpended income, and against the expenditure in any one year of more than 10 per cent of the principal.

- (d) Rigid inspection of the finances as regards both investment and expenditure of funds.

- (e) Complete publicity through open reports to the proper government officials.

- (f) Provision that no line of work which is not specifically and directly mentioned in the articles of incorporation, shall be entered upon without the unanimous consent and approval of the board of trustees, nor unless Congress is directly informed of such intention through communication to the Clerk of the House and the Clerk of the Senate, which shall be duly published in the Congressional Record, nor until six months after such intention has been declared.

2. Provision by Congress for the thorough investigation, by a special Committee or Commission, of all endowed institutions, both secular and religious, whose property holdings or income exceeds a moderate amount. The Committee or Commission should be given full power to compel the production of books and papers and the attendance and testimony of witnesses. It should be authorized and directed to investigate not only the finances of such institu-

tions, but all their activities and affiliations.

3. As the only effective means of counteracting the influence of the foundations, as long as they are permitted to exist, consists in the activities of Governmental agencies along similar lines, the appropriations of the Federal Government for education and social service should be correspondingly increased."

Discussing the difficulties that confront wage earners in collecting labor claims and securing redress for minor grievances, the report recommends the establishment either by states or municipalities of industrial courts similar to those which have proved to be successful in European countries.

It also recommends that commissioners of labor or the industrial commissions of the several states should be directed to prosecute such claims vigorously.

Unions and the Law.

Discussing the legal status of trade unions and the law relating to industrial disputes, the report says:

2. "The general effect of the decisions of American courts, has been to restrict the activities of labor organizations and deprive them of their most effective weapons, namely, the boycott and the power of picketing, while on the other hand the weapons of employers, namely, the power of arbitrary discharge, of blacklisting, and of bringing in strikebreakers, have been maintained and legislative attempts to restrict the employers' powers have generally been declared unconstitutional by the courts. Furthermore, an additional weapon has been placed in the hands of the employers by many courts in the form of sweeping injunctions, which render punishable acts which would otherwise be legal, and also result in effect in depriving the workers of the right to jury trial.

3. Important steps have been taken to deal with this situation by the enactment of the Clayton Act, applying to the Federal jurisdiction, and by the passage of laws in Massachusetts and New York which define the rights of parties engaged in industrial disputes. The actual effect of the Clayton Act can not be ascertained until it has been tested in the courts, but eminent legal authorities have expressed grave doubts that it will accomplish the desired results. At any rate, it does not seem to remove the root of the existing injustice, and, furthermore, in all the states except New York and Massachusetts the grave and uncertain situation already described exists. This situation must be corrected."

Urges English Act.

4. "There are, apparently, only two lines of action possible: First, to restrict the rights and powers of the employers to correspond in substance to the powers and rights now allowed to trade unions, and, second, to remove all restrictions which now prevent the freedom of action of both parties to industrial disputes, retaining only the ordinary civil and criminal restraints for the

preservation of life, property, and the public peace. The first method has been tried repeatedly and has failed absolutely, not only because of the intervention of the courts but because the very nature of the acts complained of on the part of employers (blacklisting and arbitrary discharge) makes it impossible to prevent them effectively by any form of legislation or administration. The only method, therefore, seems to be the removal of all restrictions upon both parties, thus legalizing the strike, the lockout, the boycott, the blacklist, the bringing in of strikebreakers, and peaceful picketing. This has been most successfully accomplished by the British Trades Disputes Act, which is the result of fifty years of legal evolution, and in its present form seems to work as successfully as could possibly be expected.

"It is suggested, therefore, that the Commission recommend:

1. The enactment by Congress and the states of legislation embodying the principles contained in the British Trades Disputes Act."

Violence.

Of violence in labor disputes the report says:

2. "Violence is seldom, if ever, spontaneous, but arises from a conviction that fundamental rights are denied and that peaceful methods of adjustment cannot be used. The sole exception seems to lie in the situation where, intoxicated with power, the stronger party to the dispute relies upon force to suppress the weaker.

3. The arbitrary suppression of violence by force produces only resentment which will rekindle into greater violence when opportunity offers. Violence can be prevented only by removing the causes of violence; industrial peace can rest only upon industrial justice.

4. The origin of violence in connection with industrial disputes can usually be traced to the conditions prevailing in the particular industry in times of peace, or to arbitrary action on the part of governmental officials which infringes on what are conceived to be fundamental rights. Violence and disorder during actual outbreaks usually result from oppressive conditions that have obtained in a particular shop or factory or in a particular industry. Throughout history where a people or a group have been arbitrarily denied rights which they conceived to be theirs, reactions has been inevitable. Violence is a natural form of protest against injustice.

5. Violence in industrial disputes is not immediately the product of industrial conditions, but of the attitude of the parties to the dispute after grievances or demands have been presented. The principal sources of an attitude leading to violence are:

(a) Arrogance on the part of the stronger party. This may result immediately in violence through the use of force for the suppression of the weaker party. The force

used may be physical or industrial. Physical force may be and is used by both employers and employes, through intimidation, assaults or attacks on property. Such physical aggression is seldom used by employes, as they are strategically the weaker party and the results are negative; only under exceptional circumstances can an employer be coerced by the use of force or intimidation. The exceptions seem to lie in the use of secret means, such as dynamite, with the object of weakening the employer's resistance.

The use of force by workers is normally directed not against the person or property of the employer, but against strikebreakers and guards. Many instances of the use of physical force by the agents of employers have, however, come before the Commission, indicating a relatively wide use, particularly in isolated communities. Such acts of violence usually take the form of assaults upon the leaders of the workers or upon organizers.

The instruments of industrial force belong chiefly to the employer because of his control of the job of the worker. Their use is more common and more effective than any other form of violence at the command of the employer. The most powerful weapon is the power of discharge, which may be used indiscriminately upon mere suspicion, which under certain conditions may be almost as potent, either in use or threat, as the power of life and death. It is the avowed policy of many employers to discharge any man who gives any sign of dissatisfaction on the theory that he may become a trouble maker or agitator.

The only corresponding weapon in the hands of the workers is sabotage, in the form either of malicious destruction of property or of interference with production. The field of its use is much more restricted in practice than in theory and its results at best are negative and produce in the employer only a blind resentment and indiscriminating hate. Sabotage as a policy shows no signs of developing in American industry.

(b) Equally productive of an attitude leading to violence in the denial of the use of peaceful methods of adjusting grievances, or the creation of a situation in which their use becomes impossible.

On the part of the employer the arbitrary acts which may be classed under this general head are:

Denial of the right to organize.

Refusal to consider the complaints of workers.

Refusal to meet the authorized representatives of workers.

Under modern industrial conditions any one of these acts makes peaceful negotiation and settlement impossible. Without organization of the workers their collective claims cannot be considered; without the right to appoint such representatives as they choose, workers are at the mercy of the em-

ployer's power of discharge and are usually unequal to the task of presenting and arguing their claims; while the refusal to consider grievances leaves only the alternative of the strike.

On the part of the workers, the possibility of peaceful settlement may be destroyed by refusal to discuss claims, by internal dissensions which render collective and definite action looking to a settlement impossible, and by the issuance of ultimatums which allow no time for consideration and negotiation. In any one of these situations the employer has only the choice between tame submission or absolute resistance to the demands of the workers."

Violence and Strikebreakers.

(c) "The immediate cause of violence in connection with industrial disputes is almost without exception the attempt to introduce strikebreakers to take the place of the workers who have struck or who are locked out. The entire problem of policing industrial disputes grows out of the problem of the strikebreaker and the attitude of the state toward him.

All experience shows that if no attempt is made to operate the plant, violence and disturbances requiring the police are practically unknown, whereas the attempt of strikebreakers to reach the plant, particularly where strikers are enjoined or prevented from using reasonable means to inform them of the existence of the strike and to use persuasive methods to keep them from entering the plant, is invariably accompanied by disorder and sometimes by active violence.

The plea of the workers for the assumption of a new attitude in relation to strikebreakers is based not only upon the negative character of the rights of the employer and the strikebreaker, but upon a positive though somewhat undefinable demand for recognition that strikers have a right to the jobs which they have left until their grievances are in some way adjusted. The argument is not only that when workers are willing to strike and sacrifice their livelihood, the conditions again which they protest must be assumed to be socially injurious, but, even more, that the worker who has struck in support of his demand for better conditions has not abandoned his job, but, in fact, has a keener interest in it than when quietly submitting to distasteful conditions.

At the very basis of the workers' contentions, however, lies the realization that working conditions can be improved only by strikes and that no strike can be won if the employer can operate his plant without difficulty. This is becoming increasingly true with every step in the nation's industrial development. During more primitive periods, if workers struck their places could not be filled except through the existence of a surplus of qualified labor in the community or by enticing workers from other employers. Now, the development of transportation, the establishment of specialized

agencies for supplying strikebreakers, and the growth of large corporations which can shift employes from one plant to another, have given each employer a command of the labor market of the entire country. There are agencies in every large city which will contract to supply any kind of labor on short notice, while almost any of the large industrial corporations can either supply the normal demand with one-half or three-quarters of their plants, or recruit from the surplus labor around their various plants a skeleton organization which can resume operations in a short time.

(d) The greatest disorders and most acute outbreaks of violence in connection with industrial disputes arise from the violation of what are considered to be fundamental rights, and from the perversion or subversion of governmental institutions."

State Constabulary.

"The Commission devoted a great deal of attention to the question of a state constabulary as a method of policing industry. Extensive investigations of the organization, personnel, and activities of the Pennsylvania State Constabulary were made and a number of witnesses were heard at length. The findings with regard to this particular police organization may be briefly stated: It is an extremely efficient force for crushing strikes, but it is not successful in preventing violence in connection with strikes, in maintaining the legal and civil rights of the parties to the dispute, nor in protecting the public. On the contrary, violence seems to increase rather than diminish when the constabulary is brought into an industrial dispute; the legal and civil rights of the workers have on numerous occasions been violated by the constabulary; and citizens not in any way connected with the dispute and innocent of any interference with the constabulary have been brutally treated and in one case shot down by members of the constabulary, who have escaped punishment for their acts. Organized upon a strictly military basis, it appears to assume in taking the field in connection with a strike, that the strikers are its enemies and the enemies of the state, and that a campaign should be waged against them as such.

There are certain features of the state police system, however, which seem to be preferable to the present haphazard methods of policing strikes. It is desirable, first, that all kinds of police should receive their entire compensation from the state; second, an organized force, whose records are known, is preferable both to the private police of corporations and to the deputies ordinarily sworn in by sheriffs; third, it is desirable that the force should be strictly disciplined and subject to definite orders; fourth, it is desirable that those in command of any police force should have a reasonably secure tenure of office and should have had previous experience under similar circumstances, as an inexperienced person is likely to become panic stricken by the

mere presence of crowds, regardless of their actions.

If these desirable features could be combined with other features which would insure their impartiality during industrial disputes, and raise their ideals from the present militaristic basis to the police basis of preserving the peace and protecting the rights of both parties and the public, the establishment of state police systems for use in connection with industrial disputes might be recommended. But under present conditions, it seems desirable rather to leave the state policing of industrial disputes to the sheriffs and the militia if the restrictions hereinafter suggested are rigidly enforced so as to protect both the organization and the personnel from partisanship."

Free Speech.

7. "One of the greatest sources of social unrest and bitterness has been the attitude of the police toward public speaking. On numerous occasions in every part of the country, the police of cities and towns have either arbitrarily or under the cloak of a traffic ordinance, interfered with or prohibited public speaking, both in the open and in halls, by persons connected with organizations of which the police or those from whom they received their orders did not approve. In many instances such interference has been carried out with a degree of brutality which would be incredible if it were not vouched for by reliable witnesses. Bloody riots frequently have accompanied such interference and large numbers of persons have been arrested for acts of which they were innocent or which were committed under the extreme provocation of brutal treatment of police or private citizens.

In some cases this suppression of free speech seems to have been the result of sheer brutality and wanton mischief, but in the majority of cases it undoubtedly is the result of a belief by the police or their superiors that they were "supporting and defending the government" by such an invasion of personal rights. There could be no greater error. Such action strikes at the very foundations of government. It is axiomatic that a government which can be maintained only by the suppression of criticism should not be maintained. Furthermore, it is the lesson of history that attempts to suppress ideas results only in their more rapid propagation.

Not only should every barrier to the freedom of speech be removed, as long as it is kept within the bounds of decency and as long as the penalties for libel can be invoked, but every reasonable opportunity should be afforded for the expression of ideas and the public criticism of social institutions. The experience of Police Commissioner Woods of New York City, as contained in his testimony before this Commission, is convincing evidence of the good results which follow such a policy. Mr. Woods testified that when he became Commissioner of Police, the found in force a

policy of rigid suppression of radical street meetings, with the result that riots were frequent and bitter hatred of the police was widespread. He adopted a policy of not only permitting public meetings at all places where traffic and the public convenience would not be interfered with, but instructing the police to protect speakers from molestation; as a result, the rioting entirely ceased, the street meetings became more orderly and the speakers were more restrained in their utterances."

To remove the causes which lead to violence and to promote the impartial and effective action of police during disputes, the following recommendations are made:

1. "The enactment by Congress of a statute prohibiting, under severe penalties, the transportation of men from state to state either under arms or for the purpose of arming them as guards or as agents either of employers or of employees.

2. The enactment by Congress of a statute prohibiting the shipment in interstate commerce of cannon, gatling guns, and other guns of similar character, which are not capable of personal use, when consigned to anyone except military agencies of the state or federal governments.

3. The regulation or prohibition of private detective agencies and private employment agencies as hereinbefore suggested.

4. The strict enforcement in all public and private employment offices of the rules requiring full notice of the existence of a strike.

5. The complete assumption by the States and municipalities of the responsibility for policing, and the prohibition of the maintenance of any private police (except a limited number of watchmen without police power except on premises).

6. The definition by statute, by the States, of the conditions under which sheriffs may deputize, such regulations to include provisions that a deputy must be a bona fide resident of the State, that a sworn statement of the complete activities of each deputy covering a period of ten years immediately preceding his deputization shall be filed with the Secretary of State, that no person who shall have been convicted of any misdemeanor or who shall have been imprisoned in any State shall be deputized, and that no deputy shall receive any money or any other thing of value from any person connected with an industrial dispute during his period of service or in connection therewith.

7. The enactment of statutes, by the States, providing a uniform code governing the militia and embodying the following principles:

(a) A proclamation of martial law or a state of war, insurrection or rebellion, by the Governor of a State, as the result of an industrial dispute, shall have no effect upon the continuance of the constitutional guarantees of the State and Federal constitutions, nor upon the law and statutes, nor

upon the jurisdiction of the courts, nor upon other civil authorities.

(b) The writ of habeas corpus or other process of the courts can not be suspended, interfered with nor disregarded by the military. It is part of the duty of the military to assist in enforcing the process and decrees of the civil courts.

(c) The ordinary courts shall have exclusive jurisdiction for the punishment of crime, and in all cases where the same act constitutes an indictable offense under both military and criminal law, court-martials shall have no jurisdiction nor authority to try officers or soldiers accused thereof, but the offender shall be turned over to the civil magistrate for trial.

(d) The military may not hold, detain, nor imprison persons arrested by them any longer than is necessary to hand them over to the civil authorities. No person arrested by the militia shall be detained after noon of the following day, without being brought before a committing magistrate.

(e) The military may not forcibly enter nor search a private house in order to seize arms or other property concealed therein without a search warrant.

(f) The military shall have no authority to establish a censorship over the press nor to interfere with the publication of newspapers, pamphlets, hand bills, or the exercise of the right of free speech, except under process of the courts.

(g) The military shall not limit, restrict, nor interfere with the freedom of movement of peaceable citizens or the rights of public meetings, assemblage, or parades in streets and public highways or elsewhere, except under due process of law.

(h) Every military officer under whose orders a civilian is asserted shall within twenty-four hours thereafter report in writing to the commanding officer the name of the prisoner, the offense with which he is charged, and what disposition has been made of him. Failing, he shall be liable to such punishment as a court-martial may direct.

(i) In times of industrial disputes no private guards, detectives, nor employes of either of the contending parties shall be enlisted or employed as members of the militia, and all persons found by the commanding officer to be in the employment of either party to a dispute or actuated by animosity or personal ill-will toward either of the contending parties, shall be forthwith released from active service.

(j) The Governor may, in times of disturbance, by proclamation forbid the sale or transportation of firearms, ammunition, and intoxicating liquors, and may require all firearms and other weapons to be deposited with the military at certain places, receipts being given therefor. Proper search warrants may be issued to discover concealed weapons.

8. That the States and municipalities should provide by law for the fullest use

of schools and other public buildings for public meetings and lectures and for other similar purposes."

Migratory Workers.

One important part of the report deals with the problem presented by large numbers of migratory laborers, many of whom find difficulty in obtaining employment during several months in the year.

The following recommendations to improve their condition are made:

1. "The Interstate Commerce Commission should be directed by Congress to investigate and report, the most feasible plan of providing for the transportation of workers at the lowest reasonable rates and, at the same time, measures necessary to eliminate the stealing of rides on railways.

If special transportation rates for workers are provided, tickets may be issued only to those who secure employment through public employment exchanges.

2. The establishment by States, municipalities and, through the Department of Labor, the Federal Government, of sanitary workingmen's hotels in which the prices for accommodation shall be adjusted to the cost of operation. If such workingmen's hotels are established, the Post Office Department should establish branch Postal Savings Banks in connection therewith.

3. The establishment by the municipal, State and Federal Governments of colonies or farms for "down-and-outs" in order to rehabilitate them by means of proper food, regular habits of living, and regular work that will train them for lives of usefulness. Such colonies should provide for hospital treatment of cases which require it."

Other subjects treated at length by the report are: Unemployment; organization, methods and policies of trade unions; methods and policies of employers' associations; joint agreements; agencies of mediation, investigation and arbitration; sickness insurance; scientific management; prison labor; immigration; labor conditions in colonial possessions; and Chinese exclusion.

Labor conditions in Porto Rico are severely criticized by the report. Wages are declared to be too low; housing and sanitary conditions bad; adequate protective laws and administrative agencies lacking; and the police and municipal authorities are charged with having denied workmen their rights. A full Congressional investigation is urged of labor conditions in Porto Rico and other possessions.

Methods of Trade Unions.

Discussing methods and policies of trade unions the report says:

"The investigations of the Commission, conducted under the direction of Dr. George E. Barnett, are the basis of the following conclusions:

1. The number of trade unionists relative to the working population is steadily increasing, although in certain industries, on account of the opposition of the great corporations and hostile employers' associations,

trade unionism is practically nonexistent. At present it may be roughly estimated that in manufacturing, mining, transportation and the building industries, if the proprietary, supervisory, official and clerical classes are excluded, twenty-five per cent of the workers twenty-one years of age and over are trade unionists.

2. The effects of trade unionism on wages are undoubted. Without some form of combination the wage workers can not bargain on equal terms with their employers. During the past fifteen years, a period of rapidly rising prices, wages in well organized trades have kept pace with the rising cost of living, in contrast to the relative decline of the purchasing power of the wages received by labor generally.

3. In the well organized trades, the hours of labor have been steadily reduced until at present eight hours is the normal working day for at least one-half of American trade unionists. It is significant of the influence of trade unionism on the length of the working day that it is exactly in those trades in which the trade unionists are a relatively small part of the total working force that they work long hours relatively to other trade unionists.

4. As the unit of industry grows larger, and the natural relation which exists between the small employer and his workmen disappears, the opportunity for unjustifiable discharges and petty tyrannies enlarges. The result is distrust and enmity among the employes. The effective remedy is the organization of the workers and the establishment of a system of trade boards in which the workers are equally represented with power to deal with such questions.

5. By means of mutual insurance in case of death, sickness, accident, old age and unemployment, many trade unions have greatly improved the conditions of their members. The extension of such systems appears to be highly desirable.

6. The trade union is a democratic institution, and faces the same problems in securing efficient government that other democratic institutions face. The theory of government which the American trade unions have adopted is the centralization of power in the national trade union as against the local unions. The successful carrying out of this plan of organization will eliminate the chief defects in trade union government. The control by the national union over strikes and the system of mutual insurance is already thoroughly established in the more important unions; it should be established in all other unions.

7. Unwarranted sympathetic strikes have undoubtedly been the cause of great annoyance and considerable economic loss to employers. The annoyance in such cases is particularly great, because no direct action by the employer can be taken; at best he can only use his influence with his associates or competitors. With the increasing control of the national officers over the local

unions, this kind of strike seems to be decreasing both in extent and frequency. Such sympathetic action is deep rooted in the sense of brotherhood which to a greater or less degree pervades and will not be completely eliminated until substantial justice exists throughout industry.

8. A few trade unions exclude qualified persons from membership by high initiation fees or other devices. This policy is condemned by the more important unions and is prohibited by their rules. The evidence presented to the Commission shows clearly that the policy of exclusion is anti-social and monopolistic, and should be given up by those unions which practice it.

9. In many trades, the efficiency of the union depends upon the maintenance of the rule that all those working at the trade shall become members of the union. Where the union admits all qualified workers to membership under reasonable conditions, such a rule cannot become the basis of monopoly and neither the rights of the individual nor the public interest are infringed by its enforcement.

10. In some trades there are a considerable number of union rules which restrict the productivity of the worker. Some of these rules can be justified on the ground that they are necessary to the protection of the health of the worker. There are some, however, which cannot be defended; these rules are anti-social and should be given up. Experience has shown that where industry is regulated by well organized systems of joint agreements, such rules either disappear or greatly decrease in number and importance. These limitations of output should not, however, be considered as standing alone. The limitations of output by associations of employers and by individual corporations are equally anti-social and have far greater consequences.

11. Jurisdictional disputes are the occasion of frequent and costly strikes. The disputes of this character which have caused most injury are in the building trades. Up to the present, the effort to lessen these disputes by action of the national unions involved have largely failed. It is suggested that the Commission recommend to the American Federation of Labor and to the national unions that renewed and more effective efforts be made to prevent such disputes.

12. The essential condition for trade union graft is the placing of the authority to call strikes or to levy boycotts in the hands of one person without adequate provision for supervision. This condition does not exist in many unions. There is abundant evidence to show that in very many cases it originates with employers who desire to secure an advantage over their competitors. The reason that graft is more prevalent in the building trades is that power is conferred on the business agent to call strikes without reference either to the rank and file or to the national officers. It has been

testified by employers who have given much attention to this problem that any well organized association of employers can eliminate graft whenever its members desire to do so. As far as the unions are concerned the solution seems to lie in the increased participation of the rank and file in the activities of the organization and increased provisions for fixing responsibility upon their business agents."

Joint agreements between employers and labor organizations representing their employes are urged as having proven the most satisfactory method of fixing conditions of employment.

A detailed plan for a permanent national mediation commission to be appointed by the President in disputes involving interstate commerce is outlined and urged upon Congress. Members, the number of which is not named, would be appointed for six years. Where official mediation of a strike fails, a board of mediation would be appointed consisting of three persons, one to be selected by the Commission and one by each of the parties. No power to compel arbitration should be given to such a Commission, says the report. The proposed Commission would have jurisdiction in all strikes where an establishment, except public service establishments, is engaged in interstate commerce or sends its products in interstate commerce. The plan provides for permanent advisory councils of employers and unionists, who would work with the Commission.

Discussing immigration, the report urges restriction based upon the general provisions of the so-called Burnett-Dillingham bill. It recommends:

1. "The enactment of legislation providing for the restriction of immigration based upon the general provisions contained in the so-called Burnett-Dillingham bill, which has received the approval of two successive Congresses. With a full realization of the many theoretical objections which have been urged against the literacy test, the consensus of evidence is so strong that its practical workings would be to restrict immigration to those who are likely to make the most desirable citizens, to regulate immigration in some degree in proportion to the actual needs of American industry, and finally to promote education in Europe, that it seems necessary at least to urge that this plan be given a practical test.

2. The enactment of legislation providing that within six months from the time of entry all immigrants shall be required, under penalty of deportation, either to declare their intention to become citizens by taking out their first papers or to definitely register themselves with the proper authority as alien tourists, and further providing that all immigrants who have failed to take out their first papers at the end of two years shall be deported, as shall all who fail to take out their second papers when

they become eligible, deportation in each case to act as a bar to future entry.

3. The provision by the state and municipalities, with the assistance of the federal government, if necessary, for the education of all adult persons who are unable to speak, read or write the English language. In order to accomplish this it may be necessary to provide that employers shall grant certain definite periods of leisure for such instruction."

PRESS ABSTRACT OF REPORT OF THE COLORADO STRIKE.

By George P. West.

Ordered Printed by Resolution of the Commission.

The responsibility of the strike of coal miners in Colorado in 1913 and 1914 for the disorder and suffering that followed is placed squarely on the shoulders of operators in a report by George P. West, made public today by the Commission on Industrial Relations.

The Colorado Fuel & Iron Company, controlled by John D. Rockefeller, is declared to have been the leader in formulating and carrying out strike policies. Mr. Rockefeller and his son, John D. Rockefeller, Jr., are charged, first, with the selection of incompetent and reactionary agents to serve as executive officials in this company, and, second, with giving their heartiest indorsement and support to these officials after they had taken action that precipitated the worst of the troubles.

Mr. Rockefeller, Jr., is charged with having approved measures to coerce the state government of Colorado and with having flouted the will of the President of the United States.

The report says:

"During all the seven tragic and bitter months that preceded Ludlow, Mr. Rockefeller wrote letter after letter in enthusiastic praise of men whose acts during this period had precipitated a reign of terror and bloodshed. It was only when the Ludlow massacre filled the press of the nation with editorial denunciation, when mourners in black silently paraded in front of his New York office, when cartoons in the conservative press pilloried him and his father before an angry public, that at last complacency gives way to concern in his letters and telegrams to Denver."

Of Mr. Rockefeller's responsibility the report says:

"Mr. Rockefeller's responsibility has a significance beyond even the sinister results of his policy in Colorado. The perversion of and contempt for government, the disregard of public welfare, and the defiance of public opinion during the Colorado strike must be considered as only one manifestation of the autocratic and anti-social spirit of a man whose enormous wealth gives him infinite opportunity to act in similar fashion in broader fields. Mr. Rockefeller writes to Mr. Bowers: 'You are fighting a good fight, which is not only in the interests of

your own company, but of the other companies of Colorado and of the business interests of the entire country.'

"And Mr. Bowers, with whom Mr. Rockefeller obviously is in full sympathy and agreement, writes letter after letter picturing the growth of trade unionism as a national menace against which the business men of the nation must combine. 'Now for the campaign of 1916 and beyond,' is the slogan with which one of these letters closes, and Mr. Bowers is unsparing in criticism of a President who would tolerate a former official of a labor union in his cabinet.

"The nation-wide significance and importance of the Colorado conflict and the company's ruthless policy of suppression are emphasized again and again. By June, 1914, Mr. Rockefeller has formulated something like a definite plan for a nation-wide campaign. The most highly paid publicity expert in the country has been borrowed from a great eastern railway, to be taken over later as a permanent member of Mr. Rockefeller's staff. A 'union educational campaign' is to be conducted, and the country is to be flooded with articles by college professors and others bitterly denouncing trade unions. And at the very time when he prepares to circulate Prof. Stevenson's intemperate and amazing defense of industrial absolutism and tirade against trades unions, Mr. Rockefeller enlists the aid of Mr. W. L. Mackenzie King, expert on industrial relations, to devise specious substitutes for trade unions that will deceive, mollify and soothe the public opinion while bulwarking the employers' arbitrary control.

"Yet it is important to remember that Mr. Rockefeller's character and policies are important only as showing the possibilities inherent in an economic and industrial situation that permits one man or a group of men to wield such enormous economic power, and through that power not only to control the destinies and dictate the circumstances of life for millions of wage earners and for entire communities, but to subsidize and control to a large degree those agencies that mold the public opinion of a nation. Even should Mr. Rockefeller change overnight, these possibilities of evil would remain inherent in our economic and industrial situation, as a menace to freedom and democracy.

Every important statement of fact contained in the report, it is said, is established by quotations from the correspondence or testimony of responsible executive officials of the Colorado Fuel & Iron Company or of Mr. Rockefeller and members of his personal staff. The report contains copious extracts from the testimony and correspondence of Mr. Rockefeller, Jr., and Starr J. Murphy, his personal attorney in New York; J. F. Welborn, president of the Colorado Fuel & Iron Company; L. M. Bowers, chairman of the executive department of the Colorado Fuel & Iron Company; the Rev.

Eugene S. Gaddis, superintendent of the company's sociological department, during the strike and until February, 1915, and others.

The report in discussing the company's rejection of President Wilson's plan for a settlement of the strike, says:

"Mr. Rockefeller not only rebuffed the President by denying his earnest request, but, if the letters of his agents may be relied upon, he apparently deceived the President and the public by means of the company's letter of rejection. This letter was written by President Welborn in collaboration with Mr. Ivy L. Lee, a member of Mr. Rockefeller's personal staff, whom he had sent to Colorado for the purpose. Mr. Rockefeller's personal staff in New York had become impressed with the strong public sentiment supporting the President's proposal, and in drafting their letter of rejection to the President. Messrs. Welborn and Lee inserted the following:

"A plan to secure harmonious relations in some industries or sections of the country would not necessarily apply to our peculiar conditions. We are not developing an even more comprehensive plan, embodying the results of our practical experience, which will, we feel confident, result in a closer understanding between ourselves and our men. This plan contemplates not only provision for the redress of grievances, but for a continuous effort to promote the welfare and the good will of our employes."

"This letter was signed by Mr. Welborn and was dispatched on September 18, 1914. On the following day, September 19, Mr. Welborn wrote to Mr. Murphy, Mr. Rockefeller's personal attorney in New York:

"I appreciate your very thoughtful letter of the 16th inst., with suggestions for consideration IN THE EVENT OF ITS BEING NECESSARY TO PROPOSE SOME PLAN TO TAKE THE PLACE OF THAT PRESENTED TO US BY THE PRESIDENT."

The political influence of the Rockefeller Company and its associates is declared to be greater today than ever before, as a result of the failure of the strike. The report says:

"The Commission is told by Mr. W. L. Mackenzie King, expert on industrial relations for Mr. Rockefeller, Jr., that Mr. Rockefeller's will and conscience are today the most potent factor to be considered in any effort to bring about an improvement of conditions. While physical and material conditions in the coal camps may be improved to some extent as a result of the publicity given to existing abuses, these improvements, if they come, will be granted as a charity, and there is as yet no indication that the inhabitants of the coal camps are nearer the achievement of industrial and political democracy than they were when the strike began. On the other hand, the arrest, persecution and conviction of union officials and strikers, with the aid of

attorneys and detectives in the employ of the Colorado Fuel & Iron Company, and by direction of public officials placed in office largely through the company's influence, indicate plainly that the reverse is true. How the Colorado Fuel & Iron Company obtained the new lease of political power by which it procured these prosecutions is well shown by the following extract from the testimony of Mr. L. M. Bowers, chairman of the executive department of the company, given before the Commission in Washington on May 24. Mr. Bowers had testified that the company turned 150 men out of its offices on election day to work for prohibition, which was bound up with the candidacies of Mr. Carlson for governor and Mr. Farrar for attorney general. Both these candidacies were successful.

Mr. Bowers: Let me explain. I don't mean we turned them out to carry the election. It was on election day, but we were out on the campaign and had a fight on and had practically no funds to carry on the campaign, and they wanted men to do the work, to do the ward work and distribute literature and all that sort of thing; and the coal operators, not only the coal operators but everybody that was interested in the question of prohibition at the election turned out their office men, and I had been — by the way, I had nothing to do with picking out that one hundred and fifty men, and I did not know it until the next day after they had been out.

Chairman Walsh: Didn't you use the prohibition sentiment that was strong in the state to get support for what you called the law and order platform, that was, for the Colorado Fuel & Iron Company and the others to aid in the ruthless prosecution of the strikers and the union officers, and a relentless policy of suppressing those men?

Mr. Bowers: It was all interlinking and locked together.

The company's deep interest in prohibition quite slips President Welborn's mind when he writes to Mr. Rockefeller the following exultant letter, dated November 6, 1914:

"My Dear Mr. Rockefeller:

"According to the figures received today, which are practically complete, the plurality of Carlson, Republican candidate for governor, over Patterson, is approximately 33,000. The plurality of Farrar, Democratic candidate for attorney general, over his next opponent, the Republican, is almost 38,000.

"Farrar is the present incumbent in the office to which he has just been elected, and has been about the only reliable force for law and order in the state house. His re-election serves to emphasize the sentiment in favor of law and order, expressed in the election of the main part of the Republican ticket.

"Mr. Farrar has been very actively engaged for several months in connection with the work of grand juries in various coal counties, where indictments have been

brought against those who participated in the rioting.

"Very truly yours,
(Signed) "J. F. WELBORN."

"Mr. Rockefeller also forgets the prohibition cause, on account of which Mr. Bowers says 150 men were turned out of the company's office as election workers. He writes:

"Dear Mr. Welborn:

"I have just returned to the city, after an absence of several weeks in the South with my wife, and find your letter of November 26 regarding the gratifying plurality for Carlson for governor and Farrar for attorney general. It would seem that the election of this Republican governor and the re-election of this Democratic attorney general, both of whom have established clear records as to their strong stand for law and order, would indicate that the sentiment of the people of Colorado is for law and order, quite irrespective of party lines.

"Very cordially,

(Signed)

"JOHN D. ROCKEFELLER, Jr."

"In pursuance of the 'law and order' policy on which they were elected, Governor Carlson and Attorney General Farrar have proceeded vigorously with the prosecution of union officials and strikers. Their most conspicuous success came with the conviction on a charge of murder in the first degree of Mr. John R. Lawson, member of the executive board of the United Mine Workers of America and the most conspicuous Colorado official of that organization. Mr. Lawson is an old resident of Colorado. He had worked his way from breaker boy to a position where he commands the respect and friendship of large numbers of the state's best citizens. He has appeared twice before the Commission, and members of the Commission and its agents have investigated carefully his record and character. As a consequence, he is believed to be a man of exceptionally high character and a good citizen in every sense of the term. The judge before whom he was tried was appointed by Governor Carlson after serving the Colorado Fuel & Iron Company as attorney and assisting in the preparation of cases against strikers. The panel from which the jury was drawn was selected by the sheriff of Las Animas County, an official whose sympathies have been with the mine owners from the beginning. Much of the evidence on which he was convicted came from men in the employ of a detective agency retained by the coal companies. The killing of John Nimmo, a mine guard, by the strikers during one of the many skirmishes between them and the deputies was the crime for which Mr. Lawson was convicted. No effort was made to prove that he fired the fatal shot. He was held responsible for the death of Nimmo because he was leading the strike and was at the Ludlow tent colony on the day of the battle. Nimmo was one of a small army of

deputy sheriffs, employed and paid by the coal companies and deputized by subservient sheriffs who made little or no effort to investigate their records. Thus Sheriff Jefferson Farr of Huerfano County testified before this Commission that the men to whom he gave deputies' commissions might have been, so far as he knew, red-handed murderers fresh from the scene of their crimes. That many guards deputized in this illegal fashion and paid by the Colorado Fuel & Iron Company were men of the lowest and most vicious character has been clearly established. That their function was to intimidate and harass the strikers had been demonstrated in the strike of 1903-1904 and had been made apparent early in the present strike by the shooting to death of Gerald Lipplatt, a union organizer, in the streets of Trinidad immediately after the calling of the strike, by a Baldwin-Felts detective employed by the Colorado Fuel & Iron Company and its associates and deputized by the sheriff of Las Animas County. In fact, it was to these deputies, then masquerading as national guardsmen, that national guard officers attempted to attribute the murder, looting and pillage that accompanied the destruction of the Ludlow tent colony of strikers later in the strike.

"On August 17 the Supreme Court of Colorado issued an order prohibiting Judge Granby Hillyer, who presided at Mr. Lawson's trial, from presiding at other trials of strikers or strike leaders, on the ground that he had been, just prior to his appointment, an attorney for the Colorado Fuel & Iron Company and the other operators. The court also issued a writ of supersedas permitting the Lawson case to come before it on its merits.

"The prosecution and conviction of Mr. Lawson under these circumstances, and his sentence to life imprisonment at hard labor, marked the lowest depths of the prostitution of Colorado's government to the will of the Colorado Fuel & Iron Company and its associates. It is the crowning infamy of all the infamous record in Colorado of American institutions perverted and debauched by selfish private interests. It is anarchism stripped of every pretense of even the chimerical idealism that fires the unbalanced mind of the bomb thrower. It is anarchism for profits and revenge, and it menaces the security and integrity of American institutions as they seldom have been menaced before.

"Attorney General Farrar's bias in favor of the owners and his conception of fairness is well shown by his comment on the grand jury which met in Trinidad in August, 1914, and which under his direction returned indictments against 124 strikers and strike leaders. Of this jury, Mr. Farrar testified before the Commission in Denver:

"I desire to say here that regardless of the reports which have been made, I have never seen a more fair-minded body of men gathered together under conditions such as

prevailed there than were the twelve men who constituted that grand jury, and the charges which were made that they were absolutely one-sided and partisan are absolutely without foundation whatever.'

"Following is the composition of this grand jury as reported by Mr. John A. Fitch of the staff of the Survey, an investigator of established reliability and fairness:

"J. S. Caldwell, proprietor of a shoe store. Formerly with the Colorado Supply Company, the company store department of the Colorado Fuel & Iron Company.

"James Roberts, public trustee. Secretary to F. R. Wood, president of the Temple Fuel Company.

"Charles Rapp, assistant cashier of Trinidad National Bank, of which W. J. Murray, general manager of the Victor-American Fuel Company is stockholder and director. Formerly with Colorado Supply Company.

"Henry C. Cossam, rancher. Deputy sheriff since April 25, 1914. Participated in one of the so-called battles.

"J. H. Wilson, real estate and insurance agent. Deputy sheriff since September 30, 1909. In charge of the deputies who attacked the Forbes tent colony October 17, 1913.

"William C. Riggs, rancher, whose son, W. E. Riggs, has been a deputy sheriff since January 20, 1911, and was in some of the battles in the fall of 1913.

"J. W. Davis, a Trinidad barber.

"D. J. Herron, life insurance agent in Trinidad.

"E. E. Phillips, rancher, Hoehne, Colo.

"John Webber, a Trinidad merchant.

"Frank Godden, proprietor Hotel S. Elmo, Trinidad.

"David West, justice of the peace, Aguilar, Colo.'

"Mr. Farrar's bias is further indicated by these additional extracts from his testimony at Denver:

"Chairman Walsh: What steps, if any, did you take to ascertain whether or not the military authorities and other authorities of the strike down there were acting in conformity with the constitution and statutes of the state, and whether or not the civil authorities were being deprived in any way of their powers?

"General Farrar: Very little. During the time the militia was there, I was not in touch with the situation in an official capacity, except as it came to me through the governor, with the exception of one or two instances. General Chase and I did not have any conference. He was at Trinidad, and during the time the militia was in the field I was not at Trinidad although on two occasions I sent my deputy down to Trinidad, in order to be able to assist along certain lines which were then under discussion. And I therefore say that my relationship with the military authorities was largely indirectly through the governor. I did, of course, know in a general way what was

being done down there, and what lines were being followed; but it was not a definite daily report or information coming to me. I will say further in that respect that there were a number of attorneys in the national guard, and that some of these were advising General Chase as to the local situation. My advice was, of course, of a more general nature and was always to the governor, with the exception of the two occasions when General Chase and I met in conference here.

"Chairman Walsh: Do you know whether or not the testimony taken before the Military Commission, of which Major Broughton was the head, was preserved?

"General Farrar: No, I know nothing of it. I have never seen the testimony and cannot answer your questions.

"Chairman Walsh: Did your office make any effort to ascertain whether or not the civil rights of any person had been violated or abused?

"General Farrar: You mean by this Military Commission?

"Chairman Walsh: Yes, by the Military Commission.

"General Farrar: Yes.

"Chairman Walsh: Was there any such abuse or violation?

"General Farrar: Not that I was able to learn. Now I must qualify that by saying that I have not seen the testimony and my information concerning it is of a general nature. * * *

"Asked by Chairman Walsh: "Have you ever gone over the list (of national guardsmen) to ascertain whether or not the law had been violated in reference to the enrollment of the men in the mine?" he replied: "Only through consulting the officers in charge of that matter."

"Chairman Walsh: What steps, if any, have been taken by your office to investigate the occurrence at Ludlow of April 20, 1914?

"General Farrar: I have taken every opportunity or every step which opportunity afforded me. As stated before, I did not have and have not seen the testimony—the evidence taken by the Military Court Martial, relative to that question. * * *

"Chairman Walsh: I am asked to inquire of you if you know about the looting of saloons and the destruction and confiscating of liquors in the Snodgrass store at Ludlow, also the complete destruction of bakeries, rooming houses and private residences at Ludlow by the militia?

"General Farrar: I know nothing of it."

"General Farrar did give his attention to the question of whether or not the state troops acted legally under Governor Ammon's original orders, prohibiting them from acting as escorts for imported strikebreakers. He testified before this Commission that he went to Governor Ammons and advised him that such a policy was not justified by law and should be abandoned.

"The same authorities who conducted this and other successful prosecutions of strikers

have taken no steps to prosecute Lieutenant K. E. Linderfelt of the Colorado National Guard, or other members of the guard who took part in the wanton slaughter of three unarmed strikers held prisoners at Ludlow, and in the burning of the Ludlow tent colony which resulted in the death by suffocation and burning of thirteen women and children. Yet at the coroner's inquest a doctor who examined the body of Louis Tikas, one of the slain strikers, testified that a blow on the head, dealt by Lieutenant Linderfelt with the stock of his rifle, was so severe that it might have caused death even had Tikas not been shot three times through the body as he lay prostrate on the ground, by men under Linderfelt's command. It is true that Lieutenant Linderfelt and other members of the guard were tried by a court martial composed of their fellow officers, and that trifling demotions in rank were assessed as punishment. Nor have the same authorities taken steps to prosecute officials and directors of the Colorado Fuel & Iron Company, in spite of evidence gathered by the Commission, and which has become common knowledge, that these officials through their agents and subordinates created a private army of armed guards and later procured the enlistment of these gunmen in the militia, and of well-substantiated charges that these disreputable agents of the company in the guise of militiamen committed various crimes from robbery, burglary and arson to murder.

"The prosecution of Mr. Lawson and many other strikers and union officials was undertaken and conducted in compliance with the stand taken by the present governor and the present attorney general during their campaign for election in favor of 'law and order.' Their conduct since taking office must be considered a confirmation of the charge made by their political opponents during the campaign that in standing for 'law and order' they were in reality standing for the coal operators against the strikers, for industrial absolutism against industrial democracy, and that their conception of maintaining law and order was the ruthless suppression of the strike and imprisonment or execution of the men who dared to lead it, this to serve as an object lesson to others who might attempt to lead a similar revolt in the future."

Discussing the causes of the strike, the report says:

Causes of the Strike.

"The Colorado strike was a revolt by whole communities against arbitrary economic, political and social domination by the Colorado Fuel & Iron Company and the smaller coal mining companies that followed its lead. This domination has been carried to such an extreme that two entire counties of southern Colorado for years have been deprived of popular government, while large groups of their citizens have been stripped of their liberties, robbed of portions of their earnings, subjected to ruthless perse-

cution and abuse, and reduced to a state of economic and political serfdom. Not only the government of these counties, but of the state, has been brought under this domination and forced or induced to do the companies' bidding, and the same companies have even flouted the will of the people of the nation as expressed by the President of the United States.

"Economic domination was achieved by the Colorado Fuel & Iron Company and its followers through the ruthless suppression of unionism, accomplished by the use of the power of summary discharge, the black list, armed guards, and spies, and by the active aid of venal state, county and town officials, who placed the entire machinery of the law at the disposal of the companies in their persecution of organizers and union members.

"This economic domination was maintained by the companies in order that they might be free to obey or disregard state laws governing coal mining as they pleased; arbitrarily determine wages and working conditions; and retain arbitrary power to discharge without stated cause. The power to discharge was in turn used as a club to force employes and their families to submit to company control of every activity in the mining communities, from the selling of liquor and groceries to the choice of teachers, ministers of the gospel, election judges, and town and county officials. In the cases of several companies, the suppression of unionism was used also to deny checkweighmen to the men in order that the miners might be cheated of part of their earnings.

"Political domination was achieved by the companies by the use of their monopoly of employment to suppress free speech, free press and free assembly, by the appointment of company officials as election judges, by the formation of a political partnership with the liquor interests, and, in the case of the Colorado Fuel & Iron Company, also by the expenditure of large sums of money to influence votes during campaigns and by resort to other forms of fraud and corruption. Where a public official refused to do their bidding, he was whipped into line through pressure from interests that responded to the economic power of the Colorado Fuel & Iron Company and its followers.

"This political domination was maintained by the companies in order that they might ignore or defy state laws enacted to safeguard the interests of their employes, prevent legislation by state or county unfavorable to their interests and obtain such legislation as they wished, control coroners and judges and thus prevent injured employes from collecting damages; and flagrantly disregard the constitutional and statutory guarantees that otherwise would have prevented them from procuring the imprisonment, deportation or killing of union organizers and strikers.

"The policies and acts of the executive

officials of the Colorado Fuel & Iron Company, and of the other companies that acted with them, had the hearty support and indorsement of the greatest and most powerful financial interest in America, that of John D. Rockefeller, and his son, John D. Rockefeller, Jr., who controlled the company through ownership of approximately 40 per cent of its stocks and bonds. Letters from Mr. Rockefeller, Jr., heartily approving his company's refusal to meet representatives of the strikers, of the measures taken to suppress the strike, and of the coercion of the governor that resulted in throwing the state troops on the side of the owners, were shown not only to executive officers of his company, but to other operators who followed its lead and his support contributed largely to the unyielding and lawless policy that finally resulted in the horrors of the Ludlow massacre and the intervention of the federal government.

"After the system of political and economic absolutism outlined above had driven the miners to revolt, the owners not only obstinately refused to admit the possibility of any grievance, but at a time when they could have prevented a strike by merely granting a conference to the union officials, they chose instead to refuse the conference and in doing so made themselves responsible for the disasters and tragedy that followed. Letters from the president and chairman of the executive board of the Colorado Fuel & Iron Company to Mr. Rockefeller's office show that these officers fully realized the gravity of the situation before the strike, and also that they believed a strike could have been averted by the mere granting of a conference. Yet their refusal even to meet representatives of the union had from the beginning the warm approval and indorsement of Mr. John D. Rockefeller, Jr.

"The refusal of the operators to accede to any plan for settlement involving a personal meeting between themselves and the strike leaders or any slightest recession from their original attitude continued throughout the strike, and eventually took the form of a rejection, amounting to rebuff, of a plan that was urged upon them by the President of the United States and that was supported by the public opinion of the nation. This continued and persistent defiance of the public interest, as that interest was urged upon them by the highest representative of the people, continued to have the support and indorsement of Mr. Rockefeller, without which there is doubt that it could have been sustained.

Discussing the situation in Colorado today, the report says:

"The defeat of the strike by the methods that have been described left the Colorado operators free to operate their properties exactly as they saw fit. The United Mine Workers have, at least temporarily, abandoned their effort to organize the miners, and the large operators other than the Colorado Fuel & Iron Company are as deter-

mined as ever that there shall be no democratic organization of the industry which they control.

"At the mines of the Colorado Fuel & Iron Company a plan purporting to provide the miners with easy access to Company officials, and with other advantages of collective bargaining, has been announced by Mr. Rockefeller and his subordinates, and has been widely heralded by them as evidence that, the strike having been defeated, they are now willing to grant of their own free will and accord what they stubbornly refused to give under the duress of the strike. Before considering the merits of this plan it must be pointed out that the spirit actuating those who conceived and executed it was the spirit of men who give as a charity or a favor that which they had denied when demanded as a right. Even if we grant that the concession has substantial value, it must still be characterized not as a concession to democratic principles, but as an instance of that handing down of favors in which autocrats and despots always have delighted.

"But after a study of the plan as disclosed in the testimony of Mr. Rockefeller and Reverend Mr. Gaddis, and in the public announcements of President Welborn, it is found that it embodies none of the principles of effectual collective bargaining and instead is a hypocritical pretense of granting what is in reality withheld.

"The testimony and correspondence not only prove this, but they contain indisputable evidence that the plan was conceived and carried out, not for the purpose of aiding the Company's employes in Colorado, but for the purpose of ameliorating or removing the unfavorable criticism of Mr. Rockefeller which had arisen throughout the country following his rejection of President Wilson's plan of settlement, and which had found utterance even in those conservative circles and newspapers in Eastern cities where Mr. Rockefeller's self-esteem could not escape injury by such criticism.

"In considering the correspondence and testimony that will here be quoted, it must be borne in mind that Mr. Welborn is still the president of the company and the dominating executive official on the ground in Colorado. If it appears that Mr. Welborn's spirit and attitude toward the new plan, as disclosed in his correspondence while this plan was being formulated, were such as to convince the recipient of his letters that he was temperamentally and by conviction unfitted for the carrying out of any plan for real collective bargaining, then Mr. Rockefeller's retention and continued support of Mr. Welborn must be taken as a measure of his own sincerity regarding the plan.

Mr. Welborn's conception of collective bargaining and of an ideal arrangement for safeguarding the wage earners' interests is expressed in the following sentence in his letter of October 9, 1914:

I am impressed with the importance

of so composing whatever committees are found advisable as to make it appear that they all represent one interest; in other words, that there is but one interest which is in every sense of the word common, yet having it understood that the committee is as free to consider any complaints or grievances of men as though it were one actually of their own selection.

"This notion that the interests of the employer and employe are common when applied to distribution of product is a fallacy that can hardly be advanced with sincerity by a man of intelligence. Yet it apparently animates Mr. Rockefeller's attitude, and he even considers it consistent with the existence of a system of collective bargaining. It need scarcely be pointed out, first, that the plan outlined by the letters and testimony here quoted does not provide an effective organization of the Company's own employes, and, second, that if it did these employes would still be unable to maintain bargaining equality without the support of a nation-wide organization such as only the United Mine Workers can give.

"The correspondence and statements already quoted show that so far from being a plan that provides for collective bargaining, it is a plan conceived and executed by men who were determined that no element of real collective bargaining should enter into it.

"The effectiveness of such a plan lies wholly in its tendency to deceive the public and lull criticism, while permitting the company to maintain its absolute power.

"Reverend Mr. Gaddis continued to serve the company as superintendent of its Sociological Department until February, 1915, or several weeks after the date on which the new plan became operative. Testifying before this Commission at Washington, he said:

"Of the much advertised welfare agent, 'as mediator between the company and its employes,' we believe his work will only tend to intensify the despicable oppressiveness of the past few years. One super at least has already been informed, *sub rosa*, that there need be no undue concern about this new officer limiting their suzerainty. He had been in the field but a few weeks when he effected the discharge of a man with a family to support, on the word of a woman of questionable character. The evicted employe was given no opportunity to present his side of the case.

"It is almost farce to presume that a pet appointee would fearlessly and impartially bring things to the surface, that would disturb the imperturbable equanimity of the one who must O. K. his monthly salary account.

"The assembling of camp delegates in Bower's old office on January 19th, in which complaints were solicited; and a generally blumpty good time with free auto rides, banquet and theater party as a part of the program; in addition all expenses being

paid to and from their respective camps, was a decided hit.

"A good square kick could hardly be expected from such sources.

"Again the remembrance of so many of their former comrades being 'canned,' for squealing would not be forgotten amidst the grandeur and informality of their temporary environment.

"A few weeks after this meeting a representative from headquarters inquired of a super if 'the men thought we were trying to put one over on them?' There is room for suspicion that 'one is being put over on the public and that the various investigating committees are having dust thrown into their eyes; for Presto, the lion has been changed into the lamb.

"If the investigating committees can be kept out of Colorado for the next six months or a year the old shackles of oppression will have received so many new rivets, that it will take the hellish fires of another strike to loosen them."

The report charges that no plan of any sort for hearing grievances and giving the men even a pretense of representation was favorably considered by the company until, in rejecting President Wilson's plan of settlement it became necessary to propose some counter plan in order to appease public criticism.

The report charges that Mr. Rockefeller made no effort to disclaim full responsibility as the controlling influence behind the operators until after the so-called Ludlow massacre. Discussing this point the report says:

"The evidence shows that the Colorado Fuel & Iron Company played a master hand in determining the policy of the operators, and in maintaining that policy after it was announced. This company mined from thirty-five to forty per cent of the coal produced in Colorado and employed nearly three times as many miners as the second largest company. For more than ten years its largest stockholder and dominating director had been John D. Rockefeller, and since 1907 a personal representative of Mr. Rockefeller had been in active charge of its management as chairman of the board of directors, vice-president and treasurer. This official was Mr. L. M. Bowers, a man sixty-nine years of age, who had been employed by Mr. Rockefeller to manage various industries for twenty years, and whose deep seated opposition and animosity toward labor unions and the practice of collective bargaining must have been well known to his employer when he was sent to Colorado to represent the Rockefeller interest.

"From first to last Mr. Bowers, as shown by his letters to Mr. Rockefeller's office, saw nothing in the struggle of the miners for the right to organize for collective bargaining except a plot by 'socialists,' 'anarchists' and 'political demagogues' to wrest the control of the mines from their owners. His letters to Mr. Rockefeller, Jr., early in the strike show him to have been bitter and prejudiced in the extreme, with

an adherence to the individualistic economic doctrines of a century ago that was almost grotesque in its intensity.

"Back of Mr. Bowers and President Welborn in determining and maintaining the operators' policies stood John D. Rockefeller, Jr., whose enthusiastic approval and indorsement of these policies gave incalculable moral and material support to both his own subordinates and to the executive officials of other companies. Mr. Rockefeller's indorsement and approval was accorded promptly at the beginning of the strike in the form of personal letters to Mr. Bowers, which were shown not only to the executive officers of the company but to the heads of other companies as well. It is greatly to be doubted if the Colorado operators could have maintained their unyielding and defiant attitude of opposition to the enlightened public opinion of the entire nation had they not been bulwarked by the material and moral power wielded by the possessor of the hugest private fortune in the world.

"Mr. Rockefeller's power to direct the policies of his own company is admitted and needs no discussion. But it is alleged that the Colorado Fuel & Iron Company was but one of many, and by itself unable to control the situation.

"Examination of the evidence shows that Mr. Rockefeller's agents admitted the company's leadership in the counsels of the operators during the first seven months of the strike.

"It was not until the horror of the Ludlow massacre had shocked and outraged the nation and brought upon its perpetrators the wrath and loathing of every decent citizen that Mr. Rockefeller, for the first time, makes the point that his company was but one of many, and that Mr. Bowers in Denver, his supreme self-complacency staggered for the minute, writes his employer 'we have been given altogether too prominent a place in this trouble.'

"Mr. Bowers used this phrase five days after the Ludlow massacre. The same sudden desire to minimize his part in the affair, apparently animated Mr. Rockefeller in New York at about the same time. Telegraphing to Mr. Bowers on April 26, while the tide of the nation's anger still rose about him, Mr. Rockefeller asked:

"How many coal companies are involved in the strike. What proportion of their normal total output does your company represent? Answer 10 West Fifty-fourth Street.'

"Contrast Mr. Bowers' modesty after Ludlow with his early boastfulness. On November 18 he wrote Mr. Rockefeller:

"Personally, the strain has been very great on Mr. Welborn, who has been the recognized leader among the operators.'

"While Mr. Rockefeller may have fully believed that conditions in the Colorado mines had been greatly improved since Mr. Bowers was sent there, and were as good or better than conditions prevailing in other fields, it

is submitted that even a cursory reading of Mr. Bowers' letters should have revealed to his employer that here was a man temperamentally and intellectually incapable of dealing wisely and fairly with a strike involving the vital rights and interests of thousands of employes and their families, and seriously menacing the peace and well being of a state. Mr. Bowers' letters alone should have been sufficient to convince Mr. Rockefeller that the writer was irritable, arbitrary and obstinate to an exceptional degree; that he was a survival of the dark age of theory and practice regarding industrial relations; that he was ignorant of the characters and records of the men whom he opposed; and that finally his attitude toward the government of the state and nation was contemptuous, hostile and defiant.

"Nor could Mr. Rockefeller be acquitted even had Mr. Bowers concealed these qualities in his correspondence with 26 Broadway. From the day, seven days before the strike began, when he avoided an interview sought by a mediator of the federal government, Mr. Rockefeller refused to enter upon any independent investigation in order to determine for himself the true situation in Colorado, before he threw all the enormous power of his personal support behind the men who had set themselves to the task of crushing the revolt of 8,000 miners.

"Yet the men whose unsupported word he accepted were almost strangers to him. They were men who could not have admitted the grievances complained of without admitting themselves guilty of crimes against society. But their denial was all that Mr. Rockefeller required before projecting himself into the situation as a decisive factor.

"That Mr. Rockefeller's support of his Colorado officials became a factor of tremendous importance, if not a decisive factor, in preventing a peaceful settlement is made clear by a study of the testimony and correspondence.

"On May 13, 1913, Mr. Bowers wrote to Mr. Rockefeller's secretary: "It is well known that the Rockefeller interests are managing the affairs of the Colorado Fuel & Iron Company.' Business men, ministers, college professors, editors, and the general public knew that Mr. Bowers and Mr. Welborn represented the greatest financial interest in the world. They represented this interest in a comparatively new state, where dependence on 'eastern capital' and the habit of sedulously cultivating the friendship of eastern investors still held. They represented the world's greatest investor in a community of small business men newly-arrived in the charmed circle of wealth and power and actually sensitive to the glamor that surrounds the world's financially powerful.

"In the business community of Denver, Mr. Rockefeller's agents had a prestige comparable to that of those strong men of Rome sent out from the world's capital to carry its grandeur into distant provinces. Three newspaper publishers, preachers of the gos-

pel, obscure officers of the militia, looked to Mr. Rockefeller, a stranger in distant New York, for succor in their financial distress. When the United States government, warned of the discontent and the impending revolt in the coal fields, moved to prevent a disastrous strike, it was to Mr. Rockefeller's office in New York that this government sent its mediator. It was to Mr. Rockefeller that a cabinet officer appealed early in the strike, and Mr. Rockefeller's answer then, in contrast with his attitude after Ludlow, carried no denial or repudiation of his supreme authority and power."

There are submitted many extracts from the correspondence between Messrs. Bowers and Rockefeller in Denver and Mr. Rockefeller, or members of his personal staff, at 26 Broadway, all bearing on the question of Mr. Rockefeller's responsibility.

The report continues:

"But Mr. Rockefeller's part in the Colorado conflict was not confined to these letters of praise and indorsement which so heartened and sustained the Colorado operators. Prior to the massacre at Ludlow on April 20, the letters proved quite sufficient for Mr. Rockefeller's purpose. But the storm of popular wrath that rose after Ludlow demanded more active participation. It was then that Mr. Rockefeller initiated the nation-wide publicity campaign by which he hoped to convince the country that the strikers, not his company's mine-guard-militiamen, were responsible for the deaths of thirteen women and children who perished at Ludlow, and that the strike itself, instead of a struggle for freedom, was a revolt by blood-thirsty and anarchistic foreigners, led by men who obtained huge incomes from organized agitation and lawlessness.

"Still hiding behind his executive officials in Denver, Mr. Rockefeller employed a publicity expert and advanced him money from his personal funds to begin the campaign. He chose for the purpose Mr. Ivy M. Lee, publicity agent for the Pennsylvania Railroad. The President of that railroad consented that Mr. Lee should devote a part of his time to Mr. Rockefeller's service, and the pamphlets and bulletins were to be dispatched in bulk from Mr. Lee's Philadelphia office to Denver, for distribution from the office of the Colorado Fuel & Iron Company. They were to go forth under the name of the operators' committee, as correct information gathered and written on the scene by men familiar at first hand with the facts.

"Early in the summer of 1914 there began that remarkable publicity campaign by which Mr. Rockefeller flooded the nation with bulletin after bulletin, defending the coal operators and denouncing the strikers and their leaders. These bulletins contained false and deceptive statements. Salaries paid to officials of the United Mine Workers in Colorado for the year ending November, 1913, were conspicuously displayed as salaries for the nine weeks ending in that month. This gross and palpable slander was

mailed to thousands of congressmen, editors, ministers of the gospel, school teachers, public officials, business and professional men, whose names appeared on Mr. Lee's carefully prepared mailing lists. No correction was made until it had been exposed by this Commission during the hearing in Denver in December, 1914.

"The preparation and distribution of these bulletins was carried on with the greatest secrecy as to the authorship of Mr. Lee and as to his employment by Mr. Rockefeller. When this Commission demanded the name of the writers of the bulletins of Mr. Welborn, during the hearing in December, Mr. Welborn refused to answer until he had consulted his attorney. Even then he carefully refrained from revealing the fact that the publicity campaign had been initiated and paid for by Mr. Rockefeller.

"Has the Colorado strike opened the eyes of Mr. Rockefeller and his associates to necessity, wisdom or moral obligation pointing toward radical concessions and changes in Colorado? The evidence justifying an affirmative answer is lacking.

"The Rev. Mr. Gaddis visited all the camps of the Colorado Fuel & Iron Company and had exceptional opportunity to meet the miners and superintendents and to ascertain the actual conditions. Testifying in May, 1915, he summed up his judgment of the situation existing in these camps in the following language:

"I have never seen a situation to my mind more despicable and damnable. * * * It is an oligarchy that is controlling everything."

The direct cause of the strike, says the report, was the refusal of the mine owners, led by the Rockefeller Company, to grant a conference to representatives of the strikers. The report says, after relating at length efforts of the union officials to obtain a conference during the summer of 1913 and prior to the strike:

"Spies and local officials had kept the operators fully informed of the unrest existing in the coal camps. That this unrest was of long standing is shown by Mr. Bowers' letter of September 19, 1913, to Mr. Murphy, in which he tells of the steps taken within the preceding year or two to forestall agitation. Before the strike began, Mr. Welborn wrote to a director in New York, Mr. J. H. Clements, expressing the writers anxiety and predicting that most of the men would go out if a strike were called.

"In his letter of September 19 to Mr. Rockefeller's office, Mr. Bowers makes the significant admission that the operators believed they could avoid the strike by merely granting a conference to the union officials. He writes:

"The strike is called for the 23rd, but it is thought on the part of a good many operators that the officials, anticipating being whipped, will undertake to sneak out if they can secure even an interview with the operators, which so far as they have been

unable to do, thus boasting before the public that they have secured the principal point, namely, recognition of the union.'

"It was three days before the date of this letter that Mr. Rockefeller in New York had declined to see Mr. Ethelbert Stewart of the United States Department of Labor, and instead had directed his attorney, Mr. Murphy, to receive Mr. Stewart and to refer him to the executive officials in Colorado.

"In the light of Mr. Bowers' admission that a mere conference would have prevented the strike, the operators' refusal to grant such a conference must be regarded as making them responsible for all the disasters that followed. For it was a policy opposed to the spirit and the practice of the times, and the state of mind which dictated it can only be explained on the theory that the habit of arbitrary power had fastened itself on the men who ruled the coal mining counties from their offices in Denver."

The report charges Mr. Rockefeller and other operators with misrepresenting the facts regarding a conference with striking employes held in Governor Ammons' office on November 26, 1913. This conference led to the plan of settlement contained in Governor Ammons' letter of November 27. The report says:

"The effort is made to convince the public that in meeting their men and accepting the governor's proposition, the operators conceded all that reasonable men could ask, and that the strikers in rejecting it became responsible for an unjustifiable continuance of the strike. Therefore, it is important to arrive at a correct conclusion regarding the validity of the operators' action as an effort in good faith to meet the strikers half way and as a modification of their previous arbitrary refusal to yield an inch.

"But the most conclusive evidence regarding the bad faith of the operators in this alleged consent to meet their men is contained in the following extract from the examination of Mr. Ivy L. Lee at Washington, in May, 1915. Mr. Lee had visited Colorado and had become, since the strike, a director representing Mr. Rockefeller in the Colorado Fuel & Iron Company:

"'Commissioner Weinstock: Are you aware of the fact, Mr. Lee, that it was brought out in the testimony here, that the operators did meet with representatives of the strikers in the office of the governor some two months after the strike took place?"

"'Mr. Lee: Yes, that has been brought out, Mr. Weinstock; but I cannot say that I have been impressed with the fact that the representatives of the men who met the operators were truly representative.

"'Commissioner Weinstock: Now, will you explain in what way they did and did not represent the men?"

"'Mr. Lee: Well, I just give you my impression. I have not been impressed with the representative character of that committee.

"'Commissioner Weinstock: Do you recall who the members were?"

"'Mr. Lee: I do not. I simply give you a general impression. My feeling is that that was one serious mistake.

"'Commissioner Weinstock: Meeting these men in the office of the governor?"

"'Mr. Lee: It was the failure to meet the real representatives and talk it over with them.

"'Commissioner Weinstock: You don't know how these men were chosen that met in the governor's office?"

"'Mr. Lee: No; I simply give you my impression as to their general standing."

Discussing the company's rejection of President Wilson's plan of settlement, the report quotes a letter from Mr. Murphy, Mr. Rockefeller's attorney, to President Welborn, as follows:

"The fact that the President of the United States has suggested a plan of settlement and has given it out to the public produces a delicate situation which we have no doubt you gentlemen in the west will handle in the same careful and diplomatic way in which you have handled the whole situation thus far, avoiding on the one hand any entanglement with the labor union and on the other an attitude which would arouse a hostile public opinion. We are, of course, greatly interested, and if you think we can be of any service in helping you to prepare a reply we shall be most happy to collaborate on any draft of one which you may send us."

And the report adds:

"Mr. Rockefeller here sends his instruction that there be no entanglement with the labor union, which, it apparently was feared, might grow out of an acceptance of the president's plan. The letter of Mr. Murphy clearly conveys Mr. Rockefeller's wish that his Colorado officials shall not be unduly impressed or swayed from their course merely by a request from the President of the United States."

"Enough has been told to prove that a spirit of accommodation or conciliation at no time actuated either the Colorado operators or Mr. Rockefeller. The evidence is conclusive that such a spirit, if manifested, would have prevented the strike and all the disastrous events that accompanied it."

Discussing violence, the report states that the first act of violence in connection with the strike was the killing of Gerald Lippiatt, an organizer for the union, by a Baldwin-Felts detective in the employ of the Colorado Fuel & Iron Company. It adds:

"But the question as to who committed the first act of violence is of minor importance. Conditions in the coal mining district were such that violence was inevitable. The testimony of Sheriff Jefferson Farr and former Undersheriff John McQuarrie proves that men accustomed to the ready use of a revolver or rifle had been imported into the district in large numbers from Texas, New Mexico, West Virginia and

other sections by the Colorado Fuel & Iron Company and its associates. These mercenary adventurers had been employed and armed by the coal companies prior to the strike, and had been given deputy sheriffs' commissions by the sheriffs of Las Animas and Huerfano Counties, who were political partners and agents of the coal companies.

"When the miners left their homes on company property and established tent colonies on land leased by the United Mine Workers, they knew that they could expect no protection from officers of the law. A sheriff who at the company's behest would deputize hundreds of men whom he had never seen, and who, for all he knew, might be red-handed murderers fresh from the scenes of their crimes, could not be counted upon to safeguard the rights of striking employes of a company that was his partner in the liquor business and his political master. Mr. Lawson, the most prominent Colorado official of the United Mine Workers, knew from bitter experience how low the sheriff of Huerfano County would stoop to aid the operators and to crush the strike. The scene was set, so far as the operators were concerned, for a repetition of 1903 and 1904, when every constitutional right of the strikers had been violated and they had been deported, imprisoned and assaulted.

"At the inception of the strike it seems clear that the union officials and the strikers determined that 1903 was not to be repeated; that at the first attempt of the operators' private army to override their rights, there should be resistance. But it is clearly established that the operators had employed 326 armed mine guards in Huerfano County alone prior to September 1, and that no step to arm the strikers was taken by union officials until twelve days after that date. Mr. Welborn gives September 12 as the first date when, it is alleged by the operators, arms were purchased of a Pueblo hardware dealer by agents of the union.

"In addition to the presence of large numbers of armed guards and the absence of honest and impartial public officials to control them, there existed the elements of violence that are common to all large strikes. The strikers had established tent colonies at strategic positions near the mouths of the canyons in which the mines were situated, so that strikebreakers going from the railroad stations to the mines were forced to pass near them. The history of strikes shows that workmen on strike feel that they have a property interest in their jobs, and that other workmen who take their places and thus aid their employers to defeat the strike are fit subjects for abuse, ridicule and violence.

"It is only by ostracizing and intimidating strike breakers that organized workmen can hope to discourage the practice and thereby win in a struggle for higher wages or for industrial democracy. For after negotiation fails, their only means of exerting a compelling influence on the employer is to stop

production by quitting work and to prevent a resumption of operations by keeping out strikebreakers. And society, if it wishes to prevent violence in industrial disputes, has only two courses open: To prohibit strikes, and in so doing to establish involuntary servitude; or to prohibit the importation of strikebreakers at least until the employers consent to meet officials of the strikers' union."

The report gives an account of the various riots and disorders and says:

"In all discussion and thought regarding violence in connection with the strike, the seeker after truth must remember that government existed in Southern Colorado only as an instrument of tyranny and oppression in the hands of the operators; that, once having dared to oppose that tyranny in a strike, the miners' only protection for themselves and their families lay in the physical force which they could muster.

"It remains to be seen how even the supreme authority of the state failed to protect them in their struggle for the right to work and live as free men and to bring up their children in an atmosphere where law and order was not synonymous with the anarchistic will of a lawless corporation."

One chapter of the report is devoted to the part played in policing the strike by the Colorado militia. It states that Governor Ammons when he called out the militia issued orders that they should not be used to escort imported strikebreakers from the railroad station to the mines. The report says:

"That this policy of Governor Ammons was not out of line with the correct theory of policing strikes is indicated by the fact that when the federal troops entered the field seven months later similar orders were issued to them by the Secretary of War.

"The wisdom of prohibiting the importation of strikebreakers as a means of maintaining order has been amply demonstrated, but this policy rests on a firmer basis than its mere expediency. The record in Colorado shows that in 1903 and 1904, and again during the strike under discussion, the coal operators had no scruples in taking steps to displace men who for years had been attached to the mining communities by ties of family, friendships and love of state, with homeless and penniless immigrant workmen from distant states.

"The record shows that strikebreakers were imported in carload lots under the guard of private detectives who recruited them in distant cities, and that both on the train and after their arrival in Colorado they were treated more as chattels than as free men. Contracts in the possession of the Commission made by detective agencies engaged in such work show that these agencies guarantee against the escape of strikebreakers enroute by providing guards for the front and rear entrances of the railway coaches. So extensive are the organizations of such agencies that strikebreakers

can be supplied within a short time in any numbers.

"If employers and strikebreaking agencies are to be permitted to operate in this fashion without let or hindrance, it means that entire communities of home-making and home-loving citizens can be displaced almost over night by an army of homeless vagabonds, drawn from the scum of the labor markets of widely scattered cities. This practice makes wanderers of hard-working and home-loving men whose only offense is that they have taken part in a strike. It fills strikers with hatred and leads inevitably to violence and finally it has a disastrous effect on the community and the state by working a deterioration in the quality of the citizenship."

The report charges that several weeks after the troops entered the field, the mine owners coerced Governor Ammons into countermanding his orders and permitting the use of the militia to escort strikebreakers. On this point the report says:

"In spite of the occasional acts of violence, the strike zone remained comparatively quiet so long as Governor Ammons' orders against the use of troops to escort imported strikebreakers remained in effect. The governor's policy in this respect had been vigorously opposed by the operators, and immediately after the calling out of the troops they began a campaign to coerce the governor into withdrawing his original orders and directing the troops to act as escorts for imported strikebreakers. Letters already quoted from Mr. Bowers, the highest executive official of the Colorado Fuel & Iron Company, to Mr. Rockefeller in New York show the methods pursued by the large companies. On November 18, 1913, he wrote:

"You will be interested to know that we have been able to secure the co-operation of all the bankers of the city, who have had three or four interviews with our little cowboy governor, agreeing to back the state and lend it all the funds necessary to maintain the militia and afford ample protection so that our miners could return to work, or give protection to men who are anxious to come up here from Texas, New Mexico and Kansas, together with some from states farthest east. Besides the bankers, the Chamber of Commerce, the Real Estate Exchange, together with a great many of the best business men, have been urging the governor to take steps to drive these vicious agitators out of the state. Another mighty power has been rounded up in behalf of the operators by the gathering together of fourteen of the editors of the most important newspapers in Denver, Pueblo, Trinidad, Walsenburg, Colorado Springs and other of the larger places in the state. They passed resolutions demanding that the governor bring this strike to an end, as they found, upon most careful examination, that the real issue was the demand for recognition of the union, which they told the governor would never be conceded by the operators, as 90 per cent of the miners themselves were

non-union men, and therefore that issue should be dropped.

"Still the governor hobnobs with Hayes, Lawson, McLennan and the rest of the gang, and either refuses or begs for more time to bring the strike to an end or to amply protect the operators in bringing in outsiders to take the places of those who have left the state and those engaged in these murderous assaults whom we refuse to take back under any circumstances. Yet we are making a little headway.

"There probably has never been such pressure brought to bear upon any governor of this state by the strongest men in it as has been brought to bear upon Governor Ammons."

"On December 22, 1913," says the report, "Mr. Bowers announced the success of this campaign of coercion in the following letter to Mr. Rockefeller:

"If the governor had acted on September 23 as he has been forced to act during the past few weeks, the strike would have never existed ten days.

"We used every possible weapon to drive him into action, but he was glove-in-hand with the labor leaders and is today, but the big men of affairs have helped the operators in whipping the agitators, including the governor.

"Now these fellows are cursing him without regard for common decency, so everybody is giving him more or less taffy to keep him from backsliding. The inclosed is a sample of the resolutions being sent to him, besides any number of personal letters."

The testimony of former United States Senator Thomas M. Patterson is quoted to show that the countermanding of this order by Governor Ammons resulted in throwing the militia entirely on the side of the operators and that very soon after the original order had been rescinded the state troops, under General Chase, began to disregard the civil rights of the miners by imprisoning them without a hearing and by exercising arbitrary power in controlling their movements.

The report states that the economic dependence of the state troops on the Colorado Fuel & Iron Company and other operators has been fully established. President Welborn testified that his company had paid militiamen from \$75,000 to \$80,000 on certificates of indebtedness.

Mine guards and company employes were enlisted by the militia and paid by the companies and the troops became, in every sense, allies of the operators against the strikers. One troop of mine guards and company employes which took a prominent part in the so-called Ludlow massacre was enlisted with the knowledge and approval of the Colorado Fuel & Iron Company and of Mr. Rockefeller only a week before the massacre.

The report describes the destruction of the Ludlow tent colony with the deaths of thirteen women and children and five strikers, three of whom were murdered by

the militiamen and mine guards while being held as defenseless prisoners. It describes the virtual rebellion that followed.

In closing its discussion of the militia, the report says:

"It seems of vast importance that it should be understood how nearly the situation in Colorado approached a condition of absolute prostration of government and of actual revolution. This is apparent not so much in the record of battles and skirmishes fought and lives lost, as in the evidences given above of the state of public feeling. It was apparent in the frankness with which strike leaders admitted that they were gathering and distributing arms, in the open admissions made by many strikers that they or others whom they named had taken part in one or the other of the various attacks, and in the refusal of the district attorney of Las Animas County to take official notice of the killings which followed Ludlow. The rules of 'civilized warfare' formed the only criterion for public criticism of acts on either side during this period.

"Enlightened public sentiment existing in Denver and other Colorado communities found itself helpless of effective expression. That expression, of course, should have come through the state. This leads to the direct causes of the failure of government and of all the horrors that resulted from it. Their consideration is vitally important because there is no guarantee that the same cause may not operate again in Colorado or other states, and that some day they may produce a situation far more serious even than that under discussion.

"The state of Colorado through its military arm was rendered helpless to maintain law and order because that military arm had acted, not as an agent of the commonwealth, but as an agent of the parties in interest, as an agent, that is, of the coal operators, as against the strikers.

"Only those who hope and pray for bloody revolution can contemplate the record of the Colorado National Guard and fail to see the need of measures that will make this branch of the government as representative of the people and as subservient to the people's will as other governmental agencies. Today there is ample evidence in Colorado to prove that the national guard is an instrument of oppression maintained for the purpose of intimidating and crushing workmen who go on strike in an effort to improve the conditions of life for themselves, their women and their children, and to secure for themselves a larger measure of freedom from arbitrary power."

The report quotes at length from the testimony of the Rev. Eugene S. Gaddis, superintendent of the Sociological Department of the Colorado Fuel & Iron Company, to show that the company's store system; its method of renting property to liquor dealers, and its hospital system, contributed to the unrest of the miners, and to the intolerable situation existing in the camps.

The companies are scored for their use of political power to control coroners' juries and other officials dealing with cases of personal injuries in the mines, in order to prevent miners from recovering damages for personal injuries in the courts.

The testimony of a former under-sheriff is quoted to show that the mine superintendent is always consulted in making up a coroner's jury, and that the sheriff of Huerfano County boasted of being a Colorado Fuel & Iron Company man.

Records are quoted to show that personal injury suits against the companies are practically unknown.

Testimony and letters by officials of the Colorado Fuel & Iron Company are quoted to show that the companies control the churches in its camps and exercise a censorship over the sermons of the ministers.

On the subject of permitting the miners to employ checkweighmen, the report says:

"No more substantial cause for resentment could be imagined than this denial to the miners of any means to insure honest payment of wages. And in denying the right to organize, the companies must be convicted of doing just this. It is impossible to conceive of the citrus fruit growers in California sending their oranges and lemons to the eastern market unweighed or unnumbered, and accepting the figures of the jobbers in the East as a basis for payment. Yet the situation would be analagous to that endured by the Colorado miners."

The reasons assigned by the operators for refusing to deal with the United Mine Workers are discussed at length. None of these reasons are declared to have been sufficient to justify the operators' refusal, and the animating reason is declared to have been merely the operators' unwillingness to brook any interference with their power.

Discussing concessions granted to the men, prior to the strike, by the Colorado Fuel & Iron Company, the report points out that all of these consist of rights already required by the laws of the state, several of which the company had previously violated. It declares that the company, in granting concessions, was animated not by respect for law or by desire to improve the conditions of their employes, but by the wish to forestall agitation by union organizers, and thus minimize the danger of a successful revolt. Letters from Mr. Bowers, Mr. Rockefeller's agent in Colorado, are quoted to substantiate this charge.

Mr. Bowers is also quoted at length to prove that political activity and domination by the Colorado Fuel & Iron Company still exist in the mining communities. It calls attention to Mr. Bowers' admission that men, whom he himself characterized as cut-throats, were employed by the company as spies on their employes.

Discussing the use of political power, the report says:

"Most important of all benefits enjoyed by the companies as a result of their polit-

ical control was the aid of subservient public officials in denying agitators or union officials access to the camps, during peace, and in intimidating, arresting, imprisoning and killing strikers and their leaders during strikes. This use of political control by the companies is more important than their use of it to ignore mining laws or to prevent the collection of damages for personal injuries, for the reason that it has effectually prevented the unionization of the mines. This unionization would have given the miners an economic weapon with which they themselves could have forced compliance with the law and by which they could have speedily broken the hold of the companies on government, by limiting the power of discharge, and thus establishing free speech, a free press and free assembly, and encouraging healthy discussion and agitation."

The report takes up at great length the five causes of the strike as set forth by the strikers, as follows:

1. Ignorance of the owners of the great coal producing properties concerning actual conditions under which their employes live and labor.

2. The lack of any proper sense of personal responsibility on the part of those owners, for what is wrong in those conditions.

3. The maintenance by the coal-mining operators of a modern system of monopolistic feudalism, with many of the evil features of the old feudalism, but without many of those features which made it somewhat beneficent.

4. Insistence by the operators upon their right to conduct a vast coal-producing business—a business in reality affected with a public interest—regardless of how their conduct may affect society at large, and as if it were a small private business.

5. The unwillingness on the part of the operators to concede to their employes the right of effective organization, while themselves maintaining a complete combination and organization.

Testimony and letters are quoted at length to support the report's conclusion that each of these charges is fully justified by the facts.

Regarding the claim of the operators that their employes did not belong to the union and that the strike was forced by a minority, the report says:

"On September 15 the convention of miners was held at Trinidad. Whether or not the men who sat in this convention and who voted for the strike, were representatives of the great body of miners, is a subject of controversy. It is regarded as relatively unimportant, in its bearing on the state of mind of the mining communities, and their attitude toward a strike.

"Spies, camp marshals, and armed guards infested the mining camp of the city of Trinidad, and the miner who might wish to attend such a convention, or to attend local meetings for the selection of delegates, knew that to do so would be to incur prompt discharge and expulsion from the town.

"In Huerfano County alone, 326 men, many imported from other states, had been commissioned as deputy sheriffs by Sheriff Jefferson Farr prior to September 1. Sheriff Farr admitted, before this Commission, that for all he knew they might have been red-handed murderers, fresh from the scenes of their crimes, and that they were employed, armed and paid by the Colorado Fuel & Iron Company and the other large companies. The first violence had already occurred in the killing of Gerald Lippiatt, a union organizer, who was shot down on a street in Trinidad by a detective in the employ of the operators.

The convention voted to call a strike for September 25, 1913. On that day, from 8,000 to 10,000 miners, comprising from 40 to 100 per cent of the employes at the various camps, packed their meager household belongings on carts and wagons, and, accompanied by their women and children, moved down the canyons through a drenching fall of snow, sleet and rain, to the tent colonies that had been established by the union officials. This sudden exodus became necessary because, in a majority of the coal camps, the companies owned every house and every foot of ground. No more eloquent proof could be given of the intense discontent of the miners and their families, and of their determination to endure any hardship rather than remain at work under existing conditions.

Dealing with the character of the men employed in the coal camps, the report says:

"Coming as amazing evidence of the repudiation of American principles by certain small but powerful groups, is the allegation frequently heard during the Colorado controversy that the inhabitants of the coal camps, being largely of foreign birth and speech, were incapable of either political self-government or of exercising a voice in determining their working conditions. Such an acceptance of the political philosophy that justified slavery half a century ago hardly needs serious consideration. Granting that social and political conditions in the coal camps could be worse than those which existed under coal company domination, and granting that they actually would be worse under a truly democratic control, the nation even then could not complacently tolerate a benevolent despotism. But no such concession can be made. There is ample testimony to prove the capacity for civic and social progress inherent in the populations of coal mining camps composed just as were those of southern Colorado—of a small minority of English-speaking miners and their families and a majority of recently-arrived Europeans. Besides the testimony of officials of the United Mine Workers who have studied the needs of the foreign-born miners and who have watched their progress, the Commission has the significant testimony from Francis S. Peabody of Chicago, a mine owner who operates on a scale larger than that of any of the Colorado companies."

THE BOILER MAKERS' JOURNAL

Official Organ of the International Brotherhood of Boiler Makers, Iron Ship Builders and Helpers of America.

A Monthly Publication Issued the First of Each Month from Room 8, Law Building, Kansas City, Kansas.

JAMES B. CASEY, Editor and Manager.

Subscription Price.....\$1.00 Per Year in Advance

ADVERTISEMENTS.

Advertising Rates Will be Furnished Upon Application to the Editor-Manager. No Reading Space Will be Sold for Advertising Purposes Under Any Circumstances.

All New Members Must Have Their Name and Address Sent in Through the Secretary of Their Lodge. After That They May Have Changes Made in Their Address by Filling Out Blank Form in Back of Book and Forwarding to the Editor.

All Copy Must be Received by the Editor by the 18th of the Month to Insure Publication in the Following Issue.

All Contributions and Correspondence Relating to the Journal Should be Addressed to J. B. Casey, Editor, Room 8, Law Building, Kansas City, Kansas.

Entered at Postoffice, Kansas City, Kansas, as Second Class Mail Matter.

MAKING A FARCE OF BOILER INSPECTION IN OHIO.

Word has come to us recently that Governor Willis of Ohio has appointed as chief inspector of boilers for that state a man totally inexperienced and incompetent for this position. It seems that he was first appointed as chief examiner of engineers, but as the engineers and others of that state made such a howl about it, he was removed from that position and made chief inspector of boilers, thus making a farce of boiler inspection in that state. However, our members in Ohio should not allow this matter to pass without a lively protest on their part, in fact they should not only protest themselves but take the matter up with the various central bodies and the State Federation of Labor and have them protest against this move that may result in such serious consequences in the future if allowed to continue.

Furthermore, our members in Ohio should seriously consider the fact that they have neglected the matter of securing proper boiler inspection laws for that state in the past and that others took advantage of this neglect or indifference and secured the enactment of spurious boiler inspection laws that practically eliminates boiler makers as boiler inspectors. They may design, build, repair and keep in good safe condition, but cannot inspect their own handiwork. This is an intolerable condition that our members should not allow to continue. It does a serious injustice to those who are thrown in close proximity to boilers in operation, because of the danger due to faulty inspection and it is an outrageous imposition on boiler makers. However, mere condemnation of the law will be of no avail. What the boiler makers in Ohio (and many other states, for that matter) should do is to wake up, get together and lay systematic plans for having the law changed so that a safe and efficient system of boiler inspection, with experienced boiler makers as inspectors, may be inaugurated.

This matter should receive the serious consideration of our members in a number of states unless they wish to abandon all claims to boiler inspection. However, the first thing for our lodges in Ohio to do is to draw up

resolutions of protest and send them to Governor Willis at Columbus, also take the matter up with other organizations and central bodies and have them send in protests also. Don't neglect or put off. Do it at once.

MOULDERS OVERWHELMINGLY REJECT AMALGAMATION.

The question of amalgamating all metal trades has been agitated and discussed pro and con by the members of the International Iron Moulders' Union for some time and a few lodges of that organization joined in requesting a referendum vote on the question. This was finally done and the vote closed with the ending of September and in the last issue of the International Moulders' Journal we find the result of that vote was 1,946 votes in favor of amalgamating and 10,758 votes against amalgamating, thus a majority of 8,812 were against amalgamation, more than five and a half to one.

This result should convince the most ardent advocate of amalgamation in the moulders' ranks that a large majority of the members of the moulders' union are against this proposition, in fact we believe this represents the general sentiment of the members of the trades that would be affected by amalgamation.

The members of these trades have too much at stake to sacrifice their organization and jeopardize the future of the labor movement by adopting any of these short cut, hazardous schemes of organization in place of their trade union. The various metal trade unions can secure all the advantages of consolidation through federating, like they are now doing, through the Metal Trades Council, and at the same time avoid all the disadvantages and dangers of a promiscuous organization.

A ROCKEFELLER "MODEL UNION" PUT IN FORCE IN COLORADO.

John D. Rockefeller, Jr., during his recent trip to the mines of Colorado, sprung a plan for settling all labor disputes and establishing harmony between the miners and the management. It is to be accomplished through his "model union," a creation of the brain of Mr. Rockefeller and his industrial managers. The mine workers had nothing to do with its plans or provisions.

The plan does not contemplate recognizing any organization of the miners, in fact an open shop is insisted on. Instead the men from each mine elects two of their number. These are supposed to look after the interests of the men. An arbitrator or industrial representative is to be selected, whose duties are to investigate grievances and render decisions; however, appeals may be taken from his decisions and carried on up.

The plan will no doubt receive a fair trial, and while it might be the part of wisdom to withhold criticism in the meantime, still we cannot help

expressing our belief that it will prove a failure in so far as protecting the full rights of the men are concerned, for on the one hand we find a thoroughly organized, rich, influential and powerful organization, and on the other poor, needy and helpless individuals entirely dependent on the good will of this corporation for the opportunity to earn a living. Should it become displeased with any of them and withdraw this opportunity to toil, they would soon be driven to want and suffering. Under this one-sided condition it is not probable that the men will secure a fair share of the wealth they produce.

In fact, it looks like a well thought out plan to prevent real organization among the miners that would deal with the company on more of an equal footing and would be in a better position to secure even handed justice for the miners.

While we believe this plan is foredoomed to failure, still we believe the trial of it will show the men a need for a real organization and in the end it will be created by them, in spite of the company's efforts to the contrary.

THE EXECUTIVE COUNCIL INDORSES MOVEMENT TO ERECT MONUMENT TO THE MEMORY OF BROTHER GILTHORPE.

One of the many matters acted upon by the Executive Council of our organization, while in session recently, was that of a resolution adopted by Lodge 25 of San Francisco which provides for the raising of voluntary contributions to a fund to erect a monument to the memory of our late International Secretary-Treasurer Gilthorpe. A copy of these resolutions appear in another part of this Journal.

The council unanimously indorsed the proposition and will issue an appeal to the lodges for contributions at an early date.

We hope that a generous response will be made to this move and that a sufficient amount with which to purchase a monument commensurate with the memory of the departed brother and the dignity and generosity of our members will be raised, and there is little doubt but that it will.

It will be a fitting service to the memory of a brother who served so long and faithfully as an International officer of our organization.

We believe the council accurately voiced the sentiments of the rank and file of our membership in indorsing this matter and that our members will respond generously to the appeal for funds.

THE STRIKE AT NEW ORLEANS SETTLED.

We are glad to state that the recent strike of our members employed in the contract shops of New Orleans and vicinity is a thing of the past. A satisfactory settlement has been reached between the men and the New Orleans Metal Trades' Association.

The conditions are, we believe, that the former agreement be restored and all men returned to work. Minor changes, we believe, were made in the agreement in reference to settlement of grievances and the manner of the termination of the agreement. The settlement was secured through the efforts of First Vice-President Hinzman and Eighth Vice-President Ryan, assisted by local members.

The underlying cause of the strike was, we believe, the existence of a benevolent organization composed of a part of the men in New Orleans, who supported this rather than the Brotherhood. However, these men are now seriously considering the matter of uniting with the balance of the boiler makers of that city, so that there will be but one organization of boiler makers there, united, harmonious and indestructible, working for the advancement and benefit of our trades. Let us hope this desirable goal will be reached at an early date.

MORE FUTURE CHANGES TO BE MADE IN THE JOURNAL.

While the council was in session we took up with them the matter of publishing the official roster but once each quarter, and in this way gain ten pages each, for eight issues during the year, or a total of eighty additional pages of reading matter each volume or year.

The matter was discussed at considerable length and from various angles, and it was shown that a large majority of the trades unions had completely abandoned the policy of printing a roster of their locals in their journal, and the discussion turned to the advisability of discontinuing the printing of roster in our journal and issuing it in pamphlet form in a suitable size to carry in the pocket. Several good reasons were advanced why this change should be made, among which was that in localities where only a portion of the men are organized or a new local is being instituted members are sometimes discharged because of their names being published as officers. Another reason advanced was that the change would tend to prevent so many outside appeals for aid from our lodges and members. The council finally decided to have this change made, therefore, this issue will be the last that the roster will appear for the present. It would not appear any more this year anyway, as we have for the past four or five years compiled an index for the year and run it in the December issue.

We believe this change will prove satisfactory to our members after they get used to the idea, and that it will be beneficial to our organization as well as our members. At any rate it is worthy of a fair trial.

Another change decided upon was to cut out the publication in the Journal of those found guilty of scabbing. Instead these names will be furnished the lodges at frequent intervals through circular letters or pamphlets in convenient form so they can be kept on file in systematic form. It was asserted that the publication of these names in the Journal gave valuable in-

formation to the strike breaking agencies, through which they did their recruiting. We believe this change will also be beneficial alike to our members and the organization.

Another change decided on was that instead of the international officers reporting through the Journal bi-monthly or less frequently, that each would be expected to report each month, and that in the event that any of them were working on confidential matters which it was not deemed advisable to make public at the time, they should at least write a short article on other matters, preferably on questions affecting the welfare of the members in their district.

No doubt this change will give much satisfaction to our members and prove of much benefit to our brotherhood by arousing an increased interest in its affairs among the rank and file.

TRYING TO CREATE SENTIMENT FOR A TARIFF COMMISSION.

An organization known as the "Tariff Commission League," with headquarters in Chicago, has been formed for the purpose of creating public sentiment in favor of a tariff commission, whose alleged duty would be to place the tariff on a "scientific basis," as if there was any science in robbing the masses of the people for the benefit of a few who have already waxed fat on this humbug in the past.

This move is supposed to be a non-partisan one. However that may be, it bears all of the earmarks of the movement inaugurated by Mr. Emory a few years ago in behalf of the manufacturers' association, with all of its corrupting influences on Congress and which was exposed by a Congressional investigation.

The country is being flooded with literature by this league and its representatives are touring the country trying to manufacture sentiment for this commission and no doubt it will be boosted before the coming session of Congress.

However, we hope the people will not be fooled into lending their support, for we believe it nothing more or less than an effort to get control of the tariff-making powers of the government and boost the tariff in behalf of special interests. It has been fully proven that high tariff is but an added tax on the consumer without any return. The industries receiving the highest protection in the past paid the lowest wages and gave the worst conditions to its employees.

And even if there was merit in a high tariff this is no time, with the disturbed conditions in the world's commerce, due to the European War, to open up the question of a revision, and it is to be hoped that this large expenditure of money, literature and time of this tariff league will have no effect on the public.

THE DANGERS ARISING FROM OIL TANK CARS.

The terrible and destructive explosion of a tank car containing gasoline at Ardmore, Okla., a short while ago should arouse railroad employes generally to the danger of these explosions which are liable to occur at any time and with such frightful results.

This car which exploded was loaded with 3,000 gallons of gasoline, and had in some way sprung a leak. One newspaper account says a car inspector mounted the car, unscrewed the cap and peered in when the explosion took place, tearing to pieces everybody and everything within a hundred yards. The leak in the tank had no doubt left an empty space at the top and in this condition was much more dangerous than if full—in the latter case there would be no room for generating gas.

In most places our members are called upon to make repairs on these tanks and they should use the utmost care in entering or going around them with fire and under no circumstances should they enter an empty with a lighted torch or a hot rivet until the tank has been thoroughly cleaned, no matter whether it previously contained gasoline, benzine or crude oil. In either case it will generate gas and explode if fire is brought within range.

About eighteen months ago, Brother Houston of Portsmouth, Va., lost his life through the explosion of gas in an empty, by dropping a hot rivet in the tank while he was inside.

Our members should take nothing for granted, when it becomes their duty to work on these tank cars. They do not get paid to take unnecessary risks and no reasonable official will ask them to place their lives in jeopardy. Let safety first be the watch word.

THE PANAMA CANAL CLOSED BY LAND SLIDES.

Owing to enormous land slides recently the Panama Canal has been closed indefinitely. It is estimated that it will take from forty-five to sixty days to clear away the loose earth, and open the channel again. It is hoped that sufficient earth will be removed this time to prevent a repetition of these slides.

The growing importance of this canal can be seen by the fact that 95 ships were held up by this slide, many departed to take another route when they found it would not be possible to use the canal for some time; others transferred their cargoes to the canal zone railroad, and others will wait until they can pass through.

It is to be hoped the trouble will be definitely removed this time and that no further interruptions of traffic will take place.

Ten or fifteen years from now if such an interruption for so long a period should take place it would be little short of a calamity and would disarrange the commerce of the world as by that time a large percentage of the world's

commerce will pass through this canal. No doubt it will not be very long until the Panama exceeds in importance and business done, that of the Suez Canal.

ORGANIZED LABOR IN NEW YORK WILL OPPOSE NEW CONSTITUTION.

In our September issue we mentioned the fact that deep, died in the wool reactionary standpatters were in control of the New York State Constitutional Convention and urged our members to scan carefully the changes proposed, so they might intelligently act on the matter.

Since that time the Convention has completed a draft of a New Constitution and adjourned.

After this proposed constitution was made public, it did not take the union men of New York state long to arrive at the conclusion that to adopt this constitution would be a long step backward. Representatives of Labor throughout the State recently held a conference in Albany, under the auspices of the State Federation of Labor and unanimously decided to do every- in their power to defeat it. It is to be hoped that our members in the State of New York will actively co-operate with the balance of the labor movement in helping to decisively defeat this constitution.

It is said that of the 168 members of the convention that 134 of them were lawyers. No doubt a large proportion of these are fully versed in all the wiles and wickedness of corporate greed and evasions of the law.

This overwhelming preponderance of lawyers is no doubt responsible for the bad result achieved.

In all representative legislative bodies it is not only desirable but necessary for successful results, that the members composing the body should be selected from among all elements that go to make up the citizenship of the state, in this way only can a thoroughly representative constitution be enacted.

The good people of New York should repudiate this new draft of a constitution and retain the one they have until a more favorable time when more representative delegation may be elected and an equitable progressive constitution formulated.

INTERNATIONAL OFFICERS VISIT FEDERAL PRISONERS.

A short while ago a bunch of International Officers from the Railway Carmen, Sheet Metal Workers and Boiler makers joined in paying a visit to the Iron Workers detained in the Federal prison at Leavenworth. The trip was made from Kansas City on a Saturday afternoon, arrangements had previously been made with the Officials, so the delegation was promptly admitted and all the Iron Workers given liberty and all repaired to a large reception room and an hour was very pleasantly spent in getting acquainted, chatting, etc.

The delegation brought along a basket of fruit and a couple of boxes of cigars which were thoroughly enjoyed by the imprisoned men.

We were agreeably surprised to see how well all were looking, showing the effect of good and humane treatment.

As the closing hour arrived, the delegation were forced to leave after hand shaking all around and a promise to return again at an early date.

OUR NATIONAL BANKING LAWS STILL NEED AMENDING.

While our National Banking laws were recently amended to a very radical extent and the whole management and control of our currency placed in the hands of national banks, still it would seem as if the laws governing these banks are anything but perfect and that the only restrictions placed upon their interest charges are their conscience and the urgency of the borrowers needs.

In addressing the State Bankers' Association of Kentucky recently Hon. John S. Williams, comptroller of the currency is reported as saying, "reports are on file in the office of the Comptroller at Washington, showing that National Banks admit having charged rates of interest as high as 40 per cent; 60 per cent, and even 1,000 per cent; and in one instance that is on record a National Bank charged a woman \$1 for the use of \$3.50 for six days." Continuing Mr. Williams stated that of the 7,615 National Banks in this country 1,020 have sent in detailed reports showing they have received an average of 10 per cent or more on their loans. While it is generally believed that some state banks, trust companies and private bankers at times charge an excessive rate of interest, we did not know that any National Bank was guilty of charging usurious rates of interest too.

As National Banks collectively have some of the choicest privileges of the Government itself conferred on them and are practically guaranteed against loss, their rates of interest should be rigidly regulated by law. No business or individual making extensive use of borrowed capital can prosper if they have to pay ten or more per cent interest for the money they borrow.

Comptroller Williams compiled a list of National Banks, whose average rate of interest amounted to over ten per cent, and they are located as follows: 2 in Illinois, 6 in Minensota, 2 in Missouri, 23 in Georgia, 6 in Florida, 21 in Alabama, 2 in Louisiana, 315 in Texas, 17 in Arkansas, 2 in Tennessee, 90 in North Dakota, 25 in South Dakota, 18 in Nebraska, 5 in Kansas, 38 in Montana, 14 in Wyoming, 37 in Colorado, 25 in New Mexico, 300 in Oklahoma, 12 in Washington, 10 in Oregon, 13 in California, 2 in Utah, 1 in Nevada and 33 in Idaho. This list discloses an extensive field of operations and points to the small farmer as being the chief sufferer. Let us hope that Congress will back up Comptroller Williams' efforts to establish an equitable rate and enact a law on the subject. It should, however, be said as a matter of justice that a majority of National banks do not charge such rates as are

complained of, still a law is necessary to restrain the greedy and unscrupulous ones.

FACILITIES FOR A TECHNICAL EDUCATION ARE INCREASING.

We have occasions, from time to time, to congratulate the mechanic of today, upon the ever increasing facilities for securing a technical education.

Twenty-five years ago it was difficult to secure a technical education unless a regular student of some college or university; to learn the art of laying out work, was a very difficult matter, those who knew how, generally kept their knowledge to themselves. Since that time the correspondence school has developed and grown until they place the means of a technical education within the reach of all.

A new idea in correspondence school, devoted entirely to those engaged in railroading has been established in Omaha, Nebr. It is "The Railway Educational Bureau" and it has received the endorsement of a number of railroads and arrangements made whereby their employes may have the advantage of its service.

We are told the real purpose for creating this bureau was not to make money, but to furnish means to all railroad men to increase their knowledge of their chosen work, thus opening the door of opportunity to advance those who will study.

While most correspondence schools have a stereotyped course of study, we are told The Railway Educational Bureau furnishes special studies to suit the needs of the individual.

The service is furnished at a nominal cost and where arrangements have been made with a railroad system, it can be paid for monthly or otherwise to suit.

Among other railroads, The Rock Island system recently had this service extended to its employes. No doubt the idea will grow and expand until it or a similar service is in vogue on all railroads in America.

Our members should take advantage of these opportunities to advance their education and increase their information concerning the technical side of their trade.

Every Boiler maker and Shipbuilder should strive to be a first class mechanic, and in order to do so they should learn to lay out. If these correspondence schools are not available or do not appeal to any of our members they should secure books on laying out, a few drawing instruments and a board and practice at home. Any one who will persevere in their study of the subject can become proficient.

GENERAL PRESIDENT KIRBY OF THE CARPENTERS DEAD.

Word was received at Headquarters recently announcing the sudden death of Mr. James Kirby, General President of the Brotherhood of Carpenters and Joiners, at Indianapolis, Ind., following swiftly on the heels of a surgical operation.

Mr. Kirby's death came as a distinct shock and surprise to union labor circles generally, and is a real loss to the Brotherhood of Carpenters and Joiners, as well as the general labor movement, as he was an able and untiring worker in the cause of unionism.

QUOTATIONS.

A combination of the ideas of a certain figure, with a power of motion and reasoning joined to substance, make the ordinary idea of a man.—Locke.

Seeming wise men may make shift to get opinion, but let no man choose them for employment, for certainly you had better take for business a man somewhat absurd than over formal.—Lord Bacon.

A man may think, if he will, that two eyes see no more than one; or that a gamester seeth always more than a looker on—but when all is done, the help of good counsel is that which setteth business straight.—Lord Bacon.

He is good that does good to others. If he suffers for the good he does, he is better still, and if he suffers from them to whom he did good, he has arrived to that height of goodness, that nothing but an increase of his sufferings can add to it; if it proves his death, his virtue is at its summit—it is heroism complete.—La Bruyere.

Ambition is to the mind what the cap is to the falcon; it blinds us at first, and then compels us to tower by reason of our blindness. But, alas, when we are at the summit of a vain ambition we are also at the depth of real misery. We are placed where time cannot improve, but must impair us; where chance and change cannot befriend, but may betray us; in short, by attaining all we wish, and gaining all we want, we have only reached a pinnacle where we have nothing to hope, but everything to fear.—Colton.

STRIKES NOW IN FORCE.

- Atlantic Basin Iron Works (Shields & Moran, New York). (Strike on.)
- Hibbon & Co., contract shop, South Chicago, Ill. (Unfair.)
- Milwaukee Boiler Co., Milwaukee, Wis. (Strike on.)
- Des Moines Bridge & Iron Works, Des Moines, Iowa, (Erecting work in Bremerton, Wash., Valejo, Calif., and Norfolk, Va., Navy Yards.)
- Heinie Safety Boiler Co., of St. Louis, Mo. (Strike on.)
- Wangler Boiler & Sheet Iron Co., of St. Louis, Mo. (Strike on.)
- O'Brien Boiler Co., St. Louis, Mo. (Strike on.)
- Halifax Graving Dock Co., Halifax, N. S., Can. (Strike on.)
- T. Hogan & Co., Halifax, N. S., Can. (Strike on.)
- The Arizona Copper Co., Clifton, Ariz. (Strike on.)
- Detroit Copper Co., Clifton, Ariz. (Strike on.)
- A. & N. M. Railroad. (Strike on.)

Mechanical Department.

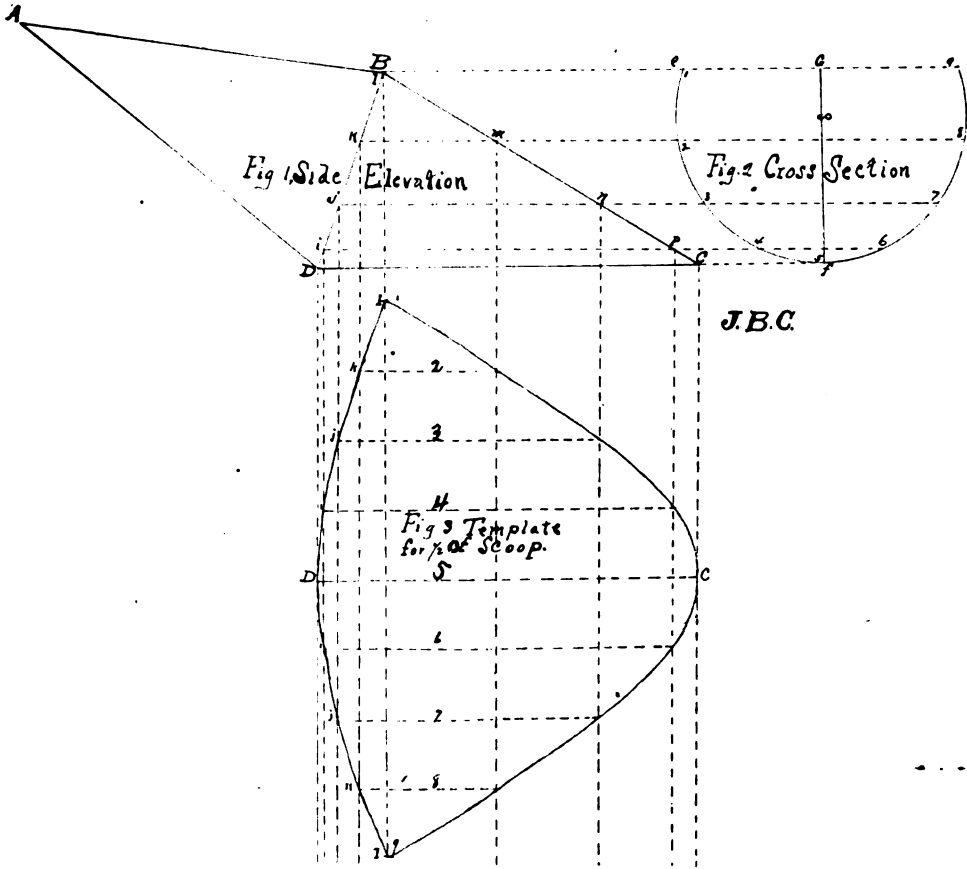

TO LAY OUT A SCOOP.

Fig. 1 shows the side elevation; fig. 2 shows a cross section of scoop at center (B D), and fig. 3 shows the lay-out of template for one-half of scoop.

First mark off side elevation the desired size and shape, draw center line B D, extend line D C to F with F as a center, erect vertical line F G, at right angles to D C F, mark radius of cross section from F to center O and with this as a center strike circular line E F G. The height of this segment will be determined by striking a line from B and parallel to line D C F until it cuts circle at E and G. Divide this circular line into eight equal parts, numbering points of division from one to nine, draw lines through these points parallel with base line D C F, extending them until they strike line B D fig. 1. From points D, I, J, K, L,

M, N, P, C draw line at right angles with the sectional lines extending from fig. 2, to line B D fig. 1. Next strike line D C fig. 3, parallel with line D C fig. 1, and sufficient distance from it to allow for lay-out of one-half of template; take dividers set the same distance as used in dividing circular line fig. 2, and mark off on each side of line, D C fig. 3, the same number of spaces as there are on each side of center line G F fig. 2. From these draw lines parallel with center line D C. It will be noticed that these lines shorten up one space on each end for each line distant from the center line until they cut but one line at 1, these points are points in the outline of the template for one-half of scoop, and a line traced through these points will show the full outline of template.

If a lap joint is desired the necessary material should be added.

International Officers' Reports.

REPORT OF SECOND INTERNATIONAL VICE-PRESIDENT NOLAN.

The following is my report for September on places visited, by instructions from headquarters, and work done as result of same from September 1st to 30th, inclusive.

September 1st, by instructions of Vice-President Hinzman, left Wilmington, Del., for Washington, D. C., to arrange a date of conference at the navy department, for a committee representing Lodge No. 19.

September 2nd, called on Brother Berres, secretary-treasurer metal trades department, and in company with him called at the navy department, as he had several matters to take up with the assistant secretary in connection with the Norfolk and Philadelphia navy yards which was referred to him to adjust if possible. During conference I requested a meeting for a committee from Lodge No. 19 on the wage question then pending, which was agreed to, but no date given, unless to say sometime in the latter part of September, when Brother Berres would be officially notified as to date, and he in turn would notify Brother Hopkins, secretary of Lodge No. 19.

The reason for requesting such a conference was because of an increase in wage recommended by the wage board at the Philadelphia navy yard in 1914 for the boiler makers employed there, which was not carried out, although the committee who appeared before the board presented wage data according to naval regulations which showed a higher rate paid boiler makers by outside firms at Philadelphia and vicinity. Surely the navy department should not hesitate when a question of justice to the mechanics is involved as the wage board would absolutely refuse to recommend unless the proper evidence was presented before the board which entitled the boiler makers to the increase as recommend at that time.

September 3rd, returned to Wilmington, Del., to attend an open meeting, and other matters which required attention in connection with the reorganization of Lodge No. 494, remaining there until September 7th. Held several meetings during that time after which the reorganization of Lodge No. 494 was effected and the necessary amount was mailed to the International secretary to cover cost of same.

September 8th, left Wilmington, Del., for Norfolk, Va., as Brother Schmitt, international vice-president, had several important matters on hand in that locality for Lodges No. 57 and 428, namely, wage increase and agreement for Lodge No. 428; the question of organization in the Norfolk navy yard for Lodge No. 57; also a grievance with the Norfolk Southern Railroad Co., on a local shop proposition which the federated crafts on the system were opposed to.

September 9th, in company with Vice-President Schmitt, also Vice-President Van

Dorens of the Brotherhood of Blacksmiths and Helpers and the Executive Board of System Federation, held an arranged meeting with the general manager of the Norfolk Southern Railroad Co., Mr. Stack, also superintendent of motive power and master mechanic on system at the general offices of the company, union station, Norfolk, Va. Pleased to report that grievance was satisfactorily adjusted and trust the same pleasant relations will continue in the future between the federated crafts and the officials of the motive power department of the Norfolk Southern Railroad Co. Brother Jolliff of the blacksmiths is chairman of the federation; Brother Callahan of No. 428 represented the boiler makers at Berkley shops during conference on September 9th.

September 10th, in company with Vice-President Schmitt and Brother Phillips of Lodge No. 57 attended a regular meeting of Lodge No. 428, which was fairly well attended, might be better, as a very important proposition was then pending between the bosses of the various contract shops and the members of Lodge No. 428, namely, an agreement, also a twenty-five cent increase per diem. Brothers Schmitt and Halstead made quite a lengthy report of what had been done in an effort to secure a joint meeting between the bosses and a committee representing Local No. 428, and hoped to be successful in arranging matters later on.

September 13th, attended an open meeting of the boiler makers' helpers employed at the Norfolk navy yard, which was called through the efforts of Brother Smith and the active co-operation of the boiler makers, including Brothers Thomas, Phillips, Parish, Dorsey and others who were present to render all possible assistance in organizing the helpers. The meeting was a success as every helper present accepted an application for membership as well as expressing a desire to co-operate with the boiler makers in building up a strong local organization at the Norfolk navy yard.

Brother Schmitt made a strong appeal on the absolute necessity of organization among the helpers, and related many experiences of his travels through different sections of the country of the improved conditions of the helpers where organized both in railroad and contract shops or in government navy yards, where the importance of organization was equally essential to improve conditions as outside corporations and in closing urged all present to become members of the brotherhood. Several of the officers of Lodge No. 57 who were present, made short talks also on the benefits of organization. It is fully expected that Lodge No. 57 will have an increased membership after regular meeting October 7th, as the result of open meeting September 13th. May the good work continue as organization is needed bad in government navy yards

among our craftsmen in the hull department.

September 14th, left Portsmouth, Va., for Wilmington, Del., to initiate the members and install the officers of Lodge No. 494. On reaching there met the temporary officers to arrange several matters then pending.

September 15th, attended an open meeting of ship builders and helpers at which several applications for membership were received and before adjourning a committee was appointed to see every non-union boiler maker and ship builder and helper in order to hand them an application for membership in Lodge No. 494, Brotherhood of Boiler Makers, Iron Ship Builders and Helpers of America.

September 16th, a special called meeting was held at which the members of Lodge No. 494 were initiated and officers installed, after which short talks were made by many brothers present, all realizing that an organization was an absolute necessity at Wilmington, Del., as conditions in boiler shops and ship yards are not what they should be, all due to the lack of organization in that city, just like all others where a ship yards are located.

It seems strange in this age when organization is just as essential as the air we breathe to sustain life that men are so blinded to their individual and collective interests which they can't fail to observe, that every line of human activity, whether labor, professional, or others, all are compelled to get together for protection. Yet in the face of such evidence, which is as clear as the noon-day sun, we find thousands working under conditions which is akin to slavery but no efforts made whatever through organized efforts to change those conditions, even absolutely refuse, seem to be satisfied; surely intelligent American citizens should at least have some say under what conditions they shall work for an employer, and the compensation they shall receive for their labor, to preserve life and comfort for themselves and families, for the greatest of nature's laws is self-preservation, but when wage earners allow their God-given rights to be tampered with and often destroyed by some employers who sacrifice principle in their greed for dollars, aided and abetted by scabs, thugs and bulls, who prey like a buzzard on honest labor, surely legislation is badly needed to prevent such a state of affairs, as organized labor asks for nothing but a square deal, like any other business, and trust that Lodge No. 494, which lapsed several years ago, but now on the roster of the Brotherhood again, will be a success as there is every prospect of a large membership in the near future. In the past Lodge No. 494 was active and always had a delegate to conventions of the Brotherhood, and hope so again.

September 21st, left Wilmington, Del., for Philadelphia by invitation of Lodge No. 19, to confer with committee on a future conference with the assistant secretary of the navy, a very important proposition to the boiler makers employed at the Philadelphia

navy yard, namely, the wage question, which is always important. On reaching Philadelphia called on committee, Brothers Goodfellow, Hopkins and Higgs, and a satisfactory arrangement agreed on, relative to conference; in fact I had the pleasure of meeting all the officers and many members of Lodge No. 19 during my short stay there. Was very much pleased while in the navy yard to meet one of the old time members of the International Brotherhood in the Quaker City, Brother Manus McFadden, who is well and favorably known to many of the old members and hope he will enjoy many more years of activity both in health and in the interests of the Brotherhood in the future as in the past is the sincere wish of the writer.

September 22nd, attended a meeting of the navy yard federation of trades, Portsmouth, Va., the following were represented by delegates: Boiler makers, machinists, blacksmiths, boat builders and ship rights, painters, moulders, carpenters, joiners, asbestos workers, plumbers, sheet metal workers, also two federal unions. Many important questions came up for consideration during the meeting and referred to the proper committees. Brother Phillips of Lodge No. 57 and one of the ex-board members of the naval federation, made a practical explanation as to the question of rates in the government navy yards, and how same should be regulated in order to bring about favorable results, both to the employes and the navy department. His plan for a change in rating mechanics employed in government navy yards made a favorable impression on the delegates present representing the above organizations, and will be taken up through the proper channel at the first favorable opportunity as the question of rating and the proper regulations of overtime in government navy yards needs adjustment, at least to conform to co-operation located in the vicinity, as the American people regard the government as a model employer, taking no undue advantage whatever, only expecting a fair day's work for compensation given, nothing more or nothing less. But when navy yard mechanics are tied up as well as blocked in their efforts to produce results by continued introduction of so-called efficiencyisms, cost of operations are increased and generally the responsibility of increase cost of production is charged up to the wrong side of the ledger again; what about the old faithful employes who have given long and continued service in the navy yard? Some provision should be made in such cases, either pension them or give them such light work as they can perform, which all old employes of the navy yard would prefer, but the present policy of dumping them on the scrap heap is cruel in the extreme, and in direct contradiction to the human principles of the American government.

September 23rd, was notified by Brother Phillips of Lodge No. 57, that a tank was about to be erected for the Consumer's Brewing Company at Norfolk, Va. While

the writer was at Wilmington, Del., Brother Philips, also Brother Halstead, visited the job to secure the work for the members of the International, and was given to understand that the job would be done under fair conditions and by members of the International. On September 25th I had a conference with the president of the company, who also assured me that bids would be submitted to fair shops only.

September 27th, visited Newport News, Va., to look over the situation in the ship yard. Met Brother Healey, president of Lodge No. 55, also Brother Arthur, corresponding secretary, who gave me all necessary information, as it was several months since I had been there and of course lost track of conditions only through communications received. While there had a meeting with the general manager relative to a member of Lodge No. 55 who came out on strike October 13, 1913, but for some reason was not returned to work according to terms of settlement between the management and a committee representing Lodge No. 55, but was assured the brother's case would be investigated at once, and put to work. While in Newport News I secured the necessary data to present to wage board for a special rate at the Norfolk navy yard in the boiler department, and turned same over to Brother Howe of Lodge No. 298.

September 30th, attended a meeting of the chippers and caulkers employed at the Norfolk navy yards. Brother Philips of Lodge No. 57 was also present to encourage the organization of them. Another meeting will be held later on and have hopes that an organization will be perfected, not only among the chippers and caulkers, but also the riveters who need organization bad, as the conditions in the hull department call for prompt action all around on the part of the caulkers, riveters and drillers; also attended a meeting same night, September 30th, of the riggers, by request of Brother Wilson, local organizer of the A. F. of L. at the C. L. U. hall, Portsmouth, Va. Brother Wilson initiated the members, and installed the officers of the first riggers' local at Portsmouth, Va., with every prospect of a large increase in membership later on. Brother Wilson, the local organizer, also Brother Philips of Lodge No. 57, made a lengthy address on the benefits of the labor movement as well as the duties of the officers and members in order that the riggers employed at the Norfolk navy yard as well as in the vicinity, would be in a position through the co-operation of the organized labor movement to better their conditions. Like all other crafts who have done so through organized affiliation with these respective internationals, may the great work of the organized labor movement go on and on to success, for its mission is a noble and humane one, the emancipation of the wage earners of America, moreover the results that has been accomplished in the past for the betterment of the toilers stand as a living monument to the unselfish devotions and

self-denials in the cause of men and women in the great battle for human rights.

The year of 1915 has been a successful one for the labor movement when we take into consideration the industrial depression labor has been up against, which gives promise of final success in the future, for all of us realize that never in our history has organized labor been fought so hard by organized capital to disrupt it, but failed as the many bitter lessons of the past has, and is bringing labor closer together for the labor movement and its efforts for human liberty depends the peace, prosperity and power of the republic.

Hoping this is satisfactory to the officers and members of the B. I. S. & H. of America.

Yours fraternally,
THOS. NOLAN, 2nd V. P.

REPORT OF EIGHTH INTERNATIONAL VICE-PRESIDENT JOS. P. RYAN.

From September 14 to October 15, 1915, inclusive.

At the conclusion of my last report I was in New Orleans, La., assisting Lodges No. 37, No. 206 and No. 442 with their strike at the New Orleans Boiler Works, Johnson Iron Works and Dusell Iron Works. On September 18, myself and a committee were preparing a written proposition for a settlement of the trouble, which we had agreed to present to Mr. John H. Murphy, president of the N. O. Metal Trades Association. On that date I received a wire from First International Vice-President Hinzman, from Memphis, Tenn., stating that he would arrive in New Orleans, September 19, enroute to Beaumont, Tex. I decided to await his arrival, and committee and myself met Brother Hinzman, Sunday, September 19, upon his arrival. We extended him an invitation to remain over a few days and assist us in negotiating a settlement. He agreed and we proceeded to make arrangements for a meeting with the officers of the Benevolent Association. A committee was appointed to meet a committee of the Benevolent Association. Brothers Andrew McGowan, Charles F. Kenney, James Ensault, Hinzman and myself met with a committee from the Benevolent Association on Wednesday evening, September 22, at the Monteleone Hotel. At this meeting it was agreed to try and secure a settlement with the shop owners and then bring about amalgamation of the Benevolent Association with the International Brotherhood.

Thursday, September 23, we secured a meeting with President John H. Murphy and Secretary Henry Stearns of the N. O. Metal Trades Association. Mr. James Reed of the Benevolent Association, Brother Hinzman and myself discussed the strike situation over with Messrs. Murphy and Sears and proposed to them a settlement of the strike, providing all men would be returned to work and the agreement restored. A change in the article governing the settlement of griev-

ances, also termination clause, was suggested by our committee and agreed upon. Messrs. Murphy and Stearns agreed to call a meeting of the N. O. Metal Trades Association and place our proposition before them for their approval. I requested that Brother Hinzman, Mr. Reed and myself be permitted to appear before the Metal Trades Association to personally place our proposition before them. This was agreed on.

On Friday, September 24, Brother Hinzman, Mr. Reed of the Benevolent Association and myself appeared at the meeting of the N. O. M. T. Association and personally placed our proposition before them, also asking that they give us a written reply, signed by President John H. Murphy, president of their association.

After so doing we retired to await their action on our proposition for settlement of the strike. We met with the members on strike, Saturday afternoon, but did not receive a reply from the N. O. M. T. Association until after the meeting adjourned. Late Saturday evening we received a reply, stating that our proposition had been accepted. We held a special meeting Sunday morning, September 26, read the letter from the Metal Trades Association and a vote was taken to declare the strike off and return to work. The result of the vote: A roll call vote stood 17 in favor and 2 against. The secretary was instructed to so notify Mr. Stearns, secretary of the N. O. M. T. Association, that the strike was officially over.

Brother Hinzman and myself, having an appointment to attend the meeting of the Benevolent Association, left our meeting to attend same. Arriving late, we found 18 of their members present. Mr. Reed called the meeting to order and Brother Hinzman and myself both spoke to the men on amalgamation. Owing to the small attendance, it was agreed that I remain over another week in New Orleans and attend the following meeting of the Benevolent Association. Brother Hinzman having business at Beaumont, Tex., in connection with Lodge No. 587, he left for that city, September 27, 1915.

At this time I wish to state that Brother Hinzman and myself attended a joint picnic given by Lodges No. 37 and No. 206 on Saturday evening, September 25, and it was all that could be asked for in the way of a success. The crowd attending entered into the spirit of the occasion and all had a rousing good time. As a token of their esteem, Lodges No. 37 and No. 206 presented Brother Hinzman and myself with a beautiful badge. I have many remembrances from various parts of the country, but the badge from New Orleans takes first place in my collection, and I shall always recall with pleasure the 25th of September, 1915, at New Orleans, La.

From September 27 to Sunday, October 3, I remained in New Orleans, in connection with the affairs of Lodge No. 37. The officers of the lodges, including the trustees and myself, had a meeting arranged for

Wednesday, September 29, when the city was visited by a tropical hurricane which demoralized business and left the famous Crescent City in a mass of wreckage. Railroads, street car lines and river traffic were at a standstill and the storm left a streak of wreckage in its wake. I am pleased to state that our members were fortunate. As a result of the storm, our members have been employed as fast as they could report for work, and several crews were shipped out of the city for repair jobs. All of the shops became suddenly brisk with work after the storm, and we were tasked to the limit, furnishing same.

Sunday, October 3, I attended another meeting of the Benevolent Association. I again took up the question of amalgamation. Owing to the effects of the storm and small attendance, no definite action was taken. I agreed to resume negotiations later.

As the council meeting was to convene, I left New Orleans for headquarters. Enroute, I stopped at Beaumont and paid a short visit to the Magnolia Refinery, where a large job is in course of erection.

After a short visit with our members at Beaumont and Business Agent T. O. Riley of Port Arthur, Tex., I left for Fort Worth, arriving there Thursday, October 7. I met with Secretary Freeman and left that night for Cushing, Okla., arriving at Cushing, Friday, October 8, 1915.

On my arrival at Cushing, I went to the First National Bank and secured the remainder of the canceled strike pay checks, issued during the oil fields' strike, and closed up the account. I am pleased to report that we had a balance of \$441 on deposit. I had the cashier issue a bank draft for that amount in favor of our International Secretary-Treasurer, Brother F. P. Reine-meyer, and after finishing my business at Cushing, I left for headquarters, arriving late Friday night, October 8, 1915.

Upon my arrival at headquarters, I made a brief report to the executive council, in session, and turned over to Brother Reine-meyer the bank draft for \$441, taking his receipt for same. This was in compliance with President Franklin's instructions, and this refund reverts back to the strike benefit fund. The refund of this amount, \$441, gives Lodge No. 592 of Tulsa, Okla., a total of \$33,747 in strike benefits paid, instead of \$34,188, as shown in my former report in September issue of the Journal.

I am advised that field work is on the gain, as there is a large job under way at the Healdton, Okla., field. While there are some open jobs, I would advise our traveling brothers who are going into the oil fields to have your dues book stamped up to date and a clearance card with you.

Since October 8 and up to October 15, my time has been taken up at headquarters, attending the meeting of the Executive Council. I expect to again return to my work in the South, unless otherwise ordered by the International President in a very short

time. Trusting my report will prove interesting to the rank and file, I remain, with best wishes,

Fraternally yours,

JOS. P. RYAN.

Kansas City, Oct. 15, 1915.

**A COMMUNICATION FROM INT. SEC'Y.-
TREAS. REINEMEYER.**

Kansas City, Kas.

To the Officers and Members of Subordinate Lodges, Greetings:

Will the following lodges: 2, 3, 4, 5, 8, 12, 14, 22, 26, 27, 30, 31, 40, 41, 45, 46, 48, 50, 55, 64, 65, 66, 72, 73, 74, 82, 83, 84, 85, 86, 91, 92, 93, 104, 106, 108, 109, 111, 113, 129, 130, 132, 133, 134, 135, 137, 143, 149, 150, 154, 169, 170, 179, 193, 194, 197, 200, 204, 205, 207, 226, 229, 233, 236, 237, 238, 239, 241, 243, 247, 250, 259, 267, 279, 284, 286, 287, 293, 298, 301, 306, 309, 311, 315, 318, 320, 323, 328, 332, 339, 341, 344, 354, 367, 369, 379, 381, 382, 390, 391, 393, 396, 398, 403, 415, 417, 418, 421, 422, 424, 428, 430, 431, 434, 435, 436, 437, 438, 439, 440, 444, 447, 448, 449, 450, 453, 458, 463, 466, 467, 469, 475, 476, 478, 479, 486, 493, 496, 500, 502, 503, 504, 510, 517, 522, 525, 529, 530, 531, 546, 548, 551, 565, 567, 571, 573, 575, 578, 579, 580, 581, 582, 583, 584, 585, 588, 590, 591, 594, 595, 596, 597, 598, 599, 601, 603, 604, kindly make returns for the raffle tickets which were sent to all lodges for the benefit of Brother Barkdale, by either returning the tickets or return the stubs and make remittance for the tickets that were sold, at the earliest date possible, so that the matter can be closed up?

Trusting I may hear from the lodges as above mentioned at their most earliest convenience, with best wishes, I beg to remain

Yours fraternally,

F. P. REINEMEYER, I. S. T.

**REPORT OF INTERNATIONAL DEPUTY
ORGANIZER REED.**

Portland, Ore.

Brothers, Greeting:

At the time of writing my last report for the Journal, I was in Victoria, B. C., and glad to report that we met with a great deal of success in getting new members and re-instating old ones. At a regular meeting of Lodge No. 191, held on June 22, we increased the membership by 21, and I cannot thank Brother Stewart too much for the great assistance rendered to me during my several visits to Victoria. I am glad to take this opportunity of congratulating the members of Lodge No. 191 as a body in the manner in which they are conducting their business, and boosting the organization along, and a continuance of the energy displayed by each and every member cannot fail to

meet with success, in spite of the fact that no less than 27 of the members of this lodge have gone to the British Isles to work on government work, we still have a good membership. Most of the brothers that left Victoria and Vancouver took withdrawal cards, and I have been informed that the Boiler Makers' Society of Great Britain has recognized them, and they are now members of that organization.

A great deal of my time has been spent in and around the city of Portland, where there has been considerable tank work under construction; tanks being erected for the Associated Oil Company and a large plant for the Shell Oil Company; these were absolutely fair jobs, and am glad to report they were completed without any trouble at all. The contractors for the erection were the firm of Gabriel & Reed, who have, I believe, and always will prefer union men on their work. There have also been several smaller jobs in this district and our members have been fairly well employed during the past few months, but at this writing, I am sorry to say, there is very little doing.

I also spent some time in Vancouver, B. C., where there is a very large number of men employed on the construction of a number of submarines for some of the European nations. While this is by no means an absolutely union job, I am glad to say that we have a large number of our members on it, and I personally have had the privilege of sending men to the jobs, and we fully expect to get a large number of new members from this work. Now, brothers, I could write at considerable length concerning this submarine proposition, but I am satisfied if I write just as I would like to; it would not be to the best interest of our cause at this time, however, for the benefit of those interested will state the conditions under which the work is being carried out. The yard is situated at Barnett, some nine miles from the city of Vancouver, and the C. P. R. runs a train to the job, charging 35 cents the round trip. The men are working two eleven-hour shifts, wages being paid from 47 to 50 cents per hour to shipfitters, riveters and caulkers, and from 33 1-3 to 40 cents to drillers and helpers, time and one-half paid after nine hours and double time for Sunday work. During my last visit to Vancouver the Canadian Trades and Labor Congress were in session, and I had the pleasure of attending several sessions, as a guest. Our organizations were represented by Brother R. C. McCutcheon, representing the International, and Brother Pettigrew from Lodge No. 191 and Brother A. Fraser of Lodge No. 194. As I expect Brother McCutcheon will make a report on the convention, it will be unnecessary to take up any space in this direction.

Hoping this meets with the approval of all, and with best wishes, I remain

Yours fraternally,

JOE REED, I. D. O.

Agreements

FEDERATED AGREEMENT BETWEEN THE DELAWARE AND HUDSON COM- PANY AND THE FOLLOWING EMPLOYES:

The International Brotherhood of Blacksmiths and Helpers, The International Brotherhood of Boiler Makers, Iron Ship Builders and their Helpers of America, International Association of Machinists and their Helpers, International Brotherhood of Electrical Workers and Helpers, The Amalgamated Sheet Metal Workers, International Alliance and Helpers, Brotherhood of Railway Carmen of America and their Helpers, Also Pipe Fitters and Helpers, including the Apprentices of all organizations.

Article 1.

Nine hours shall constitute a day's work and in the event of the company running less than nine hours, time and one-half shall be paid for all time worked after shop hours. Ten hours to constitute a day's work in all round houses and car shops and in the event of the company running less than ten hours, time and one-half shall be paid for all time worked after round house and car shop hours.

Article 2.

Time worked Sundays and legal holidays shall be paid for at the rate of time and one-half, and in the event of men being called after shop hours, such work being three hours and twenty minutes or less, will receive five hours pay; and if more than three hours and twenty minutes time and one-half shall be paid. When a legal holiday falls on Sunday the day designated by the state or nation will be observed.

Article 3.

All employes and those dependent on them for support will enjoy the same privileges of free transportation as that granted to other departments.

Article 4.

The company will in no way discriminate against any committee or any one that may be selected from time to time to represent the men.

Article 5.

Should it become necessary to reduce expenses, the working hours shall be first reduced one (1) hour per day. Should further reductions be necessary, the day shall be reduced one (1) day per week. If further reductions are necessary and men are laid off, the last man hired shall be the first laid off. When the force is again increased, men who have been laid off will be given preference for re-employment, if available, within ten (10) days, seniority to govern. No overtime will be worked except when absolutely necessary and will be distributed among the men as far as practicable. Com-

pany agrees not to hire new men while the shops are working short time unless to fill vacancies or emergency cases to balance shops.

Article 6.

If circumstances require that the company must reduce the working hours overtime shall commence at the expiration of the hour designated by the company as the quitting time, local conditions to govern the starting time. All employes covered by this agreement to start at the same time with the exception of round houses and car shops. No lap will pertain where men will be required to start work after 8 a. m. or 8 p. m.

Article 7.

When men are sent out on the road they shall receive all living expenses and to be paid for all time while traveling, shop hours at home stations to govern all conditions. Receipts to be attached to executive vouchers.

Article 8.

No employe shall be dismissed or suspended without good and sufficient cause. If, after investigation, an employe has been found to have been unjustly discharged or suspended, he shall be reinstated and receive his pay for all time lost. All cases to be investigated within five days after discharge or suspension, a stenographic report of the investigation will be taken and the chairman of the Shop Committee will be furnished a copy of same, if requested.

Article 9.

There will be no extension of piece work in any of the shops of this company. This not to include Car Department.

Article 10.

In the event of a workman having a grievance he shall first make an effort on his own part to adjust it with the foreman, failing to do so the shop committee taking it up with the general foreman. If no adjustment is reached between the shop committee and the general foreman, the matter may be referred to the shop superintendent or master mechanic. Failing in this the matter to be referred to a representative of the trade who will take up with the shop superintendent or master mechanic. If no agreement is then reached the matter to be referred to the superintendent of motive power. In case of a disagreement over interpretation of any clause of this agreement, there will be no cessation of work until all negotiations between the highest representatives of both parties shall have failed.

Article 11.

In transferring men from day to night shifts or from night shifts to day shifts,

overtime rates will be paid for the first night or day of the new shift except where transfer is made at the man's own request.

Article 12.

When vacancies occur or new jobs are created the oldest man in point of service shall have preference to such jobs, if proficient. If not the next oldest man in point of service shall have preference for the job, if proficient.

Article 13.

No one covered by this agreement shall be laid off any hours of the regular working hours to equalize time on account of having worked overtime.

Article 14.

Twenty-four (24) hours notice of any change in the working hours shall be posted on the Bulletin Board.

Article 15.

Any employe when laid off on account of reduction of force will be furnished a pass to any point on the system desired, upon application, provided the man asks for the pass at the time of his dismissal.

Article 16.

All men covered by this agreement in the service of the company for a period of thirty (30) days shall be considered competent.

Article 17.

If a mechanic or helper is placed in a higher rated position he shall receive the higher rate of pay, when employed continually for fifteen (15) days or over.

Article 18.

Mechanics and helpers who by long and faithful service in the employ of the company and become unable to handle heavy work to advantage, will be given preference of such light work as they are capable of handling.

SOLOMON FESSOR,
DAVID BOYD,
J. H. TOWNSEND,
EDW. J. HECK,
J. H. EAMES,
C. B. GIRDING,
Committee.

JAMES H. MANNING,
Superintendent of Motive Power.
LOUIS WEYAND,
V.-P., I. B. B. I. S. B. & H. of A.
J. J. McENTEE,
V.-P., I. A. of N.
F. H. KNIGHT,
V.-P., B. R. C. of A.
E. T. DICKINSON,
Pres., D. & H. Federation.
W. J. WILLIAMS,
Sec.-Treas., D. & H. Federation.

Shop Rules to Govern Boiler Makers, Apprentices and Helpers.

Rule 1. All work such as cutting apart, marking off or laying out any work pertaining to steam, air, water or oil tight boilers and tenders, laying out and building up

of any sheet iron gauge No. 16 and upwards, boiler inspecting, testing, flanging, patching, riveting, chipping and calking, taking out and putting in flues, taking out and putting in staybolts, shearing and punching, operating electric and acetylene welding machines, welding tubes, bending of arch tubes and operating pneumatic hammers, in connection with this work, shall be performed by boiler makers and their apprentices.

Above in no way to effect present practice as they have existed for the past year.

Rule 2. When long stroke pneumatic hammers are used there shall be two boiler makers or a boiler maker and an apprentice operate the hammer. When apprentices are required to run pneumatic hammers they shall have at least one year's experience at the trade before being allowed to operate the long stroke hammer.

Rule 3. Ten hours shall constitute a day's work in all round houses and overtime rates shall be paid after bulletin hours.

Rule 4. Tank and truck frame riveting shall be done by boiler makers or apprentices.

Rule 5. All hot work to be done by two boiler makers and a suitable place be provided by the company for hot work men to change their wet garments when the day's or night's work is completed.

Rule 6. When engines are brought to the shop or round house for repairs, grates will be properly cleaned.

Rule 7. Boiler makers sent out on the road to perform work shall be accompanied by an experienced helper.

Rule 8. An apprentice engaging to learn the boiler maker's trade shall be not less than 16 years of age and not more than 40 years. He shall serve a term of four years at shop hours and shall be given an opportunity to learn all branches of the trade and at the expiration of said term he shall receive the minimum rate of pay. He shall not in any case leave the service of the company without just and sufficient cause until his apprenticeship has been served. There shall be one apprentice to each shop and one to every five boiler makers employed thereafter. Fifty per cent of apprentices may be taken from the ranks of helpers. When helper engages as an apprentice his rate of pay shall not be reduced to the rate of boys provided for in this agreement.

Rule 9. Apprentice rates for boys shall be as follows:

First year	13½c
Second year	15c
Third year	19c
Fourth year	24c

Rule 10. This agreement to remain in effect until a new one is signed. If either party desires to change they will give thirty (30) days' notice to the other party.

A MOVEMENT TO BUILD A MONUMENT IN MEMORY OF BROTHER GILTHORPE.

Note: The following resolutions were adopted by Lodge 25 of San Francisco, Calif., and on being placed before our Executive Council by document, was endorsed by that body and at its recent meeting definite plans were adopted for carrying in effect the purpose of the resolutions and a letter of appeal will be issued to the lodges later.—The Editor.

San Francisco, Calif, July 28, 1915.

Jos. A. Franklin, Esq.,
International President.

Dear Sir and Brother:

San Francisco Lodge No. 25, I. B. B. M. & I. S. B. and H. of A., at its last regular meeting, unanimously adopted the following resolution:

"Whereas, In the demise of our Worthy Brother, and our Past International Secretary-Treasurer, 'Wm. J. Gilthrope,' the Trade Union movement, and especially the International Boiler Makers, Iron Ship Builders and Helpers of America, lost one of the ablest and most energetic brothers that was ever known; his integrity and his honesty was above reproach, and he was without fear of contradiction, the Father of this Organization; for through his years of hard toil and self-denial, he laid the Corner Stone of this International, and was always ready to give a helping hand to any brother in need or to any charitable cause; and he gave his life for the uplifting of our members; and

"Whereas, In view of this it would be fitting and just to erect a suitable monument over his last resting place, and do an honor to the memory of one who befriended us all;

Therefore be it Resolved, That San Francisco Lodge No. 25, subscribe the sum of \$10.00 to start a fund, to be known as the Wm. J. Gilthorpe Monument Fund; and be it further resolved;

That we request all the subordinate lodges to contribute whatever amounts that they can to this fund, so that a suitable monument shall be erected to the memory of our Grand Old Veteran; and be it further resolved; that our Executive Council be the custodian of this fund, and they in their judgment, procure the best monument that can be secured for whatever amount that may be realized; and be it further resolved; that this resolution be published in our Official Journal for a period of 90 days, and that all subordinate lodges be notified by circular letter about this proposed monument fund. We remain,

Yours fraternlly,

JOHN J. KANE,
President.

THOS. J. SHERIDAN,
Secretary-Treasurer.

EXECUTIVE COUNCIL'S ACTION.

The resolution from Lodge No. 25 was concurred in by the Executive Council and the date of closing the subscription set for April 1st, 1916. President Franklin, First Vice-President Hinzman, International Secretary-Treasurer Reinemeyer and Editor-Manager Casey were authorized as a committee to take charge of the fund.—Extract from the Executive Council Proceedings.

Correspondence.

Wilkes Barre, Pa.

Dear Sir and Brother:

I wish to inform the brothers of the quiet and unexpected wedding in this city on September 29 of Mrs. Annie Tyson and Brother E. T. Dickenson, both of Carbon-dale, Pa., was an agreeable surprise to their many friends and brothers of both cities.

Brother Dickenson is president of the Delaware & Hudson Federation of shop

Resolved, That we, the members of Lodge 176, extend to our worthy brother's family our heartfelt sympathy and condolence, in their sad hour of bereavement softened by the confiding hope that his spirit has departed to a better and brighter sphere where sorrow is unknown; and be it further

Resolved, That a copy of these resolutions be sent to the bereaved family, and to our official Journal for publication and a

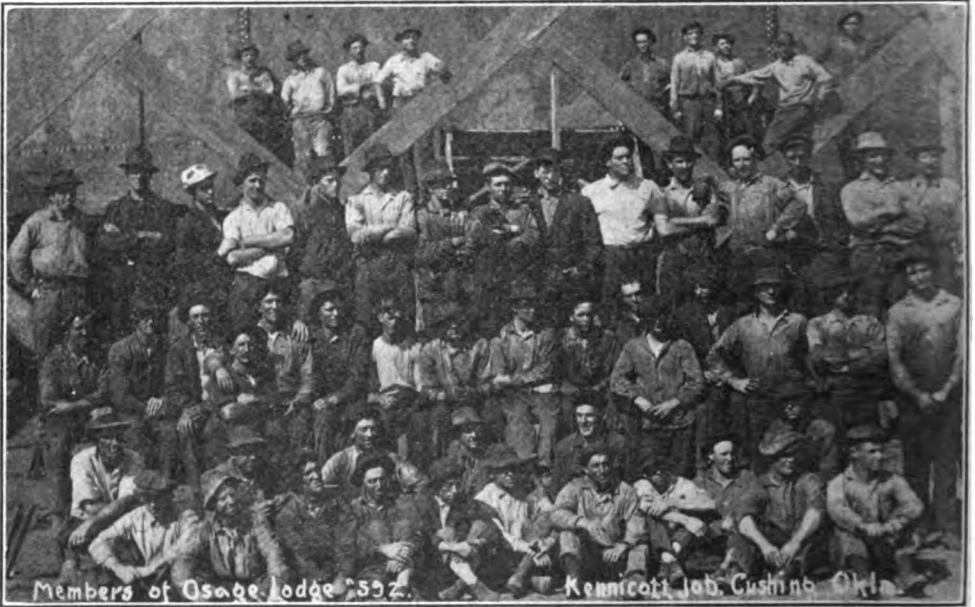

MEMBERS OF LODGE No. 592, EMPLOYED ON THE KENNECUT JOB, CUSHING, OKLA.

trades and also secretary and treasurer of Local 547, and is a great favorite among the brothers who heartily congratulate and wish him luck.

Brother Dickenson remembered the brothers of all trades by giving around good union label cigars.

Again wishing Brother Dickenson and wife good luck, and hoping to see this in the next issue of the Journal, I remain,

Yours fraternally,
THOS. J. CAVAN,
Rep. L. 547.

Elizabeth, N. Y.

Dear Sir and Brother:

At a regular meeting of Lodge 176, the following resolutions were adopted:

Whereas, It has pleased the Almighty God in His infinite wisdom, to remove from our midst our esteemed brother, George Clayton, a charter member of this lodge.

copy be spread on the minutes of our meeting.

Fraternally,
SAMUEL M. RANKIN,
Secretary L. 176.

AS THEY CONFRONT US.

Portsmouth, Va.

The worker, the thinker, the student, the statesman and the capitalist are all forced by pressure of events to consider the labor problem, all are witnesses of the power of combination for good or evil, all may know that systems of industry change by slow evolving processes and that these processes of growth culminate in crisis of mighty import.

The capitalist seeking profit or gain and workers seeking better and easier conditions may work as partners with common interests, or wage unrelenting war for the

mastery that the victory will come to the side of justice and equity, is certain prophecy of history.

The history of the labor movement is the history of civilization, it has manifested itself in all times and under all conditions of life, owing to vast territory and variety of our pursuits and the form of government have tended to lead us to overlook and underestimate the importance of the labor movement and so long as outward evidence of aggregate prosperity are present we are apt to forget or neglect to know the condition of those who contribute to the results.

Past experience has taught us that no relief can be expected from those elected by the polluted channels of party politics to

out organization the American working class would be brutally compelled to compete with each other individually for a bare existence, and they would be so outrageously imposed upon by short sighted, ignorant and avaricious employers, that they would rapidly sink to the same low level and degradations as the Moufiks of Russia, the Fellahs of Egypt and Turkey, the Peons of Mexico, the Pariahs of India and the Coolies of China. No enlightening trade unions exist among those poor creatures. They have an unlimited privilege to work for what and for whom they please as independent workers, make your own comparisons fellow American working men, and then if you draw sensible conclusions hasten to be more active in your organization and place



A GROUP OF THE MEMBERS OF LODGE No. 382, CHILDRESS, TEXAS, LABOR DAY, 1915.. THIS LODGE WAS AWARDED THIRD PRIZE IN THE LABOR DAY PARADE.

positions that should be held by patriotic and enlighten statesmen, or the stilted ignorance of political economy as usually taught in the schools and even the philanthropist is more or less blinded by the glamour and misrepresentations promulgated by concentrated wealth if even relief is had or simple justice secured to the workers it will have to come through the efforts of themselves alone. The labor organization is not an experiment any longer, it is to stay, it has survived one hundred years of terrific opposition and in spite of that it becomes more necessary and popular year by year, it provides protection for rainy day, sickness, accident, old age and death, it brings sunshine in the home, displaces gloom and discontent.

Labor organization is the only salvation for the worker of the present day for with-

it on a higher plane, by doing so you can be a benefit and credit to the course of humanity by organization.

Step by step the longest march can be won. Single stones will form an arch one by one, and by unions what we will can be accomplished, still, drops of water turn a mill singly none, singly none.

H. E. PHELPS,
Lodge 57.

Columbus, Ga.

Dear Sir and Brother:

At the last regular meeting of Kennesaw Lodge No. 436, the following resolutions were adopted:

Whereas, It has pleased the Almighty God to remove from this world of trials and sorrow, our beloved brother, V. D. Randall; therefore, be it

Resolved, That we, his fellow brothers, extend to his family our heartfelt sympathy in this sad hour of bereavement, and be it further

Resolved, That a copy of these resolutions be sent to the family of Brother Randall, a copy sent to the Journal for publication and a copy spread upon the minutes of our meeting.

Fraternally in sympathy,
E. W. McMICHAEL,
J. D. MILFORD,
B. E. DOLAN,
Committee.

Kelley Lake, Minn.

Dear Sir and Brother:

Please publish this in the Boiler Makers' Journal among the poetical selections, if convenient, and oblige.

PEDER M. PETERSON.

"AS YE WOULD."

If I should see
A brother languishing in sore distress,
And I should turn and leave him comfortless,
When I might be
A messenger of hope and happiness—
How could I ask to have what I denied
In my own hour of bitterness supplied?

If I might share
A brother's load along the dusty way,
And I should turn and walk alone that day,
How could I dare,
When in the evening watch I knelt to pray,
To ask for help to bear my pain and loss,
If I heeded not my brother's cross?

If I might sing
A little song to cheer a fainting heart,
And I should seal my lips and sit apart,
When I might bring
A bit of sunshine for life's ache and smart—
How could I hope to have my grief relieved,
If I kept silent when my brother grieved?

And so I know
That day is lost wherein I fail to lend
A helping hand to some wayfaring friend;
But if it show
A burden lightening by the cheer I sent;
Then do I hold the golden hours well spent,
And lay me down to sleep in sweet content.
—Christian Advocate.

Big Springs, Tex.

Dear Sir and Brother:

Whereas, An all wise father has in His infinite wisdom seen fit to remove from our midst Brother J. W. McMahon, we the members of Signal Mt. Lodge 423, do bow to the will of Him who knows best and ask that He comfort and sustain those who are parted from one held most dear to them; we further

Resolve, That in the death of this good brother our lodge is deprived of a most worthy and loyal member and each of us has lost a true friend; be it further

Resolved, That we condole with the bereaved wife and other relations in this hour of sadness; be it further

Resolved, That these resolutions be spread on our minutes and a copy sent to our Journal and the bereaved ones.

H. F. INKMAN,
J. E. WILLIAMS,
T. H. CARDWELL,
Committee.

Carbondale, Pa.

Dear Sir and Brother:

At the last regular meeting of the Int. B. of B. M. & I. S. Builders of America, the following resolutions were adopted:

Whereas, It has pleased the Almighty God in His divine wisdom, to remove from our midst the dearly beloved wife of our esteemed brother, George W. Jones; therefore, be it

Resolved, That we, his fellow brothers, extend our heartfelt sympathy in his hour of bereavement, and may God help him to bear his sorrow and loss.

Hoping to see a copy of this in the next issue of the Journal, I remain,

Yours fraternally,
THOS. J. NEWCOMB, R. S.

Portsmouth, Va.

Dear Sir and Brother:

There is at present considerable dissatisfaction among all the mechanics employed in the government navy yards, owing to the number of ratings which is the cause of more friction than all other working regulations combined, as many of the so-called efficiencyisms has been abolished by an act of Congress, yet an effort has been made to increase the number of ratings, which is not only an injustice to the mechanics but to the navy department as well, as under the system of many ratings men are employed as mechanics who are only first class helpers when employed by outside corporations.

There are only two classes of mechanics, first and second, and perhaps a special skilled class in some trades, such as boiler making, which requires a special skilled boiler maker as flanger and layerout, all others are imposition on the mechanics of the above named classes also the navy department, from the standpoint of economy. As the greatest results are always secured from mechanics of skill and experience on any job, either construction or repair which has been established beyond a reasonable doubt by corporations who are in business for the profit on capital invested. And why the navy department continue such a unbusinesslike policy, practical mechanics cannot understand, as quality and safety first should be the first consideration on the part of the navy department, don't cost more, but on the contrary cost less, which can be proven very easily by any skilled mechanic, if the proper investigation is made by sensible men who will listen to

reason and understand a good thing when they hear it.

"NAVY YARD MECHANIC."

Portsmouth, Va.

Dear Sir and Brother:

Enclosed, please find pictures of part of Labor Day parade that was held in Norfolk.



A SNAP SHOT OF MEMBERS IN LABOR DAY PARADE, NORFOLK, VA., SEPT. 6, 1915.

Our Lodge 298 and Lodge 57 of Portsmouth joined Lodge 428 of Norfolk and we had altogether about eighty boiler makers in line.



FLOAT—LABOR DAY PARADE, NORFOLK, VA., SEPT. 6, 1915.

Enclosed you will find three pictures of our lodge.

One picture is of Brother Balleratine and Brother Nee, who drove rivets. They are standing with their hammers crossed. The second picture is of our float with Brother Doughty and Brother Young in the rear



LABOR DAY COMMITTEE FROM PORTSMOUTH, VA.

seated on gray mules. The third picture is of our committee, naming from left to right: Brothers Cooke, Haywood, Garriss, Howe, Ford, Nee and Pendleton.

Hoping that you may find space in the Journal to publish this, I beg to remain,
Yours fraternally,

ROBT. T. HOWE.

Bay City, Mich.

Dear Sir and Brother:

At the last regular meeting of Bay Lodge No. 67, I. B. of B. M. & H. of America, the following resolutions were adopted:

Whereas, It has pleased the Almighty God in His divine wisdom, to remove from our midst the dearly beloved wife of our worthy and esteemed brother, A. C. Thompson.

Resolved, That we, his fellow brothers, extend to our brother our heartfelt sympathy in this, his hour of bereavement, and pray that the Almighty God may comfort him and console him and that he will bear his sorrow with fortitude; be it further

Resolved, That a copy of these resolutions be spread on the minutes of our meeting and a copy be forwarded to our esteemed brother and a copy be forwarded to our official Journal for publication.

W. H. BENEDICT,
N. HEGLUND,
Committee.

Raleigh, N. C.

Dear Sir and Brother:

At the regular meeting of Lodge 173 the following resolutions were adopted and the secretary was instructed to send a copy to

the editor of the Journal to be published:

Whereas, It has pleased the Almighty God in His divine wisdom, to remove from this life the beloved wife of our worthy and esteemed brother, R. F. Duval; therefore, be it

Resolved, That we, his brothers, extend to Brother Duval, and his family our heartfelt sympathy in this, their sad hour of bereavement, and pray that the Almighty God may comfort and console them that they may bear their trial with Christian patience as she was a loving wife and mother and dearly beloved by all who knew her. She is survived by an infant son.

Resolved, That these resolutions be spread on the minutes of Lodge 173 and that a copy be sent to our bereaved brother and that a copy be sent to the official Journal for publication therein.

R. A. FERRIS,
J. N. DAVIS,
J. P. TAYLOR,
Committee.

Am sending photo of boiler makers and helpers employed at the Standard Oil Company boiler shop.

Trusting this will be of interest to the readers of the Journal and that you will have space for the photo and letter, I remain,

Fraternally yours,
RAY FREEMAN,
Secretary Lodge 596.

Memphis, Tenn.

Dear Sir and Brother:

Lodge 180 held an open meeting to try and get some of our delinquents back with us, and we have had some success. We had our worthy vice-president, Brother Hinzman, and also that hustling business agent of the Frisco, Brother A. F. Bingham. Brothers Hinzman and Bingham made the boys take notice on their talk on organization and the benefits that they would derive from the Brotherhood by building up a good, strong order. Mr. A. R. Hodges, foreman

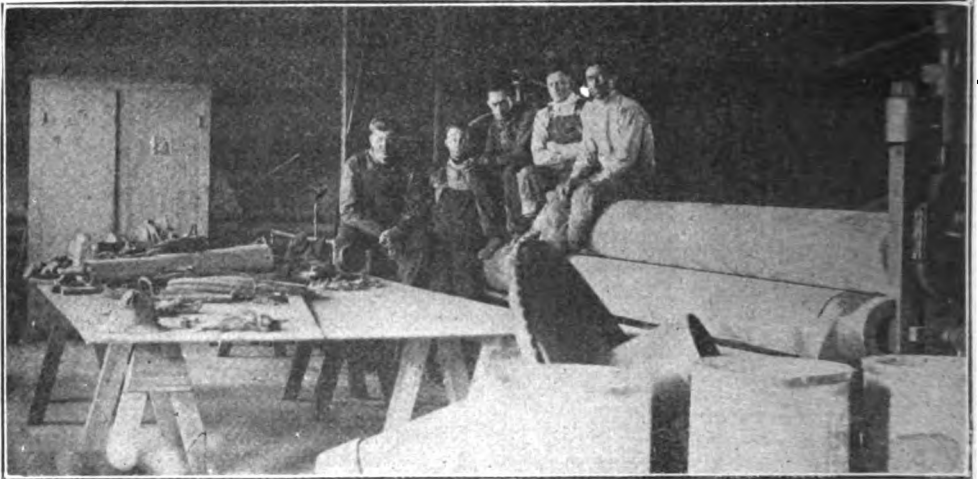

A GROUP OF MEMBERS OF LODGE No. 596, EMPLOYED BY THE STANDARD OIL COMPANY AT CASPER, WYO.

Casper, Wyo.

Dear Sir and Brother:

Just a few lines from Local 596, Casper, Wyo., to let you know we are still in business.

On September 14, Local 596 got an A No. 1 agreement signed by the Wyoming Iron Works, a company recently organized by local men, R. W. McDonald, president; C. E. Starr, vice-president; A. Doornbos, secretary-treasurer. These brothers are a trio of winners and there is no doubt as to their success. They employ about 25 card men at present. This local also has an agreement with the Standard Oil Company, The Hammond Iron Works job at Greybull, Wyo., is held unfair by Local 596. Traveling brothers take notice. More card men here than can be employed.

boiler maker at the Frisco, and Brother Theo. Hoffman, local business agent of the machinists, made some good talks on co-operation.

Well I think that Brothers Hinzman and Bingham enjoyed their visit to Memphis. The committee had an automobile at their service and took them around our beautiful speedway and through the Memphis park system, which is the best in the Southland.

After the meeting all retired to the ante-room and refreshments was served by Brother H. P. Pratt, who had an abundance of soft drinks. That is all that is allowed in Memphis as every one knows that Memphis is dry. Also had some good singing with Brother Murray performing and Broth-

er Lew Haynes accompaniment with the banjo on which he is some expert.

Hoping to see this letter in the Journal at some early date and you will hear from No. 180 again, I remain,

Yours fraternally,

EDW. O'BRIEN,
Secretary Lodge 180.

P. S.—Hope to see Brother Hinzman again in Memphis soon, as all the brothers here got stuck on him.

Philadelphia, Pa.

Dear Sir and Brother:

I am enclosing you a copy of a letter of

Chickasha, Okla.

Dear Sir and Brother:

At a regular meeting of Lodge 323, the following resolutions were adopted:

Whereas, It has pleased the Almighty God in His divine wisdom to remove from our midst the dearly beloved wife of our worthy and esteemed brother, Harry B. White; therefore, be it

Resolved, That we, his fellow brothers, extend to him our heartfelt sympathy in his sad hour of bereavement, and pray that the Almighty God may comfort and console him that he may bear his trial with fortitude; and be it further

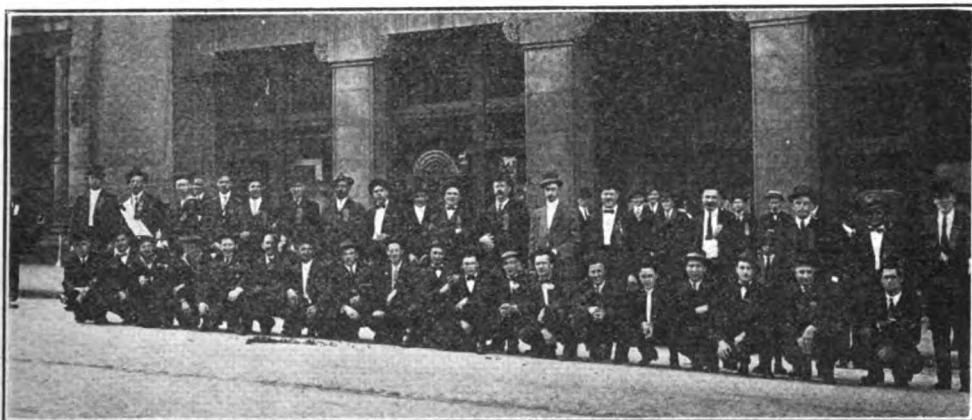

A GROUP OF MEMBERS OF LODGE No. 568, TACOMA, WASH., IN LABOR DAY PARADE, SEPT. 6, 1915.

thanks from Lodge 19 to Vice-President Nolan. I hope you can arrange to have same published in your next issue of the Journal.

Thanking you very much, I am,

Fraternally yours,

ROBT. S. HOPKINS, S. 19.

(Copy.)

Philadelphia, Pa., Oct. 9, 1915.

Mr. Thos. Nolan,

Second International Vice-President.

Dear Sir and Brother:

At a regular stated meeting of Lodge 19, Boiler Makers, Iron Ship Builders and Helpers of America, held last evening, October 8th, 1915, it was unanimously agreed that a vote of thanks be extended to you. We fully appreciate your untiring efforts and the interest manifested in our behalf at the recent conference between Assistant Secretary of Navy, Mr. Roosevelt. Now, Brother Nolan, we want you to accept our heartfelt thanks, as we feel, that it was through your kindly advice and assistance to our committee that made the conference the grand success it was. In conclusion, we all wish you good health, a long and prosperous career.

Fraternally,

ROBT. S. HOPKINS,
Secretary Lodge 19.

Resolved, That our charter be draped for thirty days, a copy of these resolutions be spread on the minutes of our meeting and a copy be forwarded to our bereaved brother, also a copy to our official Journal for publication.

Yours fraternally,

W. L. HARKINS,

Corresponding Secretary Lodge 323.

Memphis, Tenn.

Dear Sir and Brother:

Enclosed you will find some resolutions that we would like to have published in our Journal:

Whereas, It has pleased the Almighty God to remove from her loved ones the mother of Brother August Sullivan.

Resolved, That Local 180, Brotherhood of Boiler Makers, Iron Ship Builders and Helpers of America, do hereby extend our utmost sympathy to Brother Sullivan and family in their bereavement; also a copy of these resolutions be placed on the minutes of this meeting, a copy sent to the Journal for publication, and one sent to the family:

E. C. POORE,

M. O'NEILL,

E. LUFTENBURG,

Committee.

Princeton, W. Va.

Dear Sir and Brother:

The Stewart Studio has informed us that our Labor Day photo has been mailed to you on a recent date.

Labor Day, 1915, was a day long to be remembered by all citizens of this city, and neighboring communities. It was a success in every detail. Every branch of mechanical and transportation departments were well represented by a goodly turnout by the men and by appropriate floats. The parade being fully a mile and a half long.

and out, but during that month Brother Charles Scott, our International Organizer, made his appearance, especially to find out where the trouble was; and, finding it out, I can assure you Brother Scott made one dive to reorganize the members of No. 515, of which he accomplished 75 per cent before he left us, and since then the committees of each roundhouse and shops have worked hard to make a success of a hundred per cent, of which we have accomplished both in boiler making and helpers; and I would say further that Brother Charles Scott ac-

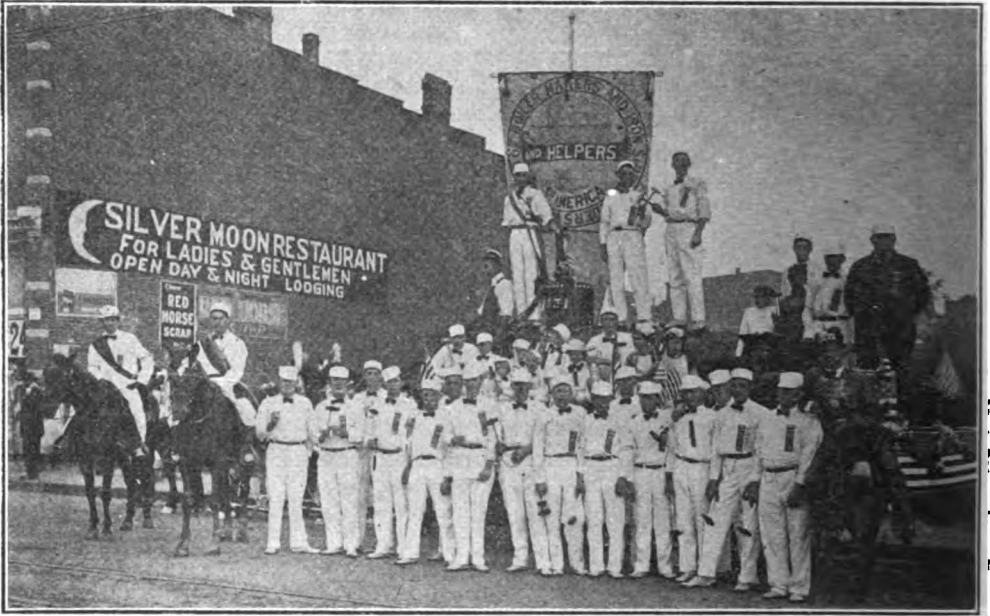

A GROUP OF MEMBERS OF LODGE No. 551, PRINCETON, W. VA., LABOR DAY, 1915.

Old Glory led the way with our federation banner following. We think the photo well shows the type of the boiler makers and helpers that go to make 551 a hustling and clean local; a star in our International association.

The afternoon was spent in an admirable field meet, climaxed by our second federation ball, one of the best our town has ever had.

You will confer a favor on Local 551 by printing this photo in the next issue of the Journal.

Thanking you in advance, I beg to remain,

Yours fraternally,

A. A. WILLIAMS,
Member of Local 551.

Boston, Mass.

Dear Sir and Brother:

Lodge No. 515 would like space enough for a few words in the Journal. Some few months ago, as far back as the month of April, Lodge No. 515 was pretty well down

complished a great many more things in Boston and its suburbs besides Lodge No. 515, and also giving Brother Scott the name of being the busiest brother than ever entered the city of Boston, of which we have titled him "Busy Scott," and I will say that one of our past presidents, Brother Johnson, has been attending the meeting regularly, which has also helped to make Lodge No. 515 a success and can surely say that at the present time No. 515 was never equaled in the history of Boston, hoping it will always continue as it is at present and I can tell you our newly appointed financial secretary, Brother John Grant, has had an awful pile of work to do transferring the names from the old books to the new ones and also the making out of new cards, hoping it will be much easier for him the coming year and going as far back as Labor Day myself and a few more members of Lodge No. 515 helped to make the parade in Lowell, for Lodge No. 371 a success, which was accomplished, and to make the parade look better. We had Brother J.

Franklin, our International President, and Brother Charles Scott, our International Organizer.

Thanking you, one and all, I am
Yours fraternally,
GEORGE PARKES, President.

Portsmouth, Va.

Dear Sir and Brother:

The labor and industrial organizations of Norfolk, Va., celebrated the morning part of Labor Day with a great street pageant, one of the best that has ever been staged in this part of the country, the line of march being fourteen squares long. There was another feature of this event and was



A GROUP OF MEMBERS OF LODGE No. 57, PORTSMOUTH, VA., LABOR DAY, 1915.

that of awarding prizes to the different participants, one for the best float, another for the best uniformed men, another for the largest percentage of men in line, but I am sorry to say that no labor organization received the first prize. Lodge 57 and Lodge 298 of Portsmouth participated as the guests of No. 428 of Norfolk; No. 428's men were uniformed and had a large return tubular boiler on a wagon, drawn by four horses.

Lodge 298 was uniformed with a boiler and a gang of riveters driving rivets and following up in the rear were two white mules representing two boiler makers whom had passed to the other world. No. 57's float had a small battleship mounted on a float with a member dressed up in Uncle Sam's uniform.

If you can find space for write-up in the Journal the members of No. 57 will appreciate the same. Enclosed find cut of the boys after the parade.

Thanking you for your past favors, I remain,

Yours fraternally,
H. E. PHELPS,
Chairman Arrangements Committee.

Little Rock, Ark.

Dear Sir and Brother:

Enclosed you will find announcement of Brother John Mitchell, president of Lodge 69, for representative of Pulaski County, in the Legislature, taken from the Labor Bulletin of Little Rock.

Organized labor has always found Brother Mitchell a staunch union man, a man that's always ready to support any move that will help the cause. Brother Mitchell has been indorsed by the Typographical Union No. 92, Boiler Makers No. 66 and No. 69, Central Labor Council and Arkansas State Federation of Labor, of which Brother Mitchell is first vice-president, Rock Island Local Federation, Carmen No. 424, and from all indications will be indorsed by several more this month.

Organized labor has several candidates in the field for officers this election and we firmly believe we will be able to put them over, and if ever a state needed good, sound legislation for the laboring man this is one. We find one great fault of a move of this kind that is lots of our members fail to pay their poll tax and when election comes we lose lots of votes. Another is they are always too ready to listen to the knocker, bringing in religious questions. I don't care what a man may be if he has been tried and found true to his obligations as a union man, we should vote for him and give him all the support we possibly can. Our members ought to get busy on the political question. We need men in our state bodies and Washington, D. C. There is no reason on earth why we should not, if we only get together.

Hoping this will be satisfactory, will close with best wishes to the Brotherhood.

Fraternally,
W. A. ROOKSBERY,
Secretary Lodge 69.

Printers Indorse Brother Mitchell's Candidacy.

Resolution No. 2, taken from the minutes of a recent meeting of the above organization:

Whereas, The Little Rock Central Trades and Labor Council has indorsed the candidacy of John Mitchell, first vice-president of the State Federation of Labor for the nomination for representative from Pulaski County, in the Democratic primary; and

Whereas, Mr. Mitchell's name has been placed upon the ticket, and he has decided to make the race; and

Whereas, We have confidence in his ability and faith in his unionism; therefore, be it

Resolved, That the Little Rock Typographical Union go on record as indorsing his candidacy, and urge our members and

all members of organized labor to vote for and support him in every way possible; be it further

Resolved, That a copy of these resolutions be spread upon the minutes of this body and a copy furnished the newspapers for publication.

Introduced by G. B. McCarty, E. G. Shoffner and J. H. Beerstecher, delegates to Central Trades and Labor Council.

(Signed) J. H. BEERSTECHEER,
President Typographical Union No. 92.

Attest:

HY. T. SMITH,
Recording Secretary.

There being no further business union adjourned till the first Sunday in November.

To the Committees Representing the Former Employees of the Arizona Copper Company, Ltd., Detroit Copper Mining Company of Arizona, Shannon Copper Company—Gentlemen:

In answer to your representations we beg to call your attention to the fact that these companies have seen their properties closed down and their operations tied up completely by a strike called by the Western Federation of Miners and this without any presentation of grievances. Our former employes have been persuaded by agitators of the Western Federation of Miners coming from outside of this district that the past pleasant relations and the present rate of wages should be radically changed.



A GROUP OF MEMBERS AND THEIR FAMILIES, LODGE No. 105, CINCINNATI, OHIO AT THEIR ANNUAL PICNIC, JULY 24, 1915.

Decatur, Ill.

Dear Sir and Brother:

Please give No. 447 space enough in the Journal for the following:

This is to inform our members at large that the watch that Lodge No. 447 raffled off for the benefit of Brother John Gray, Reg. No. 93500, to purchase an artificial limb, was drawn by Fred Kirk, a pipe-fitter employed by the Wabash R. R. at Decatur, Ill. This lodge also takes this means of thanking the Brotherhood for purchasing tickets and making it possible for No. 447 to purchase this artificial limb for Brother Gray.

CHAS. J. YOUNGER, S. L. 447.

Clifton, Ariz.

The following is a copy of a circular issued by the Arizona Copper Company and allied copper companies of Arizona and published on request of Lodge 593. A communication from that lodge follows after circular.—The Editor.

In view of these facts and notwithstanding that the companies are convinced that a large number of their old employes desire to continue to work under the conditions formerly existing in this district, they realize that any attempt to recommence under such conditions would be to invite violence and intimidation. Therefore, the management of the Arizona Copper Company, Ltd., Detroit Copper Mining Company and Shannon Copper Company desire to notify the committees and the people of the Clifton-Morenci Metcalf district that their mines and plant will remain idle indefinitely.

When it shall appear that conditions in this section warrant it and the companies are satisfied that the general sentiment of the community and their former employes is unanimously in favor of a resumption of operations on the basis of wages and conditions that have prevailed heretofore in this district, the companies reserve to themselves the right to decide whether or not they will again start up their plants.

Our attitude in the matter is based solely on the dominant influence of the Western Federation of Miners in this district at the present time, and when this influence is dissipated we may take a different view of the situation.

THE ARIZONA COPPER CO., LTD.,
By Norman Carmichael,
General Manager.

THE DETROIT COPPER CO. OF ARIZ.,
By M. H. McLean,
General Manager.

SHANNON COPPER CO.,
By J. W. Bennie,
General Manager.

Clifton, Ariz.

Dear Sir and Brother:

Yours of September 29th at hand, and will say that I forwarded you a letter yesterday, but did not go into detail as to what caused the trouble here, but will do so at

32½ cents as copper went up in price, but to make things worse the rates were on a basis of 13 cent copper and if copper went lower than that we did not know what they might do. Objections were raised and conferences asked for, but the reply was that any man who had a grievance would be received, but no committees would be received. Several men placed their grievances and were discharged. More meetings were held and the situation was talked over. There were many union men here but no locals, so it was decided to organize the camp in the district. Everything went along nicely as long as we did not go outside of the mechanical crafts, but the fun started when the Western Federation of Miners came into the district. As we had agreed to all stand together, we gave them our support in getting organized, but the companies fought the movement from the start and went so far as to hire men from all

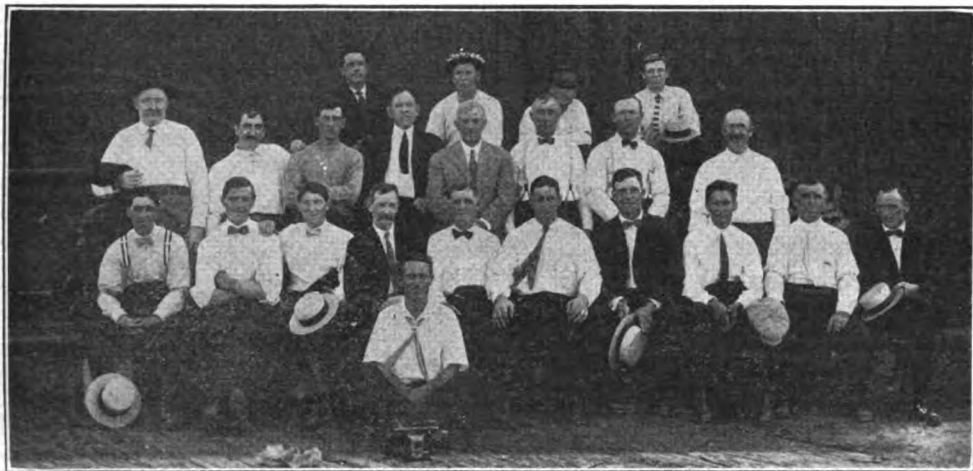

MEMBERS OF LODGE No. 204, HONOLULU, H. I., LABOR DAY, SEPT. 6, 1915.

this time. To start with will say that wage conditions here for years have been from ten to fifty per cent below the standard paid in other parts of this country. In August, 1914, the company made a cut of 10 per cent with the understanding that same would be restored as soon as conditions would permit. About February 1 of this year things were looking better and meetings were held by the employees of the different companies of the district to get the managers to restore the 10 per cent. Before the men could call for a conference the managers put into effect a sliding scale that was the most unfair proposition that was ever written. Men who had been getting 50 cents per hour before the cut were raised at this time to 49½ cents per hour, others were cut still lower to 40 and 44 cents per hour. Men who had been getting 28 and 30 cents before the cut were put down to 22½ to 25 cents and put on a scale where they might be raised to 30 and

over Arizona to come here and speak against organized labor, but this had little or no effect. They told men that if they joined the union they would be discharged and at that 95 per cent of the workers of this district are now members of some labor organization, but they were not contented with that. They also went through the mines, mills and smelters with lists asking men to sign them in case that a strike was called, the men would keep on working. To make this effective they also had a time check at hand, and if they refused to sign they were given their time. This we could not stand and a conference was asked for with the different managers, two of them answered but denied a conference. The others did not even extend the courtesy to answer our letter for some days. This brings us up to September 9, 1915, when meetings of all the different mines, when the strike vote was taken and all men came out on September 10 and 11 and not a wheel has been

turned to this time. The rest will be strike history of which I will write you later, as things are now, I am of the opinion that a new kind of history will be written of this industrial war, but I cannot make these things public at this time and would like if this could be in our next Journal.

Hoping this will be satisfactory, I beg to remain,

Faternally yours,
H. HALTER,
F. and C. S. Lodge 593.

Oswatomie, Kas.

At a regular meeting of Crown Bar Lodge No. 82, the following resolutions were adopted:

Whereas, It has pleased Almighty God to take from our midst our beloved brother, A. A. Miller; therefore be it

Resolved, That the bereaved family have lost a loving husband and father, and we have lost a true and worthy member of our organization; be it further

Resolved, That our heartfelt sympathy be extended to the family and relatives of our departed brother and that a copy of this be sent to the sorrowful family, a copy be spread on the minutes of our lodge and a copy sent to our official Journal for publication.

M. P. CHURCHILL,
A. G. EVERETT,
HARRY SHANNON.

Newcastle, Pa.

Dear Sir and Brother:

I am enclosing picture of the B. & O. bunch, boiler makers and machinists, taken in the midst of their good time at Dewey



A GROUP OF THE BOILER MAKERS AND MACHINISTS EMPLOYED BY THE B. & O. R. R. AT NEW CASTLE, PA.

Park, Saturday, September 18. Refreshments, ball games and other athletic events were the order of the day. I am sorry to say the boiler makers lost the game by a narrow margin through a costly error by one W. J. Southern, better known as "Jaggers," who was the crowning feature of the game up until he refused to get up and chase a long fly hammered out by one of

his opponents which resulted in a home run and the winning of the day for the machinists. It also must be handed to M. B.



ANOTHER VIEW OF THE B. & O. BOILER MAKERS AND MACHINISTS, ON THEIR RECENT OUTING.

Cunningham, better known as "Mark," the "Million Dollar Kid." He was on the mound for the machinists and twirled a game that will go down in history. This is their first



PHOTO OF BRO. W. J. SOUTHERN (on left), KNOWN TO HIS FRIENDS AS JAGGERS.

gathering of this kind and it was unanimously adopted to make it an annual affair. All departed for their homes at a respectable

hour feeling as free as split silk after their day at Dewey Park.

Hoping that I have not taken too much of your valuable space and also that this item and photo will appear in the Journal at some early date. I will close, with best wishes. I am,

Yours fraternally,
DAVID LEWIS,
 C. F. S., Lodge 493.

brothers. Perhaps after they have done so they will better understand and why and just where their duty to their poor unfortunate brothers lie. Those brothers, whether their own or somebody else's fault are without means to help themselves. True unionism is not only to shout for the right and wrongs of labor, it must lighten, brighten the road of hardship which is oft-times felt and seen. If now and then our



BOILERMAKERS AND THEIR FRIENDS, LODGE No. 204, HONOLULU, H. I., LABOR DAY, SEPT. 6, 1915.

St. Louis, Mo.

Dear Sir and Brother:

In the September number of the Journal on pages 681 and 682, there appeared a letter dated Livingston, Mont., and signed "Fraternally submitted, Lodge 123." Kindly allow me space in your next issue to ask the writer whether he knows the meaning of the word, "fraternal." Judging from his letter I think not. "Fraternal," as Webster's latest improved dictionary gives it means "Pertaining to becoming or like brothers." If this is true then in the name of all that is good, why the necessity of publishing in the Journal a letter such as this? The tone and manner which served no other purpose than to antagonize and stir up discord and criticisms. In the class of men the writer refers to are to be found the noblest and best and if they did occasionally ask the use of his pie card it should be cheerfully given for the man is indeed fortunate who has a steady job. As far as having \$1,000, we, who have read the story, think this is only the writer's imagination, as for being customers, the letter itself will show just how welcome the needy ones are. I would ask the writer to please read the enclosed poem and also the writer of the letter on pages 688 and 689. He, I see on looking through the Journal criticises our traveling

Western brothers meet an undeserving one I would impress on them the fact that to err is human, to forgive and help divine. In every heart there is some good and even though his pockets be lined with \$100 bills which he perhaps does not or could not get change for, just accept him as a guest for believe me the greater majority of those brothers make good at some time. Who knows you might be in the same fix and they never forget a kindness or an insult. Better be a little generous with that pie card. Don't eliminate it as it is surely hard to hear that a prosperous brother refuses to help another for whom the sun of prosperity has not shone so brightly. Get in the class of cheerful givers, who give not because they have to, but because they like to.

The Others.

How did you meet him, brother,
 He of the sad slow pace?
 What did you for the others,
 Who lost in life's fitful race?

He was a boiler maker,
 His card was up-to-date.
 When good jobs were a giving
 He simply came too late.

Ask not of him the reason,
As he enters the shop at morn,
No matter what's the reason,
Give him a welcome warm.

Place in his hand a ticket
Tell him across the way
Over to old Dad Wickets'
There he can eat and stay.

Stay there, friend, till you are rested,
Look around a bit,
I can offer you no sure thing,
Yet a job you may hit.

He tells you in the evening
He has heard in town today
Over the border
Boiler makers get good pay.

Scarce are they and always wanted,
For this job then he will try.
Now he tells you on the morrow,
He to you must say good-bye.

When you shake his hand at parting,
Call him then aside;
Tell him with old Billy Wharton,
You for him have got a ride.

He is gone, the one befriended
Him you never met before.
You perhaps may never meet
This side of the Eternal shore.

Your good deed is recorded,
By the angels up above,
Where all good deeds are rewarded
In the Father's home of love.

When you both have crossed the river,
Gone beyond the Great Divide.
He who loves the cheerful giver,
Will give you a grand reward.

Help them then, our needy brothers,
Gently on their onward way,
Kindly cheer the weary others,
Then the Lord will say:

Welcome to thee, boiler maker,
Well on earth my work thou did'st.
Come right in, good faithful servant,
Thou are welcome to our midst.

JAS. CALLAHAN,
C. S., Lodge 27.

Wilkes Barre, Pa.

Dear Sir and Brother:

While reading September Journal of B. R. C., I came across an article requesting the brothers of organized labor to purchase union-made collars so as to keep the only union labor collar company supplied with work.

Now, brothers of organized labor, this is a shame that the only union label collar company in the United States should have to appeal to the different unions for aid. If

all unions now would only do their duty, this company would work day and night.

Now, brothers, make it a point when purchasing your next collars to see that the union label is on them; do not let the merchant put you off by saying these collars do not have the label on, but are just as good, for they are not. Hoping that all brothers of organized labor will do their duty of purchasing union label collars and helping to keep this one union firm running day and night.

It is your duty not only to purchase union made collars, but everything you wear should have the union label on them.

Hoping you are all doing your duty by purchasing nothing that has not the union label on it, I remain, yours always looking for the union label,

Fraternally,
T. J. CAVAN.

Seattle, Wash.

Dear Sir and Brother:

Inclosed find resolutions and affidavit for publication in our official Journal. Resolution is self-explanatory. Affidavit is to refute report of Inspector Larmer and reason of resolution. Inspector Larmer made the following report to Captain of Navy Yard Bremerton:

"After investigating trouble on tanks, I find the men employed were labor union men; they demanded that their members only be employed. This, Mr. England refused to do; they quit work and their places were taken by other men; wages paid were good, \$2.50 and \$3.50 per day." (Mr. England is foreman for Des Moines Bridge & Iron Company.)

This statement is absolutely false and misleading; if there was an investigation (which I doubt very much), why were some of the men that worked on the job, or I, not asked to state our side of the case?

The men employed were not union men, at least not all of them. The day we pulled out, four of them were non-union men, but they came out and stayed with the union men. As to wages being \$2.50 and \$3.50, that also is false; some men were paid as low as \$7 a week, and the highest wage was \$3.20.

At no time did we ever ask them to employ union men only. All we asked was that the prevailing rate of wages be paid, which is boiler makers and ship builders, 50 cents per hour, or \$4 a day; helpers, 37½ cents per hour, or \$3 a day, on such class of work around Seattle and vicinity.

Mr. England absolutely refused to pay our scale of wages. He informed Brother Atkinson and myself that it he "could get men to work for \$1.50 a day that would be all that he would pay them, and these hard times they should be glad to take that amount. It was better than to starve.

If the inclosed resolution meets with the approval of our lodges throughout the country, I sincerely hope they will write their

Senators and Congressmen, urging them to pass laws compelling contractors to pay the prevailing wages in that territory where work is being done, or, better still, a minimum wage.

With sincere good wishes and kindest regards, I remain

Yours fraternally,
DAN P. McKILLOP,
S. & B. A. L. 104.

Text of Resolutions.

Following is the text of the resolutions:

"Whereas, It always has been, and still is, the policy of the American Federation of Labor to uphold and elevate the high American standard of living; and

Whereas, A great many American government officials are aiding and abetting unscrupulous and un-American contractors and employers of labor to lower the American standard of living; and

"Whereas, Many government officials are giving preference in employment to irresponsible foreigners, while good, loyal American citizens are starving; and

Whereas, The American Congress has refused to vote funds with which to allow anything like adequate immigration protection, notwithstanding the fact that surplus millions of dollars have been collected from this source; and

Chairman Edes Quoted.

"Whereas, Chairman W. C. Edes of the Alaska Railroad Commission, recently in a newspaper interview stated that the Commission is successfully evading the government eight-hour law in building the Alaska railroad by letting the work out to foreign station men; and

"Whereas, An official of the Puget Sound Navy Yard, located at Bremerton, Wash., recently informed a member of this council that it was his right and his privilege to employ Japanese or any other foreigner he chose on government work in preference to American citizens; and

"Whereas It is well within the range of possibility that the United States government may call upon us to defend the flag against the very foreigners who are taking our living away from us; now, therefore, be it

"Resolved, That we, the delegates to the Metal Trades Council of Seattle and Vicinity, as citizens of the United States of America, protest most vehemently against the continuation of such a policy on the part of our government in giving contracts to outside firms who do business below the American standard; and further, be it

"Resolved, That we condemn the language of the navy yard official as detrimental to the best interests of this country, which would, should it follow out his suggestion, invite the inspection and spying of our government establishments by the Japanese, who some day we may have to face in war; and further, be it

Effect in Case of War.

"Resolved, That in the event of international complications, our response to a call to the government service will depend wholly on the extent to which such unfair and un-American policies are modified by our government officials; and further, be it

"Resolved, That we hereby demand that American citizens and heads of families be given the preference on all federal public works and that the current standard rate of wages and working conditions be given them for their services; and further, be it

"Resolved, That a copy of this resolution be forwarded to his honor, President Woodrow Wilson, and copies to each member of his cabinet; and further, be it

"Resolved, That we request those men representing us in Congress to see to it that this resolution is read on the floor of both houses of the American Congress; and, also, be it

"Resolved, That copies of this resolution be spread throughout the ranks of organized labor in America through the medium of the labor press."

(Copy.)

Bremerton, Washington,
July 29, 1915.

TO WHOM IT MAY CONCERN:

State of Washington, County of Kitsap, ss.

I, A. R. Larkin, being nineteen years of age, do upon my oath say that I worked twenty-one days, eight hours per day, at fifteen cents per hour, for the Des Moines Bridge & Iron Works, of Des Moines, Iowa; I. B. England, foreman. During the month of April, 1915, that said work was performed, erecting fuel oil tanks for the U. S. Government at Bremerton, Wash., in the U. S. Navy Yards.

(Signed) A. R. LARKIN.

Subscribed in my presence and sworn to before me this the 29th day of July, A. D. 1915.

(Signed) JAMES O. BOYLE,
Notary Public within and for the State of
Washington, residing at Bremerton, Wash.
(Seal.)

Argenta, Ark.

Dear Sir and Brother:

Please publish the following in the next issue of Journal:

Arkansas had her first state-wide Labor Day celebration on the sixth day of September. A celebration that the great state of Arkansas was very much proud; special trains were run into Little Rock to accommodate the union visitors from all points in the state. About twenty thousand visitors were estimated by the press, and parade of thirteen thousand union men of various trades marched the streets. The boiler makers and helpers with their float of quality and members, young and old, uniformed for the occasion, marched for the good cause of labor.

We did not land first prize, although in competition with thirty-seven others we did receive second honors.

Labor Day in Arkansas has proven by this gigantic celebration to be one of the most important national days. Our only hope is that next year it will be larger and better.

I am inclosing picture of our float, and Lodge No. 66 would be glad to have it shown in the next issue of Journal.

I also wish to mention that the added attraction was the show of Carnival Company. The allied trades were interested in this adventure and about one thousand dollars was netted, clear profit, which is to be appropriated for the Labor Temple. The day was a grand success, both from labor's standpoint and financially.

Yours fraternally,

E. WORTSMITH, S. 66.

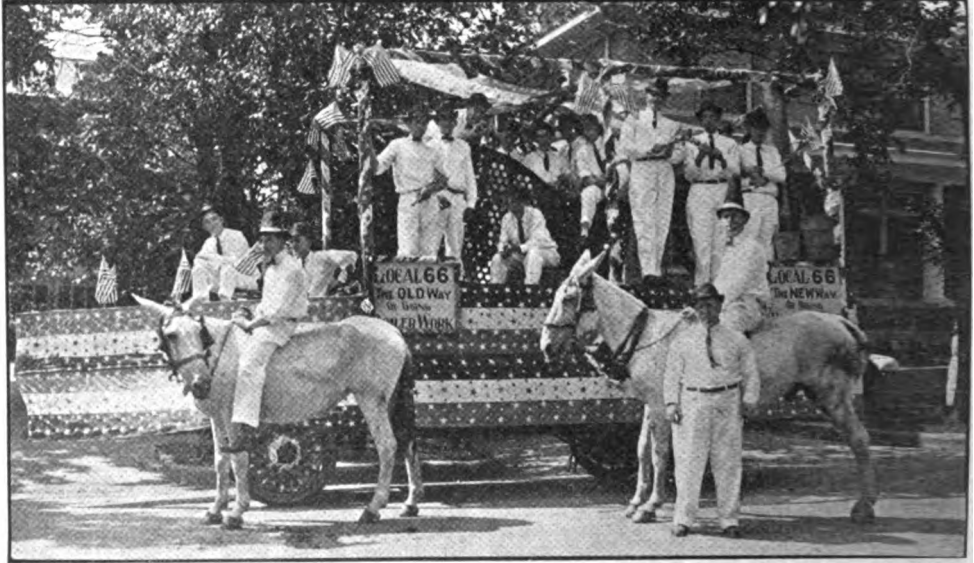

LABOR DAY FLORAL AND GROUP OF MEMBERS OF LODGE NO. 66, LITTLE ROCK, ARK., LABOR DAY, SEPT. 6, 1915.

A Compilation of Labor News.

(By The A. F. of L. News Service.)

WOULD REVISE "PEN" METHODS.

Little Rock, Ark.—A special committee appointed by Governor Hays to investigate the Arkansas penal system has made a report in which is included several important recommendations. It is urged that a reasonable amount of stationery and postage be furnished each prisoner; that bedding be more closely looked after; that more soap and towels be supplied; that bake ovens be built at each convict camp; that the cooking and serving of food be carefully watched; that the supply of home-grown food stuffs be increased and that prisoners be worked no longer than ten hours a day. It was found that but one physician looks after 1,300 men and women at seven camps, and the committee recommends that a complete hospital be maintained at administration headquarters, with emergency hospitals at each camp. Bath houses in each camp of 200 prisoners is favored, and it is urged that stockades or bunk houses erected in the future should be of masonry high enough for three stories of bunks, which should be

made of steel pipe, and all structural parts of stockades should be fire proof and vermin proof.

MUST PAY FOR POLICE.

Fort Wayne, Ind.—City officials have notified the Fort Wayne and Northern Traction Company that if it wants police to protect its property and its employes from "anticipated violence" against striking street car men, it must pay for same. The company requested the city to detail special policemen around its property and on each car during the noon and evening hours.

In a letter signed jointly by the major, chief of police and the board of public safety, the company is notified that:

"The mayor has sought your co-operation to make a final attempt to have your difficulties settled for the benefit of the traveling public who are entitled to adequate street car service as provided in your franchise, for the benefit of business men of our city so that there shall not be a continuation of business depression produced by this

controversy and for the benefit of our taxpayers that they may receive the adequate and normal police protection of which they are now being deprived by using the same mostly for your benefit. But you did not see fit, when it involved the interest and right of our public, to co-operate. You now ask us to assist you by the expenditure of the public's money after you refused to co-operate for the benefit of the public, and we feel that we are not justified in so doing, when the statute provides that in this character of difficulties you should pay the additional police service you request."

RAILROADS ACT TOGETHER.

St. Louis, Mo.—Included in a circular issued by President Perham of the Order of Railroad Telegraphers is a record of recent co-operative agreements between several railroads and the brotherhoods of engineers, firemen, conductors, trainmen and telegraphers.

President Perham says:

"Similar agreements are being arranged on many other railroads.

"Unwritten co-operative agreements have been entered into upon still other railroad systems, all of which shows an increased spirit of fraternalism and an inclination towards mutual helpfulness that is extremely gratifying.

"It is by such means that we expect to arrive at a better understanding with the train and enginemen about handling train orders by telephone, also head off various employers who are trying to institute a plan of annual physical examinations, which may have disastrous results in weeding out representative employes."

EXPLAINS COMPENSATION LAW.

Philadelphia.—In an address on the new state compensation law Prof. Bohlen, of the University of Pennsylvania law school, said predictions regarding the large number of law suits that would result were greatly overestimated. In explaining the law, he said there were three forms of insurance: The state fund, mutual associations and stock companies. The speaker insisted that the state fund will give sufficient protection.

LAWSON RELEASED ON BAIL.

Denver, Colo.—The Colorado state supreme court has admitted John R. Lawson to bail in the sum of \$35,000. Later the court will consider Lawson's appeal for a new trial. Several weeks ago the court issued an order delaying further proceedings in this case until the evidence could be reviewed. At the same time Judge Hillyer was debarred from further consideration of pending cases against other miners.

Lawson has been in jail at Trinidad since he was convicted and sentenced to life imprisonment in Judge Hillyer's court for the alleged killing of John Nimmo, a strike deputy, October 25, 1913.

MEDICS STAND BY WAGE SCALE.

Kokomo, Ind.—The "union" of doctors in this city, known as the Kokomo Medical Association, protests against a lowering of wages by compensation insurance companies. The doctors insist on the right to set their own wage and have passed the following resolution:

"We will not sign nor subscribe to any schedule of fees of any kind or nature whatsoever as has been or may hereafter be prepared by said liability insurance companies."

The doctors further declare:

"Such interference by the said insurance companies would be unbecoming and detrimental to the medical profession and grossly unjust to the public at large to whom the said insurance companies owe no liability."

FAR WESTERN UNIONISTS MEET.

Santa Rosa, Cal.—Organized labor is in favor of the vocational school, but such schools must not be used by industry for exploitation purposes, declared President Haggerty in his report to the state federation of labor convention.

Referring to the commission on industrial relations, Secretary Scharrenberg said:

"If trade-unionism needed vindication it was secured in full and plenty in the reports issued by the commission. And if some of us are inclined to become complacent the big outstanding facts about industrial conditions in our country ought to furnish a rude awakening. It is the first time that an official report has been made to the United States government on the labor question which does not hesitate to present the real remedy for economic evils."

ASSOCIATED PRESS DENIES.

Washington.—Officers of the Associated Press in this city have written a letter to A. F. of L. officials against the inference that the Associated Press is a party to an alleged plan intended to weaken work being done by the federal department of labor, and also the statement that the railroad brotherhoods accept that portion of the Commons' report to the commission on industrial relations which favors a commission to enforce labor laws.

Associated Press officials say they did not send out this story, which was printed in the A. F. of L. Weekly News letter, issue of September 25, but that it was published by newspapers that had received this information in the form of a circular, issued by an information bureau in this city.

UNIONISM THE KEY.

Denver.—"Unionism, living up to its ideal, is the key to the so-called labor question, and, therefore, constantly increasing organization should be the aim of union men," declared James M. Brewster in an address before the state federation of labor convention. The speaker was recently dismissed from the law faculty of the Colorado state university because of his avowed sympathy for the striking coal miners.

DEFENDS TAX ON RICH.

Washington.—The government has filed a brief with the United States supreme court in which the income tax is defended. The government says that "congress has, in its discretion, determined that the heavier burden can be carried more easily by the larger income and it is not for the courts to say that such classification is outrageous."

"The ordinary system of indirect taxation upon consumption places upon the poor person a disproportionate share of the burden of government support," says the brief.

UNION POLICIES CONTRASTED.

Indianapolis.—Writing in the official journal of the Brotherhood of Teamsters, Secretary Solem, of Minneapolis Milk Wagon Drivers' union, contrasts the policy of that organization and a former local in the same calling at St. Paul. Both unions were organized about three years ago. After six months St. Paul demanded wage increases that averaged \$1 a day per member and refused to compromise. In another six months the union disappeared and since then these drivers have suffered a \$5 per month reduction and are now working for \$50 and \$55 per month with no vacation.

The Minneapolis drivers adopted a more cautious plan. By thorough organization they put all employers on the same competitive basis and then began improving working conditions and raising wages. Their present rates are \$75 a month with two weeks' vacation.

SUSPEND SHIP INSPECTORS.

Washington.—George Uhler, supervising inspector general of the United States steamboat inspection service, announces that Robert Reid and Charles S. Eckliffe, the two inspectors who gave the Eastland, Chicago excursion steamboat, her last license, have been suspended pending the outcome of indictments returned against them.

DEATH ON THE RAIL.

Washington.—For the three months ending with June 30, 2,056 persons were killed and 30,336 injured on railroads in this country, according to a statement issued by the interstate commerce commission. As compared with the corresponding quarter of 1914, these figures show a decrease of 166 in the number killed and 4,392 injured.

JUDGE SUPPORTS UNIONISTS.

New York.—Opposition to the New York state constitution, which will be voted on next month, is recorded by former Chief Judge Edgar M. Cullen of the court of errors and appeals, the highest court in this state. Judge Cullen supports the trade union movement in its opposition to some sections of the new constitution and shows that in the present constitution the safety of the civilian population is protected, as it is in the constitution of the United States, by a provision in the bill of rights that "no military tribunal shall exercise jurisdiction over a civilian unless engaged in military or naval service while the regularly constituted state courts are open to administer justice."

This clause is eliminated from the new constitution, which, however, carefully continues all the old powers and provisions for the declaration of martial law in case of riots or disorders which the civil authorities are deemed powerless to curb.

Judge Cullen shows that under the proposed constitution it would not be sufficient excuse for an accused man to show that he had been absent from the scene of rioting if the military powers merely proved that he had "aided and abetted those guilty of violence."

"Under these rules of law," says Judge Cullen, "in case of a riot in Buffalo, a man may be taken from Brooklyn or New York before a military commission on the charge that he has aided the rioters and shot if the commission sees fit to order it."

The claim that the new constitution will provide greater efficiency in the conduct of state affairs is answered by Judge Cullen with the claim that "efficiency may be bought at too great a price, and such is the case when it is purchased at the expense of civil liberty."

TO VOTE ON COMPENSATION.

Philadelphia.—The voters of this state will vote on a constitutional amendment at the coming election which provides for compulsory compensation. The present law, effective January 1, is optional and may be rejected at will by employers if they prefer a lawsuit to paying injured workers.

Among Our Exchanges.

FROM "REVOLUTION" TO INJUNCTION.

In 1905 a great noise was heard in the industrial world—heralding the advent of a new savior of Labor. This savior yearned after big deeds and dreamed great dreams and proclaimed greater reforms. Everything connected with this new idea was "big"—the industrial workers of all lands were to be organized upon a world scale.

"One Big Union" was to encompass all industry—one big union, mighty to do and dare.

But the idea was so big and so vague and so intangible that harnessing it to practical uses was very much akin to trying to use a rainbow for a dyepot. The spokes of the "big wheel" were tangled in the machinery for adjusting industrial relations and be-

came an unmanageable buzzsaw in the evolution of industrial welfare.

The industrial revolutionists scorned simple, methodical policies and proclaimed direct action as the only method. They sang of that glorious free spirit which took that of which it had need—took regardless of let or hindrance. Direct actionists avowed the morals and the methods of primitive, uncomplex life. They gloried in their power and their freedom from conventional regulations or standards.

These things they avowed. What they have done is well illustrated by an incident that recently happened in Boston.

The "Industrial Workers of the World" sought to gather the common laborers under their wing in one big union—the "I. W. W." has always presented as the greatest justification for its existence effective work in organizing the unskilled.

But the unskilled of Boston did not heed the allurements of the one big union—they made evident their preference for the International Hodcarriers and Common Laborers' Union of America, an international that had developed such skill in organization that it secured for unskilled workers wages larger than those received by unorganized skilled workers and some members of professions.

When the I. W. W. found themselves powerless before this local difficulty in Boston, did they take the "short cut," apply direct action and triumph gloriously over great difficulties? Did they give reality to the inspiring ideal of universal brotherhood? Did they center their united forces upon the one objective, each for all, and all for each?

The I. W. W. sought a pettifogging lawyer who consented to take their case for a consideration, and after the manner of D. E. Loewe Company, Hitchman Coal & Coke Company of West Virginia, the Anti-Boycott Association, instituted legal proceedings against Union No. 205 of the International Hodcarriers and Common Laborers on the ground that they constituted an illegal conspiracy and asked a friendly judge to please give them an injunction restraining their fellow-workers of the universal brotherhood!

These industrial workers boasted like industrial Don Quixotes—they proclaimed an industrial spirit akin to that of the chivalrous ideals when knighthood was in flower.

They boasted deeds—they besought the court for an injunction—yes, a real, genuine, dyed in the wool injunction.

They proclaimed themselves the saviors of the workers, were like the mountain of old that travelled in great pain and brought forth a mouse. The injunction was applied for and later denied, and the Boston Laborers' Union is now on its road for better protection and the promotion of the rights and interests of the workers. Now, the I. W. W. will go on howling for another "One Big

Union," then "bust" it and later appeal to the "capitalistic" courts for more injunctions. And there you are!—American Federationist.

SHIP BUILDING.

Sixty sea-going steel ships, aggregating 288,701 gross tons, are now being built in American shipyards. This is the heaviest tonnage ever under construction in this country at one time.

There is no reason to suppose that American shipyards will go out of business when the war closes. If we bring to ship building the same genius and energy we have taken into other lines of business, we can hold our own with any competitors; and the destruction of merchant ships in this war is so great that there will be a good demand for such vessels for a long time to come.—Plumbers', Gas and Steam Fitters' Journal.

THE LOVE OF HEALTH.

If anyone doubts that this is an era of health propaganda he must, indeed, be oblivious of what is going on about him. Municipal, state and national agencies are using forces and funds at their disposal to further the interests of public hygiene. Educational influences are directing their energies to the spread of the lessons of procurable health in public print and in documents of both official and unofficial character. Novels and short stories, the literature of biography and travel, the platform and even the pulpit are proclaiming the gospel of health far and wide. The medical profession, more enthusiastic if not more vitally interested than any other group in the promotion and outcome of the modern hygienic movement, may well stop from time to time to inquire about the sanity of the methods of the propaganda. The religious doctrine of past ages involved the threat of harm; it inculcated a fear of the destruction or danger that was sure to follow the violation of the law. This dismal attitude has long since been replaced by a religion of love, of uplift and joyous anticipation. In the health propaganda, likewise, much of the pessimistic attitude, unconsciously perhaps, has been introduced in the past. The fear of disease has been held over the heads of the people. Rarely have we seen the more appropriate spirit of the modern "better health" movement better expressed than in a recent pamphlet of the Life Extension Institute. "It is not a fear of illness or of death that we should encourage, but a love of health, a sense of responsibility for the care of our bodies, a desire for bodily endurance and efficiency and full achievement. If the mind is fixed on these ideals, and the already known means of approaching them are utilized, the needless miseries that embitter the lives of so many may be left to take care of themselves. It is not so much necessary to fight disease as to cultivate health

for the happiness, contentment and moral gain that it brings." There is something unusually optimistic and buoyant in such words. They embody the psychologic cue to comfort and happiness for many a patient, without implying that "man is incapable of sin, sickness, and death," or that "health is not a condition of matter, but of mind." To inspire a love of health does not mean to exclude the great body of scientific knowledge which is the best that science can offer today regarding disease, or to replace medicine by crude metaphysics. The ardent love of health insures a mind receptive to the lessons of modern medicine.—The Journal of the American Medical Association.

WHAT WOULD THEY DO?

A lot of politicians are talking about protecting American labor. They don't seem able to say just how they would do it beyond the fact that they would increase the tariff. But that is too flimsy. The most highly protected industries have been the most notorious for bad treatment of labor, and furthermore they have employed as little American labor as they could. The New Republic recently made a very good and a wholly practicable suggestion, viz., that the men who come to Congress asking a higher tariff should be asked to make good. Talk has been plenty, but just what will they do? Will they increase wages? And how much? Will they split up with labor, and just how much do they think ought to be labor's share of the increased burden they ask the consumer to bear? In other words, it's time to stop smiling and talk turkey.

Of course, we don't expect Governor Philipp or Senator Harding of Ohio or the other politicians to talk turkey, but the men in whose name the protection is asked, the manufacturers who pull the strings—certainly it doesn't seem too much to ask a man who comes begging you to increase his profits to tell you what he is really going to do.—Milwaukee Journal.

THE SHIP-PURCHASE BILL.

The decision of the Interstate Commerce Commission to enter upon an immediate and thorough inquiry into the transportation facilities and rates between the United States and other countries must be interpreted to mean that the President is gathering fresh data to be used by him in pressing to passage a Ship-Purchase bill similar—if somewhat modified—to that which failed of passage in the last session of Congress. The results of this investigation are to be in hand, it is understood, before the assembling of the Sixty-fourth Congress in December.

The investigation will cover all phases of the ocean commerce of the United States, with particular reference to trade with South and Central America. All American shippers have been asked by the Treasury

Department to enter at once into active co-operation with the Commission in the carrying on of this work, and it is believed that the data thus secured will effectively silence some of the most strenuous opposition manifested at the former session.

That the next session of Congress will find President Wilson in a stronger position to carry the Ship-Purchase bill is evident. The Democratic majority in the Senate will be six greater than it was in the last Congress, there being three less Republican votes and there more Democratic votes. With this increase in their voting strength, it ought to be possible for the Democrats to carry out the President's recommendation in this respect and thereby enable the government to demonstrate to the American people that it is possible and profitable to operate American ships in the off-shore trade without coolie crews.—Coast Seamen's Journal.

RAILROAD FINANCE.

The Rock Island was a magnificent property whose stock sold in 1901 at \$200 per share, and after deals, manipulations and reorganizations, was depressed to \$20 and a receivership in 1915. And still Congress has refused to give the Commerce Commission control of the stock and bond issues of railroads.

Actual Rock Island losses of some \$20,000,000 are computed by the Interstate Commerce Commission, but as a company with decreased earning power and decreased ability to pay dividends, the loss is far greater. The Rock Island has larger gross earnings than ever before, but because of financial mismanagement, the company is almost worthless from the stockholder's viewpoint.

A use of power through which stockholders lose scores of millions certainly should be amenable to law. Yet by some peculiar, devious turn in the American standard of morals, the milking of corporation property is at least condoned by the American public. A few persons perhaps wax wroth over ruthless railroad losses, but the great mass of public sentiment, outside of the persons immediately defrauded, remains stolidly indifferent to the injustice inflicted.

The carrying of worthless bonds on the books for millions of fictitious values, the unwise purchase of interests in other companies and the silencing of those who would make trouble were instances of a long record of irregular transactions that would not stand the light.

A little stress on common honesty, stock regulation, jail penalties and insistence on real railroad directors instead of "dummies," are some of the lessons of the history of the Rock Island road. If Congress does not give the Commerce Commission the power to stop such episodes, it will be grossly negligent of a plain duty.—Milwaukee Journal.

News of General Interest.

CONTINUOUS-RAIL CROSSING FOR TRACK INTERSECTIONS.

(By Frank C. Perkins.)

The accompanying illustration shows a unique continuous crossing for interlocking and high speed points, as developed at Springfield, Ohio. It is pointed out that on account of the extraordinary wear and high repair cost of track intersections under modern heavy railway equipment, it was very desirable to substitute a continuous-rail crossing frog for the ordinary frog.

It is of interest to note that the devices so far designed are of two types, having sliding and revolving blocks at the rail intersections. A continuous-rail crossing

It is stated that the operating rods are cranked horizontally at each end, and this part of the rod passes through a sliding cam in the base of the crossing block. Thus a longitudinal movement of the rod shifts the blocks in a direction laterally to that of the rod and diagonally to the center lines of the tracks. Turnbuckles on the rods permit of adjustment of the throw.

As noted in the photograph, the crossing is set to give continuous rails for the track running from left to right. When the other track is to be cleared, the throw of the lever gives a stroke to the flat, operating rods and the blocks move in a diagonal direction upward and outward. This move-

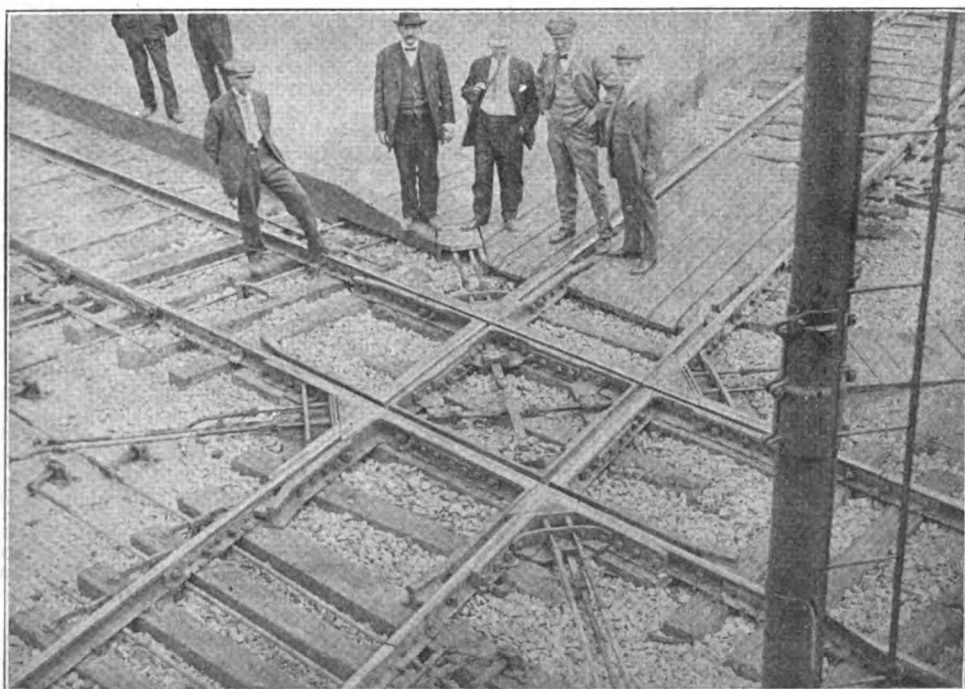

A NEW DEVICE FOR A CONTINUOUS RAIL AT RAILWAY CROSSINGS.

which is now being tried in service is of the sliding type, each corner of the crossing having a movable block whose lateral motion gives a continuous rail for one or other track. The construction and the operating mechanism are very simple.

In this equipment there are two sliding blocks moved by an operating rod, while two blocks are moved by another rod. The rods are connected for simultaneous movement, and if the crossing is equipped with signal interlocking plant, they are connected up with the interlocking mechanism. The two smaller rods at each block are the bolt blocks for locking the blocks in which ever position they are set.

ment clears the flangeways of this second track and closes those of the right and left track. The two round rods behind each sliding block are those of the locking mechanism and they partly conceal the ends of the operating rods.

The crossing illustrated is at the intersection of the main track and Sandusky branch of the Toledo division of the Pennsylvania lines, at Carrothers, Ohio, and was built to conform to the 85-lb. rails of the Am. Soc. C. E. section, with a flangeway or throat width of $1\frac{1}{4}$ -in. The entire crossing is of manganese steel, and is built in four sections, as shown. There are 28 trains daily on the Toledo branch and 32 trains on

the Sandusky branch, and the crossing is thrown at least once for each of these trains. Besides this, Carrothers is a setting-off point, so that nearly every train switching there passes over the crossing at least twice in addition to the regular movements.

A HALF-MILLION GALLON WATER TANK AND TOWER.

(By Frank C. Perkins.)

The Appleton tank shown in the accompanying illustration has a capacity of 500,000 gallons. This elevated tower and tank was constructed by the city of Appleton, Wis., and was erected to procure a reserve



A GIANT TOWER TANK.

supply of domestic water and at the same time to secure a constant pressure. It is an elliptical bottom tank with a large diameter and small height of shell supported upon an eight-foot three-panel tower, with an elevation of 102 ft. 8 in. to the bottom and 140 ft. to the high water line, giving a water pressure of 60 pounds per square inch at the base.

It will be seen that this tank has an elliptical bottom, made of plates, consisting of two courses, besides a circular bottom plate,

to which is riveted a steel riser pipe five feet in diameter. The tank is 51 ft. in diameter by 24 ft. 3 in. high, consisting of two courses of plates. The roof is constructed of 3-16 in. metal, having a bevel of 4½ in. to one foot and is supported by a roof framing of channel rafters and angle purlins. The posts are built-up members of two channels with cover plate on their back and double-laced on their front side.

The riser pipe was built of 7 ft. 6 in. sections of rolled steel plates. A spiral stairway winds around the riser pipe to the top of the second panel of tower. It then runs across to and around a post, and again spirally connects to the balcony, which encircles the tank at the spring line. In the valve pit in the center pier, under the riser pipe, is a 16 in. valve, which is opened and closed by an electrical device, worked by throwing a switch at the pumping station. In case of fire this valve is closed so that the pressure in the mains can be raised considerably above that which would overflow the tank if the valve was left open.

It is stated that the 16 in. outlet pipe projects down four feet into the bottom of the cylinder above and any dirt settling in the cylinder can be blown out by hydraulic pressure through 6 in. blow-off valve, which is flush with the bottom. This blow-off valve is opened and closed by turning a lever on the outside of the riser pipe. Besides building this large tank the city has rehabilitated the entire waterworks system. It has laid many miles of new pipe, added a great many new hydrants and valves and in addition to this an entire new pumping plant has been built.

Diesel oil engines and triplex pumps are so arranged as to interchange pumps and engines. This plant is said to be the most economical fuel using pumping plant of any city of the United States.

A REMARKABLE 75-TON FREIGHT CAR OF UNIQUE DESIGN.

(By Frank C. Perkins.)

The accompanying illustration shows a unique car of great capacity, utilized by the Westinghouse Electric and Manufacturing Company of East Pittsburgh for transporting large transformers completely assembled and ready for installation immediately on arrival at their destination. It is stated that the great increase in capacity size and weight of these transformers rendered it necessary to provide special "cut out" steel cars, with strong central floors suspended at about axle height from heavy side frames. These cars had a capacity in the well of 70,000 pounds, but even they were inadequate for the dimensions of 2,000 kva. tubular transformers and three heavy cars of the type shown in the photograph were designed and constructed at Cleveland. This car is entirely of steel and measured 35 ft. 5 in. long, with a capacity of 150,000 pounds or 75 tons in the well. For a load that can be spread over the entire car on the end

platforms as well, the capacity over 100 tons.

The surface of the floor in the well is about 2 ft. 2 in. above the top of the rails, giving a maximum amount of clearance under bridges. The car frame is of heavy built up steel guides. The trucks are of 205,000 capacity with 6 in. XII in. journals,

a reasonable number of dies to cover the range of work, it is preferable to install a machine which is adapted to any shape or dimension and for which but few dies are required.

The boiler flanging press noted in the accompanying photograph and drawings does its large work more slowly than a four-

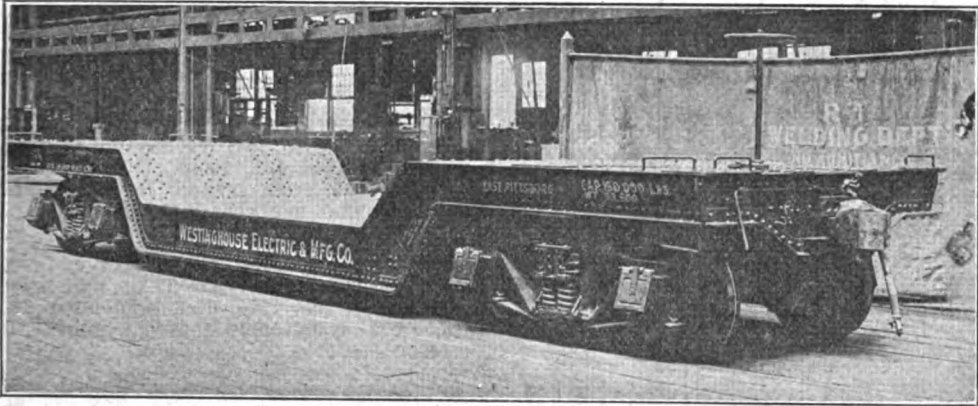

A SPECIAL DESIGNED FREIGHT CAR.

33 in. wheels and M. C. B. requirements and springs of extra large capacity. It may be stated that the center plates are wrought steel and primal boxes, riders and brasses, all conform to M. C. B. requirements for 100-ton capacity journals. Each car is equipped with Westinghouse air brakes, Westinghouse friction draft gear and M. C. B. automatic couplers. The car weight is 53,000 pounds. It may be mentioned that transformers of the oil-insulated, tubular self-cooling type with a capacity of 2,000 kva. have been built for the Southern Power Company's station at Newberry, S. C., and as loaded on car, the extreme part of the transformer stood 16 ft. above the tops of the rails.

It is said that on account of limitations, tunnels in the Allegheny mountains and at Baltimore, it was shipped via Olean, Belmer and Cape Charles City to Puiner's Point near Norfolk.

A GIANT SECTIONAL BOILER FLANGING PRESS.

By Frank C. Perkins.

The accompanying illustration, Fig. 1, and drawings, Figs. 2, 3, 4, 5, show a 150-ton flanging press, its design and method of operation in flanging a large boiler head sectionally; for flanging the entire head at one operation and flanging a blue hole as well as a boiler flue.

These drawings indicate how to flange steel either sectionally or in one piece, as suggested by the engineers of R. D. Wood & Company of Philadelphia, Pa. It is pointed out that except in shops where standard sizes of a boiler fronts and if the other work can be rigidly adhered to, enabling

column press, yet on small work, for which dies can be carried, it is equally rapid. The outer ram is used as a clamp, while the inner vertical ram, having a plow-shaped die at its lower end, turns down from two to

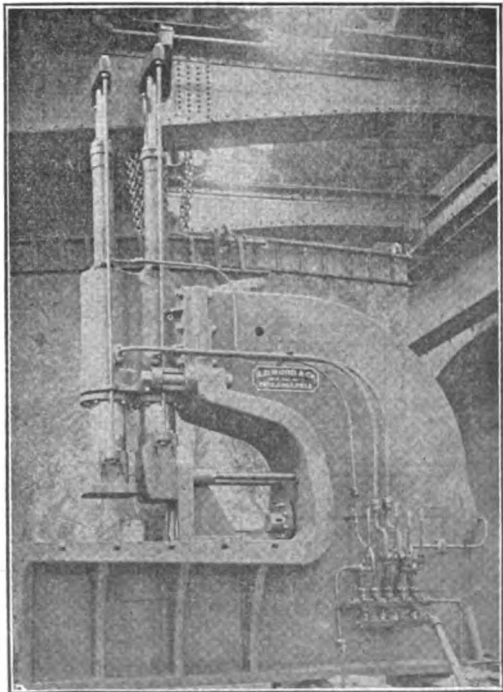

A GIANT BOILER FLANGING PRESS.

three feet of flange at one heat. The action of the horizontal rams follows the plow and smoothes and squares up the flanges around

the plow and horizontal ram. When used on small heads, both of the vertical rams are attached to a male die, and the plate is clamped against the latter by a supplementary ram moving upwards from below. The supplementary ram is carried in a cylinder hung in the lower jaw of the frame, and located centrally between the two upper rams.

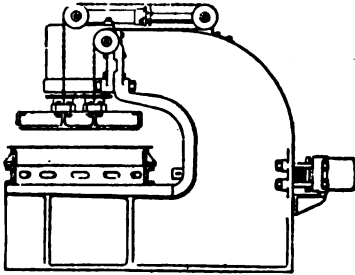

FLANGING ENTIRE HEAD AT ONE OPERATION

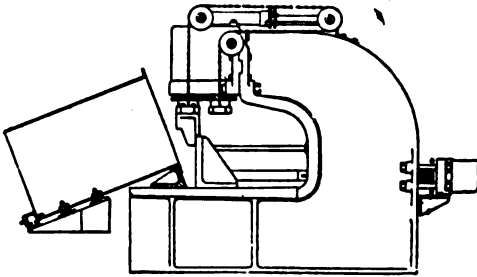

FLANGING BOILER FLUE.

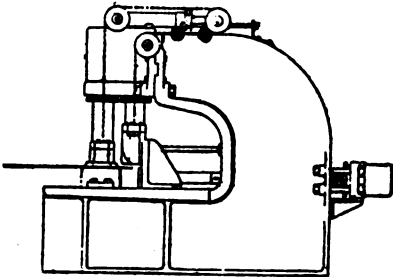

FLANGING LARGE HEAD SECTIONALLY

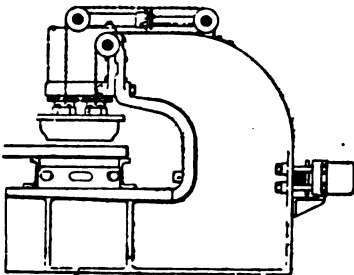

FLANGING FLUE HOLE.

the die block upon which the plate is clamped. There is an interlocking device used to prevent any possible foul between

In Memoriam

Members.

Leslie C. Carden, Reg. No. 99240, age 24 years, of Lodge No. 557, Williamson, W. Va., was born in Hampton, Tenn., 1891, died October 12, 1915, from typhoid fever; single. Was a member one year and 9 months.

Geo. E. Smith, Reg. No. 46881; age 36, Lodge No. 389, Sour Lake, Tex.; was born in Titusville, Pa., 1879, died September 26, 1915, from dysentery; single; member 10 years.

W. Skelland, Reg. No. 3824; age 57; of Lodge No. 194, Vancouver, B. C.; was born in England; died September 25, 1915, from cancer; married, one child; member one year from reinstatement.

RELATIVES OF MEMBERS.

Mrs. Annie Hannon, age 88 years, was mother of Brother John Hannon, of Lodge No. 191; she was born at West Maine, 1827; died October 11, 1915.

Lodge Notices

Feeney—Lauderback.

Anyone knowing the whereabouts of Brother Thomas Feeney, Reg. No. 48088, boiler maker, please have same correspond with Brother E. G. Lauderback, 810 Lamar Avenue, Wichita Falls, Tex.

Franks—Maley.

Anyone knowing the whereabouts of Brother John Franks, helper, Reg. No. 65361, please have same correspond with Brother J. A. Maley, 810 Lamar Avenue, Wichita Falls, Tex.

Sullivan—Mother.

Anyone knowing the whereabouts of J. P. Sullivan, last heard from while at work for Standard Oil Co., of Indiana, doing work at Casper, Wyo., as his mother and sister would like to hear from him very much. I think that he was a member of Local No. 90 at the time the agreement was signed up with this company. Anyone knowing where he is, have him write his mother and sister or please notify me at once.

NELSON HEGLUND, S. L. 67.

Kerus—Lodge No. 32.

Anyone knowing the whereabouts of Wm. Kerus, Reg. No. 78648, will please let Lodge No. 32 know. This brother's card is out of Lodge No. 403 of Hoisington, Kas.

WALTER E. DWYER, S. L. 32.

O'Brien—Lodge No. 39.

Anyone knowing the whereabouts of Edw. O'Brien, better known as Mickey O'Brien, Reg. No. 101118, be on the lookout for him and tell him if he does not correspond with the undersigned that the check he forged here for \$15 will be put into the proper hands to prosecute him. One of the brothers went good for the check and had to make it good, another brother loaned him \$15 more that he also forgot to pay. This is the same Edw. nee Mickey O'Brien that ran for mayor of Cushing, Okla.

JOHN COGHLAN, B. A. & C. S. L. 39.

Cooper et als.—Lodge No. 491.

Any secretary taking up the books or cards of any of the following brothers will please hold same and notify the secretary of Lodge No. 491, as they left town owing the amounts placed after their names. C. E. Cooper, Reg. No. 41907, \$12.35; A. J. Conley, Reg. No. 39115, \$3.95; John Crawford, Reg. No. 62321, \$34.70; W. J. Mills, Reg. No. 98504, \$6.40; John Peters, Reg. No. 80223, \$5.50.

Fraternally,
J. C. CARROLL, S. L. 491.

Kellett—Lodge No. 132.

Anyone knowing the whereabouts of Brother A. Kellett, Reg. No. 49101, boiler maker, will please notify the secretary of Lodge No. 132. E. T. CHESTER, Sec'y.

LIST OF MEMBERS PREVIOUSLY ADVERTISED

Thompson—Lodge No. 587.

F. W. Thompson, Reg. No. 20987, has been suspended by this local for non-payment of dues. He also owes about \$40 here.

T. C. MADDY,
June Journal. Secretary Lodge No. 587.

C. S. Burk—Lodge No. 82.

Any secretary taking up card of Brother C. S. Burk, Reg. No. 102470, will please hold same and correspond with secretary of Lodge No. 82, as this brother misrepresented facts to secure transportation to Kansas City, amounting to \$1.25, and we had to pay this bill out of the treasury of the local.

A. G. EVERETT,
June Journal. Secretary Lodge No. 82.

Robert Canton—Lodge No. 384.

Anyone knowing the whereabouts of Robert Canton, boiler maker's helper, will please notify the secretary of Lodge No. 384,

as this brother left this lodge without paying his bills that the lodge went good for.

A. W. JOHNSON,
July Journal. Secretary Lodge No. 384.

Douglas et al.—Lodge No. 587.

Lodge No. 587 has suspended M. E. Douglas, Reg. No. 100307, for non-payment of dues. We have also bills aggregating to \$80 against this brother. T. C. MADDY,

Secretary and Treasurer Lodge No. 587.
July Journal.

D. J. Fitzgibbons et al.—Lodge No. 99.

Any secretary taking up the card of D. J. Fitzgibbons, Reg. No. 67599, or F. G. Hayes, Reg. No. 21882, will please correspond with the secretary of Lodge No. 99, Newark, Ohio, as these brothers borrowed money from this local which they forgot to return.

CECIL C. ROBERTS,
July Journal. Secretary Lodge No. 99.

C. J. Dowd—Lodge No. 199.

Anybody knowing the whereabouts of C. J. Dowd, Reg. No. 96128, helper, left Lodge No. 199 without a card, and also owing a board bill of \$29 and other bills. Last stamp in his book issued by Lodge No. 113. Please notify the undersigned.

Aug. Journal. E. S. MCGINNIS, S. L. 199.

C. E. Cooper—Lodge No. 528.

Any secretary taking up the card of Brother C. E. Cooper, Reg. No. 41907, will please hold same and correspond with the undersigned, as this brother left here in 1913 and left unpaid bills that Brother Ed Swanson stood good for and had to pay.

J. H. THOMAS, S. L. No. 528.
Aug. Journal.

Seigler—Lodge No. 549.

Any secretary taking up the card of Brother E. R. Seigler, Reg. No. 68353, please hold same and correspond with secretary of Lodge No. 549, as this brother left here owing a bill of \$3.00, which a brother stood for.

PERRY COOPER, S. L. 549.
Oct. Journal.

Ennis—Lodge No. 346.

Any secretary taking up the clearance card of J. J. Ennis, Reg. No. 24751, will please hold same and correspond with the secretary of Lodge No. 346, as this brother left here owing some bills he misrepresented.

GEO. W. SINGER, S. L. 346.
Oct. Journal.

Hell—Lodge No. 588.

Any secretary taking up the card of Brother F. S. Hell, Reg. No. 43811, will please hold same and correspond with the secretary of Lodge No. 588, as this brother borrowed money. Last stamps and clearance card issued by Lodge No. 70.

JOHN McNANEY, S. L. 588.
Oct. Journal.

OFFICIAL ROSTER--International Officers

J. A. FRANKLIN.....International President
Room 15, Law Bldg., 721 Minnesota Ave., Kansas City, Kas.

F. P. REINMEYER.....Int. Secretary-Treasurer
Rooms 10 to 12 Law Bldg., 721 Minnesota Ave., Kansas City, Kas.

JAMES B. CASEY..... Editor-Manager of Journal
Room 9, Law Bldg., Kansas City, Kas.

A. HINZMAN.....First Int. Vice-President
Room 15, Law Bldg., 721 Minnesota Ave., Kansas City, Kas.

MISSOURI AND MISSISSIPPI SECTION.
States of Iowa, Missouri, Kansas, Nebraska, Arkansas, Mississippi, Alal a (other than Mobile), Tennessee, North and South Dakota, Oklahoma and Minnesota.

THOS. NOLAN.....Second Int. Vice-President
760 Court St., Portsmouth, Va.

GULF AND SOUTH ATLANTIC SECTION.
States of Texas, Louisiana, Florida, Georgia, North and South Carolina, Virginia, Maryland and Delaware, and Mobile, Ala.

J. P. MERRIGAN.....Third Int. Vice-President
91 Manufacturer St., Montreal, Que., Can.

CANADIAN SECTION.
The Dominion of Canada.

LOUIS WEYAND.....Fourth Int. Vice-President
6201 Flr Avenue, N. W., Cleveland, Ohio.

GREAT LAKES AND TERRITORY SECTION.
States of Wisconsin, Michigan, Cities of Chicago, Toledo, Cleveland and Lorain, O., Erie, Pa., State of New York (other than the City of New York).

WM. ATKINSON.....Fifth Int. Vice-President
212 South Pittsburg St., Spokane, Wash.
ROCKY MOUNTAIN AND PACIFIC COAST SECTION.

Honolulu, States of California, Oregon, Washington, Idaho, Utah, Nevada, Montana, Wyoming, Colorado, Arizona, Old Mexico, New Mexico and Canal Zone, Panama.

JOHN J. DOWD.....Sixth Int. Vice-President
133 Wegman Place, Jersey City, N. J.

EASTERN SEABOARD SECTION.
States of Maine, New Hampshire, Vermont, Massachusetts, Rhode Island, Connecticut, New Jersey and New York City.

M. A. MAHER.....Seventh Int. Vice-President
2114 Eighteenth St., Portsmouth, Ohio.

OHIO VALLEY AND TERRITORY SECTION.
States of Pennsylvania (other than the city of Erie), Ohio, West Virginia, Kentucky, Indiana and Illinois (other than the City of Chicago).

JOS. P. RYAN.....Eighth Int. Vice-President
7533 Vernon Ave., Chicago, Ill.

HELPERS' VICE-PRESIDENT OF WESTERN SECTION.
All states west of dividing line between Indiana and Ohio.

JOHN F. SCHMITT.....Ninth Int. Vice-President
1469 N. Fourth St., Columbus, Ohio.

HELPERS' VICE-PRESIDENT OF EASTERN SECTION.
All states east of dividing line between Indiana and Ohio.

District Lodges and Officers

DISTRICT No. 5—St. Louis, Mo. Mo. Pac. and Iron Mountain R. Lodges represented: 32, 38, 44, 66, 82, 106, 113, 117, 286, 322, 403, 507, 521, 542, 543, 565, 583 and 599.

John C. Morrow, Pres., 613 W. 4th St., Coffeyville, Kans.

Hal. Stack, Vice-Pres., Van Buren, Ark.

John J. Murphy, Secy., 3404 Eads Ave., St. Louis, Mo.

J. N. Shirley, Treas., Box 496, Hoisington, Kans.

A. E. Stewart, Member Ex. Board, 2533 Myrtle Ave., Kansas City, Mo.

A. J. Radford, Member Ex. Board, 624 Oak St., Little Rock, Ark.

Chas. A. McDonald, B. A., 4416 Norledge Ave., Kansas City, Mo.

DISTRICT No. 10—Davenport, Ia. Rock Island System. Lodges represented: 377, 144, 346, 199, 340, 293, 323, 434, 439, 491, 96, 32, 69, 393, 476, 522, 523.

Geo. W. Pring, Pres. & B. A., 677 38th St., Des Moines, Ia.

John Mitchell, V.-P., 1502 McGowan St., Little Rock, Ark.

S. T. Sample, C. & F. S., 515 N. Jackson St., Pratt, Kas.

J. J. Lynch, Treas., Box 655, Herington, Kas.

DISTRICT No. 12—New York. New York Central System. Lodges represented: 5, 7, 10, 64, 67, 85, 150, 157, 169, 175, 197, 218, 223, 229, 321, 413, 492.

A. M. Anderson, Pres., 2208 Francis St., Jackson, Mich.

G. H. Gates, Vice-Pres., 148 N. Orchard St., Watertown, N. Y.

J. J. Leamy, Sec.-Treas., 69 Livingston Ave., Albany, N. Y.

Trustees—Wm. Weber, E. J. McNamara and Thomas Ranger.

DISTRICT No. 13—Birmingham, Ala. Southern R. R. System. Organized Feb. 23, 1904. Lodges represented: 2, 4, 12, 14, 40, 50, 88, 143, 170, 226, 235, 312, 320, 334, 344, 363, 369, 419, 435, 511, 524, 584, 590.

Thos. J. Garvey, Pres., 414 E. Byrd St., Richmond, Va.

A. E. Barksdale, Vice-Pres., 119 E. Orleans St., Jackson, Tenn.

P. E. Berney, Sec.-Treas., R. F. D. 12, Knoxville, Tenn.

DISTRICT No. 15—Chicago, Ill. C. & N. W. R. R. Lodges represented: 38, 60, 129, 145, 161, 201, 227, 311, 395, 440, 486, 496, 539, 597.

M. J. Gleason, Pres., 202 Michigan St., Milwaukee, Wis.

F. E. Hill, Vice-Pres., Huron, So. Dak.

Thomas Dean, Secy-Treas., 2214 W. 13th St., Chicago, Ill.

DISTRICT No. 19—Roanoke, Va. Norfolk & Western System. Lodges represented: 29, 402, 30, 405, 537.

E. J. Horgan, Pres., 404 7th Av., N. E. Roanoke, Va.

H. D. Mauck, Secy., 519 10th St., S. W. Roanoke, Va.

J. B. O'Brien, Treas., 412 3d Ave., N. E. Roanoke, Va.

DISTRICT No. 22—D. R. G. System, Colorado and Utah. Meeting place, Denver, Colorado; Date meeting, 2d Monday in July, 1915; Lodges represented: 44, 103, 179, 335, 427, 446, 478.

Geo. S. Warden, Pres. & B. A., 1507 E. 7th St., Pueblo, Colo.

H. F. Jones, Vice-Pres., 135 Sackett Ave., Salida, Colo.

A. A. Duncan, Sec.-Treas., Box 611, Alamosa, Colo.

DISTRICT No. 23—Frisco System. Meets at St. Louis, Mo., 2d Monday in October, 1916. Lodges represented: 4, 70, 96, 180, 286, 418, 449, 458, 530, 521, 543, 546, 556, 322.

A. F. Bingham, Pres. and B. A., 701 Lombart St., Springfield, Mo.

L. W. Lawson, V.-P., 821 N. Maxey St., Sherman, Texas.

J. W. Reddick, Financial and Recording Secretary, 817 Lincoln St., Springfield, Mo.

A. A. Denton, Cor. Sec. and Treas., 1044 W. Mt. Vernon St., Springfield, Mo.

DISTRICT No. 24—Decatur, Ill. Wabash System. Lodges represented: 54, 81, 85, 169, 267, 384, 447, 581, 594.

Leo Singer, Pres., 406 S. Webster, Decatur, Ill.

L. L. Mutter, Vice-Pres., 1621 S. 8th, Springfield, Ill.

Chas. J. Young, Secy-Treas., 432 E. King, Decatur, Ill.

DISTRICT No. 25—Livingston, Mont. Northern Pac. R. R. Lodges represented: 3, 104, 111, 116, 123, 130, 165, 242, 247, 591.

J. G. Brown, Pres., 610 N. 9th St., Brainerd, Minn.

Frank Depender, V.-P., 735 E. Nora Ave., Spokane, Wash.

Theo. W. Everett, Sec.-Treas., P. O. Box 554, Livingston, Mont.

Trustees—A. H. Shanks, 221 N. 2nd St., Missoula, Mont.; Hugh Roberts, Gen. Del., Glendive, Mont.; G. M. Owens, 312 So. E. St., Livingston, Mont.

DISTRICT No. 26—Milwaukee, Wis. C. M. & St. P. Ry. System. Comprising Lodges 11, 15, 32, 38, 41, 104, 244, 302, 485, 526, 528, 568, 588, 595, 603, 606.

G. H. Hawkaworth, Pres., Box 817, Deer Lodge, Mont.

Thos. J. Godfrey, Vice-Pres., 930 E. 44th St., Chicago, Ill.

Peter W. Gunn, Secy-Treas., 2745 30th Ave., So. Minneapolis, Minn.

Trustees: R. Hennessey, 818 So. Yakima Ave., Tacoma, Wash.; John M. Slater, 425 5th St. Green Bay, Wis.;

Chas. E. Cook, 119 N. Strevell St., Miles City, Mont.

J. L. Callahan, B. A., 3606 Clinton St., Milwaukee, Wis.

DISTRICT No. 27—Int. G. N. R. R. W. O. Faulk, Pres., Palestine, Tex. Lodges represented: 222, 345, 464.

W. K. Saddler, Vice-Pres., Mart, Texas.
E. H. Frick, Sec.-Treas., San Antonio, Tex.

W. B. Graham, B. A., Palestine, Tex.

DISTRICT No. 29—Cincinnati, O. C. H. & D. R. R. Lodges represented: 10, 85, 91, 259.

W. J. Redmond, Pres., 204 N. Wash. St., Indianapolis, Ind.

A. R. Griesheimer, Vice-Pres., 329 N. Elizabeth, Lima, O.

Wm. J. McGee, Jr., Sec.-Treas., 1255 Richmond St., Cincinnati, O.

DISTRICT No. 30—Canadian Pacific. District Headquarters, Winnipeg, Man. Lodges in affiliation: 126, 134, 194, 379, 392, 466, 478, 505, 548, 417.

Geo. F. Chadburn, Pres. and Acting Sec.-Treas., 1585 Alexander St., Winnipeg, Man.

J. B. Smith, V.-P., 162 Annette St., Toronto, Ont.

R. Carswell, V.-P., 684 Home St., Winnipeg, Man.

DISTRICT No. 31—Cincinnati, O. B. & O. System. Lodges represented: 5, 10, 79, 92, 105, 135, 241, 259, 318, 326, 332, 444, 493, 498, 514, 579, 577.

J. C. Smith, Pres., Box 292, Garrett, Ind.

J. R. Cline, Vice-Pres., Cleveland, O.

M. W. Luke, Sec.-Treas., 1007 W. Main., Washington, Ind.

DISTRICT No. 34—Boston, Mass. Boston & Maine System. Lodges represented: 245, 248, 488, 481, 515, 517. Meets at Boston, Mass., 1st Monday in August and 2d Monday in February.

W. H. Wells, Pres., 108 Westford St., Lowell, Mass.

P. J. Kelley, Vice-Pres., 3 Devon St., Greenfield, Mass.

T. J. Donahue, Sec.-Treas., 5 Fernand St., Lowell, Mass.

DISTRICT No. 35—Parsons, Kas. M., K. & T. R. R. System. Lodges represented: 292, 209, 501, 576, 265, 32, 118, 207.

Fred Aisdorf, Pres. & B. A., 515 W. Owings St., Denison, Tex.

C. Dudding, V.-Pres., 2229 Crawford St., Parsons, Kas.

Robt. Rosbottom, Sec.-Treas., 600 W. Texas St., Denison, Tex.

C. A. Denton, Rec. Sec., Parsons, Kas.

Wm. Dickerson, Chairman Trustees, 810 Cleveland St., Waco, Tex.

DISTRICT No. 37—Texarkana, Tex. Cotton Belt R. R. System. Meets 3d Saturdays in January and July. Lodges represented: 68, 486.

R. M. Cummins, Pres. & B. A., 308 E. Valentine St., Tyler, Tex.

John A. Smith, V.-P., 1908 E. 8th St., Pine Bluff, Ark.

B. E. Shields, Sec.-Treas., 1508 E. 7th Ave., Pine Bluff, Ark.

DISTRICT No. 38—Atlantic Coast Line. Lodges represented: 20, 26, 239, 422, 424, 425, 448, 570.

A. J. Dixon, Pres., Rocky Mount, N. C.

W. A. Cahill, Vice-Pres., Montgomery, Ala.

E. S. Ryan, Sec.-Treas., 508 Lackawana Ave., Jacksonville, Fla.

DISTRICT No. 39—Central of Georgia System. Meets 1st Friday after Thanksgiving each

year at Columbus, Ga. Lodges represented: 4, 12, 26, 436, 510.

R. J. Black, Pres., 913 2nd St., Macon, Ga.

J. J. Dean, Vice-Pres., 226 Taylor St., Savannah, Ga.

Chas. A. Buchhall, Sec.-Treas., 103 Gordon W., Savannah, Ga.

E. M. Kendrick, Rec. Sec., Route 5, Cedartown, Ga.

R. S. Barry, Cor. and Fin. Sec., 1109 5th Ave., Columbus, Ga.

DISTRICT No. 40—Hamlet, N. C. Seaboard Airline and leased lines. Lodges represented: 2, 30, 26, 173, 298.

B. M. Jewell, Pres., 727 W. Monroe St., Jacksonville, Fla.

J. F. Brice, Vice-Pres., 204 Whitehall St., Atlanta, Ga.

E. C. Howle, Secy-Treas., 1119 E. 32nd St., Savannah, Ga.

DISTRICT No. 41—Hinton, W. Va. Chesapeake & Ohio System. Lodges represented: 55, 170, 238, 249, 356, 384, 525, 537.

R. L. King, Pres., 822 N. Twenty-sixth St., Richmond, Va.

L. F. Moatz, Vice-Pres., 159 W. Third St., Peru, Ind.

C. L. Barnett, Sec.-Treas., 419 Summers St., Hinton, W. Va.

Trustees—M. L. Steinbuck, Box 336, Clifton Forge, Va. D. C. Dowdy, 2046 7th Ave., Huntington, W. Va. A. J. Poke, 1817 Scott Ave., Covington, Ky.

DISTRICT No. 42—Danville, Ill. Chicago & Eastern Illinois R. R. Meets 1st Tues. in Feb., 1916. Lodges represented: 22, 95, 575.

Jas. B. Keenan, Pres. and B. A., 122 Indiana Ave., Danville, Ill. Office Henthorn, R. & F. S., 103 Iowa St., Danville, Ill.

A. Welch, Cor. Sec. & Treas., Villa Grove, Ill.

Subordinate Lodges and Officers

2—ATLANTA, GA. 2d-4th Thurs. A. D. Lundbon, Pres., 224 E. Fair. J. E. Basham, C. & F., 18 Wayman Ave.

2—ST. PAUL MINN. 1st-3d Fri. New Odd Fellows' Home, 9th and Franklin.

Geo. Cox, Pres., 1746 Logan. Wm. Harrington, F. S., 695 Pine. Wm. Parranto, B. A., 400 E. Jenks.

4—BIRMINGHAM, ALA. 1st-3d Tues., K. of C. Hall.

Fred Baker, Pres., 2021½ 3d Ave. A. L. Carmack, F. S. & B. A., Office: 335 Hood Bldg.

6—CLEVELAND, OHIO. 1st-3d Thurs., Room 3, Federation Hall, 310 Prospect.

Chas. Tongreen, Pres., Superior. G. H. Brady, C. B. & B. A., 1182 E. 113th.

7—BUFFALO, N. Y. 2d-4th Fri., Council Hall, 33 E. Warron.

Geo. F. Muir, Pres., 116 Goodell. Thos. J. King, C. S., 1943 Seneca. Frank P. O'Brien, F. S., 238 Schiller.

8—COLUMBUS, O. Meets 2d-4th Thurs., F. of L. Hall.

Chas. L. Nicklaus, Pres., 473 Poplar Ave.

Adam Ruckel, C. S., 267 Liebert.

10—INDIANAPOLIS, IND. 2d-4th Thurs., Labor Temple, 138 W. Washington St.

E. P. Leopard, Pres., 206 N. Tremont Ave.

Wm. Frohlinger, C. S., 543 East Louisiana St.

L. E. Hinesch, F. S., 851 Ashland Ave.

11—MINNEAPOLIS, MINN. 2d-4th Mon., Richmond Hall, 223 5th St.

H. P. Farly, Pres., 1356 Vine Place.

E. A. Conlin, C. S., 8639 1st Ave. So.

12—MACON, GA. 2d-4th Friday, Morgan's Hall, cor. Elm and Broadway.

J. T. Fenlon, Pres., 1974 Third St.

L. S. Rogers, C. S., 126 Cole.

14—CHATTANOOGA, TENN. Central Labor Hall, 8th and Cherrie Sts., 2d-4th Mon.

Wm. Quigley, Pres.

Jas. E. Evans, C. & F. S., 19 Jefferson.

15—DUBUQUE, IOWA. 1st-3d Tues., Union Hall, 19th and White Sts.

E. Keck, Pres., 1273 Lincoln Ave. R. Ruof, C. & F. S., 975 Clay St.

16—JERSEY CITY, N. J. 1st-3d Mon., Fischer's Hall, Newark Ave., cor. Erie St.

Patrick J. Kenneally, Pres., 9 Nagnolla Ave.

Hugh Fitzpatrick, C. S., 244 York. Ed. McCarthy, B. A.

19—PHILADELPHIA, PA. 2d-4th Fridays, Bricklayers' Hall, Broad and Fairmount Ave.

Frank Goodfellow, Pres., 159 W. Palmer St.

R. S. Hopkins, C. S., 2426 S. Clarion.

20—JACKSONVILLE, FLA. Meets every Tuesday, Central Labor Hall, 46½ W. 2nd.

E. F. Ketchey, Pres., 841 W. Monroe.

E. S. Ryan, C. & F. S., 603 Park.

21—NEW YORK, N. Y. 1st-3d Mon., 201 Williams St.

James H. Sullivan, Pres., 607 W. 46th St.

James McGeney, C. S., 295 Livingston St., Brooklyn, N. Y.

Harry Davis, F. S., 351 5th Ave., Brooklyn, N. Y.

22—DANVILLE, ILL. 1st-3d Mon., Trades and Labor Hall.

Ray Schenk, Pres., California St.

Wm. J. Irwin, C. S., 7 Illinois. Frank Jergens, F. S., 418 N. Bowman Ave.

G. D. Davis, B. A., 18 N. Hazel.

25—SAN FRANCISCO, CALIF. Roesch Hall, 15th and Mission Sts., 2d-4th Thurs.

John Kane, Pres., 41 Collingwood.

Thos. J. Sheridan, C. S. & Treas., 2312 24th St.

Wm. P. Bowser, B. A., 314 14th.

26—SAVANNAH, GA. 1st-3d Tues., Whittaker St. and Liberty Lane.

E. C. Howle, Pres., 1110 E. 32d St.

R. B. Allen, C. S., 509 E. 32d St.

27—ST. LOUIS, MO. Every Thurs., 10th and Carr.

Larry Kickham, Pres. & B. A., 5322 Vernon Ave.

James Callahan, C. S., 3119 Locust. Henry Seikmann, F. S., 4448 Besse Ave.

- 80—ROANOKE, VA.** 2d-4th Wed., Labor Home Hall, Commerce and Salem Ave.
G. J. Lucas, Pres., 1121 2d Ave. N. W.
J. R. Anderson, C. S., 502 Campbell Ave.
- 30—ROANOKE, VA.** 2d-4th Mon., Labor Hall, cor. Commerce St. and Salem Ave.
C. E. Eades, Pres., 313 7th Ave. N. E.
B. I. Wade, C. S., 311 Jamison Ave.
- 31—ST. JOSEPH, MO.** 2d-4th Mon., Jockey Hall.
B. E. Stitta, Pres., 2323 So. 6th.
Edward Knight, C. S., 2119 So. 9th St.
- 32—KANSAS CITY, MO.** 2d-4th Fri., Labor Temple, 14th and Woodland.
Chas. Lackenby, Pres., 2023 Bellview.
W. E. Dwyer, C. & F. S., 115 N. Elmwood.
Chas. McDonald, B. A., 4416 Norledge.
- 37—NEW ORLEANS LA.** 2d-4th Wed., Martin's Hall, Iberville and Exchange Place.
Edward Gabler, Pres., 1810 Annunciation.
Wm. J. Smith, B. A., 228 Morgan St., Algiers, La.
Lewis J. Costella, C. S., 626 So. Lopez.
Victor Escausse, F. S., 617 Alix St., Algiers, La.
- 38—OMAHA, NEB.** 1st-3d Wed., Balright Hall, 19th & Farnum.
M. J. McGovern, Pres., 2247 N. 19.
L. G. Rankin, C. S., 2825 Cass.
J. H. Massman, F. C., 1611 Locust.
- 39—SOUTH CHICAGO, ILL.** 2d-4th Tues., Union Headquarters, 22d St. and Erie Ave., South Chicago.
Frank Bacton, Pres., 10222 Ave. L.
John Cogan, C. S. & B. A., 9944 Ave. H.
Joseph Manners, F. S., 10500 Ave. G.
- 40—LOUISVILLE, KY.** 2d-4th Wed., in Beck's Union Hall, 1st and Jefferson Sts.
Thomas Mitchell, Pres., 1422A Broadway.
E. Terrell, C. S., 308 N. 19th St.
F. J. Kiesler, F. S., 212 Collins Court.
- 41—HARLOWTON, MONT.** 2d-4th Thurs., Winer Hall.
John Dennis, Pres.
Verne Scott, C. S., Box 550.
- 42—NASHVILLE, TENN.** 2d-4th Thurs., Carpenters' Hall, 342½ 4th Ave. N.
H. R. Brown, Pres., 611½ Church.
W. T. Pentecost, C. S., 2143 Oakland Ave.
- 44—PUEBLO, COL.** Every Wed., Trades Assembly Hall, Cor 3rd St., and Santa Fe Ave.
Geo. D. Hilbert, Pres., 1140 Claremont Ave.
Geo. S. Warden, C. & F. S., 1507 E 7th St.
- 45—BROOKLYN, N. Y.** Greenpoint and Manhattan Aves., 2d-4th Thurs.
Gerald A. Daly, Pres. & C. S., 676 60th St.
M. J. Callahan, F. S., 177 Norman Ave.
- 46—CHEYENNE, WYO.** Union Hall, 2d-4th Wed.
Geo. R. Wallace, Pres., P. O. Box 151.
F. A. Rath, C. S., 110 E 26th.
- 47—DES MOINES, IA.** 1st-3d Thurs., Trades Assembly Hall.
James Gillespie, Pres., 1113 Columbus Ave.
Fritz Johnson, C. & F. S., 922 W. 1st St.
- 48—LARAMIE, WYO.** 1st-3d Tues., Moose Hall.
Jacob Claus, Pres., 114 Cedar St.
- Frank M. Lepper, C. S., 360 N. 3d St.
- 50—CHARLESTON, S. C.** 1st-3d Tues., Y. M. C. A. Hall, George St.
H. J. Hartnett, Pres., 13 Anson St.
John J. Clair, C. & F. S., 193 Spring St.
- 54—FORT WAYNE, IND.** Last Wed., West Berry St.
Edward F. Siebold, Pres. & C. S., 1130 St. Mary's Ave.
O. P. Ewald, F. S., 1419 S. Calhoun.
- 55—NEWPORT NEWS, VA.** Every Wed., 8 P. M., C. L. U. Hall, 32d and Wash. Ave.
Wm. H. Healy, Pres., 3711 Huntington Ave.
D. McArthur, C. S., 211 37th.
W. Hannah, F. S., P. O. Box 430.
- 57—PORTSMOUTH, VA.** 1st-2d Thurs., C. L. U. Hall.
O. C. Hartung, Pres., 1248 Park Ave.
J. H. Parrish, F. S., 622 Clifford.
Geo. Thomas, C. S., 204 Lincoln.
60—PEORIA, ILL. 1st-3d Mon., 411 Cedar St.
E. L. Thornton, Pres., 213 Faraday.
F. Hierapiel, C. S., 410 Warner Ave.
- 61—NEW HAVEN, CONN.** 1st-3d Thurs., Boardman Bldg., cor. State and Chapel Sts.
Wm. Hefferman, Pres., 95 Carlyle.
M. J. Whalen, C. & F. S., 138 Carlyle.
- 63—HOPEWELL, VA.**
J. C. Johnson, Pres.
L. J. Holt, Secy-Treas.
- 64—JACKSON, MICH.** Every Tues., Labor Hall, Main and Jackson Sts.
Geo. Jones, Pres., 140 Bates.
Ed McNamara, C. S., 619 South Pleasant St.
- 65—VICTORIA, VA.** 2d-4th Sundays, Lunenburg Hall.
J. H. Jones, Pres., Gen. Del.
W. H. Slayton, C. S., Gen. Del.
- 66—LITTLE ROCK, ARK.** 1st-3d Thurs., Brannon Hall, Markham and Cross Sts.
W. J. Flynn, Pres., 908 Denison.
E. Wortamith, C. & F. S., 300 W. 11th St., Argenta, Ark.
C. A. McDonald, B. A., 4416 Norledge, Kansas City, Mo.
- 67—BAY CITY, MICH.** 1st-3d Thurs., Central Trades Council Hall.
Wm. H. Benedict, Pres., 703 E. Winona Ave., W. S.
Nelson Heglung, C. & F. S., 614 Adams St.
- 68—PINE BLUFF, ARK.**—2d-4th Wed., Labor Temple.
A. J. Barton, Pres., 1701 W 6th.
B. E. Shields, C. S., 622 Nebraska.
J. A. Smith, F. S., 1908 E. 8th.
- 69—LITTLE ROCK, ARK.** 2d-4th Fri., Kent Hall, 910½ Main St.
John Mitchell, Pres., 1502 McGowan St.
W. A. Rooksberry, C. & F. S., 212 Pulaski.
Geo. W. Pring, B. A.
- 70—SPRINGFIELD, MO.** 2d-4th Wed., Eagles' Home.
A. E. Welch, Pres., 1822 Roberson Ave.
Scott Daffer, C. & F. S., 1235 Broad St.
A. F. Bingham, B. A., 701 Lombard St.
- 72—PORTLAND, ORE.** 2d-4th Thurs., 230½ Yamhill St.
Arthur Gallon, Pres., 649 Milwaukie.
H. N. Cooper, C. & F. S., 733 Rodney Ave.
F. E. Disbrow, C. S., 810 E. 11th
Joe Reed, B. A., 507 Bismark.
- 73—TROY, N. Y.** 2d-4th Mon., Swan and Georgia Sts., Mechanics' Hall, Huntington Ave.
- John Donnelly, Pres., 23 3d St., Cohoes, N. Y.
David Boyd, C. & F. S., 219 9th St., Waterlot, N. Y.
- 74—HOUSTON, TEXAS.** 1st-3d Wed., Woodman Hall, 1833 Washington St.
J. L. Sherman, Pres., 1112 Mary.
F. C. Jackson, C. & F. S., 2119 Lublick St.
- 79—GARRETT, IND.** 1st-3d Tues., K. of P. Hall, Randolph.
Geo. Richmond, Pres., 214 E. Keyser.
J. C. Smith, C. & F. S., Box 282.
- 80—ANACONDA, MONT.** 2d-4th Wed., M. & M. Hall, Lodge Box 372.
J. C. Smith, Pres., 510 Cherry St.
James W. Hogan, C. S., 800 Birch.
- 81—SPRINGFIELD, ILL.** 2d-4th Tues., Fortunes Hall.
C. F. Mutter, Pres., 1523 E. Capitol Ave.
Louis L. Mutter, C. & F. S., 1621 S. 8th.
- 82—OSAWATOMIE, KAS.** 1st-3d Mon., K. & L. Sec. Hall.
Hurb Fader, Pres.
A. L. Everett, C. & F. S., Box 636.
C. A. McDonald, B. A., 4416 Norledge, Kansas City, Mo.
- 83—KANSAS CITY, KAS.** 2d-4th Tues., K. P. Hall, 624 Minn. Av.
Thomas Knowles, Pres., 760 Shawnee.
Frank Stover, C. & F. S., 322 Nebraska Ave.
- 84—GRAND RAPIDS, MICH.** 2d and 4th Thurs., Campan Hall, 949 Division Ave.
Frank C. Lemke, Pres., 551 Shamrock St.
Nelson M. Warren, C. S., 127 E. Delaware St.
- 85—TOLEDO, OHIO.** 2d-4th Tues., Mitchell's Hall, cor. Walnut and Summit Sts.
J. S. Durst, Pres., 153 Gibbons St.
Ellsworth Richardson, C. S., 137 Western St.
- 86—DALLAS, TEX.** 1st-3d Mon., Broadnax Hall.
W. H. Riley, Pres., 1408 Corinth.
C. B. Stout, C. S., R. R. 10, Box 64.
- 88—JACKSON TENN.** 2d-4th Fri., Labor Hall.
B. B. Seward, Pres.
J. W. Seward, C. S., 415 E. Deadrick.
- 90—SUGAR CREEK, MO.** 2d-4th Thurs., Woodman's Hall.
L. Novak, Pres.
C. R. Snider, C. & F. S., 1222 W. Electric St., Independence, Mo.
- 91—ELMWOOD PLACE O.** 1st-3d Mon., Kellers Hall.
Geo. Urban, Pres., St. Bernard, O.
John Cullen, C. S., 39 Prosser Ave.
- 92—LOS ANGELES, CAL.** 2d-4th Wed., Union Labor Temple, 540 Maple Ave.
Wm. Gardiner, Pres., 2207½ E. 2nd.
H. E. Herman, C. & F. S., 530 S. Griffin Ave.
- 93—JOLIET, ILL.** 2d-4th Tues., Conner's Hall.
John Buckley, Pres., 111 Willard Ave.
Richard Farrell, F. S., 503 London Ave.
Charles Mork, C. S., 424 Landen Ave.
- 94—SACRAMENTO, CAL.** 1st-3d Thurs., Labor Temple.
John Grabfelder, Pres. & C. S., 3001 G. St.
J. S. Hiller, F. S. & Treas., 1723 26th St.
- 95—EVANSVILLE, IND.** 2d-4th Mon., Ruhl's Hall.
Chas. T. Mooney, Pres., 1802 Michigan.
Herman H. Grundman, C. & F. S., 267 Mary St.

- 96—FORT WORTH, TEX. B.** of L. F. & E. Hall, 1st-3d Thurs. J. J. Dempsey, Pres., 504 Calhoun. L. A. Freeman, C. & F. S., 2250 Jennings St.
- 99—NEWARK, OHIO.** Druid's Hall, 22½ S. 3d St., 1st-3d Sun., 9 a. m. Emil Indlekofer, Pres., 76 Curtis Ave. Harry Feldner, C. S., 56 German.
- 100—MARSHALL, TEX.** 1st-3d Tues., I. O. O. F. Hall. Smith Hayden, Pres., 514 Greenwood Ave. J. P. O'Neil, C. & F. S., 708 E. Rusk.
- 103—SALT LAKE CITY, UTAH.** Labor Temple, 3d East, bet. 1st and 2d S. St., 1st-3d Wed. Wm. H. Garrick, Pres., 416 Edith Ave. B. S. R. Harrison, C. & F. S., 862 Ouray Ave.
- 104—SEATTLE, WASH.** 1st-3d Thurs., Labor Temple, 6th and University St. Fred Counter, Pres., 2360 15th Ave., So. Dan McKillop, Sec. & B. A., 166½ 10th Ave., Phone Elliott 845W.
- 105—CINCINNATI, OHIO.** 2d-4th Thurs., Workman's Hall, Mercer and Walnut Sts. Chas. Granger, Pres., 329 Union St., Bellevue, Ky. D. L. O'Brien, C. S. & B. A., 23 Forest Ave., Ludlow, Ky. Frank Barenwit, F. S., 1023 5th Ave., Dayton, Ky.
- 106—McGHER, ARK.** 2d-4th Wed., K. of P. Hall. Wm. E. Crupper, Pres., Box 215. Chas. A. Stewart, C. & F. S., Box 432.
- 107—MILWAUKEE, WIS.** 1st-3d Tues., Speers Hall, Cor. National & 3d Ave. J. Hoppema, Pres., 1303 Fratney. R. Dale, Fin. Sec., 319 4th Ave. P. Sonnenberg, C. S. & B. A., 623 Greenbush.
- 108—AUGUSTA, GA.** 2d-4th Tues., Machinists' Hall, Broad. Patrick Rice, Pres., 1342 Walton Way. E. E. Bennett, C. S., 1406 Silcox.
- 109—CHADRON, NEB.** J. W. Boyd, Pres. John F. Paulson, C. & F. S., Box 347.
- 111—MISSOULA, MONT.** 2d-4th Tues., Eagles' Hall. H. A. Chase, Pres., Box 1304. A. H. Shanks, C. S., 221 N. 2d.
- 112—MOBILE, ALA.** Trade Council Hall, 1-3 Mon. J. A. Moore, Pres., 119 So. Conception. G. A. Sloum, C. & F. S., 956 Wash. Ave.
- 113—SEDALIA, MO.** 1st-3d Tues., Labor Temple. Chas. Hall, Pres., Gen. Del. C. A. McDonald, B. A., 4416 Norledge, Kansas City, Mo. W. H. Sims, C. S., 1306 E. 7th St.
- 116—BRAINERD, MINN.** 2d-4th Fri., Trades and Labor Hall. Henry Voigt, Pres., E. Oak. Wm. B. Good, C. S., Imperial Block.
- 117—DE SOTO, MO.** 1st-3d Mon., Federation Hall. R. B. Parks, Pres. S. L. Johnson, C. & F. S., Box 248.
- 123—LIVINGSTON, MONT.** 1st-3d Thurs., Trades and Labor Hall. C. D. Cain, Pres., 204 S. K St. Theo. W. Evert, C. & F. S., P. O. Box 554.
- 124—SAGINAW, MICH.** 1st-3d Fri., Petre & Meek's Hall, Genesee Ave. John Doyle, C. & F. S., R. F. D. No. 1.
- 126—WINNIPEG, MAN.** 3d Sun., 2:30 o'clock, Labor Temple. Wm. L. Hall, Pres., 1576 Elgin Ave. I. M. Couttie, C. S., 1497 Pacific Ave. A. Cook, F. S., 1233 Sil Kirk Ave.
- 129—CLINTON, IOWA.** 4th Fri., Labor Temple, 214 15th Ave. Henry L. Weber, Pres., 503 Elm. Henry Qualman, C. & F. S., 231 14th Ave.
- 130—BUTTE, MONT.** 1st-3d Tues., Carpenters' Hall, cor. Granite and Montana Sts. T. F. Shulta, Pres., Box 779. Harry Goodland, C. & F. S., 177 E. Center.
- 132—GALVESTON, TEX.** 2d Mon., Cocks and Walters' Hall, 23d St. S. Nawdascher, Pres., 3328 Ave. H. E. T. Chester, C. & F. S., 3209 Ave. I.
- 133—WATERLOO, IOWA.** Central Labor Hall, 2d-4th Wed. E. G. Pullen, Pres., 502 Columbia St. Geo. A. McMillan, C. S., 702 Barclay St.
- 134—MONTREAL, QUE., CAN.** 1st-3d Fri., Monument National, St. Lawrence and Main Sts. Stephen Craig, Pres., 1251 Mossier. R. Chorlton, C. S., 1184 Dolormier Ave.
- 135—CHILLICOTHE, O.** 1st-3d Mon., Flaecker Hall. L. J. Medert, Pres., 516 E. Water. Harry Rittinger, F. C. S., 339 S. Watt.
- 136—COLORADO CITY, COLO.** Red Men's Hall, 1st-3d Fri. H. J. Norton, Pres., care National Hotel. E. M. Allen, C. S., 1411 Colo. Ave., Colo. Springs, Colo. J. H. Cook, F. S., 216 N. 10th.
- 137—PADUCAH, KY.** 2d-4th Sun., Central Labor Hall, 123½ N. 4th. B. C. Beadles, Pres., 1029 Madison. Wm. Black, C. & F. S., 2040 Broad St.
- 138—HARRISON, ARK.** 4th Thurs. H. C. Henpard, Pres. John G. Call, C. & F. S.
- 143—KNOXVILLE, TENN.** 319 N. Gay St., 1st-3d Tues. J. D. Krause, Pres., R. F. D. No. 1. J. C. Stansbury, C. S., 411 W. Vine. W. D. Amanns, F. S., R. F. D. No. 12, Lincoln Park.
- 144—CEDAR RAPIDS, IOWA.** 1st-3d Wed., I. O. O. F. Hall, cor. 1st St. and 2nd Ave. W. Chas. T. Bowman, Pres., 816 El-His Blvd. Frank C. Schwarz, C. & F. S., 830 G Ave., W.
- 145—MISSOURI VALLEY, IOWA.** 1st-3d Thurs., Walker's Hall. Hans Witt, Pres., Box 181. Harvey Nichols, C. S.
- 148—VALLEJO, CALIF.** 1st-3d Tues., Vallejo Temple Hall. Wm. Fountain, Pres., 225A Penn. J. M. Kelly, C. S., 1008 York.
- 149—MARSHALLTOWN, IOWA.** 1st-3d Tues., Trades and Labor Assembly Hall, Main St. Chas. Vyskocial, Pres., 9 E. Boone. O. J. Saline, C. & F. S., 307 W. Boone.
- 150—CHAMPAIGN, ILL.** 1st-3d Sun., 2:30 p. m., I. C. System Fed. Hall. Thos. H. Monahan, Pres., 511 W. Washington St. A. E. Strode, C. S., 325 Hickory.
- 153—GASSAWAY, W. VA.** 20th of each month, Boone's Hall. J. E. Perkins, Pres., Little Otter, W. Va. C. S. Davis, C. & F. S., Gen. Del.
- 154—PITTSBURGH, PA.** 1st-3d Fri., Labor Temple, cor. Washington and Webster Ave. James Sause, Pres., Wabas Hotel, East Carnegie, Pa. Henry J. Thumel, C. S., 1218 Iltin St., N. S. L. H. Thumel, F. S., 1208 Haslage Ave., N. S. James P. Carr, B. A., Labor Temple, Wash. and Webster Ave.
- 155—BLOOMINGTON, ILL.** 1st-3d Mon., Redmen's Hall, Main and Front Sts. H. F. Lambrecht, Pres., 1004 N. Livingston St. L. J. Metzner, C. & F. S., 306 W. Chestnut.
- 161—BOONE, IOWA.** 1st-3d Mon., at Electrical Workers' Hall. Frank Whitman, Pres., 1603 Benton. H. W. Martens, C. & F. S., 1329 Meridan St.
- 163—HOBOKEN, N. J.** 2d-4th Fri., 500 Bloomfield St. Jeremiah Cahill, Pres., 38 Troy. F. L. Growney, C. S., 1019 Willow Ave.
- 165—DULUTH, MINN.** 2d-4th Sat., Irwin-Sloan Block, 20th Ave. and Superior St. James A. Graham, Pres., 5705 Grand Ave., W. Duluth, Minn. Alfred S. Nelson, C. & F. S., 5705 Grand Ave., W. Duluth, Minn.
- 169—DETROIT, MICH.** 2d-4th Thurs., 273 Gratiot Ave. Charles Komes, Pres., 31 Celaren. Chas. F. Aderholdt, C. & F. S., Swiven St.
- 170—RICHMOND, VA.** 1st-3d Wed., Labor Temple, 5th and Marshall Sts. R. L. King, Pres., 822 N. 26th St. F. C. Blount, F. S., 1101 N. 23d. E. M. Daywalt, C. S., 2208 Venable St.
- 173—RALEIGH, N. C.** B. F. Long, Pres., 218 N. McDowell. J. P. Taylor C. & F. S., 611 N. Saunders.
- 176—ELIZABETH, N. J.** 2d-4th Wed., Dahmen Hall, 4th and E. Jersey St. John H. Reynolds, Pres., 33 Delaware St. Samuel M. Rankin, Secy., 64 Florida. E. J. McCarthy, B. A., 67 St. Mark's Place, New York City.
- 179—DENVER, COLO.** 2d-4th Wed., Room 301 McPhee Bldg., 17th and Glenarm. Geo. Gauss, Pres., 3869 Newton. H. Shaffroth, C. & F. S., 3749 Wynkoop St.
- 180—MEMPHIS, TENN.** Italian Hall, 1st-3d Fri. E. C. Poore, Pres., 735 Arkansas Ave. Edward O'Brien, C. & F. S., 1226 S. Orleans St.
- 187—MIAMI, ARIZ.** Every Tues., Miami Hall. J. W. Landers, Pres. Frank E. Rock, C. & F. S., Box 1121.
- 191—VICTORIA, B. C.** 2d-4th Tues., 1424 Government St. Joe Lang, Pres., Esquimalt, P. O., B. C. A. Stewart, C. S., Box 48, Beaumont, P. O. Esquimalt, B. C.
- 193—BALTIMORE, MD.** Every Tues., Patterson Bldg., Baltimore and Gay Sts. John Shanley, Pres. James Chaney, F. S., 1419 Patapsca St. Phillip Yingling, C. S., 410 E. 37th St.

194—VANCOUVER, B. C., CAN-
ADA. 1st-3d Mon., at Labor
Temple.
A. Campbell, Pres., 17th Ave.,
West Vancouver.
A. Fraser, C. S., 1151 Howe St.
195—KEWANEE, ILL. 1st-3d
Fri., O'Donnell's Hall, 3d St.
A. M. Powers, C. S., 614 Beach.
197—ALBANY, N. Y. 31 Green
St., 2d-4th Sat.
J. H. Sullivan, Pres. & B. A., 173
3d St.
Jno. J. Leamy, C. S., 68 Living-
ton Ave.
198—ODDEN, UTAH. 2d-3d
Tues., Union Labor Hall on
24th St., bet. Washington and
Grant.
F. S. Dunn, C. & F. S., 116 23d St.
199—HORTON, KAN. 2d-4th
Mon., Carman's Hall.
E. J. McCarty, Pres.
E. S. McGinnis, C. & F. S., Box
622.
200—STATEN ISLAND, N. Y.
I. O. G. T. Hall, W. Brighton,
E. L. N. Y., 3rd Mon.
Robt. Duthie, Pres., 74 Simonson
Ave., Ft. Richmond, S. I. N. Y.
Ethan A. Johnson, C. S., 208
Broadway, W. Brighton S. I.,
N. Y.
E. McCarty, B. A., 67 St. Mark's
Place, N. Y. City.
201—WINONA, MINN. Labor
Temple, 1st-3d Tues.
Frank Rice, Pres., 574 W. 7th St.
W. Kukowski, C. S., 176 Mankato
Ave.
J. H. Buchholtz, F. S., 251 E.
King.
204—HONOLULU, H. I. Waverly
Hall, 2d-4th Thurs.
Frank Esman, Pres., Majestic Hot-
tel.
Wm. H. Lane, C. & F. S., 900C
Kanoa Lane.
205—SAN FRANCISCO, CALIF.
2d-4th Tues., Rosch Hall, 15th
and Mission.
Wm. P. Bowser, Pres., 507 20th.
J. M. Enright, C. S., 1431 Delores.
Walter Anderson, F. S., 607 And-
over.
Wm. P. Bowser, B. A., 314 14th.
206—ALGIERS, LA. 2d-4th Fri.,
Renecky Hall.
Jos. Koenig, Pres. & C. S., 825
Elmira Ave.
C. A. Reynolds, F. S., McDonogh-
ville, La.
207—WALNUT SPRINGS, TEX.
E. P. Jones, Pres.
C. W. Leigen, C. & F. S.
209—DENISON, TEXAS. 2d-4th
Mon. over State Nat. Bank.
A. McDowell, Pres., 504 W. Ow-
ings St.
S. E. Harris, C. & F. S., 923 W.
Morgan St.
216—EL PASO, TEXAS. 2d-4th
Thurs., 215 S. Stanton.
F. E. Perry Pres., 3018 Wyoming.
Frank H. Balt, C. S., 206 S. Stan-
ton St.
220—CHICAGO, ILL. 2d-4th
Tues., Pusey's Hall, 901 E. 75th.
Thos. P. Smith, Pres., 315 W. 51
Place.
A. G. Smith, C. & F. S., 7036 Har-
per Ave.
221—PITTSBURG, KAN. 1st-3d
Tues., Red Men's Hall, W. 3d St.
E. E. Hiett, Pres., 1803 N. Grand
Ave.
P. J. Hiett, C. S., 1801 N. Grand.
222—MART, TEXAS. W. O. W.
Hall.
E. J. Blount, Pres.
G. W. Coates, C. & F. S.
223—UTICA, N. Y. Labor Tem-
ple, 2d Fri.
Louis Wenzert, Pres., 8 Willey St.
Edward Wenzert, C. S., 43 Fass
Ave.
225—ELMIRA, N. Y. 2d-4th Sun.,
Trades & Labor Hall, 200 E.
Water St.
A. E. Stevenson, Pres., 944 McGee.
N. P. Durnin, R. & C. S., 519 Penn
Ave.

226—SALISBURY, N. C. W. O.
W. Hall, Innes and Main Sta.,
1st-3rd Fri.
J. J. Garvey, Pres., E. Spencer,
N. C.
P. P. Surratt, C. & F. S., Box 278,
Spencer, N. C.
227—CHICAGO, ILL. Garfield
Park Hall, 4039 W. Madison St.
2d-4th Sat.
John Seldon, Pres., 1107 Keeler
Ave.
Thomas Dean, F. & C. S., 2214 W.
18th St.
229—ROCHESTER, N. Y. 2d-4th
Wed., 14 N. Water St.
W. Weston, Pres., 17 Coffrey
Place.
Robt. Little, C. S., 211 Garfield.
233—OAKLAND, CAL., 2d-4th
Mon., cor. 7th and Feralta Sta.
H. Brown, Pres., 1003 Pine St.
Geo. Young, C. S., 1788 9th St.
235—COLUMBIA, S. C. 2d-4th
Tues., Plumbers' Hall, 1623
Main St.
T. W. Mooney, Pres., 923 Wallace.
J. M. Frick, C. S., 3405 Central
Ave., Colonial Heights.
236—MARQUETTE, MICH. 4th
Thurs., E. Seigle's Hall.
Albert Bastien, Pres., 347 West
Washington.
Arthur Bourgols, C. S., 817 North
3d St.
237—HARTFORD, CONN. 2d-4th
Wed., at C. L. U. Hall, Central
Row.
James Thornton, Pres., 52 Green.
John J. Reilly, C. S., 46 Pliny.
238—CLIFTON FORGE, VA. 1st-
3d Fri., Junior Hall.
A. J. Hauer, Pres., 34 Alleghany.
M. L. Steinhuck, C. & R. S., Box
334.
D. G. Clark, F. S., 192 Ridge-
way.
239—ROCKY MOUNT, N. C. 1st-
3d Mon., Machinist Hall, cor.
Sunset and Main Sts.
G. T. Mathews, Jr., Pres., 620 S.
Church.
J. S. Wakefield, C. S., Box 224.
H. L. Moore, F. S., 127 Pearl.
241—WASHINGTON, IND. Zin-
kin's Hall, 3d and Vantress
Sts., 1st-3d Tues.
J. C. Mooney, Pres., East George.
M. W. Luke, C. & F. S., 1097 W.
Main.
242—SPOKANE, WASH. 2d-4th
Wed., Carpenters' Hall, No. 9
Madison St.
Frank Depender, Pres., 611 E.
Indiana Ave.
R. L. Mason, C. S., 213 S. Pitts-
burg St.
243—BELLEFONTAINE, O. Last
Sunday in each month, Eagles'
Hall.
H. S. Dickenson, Pres., 329 Gar-
field.
R. E. McNeff, C. & F. S., 105 N.
Elm.
244—SIOUX CITY, IOWA. 3d
Wed., Motor Mart Bldg.
John Ewing, Pres., 103 Alice St.
Robt. O'Hern, C. S., No. 5 14th.
245—CONCORD, N. H. 2d-4th
Mon., Central Labor Union Hall.
Geo. Tanner, Pres., Hall St.
J. J. Berryman, C. S., 2 Home Ave.
J. R. New, F. S., 120 Broadway.
246—TERRE HAUTE, IND. Cor.
8th and Wabash Ave., 1st-3d
Tues.
H. M. Showalter, Pres., 1410 S.
17th.
Jesse Dukes, C. S., 1561 S. 18th.
F. Wittke, F. S., 1709 N. 12th.
247—TACOMA, WASH. 1st - 3d
Mon., Odd Fellows' Hall, S. Tac-
coma.
Andrew Hansen, Pres., 5406 So.
Paks St.
Wm. Polzina, C. & F. S., 1727 So.
56.

248—HUNTINGTON, W. VA. Sw-
ery Wed., Thompson Bldg., cor.
20th St. and 3d Ave.
J. S. Myers, Pres., 2720 Collis Ave.
Eugene Brennan, C. & F. S., 833
23d St.
A. E. Pring, B. A., 1812 12th Ave.
250—BOSTON, MASS. Hollis Hall,
724 Washington St., 1st-3d Fri.
James Downey, Pres., 8 Cathed-
ral.
Jeremiah Murphy, C. S. & B. A.,
107 Union Park St.
J. F. Neas, F. S., 1177A Tremont
Roxbury, Mass.
254—CHICAGO HEIGHTS, ILL.
1st-3d Mon. at Trades & Labor
Assembly Hall, West End Ave.
Thomas Hines, Pres., 1656 West
End Ave.
Thomas Brooks, C. & F. S., 306
W. 15th Place.
258—LIMA, OHIO. 2d-4th Thurs.
334 No. Main.
A. K. Griesheimer, C. S., 329 N.
Elizabeth.
Harry Gunn, F. S., 713 W. Met-
calfe.
265—SMITHVILLE, TEXAS. 1st-
4th Mon.
M. C. Vaughn, Pres., P. O. Box
521.
Guy Hooper, C. & F. S., P. O.
Box 356.
267—MOBERLY, MO. 2nd and 4th
Thurs., Painters' Hall.
J. J. Cadagin, Pres.
F. R. Lee, C. S., 601 Monroe Ave.
269—PASCO, WASH. 1-3d Wed.
212 Second St.
F. E. Girton, Pres., 407 N. 6th.
W. H. Warwick, C. & F. S., Gen.
Del.
276—ST. LOUIS, MO. 2d-4th Fri.
N. E. Cor. 11th and Locust.
Herbert Abbey, Pres., 2613 Ann Av.
Henry Waeckerle, C. S., 2919A Mi-
ami.
Max Groth, F. S., 4874 Kings
Highway, N. E.
278—ELKINS, W. VA. 2d-4th
Thurs., Kendall Hall.
Geo. Cade, Pres., 620 Yokem.
C. H. Goodwin, C. & F. S., 3 Ceas-
ter St.
279—EDMONTON, ALB. CAN. 1st
Mon., Calder, Edmonton.
Wm. J. Fitzmaurice, Pres., Box
2100, of E. D. & B. C. Ry.
James McLean, C. & F. S., 10236
113th St.
281—NORWOOD, MASS. 2d-4th
Fri., 724 Washington St., Bos-
ton.
Amos Bennett, Pres., 130 Dart-
mouth, Boston, Mass.
Robert Henderson, C. S., 274 Met-
ropolitan Ave., Roslindale, Mass.
284—FREEPORT, ILL. 1st Sun.
at Blust Hall.
C. J. Pontius, Pres., 26 Park Ave.
Earl Barth, Secy-Treas., 1334 20th
Ave., Rockford, Ill.
286—FORT SCOTT, KAN. 1st-3d
Mon., Redmen's Hall, 111 E.
Wall St.
J. W. McNowa, Pres., 816 Marion
Ave.
J. C. Bonesteel, C. S., 1213 So.
National.
287—KINGSVILLE, TEXAS.
M. H. Nicholson, Pres., Gen. Del.
F. C. Martin, C. S., Box 162.
290—BREMERTON, WASH. 3d
Tues., Hunter & Daily Bldg.,
Pacific Ave.
Percey Counter, Pres., Box 272,
Charleston, Wash.
John Hornby, C. & F. S., Gen.
Del.
292 — PARSONS, KAN. 2d-4th
Tues., Moose Hall.
Frank Thompson, Pres., 2318
Crawford.
E. P. Butler, C. S., 1721 Gabriel.
293—SHAWNEE, OKLA. 2d-4th
Mon., Moose Hall.
Floyd Ott, Pres., 639 N. Boll.
A. D. Ross, C. & F. S., 459 N.
Park Ave.

- 226—PORTSMOUTH, VA.** C. L. U. Hall, 2d-4th Thur.
M. A. Garris, Pres., 2226 King.
H. W. Jarrett, F. S., 1322 County.
Robt. T. Howe, C. S., 826 4th St.
- 290—WATER VALLEY, MISS.** I. O. O. F. Hall, 1st-3d Thur.
C. H. Baker, Pres. and Treas.
- 301—CANTON, OHIO.** 1st-3d Mon., Switzer Hall, Cherry and 8th Sts.
Joe Patch, Pres., 1119 5th St., N. E.
E. J. Gussett, C. & F. S., 1202 McKinley Ave., S. W.
- 302—MILWAUKEE, WIS.** 1st-3d Sat., Lipp's Hall, 3d and Prairie.
Henry J. Murray, Pres., 113 29th
Hugh J. Fuller, C. S., 406 30th
John DuBrucq, F. S., 317 1/2 4th Ave.
John L. Callahan, B. A., 3606 Clifton Ave.
- 305—FORT ARTHUR, TEXAS.** 2d-4th Tues., Labor Hall.
C. L. Bragg, Pres., Gen. Del.
T. O. Riley, C. S. & B. A., Box 683.
James Rose, F. S., Box 8.
- 306—EVANSTON, WYO.** I. O. O. F. Hall, 1st-3d Wed.
John T. Whittle, Pres., County Road.
- J. H. Willoughby, C. S., Box 419.**
- 311—SOUTH KAUKAUNA, WIS.** 2d-4th Mon., Odd Fellows' Hall, Louis Crever, Pres.
Chas. Robedeau, C. & R. S., P. O. Box 279.
- 312—SELMA, ALA.** 1st-3d Wed., at R. R. Y. M. C. A.
J. F. Ryals, Pres.
W. P. Fawcett, C. S., 1509 Selma.
- 315—McCOMB, MISS.** Central Trade and Labor Hall, 1st-3d Wed., at 7:30.
R. O. Bean, Pres. & C. S., Box 684.
- 317—RICHMOND, CALIF.** 2d-4th Fri., Barnman's Hall, 19th St.
Frank Mallinson, Pres., care Randall Hotel.
Wm. Jones, C. & F. S., Box 634.
- 318—PITTSBURGH, PA.** 1st-3d Mon., Hazlewood Bank Bldg., cor. 2d and Hazlewood.
W. Mertz, Pres., Path Alley.
T. A. Hudson, F. S., 310 Johnston Ave.
- 320—MERIDAN, MISS.** B. L. E. Hall, 5th St. and 40th Ave., 1st-3d Thurs.
J. A. Smitheren, Pres., 511 40th Ave.
J. E. Alexander, C. & F. S., 3817 35th St.
- 322—ST. LOUIS, MO.** 1st-3d Tues., Reddy Hall, 3100 Chau-teau
John Coats, Pres., 2726 Wash-ington Ave.
W. J. Tinell, C. S., 812 Atlantic, Webster Grove, Mo.
- 323—CHICKASHA, OKLA.** 2d-4th Fri., Labor Hall, 4th and Choctaw.
C. A. Chincholl, Pres., P. O. Box 502.
W. L. Harkins, C. & F. S., 528 S. 15th St.
- 325—SHREVEPORT, LA.** K. of P. Hall over West End Drug Store, 2d-4th Thurs.
H. Abbott, Pres., 1542 Luchina Ave.
- H. W. Huff, C. S., 1863 Texas Ave.**
- 327—CUMBERLAND, MD.** 1st-3d Mon., Odd Fellows' Hall.
C. C. Bowen, Pres., 107 W. 1st.
Geo. H. Little, C. S., 401 E. 1st.
J. R. Beck, F. S., 106 W. 1st.
- 333—PARKERSBURG, W. VA.** Bricklayers' Hall.
Walter Barby, Pres., 120 6th
B. E. Robinson, C. & F. S., Al-media St.
- 334—PRINCETON, IND.** 2d-4th Tues., Redmen's Hall.
Joe Myers, Pres., 1101 S. Race.
Fred Day, C. S., 617 Gibson.
- 335—GRAND JUNCTION, COLO.** 2d-4th Fri., Eagles' Hall.
G. R. Stoll, Pres., 327 White.
E. H. Friend, C. & F. S., 303 Pitkin Ave.
- 339—SPARKS, NEV.** 2d-4th Wed., Engineers' Hall.
Wm. Daseier, Pres., P. O. Box 214.
C. E. Crouch, C. S., P. O. Box 204.
- 340—HERINGTON, KAS.** 1st-3d Sat., I. O. O. F. Hall.
John Olson, Pres.
J. E. Anderson, C. S., 303 N. 8th.
- 341—PHILADELPHIA, PA.** 2d-4th Tues., 8 p. m., Labor Head-quarters, 232 N. 9th St.
Wm. J. Boyle, Pres., 208 N. 58th St.
Chas. Heberly, C. S., 3084 Aramin-go Ave.
- 344—SHEFFIELD, ALA.** 1st-3d Wed., at I. O. O. F. Hall, Mont-gomery Ave.
W. H. Wilson, Pres., Tuscumbia, Ala.
E. T. Holland, C. S., Box 65.
- 345—SAN ANTONIO, TEXAS.** Trades Council Hall, 2d-4th Thurs.
F. E. Hamilton, Pres., 2103 W. Travis.
E. H. Frick, C. & F. S., 1233 W. Traves Ave.
Delrympel, B. A., 410 River Ave.
- 346—TRENTON, MO.** 1st-3d Tues., at Cutlip's Hall.
Walter Mason, Pres., 1726 Lula Ave.
Geo. W. Singer, C. & F. S., 1801 Maine St.
- 354—BROOKFIELD, MO.** 1st-3d Tues., 212 N. Main St.
Martin Murphy, Pres., 291 Elm St.
J. K. Burnham, C. S., 529 S. Living
- 355—CONNEAUT, OHIO.** 2d-4th Fri., Stationary Eng. Hall, Main St.
Chas. Ward, Pres., 685 Lakeview Ave.
W. J. Brockett, C. S., 539 Blair.
E. J. Dickson, F. S., 815 Main.
- 356—HAMMOND, IND.** 1st-3d Wed., Long's Hall, State St.
James Boyle, Pres.
Thomas Boyle, C. S., 264 State-line St.
- 360—LAFAYETTE, IND.** 1st-3d Thurs., Bartenders' Hall, 3d and Ferry Pt.
Fred Ramp, Pres., 1601 N. 12th.
Wm. Peterson, C. S., 426 Lingle.
James Goldsberry, F. S.
- 363—EAST ST. LOUIS, ILL.** 1st-3d Fri., Barry Hall, Collensutte and Ohio Ave.
Louis Wolf, Pres., 613 So. 8th
John Roche, C. S., 833 N. 8th.
- 367—HAVRE, MONT.** 3d Sat., Oxford Hall.
- 369—ALEXANDRIA, VA.** 1st Thur. in month during sum-mer months, 108 N. Patrick St.
R. B. Craddock, Pres., 809 Cam-eron.
M. Gemeny, R. & F. S., 1305 Prince.
- 371—LOWELL, MASS.** 2d-4th Wed., 32 Middle St.
James Lanigan, Pres., 48 Blossom.
J. J. Cunningham, C. S., 656 Gor-ham.
- 377—MOLINE, ILL.** 1st-3d Fri., Moline Industrial Home, cor. 14th St. and 5th Ave.
Carl Robison, Pres., 7th St., Sil-vis, Ill.
John Fulton, F. S., 7th St., Sil-vis, Ill.
- Charles McGowan, B. A., 7th St., Silvis, Ill.
C. R. Kiser, C. S., Box 581, Silvis, Ill.
Walter S. Schneider, B. A., 1317 28th St., Rock Island, Ill.
- 378—MONTON, N. B., CAN.** 2d-4th Fri., Sons of Temper-ance Hall.
Alex McDougall, Pres., 143 High St.
R. D. Donnelly, C. S., 69 Down-ing St.
- 379—McADAM JUNCTION, N. B., CAN.** 2d-4th Fri., Orange Hall.
Geo. Guest, Pres.
A. J. McLaggan, C. S.
- 381—AMARILLO, TEXAS.** 1007 Buchanan.
M. L. Parker, Pres., Box 407.
Joe Wilson, C. S., 1007 Buchanan.
- 382—CHILDESS, TEXAS.** 2d-4th Fri., at 7:30 p. m., in Labor Temple.
Mack Leopold, Pres., P. O. Box 835.
J. M. Neal, C. S.
- 384—PERU, IND.** 2d-4th Tues., Labor Trades Hall.
Floyd W. Seitz, Pres., 164 N. La-fayette.
A. W. Johnson, C. & F. S., 67 N. Lafayette.
Frank Sullivan, B. A., 133 W. 3d.
- 388—MECHANICSVILLE, N. Y.** 2d and last Tues., A. O. H. Hall, North Main St.
James S. Kennedy, Pres., S. Sec-ond Ave.
Thos. F. Baldwin, C. S., 28 Rail-road.
Chas. Chapman, F. S., 112 N. 2d.
- 390—TRINIDAD, COLO.** 2d-4th Wed., Labor Union Hall, East Main St.
W. F. Flynn, Pres. and C. S., 915 Arizona Ave.
- 391—DAVENPORT, IOWA.** 2d-4th Fri., Danish Hall.
John Schach, Pres., 516 1/2 W. 3d.
R. F. Stewart, C. S., 738 E. 9th.
W. C. Richards, F. S., 1938 Bridge Ave.
- 392—CALGARY, ALBERTA, CAN.** 3d Sat., 2:30 p. m., Labor Tem-ple.
J. Chambers, Pres., Ogden, P. O. Perry, Willis, C. S., 1614 11th Ave.
- 393—GOODLAND, KAS.** 1st-3d Tues., Calvert & Sparks' Law Office.
S. E. Braffet, Pres.
John Maher, C. & F. S.
- 395—NORTH FOND DU LAC, WIS.** 1st-3d Fri., Trades and Labor Hall, cor. 3d and Main.
Carl Deyer, Pres., 615 Michigan Ave.
Jos. A. Hautzinger, C. S., 223 E. Johnson, Fond du Lac, Wis.
- 396—NORWICH, N. Y.** 4th Wed. in Cook Block.
James E. Callahan, Pres., 1 Co-lumbia St.
Julius Schraft, C. & F. S., 13 Davis.
- 398—RIVIERE DU LOUP, QUE-BEC, CANADA.** 2d-4th Mon., Rioux Hall.
Mak. Bourgoin, Pres., River du Loup Station.
Jos. Beaulieu, B. A., Blaisville.
Ludger Oullet, C. & F. S., Blais-ville.
- 400—MIDDLETON, N. Y.** 1st-3d Fri., Odd Fellows' Hall.
Wm. Springer, Pres., 55 Beattie Ave.
Wm. E. Appel, F. S., 378 North.
Chris Smith, C. S., 381 North St.
- 402—PORTSMOUTH, OHIO.** 2d-4th Fri., C. L. U. Hall.
R. L. Johnson, Pres., 2949 Galla.
E. L. Wilson, F. S., 1721 6th St.
Wm. H. Miller, C. S., 1411 Grand-view Ave.

- 403—HOISINGTON, KAS. I. O. O. F. Hall, 1st-3d Mon.
Ray Bowler, Pres., P. O. Box 73.
C. W. Cramer, C. & F. S., Box 494.
- 405—BLUEFIELD, W. VA. 1st-3d Fri., Masonic Temple.
E. K. Collins, Pres., Princeton Ave. E.
W. F. Dupree, C. & F. S., Gen. Del.
406—CLARKDALE, ARIZ.
Carl Reibnan, C. S., Box 191.
- 410—SAN FRANCISCO, CAL. 2d-4th Wed. Labor Temple, 16th and California.
Ed Hanny, Pres., 2217 Howard
L. Kevie, C. S., 208 Springdale Ave.
- 418—ST. THOMAS, ONTARIO, CAN. 2d-4th Tues., Machinists' Hall, Talbot St.
Frederick Brooks, Pres., 5 Maama
Frank Roberts, C. S., 61 Wilson
- 414—ONEONTA, N. Y. 1st Wed. and 3rd Sun., 2:30 p. m., Redmen's Hall.
James Walsh, Pres., 51 Church.
David Lawrie, C. & F. S., 73 W. Broadway.
- 415—JACKSONVILLE, ILL.
F. McKenna, C. S., 475 E. State.
- 417—NORTH BAY, ONT., CAN. 2d-4th Mon., L. O. L. Hall.
A. E. Lye, Pres., Box 799.
Fred S. Gardner, C. & F. S., Box 1262.
- 418—NEODESHA, KAS. 1st-3d Sat., Baldwin Hall.
Chas. Brown, Pres.
E. P. Reddick, C. S., 1007 Iowa.
A. F. Wingham, B. A.
- 419—SOMERSET, KY. 1st-3d Tues., at Owen's Hall.
W. C. Williams, Pres.
J. S. Arnold, C. & F. S., Sta. A.
- 421—HAMILTON, ONT. 1st-3d Fri., Labor Hall, John St. So.
L. Lawton, Pres., No. 31 Tuckett.
F. Honison, C. & F. S., 6 Bristol.
- 422—SANFORD, FLA. 3d-4th Wed., Eagles' Hall.
H. B. Purden, Pres.
Geo. Randall, C. & F. S., Box 1194.
- 423—BIG SPRINGS, TEX. 2d-4th Tues., I. O. O. F. Hall.
D. D. Crawford, Pres., cor. Gregg and 3d.
W. P. Warren, C. & F. S., 201 W. 1st.
- 424—FLORENCE, S. C. 2d Thurs., Y. M. C. A.
L. H. Mims, Pres., 222 Covington St.
A. H. Dickman, C. & F. S., 609 Day St.
- 425—WAYCROSS, GA. 1st-3d Thurs., Loot Hitch Bldg.
C. M. Schultz, Pres., 37 Stephens Ave.
L. J. Flohr, C. & F. S., Box 236.
- 427—SALIDA, COLO. 2d-4th Thurs., McCollough Hall.
Wm. M. Adams, Pres., 506 E 3d.
Wm. Dargavel, C. & F. S., 821 E.
- 428—NORFOLK, VA. 2d-4th Wed., Pythian Castle Hall.
W. M. Wood, Pres., 617 Liberty St., Berkeley, Va.
Thos. Callahan, C. & F. S., 116 Middleton St., Berkeley, Va.
- 430—CAPE GIRARDEAU, MO. 1st-3d Tues., Haas' Hall.
Geo. Stanley, Pres., 223 Frederick St.
Oscar O. Berry, F. S., 415 S. Frederick St.
- 431—BOSTON, MASS. 2d Thurs., Naomi Hall, 724 Washington.
Thos. E. Keenan, C. S., 80 W. 5th St., So. Boston.
- 434—CHICAGO, ILL. 2d-4th Tues., Marquette Hall, 6650 Halstead St.
H. Fischer, Pres., 6438 Sangamon.
Edward Osborn, C. S., 48 E. 43d St.
- 435—BRISTOL, TENN. 2d-4th Fri., Sixth and Shelby Sta.
M. C. Cooper, Pres., V. & S. W. Ry. Shops.
J. B. Wood, C. & F. S., 27 Lancaster S., Bristol, Va.
- 436—COLUMBUS, GA. 1st-3d Fri., Trades and Labor Assembly Hall.
R. S. Barry, Pres., 911 4th Ave.
E. W. McMichael, C. & F. S., 1105 21st St.
- 437—TWO HARBORS, MINN. 2d and last Thurs., Iron Dock Grove Hall.
Christ. Anderson, Pres.
Charles Larson, C. & F. S., Box 298.
- 438—GALETON, PA. 2d-4th Tues., Eagles' Hall.
J. M. Parker, C. S., 10 Williams St.
- 439—FAIRBURY, NEB. 4th Wed., K. of L. S. Hall.
B. Z. Milliken, C. & F. S., P. O. Box 167.
Fred Kurat, B. A.
- 440—BELLE PLAINE, IOWA. 2d-4th Mon., Fireman's Hall.
Charles Corns, Pres., 10th St.
Warren Wheeler, C. S., P. O. Box 605.
- 442—NEW ORLEANS, LA. 3d Tues., McMahon Hall, 1112 Drades.
James Miller, Pres., 1204 So. Franklin.
John Mocklin, C. & F. S., 606 S. Telemachus St.
- 444—CONNELSVILLE, PA.
J. W. Easley, C. S., 517 N. Pgh.
- 440—ALAMOSA, COLO. 2d-4th Wed., Trades Assembly Hall.
Albert Jacobson, Pres.
Chas. F. Darling, C. S., Box 64.
- 447—DECATUR, ILL. 1st-3d Tues., Ashley Hall, Mason Temple.
Jas. Gray, Pres., 817 N. Broadway.
Chas. J. Younger, C. & F. S., 432 E. King St.
- 448—MONTGOMERY, ALA. 1st-3d Wed., Young's Hall.
J. A. Redding, Pres., 316 Columbus.
E. J. Ford, C. S., 75 Morgan Ave.
- 449—SAPULPA, OKLA. 3d-4th Mon., Moose Hall.
M. E. Lange, Pres., 913 E. Hobson.
Victor Edwards, C. S., Gen. Del.
- 450—WASHINGTON, D. C. 2d-4th Wed., New Masonic Hall, 8th and F Sts., N. E.
A. W. Sherler, Pres., 106 15th S. E.
W. F. Kilroy, C. S., 817 N. Capitol.
- 451—WINNIPEG, MAN., CAN. 3d Fri., Labor Temple.
D. Nelson, Pres., 469 Hetherington Ave.
F. Snare, C. & F. S., 263 Bradford St., St. James.
- 458—COPPERHILL, TENN. 1st-3d Tues., I. O. O. F. Hall.
Chas. Frenz, Pres., Box 711.
E. N. Hall, C. S., Box 382.
- 454—CHICAGO, ILL. 2d-4th Thurs., Percy Hall.
Walter Love, Pres., 752 E. 69th St.
E. R. Dettmer, C. S., 9245 Stonely Island Ave.
- 458—SHERMAN, TEXAS. 2d-4th Thurs., Machinists' Hall.
W. K. Murray, Pres., Tucket Ave.
John Plexco, C. & F. S., 424 Gribble Ave.
- 463—BALBOA, CANAL ZONE, PANAMA. 1st-3d Fri., Ancon Lodge Hall.
A. R. R. Charters, Pres., Carozal, C. Z.
W. H. Keenan, C. & F. S., Box 76, Balboa, C. Z.
- 464—PALESTINE, TEXAS. Labor Temple, 2d-4th Wed.
J. S. Guinn, Pres., 635 Tenn. Ave.
J. D. Mallette, C. & F. S., P. O. Box 133.
- 466—REVELSTOKE, B. C. 2d Sat., Bellirk Hall.
M. M. Keller, Pres., Box 132.
A. McMahon, C. S., Box 138.
- 467—PORTSMOUTH, N. H. 2d Wed., Eagles' Hall.
John Quinn, Pres., Court St.
Alfred Olson, C. S., Box 37, Kittery, Me.
- 469—TERRELL, TEXAS. 2d-4th Fri., Trades and Labor Hall, 202 E. Moore Ave.
J. R. Poston, Pres., 608 E. College St.
R. E. O'Reilly, C. S., 906 E. Moore Ave.
- 471—CRISTOBAL, C. Z. 2d-4th Thurs., Canal Lodge Hall.
Alexander McKenzie, Pres.
Jas. Z. Knapp, C. & F. S., Box 219.
- 473—HELPER, UTAH. 1st-3d Wed., K. of P. Hall.
Alf Ovall, Pres.
E. W. Smith, C. & F. S., Box 411.
- 475—GRAND ISLAND, NEB. 1st-3d Mon., City Hall, 3d St.
H. W. Hunt, Pres.
Sherman Aldrich, F. S., 1014 E. 4th St.
- 476—DALHART, TEXAS. 3d Fri., Socialist Hall.
H. C. Fritche, Pres.
Theo P. Nelson, C. & F. S., Box 282.
- 478—MOOSE JAW, SASKATCHEWAN, CANADA. 2d-4th Mon. Trades and Labor Hall, Main St.
Wm. Gillies, Pres., 364 Fairford St., W.
W. G. Vaughan, Secy.-Treas., Box 352.
- 479—DEVIL'S LAKE, N. DAK. 1st Fri., Opera House Hall.
- 481—LYNDONVILLE, VT. 1st-3d Wed., Eaton's Hall.
E. A. Hinds, Pres.
E. A. Phillips, C. & R. S.
J. M. Bresson, B. A.
- 482—ALTON, ILL. Schwartzbeck Hall, 3d and Ridge. 1st-3d Tues.
D. Stafford, Pres., 1009 E. 5th St.
Robt. Dale, C. & F. S., Gen. Del. Sub. Sta., Upper Alton.
- 485—GREEN BAY, WIS. 1st-3d Thurs.
John Christianson, Pres., 323 E. Maple Ave.
John Slater, C. & F. S., 425 5th St.
J. L. Callahan, B. A., 3606 Clifton Ave., Milwaukee, Wis.
- 486—TYLER, TEXAS. 1st-3d Wed., K. O. T. M. Hall.
J. A. Fuller, Pres., 1116 Irvin.
J. M. McCarty, C. & F. S., 216 Center Ave.
C. R. Welch, B. A., 1423 N. Fannie Ave.
- 491—VALLEY JUNCTION, IOWA. 1st-3d Tues., I. O. O. F. Hall.
Frank S. Hoppe, Pres.
J. C. Carroll, C. S., Box 165.
Geo. W. Pring, B. A., Treas.
- 493—NEW CASTLE, PA. Jan. 13, 1915, and every other Wed., Trades Assembly Hall.
D. E. Sturdevant, Pres., 516 Waldo.
David Lewis, C. & F. S., 428 Galbreath Ave.
- 494—WILMINGTON, DEL. 2-4 Wed., Odd Fellows Hall, 3d & King Sts.
James Struthers, Pres., 303 West St.
Chas. P. Mousley, C. S., 511 W 3d.
- 495—HATTIESBURG, MISS. 1st-3d Tues., 500 Boule St.
C. W. LeBlanc, Pres., 107 Evans.
A. H. Waddell, C. & F. S., 500 Boule.
- 496—HURON, SOUTH DAKOTA. 2d Sun. and 4th Fri., Labor Hall.
Peter Paluszak, Pres.
C. Storkson, C. & F. S., 225 Beach St.

500—EVERETT, WASH. 3d-4th Tues. Labor Temple, 3506 Everett Ave.

501—WACO, TEXAS. 2d-4th Fri. Labor Hall.
Chas. Bullock, Pres., R. F. D. No. 2.
Wm. Dickerson, C. & F. S., 514 N. 15th.

502—TEAGUE, TEXAS. 1st-3d Mon. Davis Hall.
T. H. Pique, Pres., Gen. Del.
O. D. Clayton, C. S., 309 N. Grant.

503—FITZGERALD, GA. 1st-3d Wed., I. O. O. F. Hall.
M. J. Mauns, Pres., P. O. Box 636.
A. B. Campbell, C. S.

504—MUSKOGEE, OKLA. 1st-3d Wed., Carpenters' Hall.
Guy Carver, Pres., 1220 Baltimore.
W. H. Hannaford, C. & F. S., Gen. Del.

505—FORT WILLIAM, ONTARIO, CAN. 1st-3d Fri., Electricians' Hall, Murphy Block, Simpson Ave.
James Duncan, Pres.
A. Cruickshank, C. S., 1007 Minn. Ave.

507—ATCHISON, KAS. 1st-3d Mon. Fireman's Hall, 1521 Main St.
J. F. Coyle, Pres., 1418 Kansas Ave.
John J. Freibott, C. & F. S., 1420 Kansas Ave.

508—JACKSON, OHIO. 4th Tues. Hibernian Hall.
O. B. Reynolds, Pres., 77 High St.
Albert Edmonds, C. S., 76 Vine.
J. B. Fillingier, B. A. and Journal Cor., 53 Main St.

510—CEDARTOWN, GA.
E. M. Kendricka, Pres.
I. C. Smith, C. S.

511—WHISTLER, ALA. 1st-3d Mon., I. O. O. F. Hall.
J. B. Chestang, Pres.
C. C. Crone, C. S., 209 Bauregard, Mobile, Ala.

515—EAST CAMBRIDGE, MASS. Engineers' Hall, 104 Canal St., Boston, Mass., 1st-3d Fri.
Geo. L. Parks, Pres.
John P. Grant, C. & F. S., 124 Spring St.

517—GREENFIELD, MASS. 2d-4th Sat., Forester Hall.
Patrick Kelley, Pres., 3 Devens.
Tim Scannell, C. & F. S., 6 Russell St.

518—WICHITA, KAS. 1st-3d Thurs., 216 N. Main St.
G. W. Thompson, Pres., 2127 University Ave.
O. E. Maze, C. S., 1415 W. Maple.

520—MILES CITY, MONT. 2d-4th Fri., Wilboux Hall, 7th and Main.
P. J. Gallagher, Pres., 602 N. Lake St.
Chas. E. Cook, C. & F. S., 119 N. Strevelle.

521—VAN BUREN, ARK. 1st-3d Tues., Federation Hall.
Hal. Stack, Pres.
C. Montgomery, C. S., Box 343.
C. A. McDonald, B. A., 4416 Norledge, Kansas City, Mo.

522—EL RENO, OKLA. 1st-3d Tues., Redmen's Hall.
H. E. Hart, Pres., Box 624.
H. A. Mathews, C. & F. S., Box 12.

523—PRATT, KAS. 2d-4th Tues., at S. T. Sample's residence.
W. F. Stephen, Pres., 624 N. Ninircah St.
F. W. Sharpe, C. S., Box 73.

524—MURPHYSBORO, ILL. 2d-4th Wed., Machinists' Hall, 107 S. 10th.
A. R. McFarland, Pres., 638 N. 3th.

E. P. Herin, C. & F. S., 2107 Wall.

525—HINTON, W. VA. 1st-3d Mon., Big Four Bldg.
W. L. Taylor, Pres., 108 Grace St.
C. L. Barnette, C. & F. S. & B. A., 419 Summer Ave.

528—DEER LODGE, MONT. 2d-4th Fri., I. O. O. F. Hall.
T. J. Messing, Pres.
J. H. Thomas, C. & F. S., P. O. Box 877.

529—WINNIPEG, MAN., CAN. 1st Sun., Campbell Hall, Transcona, 3rd Sun., Labor Temple, Winnipeg, 3 p. m.
A. Orr Pres., James St., East.
James Hawthorn, C. & F. S., 869 Boyd Ave.

530—SPRINGFIELD, MO. 3d Mon., Dengeldem's Hall.
J. W. Reddick, Pres., 817 Lincoln.
John Cain, C. & F. S., 507 Fort.
A. F. Bingham, B. A., 701 Lombard St.

531—CHAFFEE, MO. 1st-3d Thurs., City Hall.
T. C. Davis, Pres.
C. F. Bourlon, C. & F. S., Box 365.

537—COVINGTON, KY. 2d-4th Fri., Workman Hall, 122 Pike St.
A. J. Pope, Pres. & B. A., 1817 Scott St.
John J. Fielding, C. & F. S., 1842 Pearl.

541—BEDFORD, IND. 2d-4th Thurs., Labor Union Hall.
Dan J. Kane, Pres., 511 N. I St.
Frank McCann, C. S., 718 I St.

542—COFFEYVILLE, KAS. Labor Temple, 2d-4th Wed.
R. M. Jones, Pres., 807 W. 14th.
J. C. Morrow, C. & F. S., 613 W. 4th St.

543—WICHITA, KAS. 216 N. Main St., 2d-4th Wed.
C. E. Grove, C. & F. S., 701 W. Central.

546—MONETT, MO. 1st-3d Tues., K. C. Hall.
T. J. Moore, Pres., 706 Benton Ave.
John Linebarger, C. & F. S., 214 Pearl St.

547—CARBONDALE, PA. Pughanas Hall, 2d-4th Fri.
E. T. Dickenson, C. & F. S., 142 Wyoming.
Wilkes Barre Representative, T. J. Cavan, 60 Chester St., Wilkes Barre, Pa.

548—TORONTO, CAN. 2d-4th Wed., Labor Temple, Church Joseph P. Dobson, Pres., 280 Perth Ave.
John C. Walker, C. & F. S., 152 Gladstone Ave.

549—MIDDLEPORT, O. 1st-3d Tues., Firemen's Hall.
Lester Cunningham, Pres.
Perry Cooper, C. & F. S.

551—PRINCETON, W. VA. Castle Hall, 1st-3d Thurs.
J. H. Blackwell, Pres., Box 312.
J. J. Bowers, C. S., 516 Bluefield.

556—OKLAHOMA CITY, OKLA. C. S. Cochran, Pres., 406 W. Frisco.
C. H. Hendrix, C. S., 502 Chickasaw.

557—WILLIAMSON, W. VA. 2d-4th Tues., Eagles' Hall, 3rd Ave.
W. H. Turner, Pres., 113 6th Ave.
H. W. Bias, C. & F. S., 124 Oak.

564—PARAISO, C. Z. 1-3 Tues., Paraiso Hall.
W. H. Kirby, Pres.
James E. Welch, C. & F. S.

565—FALLS CITY, NEB. 1st-3d Thurs., W. O. W. Hall.
C. W. Jonas, Pres.
E. Woodington, C. & F. S., 710 E. 16th St.

567—SAN ANGELO, TEX. 1st-3d Wed., Eagles' Hall.
R. W. Berry, Pres., 23 W. Ave. L.
R. L. Wright, C. S., 27 West Ave. L.

568—TACOMA, WASH. Maccabee Hall, 1109 1/2 C St., 2d-4th Thurs.
Chas. Manning, Pres., 5808 S. Lawrence St.
A. W. Rickett, C. & F. S., 615 So. State.

570—HIGH SPRINGS, FLA.
H. A. Smith, Pres., P. O. Box 273.
F. C. Magerstaadt, C. S.

571—DE PERE, WIS. De Both Hall, 1st Sun.-3d Wed.
T. J. McDonald, Pres., Lock Box 44, W. De Pere, Wis.
A. E. Steinfeldt, R. S., P. O. Box 207.

573—LANSFORD, PA.
Frank A. O'Donnell, C. S., Summit Hill.

575—VILLA GROVE, ILL. 1st-3d Fri., Red Men's Hall.
James Tally, Pres.
A. Welch, C. S.
H. A. Downes, F. S.

576—WICHITA FALLS, TEX. 2d-4th Thurs., Labor Hall.
J. H. Gibson, Pres., 309 Lee St.
R. A. Campbell, C. & F. S., Box 750.
C. H. Shoemaker, B. A., Box 18, Healdton, Okla.

577—CUMBERLAND, MD. 1st-3d Thurs., Trades Council Hall.
E. H. Stealey, Pres., Ridgeley, W. Va.
Owen Layman, C. & F. S., Ridgeley, W. Va.

578—HAGERSTOWN, MD. Moose Hall, 2d-4th Thurs.
J. S. Bussard, Pres., 215 Ridge Ave.
F. H. Stouffer, F. S., 817 Summit Ave.
C. F. Martz, C. S., Boulevard and Cedar St.

579—KEYSER, W. VA. 1st-3d Tues., City Building.
W. H. Wolf, Pres., Gilmore St.
P. R. Dougan, F. S., Gilmore St.
Joseph F. Hines, C. S., Piedmont, W. Va.

580—HALIFAX, N. S. CAN. 1st-3d Wed.
Thomas Burns, Pres., Star St.
Wm. F. Cash, C. S., 47 Cagawell.

581—MONTPELIER, O. 1st-3d Wed., Ry. Trainmen's Hall.
Frank Linerode, Pres.
C. Schalb, C. & F. S.

582—BATON ROUGE, LA. 2d-4th Thurs., Odd Fellows' Hall, 3d St.
W. P. Kidd, Pres., 302 St. Phillip St.
S. V. Acosta, C. & F. S., 918 St. Ferdinand St.

583—NEVADA, MO. Socialist Hall, Hall, So. Main St., 1st-3d Thurs.
L. E. Whitehead, Pres., R. F. D. No. 1.
A. C. Le Quellec, C. & F. S., 313 N. Washington.
C. A. McDonald, B. A., 4416 Norledge, K. C., Mo.

584—LUDLOW, KY. 1st-3d Thurs. Morley Hall.
Thos. Jackson, Pres., 17 Pherry.
H. J. Stroer, C. S., 833 Main, Covington, Ky.

585—BOSTON, MASS. 1st Thurs., 3 p. m., and 3d Sun., 2:30, Hemstead Hall, 724 Washington St.
Wm. E. McNabb, Pres., 263 Chelsea, E. Boston, Mass.
Daniel B. McInnes, C. S., 238 Marginal Ave., E. Boston, Mass.
Daniel N. Generson, B. A., 17 Bul-lard, Dorchester, Mass.
James Vincent, F. S., 77 Lavin Hill.

590—SLATER, MO. 2d-4th Mon., I. O. O. F. Hall. Chas. Crawford, Pres. Andy Phelps, C. & F. S.

597—BEAUMONT, TEX. 2d-4th Tues., Trades Assembly Hall. Geo. H. Clayton, Pres., Box 624. T. C. Maddy, C. & F. S., Box 624.

598—CHICAGO, ILL. 2d-4th Tues., Koop's Hall, California & North Aves. Thomas Godfrey, Pres., 930 E. 44th St. John McNaney, C. & F. S., 819 N. Rockwell.

599—MILWAUKEE, WIS. 2d-4th Thurs., 923 E. Water St. Frank Thinnas, Pres., 729 5th. M. J. Gleason, C. & F. S., 302 Michigan St.

590—MONROE, LA. 1st Fri., 615 A St. J. W. Grant, Pres., 501 Wood St. J. J. Devereux, C. & F. S., 615 Calypso St.

591—GLENDALE, MONT. 2d-4th Fri., Noderhoff Hall. N. A. Schope, Pres., Gen. Del. V. B. O'Connor, C. & F. S., 317 Valentine.

592—TULSA, OKLA. 2d-4th Sat. 214 1/2 S. Main. J. E. Dixon, Pres. Richard Leahy, C. & F. S., 215 Reeder Bldg.

593—CLIFTON, ARIZ. Every Sat., Carpenters' Hall. Homer Darr, Pres., Box 704. Joseph B. Hammer, C. & F. S., Box 191.

594—STANBURY, MO. 2d-4th Tues., K. of P. Hall. John Inman, Pres. E. W. McNew, C. S.

595—AVERY, IDAHO. 2d-4th Mon., Godfrey's Home, West Avery. A. Anderson, C. & F. S., Gen. Del.

596—CASPER, WYO. 2d-4th Mon. John Mulligan, Pres., 232 N. Beach. Ray Freeman, C. S., Box 921.

597—ESCANABA, MICH. 1st-3d Thurs., Lemmer Hall, Ludington St. Jos. Vickers, Pres., 506 Wells Ave. Wm. Grosnich, C. & F. S., 714 Wells Ave.

598—SALAMANCA, N. Y. 1st-3d Mon., 3 Maple St. A. G. Frey, Pres., 165 E. State St. D. J. Carpenter, C. & F. S., 3 Maple St.

599—PARAGOULD, ARK. 1st-3d Thurs., Carpenters' Hall. J. W. Frey, Pres., 321 S. 2d St. A. Johnson, C. & F. S., 216 N. 5th Ave.

C. A. McDonald, B. A., 4416 Norledge, Kansas City, Mo.

601—QUEBEC, CAN. A. Bourget, Pres., 197 3rd St., Limorlow. G. Dery, C. S., 153 4th St., Limorlow, Quebec, Can.

602—GREAT FALLS, MONT. 2d-4th Tues., Musicians' Hall, over the Mint. J. L. Smith, Pres., 205 2nd Ave. North. Roy J. Preston, C. & F. S., 420 8th Ave. So.

603—OTHELLO, WASH. 1st-3d Mon., I. O. O. F. Hall. O. W. Bohusock, Pres. W. O. Clark, C. S., Box 137.

604—JOLIETTE, QUE., CAN. H. Fournier, Pres., Gen. Del. E. Duval, C. S., Gen. Del. G. Lahaye, F. S., Gen. Del.

605—TOOELE, UTAH. 2d-4th Thurs., Fraternal Hall. D. B. Sullivan, Pres. L. Fornoff, F. S., Box 294.

606—MORBRIDGE, S. D. 1st-3d Thurs., Moose Hall. J. P. Schmicrath, Pres., Box 721. H. L. Adams, C. & F. S., Box 166.

607—BAYONNE, N. J. 2-4 Fri., Eagles Hall, 24th & B'way. Hugh Brennan, Pres., 296 Ave. C. Thomas F. Richardson, C. & F. S., 30 W 15th St.

International Officers of the Ladies' Auxiliary

MRS. J. W. EDWARDS.....President
1234 S. 9th East St., Salt Lake City, Utah.

MRS. F. R. REINEMEYER ...1st Vice-President
Tauromee Ave., Kansas City, Kans.

MRS. MOLLIE GEARY.....2nd Vice-President
6428 S. Albany St., Chicago, Ill.

MRS. A. F. BINGHAM.....Secretary-Treasurer
701 Lombard St., Springfield, Mo.

L. A. 5—SALT LAKE CITY, UTAH.
Mrs. J. W. Edwards, Pres. & C. S., 928 W. South Temple St.
Mrs. Lydia Smithen, V.-Pres., 360 West 1 South St.
Mrs. J. C. Walton, F. S.
Mrs. Jane Foreman, Treas.
Mrs. Morton, R. S., 116 Markham.

L. A. 7—SUNFLOWER, Parsons, Kas. 2d-4th Tues. aft., Kennedy Hall.
Mrs. Lillian Dudding, Pres., 2229 Crawford Ave.
Mrs. Alice Leach, Vice-Pres.
Mrs. Zita Rever, Treas.
Mrs. Lula VanVleck, C. & R. S., 2701 Clark Ave.
Mrs. Ethel Smith, Fin. Sec., 2227 Wash. Ave.
Mrs. Mary Carver, Chaplain.
Mrs. Marion Butler, Marshall.
Mrs. Ida Cormany, Conductress.
Mrs. Kate McMullen, In. Guard.
Mrs. Emma Pilkington, O. Guard.

L. A. 8—FRANKLIN, McComb, Miss., Ladies' Aux. Hall, Ave. F. East McComb, 2d-4th Thurs.
Miss Lulu Hasfield, Pres., R. F. D. No. 1.
Mrs. E. Sullivan, V.-P. & Treas., 725 Ave. F.
Miss Emma Sullivan, C. S., 725 Ave. F.
Miss Lulu Hasfield, R. S.

L. A. 9—GRAND JUNCTION, COLO.
Mrs. W. H. Holeman, Past Pres., 914 S. 5th St.
Mrs. F. N. Davies, Pres. & Treas., 538 Uta Ave.
Mrs. J. W. Cox, C. & F. S. & V.-P., 925 S. 5th St.
Mrs. L. A. Turner, R. & S. T.

L. A. 10—SPRINGFIELD, MO.
Mrs. A. F. Bingham, Pres., 701 Lombard St.
Mrs. J. Gestring, Vice-Pres.
Mrs. C. S. Gilliland, C. & R. S., 1914 Johnson St.
Mrs. Wm. Specht, F. S. & T., Route 6.
Mrs. Rheaden, Chaplain.
Mrs. J. East, Conductress and Marshall.
Mrs. J. Ritterhouse, Inside Guard.
Mrs. Gestring, Mrs. Gilliland and Mrs. East, Trustees.

L. A. 11—LONE STAR, Palestine, Texas, Labor Temple, 2d-4th Tues. afternoons.
Mrs. Frances Brunson, Pres., 15 Cottage Ave.
Mrs. Helen Redus, V.-P., 106 Queen St.
Mrs. Florence Payne, R. S. & Treas., 213 Palmer Ave.
Mrs. Willie Welch, C. & F. S., 511 Green St.

L. A. 12—GARFIELD PARK, Chicago, Ill., 2d-4th Thurs., 3 p. m. Garfield Park Hall, 4039 W. Madison.
Mrs. Maud Reinemeyer, Past Pres.
Mrs. Mollie Geary, Pres., 6428 S. Albany Ave.
Mrs. E. Farrell, V.-P., 4118 Carroll Ave.
Mrs. Helen Hughes, Cor. & Rec. Sec., 716 N. Avera Ave.
Mrs. Mary Driscoll, Fla., Sec. & Treas., 4135 Carroll Ave.

L. A. 14—TOLEDO, O.
Mrs. E. Richardson, Pres.
Mrs. Allen Thomson, V.-Pres.
Mrs. C. F. Hagar, R. S.
Mrs. C. J. Suga, C. & F. S.
Mrs. Carrie Stephan, Treas.
Mrs. Louise Brown, Conductress.
Mrs. Lena Kern, Inspectress.

L. A. 15—SAPULPA, OKLA.
Mrs. Cora Johnson, Pres.
Mrs. Myrtle Clifton, V.-Pres.
Mrs. Addie Allen, R. S.
Mrs. Beattie Lewis, C. S.
Mrs. Hester Chapman, F. S.
Mrs. Ethel Edwards, Treas.
Mrs. Hettie London, Chaplain.
Mrs. Ferrel Wells, Conductress.
Mrs. Emma Davis, Inside Guard.
Mrs. Katie Hoover, Marshall.
Trustees—Laura Cargill, Mrs. Emma Davis, Mrs. Addie Allen.

L. A. 16—DECATUR, ILL.
Mrs. M. J. Kelly, Pres.
Mrs. Fred Reutcher, Vice-Pres.
Mrs. H. J. McLaughlin, R. S.
Mrs. Henry Yost, C. & F. S.
Mrs. C. C. Dean, Treas.

L. A. 17—CHICAGO, ILL. 2d-4th Mon., Puseys Hall, 75 St and Drexel Ave.
Mrs. Rose Ptok, Pres., 9015 Houston Ave.
Mrs. Cora Kelley, Vice-Pres., 9251 Stoney Island Ave.
Mrs. O. M. Diedrich, Cor. & R. S., 7436 Evans Ave.
Mrs. Eleanor Clark, F. S. & Treas., 7539 Rhodes Ave.
Mrs. Katherine Murphy, Chaplin, 751 E 73rd St.
Mrs. Anna Cullerton, C. and M., 749 E. 73rd St.

Boilermakers' Lodges by States.

Alabama.
 Birmingham . . . 4
 Mobile112
 Montgomery . . . 443
 Selma312
 Sheffield344
 Whistler511

Arizona.
 Clarksdale . . . 406
 Clifton593
 Miami187

Arkansas.
 Harrison138
 Little Rock . . . 66
 Little Rock . . . 69
 McGhee106
 Paragould . . . 599
 Pine Bluff . . . 68
 Van Buren . . . 521

Canada.
 Calgary, Alberta . . . 392
 Edmonton, Alb. 279
 Ft. William, Ont. 605
 Halifax, N. S. 580
 Hamilton, Ont. 421
 Joliette, Que. 604
 McAdam Jct. 379
 Moncton, N.E. 373
 Montreal 134
 Moose Jaw, Sask. 478
 North Bay, Ont. 417
 Quebec 601
 Revelstoke . . . 466
 Riviere du Loup, Que. 398
 St. Thomas, Ont. 413
 Toronto, Ont. 548
 Transcona, Man. 529
 Winnipeg, M. 126
 Winnipeg, M. 451

British Columbia.
 Vancouver . . . 194
 Victoria 191

California.
 Los Angeles. . . 92
 Oakland 233
 Pt. Richmond 317
 Sacramento . . . 94
 S. Francisco. . . 25
 S. Francisco. . . 205
 S. Francisco. . . 410
 Vallejo 148

Colorado.
 Alamosa 446
 Colorado 136
 Denver 179
 Grand Jct. 335
 Pueblo 44
 Salida 427
 Trinidad 390

Connecticut.
 Hartford 237
 New Haven. . . 61

Delaware.
 Dist. of Columbia Washington 450

Florida.
 High Springs. 570
 Jacksonville. . 20
 St. Augustine. 230
 Sanford 422

Georgia.
 Atlanta 2
 Augusta 108
 Hawaiian Islands Honolulu. 204

Cedartown . . . 510
 Columbus . . . 428
 Fitzgerald . . . 503
 Macon 12
 Savannah . . . 26
 Waycross . . . 425

Idaho.
 Avery 595

Illinois.
 Alton 483
 Bloomington 155
 Chicago 39
 Chicago 220
 Chicago 227
 Chicago 454
 Chicago Hts. 254
 Chicago 588
 Danville 22
 Decatur 447
 Freeport 284
 Joliet 93
 Kewanee 195
 Moline 377
 Peoria 60
 Murphysboro 524
 Springfield . . . 81
 E. St. Louis. 363
 Urbana 150
 Villa Grove. 575

Indiana.
 Bedford 541
 Evansville . . . 95
 Ft. Wayne . . . 54
 Garrett 79
 Hammond 356
 Indianapolis . . 10
 Lafayette 360
 Peru 384
 Princeton . . . 334
 Terre Haute. 246
 Washington . . 241

Iowa.
 Belle Plaine. 440
 Boone 161
 Cedar Rapids. 144
 Des Moines. . . 47
 Dubuque 15
 Marshalltown. 149
 Mo. Valley. . . 145
 Slou City 244
 Valley Jct. . . . 491
 Waterloo 133

Kansas.
 Atchison 507
 Coffeyville . . . 542
 Ft. Scott 286
 Goodland 393
 Herington 340
 Hoisington . . . 408
 Horton 199
 Kansas City. . . 83
 Neodesha 418
 Osawatomie . . . 82
 Parsons 292
 Pittsburg 221
 Pratt 523
 Wichita 543
 Wichita 518

Kentucky.
 Covington . . . 537
 Louisville 40
 Ludlow 584
 Paducah 137
 Somerset 419

Louisiana.
 Baton Rouge. 532
 New Orleans. . . 37
 New Orleans. 442
 Shreveport . . . 328
 Algiers 206
 Monroe 590

Maryland.
 Cumberland. . . 332
 Cumberland. . . 577
 Baltimore . . . 193
 Hagerstown . . 578

Massachusetts.
 Boston 250
 Boston 431
 Boston 585
 Cambridge . . . 515
 Greenfield . . . 517
 Lowell 371
 Norwood 281

Michigan.
 Bay City 67
 Detroit 169
 Escanaba 597
 Grand Rapids 84
 Jackson 64
 Marquette . . . 236
 Saginaw 124

Minnesota.
 Brainerd 116
 Duluth 165
 Minneapolis . . 11
 St. Paul 3
 Two Harbors. 437
 Winona 201

Mississippi.
 McComb City. . 315
 Meridan 320
 Water Valley. 300

Missouri.
 Brookfield . . . 354
 Cape Girar. . . 430
 Geau 531
 De Soto 117
 Kansas City . . 32
 Moberly 267
 Monett 546
 Nevada 583
 Sedalia 113
 Springfield . . . 70
 Springfield . . . 530
 Slater 586
 St. Louis 27
 St. Louis 276
 St. Louis 322
 St. Joseph . . . 31
 Stanbury 594
 Sugar Creek. . . 90
 Trenton 346

Montana.
 Anaconda 80
 Deer Lodge. . . 528
 Glendive 591
 Great Falls. 602
 Harlowton . . . 41
 Havre 367
 Livingston . . . 123
 Miles City . . . 520
 Missoula 111
 Butte 130

Nevada.
 Sparks 339

Nebraska.
 Chadron 109
 Fairbury 439
 Falls City 565
 Grand Island. 475
 Omaha 38

New Hampshire.
 Concord 245
 Portsmouth . . . 467

New Jersey.
 Bayonne 607
 Elizabeth 176
 Hoboken 163
 Jersey City . . 16

New York.
 Albany 197
 Brooklyn 46
 Buffalo 7
 Elmira 225
 Mechanicsville 388
 Middletown 400
 Norwich 396
 Oneonta 414
 Rochester 229
 Salamanca . . . 598
 Staten Island. 200
 Troy 73
 Utica 223
 N. Y. City. . . . 21

North Carolina.
 Raleigh 173
 Rocky Mount. 239
 Salisbury 226

North Dakota.
 Devils Lake. 479

Oklahoma.
 Muskogee 504
 Okla. City 556
 Sapulpa 449
 Shawnee 293
 Chickasha 323
 El Reno 522

Ohio.
 Bellefontaine. 243
 Canton 301
 Chillicothe . . . 135
 Cincinnati . . . 105
 Cleveland 8
 Columbus 5
 Conneaut 355
 Elmwood 91
 Jackson 509
 Lima 259
 Middleport . . . 549
 Montpelier . . . 581
 Newark 99
 Portsmouth . . . 402
 Toledo 85
 Van Wert 409

Oregon.
 Portland 72

Panama.
 Cristobal 471
 Empire, C. Z. 463
 Paraiso 564

Pennsylvania.
 Carbondale . . . 547
 Connellsville . 444
 Galeton 438
 Lansford 573
 New Castle. . . 493
 Philadelphia . . 341
 Pittsburgh . . . 154
 Pittsburgh . . . 318
 Philadelphia. . . 19

South Carolina.
 Charleston . . . 50
 Columbia 235
 Florence 424

South Dakota.
 Huron 496
 Mobridge 606

Tennessee.
 Bristol 435
 Copperhill 453
 Jackson 88
 Knoxville 143
 Memphis 180
 Nashville 42
 Chattanooga . . 14

Texas.
 Amarillo 331
 Beaumont 587
 Big Spring . . . 423
 Childress 332
 Dalhart 476
 Dallas 86
 Denison 209
 El Paso 216
 Ft. Worth 96
 Galveston 132
 Houston 74
 Kingsville 287
 Marshall 100
 Mart 232
 Palestine 484
 Sherman 458
 Port Arthur. 305
 Smithville . . . 265
 San Antonio. 345
 Teague 502
 Terrell 469
 Tyler 486
 Waco 501
 Walnut Springs . . . 207

Utah.
 Helper 473
 Ogden 198
 Salt Lake City 103
 Tooele 606

Vermont.
 Lyndonville. . . 431

Virginia.
 Alexandria . . . 369
 Clifton Forge. 238
 Hopewell 63
 Newp't News. 55
 Norfolk 428
 Portsmouth . . . 298
 Portsmouth . . . 57
 Richmond 170
 Roanoke 30
 Roanoke 29
 Victoria 65

Washington.
 Bremmerton. . 290
 Everett 600
 Othello 603
 Pasco 265
 Spokane 242
 Seattle 104
 Seattle 489
 Tacoma 247
 Tacoma 568

West Virginia.
 Bluefield 405
 Elkins 278
 Gassaway 153
 Hinton 525
 Huntington . . . 249
 Keyser 579
 Parkersburg . . 333
 Princeton 551
 Williamston . . 557

Wisconsin.
 Butler 589
 De Pere 571
 Green Bay 485
 Milwaukee 107
 Milwaukee 302
 N. Fond du Lac 395
 S. Kaukauna. 311

Wyoming.
 Casper 596
 Cheyenne 46
 Evanston 309
 Laramie 48

ALL ABOUT BOILERMAKING

The best, most interesting and timely information about the Boiler Making Industry is published every month in the magazine — THE BOILER MAKER.

This magazine is devoted exclusively to YOUR interests and prints everything worth knowing about Boiler Designing, Building and Repairing. THE BOILER MAKER would be a big help to you in your work and keep you in touch with all the new methods and improvements.

Fill in the coupon below, mail it to us and we will send you a copy FREE.

THE BOILER MAKER
17 BATTERY PLACE NEW YORK

COUPON

The Boiler Maker,
17 Battery Place, New York City.

Gentlemen:

Please send me a copy of THE
BOILER MAKER FREE.

Name.....

Address.....

Occupation.....

*When Writing
Advertisers
Mention*



*The
Boilermakers
Journal*

Just the Information We Need

**WEBSTER'S
NEW INTERNATIONAL**
—THE MERRIAM WEBSTER

Every day in your talk and reading, on the street car, in the office, shop, and school some new question is sure to come up. You seek quick, accurate, encyclopedic, up-to-date information.

This NEW CREATION will answer *all* your questions with *final* authority. *400,000 Words Defined. 2700 Pages. 6000 Illustrations. Cost \$400,000. The only dictionary with the new divided page. A "Stroke of Genius."*

Write for specimen pages, illustrations, etc.

Mention this publication and receive FREE a set of pocket maps.

**G. & C.
MERRIAM
CO.**
Springfield,
Mass.
U. S. A.

KANSAS CITY, KAS., DECEMBER, 1915.

THE BOILERMAKERS JOURNAL

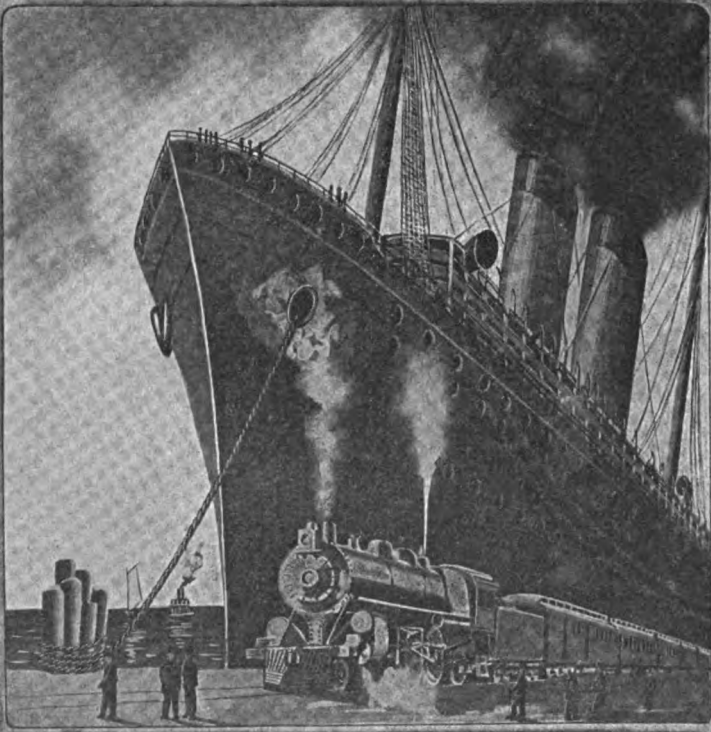

OFFICIAL ORGAN OF THE
INTERNATIONAL BROTHERHOOD
OF BOILERMAKERS, IRON SHIP BUILDERS
AND HELPERS OF AMERICA

HEADLIGHT OVERALLS

(Union Made)

IF YOUR JOB'S INSIDE WHERE IT'S WARM.
UNBUTTON THE TOP BUTTON AND THE
COLLAR ROLLS BACK COMFORTABLY



Guaranteed the best
overalls you ever bought
or money back after 30
days' wear.

Look for this ticket

THE ADJUSTABLE NECKBAND, WHEN BUTT-
ONED CLOSE, GIVES A NATTY APPEARANCE
AND KEEPS OUT THE GRIME AND COLD.

WAR—DYE STUFFS—COTTON

These three factors make it necessary to advance the price of our **extra heavy** imported indigo dyed blue denim HEADLIGHTS to \$1.25 per pair. Other HEADLIGHTS at \$1.00, \$1.10 and \$1.15 per pair. **We will not reduce our quality. HEADLIGHTS will continue to be the world's best overalls.**

(Price of HEADLIGHT Overalls in Canada \$1.25 per pair.)

Larned, Carter & Co., Detroit

WORLD'S GREATEST OVERALL MAKERS

Factories: Detroit and Port Huron, Mich.,

St. Louis, Mo., San Francisco, Cal.

Canadian Factory,--Sarnia, Ont.



SECURITY SECTIONAL ARCH

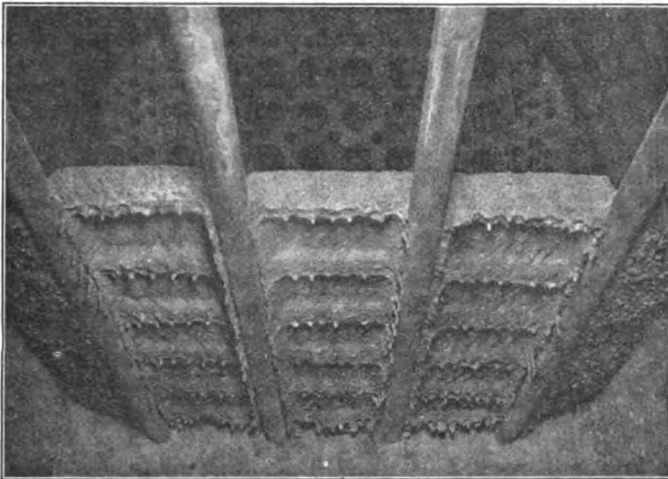

This arch is of light weight
It is built up of small sections
So made as to cool off quickly
It is easily removed for work
Made so to help the boilermaker

AMERICAN ARCH COMPANY

30 CHURCH STREET, NEW YORK

McCORMICK BUILDING, CHICAGO

Since before the Telegraph was invented

STIFEL'S Indigo Cloth

Has been the standard
cloth for

Overalls, Uniforms and Jumpers

Look for the trade mark
 on the back of the
cloth on the in-
side of the garments to be
sure you get the one and
only *Stifel's Indigo*.



It wears
like leather
and its color
is "everlasting."

*Standard for
over 75 Years.*

Cloth manufactured by

J. L. Stifel & Son

Indigo Printers and Dyers - WHEELING, W. VA.

SALES OFFICES

New York, 260-262 Church St.	Baltimore, 114 W. Fayette St.
Philadelphia . 324 Market St.	St. Louis . 425 Victoria Bldg.
Boston . 31 Bedford St.	St. Paul . 238 Endicott Bldg.
Chicago, 223 W. Jackson Blvd.	Toronto . 14 Manchester Bldg.
San Francisco	Winnipeg, 400 Hammond Bldg.
Postal Telegraph Bldg.	Montreal
St. Joseph, Mo.,	Room 500, 480 St. Paul St.
Saxton Bank Bldg.	

Extend Your Education

Every railway employe should devote a part of their spare time in improving their education and knowledge of the technical side of their trade or calling as well as that of the practical side. There is no position in the whole field of railroading that any employe may not aspire to if they will only take advantage of the educational facilities now available, and devote their spare time to study.

The Railway Educational Bureau is the medium through which all may satisfy their desire for knowledge. It is the last thought in correspondence schools, with a personal service attached, and it is furnished at such a small cost that all may avail themselves of its service. The Railway Educational Bureau has been inaugurated on a number of railway systems already and it is rapidly being extended to other railroads.

If it is not yet on the system that you are employed on and you want to learn more about it write for information and it will be promptly furnished.

Address

**The Railway Educa-
tional Bureau**
OMAHA, NEB.

The Boilermakers' Journal

Official Organ of the
**International Brotherhood of Boilermakers
Iron Ship Builders and Helpers of America**

Vol. XXVII.

KANSAS CITY, KAS., DECEMBER, 1915.

No. 12.

EXTRACTS FROM THE REPORT OF A. F. OF L. EXECUTIVE COUNCIL.

San Francisco, Calif., Nov. 8, 1915.

To the Officers and Delegates of the Thirty-fifth Annual Convention of the American Federation of Labor, Greeting:

The past year has been one of particular stress for the labor movement, testing its power and its practical efficiency. Like every other organization, the labor movement has found itself confronted in its various relationships by war conditions and war difficulties. At the outbreak of the war there came a great catastrophic upheaval, when the activities and policies of peace were suddenly sundered and Europe was plunged into an atmosphere of fighting and destruction.

Men's thought and efforts had been centered upon progress, upon the development of civilization and upon the conservation of human life and the enlargement of opportunities for human development. With the declaration of war, almost in an instant everything was changed, the course and purpose of organized society were changed to further the purpose of destruction and to serve war needs. Skill of men's minds and muscles, knowledge and scientific invention, progress of all the ages, were put at the service of the armies and navies engaged in the terrific conflict, destroying human life with unparalleled effectiveness. It seemed as though Europe had suddenly gone mad; all of the agencies to which had been entrusted the welfare and the progress of humanity were suddenly made helpless. But after the period of almost paralyzed horror passed, we began to devise ways by which we could control the convulsion following the war and utilize even war conditions for human betterment. The period of readjustment enabled us as a nation to adapt ourselves so as to organize upon a basis that would enable us to protect the citizens of our own nation.

The working people have been those who have suffered most from these changes. During that period of wonder and horror that followed the beginning of the war, many of the workers were suddenly left without

the means of earning a livelihood; left to struggle on as best they could for themselves and those dependent upon them, although they had not been able to provide out of their scanty wages to meet such an emergency. Industries throughout the country struggled on for a time in a halting sort of fashion and some stopped. The commerce that was prepared to meet the needs of peace was wasted in the war situation. There followed a period of depression which meant to the workers of our country unemployment of such a serious nature that thousands were facing starvation. Yet, in the midst of all this confusion, this turmoil, uncertainty and even despair, there was one agency upon which the workers fixed their trust and hope, the one agency that was appealed to by the toilers and the oppressed, not only of this but of the nations that were suddenly submerged in the European war.

The labor movement has done much in the crisis of the European war, but it has been hampered by lack of funds. The same obstacle is felt in carrying out ideals and plans for greater helpfulness in all international relations.

This agency remained because it was founded for an unselfish purpose, because it did not exist for the hope of gain, because all its efforts were bent upon the protection and assistance of human beings. The labor movement owes its existence to the needs of men. It expresses their hope for the future. It continues because it meets the needs of the people, and it maintains its power and its vigor in proportion as it keeps itself free from the agencies of greed and of selfish interest that would use it to further their own purposes or would weaken it to eliminate its opposition. In this country as the desires of men increase and are more urgent, the need for the labor movement becomes greater. In the period of distress and disruption that followed, men's thoughts and men's hopes were turned to the labor movement of America. Whether organized or unorganized, they knew they could depend upon that organization to help them in their time of need.

In the time of peace, the labor movement

is the constructive force in the industrial world which brings system, organization and opportunity for progress into industrial relations between employers and employes. It is the democratic medium by which the toilers can work out their problems, remedy wrongs and secure for themselves ever increasing opportunity for better living.

Industrial organization is now upon too large a scale to permit of haphazard methods and disorganized conditions in any of its relations. Employers have found that their interests in industry must be very highly systematized if they are to survive in the struggle with their competitors. Employes cannot remain a helpless disorganized mass with inarticulate wants and needs if they are not to be crushed and maimed by the strong organized forces in industry. Such inhumane and unwise policy would result in reducing the workers to a condition for which only industrial revolutions and rebellions would secure betterment, protection or justice. Such a policy is not worthy of an enlightened nation. It is subversive to all ideals of industrial progress or industrial statesmanship.

It has become a generally accepted fact that all relations of life must be so organized that there shall be in existence agencies for constructive development and gradual and natural progress—agencies whereby the problems arising in these various relationships can be worked out without upheavals or unnecessary disturbances. It is now recognized that policies and principles of statesmanship must be applied to industrial relations as well as to political relations. In truth, industrial relations are now of greater consequence than political relations because they touch the lives of the people more intimately and with greater power for good or evil than do political relationships. Furthermore, it is now recognized throughout the civilized world that the agency necessary for the existence of regulation, system and progress in relations between workers and their employers is the trade union, which is founded upon the highest ideals for associated effort of any kind. It is a simple democratic organization which meets the needs of the workers and enables them to protect themselves and make such progress that they shall become of increasing value and importance to the nation.

The labor movement of America was the great steadying force in the period of upheaval and transition that followed the outbreak of the war. It was the force that insisted upon the maintenance of existing standards that protected the workers against all efforts to throw upon them the full burden of the war. It was the force that demanded for the workers an opportunity to work in order to earn a daily living. It was the force that held true and tided things over.

When employers had readjusted to meet the changing conditions and to meet the de-

mands of European nations that had grown out of the conduct of the war, the labor movement of the country was the agency that enabled the workers to share more equitably the results of the industrial impetus given by the war. The workers soon realized that the employers intended to keep to themselves all of their vastly increased profits. The organized workers made demands through their regular representatives, and many unorganized workers caught the spirit of the day and organized in order that they, too, might make their demands effective. Thus there came in many industries a great labor forward campaign. It was recognized that the organized economic power of the workers was their main dependence under all conditions and all necessities, whether for protection or for opportunity to share in prosperity.

In the meanwhile the workers of the warring nations were constantly turning to the labor movement of America for assurance that the influence and power of our own workers of this country would be exerted upon international relations for the maintenance of the cause and rights of humanity. Appeals came from the workers of desolated lands for assistance and in all and through it all the spirit of fraternity, the spirit of fellowship among industrial workers survived, even when the outward physical ties of organization were temporarily lost in the stress of war.

Even though of late there has been increasing difficulty in maintaining intercourse with the labor movements of some foreign countries, yet there still remain the spirit of fraternity and the confidence that the American labor movement will stand for the rights of humanity, of the workers in all of the countries, and will insist upon the paramount importance of humanity. Yet to maintain the force of our labor movement straight and unerring, has not been an easy task. There have been innumerable influences that have sought to fasten themselves upon the labor movement of this country because they recognized its power, and because they desired to use it to serve their own purposes.

It has been due to the integrity, the honor and manhood of the wage-earners that many efforts to embroil our country in the present international complications have failed. They have held their ideals too dear to be sacrificed to personal gain, and they have not deviated from the determination to make all forces and all conditions contribute to the progress of the labor movement which is the well-being of the wage-earners. In every trade they have sought to obtain higher wages, shorter hours of work, and better working conditions. They have used their influence to secure not personal benefits, but something that would lift the labor movement upon a higher plane with greater opportunities. These efforts to use the labor movement have come in all manner of

guises. They have come as humanitarian efforts; they have come as patriotic appeals; they have come as promoting the highest ideals which human beings have conceived. But the trade union movement of America has steadfastly refused to be moved from the principles upon which it has built up its present power and effectiveness. The trade union movement, the powerful militant organization in industry for the protection of the rights of the workers and for the maintenance of industrial justice, has refused to give its sanction to any political movement in furtherance of peace at any price. While the trade union movement recognizes that peace is absolutely necessary for normal, consecutive development and progress, yet it refuses to secure this peace at the sacrifice of ideals and standards of justice. It maintains that a necessary assurance of peace is power for self-protection and readiness to maintain rights. The principles of statesmanship that hold true in the industrial world hold true in the political world.

The trade union movement holds that peace in any relationship can be secured only when justice prevails and that peace follows because men are accorded their rights and are assured opportunities for necessary progress. The trade union movement is founded upon democratic principles; therefore, it holds that people have a right to work out their own salvation according to their own ideals. In accord with this ideal, it refuses to sanction any effort to interfere with others who are working out their own problems. Further, it holds that it ought to take advantage of every opportunity to plan for peace in a constructive way. At the Philadelphia convention, the trade union movement indorsed a proposal that when the nations shall meet to determine upon conditions of peace at the conclusion of the present war, that representatives of the wage-earners—the great masses of all the nations—ought to be present in order to present and insist upon conditions and declarations that shall provide for the safety and the advancement of human welfare and shall maintain human rights as of greater importance than any other consideration. The trade union movement insists that a human being is of greater importance than the product of his toil. The human being is the creator and in him lies that infinitely valuable thing—creative genius. Creative genius is the thing that civilization and the agencies of civilization ought to protect. This is the principle which the trade union movement has indorsed, and which it proposes to further in all of the councils of state.

As we have said again and again, the trade union movement is as wide and as deep as human life. There is nothing that concerns human life that is foreign to the labor movement. While the efforts of the

trade union movement are directed first of all to secure certain material benefits, these benefits are for the purpose of promoting and advancing human life. It has been demonstrated that the shorter workday lengthens the lives of the workers. It gives them opportunities for better living. It is indisputable that higher wages provide the workers with the necessities for better living, and therefore make better men and women. Improved conditions of work protect the health of the workers, conserve their productive power and make them of greater value to themselves and the nation.

From this it is evident that the work of the trade union movement is of tremendous importance to the workers themselves and to the nation, and it is also evident how serious is the duty and obligation that develops upon us as the members of this Executive Council. The seriousness of that duty and obligation has been ever present to our members, and we have tried to do what we could and make the following report of our year's work.

We have had four meetings during the years, as follows:

January 11-16, 1915; April 19-24, 1915; September 20-25, 1915, and November 6, 1915.

There were submitted to us during the year 162 documents. The most important of the matters to which we have given attention and consideration during the year are included in this report.

Secretary Morrison's Report.

To the Officers and Delegates to the Thirty-fifth Annual Convention of the American Federation of Labor:

Fellow Unionists: I have the honor to submit a report to you of the receipts and expenditures for the past twelve (12) months, beginning October 1, 1914, and ending September 30, 1915.

It is with satisfaction I report at the close of the fiscal year a balance on hand of \$110,632.39—\$70,132.39 in cash and \$40,500 advanced from the defense fund for local trade and federal labor unions on account of \$50,000 loan to erect American Federation of Labor office building. Of the total amount on hand, \$97,887.83 is in the defense fund for the local trade and federal labor unions and can be used to pay benefits only in case of a strike or lockout of the members of these local unions. The balance, \$12,744.56, is in the general fund. Of that fund only \$8,683.16 is available for the general expenses of the American Federation of Labor. The balance, \$4,061.40, is in the fund created by the one-cent assessment levied December 17, 1914, to defray expenses of appeals in the United Hatters' contempt cases and for the organization of women workers.

The total receipts from all sources are \$271,625.53, the total expenses are \$303,985.95, which includes the \$40,500 advanced on office building loan, leaving the actual expenses amounting to \$263,485.95. Deduct-

ing the actual expenses from the receipts shows an excess of the receipts over the expenditures of \$8,139.58.

The following are the receipts and expenses for the twelve months ending September 30, 1915:

RECEIPTS.	
Balance on hand September 30, 1914.....	\$102,492.81
Per capita tax.....	\$176,372.31
Supplies.....	8,028.54
Interest on funds on deposit.....	2,340.00
American Federationist.....	36,731.27
One-cent assessment to defray expenses in the United Hatters' case...	15,777.24
One-cent assessment to organize women workers.....	5,373.95
Defense fund for local trade and federal labor unions.....	14,257.98
Disbanded and suspended unions and fees for charters not issued.....	890.53
Reinstatement and initiation fees.....	5,804.47
Money received and not receipted for.....	858.50
Premiums on bonds of officers of affiliated unions.....	5,190.74
	271,625.53
Total.....	\$374,118.34
EXPENSES.	
General.....	\$193,595.26
Defense fund:	
Local trade and federal labor unions.....	\$ 8,223.57
*On account of amount advanced on office building loan ...	40,500.00
	48,723.57
American Federationist.....	35,294.06
Premiums on bonds of officers of affiliated unions.....	5,052.66
One-cent assessment to defray expenses in the United Hatters' case...	11,982.43
One-cent assessment to organize women workers.....	9,192.62
Reinstatement and initiation fees.....	145.35
	303,985.95
Cash balance on hand September 30, 1915.....	\$ 70,132.39
RECAPITULATION.	
In general fund.....	\$ 12,744.56
In defense fund for local and federal labor unions.....	57,387.83
	\$ 70,132.39
*On account of amount advanced on office building loan from defense fund.....	40,500.00
Balance on hand September 30, 1915, including building loan.....	\$110,632.39
The following is the grouping under their respective heads of the detailed monthly expenses:	
Appropriations:	
Trades and Labor Congress of Canada.....	\$500.00
National Women's Trade Union League of America.....	450.00
Union Label Trades Department.....	52.25
Rent.....	5,924.50
Refunds of premiums on bonds and supplies returned.....	139.36
Premiums:	
Bonds, local unions.....	5,052.66
Treasurer's bond.....	125.00
Secretary's bond.....	20.00
Fire insurance.....	14.45
Expressage, freight and drayage.....	1,173.00
Legislative expenses.....	7,068.75
Newspapers, magazines and books.....	241.24
Office fixtures.....	83.90
Postage stamps.....	4,501.02
Printing and binding proceedings of the Philadelphia Convention.....	2,669.50
Stamped envelopes.....	1,011.84
Supplies and printing.....	18,377.03
Telegrams.....	2,090.64
Expenses of delegate to Philadelphia Convention of the Union Label Trades Department.....	51.90
Expenses entertaining fraternal delegates.....	11.50
Expenses of fraternal delegate to Canadian Trades and Labor Congress.....	207.85
Philadelphia:	
Committee rooms.....	190.00
Expenses, Secretary attending Philadelphia Convention.....	106.80
Messenger, Sergeant-at-Arms, and Assistant Secretary.....	424.00
Printing and supplies.....	132.24
Printing daily proceedings.....	2,295.60
Stenographers.....	1,139.89
Telegrams, telephone, stamps, porters, stationery, reading proof, sending out daily proceedings, rent of typewriters, photographs.....	180.02
Salary:	
President.....	6,875.01
Secretary.....	4,750.01
Treasurer.....	500.00
Office employes.....	41,730.82
Janitor service.....	47.80
Expenses:	
Auditing and Credential Committee.....	269.10
Executive Council meetings.....	6,157.20
President traveling during year.....	1,893.84
Secretary traveling during year.....	424.14

Defense fund:	
Strike benefits	8,190.90
On account of amount advanced on office building loan	40,500.00
Refund of overpayment of per capita tax received from local trade and federal labor unions	
	32.67
Assessment:	
One-cent assessment to defray expenses in the United Hatters' case	11,982.44
One-cent assessment to organize women workers	9,192.62
Organizing expenses	72,342.90
Printing and publishing American Federationist	35,294.06
Printing American Federation of Labor Weekly News Letter for organizing and legislative purposes	3,648.00
Printing American Federation of Labor Weekly News Letter	1,404.00
Postage on American Federation of Labor Weekly News Letter	381.15
Legal expenses	25.00
Expenses attending Louis Kemper's funeral	91.00
Expenses relative to erecting of booth and American Federation of Labor exhibit at Panama Exposition	3,885.75
Refund of reinstatement at initiation fees received from local trade and federal labor unions	133.10
Total	\$303,985.95

ONE-CENT ASSESSMENTS.

Assessments levied on the membership of affiliated organizations August 4, 1913, and December 17, 1914, were to defray expenses of appeals in the United Hatters' case, and the contempt case, and after all expenses were paid in these cases the balance to be used to organize women workers.

The following is a statement of the receipts and expenses for this fiscal year, ending September 30, 1915:

RECEIPTS.

Balance on hand September 30, 1914	\$266.59
Receipts from October 1, 1914, to and including September 30, 1915	15,777.24
Total	\$16,043.83

EXPENSES.

On account of attorney fees and expenses relative to the United Hatters' case:	
Alton B. Parker	\$7,500.00
Frank L. Mulholland	1,368.61
Printing brief in Lawlor vs. Loewe case, Alton B. Parker	376.25
On account of stenographic work, Hatters' case, J. H. Ralston	71.70
On account attorney fees preparing bill to be introduced in Legislature, J. H. Ralston	100.00
Organizing expenses, S. A. Conboy	720.04
Organizing expenses, M. Kelleher	940.15
Organizing expenses, Wm. Collins	449.01
Organizing expenses, M. Scully	456.67
Total	\$11,982.43

RECAPITULATION.

Receipts	\$16,043.83
Expenses	11,982.43

Balance on hand September 30, 1915 4,061.40

*All expenses incurred in the Buck Stove and Range, Contempt and United Hatters Case have been paid, and there is a balance of \$4,061.40 in this fund to be used for the organization of women workers.

* * * *

Cash balance on hand September 30, 1915 \$70,132.39
 On account of amount advanced on Office Building loan 40,500.00

Balance on hand September 30, 1915, including building loan \$110,632.39

Charters issued.

During the twelve months ending September 30, 1915, there have been issued 212 charters to National and International, Central, Local Trade and Federal Labor Unions.

Of this numbers, one was granted to the following International:

International Brotherhood of Steam Shovel and Dredgmen.

One State Branch: South Carolina State Federation of Labor.

- Trade unions, 126.
- Federal Labor Unions, 40.
- Forty-four Central bodies, as follows:
- Alabama—Tuscaloosa.
- California—Santa Barbara.
- Canada—Sherbrooke.
- Illinois—Carlyle, Gillespie, Oglesby, Royalton, Sandoval, Westville.
- Indiana—Dunkirk.

- Iowa—Iowa City.
- Kansas—Hutchinson.
- Massachusetts—Gardner.
- Mississippi—Jackson.
- North Carolina—Charlotte, Durham.
- New York—Mt. Kisco, Tonawanda.
- New Jersey—Atlantic City.
- Nevada—Tonopah.
- Oklahoma—Sapulpa.
- Pennsylvania—Harrisburg, Johnstown, Mt. Carmel, Nanticoke, New Kensington, Shamokin.
- Porto Rico—Bayamon.
- South Carolina—Greenville, Spartanburg.
- South Dakota—Aberdeen.
- Tennessee—Bristol.
- Texas—Ablene, Amarillo, Brownwood, Cleburne, Commerce, Strawn, Texas City.
- Vermont—Wilder.
- West Virginia—Clarksburg, Wheeling.
- Washington—Bremerton, Chehalis.

**National and International Organizations
Formed From American Federation of
Labor Local Unions.**

The American Federation of Labor in the past nineteen years has formed out of directly chartered local unions, the following seventy-five national and international organizations:

1896.

Mineral Mine Workers' Progressive, Northern.

Actors' National Protective.
National Union of Textile Workers.
Boiler Makers' and Iron Ship Builders' Union.

Brickmakers' Alliance, National.
Federated Association of Wire Drawers.

1897.

Bicycle Workers' International Union.
Gold Beaters' National Union.
Steam Engineers' National Union.
Core Makers' International Union.
Blacksmiths, International Brotherhood of.
Brotherhood of Paper Makers.
Meat Cutters and Butcher Workmen's National Union.

1898.

Mosaic and Encaustic Tile Layers' and Helpers' International Union.

Building Laborers' International Protective Union of America.

Trunk and Bag Workers' International Union.

1899.

International Brotherhood of Stationary Firemen.

National Association of Steam and Hot Water Fitters and Helpers.

Brotherhood of Coal Hoisting Engineers.
Tin Plate Workers' International Protective Association.

Team Drivers' International Union.

1900.

Chain Makers' National Union of the United States of America.

Glass Workers' National Union.
International Jewelry Workers' Union of America.

International Union of Wood, Wire and Metal Lathers.

Building Laborers' International Protective Union.

International Brotherhood of Oil and Gas Well Workers.

United Metal Workers' International Union.

Upholsterers' International Union of North America.

1901.

Shirt Waist and Laundry Workers' International Union.

Amalgamated Leather Workers' Union of America.

International Watch Case Makers.
International Association of Car Workers.
Paving Cutters' Union of the United States of America.

National Association of Blast Furnace Workers and Smelters of America.

1902.

United Cloth Hat and Cap Makers' Union of North America.

Sawsmiths' Union of North America.

Piano and Organ Workers' International Union of America.

National Association of Machine Printers and Color Mixers of the United States.

United Powder and High Explosive Workers of America.

International Association of Tube Workers.

International Association of Marble Workers.

Window Glass Snappers' National Protective Association of America.

1903.

Quarrymen's International Union of North America.

American Brotherhood of Cement Workers.

International Brotherhood of Tip Printers.

International Union of Slate Quarrymen, Splitters and Cutters.

International Slate and Tile Roofers' Union of America.

Brotherhood of Railway Expressmen of America.

International Hodcarriers and Building Laborers' Union of America.

International Shingle Weavers' Union of America.

Bill Posters and Billers of America, National Alliance of.

International Association of Glass House Employes.

International Handlers and Warehousemen's Union of America.

Glove Workers' International Union of America.

Order of Commercial Telegraphers.

Amalgamated Rubber Workers' Union of America.

National Union of Shipwrights, Joiners and Caulkers of America.

International Union of Flour and Cereal Mill Employes.

1904.

Asbestos Workers of America, National Association of Heat, Frost, General Insulators and.

International Association of Fur Workers of the United States and Canada.

Mattress, Spring and Bedding Workers' International Union.

Brushmakers' International Union.

International Brotherhood of Foundry Employes.

International Union of Building Employes of America.

International Union of Paper Box Makers.

Tack Makers' International Union.

1905.

National Brotherhood of Woodsmen and Saw Mill Workers.

International Union of Pavers and Rammermen.

1906.

Steel Plate Transferrers' Association of America.

1907.

International Brotherhood of Composition Roofers, Damp and Waterproof Workers of United States and Canada.

Postoffice Clerks, National Federation of. Lobster Fishermen's National Protective Association.

1910.

Tunnel and Subway Constructors' International Union.

1913.

International Fur Workers' Union of United States and Canada (second time chartered).

* * * *

Protection of American Citizens' Rights.

As a result of the developments during the months that the European war has been in progress, it is plain that under present conditions protection for the American citizens is inadequate, and not what any sovereign world power ought to give to its citizens. Native-born citizens of alien parentage and naturalized citizens have been forced by foreign countries into the military service for the present European war. In this way naturalized citizens have been forced to participate in war in defiance of their rights as citizens of the United States.

We, therefore, recommend that this convention in the name of the citizenship of our country urge upon the government of the United States to enter into negotiations with foreign countries for the formulation of treaties that shall guarantee protection of American citizens whether native born or naturalized, and specifically had recognized the fact that no country on the face of the globe has any right to claim any act of allegiance of any native born or naturalized citizen; that no country or government ought to have, and can have any legal claim upon them for their service.

We hold that an American citizen whether native-born or naturalized, is a citizen of the United States, owes no allegiance to any foreign country, yet as the result of the developments during the European war, now in progress, it is plain that the assertion of this principle has been questioned and controverted. In other words, native born citizens of the United States of alien parentage, and naturalized citizens of the United States, have been forced into the military service of foreign countries against their will, and compelled to engage actively in the present European war. We hold that no country or government other than the United States is to be permitted to lay claim upon American citizens or for their services, military or otherwise.

* * * *

Organizers.

It was not so many years ago that an organizer for the labor movement was regarded as a dangerous man in a community. He was a marked man, blacklisted, denied op-

portunities for any kind of work, starved and persecuted, but since the labor movement has grown in power, and has been recognized as a movement for humanity, it now is regarded as a great constructive agency of the community. In industrial clashes and in periods of industrial unrest, labor organizers are recognized as representatives of a movement that stands for justice and for the general human welfare. In many cases during late years employers and the community have welcomed the appearance of an organizer of the American Federation of Labor, for they know that these representatives stand for constructive, practical policies. Formerly one of the indispensable qualities of an organizer was ability for physical self-defense and protection. While the organizer of the present day does not lack physical power or courage, he must possess, he must have, sincerity and devotion to the rights and interests of the workers whom he represents, and, in addition, power of leadership and ability to educate. This change marks the tremendous forward progress of the trade union movement since the organization of the A. F. of L.

To be sure, that progress is not uniform. There are still localities where the forces of property and private gain are so powerful that the workers are denied the right to organize, and where attempt to exercise that right is contested by violence and by warfare. But in those sections of the country where the greatest industrial progress has been made and where the broadest ideals of human liberty prevail, organization is recognized as an essential element of industry. Where industrial statesmanship has been developed to a degree that co-operation with the organized labor movement is sought, there the work of the organizers of the labor movement becomes largely administrative and educational. Recognition of this fact has led during the past year to increased efforts to render necessary assistance and information to the organizers of the A. F. of L. This has been referred to in another section of this report.

The labor movement can be no greater than the people that compose the labor movement. It can make progress no faster nor no more definitely than the wisdom and the experience of the members of the labor movement direct. This emphasizes the importance of educational ability among the organizers, because it emphasizes the necessity for giving to the rank and file of the labor movement information that will prevent them from making mistakes in directing their course, and enable them to decide upon the wisest plans.

The organizers of the A. F. of L. are in daily contact with the wage-earners. They have, through conferences, conversations, public addresses, as well as in all of their activities of an official character, innumerable opportunities to disseminate information, and to make suggestions that will give form and direction to opinion in the labor

movement, and will be of infinite power in determining its ultimate destiny. The success of all efforts depends in a large degree upon those to whom is entrusted administration. The duties of organizers and members of unions may often seem commonplace and unimportant, but this seemingly routine or obscure work that has been necessary, has brought the labor movement to its present high degree of power and effectiveness.

There are, in the labor movement of America, many organizers who serve without pay, who give to the labor movement whatever of time and of energy they have left when the day's work is done. The work of these faithful men and women has been one of the instrumentalities that has brought the trade union movement beyond the two million mark, and is steadily urging it up to the three million. Though their services may never receive full recognition, yet the value of their services will be felt throughout all of the ages as the labor movement brings greater freedom and greater opportunity to all.

Because many of these unpaid organizers contribute not only their time and energy, but often do so at an expense to themselves, during the past year a special offer has been made to reimburse them for their activities by paying a certain sum for every new organization added to the A. F. L. through their efforts. A great measure of credit and appreciation is due to the organizers of national and international unions, and organizing committees of central bodies for the growth and progress of the labor movement during the past year.

As a result of the financial depression of the past year, which affected the labor movement as well as all other organizations connected with industry, we have been hampered in our work of organization. It has been necessary to discontinue some paid organizers and thereby curtail many plans that have been made. This condition made the work of unpaid organizers of even greater importance in determining the growth of the A. F. of L.

It is our sincere hope that we shall soon be able to increase the number of paid workers in the field. There have been during the past year 1,754 organizers of the A. F. of L.

* * * *

Public Versus Private Construction of Naval and Other Vessels.

Several of our conventions in the past have given instructions to encourage legislation in behalf of public versus private construction of vessels for the United States government and for all repairs to government vessels to be made at government navy yards. In co-operation with the Metal Trades unionists we have continued our efforts along the lines of those instructions and report that the proportion of repairs to government vessels is much greater in government navy yards than in private ship yards. The Naval Appropriation Acts for 1914 and 1915

provided for the construction of a naval supply ship in the Charleston Navy Yard at Boston, and a transport vessel for the government at the League Island Navy Yard, Philadelphia, Pa. The 1915 appropriations carried with them a sum of \$148,000 for better equipment of new construction work for the Charleston Navy Yard, and \$200,000 for the Philadelphia Navy Yard. Through our united efforts we also secured a valuable clause in the interests of the metal and ship building trades in this year's Naval Appropriations Acts, which states that:

"No part of the sums appropriated by this act shall be used to procure through purchase or contract any vessels, armament, articles or materials which the navy yards, gun factories or other industrial plants operated by the Navy Department are equipped to supply, unless such government plants are operated approximately at their full capacity for not less than one regular shift each working day."

Several bills introduced in Congress provided for governmental construction and ownership of a merchant marine.

* * * *

Piecework—Taylor System—In Government Service.

Resolutions Nos. 20, 139 and 156, adopted by the Philadelphia convention, reiterated protests against the Taylor system, piecework, premium, bonus and stop-watch schemes of shop management in government departments. Resolution No. 139 made particular reference to the intimidation of railway mail clerks by Alexander H. Stephens, General Superintendent of the Postal Railway mail service, who had been tyrannical in his efforts to prevent railway mail clerks from signing petitions and sending them to Senator Borah in behalf of the bill, S. 5826, which he had introduced and championed in Congress. An overwhelming number of protests against Superintendent Stephens were sent to Senator Borah and other members of Congress. The Postoffice Department, and particularly its chief administrative officials were severely criticised and fearlessly denounced by Senator Borah in two speeches which he made in the Senate. Stephens afterwards denied that he had attempted to coerce or intimidate the railway mail clerks, and that he had not discharged any of the clerks because they had signed the petitions for the abolition of the stop-watch, Taylor scheme foisted upon the service by him. Not long after Senator Borah had excoriated Stephens and our combined protests had been reviewed, Stephens was removed from the superintendency of the railway mail service. Since that time, the complaints against the speeding-up system of railway mail clerks have not been so numerous.

During the consideration of the legislative, executive and judicial appropriation bill in the second session of the Sixty-third Congress, Representatives Buchanan, Nolan and others succeeded in having a system of piece-

work abolished in one division of the Post-office Department at Washington, D. C. The piecework system which had been in existence there for some time had become intolerable to the men and women employes.

We continued our efforts in co-operation with the metal trades to abolish the Taylor system which had become partially established in some government navy yards and arsenals. Finding it impossible to secure direct legislation upon the subject by the enactment of the Deitrick bill, H. R. 17800, we had recourse to other methods of securing congressional action upon the bill, and in response to our continued efforts, Mr. Deitrick offered his bill as an amendment to the Army Appropriation bill on January 22, 1915. The chairman of the Military Affairs Committee, which had the bill in charge, promptly made a point of order against it, using the old subterfuge "that it was new legislation." Ample congressional precedents proved to the satisfaction of the members of the House that contractual relations and industrial working conditions can be legitimately defined and included in an appropriation bill. Representatives Buchanan, Nolan, Keating and others of the labor group vigorously supported Mr. Deitrick's amendment. The chairman of the committee withdrew his point of order, and the House, by a unanimous vote, in committee of the whole adopted the Deitrick anti-stop-watch, anti-speeding-up, anti-premium system proviso in the bill.

It is worthy of special note in this record that Brigadier General William Crozier, Chief of the Ordnance Bureau in the War Department, a most insistent advocate and promoter of the Taylor system in the government arsenals, immediately after above recorded action of the House, wired to his subordinate officials at Watertown, Mass.; Watervliet, N. Y.; Frankford, Pa., and Rock Island, Ill., for them immediately to stop the stop-watch Taylor system in their several departments, but this did not deter him from exercising every possible resource with the members of the Senate Committee on Military Affairs to defeat the Deitrick amendment. When the Senate Committee on Military Affairs reported the Army Appropriation bill to the Senate they had stricken out the Deitrick amendment. On February 23, 1915, when the army bill was brought up in the Senate a vigorous debate ensued. Senators Lippitt of Rhode Island, Thomas of Colorado, Warren of Wyoming, Weeks of Massachusetts, Oliver of Pennsylvania and Root of New York vigorously supported the Taylor system and complimented the committee for striking the amendment from the bill. Senators Hughes and Martine of New Jersey were emphatic in their protests against the committee for striking it out. They urged the retention of the Deitrick proviso in the bill. After extended

debate, three ballots were taken and the Senate struck out of the bill the anti-Taylor system proviso. Nevertheless, we did not allow this apparent set-back to stop our efforts. We succeeded on February 8, 1915, in securing the addition of the Deitrick bill of the Naval Appropriation bill when it was before the House of Representatives. The Senate Committee on Naval Affairs being informed on industrial questions and more sympathetic towards the interests of Labor than the Committee on Military Affairs, kept it in the naval bill, and so reported it to the Senate. On February 25, 1915, when the naval bill came up in the Senate, Senators Warren of Wyoming and Oliver of Pennsylvania, members of the Committee on Military Affairs, who had shown opposition two days before in the Senate to the Deitrick bill in the army appropriation bill, raised points of order against the anti-Taylor system proviso in the naval bill. The point of order was sustained by the Vice-President, and again it looked as though we were out-generated. The army and naval appropriation bills were sent to conference and on March 2, 1915, when the conferees reported to the Senate that the House would not recede, the Senate agreed to permit the anti-Taylor system proviso to remain in the naval bill. The only protesting votes against it were those of Senator Oliver of Pennsylvania, Lippitt of Rhode Island and Weeks of Massachusetts. At a late hour, on the same day, the Senate conferees on the army bill reported that they had agreed with the House conferees to retain the anti-Taylor system Deitrick amendment in the army bill, and it was agreed to with the exception of Senators Oliver of Pennsylvania and Bristow of Kansas, who registered their bitter opposition to the last moment.

We are pleased to report in detail this successful outcome of our united endeavors and believe that now we have succeeded in adding these meritorious provisos to the naval and army appropriation bills it will be less difficult to obtain positive, clear-cut legislation, which will permanently prohibit the objectionable stop-watch, speeding-up, premium bonus, Taylor system, of driving and intimidating employes in federal departments.

* * * *

Industrial Education—Vocational Training.

It is impossible for us to give any substantial report at this time concerning the progress of federal legislation in behalf of industrial education—vocational training. The short session of Congress last year was too crowded with other matters for consideration of this subject.

The Philadelphia convention recommended that the matter be left with us to take such further action as will cause the greatest benefit to Labor in the development of industrial education, vocational and trade training. We hope to be able to give further

attention to this very important subject during next Congress.

We have, however, co-operated to the fullest extent of our ability in localities such as Richmond, Va.; New York City; Minneapolis and St. Paul, Minn.; Cleveland and Cincinnati, O., and other cities where local efforts have been undertaken to study or install improved systems of industrial education. Other local surveys have been made at Albany, N. Y.; Pittsburgh, Pa.; New Orleans, La.; Peoria, Chicago and other cities in Illinois; Grand Rapids, Mich.; Buffalo, N. Y.; various localities in Wisconsin under the jurisdiction of the university of that state. In Indiana also some activity has been noted. Taking it all in all, the past year has been an important one in the sphere of local activities to obtain professional technical instructors and in stimulating interest and action to promote vocational education.

The Department of Labor and the Bureau of Education of the United States Department of the Interior must be credited with giving a measure of assistance and encouragement to local efforts in behalf of improved systems of vocational and trade education.

During the second session of the Sixty-third Congress an increase in the appropriations for the Bureau of Education was obtained, and from those funds the position of a specialist in vocational education was established. Mr. William T. Bawden was appointed to fill the duties.

In connection with the subject of industrial education and vocational training, we submit that the federal government should afford generous financial aid to this matter fraught with so much value to the workers, to the people generally, and to the stability of our country. In our judgment, there can be no better preparation of the United States than intelligent understanding and effective work in industry. Our movement has already established the system of educating the men and women engaged in agriculture and horticulture, and affording the best opportunity for the sons and daughters of the farmers of our country so that they may become more intelligent and efficient workers in agriculture. We submit that an introduction of that system, so that it will apply to the mechanic, artisan and laborers of the United States is the opportunity of wisdom, foresight, economy and broad-minded self-interest and betterment to extend the federal plan of operation to industrial education, vocational training, civic rights, duties and responsibilities.

Locomotive Inspectors.

The Locomotive Inspection bill, H. R. 17894, by Representative Goeke of Ohio, which passed the House, January 4, 1915, extended the inspection service formerly restricted to locomotive boilers to the engines

and tenders of locomotives used in interstate commerce.

In accordance with the requirements of Resolution No. 141, passed by the Philadelphia convention, we urged Congress to embody the legislation proposed, requiring inspectors of locomotive boilers and locomotive engines to possess practical shop experience, and submitted a draft of a substitute bill for the proposed Goeke measure. The officers of the Railroad Employes' Department, the Boiler Makers, the Machinists and the Metal Trades Department co-operated with us in these endeavors, particularly before the Senate Committee on Interstate and Foreign Commerce, which had the bill in charge. Nevertheless, the Senate disregarded the suggestions made, and on March 4, 1915, the House bill was passed without material change.

In the month of August, a conference was held at Washington in the office of the chief locomotive inspector, at which the officials of the Railroad Employes' Department, the International Association of Machinists, the Brotherhood of Locomotive Engineers, and the Brotherhood of Locomotive Firemen and Enginemen, together with superintendents of motive power of the largest railroad systems, agreed in part to certain rules to govern the inspection of locomotive engines and tenders, same to be later submitted (September 28, 29) for approval to the Interstate Commerce Commission.

* * * *

Agricultural Credit Legislation.

The Philadelphia convention indorsed certain resolutions recommended by the Farmers' National Congress relative to specific beneficial features to be incorporated in such farm credit legislation as may be enacted by Congress. We were directed to continue efforts to secure the enactment of such remedial legislation in behalf of the farmers. Strenuous efforts were made by Senator Fletcher of Florida and by several Senators and Representatives to secure the passage of farm credit legislation during the last session of Congress, but on account of the divergent views entertained by Representatives and Senators on this subject it was impossible to reach any conclusion, but a joint committee on rural credits, composed of the following Senators and Representatives was appointed to examine into the question and report to the next session of Congress not later than January 1, 1916:

Representative Carter Glass, Virginia, chairman.

Senator R. L. Owen, Oklahoma.

Senator Henry F. Hollis, New Hampshire.

Senator Thomas P. Gore, Oklahoma.

Senator Hoke Smith, Georgia.

Senator Knute Nelson, Minnesota.

Senator James H. Brady, Idaho.

Representative Michael Phelan, Massachusetts.

Representative Asbury F. Lever, South Carolina.

Representative Ralph W. Moss, Indiana.
Representative Everis A. Hayes, California.
Representative Willis C. Hawley, Oregon.

As soon as practical, after the above action had been taken by Congress, a letter was addressed to each member of the Joint Rural Credits Committee, in harmony with the instruction of the last convention, asking the members of the committee to give consideration to the following:

• "Resolved, That any farm credit plan which does not include a direct reduction of the 'prevailing rates' of interest, as well as a long term of small annual payments upon farm mortgages, will not meet agricultural credit requirements.

"Resolved, That the government of the United States should borrow money at a rate of interest not to exceed 3½ per cent and lend the money at a rate not to exceed 4½ per cent to the farmers upon long time farm land mortgages with such restrictions as many be necessary to make the government perfectly secure and the profit to the government to be expended in road improvement or for some other object that will benefit the whole people."

Replies have been received from Chairman Carter Glass; Representatives E. A. Hayes, A. F. Lever, Michael F. Phelan, W. C. Hawley; Senators T. P. Gore, Hoke Smith and Knute Nelson to the effect that the measure will be given careful consideration.

In addition to the views expressed in the resolution communicated to the committee, we submit for your careful consideration as to whether another system of farm credit should be inaugurated—a system based upon individual ownership with community credit and community guarantee. Elsewhere than in the United States such a system is in vogue, and where it prevails no securities are held with greater confidence. This proposition, with such other improvements as time and experience have demonstrated might well be considered, is suggested to our fellow workers in agriculture.

* * * * *
Labor Press.

Unquestionably the newspaper is the chief literature of Americans. In form, in method and in spirit, it is adapted to the needs of the times. The paper habit has become so firmly established as a national custom that every cause must have the means of publicity. It is the only way to get the news quickly and surely to those who must be reached. The policy of the paper depends usually upon the motives in the managing room. The ordinary daily paper is published for profit. There may be ideals in the editorial room and scattered among the reporters, but these may be checkmated at any time by the decisions from the managing room, based upon the balance sheet.

These conditions mean that the cause of

the people is often neglected to make room for the special interests of those who can afford to pay. They mean that news will be edited, suppressed, perverted—for those who will pay. The cause of the toilers, the wronged of humanity, fails to secure space if its publication affects profits.

These conditions made labor papers necessary and they have struggled against tremendous obstacles—hampered by lack of appreciation, friends, facilities and opportunities.

Each year brings increases in the power and the number of the labor papers of the land. They are tremendous dynamic forces giving publicity to the cause of human welfare and the struggle of the workers for justice and a better life. They herald abroad the news of labor—the ideals that touch the things of daily life and make them to glow with the glory of humanity. They tell the facts of the workers' lives and of the struggles for a better life.

Usually in a secluded office, work the labor editors who dedicate their lives to the cause of publicity for labor. Their reward has been frequently but a meager living and the satisfaction of a great work done. The labor movement stands for fair wages—an ideal that must be extended to labor editors. Yet, on the other hand, great care must be exercised lest the power that comes through a labor paper should fall into the hands of those unfit to use it. Labor papers must be kept clean, free from outside or political partisan domination.

The labor papers by bringing about understanding of conditions, are a powerful element in helping to unify and give direction to the labor movement. They journey throughout the length and breadth of the land, entering into the mental life of each reader, expanding in some way his thought, and consequently his acts. They are an incalculable power in the labor movement and ought to be supported financially and morally by all the workers, and those who genuinely sympathize with the great cause of labor.

THE ROCKEFELLER INDUSTRIAL REPRESENTATION PLAN.

By John R. Lawson.

(Courtesy of the Survey.)

My opinion concerning the plan of representation of employes of the Colorado Fuel & Iron Company announced by Mr. Rockefeller is practically the same as that expressed to him by the representatives of the United Mine Workers during our conversation on this subject with Mr. Rockefeller in New York City in January last, while we were attending the sessions of the United States Commission on Industrial Relations. On that occasion I expressed serious doubts of the practicability of his proposal,

although the details were not then fully known or perhaps even determined. The reasons why the failure of the plan may be predicted were apparent then, as they are now, and no one regrets more than we of Colorado that Mr. Rockefeller was unwilling, in the interests of permanent industrial peace, to concede their fundamental soundness.

The most interesting and suggestive part of Mr. Rockefeller's proposal is the evidence it presents of the concessions in principle which the miners have at last wrung from him and his associates at an immeasurable cost in lives and human suffering during the long struggle against economic and political feudalism in Colorado. Bearing in mind that these concessions are only in principle, we find that Mr. Rockefeller has, nonetheless, acknowledge the following demands, for which the miners of Colorado have long contended:

First, the right of labor to organize in unions without discrimination on that account.

Second, the right to improve working conditions.

Third, the right of the workers to elect representatives to present their grievances to the employers, with the allowance of appeal from unjust decisions.

Fourth, the justice of the workers' claim to an eight-hour day and check-weighman, long guaranteed by Colorado law.

Fifth, a willingness of the employers to pay a wage scale to be advanced proportionately when the wage scales of competitive companies advance.

Such concessions are, of course, valuable theoretically, but the trouble all along has been, and I fear even under Mr. Rockefeller's plan will continue to be, that principle and practice, in the economic field, do not often coincide. Because of inherent weaknesses, the plan will almost surely fail on trial. Unfortunately, it is monopolistic and paternalistic, whereas for anything more than temporary success any proposed improvement in the lot of the workers must rest in the democratization of industry, either through partnership in control, or through the collective bargaining of employees meeting in the fellowship of mutual respect, on the plane of organized equality. The coal miners of Colorado are not seeking charity; they ask simple justice. They seek that which the officials of the Colorado Fuel & Iron Company claim for themselves—the right to join an organization of their choice; as sanctioned by law. The propriety of such organization being conceded, the workers insist on the privilege of selling the labor which is their one commodity through the medium of collective bargaining. They are convinced that in the present stage of industry only by the meeting of collective capital with collective labor, each governed by a sense of equity and similar

in strength, may fair contracts, binding on both, be made and maintained.

Under Mr. Rockefeller's plan, the wealth and power of industry are massed on one side, while on the other are grouped, in the absence of strong organization, scattered employes, without any real force, authority or opportunity for community of opinion or expression.

It should be clear that under Mr. Rockefeller's outwardly benevolent plan it will be possible for his subordinates to renew their long-continued and unforgotten exploitation, and that it will be a hopeless task to seek real representatives for the workers under conditions of absentee landlordism. The immediate interest and profit of Mr. Rockefeller's "representatives of the workers," who are without organization to protect them, lead directly to the side of the employers. This foredooms the plan and makes manifest to every intelligent person familiar with the practice of modern industry that what is offered is a mere subterfuge. The workers have asked for bread and are again given a stone.

The great defects in Mr. Rockefeller's suggestions, therefore, are that they strip the workers of the natural protection of organization (which, as stated, cannot successfully exist within and wholly subordinate to the employers' organization), and substitute paternalism for democracy in industry. It should be remembered that the workers have found organization far more important as a shield than as a sword. Its value is far more protective than offensive. And the democracy of union organization has made it at once the free school, the independent church, and the fraternal society of the workers.

Mr. Rockefeller has offered no substitute for these vital, social, economic and political factors. He and his associates assume—in the face of a record so near that men cannot forget, and so appalling that it alarms—that the workers are ready to take the employers' word as to their fatherly interest and concern in their employes. The workers of Colorado have read with pleasure that Mr. Rockefeller, on his recent trip to Colorado, discovered that the children of the coal camps were not dissimilar to his own. They also have received in friendly spirit Mr. Rockefeller's various statements. But at the same time, they have not found it possible entirely to turn their eyes from the hopeless, pitiless, remediless and one-sided tragedies of Southern Colorado in the last two years; and they have found it necessary to remember the life-long struggles that culminated in Ludlow. Is it any wonder that paternalism advances slowly in such an environment?

As to the democracy of Mr. Rockefeller's proposal, it should be remembered that he mistakenly assumes that employes sitting at a table with him will find themselves free and equal. They will, on one condition

only—if men trained in the labor movement, who know its problem from practical experience, and who have the confidence of their fellows, are backed by the freedom, equality and power of organization. Otherwise, the individual worker is weak, indeed, against the representative of collective capital. Standing alone, the worker is neither able to complain, equipped to compete, nor free to advance.

Mr. Rockefeller's experiment, therefore, while interesting, impresses me as largely academic. It is to be deplored that the suggested solution of our industrial problems has not been inspired by a wider vision of just human relations. It appears difficult for the masters of industry to separate themselves from the notion of their divine right to govern benevolently or otherwise, according to the temper of those who have the power. The United Mine Workers appeal from that view, not only to the good sense and conscience of mankind, but to the long record of industrial peace where contractual relations based on mutual self-respect have existed between them and the coal operators of the United States.

The other plan—Mr. Rockefeller's plan in essence—has been tried, and has failed again and again, not only in Colorado, but in many other fields. Partnership in industry through state control or sound contractual relations based on collective buying appears to be indispensable to industrial peace, economic progress, social happiness, and even political freedom.

ROBBERY AND OPPRESSION LEGALIZED.

(By A. A. Graham, Topeka, Kas.)

John D. Rockefeller, Jr., in an address at Denver, has recently said that his father, whom he represents, has never received any dividends or income on his stock in the Colorado Fuel and Iron Company.

Neither should he. This company is bonded away beyond its physical value or the original outlay, so that the excess of bonds should never pay any interest or income either.

Up to the physical valuation of the property, or the original cost, there should be a fair return on the capital invested as represented by the bonds; but beyond that, neither bonds nor stock should ever be issued, or, if issued, should ever pay any interest or income.

The almost universal way, however, to handle corporate property is, to issue all the bonds the market value of the property will float, and as far beyond this as the public will buy; and then to issue stock of a face value equal to all the bonds. Up to this point, the issue of stock, under present business methods, is regarded as legitimate, because it is assumed the public will not buy bonds beyond the market value of the property; but in practice, all the bonds that

will sell on a fictitious value of the property are usually disposed of.

After the issue of stock of face value equal to the face value of the bonds, the issue of more stock is a most common practice. This is what we call watered stock. The law should not permit this, but it ordinarily does.

Illustration: A plant costing one million to erect may be bonded for two million. This requires an earning capacity at this point to pay interest on twice the original cost. Stock is now issued for two million, and this is supposed to pay dividends at least equal to the interest rate on the bonds, and this now requires an earning of four times the original cost or outlay. Watered stock may now be issued for two million more, and this requires an earning on an amount six times the original cost, and the owners are making a fair rate of interest on six dollars where they spent but one.

Granting an income of ten per cent as fair on the original cost, by a system of bonding and stocking, the interest rate is increased to sixty per cent annually.

This increase is all made out of labor.

Physically the property has remained the same, and the enormous income has been made out of labor. Labor has made it all, yet labor gets no part of this increased income; but, on the other hand, is ordinarily cut down in rate of pay as the business becomes more remunerative, and the more profitable the business, the less the wages, as a rule.

Surely labor is not getting a square deal! The income from property may become so great and the exactions of labor so severe that ROBBERY and OPPRESSION are the only terms to fit the case.

Specifically in the present case, the reason Rockefeller has never received any dividends on this stock is because the employes have not yet been able to earn six times the normal income.

New York.—Little Old Manhattan is flat-footed, wears poor shoes and stands up at its work, according to figures compiled by Captain Frank E. Evans of the local recruiting office of the United States Marine Corps.

Captain Evans is authority for the statement that approximately 18 per cent of all applicants who applied for enlistment in the Marine Corps at its Twenty-third Street office during the past year, were rejected for "pes planus," or flat-foot. He puts the blame on the cheaply constructed, poorly made shoes the average toiler wears at his work for the epidemic of falling arch, and on the fact that the majority of victims claimed they were forced to stand on their feet for long stretches while at their employment.

Motormen, conductors, subway guards, policemen, machinists, waiters and clerks are the principal sufferers from "pes planus," Captain Evans says.

A MOVEMENT TO BUILD A MONUMENT IN MEMORY OF BROTHER GILTHORPE.

NOTE—The following resolutions were adopted by Lodge 25 of San Francisco, Calif., and on being placed before our Executive Council by document, was indorsed by that body and at its recent meeting definite plans were adopted for carrying in effect the purpose of the resolutions and a letter of appeal will be issued to the lodges later.—The Editor.

San Francisco, Calif., July 28, 1915.

Jos. A. Franklin, Esq.,
International President.

Dear Sir and Brother:

San Francisco Lodge No. 25, I. B. B. M. & I. S. B. and H. of A., at its last regular meeting, unanimously adopted the following resolution:

"Whereas, In the demise of our Worthy Brother, and our Past International Secretary-Treasurer, 'Wm. J. Gilthorpe,' the Trade Union movement, and especially the International Boiler Makers, Iron Ship Builders and Helpers of America, lost one of the ablest and most energetic brothers that was ever known; his integrity and his honesty was above reproach, and he was without fear of contradiction, the Father of this Organization; for through his years of hard toil and self-denial, he laid the Corner Stone of this International, and was always ready to give a helping hand to any brother in need or to any charitable cause; and he gave his life for the uplifting of our members; and

"Whereas, In view of this it would be fitting and just to erect a suitable monument over his last resting place, and do an honor to the memory of one who befriended us all;

"Therefore Be It Resolved, That San Francisco Lodge No. 25, subscribe the sum of \$10.00 to start a fund, to be known as the Wm. J. Gilthorpe Monument Fund; and be it further

"Resolved, That we request all the subordinate lodges to contribute whatever amounts that they can to this fund, so that a suitable monument shall be erected to the memory of our Grand Old Veteran; and be it further resolved; that our Executive Council be the custodian of this fund, and they in their judgment, procure the best monument that can be secured for whatever amount that may be realized; and be it further resolved; that this resolution be published in our Official Journal for a period of 90 days, and that all subordinate lodges be notified by circular letter about this proposed monument fund. We remain,

"Yours fraternally,

"JOHN J. KANE, President.

"THOS. J. SHERIDAN,
"Secretary-Treasurer."

EXECUTIVE COUNCIL'S ACTION.

The resolution from Lodge No. 25 was concurred in by the Executive Council and the date of closing the subscription set for April 1, 1916. President Franklin, First Vice-President Hinzman, International Secretary-Treasurer Reinemeyer and Editor-Manager Casey were authorized as a committee to take charge of the fund.—Extract from the Executive Council Proceedings.

THE BOILER MAKERS' JOURNAL

Official Organ of the International Brotherhood of Boiler Makers, Iron Ship Builders and Helpers of America.

A Monthly Publication Issued the First of Each Month from Room 8, Law Building, Kansas City, Kansas.

JAMES B. CASEY, Editor and Manager.

Subscription Price.....\$1.00 Per Year in Advance

ADVERTISEMENTS.

Advertising Rates Will be Furnished Upon Application to the Editor-Manager. No Reading Space Will be Sold for Advertising Purposes Under Any Circumstances.

All New Members Must Have Their Name and Address Sent in Through the Secretary of Their Lodge. After That They May Have Changes Made in Their Address by Filling Out Blank Form in Back of Book and Forwarding to the Editor.

All Copy Must be Received by the Editor by the 18th of the Month to Insure Publication in the Following Issue.

All Contributions and Correspondence Relating to the Journal Should be Addressed to J. B. Casey, Editor, Room 8, Law Building, Kansas City, Kansas.

Entered at Postoffice, Kansas City, Kansas, as Second Class Mail Matter.

CHRISTMAS GREETING.

As this will be our last issue until after the great festival of Christmas has come and gone, we desire to extend to all of our readers, our very best wishes, for a Happy and Joyous Christmas for themselves and their families; may they have all the good things that go to make the day an enjoyable one.

May that Divine Spirit of "Peace on earth, good will toward men," universally prevail throughout the world, and especially among our members; may this spirit enter the hearts and minds of those who are directing the dreadful carnage of death and destruction in Europe and prompt them to seek some just grounds for an early settlement.

While the year 1915 has been a very dull one, and for a part of the year a large percentage of our members were idle, still all have reasons for rejoicing and thankfulness at the present time.

We were told some time ago that as a result of the war in Europe, fifteen millions have been either killed or permanently crippled and still the dreadful carnage goes on—thousands and tens of thousands are being added each day to this enormous total. That our country is at peace with all the world is sufficient grounds alone for all of us to rejoice and as the long period of industrial depressions has passed and there is seemingly enough of work to go around, this fact should prompt us to still greater rejoicing. However, as we rejoice and make merry we should not overlook those less fortunate than ourselves; we should do all we can to bring sunshine and happiness into their lives, too, and especially the little ones. This day is especially devoted to their pleasure. In helping to make pleasure for them we create for ourselves a keener sense of pleasure and happiness than can come to us in any other way.

Here is wishing health, prosperity and happiness to all.

THE EXECUTIVE COUNCIL ADOPTS REPORT FORMS.

At the recent meeting of the Executive Council the matter of requiring a copy of all reports of trustees of local lodges to be forwarded to the Inter-

national President's office, was taken up and it was decided that a copy of all such reports must hereafter be forwarded to headquarters and a very elaborate report form for this work was adopted and copies of same have been sent to all lodges.

The trustees should secure copies of this report form and study it so that when the time comes for making out their next report they can use these forms accurately. In assuming the work of bonding all local lodge and district officers, the Grand Lodge has taken upon itself a large task, and the only way it can prove successful is to run it upon a strictly business basis. All bonding companies require prompt and accurate audits and reports on the accounts of those under bond, and to be successful with the bonding department of our brotherhood, our audits and reports must also be made promptly and carefully.

PRIVATE AMMUNITION AND ARMOR MAKERS SHOULD BE ELIMINATED FROM GOVERNMENT CONTRACTS.

No doubt the question of preparedness will be a big one during the next session of Congress, which opens this month, and it is quite likely that a material increase in our army and navy will be authorized. However, there should not be a dollar appropriated until it is definitely and unequivocally decided to eliminate the private contractor in everything that the government departments themselves can supply—from superdreadnaughts to common black powder. If any of the departments have not enough facilities, let them provide for them and with the very latest machines and appliances, so that the contractor will be eliminated from government work entirely. They have overcharged and gouged it long enough, and it is high time the government took hold of this matter seriously. The people are getting tired of seeing their money squandered in this way.

To eliminate the contractor entirely and have the government owned plants furnish these supplies would save millions and millions of dollars each year.

One of the most shameless and outrageous cases of gouging occurs in armor plate contract. If the government had an armor making plant in operation, it could save enough on the armor for two dreadnaughts to pay for the plant, and why it does not build a plant is beyond the reckoning of the human mind unless it is that these fat contractors have sufficient influence to stifle any such effort. Secretary of the Navy Daniels made a bluff some time ago along this line, by asking an appropriation from Congress, but nothing came of it. Now, however, that increased appropriations are wanted, this do-nothing policy should be changed before any more money is appropriated for the army or navy.

Congressman Tavenor has effectively shown up the robbery of these ammunition and supply men and he will no doubt continue the fight on them, and organized labor will support his efforts to stop this robbery of the people's money.

FORMS A PERMANENT INDUSTRIAL RELATIONS COMMISSION.

Former chairman of the Federal Industrial Relations Commission, Frank P. Walsh, and three other former members of the commission, James O'Connell, John Lennon and Austin Garretson, met recently with a number of labor leaders and sympathizers in New York and organized a permanent Industrial Relations Commission. The first efforts of this new body will be directed towards securing congressional action favorable to printing for free distribution the full reports, hearings, etc., of the former Federal Industrial Relations Commission, and headquarters will be established in Washington to aid in the work.

Some of the investigators who were on the former commission's staff, including Basil M. Maley, who wrote the main report of the commission, will be on the staff of the permanent commission.

The platform of work mapped out by this body at its initial meeting is a splendid one and worthy of the support of all trade unions. Here is the program as given out:

1. To secure the printing by Congress, for free distribution, of the report of the commission.
2. To secure the publication by Congress, for free distribution, of all the testimony taken by the commission and all the special reports.
3. To secure the passage by Congress or, if necessary, the initiation of a constitutional amendment, providing specifically that the courts shall exercise only the powers granted by the constitution, and shall not be permitted to declare laws unconstitutional.
4. To secure the passage of laws providing for the selection of juries by an impartial method from a list containing the names of all qualified voters.
5. To secure the passage of an act requiring the Federal Trade Commission to consider as unfair competition the exploitation of labor through long hours, low wages, unsafe or insanitary conditions, or through the refusal to meet and deal with the authorized representative of employees.
6. To secure the enactment by Congress of laws prohibiting the shipment of armed guards and of cannon, machine guns and other similar weapons in interstate commerce, except when consigned to the military authorities of the state or nation.
7. To provide that all programs for national defense shall be upon a democratic basis, properly designed to safeguard the rights of the private soldier and the rights of the workers during industrial disturbances.
8. To urge that, if additional revenue is required for the needs of the government, it shall be secured by the passage of an inheritance tax, as outlined in the report of the commission, and not by taxes upon necessities.
9. To fight the repeal of all salutary legislation, such, for example, as the Seaman's Bill.
10. To see that the grievances of unorganized workers, such as the

Pullman, Western Union and Postal employes, which are brought to light by the commission, shall be kept before the officials and directors of those companies and before the public until they are redressed.

One of the most important items of this program, as well as one of the most important subjects confronting the American people, is in reference to curbing the powers of the courts and prevent them in the future from assuming the authority of saying whether laws are valid or not. The framers of the Constitution of the United States did not provide such powers for the courts and for many years after the constitution went into effect they did not presume or dare to take upon themselves such power, but gradually, by hook and by crook, and all legerdemain known only to the slyster lawyers, they have usurped absolute and tyrannical powers that threaten to destroy the temple of American liberty unless these autocratic and unlawful powers are taken from them and restored to the people. The masses of the people will, no doubt, co-operate with the commission in its praiseworthy efforts to bring about reforms affecting the future welfare of our nation and its citizens. It might not be a bad idea to raise funds with which to purchase permanent headquarters for this and similar bodies working for the good of mankind.

A FAST BOAT RECORD.

While the mania for speed continues to develop in all means of travel, in no branch is it making greater headway than in ship building. We thought that when torpedo boat destroyers began to make 34 and 36 miles an hour records, the limit of speed had been reached. However, immense battle cruisers are being built with this speed, which is about the average for express trains.

Now comes the record for a racing boat recently built in Chicago, and known as Disturber IV, with a record of 62 miles an hour.

It is a forty-foot hydroplane, equipped with 24 cylinders, 1,800 horse power engines. This is a greater horse power than some of the large cargo-carrying ships have and it is no doubt the fastest boat so far built. One can scarcely conceive of a boat traveling through water at the rate of a mile in less than a minute.

A CLOSER CO-OPERATION BETWEEN THE FARMER AND LABOR UNIONS.

We are glad to notice that here lately there is a better understanding between the members of the farmers' unions and that of organized labor. Each are coming to understand that their interests are similar and that those who are exploiting one are also exploiting the other.

Owing to the poison of prejudice that was sown among the farmers in the past by those interested in keeping the toilers apart, the farmers entertained more or less prejudice against organized labor, but now they are beginning to see most forcibly that the interests of the toiler on the farm are

closely linked with those of the toiler in workshop, mine and factory, and that the closer they get together and the more they co-operate with each other the better it will be for both.

At the recent convention of the A. F. of L. at San Francisco the Farmers' Union had a fraternal delegate present by name of J. H. Patten, who in addressing the convention, among other things, stated that while the United States government had done much toward developing the science of farming, that it had done absolutely nothing towards developing the science marketing farm products. This statement seems to be well founded and there is no valid reason why such should be the case, unless it is because of the influence of the commission merchants and produce dealers, who stand upon the highway of commerce, and like Robin Hood, and levy tribute upon all who pass. In this way they absorb most of the profits of the farmer and secure most of the wages of the working men. It has been fully established that farm products more than double from the time they leave the farm until they reach the consumer.

This difference is the profit that goes into the hands of the middle man for receiving these products from the farmer and turning them over to the consumer and collecting the money.

There is no reason for this unfair condition to exist and still less for the government's failure to try to help improve the selling end of the farming industry.

If direct trading between the farmer and the consumer was developed to its full possibilities, it would mean a great deal to both.

The Parcel Post has unlimited possibilities in this respect and there is no reason why it should not be used.

If the consumer knew where to secure fresh produce at a saving of 25 per cent he would gladly avail himself of the information and buy them from that source. At the same time, if the farmer knew where he could find purchasers of his produce and had a reasonable guarantee that prompt payment would be made on all shipments he made, he would gladly sell them direct to the consumer at 25 per cent below the retail market price, as it would mean an increased profit to him from 25 to 50 per cent over what he is now getting. All that is necessary then is to bring about this mutually beneficial condition is to get the producer and consumer in touch with each other and arrange some system of guarantee to the producer that prompt returns would be made, and the robber middle man will be eliminated. The solution of this problem can be solved by the Farmers' Union and organized labor, if they will only set their minds to the task. Let us hope they will.

THE AMERICAN FEDERATION OF LABOR'S HEADQUARTERS BUILDING.

Agitation for the building of a permanent headquarters for the A. F. of L. has been going on for a number of years and this agitation has been especially strong during the A. F. of L. conventions in recent years, and even

as far back as the Boston convention of 1903, a resolution was adopted instructing the executive council to investigate the cost, and finally at the Philadelphia convention last year the executive council was authorized and directed to proceed to purchase a lot and have a suitable building erected. A lot has been purchased on the corner of Massachusetts Avenue and Ninth Street Northwest at a cost of \$40,000, and a five-story and basement building has been contracted for at a cost of \$90,450, and is to be ready by April 7, 1916. The executive council selected Samuel Gompers, James O'Connell and Frank Morrison as trustees, to hold title and have the management of the building on behalf of the federation. This is a good move and one that will tend to give stability and permanency to the headquarters of organized labor in America.

This example should stimulate the building of permanent homes for national and international trade unions and for the central bodies. There is no reason why each international union should not have a home of its own. It would be beneficial in many ways, and it would save much in the way of rents.

A building dedicated to the cause and use of organized labor in each city and town throughout the country is almost an absolute necessity for the proper carrying on of the business of organized labor.

Let us hope that an impetus will now be given to this work and that rapid progress will be made in the next few years.

OUR ADVERTISERS.

We desire to bring to the favorable notice of our readers, the advertisements appearing in the Journal. These advertisers, in this particular way, show their friendliness towards your official journal, and our members. We should show our appreciation by patronizing them when possible.

Utilizing a part of our space for advertisements produces a revenue that helps to bear the cost of publishing the Journal, and in this way we may look forward to the time when we may enlarge still further the size of the Journal and utilize the added space for new features helpful and beneficial to our members.

In seeking to build up our advertising we have had many difficulties to overcome. We have had to depend on our personal efforts to secure ads, as the solicitors who usually do this work want to absorb about all profits for their work, so we are determined to continue our personal efforts, and if our members will give their co-operation we will place the Journal's advertising business on a par with that of any of the labor journals.

Advertising is a business proposition. Advertisers have something to sell and they seek those who want to buy. If a publication proves to be an effective medium through which to connect the seller and buyer, then its advertising becomes a success. We have had many evidences of the co-operation of our members in the past, which has become of much help to us

in this work, and we hope all will continue to lend their co-operation and assistance.

We carry several new ads this issue and are promised others for the next issue and those to follow, with the active help of our readers, it will not be long until we have secured a volume of business commensurate with the importance of our journal as an advertising medium.

ORGANIZED LABOR OVERWHELMS REACTIONARY CONSTITUTION.

In our last issue we referred to organized labor's opposition to the reactionary constitution adopted by the "stand pat" constitutional convention of New York after many months' efforts. How effectively organized labor worked against this proposed constitution may be judged from the fact that about a half million majority was piled up against it.

The people of New York are to be congratulated upon their decisive defeat of this vicious and reactionary draft of a constitution. They are better off under the old one, faulty though it may be, than they would have been under the one just buried out of sight. We believe there was only one or two union men members of this constitutional convention, and that of the 168 members, 134 of them were lawyers. Just think of such a large proportion of members taken from one calling. No wonder the result was so bad. There should have been at least forty or fifty members of organized labor in this body and a like number of farmers, and the balance taken from all the other walks of life, and if the lawyers had been left out altogether the result would have been good. Lawyers could have been hired for so much per day to put into proper shape all laws that the convention adopted. Let us hope when the question of holding another convention is decided on that organized labor will secure a fair representation.

STRIKES NOW IN FORCE.

- Atlantic Basin Iron Works (Shields & Moran, New York). (Strike on.)
- Hibbon & Co., contract shop, South Chicago, Ill. (Unfair.)
- Milwaukee Boiler Co., Milwaukee, Wis. (Strike on.)
- Des Moines Bridge & Iron Works, Des Moines, Iowa. (Erecting work in Bremerton, Wash., Valejo, Calif., and Norfolk, Va., Navy Yards.)
- Heinie Safety Boiler Co., of St. Louis, Mo. (Strike on.)
- Wangler Boiler & Sheet Iron Co., of St. Louis, Mo. (Strike on.)
- O'Brien Boiler Co., St. Louis, Mo. (Strike on.)
- Halifax Graving Dock Co., Halifax, N. S., Can. (Strike on.)
- T. Hogan & Co., Halifax, N. S., Can. (Strike on.)
- The Arizona Copper Co., Clifton, Ariz. (Strike on.)
- Detroit Copper Co., Clifton, Ariz. (Strike on.)
- A. & N. M. Railroad. (Strike on.)

Mechanical Department.

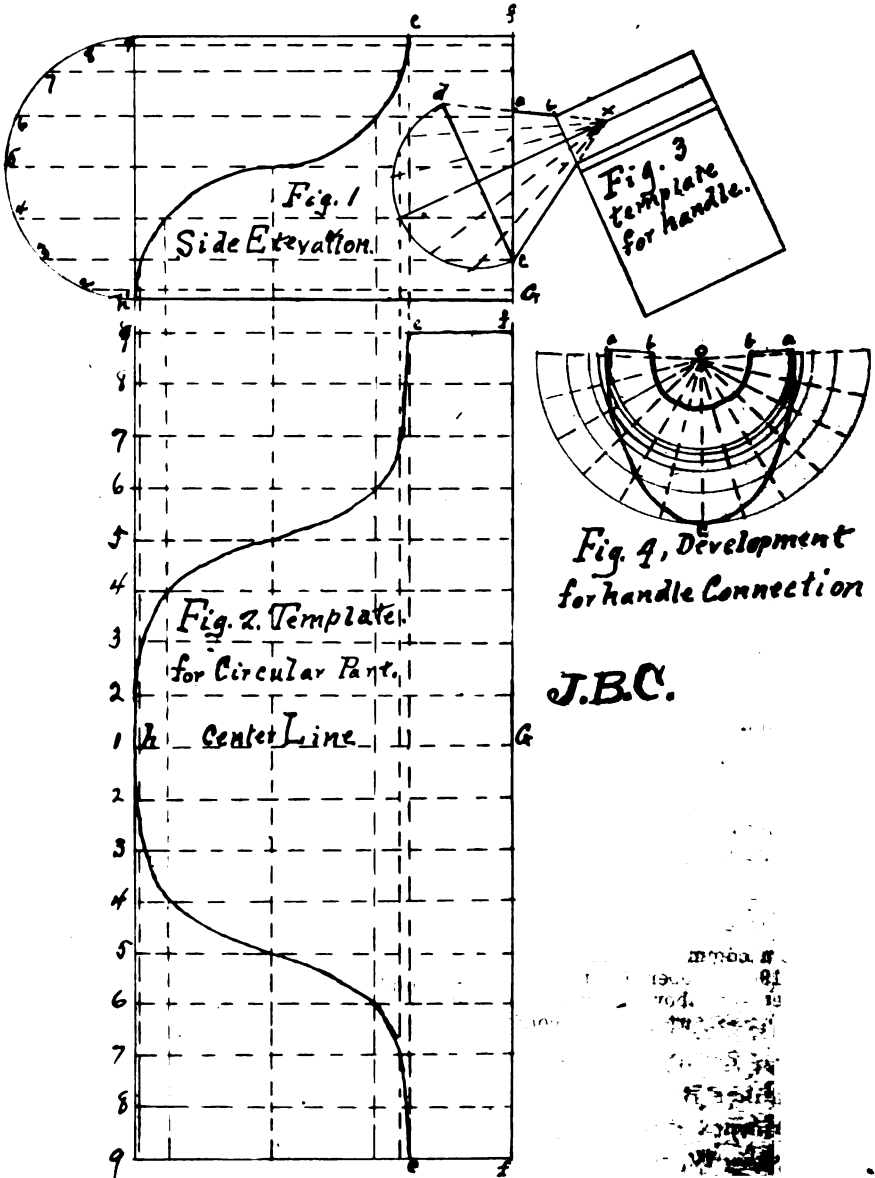

J.B.C.

TO LAY OUT A HAND SCOOP.

Last month we showed how to develop a scale scoop, and this issue we will proceed to show how to lay out a hand scoop.

Fig. 1 shows the side elevation. First, extend top line *e-f* out indefinitely and parallel with the base line *h-g*; strike vertical line from *H* up and at right angles with base line *h-g*. Divide into two parts line from *h*, to top line *e-f*, with one point

of dividers at center of division strike half circle. Divide this into eight equal parts and number the points of division from 1 to 9; from these points of division draw lines parallel with top and bottom lines, and where these lines across the edge of scoop, strike down and at right angles to the sides of scoop. Continue these indefinitely and mark off the circumference of scoop and divide into twice the number of parts as there

are division spares in the semi-circle, and from these points, strike lines at right angles to the vertical lines. Commencing at the center line, number these lines from one to nine on each side of center line.

Next, starting at center line, trace a line through points where these vertical and horizontal lines cross each other, as shown in Fig. 2. This will complete template for the circular part of scoop, which when cut out and trimmed will be rolled into a circle; the end for this will be a plain, circular head, large enough to put a small flange on it and fit into the circle end of scoop.

We will next proceed to develop handle and the tapering handle connection. The handle is but a plain straight tube. Fig. 3 shows template for this section. All it is necessary to do is to roll this round; the handle connection is the shape of the frustum of a cone cut at a slant on the large end. Extend line a-b to x one end and to d on the other, making distance from x to d equal from x to c. Strike a line from d to c, divide this into two equal parts and from the center strike semi-circle from d to c; divide this semi-circle into 6 equal parts and from these points of division strike

lines to center line and at right angles to same.

Note.—An error appears in the above cut with reference to this. The lines show direct from points of division to point X, when they should run parallel with the center line of cone until they cut line D-C and then from where they cut line d-c direct to point x. This was overlooked until tracing was sent engravers.

Next take dividers and set them distance from x to c and with one point at O, Fig. 4, strike circular line; divide this into 12 parts, using dividers as set for dividing half circle. Next take the length of the other division lines from x to where they strike end of scoop and with one point at O, Fig. 4, strike the other smaller circular lines in Fig. 4, and through points where these division lines and circular lines cross, trace a line on each side of center as shown. Next, the distance from x to b and with one point at O strike small circular line b-b, Fig. 4.

This will complete template for handle connection; roll this up into a circular form, allowing sufficient material on each end for lap and flange to connect with head of scoop.

International Officers' Reports.

REPORT OF INTERNATIONAL VICE-PRESIDENT NOLAN.

Cumberland, Md., November, 1915.

Dear Sir and Brother:

Just a short report for the official Journal and desire to say that conditions have somewhat improved in the Southeast District; therefore, will report progress. Let us hope for greater activity in the near future, as the railroad shop men for some time past have been up against it sure.

October 1, by instructions from the International President, I left for Washington, D. C., to meet a committee from Lodges No. 450 and No. 19. October 7 left for Washington to meet the above committees, and also to have an opportunity of conferring with Brother Berres of the Metal Trades Department on matters pending in connection with navy yard business.

On reaching Washington, D. C., met committee of Lodge No. 450, Brothers Evans, Kilroy and Kelchner, who explained cause of grievance in the boiler department. October 3, in company with the above committee, called on the Secretary of Navy to secure a conference, but found that the secretary had agreed to meet a committee from all trades employed in the Washington yard a 5 p. m., October 5. In the meantime Brother Berres of the Metal Trades Department had a previously arranged conference with the Assistant Secretary of the Navy for a committee representing Lodge No. 19

of Philadelphia, Brothers Higgs and Goodfellow, who reached Washington on the evening of October 3, when both committees from Lodges No. 19 and No. 450 held joint meetings at the Atlantic Hotel to discuss matters in connection with the Washington and Philadelphia navy yards, and both committees were unanimous in their opinion for the boiler makers naval district was an absolute necessity.

In order that matters of general interest to the boiler makers employed in government navy yard could be taken up with the Department in Washington by a duly authorized representative of such district and under the jurisdiction of the International Brotherhood. October 4, in company with committee of Lodge No. 19, also Brother Berres, held the arranged conference with the Hon. Franklin D. Roosevelt, Assistant Secretary of the Navy, in connection with wage increase as recommended by the wage board at the Philadelphia Navy Yard in 1914. The meeting was entirely satisfactory to the committee, who left same evening for their homes, with the knowledge and assurance that much had been accomplished for the men employed in the boiler shop at the Philadelphia yards.

Before closing report in connection with the above meeting, I desire to say that considerable credit is due the committee from Lodge No. 19 for their practical explanation before the Secretary of Navy relative to the class of work done at the Philadelphia Navy

Yard, as well as producing many statements from reliable firms in Philadelphia and vicinity which showed a much higher rate paid their boiler makers than paid by the government.

The Assistant Secretary, Mr. Roosevelt, questioned the committee very closely on wage conditions at Philadelphia, Pa., as well as the number of boiler makers employed by these firms, which was answered in a straightforward, satisfactory manner, leaving no room for doubt whatever that the boiler makers employed at the Philadelphia Navy Yards were entitled to generous consideration, wage increase included, and trust the earnest appeal of committee will bring about the desired results.

Lodge No. 19, through the official Journal, desires to thank Brother Berres for kindness shown our committee while in Washington, as well as our sincere appreciation for advice while in conference with Mr. Roosevelt in our behalf on the wage proposition. Same date, October 4, at 5 p. m., each trade affected by wage increase at the Washington yard had a separate meeting with the Hon. Secretary of the Navy, giving each ample time to fully explain their grievance. The Assistant Secretary of the Navy was present at meeting, also Brother Berres, representing the Metal Trades Department during the entire conference of all the trades.

At 5:30 p. m., the committee representing Lodge No. 450 were introduced to the Secretary. Brother Evans as chairman at once proceeded to explain to Secretary Daniels why the grievance of the boiler makers at the Washington yards was a just one and founded on data in compliance with instructions from wage board secured at a considerable expense to the men employed in the boiler department; therefore, sufficient evidence had been placed before the wage board to at least justify an increase according to data presented them; also there should be a more equal distribution of increase so that all boiler makers would receive an equal pro rata.

Brother Evans read a carefully prepared paper which was a concise statement of conditions in the boiler department, as well as the high grade of work constructed there, using clean cut, mechanical illustrations of the difficult work done by mechanics in that department who have been trained by long experience in that particular class of work and giving entire satisfaction at all times to the foremen and higher officials in charge for the successful prosecution of the work at all times under construction. Many questions were asked Brother Evans by the Secretary of the Navy, which were answered satisfactorily to all present in the Secretary's office.

The committee's appeal for the men they

represented was a splendid effort and to the point, never losing sight of one important fact, that they were there in the interests of every boiler maker employed in the Washington yard, and concluded in the hope that the Hon. Secretary of the Navy would give their appeal his most earnest consideration. The writer desires to say that Lodges No. 57, No. 450 and No. 19 have committees that are fully able to cope with and handle any grievance before the Navy Department, as the committees representing the above lodges are fair in the discussion of grievances and well posted on naval regulations as to conditions and wages.

October 5, left Washington, D. C., to attend council meeting of the Brotherhood at Kansas City, Kas., remaining there until the 15th, when, by instructions of Brother Franklin, I left for Portsmouth, Va., to represent the Brotherhood at convention of the Southeastern Consolidated Federation of Railroad Shop Trades, reaching there on the night of the 17th. October 19, at 10 a. m., President Garvey called the convention to order and in a neat and forcible address reminded the delegates of the importance of the session at that time and he hoped the convention would be a repetition of previous ones, where absolute harmony, as well as beneficial laws, were enacted for the protection of the railroad shop men, which was applauded by the entire convention.

The convention was an exceptionally large one, which naturally indicated the interest manifested by the shop employes in the Southeast District, and the following railroads were represented by delegates, as well as presidents of federated systems, also Grand Lodge officers representing Brotherhood Railway Carmen, International Association of Machinists, Brotherhood of Electrical Workers, Brotherhood of Blacksmiths and Helpers, Sheet Metal Workers, Brotherhood of Boiler Makers, Iron Ship Builders and Helpers of America and a representative of the Plumbers, who attended the session. Roads represented were: S. A. L.; N. & W., C. & O.; A. C. L.; Virginian Railway; Southern & Allied Lines; Central of Georgia, and Norfolk Southern Railroad.

The following speakers were introduced by President Garvey, who are well known in Tide Water, Va., as advocates of the labor movement, namely: The Hon. Frank Hope Mayor of Portsmouth, Va.; Mr. Robert E. Glover, sheriff—by the way, Sheriff Glover was a charter member of Lodge No. 57, Brotherhood of Boiler Makers, Iron Ship Builders and Helpers, organized many years ago, when labor organizations were few and far between in the Old Dominion; Mr. Charles T. Bland, who was at one time a member of the Painters' Union, but now a member of the legal fraternity and attorney for the city of Portsmouth, Va.

The last speaker, but not the least, was Mr. Anderson, collector of the port, who de-

livered a pleasing address and as a representative of the government, closing by extending an invitation to the delegates and their friends for a trip around the harbor on the ocean-going tug Memphis, which gave them and their friends, many of whom were present, an opportunity of seeing the Norfolk Navy Yard, also many other points of interest, including Old Point Comfort and the famous Rip-raps.

After these distinguished visitors had completed their addresses, Brother A. O. Wharton, President of the Railway Employees' Department of the American Federation of Labor delivered a very able address in connection with the department, outlining its policy and future possibilities through the co-operation of the railroad shop men, impressing on the delegates that such an organization was an absolute necessity for economic justice and later on the second day of the convention a unanimous vote was cast to affiliate with the Railway Employees' Department of the American Federation of Labor, bringing about a splendid force of organized shop men who understand what the labor movement means, yet conservative and loyal when put to the test in defense of its principles.

The next convention of the Southeastern Consolidated Federation will convene at Cincinnati, O. 1917. May the good work continue in the interest of the railroad shop trades until justice is fairly established on a foundation which will be impossible to shatter. The following officers were elected to represent the Southeastern Consolidated Federation: Thomas J. Garvey, President; J. Peyton, Vice-President, and Arthur Gladhill, Secretary-Treasurer. Brother Thomas of Lodge No. 238 was elected Boiler Makers' Executive Board member, who is also President of District No. 41, C. & O. Railway System, is a young, active worker and I am confident that he will make a success if given the proper support.

The following boiler makers were representatives as delegates to convention: Brother Garvey, Southern Railway; Jewell, S. A. L.; Barksdale, M. & O.; Thomas, C. & O. Railway; Moore, A. C. L. Railway; Horgen, N. & W. Railway; Buchheit, Central of Georgia, and Blackwell of the Virginia Railway.

After convention adjourned there was a little mix-up at the S. A. L. shops, Portsmouth, Va., which was adjusted satisfactorily on the 24th.

October 24th, received instructions from President Franklin to proceed to Washington, D. C., on a grievance between Lodge No. 450 and the Navy Department; met Brother Evans on the 26th, and arranged a meeting with the Assistant Secretary of the Navy on the 27th. Same date, 26th, in company with Brother Evans, called on the proprietors of two contract shops at Wash-

ington, D. C.—Boswells, also Webber & Thomas, both of whom signed an agreement with the International Brotherhood, making agreements complete with every contract shop in that city. Lodge No. 450 deserves considerable credit, as the active members worked hard to line up all the contract shops in the capitol city and have accomplished it after several years of continual plugging, and Lodge No. 450 desires to serve notice on all boiler makers and helpers coming that way: "No card, no work."

Same date, afternoon, called on the mechanical superintendent of the government printing office on the possibility of maintaining a permanent force of boiler makers employed in his department, and he informed me that he would be pleased to meet a committee from our local lodge or give him the names of a committee, but arranged to have a committee meet him, Brothers Evans and Kilroy, which meeting took place also on the 27th, but I am not aware of the result, as I had to leave Washington same evening to attend a meeting of Lodge No. 494. On the same afternoon, with the committee from Lodge No. 450, Brothers Evans and Kilroy held an arranged meeting with the Assistant Secretary of the Navy relative to late increase by the wage board, also late recommendation by the commandant of the yard, but nothing was accomplished, unless a change of rating is recommended and was so informed by the Assistant Secretary, which I trust will materialize in the interests of the men.

Have just received a communication from the Secretary and Assistant Secretary of the Navy in reference to the above, which has been mailed to the secretary of Lodge No. 450, in which the Secretary of the Navy has approved the findings of the wage board for 1915 and 1916, both special and general increase; therefore, comments are unnecessary. On night of October 27, attended a regular meeting of Lodge No. 494, which is a ship builders' local, and desire to say some very active work has been done by the officers and members, having succeeded in building up a large membership and increasing very rapidly. It is only a question of a short time when Lodge No. 494 will have a membership of two hundred or over. Every ship yard in the country should do likewise, as there never was a better opportunity to secure better working conditions, as well as a possibility of getting agreements between the ship builders and ship building firms. The only reason why they are not in a position to do so at present is due to the lack of organization.

At a regular meeting mentioned above, the hall was packed and 26 new members initiated, while several applications for membership are pending. In fact, a special meeting was arranged for November 2, to initiate a number of candidates in order to give the lodge an opportunity to transact its business at regular meeting. October

28, left Wilmington, Del., for Philadelphia, Pa., to meet the officers of Lodge No. 19, in connection with business now pending before the Navy Department and wage board at the Philadelphia Navy Yard; met Brothers Goodfellow and Hopkins and discussed the situation at issue, agreeing on a certain line of action if necessary; while at Philadelphia, had the pleasure of meeting Brother Scott, General Organizer of the International, who was there on business with Brother Napeir, business agent of Philadelphia, Pa. While in Philadelphia, a peculiar incident occurred, a strike of unorganized boiler makers and helpers at the B. & O. shop on account of the foreman, who saw his opportunity to drive them beyond the speed limit generally used in unorganized shops.

The men at one time were organized and had pretty fair conditions, which should be an object lesson to them as well as every other unorganized boiler maker and helper in Philadelphia, that without organization they are at the mercy of the bosses, who in many cases know no principle or honor in dealing with their fellow men; yet the men know this and still won't organize. If all wage workers were organized, the industrial situation of today would be far different, for every wage earner would then get a fair share for his labor. If organized, there wouldn't be any industrial battlefield which has been fought on many occasions for the last thirty years or more. We have all heard of the slaughter of labor's heroes in their legitimate fight for human rights. We have many times heard the crack of rifles in the hands of uniformed soldiers, pouring their missiles of death into the ranks of the wage earners, and in spite of this fact a large majority do not realize the necessity of organization.

The soil of our country many times has been washed with the blood of honest labor in the interests of financial greed, yet the workers fail to heed; but the time will come when conditions will force them together to correct their mistakes of the past, so as to be in a position to join hands with the American labor movement, which has a grand and great mission to fill. In order to sweep from the industrial field every form of corporate injustice to the American wage earner and establish a civilization that makes extreme poverty unknown and war impossible.

October 30, left Philadelphia for Rocky Mount, N. C., according to instructions received October 20, while the Southeastern Consolidated Federation was in convention at Portsmouth, Va., to work in co-operation with Brother McCreery of the Carmen and Brother Alyward, President of the federation on the Coast Line Railway.

Hoping this report is satisfactory to the

officers and members of the International Brotherhood, I remain

Yours fraternally,

THOS. NOLAN,
International Vice-President.

P. S.—Owing to being very busy at this time, my report was written through the courtesy of Brother Nolte, Vice-President of the Carmen.
T. N.

A COMMUNICATION FROM INTERNATIONAL VICE-PRESIDENT HINZMAN.

Kansas City, Kas., Oct. 26, 1915.

Dear Sir and Brother:

This is to advise that the Executive Council in their regular session October 12, revoked the card of H. C. Rawlings, Reg. No. 63397, for non-payment of a note executed in the International President's office, November 10, 1914, for the sum of \$17.25; \$9.25 of this amount was a clothing bill stood good for by the members of Lodge No. 521 of Van Buren, Ark., and the balance, \$8, was borrowed money from one of the members of Lodge No. 521.

This bill had been standing for more than four years. Brother Rawlings had deposited his due book with the members of No. 521 for the borrowed money, and the latter, through misrepresentation, obtained a duplicate due book from the International Secretary-Treasurer. The duplicate issued by the International Secretary-Treasurer was held up November, 1914, and Brother Rawlings was permitted to go on his way after executing a note to cover the amount of \$17.25, to promise to pay same within 60 days. Nearly 11 months have elapsed, and no payment having been made upon same, the Executive Council ordered that his membership be revoked and he be expelled from the Brotherhood until such time as he takes up the note executed in this office. It was ordered by the Executive Council that this action be published in the official Journal and all secretaries be notified of same. Any secretary taking up the card and book of Brother Rawlings will please forward same to the International President's office.

Yours fraternally,

AL HINZMAN,
First International Vice-President.

REPORT OF VICE-PRESIDENT MERRIGAN.

From the 15th of September to the 15th of November, I visited the following places: Hamilton, Fort William, Winnipeg, Medicine Hat, Calgary, Edmonton, Kansas City and Halifax.

While in Hamilton, I attended initial meeting of the shop trades employed by the

T. H. & B. R. R., who had made application to the Railway Department of the A. F. of L. for a charter. The following trades were represented on the charter: Carmen, Blacksmiths, Boiler Makers and Helpers and Machinists. Officers were elected, and charter fee forwarded to the Railway Department. The meeting was interesting, and all delegates voiced the approval of the members they represented towards system federation. All crafts employed, or rather mentioned above, are practically one hundred per cent organized, and no doubt will make a success of their new undertaking.

I also attended meeting of Lodge 421, and explained some matters in which the members were not versed. A proposed schedule had been submitted and approved. Lodge 421

that every attention would be given them by Lodge 392.

At Calgary I had a special meeting of the members of Lodge No. 392. Many matters were discussed pertaining to organization, and the necessity of keeping in touch with men at outlying points. Report of trade was fairly good.

At Edmonton I attended a meeting of Lodge No. 279 and found that the officers and members are greatly interested in organization. This lodge was organized during the month of February of the present year, and from their reports it is evident that they have not been idle in making it known to men at outside points, that there was a lodge of our Brotherhood in Edmonton. They are to be commended on the in-



Original.

Cor. Secretary, Lodge No. _____

Please forward the following supplies:

Date, _____ 191__

Name _____

Street Address _____

Post Office _____ Box No. _____

City _____ Province _____

DO NOT SIGN BACK, IT IS LIABLE TO BE BROKEN THROUGH THE ENVELOPE AND AS LONG AS APPROVED MEMBERS TO SIGN BACK OR SIGN TO WHAT IS IN IT MUST BE KEPT UNLESS RETURNED TO THE ENVELOPE, AND THEN SEND BY REGISTERED MAIL.

ENCLOSED FUND		\$	cts.
Cash	as per bank check		
P. O. Money Order			
Express Money Order			
Total Amount Sent			

Extract from Constitution:

"Any member becoming delinquent in the matter of three full months dues, or becoming suspended for the same period of time or longer, shall lose all rights to benefits provided for in Article XIV, Section 4. When a member forfeits his rights to such benefits on account of becoming suspended he will not be entitled to such benefits again until he has been reinstated and has in continuous good standing in this Brotherhood at least 125 weeks months, and then only for the lowest amount provided for in Article XIV, Section 4, namely Fifty Dollars (\$50.00)."

NAME	Qualifications as per By-Laws	Education	Industry	Business	Domestic	Foreign	Months	U.S. Money	By Postal Note	Check	Bank	Branch	Country	Address	Phone	Notes	\$	cts.
Total																		

THE ABOVE IS A CONDENSED REPRODUCTION OF THE REPORT BLANK ADOPTED BY THE EXECUTIVE COUNCIL, AT ITS RECENT MEETING, FOR THE USE OF MEMBERS WORKING AT ISOLATED POINTS.

reported trade brisk. Overtime had been resorted to, and trade in general was good, considering the slackness they had experienced.

At Ft. William I had a special meeting of the members that were endeavoring to hold the charter of Lodge No. 505. Trade at that point had become so dull that it employed, and vacancies for boiler makers and helpers.

At Medicine Hat, I found that a number of members there had allowed themselves to go in arrears, who were members of Lodge No. 392. I had an understanding with these men, as to the cause of their delinquency and had them to agree to be reinstated, and

terest taken in organization. I had been requested to visit some points under the jurisdiction of Lodge No. 279, but owing to the time at my disposal, before attending the executive council meeting, I was unable to comply with the request, and made arrangements with the lodge that were satisfactory. Trade in and around Edmonton was good, and the outlook encouraging for some time to come. Boiler makers and helpers were in demand, and few applications.

In the November issue of the official Journal, many of the more important matters that the executive council had to deal with are explained, and as the minutes of the

meeting are now on file in all lodges, it is hardly necessary for me to repeat what has been reported, other than to confirm what has been stated through the columns of the Journal.

There is one subject that I would like to enlighten the members on and that is the "Supply Blank Book" that the writer introduced and has adopted. This book is for the benefit of our members who are working at outlying points, and where there is not sufficient members to carry on the business of a lodge successfully, and thereby have to forward their monthly dues to the secretary of the nearest lodge, and make application for other supplies that they may require from time to time. This book is now being used at many outlying points in Canada, and good results have been obtained as a consequence of the use of this book. I believe a fac-simile of one of the blanks taken from the book will appear in the December issue of the Journal, and the members will get familiar with this form without much trouble. The local lodge can arrange with some member at the outlying point to collect dues from the members at that point, and have same entered on the looked to the members as though it would be necessary to return the charter to headquarters as the membership had dropped to a quorum, owing to the lay-off of members, who had to seek employment elsewhere. However, I arranged with the members to hold their charter, and that I would endeavor to have several suspended members reinstated at the earliest possible date, and if possible to have some other members employed in the vicinity transferred to Lodge No. 505, so that they would be in a position to hold meetings and maintain their lodge until such time as trade again picked up, and would then be able to carry on their business as in the past.

While in Winnipeg, I had a special meeting with Lodge No. 529, and met with the several officers and members of Lodges Nos. 126 and 451. I found that Lodge 529 had practically a new set of officers, and they were doing good work towards building up their lodge and operating same on a business basis. The members of Lodge No. 529 are now employes of the government railway, and were anxious to have all men employed organized at least between Winnipeg and Cochrane. The government is now operating the shops formerly occupied by the G. T. P. at Transcona, which is under new management. The members of Lodge No. 126 reported trade slack and no immediate prospect of conditions becoming more active. Lodge 451 reported trade good. Overtime being worked, with night and day forces blank and forwarded to the secretary of the local lodge, who will cancel said stamps and return same to the member who ordered same, who will then place stamps on the members' books who paid for same. This method will have a better effect towards keeping our members in good standing, and

a protection to our members at the outside points, should at any time all not go well at the local lodge. It will save the individual members at outlying points, the necessity of letter writing and save them from being suspended, etc. These books may be purchased from the I. S. T. I don't know what the price of the book will be, but it will not cost very much. I would ask that all lodges having members at outside points purchase one of these books and give it a trial. It works out satisfactory.

At this writing I am at Halifax, in the interests of the members of Lodge No. 580, who have been on strike since August 1, against the Halifax Graving Dock Co. and the T. Hogan & Co. The men have the situation well in hand and are optimistic as to the future. Pickets are doing good work, and the strike is proving effective and the men are more determined than ever to win this strike.

As this will be my last report of the year, I wish you all a Merry Christmas and a Happy New Year. I am,

J. P. MERRIGAN,
Third I. V. P.

REPORT OF FOURTH INTERNATIONAL VICE-PRESIDENT WEYAND.

Kansas City, Kas., Nov. 1, 1915.

Mr. J. A. Franklin,
International President.

Dear Sir and Brother:

The following is my report for the months of September and October, 1915:

At the conclusion of my last report I was stationed in the city of Baltimore, Md., on an organizing mission in the interest of Lodge No. 193.

On Saturday, September 4, I was requested to visit the Maryland Elevator, by one of the members of Lodge No. 193. The boiler makers reported to me that the iron workers were using every method to drive them off the work, which was beyond dispute boiler makers' work. In accordance with the agreement between the two organizations. On my arrival at the plant, I met the business agent of the iron workers of Baltimore. After a great deal of argument, we were able to adjust the matter, and our members remained on the work. In the evening I left Baltimore for Cleveland to spend Labor Day at home with my family.

Tuesday, September 7, I returned to Baltimore to again take up the organizing work. On my arrival in Baltimore I visited Fairfield and Curtis Bay, where a refinery and other new plants were under construction, and I found that a number of tanks were to be built in those plants.

On September 9 I received orders by wire from Vice-President Hinzman to go to Elmira, N. Y., at once, as the boiler makers of Lodge No. 225 had a grievance at the La France Engine Company's plant. On my ar-

rival in Elmira I found that Brother Stevenson, president of Lodge No. 225, had been discharged. I met with Brother Stevenson and went over the circumstances in connection with the case, and took the necessary data to present to the management and endeavor to prove that he was unjustly dismissed and should be reinstated.

In the evening we had a special meeting with the Metal Trades Council, to discuss the merits of the case with the delegates of the several trades. It was decided to appoint a Metal Trades committee to wait on the management the following morning and arrange for a conference that evening after quitting time, with Mr. Mason, superintendent of the shop. Brother Stevenson and myself were to be present at the conference in order to present our side of the case. At the appointed time Brother Stevenson and myself were at the office to meet with the committee and the management of the company. Mr. Mason was at the office door, waiting my arrival, and requested me to come into the office to discuss the case. To my surprise, I found that Mr. Mason had called the committee into his office that afternoon and had gone over the matter with the committee without myself or Brother Stevenson being present. I asked Mr. Mason what his reason was for calling in the committee without myself and Brother Stevenson being present.

Mr. Mason's answer to me was that he would not meet Brother Stevenson in reference to the matter, but that he was willing to meet me without the committee and hear my side of the case, but would not agree to have me meet with the committee and give me an opportunity to question his foreman as to whether they were discriminating against Brother Stevenson, owing to the part he took in the late strike. This was the main point at issue, as I had considerable data to prove that this was the case. I informed Mr. Mason that I insisted I meet him and his foreman with the committee and be given an opportunity to defend Brother Stevenson, by all means. But Mr. Mason refused to grant me that privilege.

I then insisted that he meet Brother Stevenson and in the presence of Brother Stevenson state to me what the charges were against him. Mr. Mason agreed to this and called Stevenson in the office and stated before Stevenson that he was discharged because he interfered with other departments. I told Mr. Mason that the charge he just stated was incorrect, and I was in a position to prove my statement, if he would give me the opportunity to meet with the committee and question his foreman in the presence of the committee. But Mr. Mason would not agree to my proposition.

The same evening we again had a special meeting of the Metal Trades Council. At the meeting, the committee appointed to

handle the case reported that they had made the arrangements for a conference that evening with Mr. Mason, as instructed by the Council. But at 3 o'clock that afternoon he, Mr. Mason, sent for the committee and told them that he did not have time to meet the committee that evening and preferred to discuss the case at that time. The committee fell for Mr. Mason's game and discussed the case without myself or Brother Stevenson being present.

It was also reported at the meeting that one of the machinists had reported to his foreman that Brother Stevenson was interfering with other departments and from this report came the foundation for the charges against Brother Stevenson. It was brought out that on one or two occasions Brother Stevenson had visited the erecting department and found some of the machinists driving rivets on truck frames. Brother Stevenson, passing by those men, did not interfere with them, but merrily said, "You ought to cut that work out, as it is boiler makers' work." Hence the charge against Brother Stevenson.

The Council against instructed the committee to see Mr. Mason the following morning and arrange for another conference and endeavor to have Mr. Mason to agree to have myself and Brother Stevenson present. The following evening we had another special meeting of the Council, and the committee reported that Mr. Mason would not meet Vice-President Weyand with the committee, but that he was willing that the matter be submitted to a board of arbitration, consisting of six men, three from the several trades and three from the company, and, if necessary, they to appoint the seventh man, and Brother Stevenson could appear before this board and present his side of the case. I told the committee and the Council that I did not think much of Mr. Mason's proposition, as I did not believe Brother Stevenson would get a square deal. But the Council concurred in the committee's report and accepted Mr. Mason's proposition. Their action convinced me that we would not have the united support of all the trades, if it came to calling a strike to force the reinstatement of Brother Stevenson; consequently, the case went before the board of arbitration.

The trial took place the following day. In justice to the three men appointed from the several trades, I may say they were good, strong union men and used every argument and method within reason to convince the other side that Brother Stevenson should be reinstated. But it was understood that the men from the company's side were for conviction and our only salvation was in the seventh man. The seventh man agreed upon was a carpenter-contractor, who employed union carpenters. But in rendering his decision he was found on the company's side, and Brother Stevenson lost his job.

On Thursday, Septemebr 23, I returned to Baltimore to again take up my unfinished work, as I had some matters to take up in connection with the death claim of our late Brother Kilcullen, who died in Baltimore, August 1, 1915; also visited Fairfield and Curtis Bay to keep in touch with the work to be erected in those plants. I find there is going to be considerable work in and around the vicinity of Baltimore in the contract ship yards and a large amount of field work.

While I have had very good success in lining up our delinquent members in that part of the country, but to continue this work it will require someone on the job continually, owing to the fact that when the local men who are employed on the job are found talking to those who are not members, by the officials in many cases, they are confronted with discrimination and in many instances lose their jobs and are being classed as agitators.

As I had been notified by the International President that the Council would meet in Kansas City on October 4, I left Baltimore on September 30 for Cleveland. On October 2 I left Cleveland for Kansas City and arrived in Kansas City on Sunday evening, October 3. As the Council was in session three weeks, adjourned October 24. This time was spent in regular session of the Council, in going over the many subject matters brought to the attention of the Council.

After adjournment of the Council, I was requested by President Franklin to remain at headquarters to take charge of the International President's office, owing to the fact that President Franklin and First Vice-President Hinzman were to start for San Francisco to attend the convention of the American Federation of Labor and other departments.

This concludes my report for the two months ending November 1, 1915. Trusting the same is satisfactory, and with best wishes and kindest regards, I am

Yours fraternally,

LOUIS WEYAND,

Fourth International Vice-President.

A COMMUNICATION FROM INTERNATIONAL VICE-PRESIDENT WEYAND.

Kansas City, Kas., Nov. 10, 1915.

Dear Sir and Brother:

Owing to the adoption of the Fidelity Department in this International Brotherhood, and in compliance with the laws of our constitution including the provisions in application pertaining to the accounts of the local financial officers and submitting a copy of the trustees' report to the International office of the Fidelity Department, the Executive Council, at their recent session, took

up the proposition of adopting a uniform Local Trustees Report Sheet, in order to assist the local trustees in filing a uniform report of their audit to the International office, in accordance with the laws of the Fidelity Department. We respectfully request that all subordinate lodge officers and trustees will make a special effort to put this system into effect in our Brotherhood and endeavor to fill out the various items of business handled by their local lodge officers. By complying with this system of reporting to the International lodge, you will protect your local in any just claim your lodge may have against the Fidelity Department in the future, and we sincerely trust you will comply with the same.

With best wishes, I am,

Yours fraternally,

LOUIS WEYAND,

Fourth International Vice-President.

A COMMUNICATION FROM NINTH INTERNATIONAL VICE-PRESIDENT SCHMITT.

Columbus, Ohio.

Dear Sir and Brother:

You will find enclosed copies of letters that I have mailed our lodges, and letters that I am mailing out to organized labor in general.

This letter of protest which was endorsed by the Columbus Federation of Labor, and published in the press, has caused considerable comment among the politicians, and since then the administration has been trying to square itself as to these appointments, and if these letters of protest are sent in as requested it is more than likely that these appointments will be recalled.

And you can see by the letter sent to our lodges I have urged them to get on the job, which I trust they will so that there will be an eligible list in case these appointments are recalled, so that boiler makers may have an opportunity to fill these positions in the Boiler Inspection Department, which rightfully belongs to them.

With best wishes and kindest regards, I am,

Fraternally yours,

J. F. SCHMITT.

Columbus, Ohio, Nov. 13, 1915.

To Organized Labor—Greeting:

The following resolution was adopted by the Ohio State Federation of Labor at the convention held at Mansfield, Ohio, October 11-16, 1915:

Whereas, It has come to the attention of this convention that the appointment of state employes in departments affecting labor are not in conformity with the best interests of the wage earners and the effi-

ciency that should prevail in the duties devolving upon these men; and,

Whereas, In this method of making appointments the safety and health of the wage earners is placed in jeopardy; therefore, be it

Resolved, That we, the delegates to the thirty-second annual convention of the Ohio State Federation of Labor, go on record as being opposed to the appointment of men not qualified under the law and known enemies of labor to positions in departments that labor has created, and depends upon organized labor to see that justice is administered, and we are further opposed to these inefficient servants displacing men who have proven their qualifications and efficiency.

In accordance with the above resolutions I am inclosing you two letters of protest against appointments of unfair men in the Boiler Inspection Department, one of which it is requested be forwarded to Hon. Frank B. Willis, Governor, State Capital, Columbus, Ohio, and one to Mr. George Stoughton, Secretary of the Industrial Commission, Majestic Bldg., Columbus, Ohio.

Trusting that the above request will be given immediate attention, as the time to prevent the present appointments from becoming permanent appointments is limited.

Fraternally yours,

J. F. SCHMITT,
Ninth International Vice-President.

COMMUNICATION FROM INTERNATIONAL SECRETARY-TREASURER.

October 27, 1915.

To the Officers and Members of All Subordinate Lodges, Greeting:

My attention has been called to several errors in the expense accounts of some of the Vice-Presidents and Organizers in the Third Quarterly Report of 1915. Immediately upon receipt of these complaints, I investigated the matter through Russell Printing Company, who had printed the quarterly reports, as I was under the impression that after we had proof-read the quarterly report that they made the corrections that we instructed them to make. So the Russell Printing Company investigated this matter with the Western Typesetting Company, who does the linotyping for the Russell Company. Upon investigation they found that they were responsible for the errors, and I am reproducing a copy of the letter signed by Henry C. Alwes of this company, which, no doubt, will be self-explanatory:

"Kansas City, Mo., Oct. 13, 1915.

"Mr. F. P. Reinemeyer,
Secy. I. B. of B. M., I. S. B. & H. of A.

"Dear Sir:—In the rush due to the shortness of time in composing the last quarterly report, there were several errors, all of

which appear to be material unless satisfactorily explained.

"On page 16, in the expense account of J. P. Merrigan, in the period from July 1 to July 16, the miscellaneous expenses should be 35c, instead of \$3.35.

"On page 19, the signature to the report of John J. Dowd should be that of John J. Dowd, instead of Chas. F. Scott.

"On page 22, the signature of Chas. F. Scott's report should be that of Chas. F. Scott, instead of John J. Dowd, and the salary of Chas. F. Scott for the period of September 1 to September 15 should be \$50.00 instead of \$62.50.

"There errors were all made by us and were incident to the shifting of forces at 4 o'clock in the afternoon.

"Anything we can do to correct this report and make it public to your membership will be gladly done by us. The Russell Printing Company are in no way responsible for these errors, as we assume responsibility and furnish them with O. K. matter.

"Sincerely yours,

"WESTERN TYPESETTING CO.,
(Signed) "Henry C. Alwes."

Trusting that the above letter will make this clear to each and every members of the Brotherhood, with best wishes and kindest regards, I beg to remain

Yours fraternally,

F. P. REINEMEYER,
International Secretary-Treasurer.

COMMUNICATION FROM INTERNATIONAL SECRETARY-TREASURER.

October 27, 1915.

To the Officers and Members of All Subordinate Lodges, Greeting:

In the past few months we have had several traveling members of this organization call at this office, applying for duplicate due books and stating that the subordinate lodge secretaries, as well as some of the members, advised these traveling brothers who had the misfortune to lose their due books to come to Kansas City and they could secure duplicate due books.

Now, I wish to state to each and every secretary, as well as the members, that it must be distinctly understood that the International Secretary-Treasurer does not issue duplicate due books to anyone, except by a sworn affidavit coming through the secretary of the lodge to which the member last belonged.

Therefore, I am publishing this at this time to notify all members when they have the misfortune to lose or have their due books stolen, that they must fill out one of the official affidavits and send to the local secretary who issued the last stamp, and he must forward the affidavit to this office,

with 25 cents to cover the cost of the duplicate due book.

I trust that all secretaries and members will take notice of this letter and give it due consideration.

Assuring you of my best wishes, I beg to remain

Yours fraternally,

F. P. REINEMEYER,
International Secretary-Treasurer.

REPORT OF R. C. McCUTCHEON,

International Delegate of the B. of B. M., I. S. B. and H. to Thirty-first Annual Convention of the Trades and Labor Congress of Canada, Held in the Labor Temple in Vancouver, B. C., September 20 to 26, Inclusive.

To the Officers and Members of our Organization:

In making a report of this kind it will be necessary to curtail and in some cases eliminate some of the proceedings of minor importance, but in so doing I will try and report at some length on those propositions which will be of the most interest to our membership.

The convention was opened with a short talk by Brother McVety, President of the Vancouver Trade Council, who was followed by President Watchman of the British Columbia Federation of Labor; W. C. Bowser, Attorney General of British Columbia, Dominion Minister of Labor; H. J. Conway, fraternal delegate from the American Federation of Labor, and Andrew Furseuth, Secretary of the Sailors' Union, all giving short opening addresses, after which the chair was turned over to President Watters.

The substance of Attorney General Bowser's talk was that the British Columbia Provincial Government was forming a committee for the purpose of investigating the different workman's compensation acts throughout the United States and Canada. The committee to consist of three persons, one to be appointed by the Manufacturers' Association, one by the Trades Congress and one by the Provincial Government, their expenses to be paid by the government and upon whose report would be based the proposed Workmen's Compensation Act of British Columbia.

The talks of the other speakers will be dealt with later.

That the convention would reflect, through a thin attendance of delegates, the serious extent to which organized labor in Canada had been affected by the prevailing economic conditions and the drainage of trade unionists from industrial to military pursuits was anticipated by all. It was, therefore, a source of deep gratification to find that about 180 delegates were present. Such a number of representatives gathered in the

extreme West from every part of Canada, including Moncton in the extreme East, indicates the determination of the trade unionists in this country to exercise an alert interest in the affairs affecting them in spite of the heavy handicaps under which they labor at present. It proved that the spirit of trade unionism was capable of responding to the extremity of the situation in a degree that surprised even those who were best qualified to estimate probabilities.

Another surprising and agreeable feature was that this was the first time that the Congress has been able to hold its convention in a building owned and controlled exclusively by organized labor. Not only did the delegates feel proud that they were thus privileged, but the facilities afforded for conducting the business of the convention were perfectly satisfactory and the accommodation provided much more adequate than is usually the case. The handsome temple of labor erected by our comrades on the Pacific Coast creditably reflects their enthusiasm for and faith in the labor movement; while their pride of possession in the most comfortable and palatial edifice of its kind in the Dominion is too readily manifested to be overlooked. The fact that the convention was housed within the walls of a labor temple added materially to the comfort and general satisfaction of the delegates.

A sensation of relief was also felt when the report of Secretary-Treasurer Draper was submitted, showing that the leakage was less than had been anticipated. The Congress commenced the year with a per capita paying membership of 80,094. This number has been reduced during the year by 8,675, leaving the membership at 71,419. The secretary estimated that this reduction represented about the number of trade unionists who had enlisted. Assuming this to be correct, trade conditions in the East must be considerably better than in the West, where the falling off in membership, particularly in the building trades, has been enormous.

The finances of the Congress are unexpectedly satisfactory. In spite of the reduced membership the administration of the funds has been so economical that the receipts exceeded the expenditures by \$1,063.14. The year began with a balance in hand of \$10,951.05, and ended with a balance of \$12,014.18.

It is quite safe to say that never before in the history of the Congress have the delegates met under such impressive circumstances. The whole mental atmosphere was charged with serious consideration of what attitude would be taken with regard to the war. The problem overshadowed all others, and obsessed the mind of every delegate until disposed of. At the St. John convention the war was in its early stages. Its tremendous import had not been realized. There was hope that its duration might be

short. At Vancouver all this had changed. In spite of the economic drainage of the nations and the nameless horrors resulting from the war, peace seemed farther away than ever, and the seriousness of the situation was infinitely more impressive. For years, the Congress had declared that war was waged purely in the interest of capitalism, and that as the capitalists made the war they should do the fighting. Would this pious resolution stand the tremendous test that was now being applied to it.

The War Debate.

At the St. John convention, the question had been somewhat judiciously disposed of with a complete abdication, by language which evaded the challenge, and speculation was rife as to the effect which another year's experience had wrought in the minds of the delegates—or, at least, in the expression of their minds. In addition, the convention last year had been held in the far East where the workers were supposed to be conservative in their views. This year it was held in the far West, in the home of revolutionary socialism and ultra radicalism. This fact undoubtedly contributed greatly to the speculative aspect of the situation. The submission of the report of the Executive Council effectually dispelled any idea that might have been harbored that diplomatic methods would be adopted in dealing with the question. Without reserve, the report threw down the gauntlet to the school of thought that maintained the war was no business of the working class, and that it was a matter of indifference to the workers which side won. Not only did the executive regard it as a fact that the interests of the working class were bound up with the way in which the war terminated, but regarded those interests as inseparably bound up in the triumph of the Allies, and specifically declared that it was the duty of labor to lend every assistance to the cause of the Allies.

What has been described as the most intense and brainiest discussion that ever took place on the floor of the Congress, followed the submission of a motion to delete the following paragraph from the executive report:

"Under existing conditions it becomes the duty of the labor world to lend every assistance possible to the Allies of Great Britain, and, for us in Canada, more especially to the Empire of which we form a part, in a mighty endeavor to secure early and final victory for the cause of freedom and democracy."

For four hours a hot debate raged around the resolution to delete this section of the report after which it was defeated by a standing vote of 104 to 29.

Declaring that conscription is antagonistic to the labor interests and at variance with the fundamental principles of constitutional freedom, the report went on to state that

"the Trades and Labor Congress of Canada cannot too emphatically register its disapproval of even the remotest attempt at enforced enlistment." This section was adopted without comment. All other sections of the report were passed without contention and the whole report finally approved.

Next in importance to the war was the subject of the "Lemieux Act," sometimes called the "Lemon Act," but commonly known as the "Industrial Disputes Act," which arose out of the proposed amendments offered by the Minister of Labor, Crothers, to the above act and out of the following:

Resolution of Division 101, A. A. of S. and E. O. E. of A., Vancouver, B. C., asking the Congress to exert all its power for the repeal of the Lemieux Act, as we have found once more to our cost it is no just remedy for settling disputes between capital and labor. Lodge 484, Machinists, of Transcona, Man., also had the same resolution.

This matter occupied the attention of the convention for the greater part of three sessions.

It was arranged that we should hear the speech from Hon. T. W. Crothers, Minister of Labor, first before discussing the amendments. He believed that some were in favor of the repeal of the act. Imperfect as all legislation is, the Industrial Disputes Act does not pretend to be perfect, but he believed that it would be one of the best acts passed in many years. It was meant to avoid as far as possible industrial war. The working people and wage earners are the people that suffer most in war and also in industrial war. The act was passed to prevent industrial war. He had only known two awards that were against the contentions of the men, and had only made one mistake in four years by the appointment of a chairman. He did not know the men, but he generally appoints a judge.

Under the new bill a strike cannot take place until a secret vote has been taken. The object is to give the men a chance to think over the matter properly, and to allow the public to think it over after reading the award.

In any public utility the minister can grant a board even if company employes or city commissioners do not apply for one. During his speech the minister remarked that every working man should be a member of a trade union, and that a man had no right to enjoy the benefits which are gained by the work of a trade union if he does not help sustain such union. The minister left a better impression after his speech than he did last convention at St. John's, when he made himself scarce as soon as finished.

A feature of the discussion on this subject was the indication that the miners are far from forgiving the Minister of Labor for his actions in connection with the strike at Vancouver Island and the incidents preced-

ing it. Their delegates hotly attacked him on the ground that had he acted in accordance with the spirit of the act the strike would probably have been averted, and incompetent Orientals would not have been employed in the Vancouver Island mines, taking the jobs of men who were now thrown out of work.

A sinister looking feature of the proposed bill is that it seeks to enact that in case of strike any person who is not an employe in the employment in which the strike takes place, but who has ordered or encouraged such strike, shall be liable to a fine of not less than \$100, nor more than \$2,000, or to imprisonment for any period not exceeding six months. This section appears to be framed to hit trade union officials, whose duties bring them directly in touch with employments in which they are not engaged.

Your delegate pointed out how we and the machinists had fared under the existing act in our strike on the Grand Trunk Pacific, when in trying to comply with the conditions of the present act, it gave the officials of above road time (which was about nine months) to discharge many of the active members of the unions, to locate a bunch of scabs and do other things that would better prepare them, "the company," to fight a strike, also pointing out that we would be better without any legal interference on the part of the government, if we were in a position to strike and if we were not the law would be of no use to us anyway. A special committee that had been struck off to deal with this subject reported unfavorably on the resolutions in favor of the repeal of the act, and that the matter be referred to the incoming executive council, they to oppose any objectionable and support any favorable amendments.

Delegate Rees, of the United Mine Workers, Gladstone Local 2314, District 18, spoke for a considerable time against the report of the committee. He pointed out that Mackenzie King, who is in the employ of Rockefeller, is working hard to have a similar act passed in the states of Colorado and West Virginia. If it was beneficial to the workers would the Rockefeller corporation want to get legislation of a similar kind on the statute books. Certainly not.

The Minister of Labor being given the last words at the end of the discussion who stated that he would rather resign office than have the act repealed and as was to be expected, a lot of the delegates fell for the bluff and the report of the committee carried on a standing vote of 97 to 55.

Efforts That Failed.

That there are still trade unionists who are not satisfied to have the Congress retain its present function as only the legislative mouthpiece of Canadian organized labor was shown in the submission of one

resolution asking that the Congress be established as the parent body of a Labor Party, and another urging that the Congress exercise its power to secure direct labor representation on all administrative bodies by immediately commencing a propaganda with the object of accomplishing this end. Fortunately the overwhelming majority of the delegates realize the perils and difficulties that such a policy would beset the Congress with, and the resolutions were negatived.

Two resolutions were submitted by the Guelph Trades Council. First, asking that alien enemies working in Canada be dismissed and placed in detention camps. This was turned down. Second, that at the close of the present war all aliens interned be deported to their own countries to provide work for the returned soldiers and British subjects that will surely troop into Canada. This was referred to the committee on officers' reports, who brought in a recommendation of non-concurrence, as a great many of these men were members of trade unions interned through no fault of their own. The same view was taken by the convention, which adopted the report of the committee.

A resolution was passed urging that all local affiliated unions subscribe for its entire membership to the official labor paper published in its immediate vicinity, to the end that these papers may take their proper place as the means of communication and mouthpieces of the labor movement.

W. S. Burns, of the Vancouver branch of the Sailors' Union, submitted a resolution dealing with the laws governing seamen which deny them the equal freedom enjoyed by other workers. The United States have lately adopted laws that gives such freedom to all seamen that come under the jurisdiction of the United States, and he asked that these laws be submitted to the government and the people of the Dominion for their serious consideration, and also that copies of these resolutions be forwarded to the Dominion Government and to the government of Great Britain. Andrew Fursueth, Secretary of the Pacific Coast Sailors' Union, was given the platform to speak to the delegates in support of the above resolution. He made a profound impression upon the delegates. The theme of his discourse was that unless better laws were devised for the protection of the white seamen they would continue to leave the sea. He said that unless Britain awoke to that fact, sea power would pass from her, and with its passing would vanish her paramount place in the maritime nations of the world. It was by the blood of British men that the empire was built, and it can only be maintained by the same means. The shipowners are so organized that if you touch an owner on the Pacific Coast a shipowner on the Mediterranean feels it. The whole white race are leaving the sea, and leaving it to the yellow and

colored race. What is to become of Great Britain under these conditions? I come to you to say that we are blood of your blood and bone of your bone. I appeal to you as men and women of Canada and the British Empire to bring before your governments the claim that the seamen shall be free and that the slavery of the sea shall cease. The resolution was adopted by a standing vote which was unanimous.

After a lengthy discussion, in which some of the arguments were delivered red-hot, the Congress decided to sever its affiliation with the Social Service Council of Canada by a vote of 72 to 66. This action was taken while the report of the Ways and Means Committee was under discussion.

Resolution by J. W. Bruce of Toronto, asking that the fair wage clause be inserted in all contracts for the making of war supplies, and the rights of the workers be protected by that means, as a great many firms are exploiting their employes and paying miserable wages in a great many industries. Delegate Bruce and also Delegate O'Dell spoke in support of this resolution. Hon. T. W. Crothers said that the government had no authority to deal with the question of war supplies, it was the British government; but spoke of a few instances where he was able to get a raise in wages at some factories through his influence and through threats to do all in his power to stop said factories from getting more work. Left to the executive council to take it to the British government if the home government did not do anything. A special representative to be dispatched to Great Britain.

Following are some extracts from the Committee on Immigration and Unemployment report, all were adopted by the convention:

That the executive council and the provincial executive urge upon their respective governments the necessity for the adoption of a six-hour-day law covering the workers in all industries in their several jurisdictions.

And that the federal and provincial governments be requested to begin without delay any buildings or other public works contemplated or necessary in order to assist in relieving the congestion of the labor market.

Also that the present system of home-steading is useless as a solution of unemployment difficulties. To avail himself of it the applicant must have sufficient to maintain himself, purchase implements, etc., and is in most cases further and finally handicapped by a complete lack of agricultural knowledge or experience. Temporary sustenance, shelter and tuition must be provided, for the thousands of unemployed which will immediately follow the declaration of peace and the return to the open market of thousands of soldiers, munition workers and others.

While it must be fully recognized that those men who have enlisted from the Dominion of Canada have every right to return to the labor market untrammelled by any restrictions other than those created by changed conditions; it will be just as readily recognized that the conditions will be so changed as to render the outlook of those thrown on the labor market following the war as anything but desirable. So far, indeed, as the cities are concerned that outlook will be well nigh hopeless for the great mass of applicants.

It is therefore recommended that the government should select such land as may be necessary for the proper carrying out of a scheme which will meet the abnormal conditions which confront the Dominion, which land should not be privately owned; and that the federal government be requested to offer, as an option to discharge from the army, further enlistment for a period of five years of such men as would be willing to undertake agricultural work under the direction of qualified experts from experimental farms and agricultural colleges. That such men should receive the regular army pay, allowances and rations on same basis. Suitable accommodation to be provided, with married quarters for men with families. After such period of enlistment had expired, the men who have thus served should have the option of settlement upon suitably sized allowances of the land so improved, the same to be held on leasehold terms from the Dominion Government.

H. J. Conway, secretary of the International Association of Retail Clerks, who was present as the fraternal delegate from the American Federation of Labor, delivered a stimulating address, urging the Congress to give more attention to organizing and helping to raise the standard of the female workers.

Election of officers resulted as follows:

J. C. Watters, re-elected president.

J. Watchman, for vice-president.

P. M. Draper, re-elected secretary and treasurer.

Fred Bancroft, fraternal delegate to American Federation of Labor.

J. Simpson, fraternal delegate to British Trades Congress.

In conclusion I wish to mention that two local lodges were represented at the Congress, Brother Pettigrew from Lodge 191, and Brother A. Fraser of Lodge 194, also had the pleasure while in Vancouver of meeting International Organizer Hos. Reed, who was in attendance at the convention some of the time.

Hoping the above report meets with the approval of all, and any one desiring the complete minutes of the convention can secure a copy by dropping a card to Secretary P. M. Draper, P. O. Box 515, Ottawa, Canada.

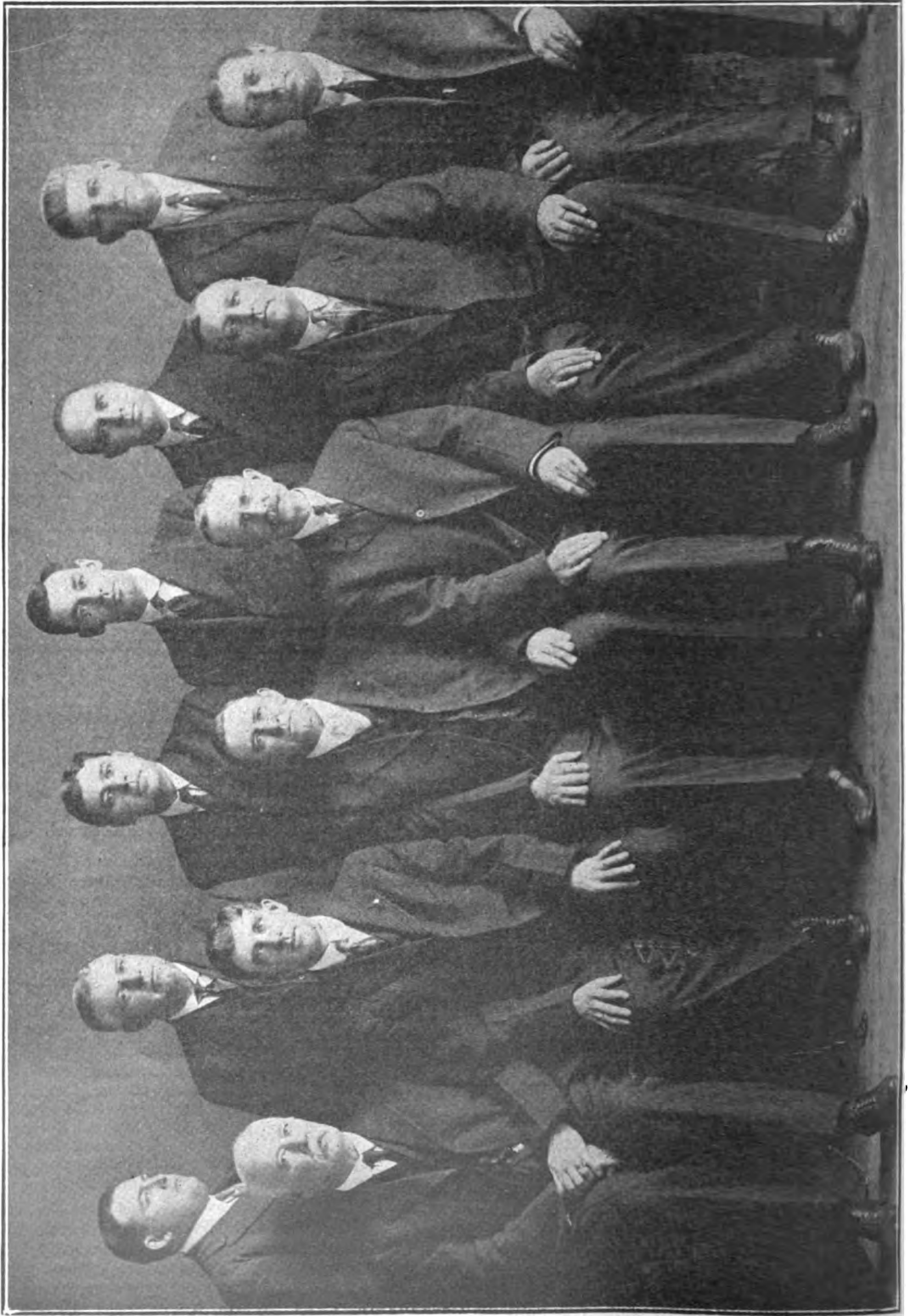

A GROUP OF THE INTERNATIONAL OFFICERS OF OUR BROTHERHOOD.

Agreements

Agreement entered into between the Chicago Junction Railway and the Brotherhood of Boiler Makers, Iron Ship Builders and Helpers of America:

ARTICLE I.

Nine hours shall constitute a day's work; eight men will work ten hours. All time worked after bulletin hours shall be paid for at the rate of time and one-half. All overtime to be divided equally as far as possible. No employe shall be laid off any regular working hours to equalize time on account of having worked overtime.

ARTICLE II.

To all boiler makers and helpers working night as well as day, time and one-half shall be paid for Sundays and legal holidays as follows: New Year's, Decoration Day, July Fourth, Labor Day, Thanksgiving Day and Christmas Day.

ARTICLE III.

If any of the holidays mentioned in this schedule fall on Sunday, then the day to be observed by the state or nation or by proclamation, shall be considered a holiday and paid for as such.

ARTICLE IV.

All work, such as cutting, repairing, fitting up, any work pertaining to air, oil or water-tight tanks, cutting off, or drilling stay bolts, drilling of mud rings or radials when renewed, steel tank frames, all iron and steel from 1-16 inch up in thickness, pertaining to boilers or tanks, laying out, flanging, patching, caulking, riveting, chipping, all round house work, testing and all flue work, is to be done by boiler makers.

ARTICLE V.

When boiler makers and helpers are sent on outside work, they shall receive not less than ten (10) hours' pay. When sent outside of city limits, they shall be paid from time of leaving home station until time of return to same.

ARTICLE VI.

All boiler makers sent on outside work shall be furnished with a helper. This also applies to roundhouse men and night men.

ARTICLE VII.

When a general reduction in expenses is necessary, working hours shall be reduced to eight (8) hours per day before laying off men. If further reduction is necessary, the last man hired shall be the first laid off, seniority to govern.

ARTICLE VIII.

When long-stroke hammer is being used, two boiler makers will operate same.

ARTICLE IX.

Boiler makers doing general running repairs in roundhouse will not be asked to remove or replace staybolts.

ARTICLE X.

The rate of wages shall be for boiler

makers 42 cents per hour and helpers 28 cents per hour.

ARTICLE XI.

All engines coming into shops for general overhauling shall have front end and fire-box washed out.

ARTICLE XII.

All boiler makers and helpers called to work overtime shall receive five hours' pay for three (3) hours and twenty minutes' work, or less; after three hours and twenty minutes' work, shall receive time and one-half.

ARTICLE XIII.

When an employe is transferred from day to night, or night to day shift, he shall be paid at the rate of time and one half for the first day or night's work.

ARTICLE XIV.

Boiler makers and helpers shall receive one hour off on Saturdays with pay, same as other roads.

ARTICLE XV.

Boiler makers and helpers wishing to be absent after two days from service must obtain leave of absence from foreman.

ARTICLE XVI.

Boiler makers and helpers to be allowed the same privileges with regard to transportation as any other employes.

ARTICLE XVII.

No boiler maker or helper shall be discharged without a just and sufficient cause. If after proper investigation it shall be found that any such person was unjustly discharged, he shall be reinstated with full pay for the time lost by such discharge, provided he submits his grievance to the company and to the committee within five days.

ARTICLE XVIII.

In case of any grievance, same shall be presented by committee, to the proper officials of the company. The course of procedure will be: First, to present the matter to the master mechanic, and in case a satisfactory adjustment cannot be made, to present same to the superintendent. Grievances presented as above will be promptly acted upon and remedied, and no discrimination will be permitted against anyone on account of service on any committee.

ARTICLE XIX.

This schedule and rules will be in force from November 1, 1915, and will supersede all other schedules and rules contrary thereto, and will remain in effect until changed, subject to 30 days' notice from either party of their desire to change it.

(Signed)

JAMES FITZMORRIS,
Master Mechanic.

H. McMAHON,
THOS. P. SMITH,

Com. for Bro. B. M., I. S. B. & H. of A.

Correspondence.

A CRITICISM OF NAVAL CONSTRUCTION.

(Printed by Request.)

Our Navy Department has always been an object of criticism by some of the magazines and newspapers of this country as regards the design and construction of our warships, and also the system employed in the management of this department.

I have held the position of overseer and inspector of warships that were under construction in several of our Navy yards both on the Atlantic and the Pacific coast, and also positions in private shipyards where such work was also being done, and can state with authority that there is good and sufficient cause for the criticism that our Navy Department has had heaped upon it, for it is nothing short of criminal on the part of our naval officers to allow such work to go on, and just as much so for anyone who is familiar with these facts not to inform the public of the criminal negligence that our Navy Department is guilty of, for, as the laws says, "It is a fraud to conceal a fraud."

There was some excuse fifteen or twenty years ago for making mistakes in the building of warships, but at the present time there is absolutely no excuse for the mistakes of twenty years ago, for thirty years of practical experience in that line of work should give any man of ordinary intelligence a thorough knowledge of the design and construction of any kind of ship.

The people of this country have been put to the expense of many millions of dollars for the building of warships, and it is high time that they should receive something for this enormous expenditure.

Not only has an immense amount of money been expended, but a great sacrifice of human life has been the result of this faulty construction of our warships, and I can safely say that 75 per cent of the so-called accidents would be a conservative estimate of the number that could have been avoided had the proper care been taken in the construction of our warships.

These are broad statements to make, but nevertheless they are cold facts, and I will state that 40 per cent of our warships in commission at the present time are unsafe and unseaworthy, and it is almost impossible to believe that a country like ours would allow such a state of affairs to exist, when one considers the number of men on board one of them when equipped for sea duty. The Dreadnoughts carry nearly one thousand officers and men when the enlistment is up to the standard, all picked men having no physical defects and there is no finer looking or more efficient body of men in any navy than that of the United States.

I have never been able to understand why those in charge of work of construction of

our warships were so careless and negligent in the work, the homes of our enlisted men of the navy, and as I stated before there is no excuse for this faulty construction at all. The people of this nation are paying 25 per cent more for these ships than they are worth, thereby not only paying an excessive charge for these ships, but getting defective ships in the bargain.

One might ask the reason why this state of affairs is allowed to exist, and for answer I will say that there is too much incompetency on the part of those in charge of the work, and those actually doing the work, the result of dirty politics, as all have secured their positions through political influence or some other influence equally as bad, and the method of doing the work by these incompetents is so crude and out of date that it costs 25 per cent more than it would with efficient men and methods up to date.

The cost of construction in the New York Navy Yard has increased since the Connecticut was built very materially, the time required to do the same amount of work has also increased, but the fact that wages have increased some should be more than offset by the improvement in machinery and tools.

We are told that the navy yards are operated under civil service rule, but I will try to explain navy yard civil service. A Board of Labor, composed of one or more naval officers, convenes once a month at the present time and decides upon the men needed of those who have applied for positions, their names being on file in the office. These names are supposed to be chosen from the top of the list, a notice being sent to each one, notifying them when to report for work.

Application is made by writing to the Board of Labor of the Navy Yard, where the applicant desires to be employed, stating that he wishes to apply for a position, and he will receive, from the board, application blanks which he must fill out according to instructions given with the blanks, comprising a history of his life if true, but untrue if it best suits his purpose; three or four references, and a doctor's certificate as to the applicant's physical ability makes everything complete, after which the application must be delivered in person to the navy yard where the applicant desires a position, but should a word be misspelled in the application or the applicant forget to remove his hat when entering the office, the application may be rejected, and another one have to be filled out.

This method of selecting the applicants for the positions seems to be fair enough, though there is a great deal of red tape about it, but this is not all. When an applicant files his application he may stand close to the top of the list, say No. 4, and

four men are called for the position No. 4 applied for, but No. 4 is not called, but upon going to the Labor Board to find the reason is informed that he is 14 on the list, it being a small matter to put a 1 in front of a 4, making 14, and should No. 4 argue the matter, he is told by these honorable gentlemen that they will not discuss the matter further, and if he is not satisfied with this decision a marine is called and No. 4 is escorted from the navy yard.

The above method is used by a favored politician or Representative for the benefit of a friend. Any man who stands in with the naval officers is able to put a friend to work at any time that he wishes to do so, as these naval officers are looking for favors themselves, and if they have no political influence are liable to find themselves in Cuba or the Philippines. This is how Admiral Dewey became a hero, for had there been any prospect of war when he took command of the Pacific fleet, I doubt very much if he would have had the chance to become a hero.

The selection of foremen, or masters as they are called in our navy yards, is by special examination, which is supposed to be advertised in the postoffices, though this is not always done, and should not be allowed as it is another case of deceiving the public. The men are picked for the position before the examination takes place. I have known men to go to a great deal of trouble, studying for weeks and looking up references, etc., when it was all prearranged for someone else to have the position. Some of the applicants travel for hundreds of miles to try for these positions, but those living near the navy yards seldom try for these positions, being aware of the deception practiced, and I know positively that 75 per cent of these positions were given out in this manner.

One might ask the object in selecting certain men for these positions, and if it would not be better to let the best men win in the examinations. It surely would produce greater efficiency in the work of construction, but a naval officer in charge of construction work being incompetent, and not being able to make good without practical men for these positions, who will do as the officer commands, whether it is right or wrong, and is willing to shoulder the blame should things go amiss, picks such men for these good qualities. Such a master mechanic is little more than a messenger boy, and has very little to say in the work of construction. A really efficient mechanic would not accept such a position if it were offered him under such conditions.

This civil service, as it is called, does not come under the jurisdiction of the Civil Service Commission and will not hold good in a court of law; it is only a navy yard order and is a clear case of fraud, and this method of choosing employes of the navy

yard keeps the best mechanics out of our navy yards.

When the Connecticut was about to be built some ten or twelve years ago at the New York yard, there were no mechanics who understood the laying out of the work by modern methods, so the naval constructor in charge of the work, knowing that he would be ridiculed if the old method were used, had the chief draftsman look up a number of men who understood the modern method in use at that time, promising them special pay if they would go to the New York yard and help in the work at hand. Some of these men accepted the proffered offer and the work progressed under their supervision for about nine months, but the old crowd of mechanics being strongly entrenched through political influence put every obstacle in the way of these new men and otherwise making life under such conditions almost unbearable, even going so far as to spoil some of the work, quite a number of steel plates weighing over a ton and worth about \$50 each being consigned to the scrap heap, followed by the resignation of these efficient mechanics, causing the work to fall off 50 per cent. Up to that time the navy yard was ahead of the private that was building a sister ship to the Connecticut, and anyone who is interested in shipbuilding will remember the race that took place between the navy yard and the private yard.

The time consumed in building these two ships was reduced from 36 months to 25 months, or nearly one-third, but even that is a poor record, for some of the Dreadnoughts can be built in 18 months without the expenditure of any extra amount of energy, but with competent mechanics under the supervision of efficient constructors.

The difference in the cost of these two ships, according to the figures given out by the Navy Department, was that the ship built at the navy yard cost \$330,000 more than the one built by the private concern. This difference in cost is easily accounted for by the "dead wood" as it is called in shipyards, and would more than make up for the difference. Men were doing helpers' work and receiving for their services mechanics' wages; helpers doing boys' work and receiving helpers' pay; mechanics working day work receiving piece work prices; in fact, there was a waste of money everywhere.

Three ships have been built at the New York Navy Yard since the battleship Connecticut was built, and they cost nearly \$800,000 more than the same class of ships cost in the private yards, the time consumed in their building being longer, as well, while the workmanship was of the poorest possible kind, and I know positively from personal inspections of the last product of the New York yard, the battleship New York, that the same work done on this ship would not pass inspection as a repair job on a

tramp steamer under the supervision of the Lloyds.

Figures do not lie, but liars will figure, as is shown by the figures given out at different times by some of our bureau chiefs, as to the cost of construction of battleships in our own navy yards, and why the cost is greater than that of the individual builders.

Prior to the enforcement of the eight-hour law, calling for an eight-hour work day on all government work, these gentlemen, for the reason that the work day was two hours shorter in the navy yards than the work day in the private yards, and the wages were 50 per cent higher, figured that the cost of constructing a ship in the navy yard of New York would cost 50 per cent more than the cost of construction by a private yard. This seemed to be very plausible, but there are other facts to be taken into consideration. Let me explain. There never was a ship yard in the country that the workmen worked ten hours a day; true, they stayed in the yard ten hours, but as for working, during my experience in handling men I was well satisfied if I could get the men to work eight hours per day. Also in private yards there are 50 per cent of the men working piece work and they do not average more than seven hours a day. Another item not taken into consideration by our navy experts, and that is the class of workmen. It makes a great difference in doing any kind of work if one has skilled workmen to deal with, and it is "working safe" to say that one man in four, only, is skilled. This will apply to any line of work from common laborer to draftsman. This is why the ship yards that pay the highest wages and have the shorter working day are able to secure the cream of the workmen.

Here are some facts to substantiate the foregoing statements: The Quincy yard in Massachusetts worked nine hours for years, and figured against yards working ten hours per day. The wages in the Quincy yard were 15 per cent higher than the wages in other yards; they also have to pay more for material, as they are farther from the rolling mills. Still the fact remains that the Quincy yard figured as low as the other yards and managed to get their share of the work.

Our bureau chiefs figured that in building ships under the eight-hour day it would cost \$224 per ton as against \$176 per ton for a ten-hour day, making a difference of \$48 per ton. Apparently the ship builders have taken advantage of these figures, as they have figured accordingly. Now if these figures are correct, the yards working nine hours a day figuring against the yards working ten hours a day would be at a disadvantage, as the difference of two hours a day, according to the bureau chiefs' figures, being equal to \$48, one hour a day would make a difference of one-half of \$48, or \$24, and figuring this in a contract of \$7,000,000 would be quite an item. Let us see. A ship

of 32,000 tons at a saving of \$24 per ton is \$768,000. If these bureau chiefs' figures are correct, the navy yard should save the people more than \$1,000,000 in building a Dreadnought. Before the eight-hour day in private yards, the cost of construction of a Dreadnought was \$500,000 more in the navy yard than in the private yards; now by adding the \$48 per ton more would give the navy yards an advantage of \$1,536,000.

The contracts for three dreadnoughts have been recently awarded, one to Newport News, one to the New York ship yard, Camden, N. J., and one to the New York navy yard. Four private firms figured on these ships, the fact of the matter is there are only four yards with the proper facilities for doing this class of work, exclusive of the navy yards.

The following are the estimates of the different yards as they were published in the marine newspapers. These figures are not always to be had as there are only one or two marine papers that publish these figures. Newport News Shipbuilding and Dry Dock Co., \$7,116,000; New York Shipbuilding Co., Camden, N. J., \$7,175,000; Fall River Ship and Engine Building Co., Massachusetts, \$7,440,000, and the Cramp Shipbuilding Co., Philadelphia, Pa., \$7,625,000. The difference between the highest and the lowest bid is \$509,000, and this difference is sufficient to build a submarine, complete.

Bids for destroyer were as follows: Newport News Shipbuilding and Dry Dock Co., 2 vessels, class 2, \$885,000 each; two vessels same class, Curtiss Turbines, \$875,000 each. Union Iron Works, San Francisco, Cal., 2 vessels class 1, \$880,000 each. Bath Iron Works, Bath, Maine, one vessel, class 2, \$884,000; two vessels, same class, \$850,000; three vessels, same class, \$850,000. Seattle Construction and Dry Dock Co., Seattle, Wash., 1 vessel, class 2, \$873,000; 2 vessels, same class, \$860,000. Fall River Shipbuilding Corporation, Quincy, Mass., 1 vessel, class 1, \$872,000; two vessels, same class, \$852,000; one vessel, class 2, \$889,000; 2 vessels, same class, \$852,000; 1 vessel, modification, \$815,000; 2 vessels, same class, \$795,000. William Cramp & Sons Ship and Engine Building Co., Philadelphia, Pa., 1 vessel, class 1, \$859,000; 2 vessels, same class, \$847,000; 3 vessels, same class, \$834,000; 1 vessel, class 2, \$853,000; 2 vessels, same class, \$841,000; 3 vessels, same class, \$834,000; 1 vessel, same class, \$845,000; 2 vessels, same class, \$834,000; 3 vessels, same class, \$825,000.

These figures have all been copied from one of the leading Marine Journals which stated that Mare Island also had a bid in for two of these dreadnoughts, and their bid was \$200,000 lower than the private yards. Mare Island yard is the highest-paid navy yard in this country, the rate of wages being 75 per cent higher than some of the private shipyards that figured against them. Mare Island is also at a disadvantage in getting material, as it is shipped from Pittsburgh. The boilers are built in

East New Jersey, transportation by way of the Panama Canal is about \$12.00 per ton, \$16.00 by rail.

Some more figures from these experts undoubtedly shows that they are wrong somewhere. Our bureau chiefs claim that it costs 50 per cent more to build ships in the navy yards than in private yards, and the construction in the navy yard figures 25 per cent less.

Here are some more figures, the main features of these destroyers:

Displacement, 1,100 tons.
 Turbine arrangement, twin screws.
 Shaft horsepower, 1,700.
 Revolutions per minute, 450.
 Steam pressure at turbine gauge pressure, 250 pounds.
 Cooling surface, condenser 11,000 square feet.
 Number of boilers, 4.
 Steam pressure at boiler, 265 pounds.
 Total heating surface of boilers, 21,500 square feet.

It will be seen that 4 boilers with 21,500 square feet of heating surface, shaft horsepower 17,000, as compared with some of the boilers, according to an article published in this same paper, on the Japanese battleship cruisers, 27,000 tons' displacement, have a horsepower of 70,000, and a speed of 28 knots, or about 2.5 horsepower for every 1,000 tons of displacement. These destroyers will have 17,000 horsepower for every 1,100 tons' displacement; the speed calls for 29½ knots per hour, and it seems just possible to attain a speed of 30 knots per hour with 17,000 horsepower.

The fact of the matter is that these figures are juggled to fool the people, as you will note was done in the bids, as the bid with modifications is much lower than the others, and then what is meant by "modifications"?

The work of building ships has always been distributed among the different ship yards; the ships are, as a rule, constructed on the same lines, and it would necessitate quite a saving to the people if the ships were built in one yard, for if the yard makes a specialty of a certain class of work they cannot only do it cheaper, but with better results as to workmanship, as a mechanic working on the same class of work all the time becomes more and more expert in that line.

These vessels can be built at a fair profit for \$600,000. The ship builders in this country have always had the sympathy of the American people, for they called that they could not build ships in competition with the ship builders of foreign countries on account of the high cost of labor.

(To be continued next month.)

Jacksonville, Fla.

Dear Sir and Brother:

The second annual convention of District No. 38 was held in Savannah, Ga., October 18 and 19, 1915. Delegates were present

from all points on the Atlantic Coast Line System. It was a harmonious meeting; in fact, it was the best meeting I have attended in years. Business was carried on with promptness and dispatch. Delegates from various points on the system were there, with one object in view, the betterment of the brothers on the system. I wish to congratulate Brother Bolton, our presiding officer, and the delegates for the able manner in which this meeting was conducted, and I sincerely hope that this will be a prosperous year for the brothers on the system.

The following officers were elected for the ensuing term: President, H. J. Bolton, Rocky Mount, N. C.; vice-president, C. M. Schultz, Waycross, Ga.; secretary-treasurer, E. S. Ryan, Jacksonville, Fla.; trustees—George Randall, Sanford, Fla.; C. M. Schultz, Waycross, Ga.; C. D. Miller, High Springs, Fla.

Yours fraternally,

E. S. RYAN,
 Secretary-Treasurer.

Salida, Colo.

At a regular meeting of Narrow Gauge Lodge No. 427 of Salida, Colo., the following resolutions were adopted:

Whereas, It has pleased our Heavenly Father, in His infinite wisdom, to call from this earth to her home above, the beloved wife of our brother, Vice-President J. M. Campbell; therefore, be it

Resolved, That we, his brother workers, extend to him our most heartfelt sympathy in this his sad hour of bereavement; be it further

Resolved, That to the invalid daughter we pray that our Heavenly Father may so console and comfort her in her bereavement that she may be able to bear her double burden with fortitude; be it further

Resolved, That a copy of these resolutions be spread upon the minutes of our lodge and a copy presented to our brother, J. M. Campbell.

EDWARD SCHILTHUIS,
 H. F. JONES,
 WM. DARGAVEL,
 Committee.

North Bay, Ont., Can.

Dear Sir and Brother:

At the last regular meeting of Nipissing Lodge No. 417, the following resolutions were adopted:

Whereas, Our Heavenly Father, whom we believe and know doeth all things well, has in His infinite wisdom, called to His heavenly home, the beloved father of our worthy and esteemed brother, T. J. Wilson.

Resolved, That we extend to our brother and his family our sincere and heartfelt sympathy in their hour of sorrow, as the tie is broken here there will be one to welcome

them when they reach that land where there is no parting or sorrow.

Resolved, That a copy of these resolutions be sent to our esteemed brother, a copy sent to his family, a copy spread over the minutes and a copy sent to our Journal for publication.

A. L. LYE,
E. COOK,
F. GARDNER,
Committee.

Esquimalt, B. C., Oct. 27, 1915.

The boiler makers, iron ship builders and helpers of Local No. 191, Victoria, B. C., had a very enjoyable picnic at Deep Cove, 23 miles distant, on Labor Day. It is to be an annual event. A splendid program of

Atkinson, Fifth I. V. P., with us, but better luck next time.

Enclosed please find photo of the picnic party at the Deep Cove grounds, which we hope you will publish full size in the next issue of our Journal, also this letter.

Yours fraternally,

A. STEWART,
Secretary Lodge 191.

Rocky Mount, N. C.

Dear Sir and Brother:

In September issue of the Journal I read with much interest that article from the pen of Brother A. J. Dixon of Lodge No. 239 on conditions in many railroad shops, as well as discrimination practiced by many railroad officials, against fair-minded as



A GROUP OF MEMBERS OF LODGE No. 191, ESQUIMALT, B. C., CAN., AND THEIR FAMILIES ON A PICNIC, LABOR DAY, SEPTEMBER 6, 1915.

sports was carried out, the principal events being baseball, football, tug of war and 100 yard foot race for the championship of the local. The baseball and tug of war went to the Helpers, the 100 yard race to Brother Percy Peters, riveter, and the football game was declared a tie after 10 minutes of extra play.

Everybody enjoyed themselves to the utmost and special credit is due the committee who had the arrangements in hand from the start, not only for the efficient manner in which the transportation, program of sports, prizes, etc., were arranged, but also for the pleasant way in which they looked after the welfare of the wives and children of the members and their friends.

The thanks of the local are also due the many merchants of the district who so generously contributed to the prize list. We were very much disappointed in not having Brother J. Reed, I. D. O., and Brother. W.

well as active members of the various organizations employed in railroad shops. A copy of that article should be framed and hung up in the home of every mechanic employed in the railroad shops of America, for its good things, to ponder over by men who expect to get a square deal in the future.

Many railroad officials try to be fair, and are fair, while others are a standing disgrace to American manhood, as well as a menace to the peace and welfare of the industrial future, but they don't realize it, as their desire and ambition is to grind out dividends at the expense of the shop men, and are doing it right along.

Their weapon is discrimination against any employe who has enough of red blood in his veins to stand like a man, and declare himself. Such tactics should be stopped, as it doesn't seem possible that men who claim to be free men will continue to

submit to conditions almost akin to slavery. Men will fight to uphold the honor and dignity of their country; will leave father, mother, wife of children to shed their blood in defense of it, which is their duty to do; otherwise we would be a nation of slaves. If such is the case and cannot be contradicted, then why is it possible that we tolerate our industrial rights to be trampled on and in many cases without even a protest. For industrial discrimination is nothing but slavery under another name, a system which drives thousands of children out of the schools into the factory in their tender years. At a time when they require at least some education as well as moral training to fit them for the duties of American citizenship, both men and women. We hope the day is not far distant when votes for women will be forgotten, only when they are depositing their ballot for honest government.

Every man and woman who toils for a living should carefully read the report of the Industrial Commission on conditions existing among the wage workers of our country, both in some railroad shops and many industrial plants. It is impossible that such a state of affairs would be tolerated in the land of the brave and the supposed home of justice to all the American people, not any particular class of people.

If we would only read matters of real interest or economic subjects, something that would show us the road to at least economic justice through the co-operation and intelligent action of organized labor forces, instead of filthy publications used and financed by organized capital, with only one purpose in view, to destroy and prevent any possible opportunity of the emancipation of the wage workers of America, which is patent to all who have eyes to see or ears to hear, such a blind policy of description would be impossible. If we would only study the Sermon on the Mount, but what awful mistakes we make, and sometimes in the name of justice, for personal advancement, and Brother Dixon, late of Lodge No. 238, was one of the real victims.

A ROCKY MOUNT, N. C., BOILER MAKER.

Denver, Colo.

Dear Sir and Brother:

In memorial of Mrs. Frank Brinkley, who died October 10, 1915:

Whereas, The finis to all life is death; relentless death going hither and there, non-respector of persons, laying his cold, irony hand upon the aged today, then snatching the suckling babe from its mother's arms or stilling the heart in the blithesome youth on the morrow. So death entered into the home of our brother, Frank Brinkley, and took from our midst his loving wife, more sad it seems because of youth, her years being thirty. She had graced our brother's home less than a year, and as the months passed on, the hands of the expectant mother

deftly turned and stitched the little garments that would never be used; so we grieve with our brother in his dark hour of sorrow; therefore, be it

Resolved, That Local No. 179, I. B. of B. M., I. S. B. & H. of America extend our hearts in sympathy to him.

We greet the heartless death,
As with uncovered head,
We saw thy cruel triumph
In the calm silence of our brother's dead.

How silently she lies in death's embrace,
And yet the while, "to us it seems"
'Tis not death we look upon,
But some unnatural midnight dream.

But the pallid face and weeping friends
And the flowers upon your bier
Dispel the thought of flitting dreams,
Proclaim to us cold death is here.

We leave thee, sister, to thy last long sleep.
We cannot bring you back to life;
We bid you now a last farewell.
Farewell, to thee, our brother's wife.

F. S. KIDNIEGH,
Committee.

Dalhart, Texas.

At a regular meeting of Dalhart Lodge No. 476, the following resolutions were adopted:

Whereas, It has pleased Almighty God to take from our midst the beloved father of Brother Michel Burke; therefore, be it

Resolved, That the bereaved family have lost a loving father; and be it further

Resolved, That our heartfelt sympathy be extended to the family and relatives of our departed brother's father and that a copy of this be sent to the sorrowful family, a copy be spread on the minutes of our lodge and a copy sent to our official Journal for publication.

WALTER KEYS,
E. BETTS,
T. P. NELSON.

East St. Louis, Ill.

A few words to the brothers at large in regard to our Labor Day celebration, as the majority of our members work seven days a week (as we are in a round house district). It is hard for us to make the showing we should in a line of march.

With the able assistance of the terminal brothers (Lodge No. 276), our parade was a grand success. As we differ with the actions of our city officials in regard to what craft should hold the position of city boiler inspector, we endeavored to make quite a showing. We were successful by out-numbering our union engineers by 5 to 1.

Their motto seems to be "Grab all," regardless of whom it belongs to. They claim they are combination of all trades, which must mean master of none.

At present they have control of the position of city boiler inspector. We distributed the above "Safety First" cards along the line of march, and they answered the purpose.

As it was something new, the public endeavored to find out what it meant. As we have the best of the argument, we have all the confidence in the world that a boiler maker will be on the job at an early date.

Your humble servant had the honor to hand our honorable mayor our card before we started on our line of march. So it would remind him to take particular attention to see which craft was the best represented.

After we made our little three-mile walk to our place of amusement, we found one of our members had taken up the art of photography; although new at the business, you will agree with me he made a very nice picture. Our banner was placed a little

the dearly beloved mother of our worthy and esteemed brother, Henry B. Berge; therefore, be it

Resolved, That we, his fellow brothers, extend to our brother our heartfelt sympathy in this his hour of bereavement, and pray that the Almighty God may comfort and console him, and that he will bear his trial with fortitude; be it further

Resolved, That a copy of these resolutions be spread on the minutes of our meeting, a copy to be forwarded to our official Journal for publication.

FRED OLSON,
JOHN AMUNDSON,
E. A. CONLIN,
Committee.

Chicago, Ill.

Dear Sir and Brother:

At the last regular meeting of Central Lodge No. 220, I. B. of B. M. & H. of Amer-



A GROUP OF MEMBERS OF LODGE No. 363, EAST ST. LOUIS, ILL., LABOR DAY, 1915.

high and the name of the Boiler Maker does not show. Our marshal, Brother James Whitmore, at the right a little back of the banners, overlooked that part. As he was successful in landing us at the park safe and sound, we will forgive him. Your humble servant had to excuse himself a short distance from the park to take care of our visiting brothers on the return to the hall.

"Safety First. Have a Boiler Maker for City Boiler Inspector."

Fraternally yours,
JOHN ROCHE, C. S. No. 366.

Minneapolis, Minn.

Dear Sir and Brother:

At a regular meeting of Flour City Lodge No. 11, the following resolutions were adopted:

Whereas, It has pleased Almighty God in His divine wisdom to remove from our midst

ica, the following resolutions were adopted:

Whereas, It has pleased the Almighty God in His divine wisdom to remove from our midst, the dearly beloved Father of our worthy and esteemed brother, Patrick Lowe; therefore, be it

Resolved, That a copy of these resolutions be spread on the minutes of our meeting, a copy be forwarded to our esteemed brother, and a copy be forwarded to our Journal for publication.

P. CASSIDY,
G. MAIERHOFER,
A. G. SMITH,
Committee.

St. Paul, Minn.

Dear Sir and Brother:

At a regular meeting of Capitol City Lodge No. 3, I. B. B. M. & I. S. B. of A., the following resolutions were unanimously adopted and an order was made that a copy of

the same be sent to the editor of the Journal so that the same can be published in our official Journal:

Whereas, Our Executive Council has withdrawn the support of the business agents of the 19 cities and districts that had these business agents; and

Whereas, In summarizing the expense accounts of the second quarter, we find that the report as shown by Lodge No. 25 of San Francisco in the October Journal is correct; and

Whereas, Our Executive Council has gone on record at their annual meeting held October 22, as being in favor of non-concurring in the request of Capitol City Lodge No. 3 to restore financial assistance to business agents; and

Whereas, Our Executive Council took no further action to curtail expenses than to dispense with the services of the said 19 business agents indefinitely; therefore, be it

Resolved by Capitol City Lodge No. 3, I. B. B. M. & I. S. B. of A., That if our Executive Council does not restore financial aid to our business agents and pay the money that is due to the support of our business agents, that we go on record as being in favor of taking some action that will force our Executive Council to give us a more business-like administration; and be it further

Resolved, That we heartily approve of the resolutions of San Francisco Lodge No. 25, which were printed in our official Journal, October, 1915, issue.

WM. JOHNSON,
G. L. COX,
J. J. GALLINO,
P. WELSH,
Committee.

Lafayette, Ind.

Dear Friend and Brother:

It has been a long time since I hit the trail; those days riding on the cushions made my feet sore. It is different now, Jim; I don't think I would know how to ride a brownie now, but joke with me if I had to.

I am taking a vacation for a couple of months. When I left Deer Lodge everything was working fine, but the hours, 40 per week, and living so high. I have compared the cost there and the East—over 25 per cent difference in favor of the home team, Montana, by heck! It has been several years since I was in this territory. Will say Brother Maher, Seventh International Vice-President, has accomplished a lot of good in this section of the country.

I stopped off at St. Paul, Minneapolis, Milwaukee and Chicago, taking a rest here with my friend, Dick Aldrich, and wife, going to Chicago next Saturday; will spend Thanksgiving with my friends in Elkhart, Ind.; from there will go to Cleveland and Detroit for a while, then back to the mountains.

I had a nice time in Milwaukee, met some friends I worked with 30 years ago, and

Mrs. Callahan, the mother of our representative of District No. 26, gave me a royal reception, and Brother Jack is some worker and a good fellow with it, the right man in the right place.

I think the movement to build a monument in memory of Brother Gilthorpe is all right, for he was a grand old veteran and one we ought to be proud of.

Give my regards to Brother Joe Franklin and Hinzman, also Brother Reinemeyer.

Wishing you good luck, I remain

Yours fraternally,

JACK CUMMINGS.

Philadelphia, Pa.

Dear Sir and Brother:

I am inclosing you a photograph of Brother Robert J. Hanna, who has been honored



Photo of Brother Robt. J. Hanna, of Lodge No. 19, Philadelphia, Pa., and an Aide-de-Camp, on the Staff of the Commander-in-Chief of the United Spanish War Veterans.

with the appointment as an aide de camp on the staff of the commander-in-chief of the United Spanish War Veterans. Brother Hanna is well deserving of this recognition, having faithfully served during the Spanish-American War, and after being honorably discharged worked hard to bring about the inception of the United Spanish Veterans. To Lodge No. 19 Brother Hanna has been a valuable member, always willing to render assistance whenever possible, and we always

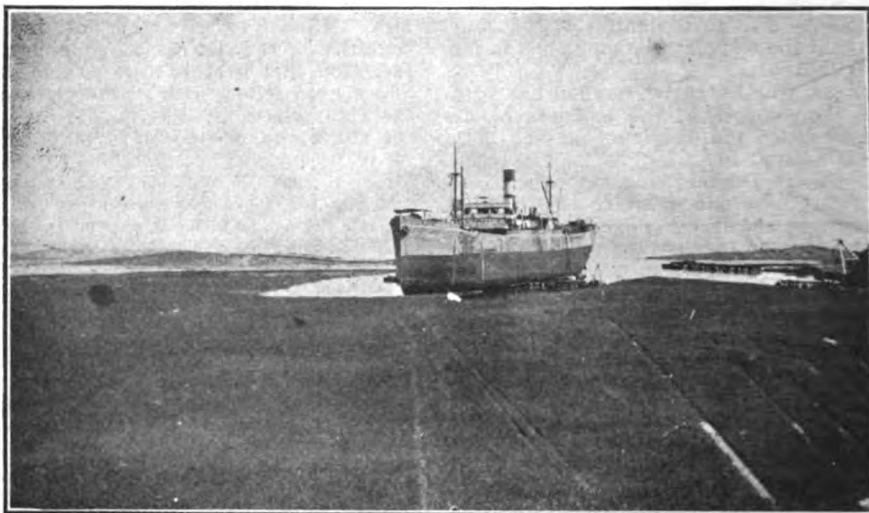

A LARGE OCEAN-GOING STEAMER, BLOWN FOUR AND ONE-HALF MILES FROM THE CHANNEL DURING THE STORM SOME TIME AGO AT GALVESTON, TEXAS.

felt assured the committee that he was a member of would be successful.

Believing that the type of Brother Hanna is a credit to both the Spanish War Veterans and our own Brotherhood, I am

Fraternally yours,
ROBT. S. HOPKINS, C. S. L. 19.

Galveston, Tex.

Dear Sir and Brother:

I am sending you two views; one is a large steamer that was blown ashore in our last storm, and the other one is a gang of

boiler makers and helpers that did quite a lot of work on her after she was dredged afloat. The steamer was blown about four and a half miles over a shoal mud bank, and a channel had to be dug up to her and a large hole around her so that the bank underneath would give way before she would float.

We would like to have you put the views in our Journal, if you would not mind doing so for us.

Hoping this will be satisfactory, I remain

Yours fraternally,

E. T. CHESTER.

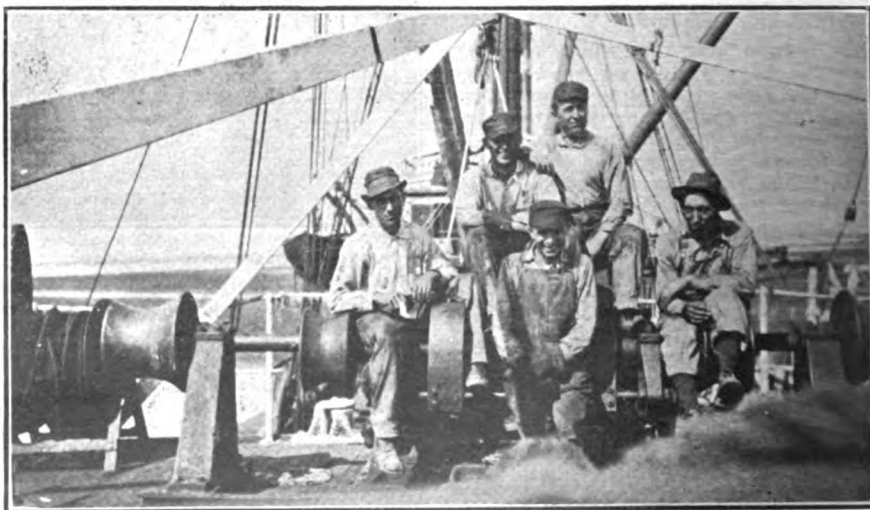

A GROUP OF MEMBERS OF LODGE No. 132, GALVESTON, TEXAS, WHO MADE EXTENSIVE REPAIRS TO THE STEAMER BLOWN ASHORE IN THAT HARBOR SOME TIME AGO.

Denison, Tex.
 Mr. E. P. Butler, Secretary Lodge No. 292,
 Parsons, Kan.
 Mr. Wm. Dickerson, Secretary Lodge No.
 501, Waco, Tex.
 Mr. E. H. Monohan, Secretary Lodge No.
 576, Wichita Falls, Tex.
 Mr. C. W. Leigen, Secretary Lodge No. 207,
 Walnut Springs, Tex.
 Mr. Guy Hooper, Secretary Lodge No. 265,
 Smithville, Tex.

Gentleman and Brothers:

This is to inform you that you and the entire membership of your respective lodges, and their families, are urgently requested to be present with us at our next regular meeting, November 25, 1915.

We are going to have a little music, a little singing, a little dancing, a little something to eat and a BIG, jolly good time. Come, one; come, all. At least see that your local is represented.

Yours fraternally,

S. E. HARRIS,

Corresponding and Financial Secretary.

P. S.—Try and let me know by the 22nd, inst., the number we may expect from your local, and oblige.

S. E. HARRIS.

P. S. No. 2:

Mr. F. P. Reinemeyer, International Secretary-Treasurer, Kansas City, Kas.

Dear Sir and Brother:

The above invitation also includes all of our International officers.

See to it that you are represented.

S. E. HARRIS.

Minneapolis, Minn.

At a regular meeting of Flour City Lodge No. 11, the following resolutions were adopted:

Whereas, It has pleased the Almighty God in His divine wisdom to remove from our midst the dearly beloved son of our worthy and esteemed brother, Nels Ostram; therefore, be it

Resolved, That we, his fellow brothers, extend to our brother our heartfelt sympathy in this hour of bereavement, and pray that the Almighty God may comfort and console him and that he will bear his trial with fortitude; be it further

Resolved, That a copy of these resolutions be spread on the minutes of our meeting, a copy be forwarded to our official Journal for publication.

FRED OLSON,
 JNO. AMUNDSON,
 E. A. CONLIN,
 Committee.

Alton, Ill.

Dear Sir and Brother:

Whereas, It has pleased the Almighty God in His wisdom to remove from our midst our late brother and fellow worker, Phillip Doyle,

Resolved, That Lodge No. 483 of the International Brotherhood of B. M., I. S. B. &

H. of America, having learned of the sad event in session on this date, is filled with sorrow at the announcement, and tender to his bereaved relatives our heartfelt sympathy in their day of sorrow, and be it further

Resolved, That while we realize that it is destined for all that live to die, and while all must submit to the decree of Him who, we are told, "doeth all things for the best," it is with regret that we realize that never on this worldly abode can we clasp his hand in honest friendship or hear again the sound of his cheerful voice.

Resolved, That our charter be draped for the space of 30 days. The members of Lodge No. 483 also request that this be published in the next issue of Journal.

R. J. FITZGERALD,
 Chairman of Committee.
 E. A. NELSON.
 JOSEPH DEGAN.

East St. Louis, Ill.

Dear Sir and Brother:

Please publish the working rules, having been approved by Local No. 363:

Working rules of Local No. 363 of the International Brotherhood of Boiler Makers, Iron Ship Builders and Helpers of America:

KNOWN AS TRANSIENT WORK.

The following rules shall govern all members of the International Brotherhood of Boiler Makers, Iron Ship Builders and Helpers of East St. Louis, Ill., and vicinity:

1. Eight hours shall constitute a day's work, between 8 a. m. and 5 p. m., except Saturday. Double time shall be paid for all overtime and the following holidays: All Sundays, New Year's Day, Independence Day, Thanksgiving Day and Christmas Day; also Saturday afternoon, and no member is permitted to work on Labor Day.

2. The minimum rate of pay for boiler makers shall be 60 cents per hour; for helpers and rivet heaters, 42½ cents per hour on all work.

3. The following shall be considered boiler makers' and helpers' work: All boiler work, breeching, stacks, up-takes, iron and steel ship building, all iron and steel tanks (pontoons, air, oil and water-tight), purifying boxes, stand pipes, smoke consumers, brewery vats, water towers, all work in and around blast furnaces and rolling mills, coal hoppers, ash chutes, coal bunkers, pans and tanks of all descriptions, superheaters, evaporators, condensers, gasometers, and all air, steam, gas water-tight work, all grain bins, grain tanks and steel grain elevators, the putting in of all flues or tubes, steel, brass or copper.

4. On all tight work a gang shall consist of four (4) men, namely: One (1) rivet heater, one (1) holder on, and two (2) boiler makers.

5. Saturday noon shall be pay day.

6. Each member shall be governed by

these rules and the constitution and by-laws of this organization.

JNO. ROCHE, S. L. 363.

Concord, N. H.

Dear Sir and Brother:

Inclosed please find a picture of a group of members who took part in the Labor Day parade, September 6, 1915. For the past five or six years there have been all kinds of parades in Concord, N. H., but never a Labor Day parade. To hear some of the people talk here, you wouldn't think there were enough union men to make a parade, but I wish to state that we not only had a parade, but we had one that we can feel

ing so, to voice his own and the lodge's appreciation of the faithful stewardship and good work rendered by Brother McDonnell, who accepted the token of good will from his associates with gratitude and assurance that he would continue to do all that he could to advance the interests of Lodge No. 585.

It was with profound regret that Lodge No. 585 heard of the temporary retirement from his sphere of activity of that prince of good fellows, that implacable opponent of corruption and dark cellar methods in trade unionism in our craft, International Deputy Organizer Charles F. Scott, for during his sojourn in Boston and vicinity he



A GROUP OF THE MEMBERS OF LODGE No. 245, CONCORD, N. H., LABOR DAY, 1915.

justly proud of. Good men were put on the committee for Labor Day, and they certainly did it up in good shape. Will also state that we carried off second prize (which is not so bad). After the parade, everybody beat it for Capitol Hall, where we had something on ice. Brother George Hudson took the picture.

Hoping you will find room for this in the Journal, I remain

Yours fraternally,
JAMES J. BERRYMAN, R. S.

Editor of Journal: East Boston, Mass.
Lodge No. 585 at a recent meeting showed its appreciation of its retiring treasurer, Brother Bernard McDonnell, by presenting him a pair of handsome gold cuff links. President William McNabb (who with Brothers Thomas J. Farmer and D. B. McInnes arranged the affair), in presenting the links to "Barney," stated he took pleasure in do-

ing so, to voice his own and the lodge's appreciation of the faithful stewardship and good work rendered by Brother McDonnell, who accepted the token of good will from his associates with gratitude and assurance that he would continue to do all that he could to advance the interests of Lodge No. 585.

It was with profound regret that Lodge No. 585 heard of the temporary retirement from his sphere of activity of that prince of good fellows, that implacable opponent of corruption and dark cellar methods in trade unionism in our craft, International Deputy Organizer Charles F. Scott, for during his sojourn in Boston and vicinity he

has been a great help to Lodge No. 585 in adding to its membership, rounding up delinquents, smoothing over in his practical common sense way many difficulties that have beset us; in fact, assisting us in every conceivable manner, and we hope conditions may soon warrant his re-entry into the arena of activity again.

Brother Robert Mills is still on the disabled list, but we hope he will soon be O. K. again.

We regret to state that efforts of the surgeons to the sore eye of Brother John Warrnock were unavailing and he is still suffering considerably from the terrible injury he received to his optic organ in August last.

Brother McNabb, our live-wire president, with our other active members, is doing all he can to build up the lodge.

Yours fraternally,
DANIEL B. MCINNES, C. S. L. 585.

Philadelphia, Pa.

Dear Sir and Brother:

The following is a copy of Mrs. Anderson's letter to the employes of boiler shop, Philadelphia Navy Yard:

To the employes of the boiler shop, Philadelphia Navy Yard, who have so generously contributed to a fund that was presented to me by your committee in the hour of need: I do not know how to express my appreciation of your thoughtfulness of this grand act of charity, which will be a memorial of your Christian character and will never be forgotten by me.

Mr. Anderson well understood in the last days of his illness what you were doing for him, and expressed a wish to shake hands with all in token of his appreciation, but his physical condition would not permit him.

Thanking all and may God's blessing ever remain with you,

Sincerely yours,

EMMA ANDERSON.

In connection with Mrs. Anderson's letter of thanks to the employes of the boiler shop, Philadelphia Navy Yard, permit me to add on behalf of the members of Lodge No. 19 a word of praise to which they are entitled. During Brother Anderson's long illness, our members never hesitated to visit him daily and console him, and in his hour of need arranged a drawing for his benefit; in six days' time realized the magnificent sum of \$190. The day of his funeral nearly every man in the shop (all members of Lodge No. 19) attended to pay their last respects and show the loyalty which we believe should be shown every shopmate.

Hoping you can arrange to publish this, as well as the others I am sending you, in December Journal, I am

Fraternally yours,

ROBT. S. HOPKINS, C. S. L. 19.

Portsmouth, Va.

Dear Sir and Brother:

The problem of today, as of yesterday and tomorrow, is how to establish equity between men. The worker who is forced to sell his day's labor today, or starve tomorrow, is not in equitable relations with the employer, who can wait to buy labor until starvation fixes the rate of wages and hours of time.

The labor movement is the natural effort of readjustment, and ever-continued attempt of organized workers, so that they may withhold their labor until the diminished interest or profit or capital of the employer shall compel him to agree to such terms as shall be for the time measurably equitable. These are the forceful methods of all times, and may continue to develop manhood and womanhood by forceful revolution as workers advance these lines or may cause social earthquakes, and become destructive by the the organized oppression of labor's rights.

Before the solution of the labor problem

can be reached, the nature of the complaint must be understood; primarily, the responsibility for strikes and outbreaks rests upon the wage labor system, a system that encourages cunning above conscience, that robs the worker and enriches the employer; a system that shortens life, engenders disease, enfeebles the mind, corrupts the morals and thus propagates misery, vice and crime; a system, like a serpent, pushes itself along wherever those bonds of commercial iron and steel are laid, carrying discontent in its train.

A system which enables a few men to sit at their desks in any of our large industrial centers without any thought of the welfare of the country and issue imperial mandates which direct the movement of the whole industrial population; a system which makes every industrial department head an autocrat at whose nod or beck the poor, unrequited horse whose labors must bow their head and bend their knees in suppliance. We should not war with man for being what we make him, but strike a powerful, telling blow at the base of the system so long as the present order of things exists. Just so long will the attempt to make peace between the man who sells and the man who buys labor be fruitless, but are prepared to lay seige to this bulwark of oppression.

Remember, it has been with us for centuries; it has slowly yet steadily been making new and deeper inroads day by day, year by year, until today it stands so well established and powerful than even the staunchest heart in the ranks of labor defenders almost sinks in despair at the thought of breaking down the barriers of dear ignorance and superstition to which its existence has given him birth. The toiler must educate himself so that presentations of facts that are before him are not to be remedied through suicidal strikes, but it lies only through effective organization.

Without organization, we are helpless, through it we can forever banish that curse of modern civilization, wage-slavery.

Fraternally,

H. E. PHELPS, Lodge No. 57.

North Bay, Ont., Can.

Dear Sir and Brother:

At the last regular meeting of Nipissing Lodge No. 417, the following resolutions were adopted:

Whereas, Our Heavenly Father, whom we believe and know doeth all things well, has, in His infinite wisdom, called to his heavenly home the beloved father of our worthy and esteemed brother, T. J. Arlien,

Resolved, That we extend to our brother and his family our sincere and heartfelt sympathy, in this their hour of sorrow, as the tide is broken here, there will be one to welcome them when they reach that land where there is no parting or sorrow.

Resolved, That a copy of these resolutions be sent to our esteemed brother, a copy sent

to his family, a copy spread over our minutes and a copy sent to our Journal for publication.

A. L. LYE,
E. COOK,
F. GARDNER,
Committee.

St. Louis, Mo.

Dear Sir and Brother:

It again becomes my painful duty to inform my brothers through the columns of the Journal of the sad and untimely death of a good and true member of this local (No. 27). This brother, Albert J. Savagnac, was a member of the Brotherhood since 1908. He was employed at the John O'Brien Boiler Works up to the time said firm with two others refused to sign the agreement. True to his union principles, this brother walked out on strike with the rest.

Naturally interested in the place therein, he, in passing by, the night of September 30, saw a light burning, approached closer, intent on seeing what was taking place; heard not the stealthy steps of the watchman paid to guard the property. What transpired between our brother and his assailants will never be known, as dead men tell no tales. Suffice to say that those foes of unionism, after beating our brother, shot him; yes, my brothers, shot him. He was taken to the City Hospital, where he died at 1:30 p. m. the next day.

The watchman (John Tolin) was exonerated; even though his shot deprived a wife of a husband, a little boy of his father, he went free. What a sad travesty on justice. On the pages of our history, the name of Brother Savagnac must ever remain an honored one, since he died a union martyr in the prime of his early manhood. Our brother was called away. The shock was a severe one, and the incidents surrounding his death cast a gloom over the beautiful October day on which our martyred brother was borne to his last resting place. Our local, No. 27, with the true sympathy and ever ready help and comfort for which our local it noted, turned out in large numbers. On every side could be heard expressions of sorrow and regret for the sad, sudden ending to a young life.

Too much cannot be said in condemnation of such treatment at the hands of those monsters of humanity. Our heartfelt sympathy and, I feel sure, the sympathy of all his brother members of the Brotherhood, go out to his loved ones. May He, the dispenser of all consolation, help and comfort them in their hour of sorrow in his taking away. We know we have lost a firm supporter of unionism, but we are proud of our deceased brother. Proud and devoted to the principles which made him a martyr. The principles which mean the right to earn a living, the right to be a union man and to stand for the right to uphold and keep to the letter our honored place in the field of labor,

even in the awful opposition we are meeting with.

Fraternally,
JAS. REDMON,
JAS. DONNELLY,
JAS. CALLAHAN,
Committee.

Little Rock, Ark.

Dear Sir and Brother:

At our last regular meeting of Local No. 69, the following resolutions were adopted:

Whereas, It has pleased the Almighty God in His divine wisdom to remove from this life the infant son of our worthy and esteemed brother, G. D. McLeod; therefore, be it

Resolved, That we, his brothers, extend to Brother McLeod and his wife our heartfelt sympathy in this his sad hour of bereavement and pray that God may comfort and console them that they may bear their sorrow with Christian patience.

Resolved, That these resolutions be spread on the minutes of Local No. 69, and a copy be sent to the bereaved parents, also a copy be sent to the Journal for publication.

W. A. ROOKSBERY,
J. A. GODFREY,
JOHN ENGLEBERGER,
Committee.

Wichita Falls, Tex.

Dear Sir and Brother:

At regular meeting of Wichita Falls Lodge No. 576, the following resolutions were adopted:

Whereas, It has pleased the Almighty God in His divine wisdom to remove from our midst the dearly beloved father of our worthy and esteemed brother, W. D. Talley; therefore, be it

Resolved, That we, his fellow brothers, extend to our brother our heartfelt sympathy in his hour of bereavement, and pray that the Almighty God may comfort and console him that he will bear this trial with fortitude; be it further

Resolved, That a copy of these resolutions be spread on the minutes of our lodge, a copy be sent to the bereaved brother and a copy to our official Journal for publication.

F. ENNIS,
J. A. MALEY,
JAMES ALEGO,
Committee.

Minneapolis, Minn.

At a regular meeting of Flour City Lodge No. 11, the following resolutions were adopted:

Whereas, It has pleased Almighty God in His divine wisdom, to remove from our midst the dearly beloved son of our worthy and esteemed brother, William M. Teague; therefore, be it

Resolved, That we, his fellow brothers, extend to our brother our heartfelt sympathy in this hour of bereavement, and pray that the Almighty God may comfort and con-

sole him, and that he will bear his trial with fortitude; be it further

Resolved, That a copy of these resolutions be spread on the minutes of our meeting, a copy be forwarded to our official Journal for publication.

FRED OLSON,
JOHN AMUNDSON,
E. A. CONLIN,
Committee.

Madison, Wis.

Dear Sir and Brother:

I am inclosing under separate cover a photo of our second annual Labor Day float, which I would like to see published in Journal.

Our float this year was a decided change from that of last year, as it did not so

mobile, are Brothers Stevens, Forrest, Hagan, Froney, in car front seat; Hartner and Westover at wheel, with his baby boy as mascot, seated on windshield; back seat, Magarvio and McCann. I am very sorry that Brothers Dixon and Driscoll were not able to attend.

The revival of Labor Day parades in this city is not meeting with the success or cooperation that was expected. I firmly believe that this is not only a waste of money, but a waste of time and energy for the little results accomplished. If the money we spend on Labor Day were properly spent on giving legal education to some of our young men and women of the labor movement of this country, the results would be of greater nature and have a deeper effect on the labor movement in general. Why?

The one man who is considered the greatest legal mind of this country by our friend,

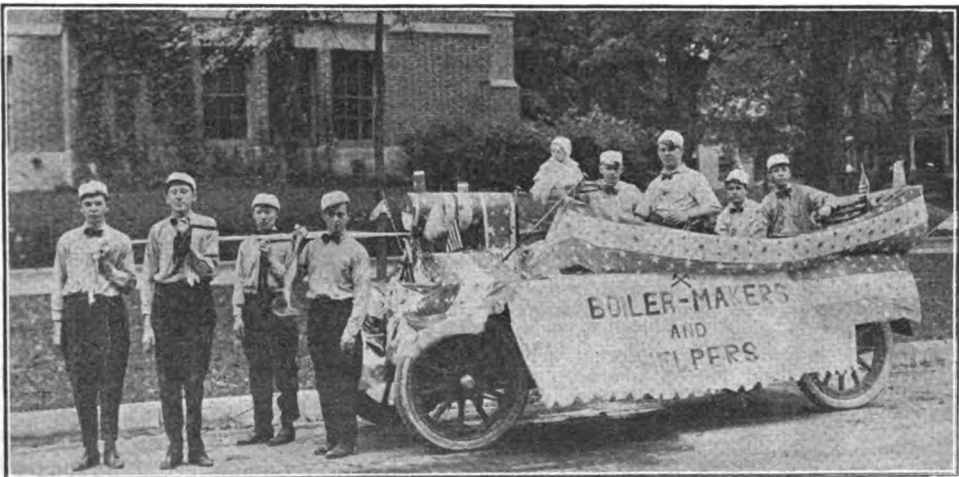

FLOAT OF THE BOILER MAKERS AT MADISON, WIS., LABOR DAY, SEPTEMBER 6, 1915.

forcibly impress on the minds of those who were curbstome spectators, the element that goes to make up the average boiler shops. I am safe in saying that the average person, or over sixty per cent of the people, does not know under what trying conditions we have to work; if it were possible to awaken in every person of society that slumbering element of human feelings, boiler makers included as well, how soon would the condition of labor be righted, and placed on a more human basis.

Brother Westover donated the services of his automobile for the day. The boiler that is mounted on the hood of the car was constructed out of time by Brother Hartnett and Brother Westover, and same decorated by Mrs. Westover. The Madison Federation of Labor, Carpenters and Teamsters also had floats in the parade, and about seven hundred local union men turned out.

Reading from left to right, leading auto-

mobile, are Brothers Stevens, Forrest, Hagan, Froney, in car front seat; Hartner and Westover at wheel, with his baby boy as mascot, seated on windshield; back seat, Magarvio and McCann. I am very sorry that Brothers Dixon and Driscoll were not able to attend.

Possibly if we would follow this mode of legal procedure, we would have less lawyers and court fees to pay, and possibly a case like the Danbury Hatters would have been avoided. It is a foregone conclusion, if the workers are to be successful, they must adopt some of the methods used by the corporation, but the greatest weapon in the hands of labor is education of the masses. Violence will only react on us. Therefore, brothers, we must build the future society on the bedrock of education. Let our motto be: Education first, last and all the time.

Sincerely yours,

W. L. FOREST.

Minneapolis, Minn.

At the last regular meeting of Flour City Lodge No. 11, the following resolutions were adopted:

Whereas, It has pleased the Almighty God in His divine wisdom to remove from our midst the dearly beloved daughter of our worthy and esteemed brother, T. B. Coleman; therefore, be it

Resolved, That we, his fellow brothers, extend to our brother our heartfelt sympathy in this his sad hour of bereavement, and pray that the Almighty God may comfort and console him, and that he will bear his trial with fortitude; be it further

Resolved, That a copy of these resolutions be spread on the minutes of our meeting, a copy be forwarded to our official Journal for publication.

FRED OLSON,
JNO. AMUNDSON,
E. A. CONLIN,
Committee.

Hagerstown, Md.

Dear Sir and Brother:

Please have the following notice inserted in the next issue of Journal:

At a regular meeting of Antietan Lodge No. 578, the following resolutions were adopted:

Whereas, Almighty God has seen best to take from our midst our beloved brother, I. W. Bohn; therefore, be it

Resolved, That we have lost a most worthy member of our organization and that our deepest sympathy be extended to the bereaved wife and relations of our departed brother and that a copy of this be sent to the wife, a copy be spread on the minutes of our lodge, and a copy be sent to our official Journal for publication.

C. F. MARTZ,
C. F. MOSER,
F. H. GOODYEAR,
Committee.

A Compilation of Labor News.

(By The A. F. of L. News Service.)

SOUTHERN NEWSPAPERS FAVORS TRADE UNIONS.

Columbia, S. C.—The Columbia State has again shown it is in the forefront of thoughtful Southern newspapers by a defense of the workers' right to organize. Manufacturers are called upon to reckon with the spirit of the times, and in referring to the discharge of several cotton operatives in Greenville, because they joined the United Textile Workers' Union, the editor says:

"Collective bargaining by labor is recognized nearly everywhere in the United States, and in opposing it is no more wisdom than would be opposing movements of the tides or the march of the seasons."

"To say that textile workers of the South," continues this paper, "are peculiarly situated, that they and their work differ from other laboring men and their employment, so that unionizing they would not help them, is to challenge the plain facts of labor's history.

"If the mill workers of South Carolina have in politics flocked together, if they have sometimes stopped their ears to the appeals of their real friends, if they have fallen an easy prey to demagogues opposed to every reform designed for their betterment, the explanation is not hard to find. They have felt that they were neglected and forgotten. A sense of helplessness and hopelessness has depressed them and they have groped for and grasped at anything that has promised relief and strength. Why should anyone oppose their unionizing? Why should they not join forces? Let them do so, and as sure as day comes after night, they will become self-reliant and gain freedom from a

demagogic domination. They will learn and know that fellow citizens engaged in other work are not their enemies and oppressors.

"The mill workers have the right to unionize. Their unionizing cannot and ought not be prevented. It will make them better citizens and better men. It will in time make them freer and stronger. That is enough for The State."

BANKS WARNED AGAINST USURY.

Washington.—Comptroller of the Currency Williams has mailed a letter to all national banks calling attention to the law against usury.

"This office," says the letter, "regrets to report that the sworn statement of condition of a great many national banks show that Section 5197, U. S. Revised Statutes, against usury, has been grossly violated by these banks.

"You are respectfully advised and admonished that this provision of the national bank act should be faithfully observed by all national banks, their officers and directors, in accordance with the solemn oaths taken by directors.

"You are requested to read this letter at the next meeting of your board of directors, and to have it inscribed upon the minutes, and to send a copy of this letter to every member of your board who may not be present at such meeting."

In a speech last month the federal bank official called attention to the usurious practices of certain national banks, which charged, in some cases, as high as 2,400 per cent.

"Here in this country," he said, "We find bankers, men in business who should be the most respectable, as it is the most responsible of all secular avocations, literally crushing the faces of their neighbors, deliberately fastening their fangs in the very heart of poverty."

SPECIAL PRIVILEGE SURPRISED.

New York.—Special privilege in this state has not recovered from its smashing defeat when the people rejected the new constitution at the last election.

The majority of nearly half a million against surprised the most optimistic opponent of the proposed organic act. Trade unionists were a unit in their opposition and the campaign carried on by the organized workers made it possible for every citizen in the state to become acquainted with those sections in the constitution that were designed to place the military above civil authority. As the convention that framed this constitution rejected the numerous suggestions made by labor, it is quite possible that the next convention will recall labor's demonstration of solidity on the first Tuesday in November. Other objections to the new constitution were: Governor could appoint officials without confirmation by the state senate; governor would have unrestricted authority to remove officials and his power over appropriations would be extended.

REJECT ALLEGED "M. O."

Detroit.—Trade unionists succeeded, at the last election, in defeating the proposed municipal ownership plan by an actual majority of 2,399. It was necessary to secure 60 per cent of the total vote cast. This means that the plan was rejected by about 10,000 votes.

Unionists opposed the plan because it made no provision for arbitrating grievances workers might present. It was proposed to make the commission that would run the street cars absolute dictators, beyond the control of the city council or other representatives of the people. The powerful street car men's union showed that if this plan was adopted it would be impossible to enforce contractual relations similar to those now existing between them and the present company, and that they were in danger of losing every advance it has taken years to secure. The unionists attempted to have the proposal amended so that the workers' rights would be protected. In this they failed, so they defeated the plan.

By the small majority of 167 an amendment was carried which empowers the city to adopt the plan. It is claimed that under this amendment the defeated proposal can be resubmitted to the people.

EVILS OF CHILD LABOR SHOWN.

Berkeley, Cal.—There are just 1,990,225 children less than 15 years old working for wages in the United States, said Miss Jose-

phine J. Eschenbrenner, of the national child labor committee. This is a ratio of one child in six, she said, who are kept out of school to make American dollars under fearful industrial conditions. In New York there are 10,000 houses in which sweatshop labor is carried on. This means 120,000 families engaged in this kind of labor in the shadow of the statue of liberty. Other Eastern cities are also hotbeds of this sort of industry, while in Southern cotton mills conditions are appalling. The morale of whole states full of pure Americans has been lowered through child labor, she declared.

NEW PACIFIC BOAT LINE.

New York.—The Pacific and Eastern Steamship Company, a \$2,000,000 corporation, has been organized with offices in this city, for the purpose of replacing the Pacific Mail Steamship Company. The new line will operate under the American flag.

The Pacific Mail recently sold its vessels to an Eastern company and stated that it was forced out of business by the new seamen's law. Secretary of Commerce Redfield replied that a profit of \$1,000,000 might have been a factor in the transaction.

The new company supports the claim of defenders of the seamen's law that the American flag will continue to fly with profit over vessels in the Oriental service doing business under humane conditions.

LABOR'S TWO ASSETS.

Pueblo, Colo.—"Organized labor cannot advance by the commission of crime," said John R. Lawson, in a speech in this city. "Education and moral courage are the two great assets of our cause. As yet, all laboring men have not the moral courage to stand up and demand that their rights be considered. But a new era is dawning, and through these two assets we will win."

A large crowd welcomed the miners' official who visited this city for the first time since his unjust conviction in Judge Hillyer's court. He made but one reference to his imprisonment, and then in a humorous manner.

LARGE EARNINGS OF U. S. STEEL.

New York.—Earnings of the United States Steel Corporation for the last quarter total \$38,710,644, an increase of \$10,760,589 over the preceding quarter. The report states that the three months embraced in the quarter show a steady growth. September's earnings of \$14,569,652 exceeded those of August by \$922,000, while August made a gain of \$1,736,762 over July.

EXPORTS MAKE RECORD.

Washington.—September was a record-breaker for United States exports, the figures being the largest in the history of the bureau, according to a statement made by the bureau of foreign and domestic commerce. The exports for September, this year, totalled \$300,676,822, compared with

\$156,052,333 for the same month last year. The imports also showed an increase in September of this year, the first time an increase has been shown for many months. The figures indicate that \$151,236,026 worth of materials were imported into the country in September, 1915, as compared with \$139,710,611 for the same month of last year.

RECORD FOR R. R. EARNINGS.

Philadelphia.—A report covering the net earnings of the Pennsylvania railroad lines east of Pittsburgh should furnish a clue to those well-meaning citizens who marvel at the "unrest and discontent of working people." The report shows that the net earnings for September amounted to \$7,282,021, and is the largest for any one month in the railroad's history. The gross earnings of \$20,817,361 have been exceeded only twice, the figures for the months of August and October, 1913, being slightly higher.

BUYS 175,000 TONS OF RAILS.

Philadelphia.—The Pennsylvania railroad has placed orders for 175,000 tons of steel rails, which is said to cover the requirements of this system. An order for 75 heavy

freight locomotives for immediate delivery has also been placed. These locomotives are to be used on lines east of Pittsburgh.

SUSPEND STEAMBOAT PROBE.

Washington.—Secretary of Commerce Redfield has ordered that the investigation of the steamboat inspection service of the Great Lakes be suspended. Steamboat inspectors who were conducting this probe have been ordered to their respective stations. It is stated that this order was issued as a result of the seamen's law, which became effective on American vessels November 4. The investigation started shortly after the Eastland disaster.

ADOPT MINIMUM WAGE LAW.

Cleveland.—A minimum wage amendment to the city charter was adopted at the recent election by a majority approximating 50,000. The act applies to all work done by the municipality and provides that where a craft is organized, the rates of that union must prevail. In trades and callings where no unions exist a minimum of \$2.50 per day shall be the rule.

Among Our Exchanges.

LABOR IN PROTEST TO THE GOVERNOR.

Protesting against the appointment to state departments of men termed inefficient and "unqualified under the law," the Columbus Federation of Labor last night authorized the sending of a letter to Governor Willis, signed by President George S. Compson and Secretary A. L. Leavitt, in which the recall of certain appointments is asked.

Men who jeopardize the efficiency of these departments have been appointed to replace men who have proven their qualifications and efficiency, the letter states. Particular objection is voiced against J. C. Callery of Hamilton, recently appointed chief state boiler inspector, and C. A. Karnell of Toledo, deputy boiler inspector.

"Enemies of Labor."

The letter follows:

We desire to call your (Governor Willis) attention, as part and parcel of the labor movement of the state of Ohio to appointments being made in various departments, created by and through the efforts of organized labor, of men who will jeopardize the efficiency of these departments, by substituting incompetent men, such as J. C. Callery for chief boiler inspector, of Hamilton, Ohio, and C. A. Karnell as deputy boiler inspector, of Toledo, Ohio, who are incompetent for the positions; besides the above-named are well known scabs, they being appointed to fill the positions which were held by efficient union men.

We protest the appointment of men not qualified under the law and known enemies

of organized labor, to positions in departments created through the influence of organized labor.

And we further protest to these inefficient servants displacing men who have proven their qualifications and efficiency, for the reason that members of organized labor are better qualified for the positions.

We therefore urge and request that these and similar appointments be recalled, and that in departments affecting labor, where appointments are to be made, members of organized labor be appointed, that the interests of labor may be justly administered.—Ohio State Journal.

SHIP BUILDING IN JAPAN.

Great activity is being shown at all Japanese shipyards, even the smallest keeping their employes at work day and night. At the Mitsu Bishi yard in Nagasaki four ships with a tonnage of 7,300 each and two of 3,700 tons each are under construction. At the Kobe yards of the same company one 1,800-ton and two 5,300-ton vessels are on the ways. In the last named city the Kawasaki yards are building one 1,700-ton, and one 3,000-ton, two 4,000-ton, and three 7,300-ton boats. Other important orders being executed at the different shipyards are: Osaka Iron Foundry, Osaka—six 7,300-ton, one 5,000-ton, twelve 3,200-ton, one 1,100-ton; Uraga Dockyard Co., Uraga—four 2,200-ton vessels; Fuji Nagata yard—one 2,000-ton ship; Harima yards, Kobe—two 1,100-ton vessels.

This is a total of 43 ships, and there are

said to be many still being negotiated for between builders and owners. The Mitsui Bussan Kaisha is negotiating for the building of two cargo boats of 5,000 tons each. Builders are now reluctant to accept orders in anticipation of a scarcity of materials.—Coast Seamen's Journal.

ARE WE FAILING?

"In Boston recently out of 600 applicants for the navy only thirty were accepted. This is an example of the proportion of our fit young men in the large cities." This is a statement attributed to Rear Admiral Ross.

It is time for us to stop and think a bit. We have been hearing that some nations are degenerate; perhaps we have been thinking so, too. Undoubtedly we have had a comfortable glow as we reflected: "Well in this new land, where there is still room and air for everyone, with our constant infusion of new and vigorous blood, we are the finest race the world has ever seen." But are we? If only 5 per cent of our young men are fit for the navy, then certainly we are in a bad position. We could not have fought the Civil war on that basis.

Of course we must make some allowances. Not anything like all of our abler young men were included in this test, not many of those who would be ready to serve at need. Again, probably many of those rejected could be used in time of real need. Still, one thing is perfectly plain. With all our clubs and gymnasiums and playgrounds and school athletics, we have not begun in the cities to overcome the harm to health and efficiency that is done when a great city comes into being.

Now we need these young men, all of them, not merely because defense calls first and last and always for men, but because we need efficient men for peace and nation-building far more than for war. Manifestly our cities have still a mighty and a fearsome problem. There is no ground for the man to stand on who begins to argue that "We have done enough." With Boston's record at 5 per cent, we are down at the bottom, and we cannot move too fast.—The Milwaukee Journal.

WHY HAS CO-OPERATION BEEN A FAILURE IN AMERICA?

Why have the workmen of America failed to develop the co-operative movement which has proven to be a marked success in many other countries?

Recently in reading the correspondence columns of the official journal of another trade we were impressed with a statement which was made to account for the lack of vigor in one of the local unions.

"The local membership," the writer said, "have lost all of their vitality because they were unsuccessful in their endeavor to establish a co-operative shop. Furthermore, they foolishly lost several hundred dollars; thus they became financially broke, and mentally, if I may say, static."

Why did their co-operative shop fail? Why have the co-operative foundries established by our members failed? Why has practically every productive co-operative enterprise launched in America failed?

The true answer might enable us to better understand some of the problems our movement must solve if it is to be the force for good which it should be.

The workmen's co-operative societies of Europe have been in existence for many years, and have given most splendid returns to their members. The total amount of business which these societies transact is startling to the American worker.

One co-operative association in Great Britain, the Co-operative Wholesale Society of Great Britain, had 1,510 local branches with a membership of 3,188,140 in 1914, and during that year it transacted business to the amount of \$673,666,411.62. In addition to this the society has a banking department, the total transactions of which for 1914 footed up to about \$900,000,000.00. Equally remarkable figures are submitted from the workmen's co-operative movements in Belgium, Germany and the Scandinavian countries.

Why have no such movements proven successful in America?

Robert Owen, the great English co-operator, spent many years in America preaching the doctrine of co-operation and founding co-operative societies. Union and non-union workmen have become co-operators. The leaders of the trade-union movement, immediately following the Civil War, preached co-operation, our own Wm. H. Sylvius being a leader in the movement. In our earlier conventions co-operation was one of the most prominent questions and it met with the hearty support of the officers and members. With all of the encouragement which International Union could give co-operative foundries were started in a number of cities and finally a \$100,000.00 co-operative enterprise was launched in Pittsburgh, Pa., under the direct supervision of the International Union, yet all of these failed, most of them finally passing into the hands of business men who made them profitable to themselves. Our experience has been that of practically every other trade in this respect.

What has been the reason for these failures in America of methods which have proven successful in Europe?

The students and thinkers who can discover the causes will confer a great benefit to the workers, for through co-operation the workers can make their resources go much farther than they can without.—International Molders' Journal.

STARTLING, IF TRUE.

One of the "features" in the agreement arrived at between the Rockefeller coal miners' union and the Rockefeller coal mining company is the declaration that "the com-

pany agrees to abide hereafter" by the mining and labor laws of Colorado. Such magnanimity is indeed touching. Of the many "concessions" voluntarily made by Mr. Rockefeller, this one is really almost too

good to be true. Think of it. Brethren, Rockefeller has "voluntarily" agreed to "hereafter" abide by the law. Goodness gracious, call the police!—Coast Seamen's Journal.

News of General Interest.

THE RUSSIAN STATE RAILWAYS LOCOMOTIVE.

(By Frank C. Perkins.)

The accompanying illustration shows one of the 250 locomotives of the Decapod (2-10-0) type built for the Russian State Railways at Philadelphia, Pa. Apart from the magnitude of the order, these engines are of interest because of their design and the urgency with which they are being constructed. Although the axle loads are light, as compared with American practice, they should be able to do easily, while working at fairly economical cut-off. While special materials and equipment are used to a considerable extent in the

rows of expansion stays, which are of a new design recently introduced by the builders. The nut on the upper end of the radial stay is seated in a dis-forged stirrup, which is screwed into the roof-sheet. After the nut has been adjusted to give the proper tension, the thread on the stay is set into the nut with a punch. This is a simple arrangement, which has ample flexibility and utilizes ordinary stay-belt taps in the boiler and firebox sheets; while the water space above the crown is not obstructed, as is the case where T-iron stays are used. These locomotives are equipped with Schmidt superheaters and outside steam pipes. The superheater is composed of 28 elements,

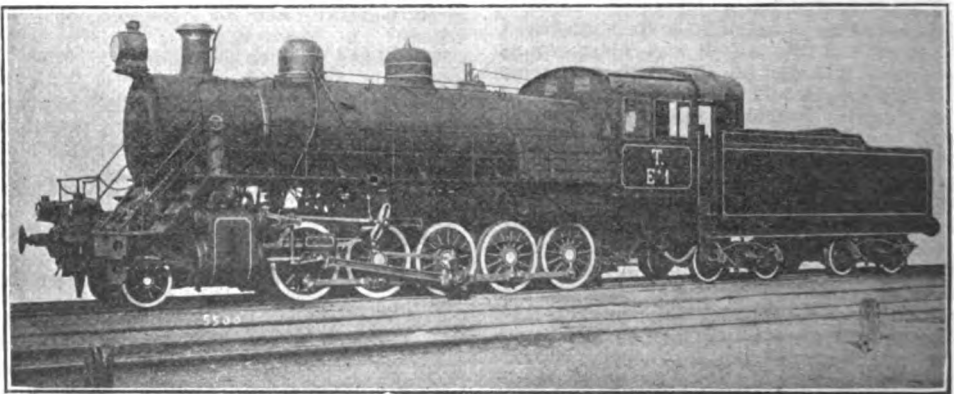

A LOCOMOTIVE BUILT FOR THE RUSSIAN STATE RAILWAYS.

construction of these engines, the design is generally in accordance with the practice of the builders. The fuel used is a most inferior grade of bituminous coal, and this is burned on a rocking and drop grate with an tice, the locomotives are of considerable capacity, as they exert a tractive force of 51,500 pounds. The ratio of adhesion, however, is unusually low.

It is of interest to note that these locomotives are designed to haul 1,000 metric tons up a straight grade of 0.8 per cent, at a speed of approximately 8 to 10 miles per area of 64.5 square feet. The fibre box is placed above the driving wheels, and is equipped with a sectional brick-arch supported on water tubes. The fire-doors are pneumatically operated. The inside firebox is of copper, and copper stays are used in the water legs.

It may be stated that the front end of the firebox crown is supported by three

with a superheating surface of 563 sq. ft. The steam distribution is controlled by 12-inch piston valves, which are arranged for inside admission and driven by Walscherts motion. The Rushton power reverse mechanism is applied. This device is operated by a small rotary air engine. It is exceedingly compact, and if necessary can be arranged, without difficulty, for manual operations.

It will be seen that the cylinders, frames and running gear closely follow American practice in design. Forty per cent of the weight of the reciprocating parts is balanced, and careful attention has been given to making these parts as light as is consistent with the required strength. The pistons have rolled steel heads, with cast iron rings sprung in, and extended rods. The guides and crossheads are of the single bar type, following Russian practice in design. The front and back driving wheels have a total

lateral play in the boxes of 7-16 inch and the knuckle pins in the front and back side rods are fitted into spherical bushings to provide for lateral motion.

The main driving-wheels have plain tires. This construction is necessary as the engines will be required to traverse curves of 350 feet radius. In accordance with Russian practice, these locomotives have a wide running board with a railing around the outer edge. There is also a railing around the front bumper. The cab is of steel, and the front end of the tender is enclosed, to protect the engine crew from the weather. The equipment includes Russian-Westinghouse automatic air brakes.

The couplers and buffers are of course arranged in accordance with Russian practice. The tender is carried on two four-wheeled trucks, which are of the arch-bar type, with rolled steel wheels. The frame longitudinal sills consist of 12-inch channels. The tender is of light construction, as it was important to reduce the weight where possible.

This locomotive built for Russian State Railways has a gauge of 5'0", the cylinders measuring 25x28 inches and the valves are of piston type 12 inch in diam.

The boiler has a diameter of 70", the thickness of sheets being $\frac{5}{8}$ " and the working pressure is 180 lbs. The fuel is low grade soft coal and the firebox has a length of 108 $\frac{1}{8}$ " and a width of 86" and the thickness of sheets, sides $\frac{1}{2}$ " and the back being $\frac{1}{2}$ " and the tube 1 $\frac{1}{8}$ ".

This locomotive is equipped with Schmidt superheater, having a superheating surface of 563 sq. ft. The total heating surface is 2,601 sq. ft. and the grate area is 64.5 sq. ft. The weight on driving wheels is 176,000 lbs. and on truck 22,000 lbs. while the total weight of engine and tender is 330,000 lbs.

MODERN ELECTRIC ARC WELDING.

(By Frank C. Perkins.)

The accompanying illustration shows the electric motor generator set, switchboard and apparatus for welding with the electric arc as developed at Cleveland, Ohio. In welding with the electric arc as with ordinary welding the two pieces of metal when heated to the proper temperature and brought in close contact may be united into one solid piece. The foundation of the whole process of welding lies in bringing the pieces of metal to the proper heat.

This has been done in various ways, the most familiar being the forge fire, in which the blacksmith heats the ends of the two pieces of metal he wishes to weld. More modern methods include the oxy-acetylene torch which burns gas to produce the heat. The thermit process depends upon the chemical combination of two substances to produce great heat and lastly the electric arc, which transforms electrical energy into heat for welding purposes.

It is pointed out that the only purpose of electricity in welding is to supply the heat.

Thorough understanding of this simple fact will do away with most of the mystery with which this subject has been surrounded. The idea has been prevalent that electricity possesses some mysterious characteristic which makes it especially effective in welding work, but nothing could be further from the truth.

It is clear that the blacksmith's forge fire, the acetylene torch, the thermit process or any of the other methods of producing great heat will heat pieces for welding equally as well as electric arc. The advantages which the electric arc enjoys are, first: The production of greater heat at lower cost, and second, the convenience in applying this heat where it is needed for welding purposes.

It is of interest to note that the anvil weld is applied to welding processes where the two pieces of metal after being heated are forced together by pressure in order to complete the weld. Again the familiar example of this is the weld which the blacksmith makes by first heating on his anvil. In regard to butt and spot welding, it may be stated that an application of this is the spot or butt welding process in which two pieces of metal are heated by electric means, and then pressed together to complete the weld.

Autogenous welding is a process where the metals are raised to such a temperature that they will fuse together on contact without pressure being applied. The main difference between the two processes is one of the temperature of metal at the weld.

In electric arc welding the electric arc is a gap in an electric circuit and the current "jumps" or "arcs" across this gap. It does this against great resistance because electric current does not pass easily through the atmosphere. Because of this resistance great heat is produced and the ends of the gap in the circuit become very hot. This process of course much refined, as a matter of fact the metal which is to be welded usually forms one end of the gap, or one electrode and a stick of carbon or a rod of metal forms the other electrode. The heat produced by the electric arc has never been measured, but it is variously estimated at a temperature of 6,500 to 7,000 degrees Fahrenheit, and is the highest temperature which can be produced at the present time.

It is claimed that the principal advantage of the electric arc for welding is the fact that it produces heat at lower cost. Compared for instance with the oxy-acetylene torch, the electric arc will produce effective welding heat at from ten to thirty per cent of the cost of the other method. There are two methods of arc welding, one where a carbon electrode is used, and one where a metal electrode is used. With the carbon electrode the heat which can be obtained is practically unlimited, and metal can therefore be melted very rapidly; in fact, faster than with any other possible method, applicable to welding.

In welding, there is used a rod or wire of metal for the electrode in place of the carbon. This electrode is gradually melted, and furnishes the molten metal for joining the welded parts. The electric arc may be used for welding practically all metals. There are several practical difficulties, however, which are always encountered in welding work. These limit the use of the process for commercial purposes somewhat.

It is maintained that the first difficulty is the expansion and contraction which results from heating a certain part of a piece of metal or how the heating of the rim of a

intimate contact and a perfect weld cannot result. The welded surfaces, however, may be kept clean by floating the oxide on top of the molten metal.

In considering the subject of welding of iron and steel, it is pointed out that the difference in welding of metals is best understood by studying some of the practical applications of electric arc welding and the simplest of these is the welding of cast steel.

It is well known that steel castings are produced by melting the steel, pouring it in a mold and allowing it to cool in the de-

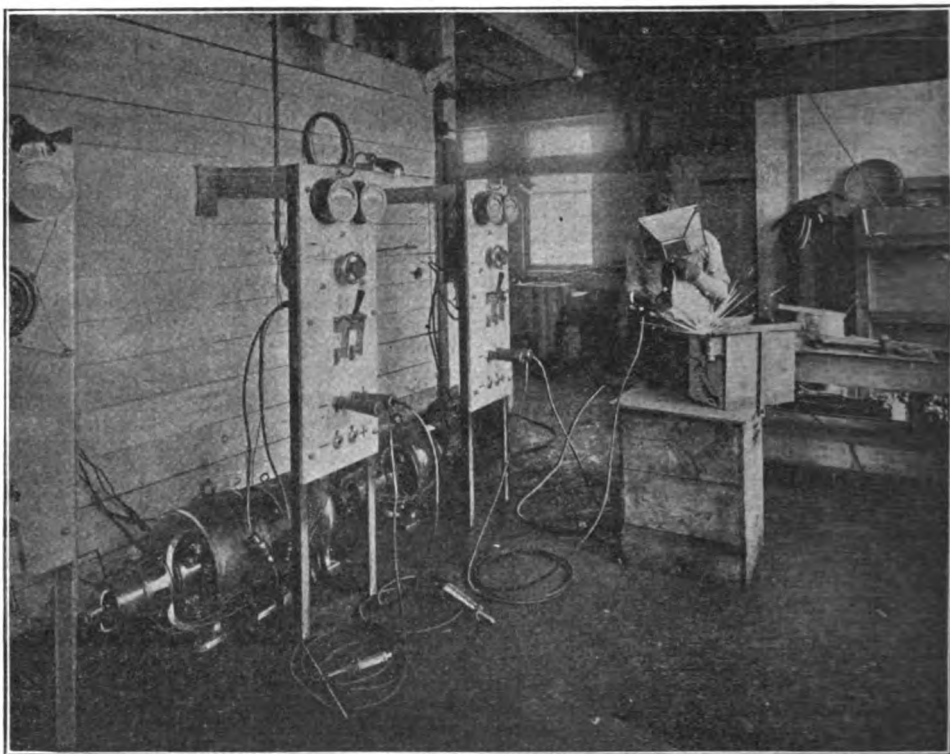

MODERN ELECTRIC ARC WELDING.

metal wheel and the subsequent cooling off that part would set up strains in different parts of the wheel. This difficulty can be overcome by different methods. The whole piece is often heated before the welding operation begins or it may be annealed by heating afterwards.

In the matter of expansion and contraction, the electric arc has a distinct advantage over the oxy-acetylene flame, due to the fact that the intense heat of the arc is confined to a very small area. The oxy-acetylene flame always heats up a large area around the weld. The second difficulty in welding is due to the formation of oxides. Metals at high heat combine with oxygen, the oxides thus formed on the parts of the metal to be welded will prevent the metals coming in

sired shape. Now if there is a place in this casting which is not filled out as it should be, it is a simple matter to melt steel in the electric arc, and weld it into this low spot, because the material which is added is the same as that of the original casting—simply steel which has been melted and has cooled again. By adding metal of exactly the same chemical composition as the casting the weld can be made identical with the rest.

In order to do this the casting is connected to one end of the electric circuit so that it forms one of the electrodes. The operator handling the other electrode brings it in contact with the surface of the casting, then quickly withdraws it a short distance, causing the electric arc to form between the carbon and the casting. After heating

the surface around the low spot and melting the steel he places a rod of steel in the flame of the arc and allows the metal to run into the low spot until it is filled.

In the electric welding rolled steel, it is well to note that steel when rolled or worked is changed somewhat in its nature. It is made more compact, tough and elastic. The steel sheets, structural steel shapes, steel rails, and various other products are produced by this rolling or working process. When two pieces of such material are welded the work is done by melting the steel at the point of weld, and allowing it to cool again, usually adding some metal from an outside source.

Of course the metal will not be the same as the other metal. It will be cast steel because the melting has taken away all the effects of working or rolling. This is a most important fact to remember in electric arc welding of rolled stock. The material in the weld can never have exactly the same properties as that in the original piece. It may have the same tensile strength but it will never have the same degree of elasticity. This is a limitation of any welding process. The nature of the weld can be controlled of course, by the kind of metal that is added.

It is claimed that low carbon steel will make the weld more ductile; high carbon steel will make it higher in tensile strength. Welds can be assured in rolled stock which are stronger than it is possible to produce by the methods of riveting. This is readily seen when it is remembered that the efficiency of the quadruple riveted double strapped joint is not greater than 85 per cent, while the arc welded joint may be made with an efficiency of 90 per cent without particular difficulty.

It may be stated that the process by which wrought iron is manufactured leaves a certain amount of slag in the metal. In welding, care is taken to float this slag out of the weld. Otherwise wrought iron is treated in exactly the same manner in arc welding as rolled steel. Either carbon or metal electrode is used depending on the size or shape of the pieces to be welded.

It may be mentioned that the current for electric arc welding must be direct current, and the voltage required is from ten to fifty volts, depending on whether a metal or carbon electrode is used and upon the kind of work being done. Alternating current is not practical for use in electric arc welding. The alternating current arc is difficult to control and the heat is not so easily applied as with the direct current arc. A large part of the heat generated in the electric arc is liberated at the positive electrode, that is, at the electrode from which the current flows. In an alternating current arc the polarity of the electrodes changes with each alternation of the current, that is a certain electrode will be positive one instant and negative the next, so that the heat is divided equally between the two electrodes. With the direct current one electrode re-

mains positive, and the heat is generated at this point, thus making it easily controlled.

As to the direct supply current, it may be stated that where the current on the power line is continuous or "direct" it can be used for welding purposes simply by cutting it down to the proper voltage. This can be done by putting a resistance in the circuit which means that the extra power not needed for welding is simply wasted in the heat passing through the resistance. If the direct current supply is 220 volts and it is cut down to 30 volts for electric welding purposes, the ratio of power used to power taken from the line is as 30 is to 220. More than six times as much power is wasted as is actually used for the welding operation. With an alternating supply current this must be changed to direct current, and must also be cut down to the proper voltage for welding.

The electric welding equipment is simple and efficient. The purpose of all electric arc welding machinery is to take the available supply current and deliver it in proper form for welding work. The simplest form of machine is a motor (either alternating or direct current, depending on the supply). This motor is turned by the current from the supply line and the motor in turn drives a generator which is made to deliver direct current at a voltage more nearly suitable for welding.

In one type of motor generator offered for welding service, the current is delivered at a constant voltage of 75 volts. In order to do welding work this 75 volts must be cut down to from 10 to 50 volts, depending on the work, so that there is still from 30 to 80 per cent waste owing to the use of resistance. However, some saving results from the use of such a "constant voltage" machine because it lessens the amount of current wasted by resistance.

It is claimed that the variable voltage machine is better adapted to welding work as it is so made that the generator delivers just the voltage required by the arc. For instance, in welding at the time the electrode touches the piece to be welded the voltage is nearly zero, and as the electrode is drawn away the voltage increases with the length of the arc. It will be seen, therefore, that the voltage is constantly varying. A machine, which will give exactly the voltage required will make a great saving. With this type of machine no resistance whatever is necessary, and no power is wasted in this way. The only object of welding equipment is saving of power and this type of machine gives the greatest possible saving.

Comparing the cost of various forms of welding, suppose the arc uses 150 amperes current, the voltage of the supply line is 250 volts, and the voltage really necessary at the arc for welding purposes averages 25 volts and assume that the current will cost 2 cents per kilowatt hour. Then comparing the cost of electric power first, when welding with simply a resistance in the cir-

cut; second, when welding with a 75 volt constant voltage motor generator; and third, when welding with a motor generator which will deliver just the voltage required. Where the motor generator is used approximately 25 per cent must be added for loss in the two machines.

Taking the system utilizing the 250 volt lines with resistance and 150 amp. using 37.5 kilowatt hours per hour welding, the cost of power per hour of welding would be 75 cents. Now with the motor generator 75 volts constant with resistance using 14.06 kilowatt hours per hour welding, the cost of power per hour of welding would be 28 cents, while with the motor generator variable voltages average 25 and no resistance using 4.69 kilowatt hours per hour welding, the cost of power per hour of welding would be 9.4 cents.

The arc welder shown in the photograph is so constructed that it generates at all times exactly the voltage required by the arc and at the same time gives a current which is practically constant. On this account no resistance is ever necessary in the circuit to cut down the voltage and therefore no power is wasted. This feature is due to special windings in the generator.

It is claimed that the method of control is much simplified by this elimination of resistances and any reasonably intelligent man can learn to operate the welder in one or two days' time. This is of great importance, because most welding machines are operated by men who are neither electricians or mechanics. Labor is a great factor in the cost of welding, and the welder should be so simple that it is not necessary to have a highly skilled man to do the work. Emergency service is frequently demanded in arc welding plants, and for that reason these arc welders are designed to stand long heavy duty, and to carry overload without damage to the machine.

Individual units are sometimes installed of two or more arc welders and one may be in use, the other idle for the time being, but is not consuming any current as would be the case if the installations were made up of one large welder. Where there is sufficient work to require more than one operator, a separate unit is installed for each man. The advantages of this plan are obvious. The user of the arc welding process can in this way do the work at the lowest cost and with the smallest initial investment.

It is held that by installing individual units, the money invested in welding equipment may always be kept proportional to the amount of work done. The arc welder operates at the lowest possible power cost, due to the fact that no resistance is necessary. In addition to this fact, the use of an individual plant for each operator makes it possible to operate each plant only when there is use for it, and then at maximum efficiency. Owing to the fact that no power is wasted in resistance banks by the wel-

der, the actual power required to do welding is small. This welder for ordinary service (with the exception of large steel casting work and heavy cutting) can be operated on any power line large enough to carry a 10 h. p. motor. This advantage permits the installation of the plant at almost any point in the shop where there is a power line or it may be made portable and connected where needed.

It is claimed that in large railway shops and other plants where the time allowed to do the work is limited and a shut-down of the welding plant holds up the rest of the organization, the installation of individual welders is the only insurance against great loss due to a total shut-down. Arc welders are flexible in their operation. Any number of the plants may be operated individually or in parallel. For instance, the operator can, without the service of an electrician connect three 150 ampere plants in parallel to get 450 amperes for heavy carbon electrode work. He can then individualize the plants again in a few minutes.

AN EMERY WHEEL SAFETY FIRST EYE GUARD.

(By Frank C. Perkins.)

The accompanying illustration shows an emery wheel safety first eye guard for the protection of the workmen of the Portland

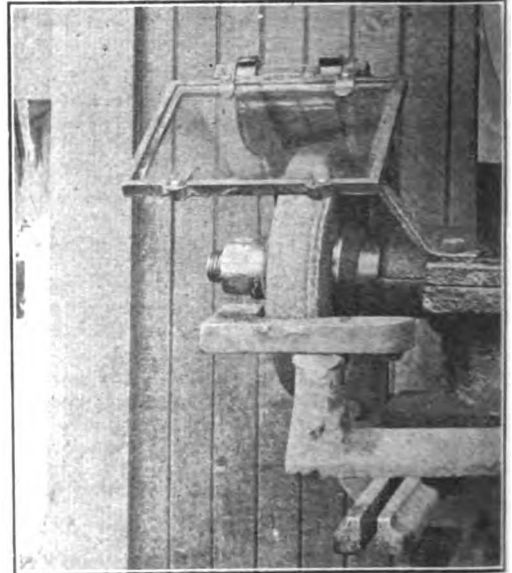

A GLASS EMERY WHEEL GUARD.

Railway, Light and Power Co., at Portland, Oregon.

This safety first device was designed for preventing particles of emery wheel from flying in the eyes of employes using wheel. For a number of years, employes were urged to wear glasses while using emery wheel, but they would not use them, and every once in a while someone would have an eye in-

jured and in some instances lose the eye, so the idea was advanced of putting the glasses on the emery wheel, and this has been a perfect solution of the problem. Every effort is being put forth to eliminate all forms of accidents.

A GIANT HYDRAULIC FORGING PRESS.

(By Frank C. Perkins.)

The accompanying illustration shows the construction of an enormous tool in operation at Montreal, Canada, and largely utilized in Canadian shops in the manufacture of

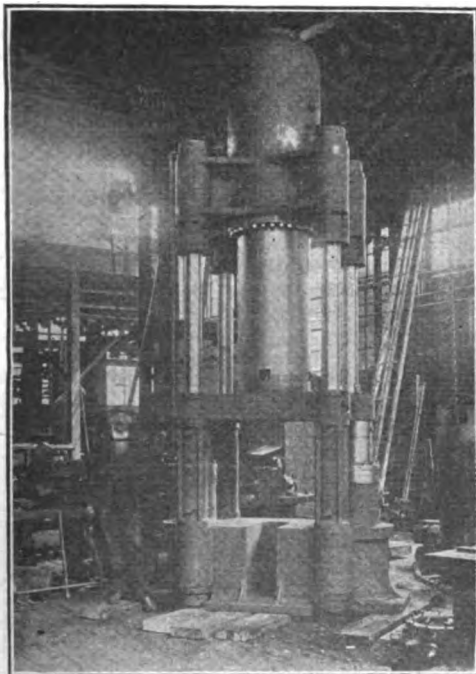

A GIANT HYDRAULIC PRESS.

munitions of war for the English and French armies. This 350 ton inverted hydraulic forging press is employed for piercing and drawing the 4.5 shells and is entirely of steel construction. Its great size is clearly indicated by comparison with the workman standing at the left of this giant hydraulic machine.

EFFECT OF MINIMUM-WAGE DETERMINATIONS IN OREGON.

In Bulletin 176 of the U. S. Bureau of Labor Statistics, just issued, is presented an interesting study of the effect of minimum-wage determinations in Oregon, as shown by a comparison of the records of 40 departments, dry goods, 5 and 10-cent, specialty and neighborhood stores for the two spring months, March and April, in 1913, and the same two months in 1914—periods ending five months before and beginning five months after the date on which the first minimum-wage determinations went into ef-

fect and at the same time nearly one month after the date on which the last retail store determinations took effect. These stores employed in the selected period before the determinations went into effect 1,930 women and girls and 974 men; and in the period after the determinations went into effect 1,642 women and girls and 902 men. All records were copied from store books by agents of the Bureau. In addition 443 women were personally visited, and a record was obtained, showing their age, experience, place of employment, occupation, rate of pay, earnings, and hours of work, before and after the minimum-wage determinations.

The first of the Oregon awards fixed a minimum of \$1.00 a day for girls under 18 and took effect October 4, 1913; the second taking effect November 23, 1913, fixed a minimum of \$9.25 a week for experienced adult women in Portland; and two taking effect February 7, 1914, fixed a minimum of \$8.25 a week for experienced adult women outside of Portland, and of \$6.00 a week for inexperienced adult women throughout the state.

Since the awards came into effect the rates of pay for women as a whole have increased, but the wages of three groups (girls under 18, adult inexperienced women, and adult experienced women), have been differently affected. Girls under 18 were benefited, the proportion receiving under \$6.00 a week decreasing from 26 per cent before the determinations to less than 1 per cent after the determinations; the proportion getting \$6.00 a week was 53 per cent before and 79 per cent after the determinations, while the proportion getting more than \$6.00 was practically the same both before and after. In the period before the determinations the average rate for the whole group under 18 was \$5.93 while afterwards it was \$6.24.

For adult inexperienced women the results were not so favorable. The average rate per week decreased slightly, falling from \$6.88 to \$6.84. Before the determinations 59 per cent and after the determinations only 50 per cent of this group received more than \$6.00. The old employees did not suffer a reduction of wages but the place of a \$28 or a \$30 a month girl was filled by a \$26 girl.

For adult experienced women the wage determinations brought an improvement of conditions. There was an increase not only in the proportion receiving \$9.25 a week (the legal minimum in Portland), but also in the proportion receiving more than \$9.25. The proportion of the force getting \$12 and over a week also increased, although the actual number decreased. The average weekly rate of pay for the whole group in Portland was \$11.74 before and \$11.97 after the determinations. Some experienced women in Portland were still receiving rates below the minimum to which determinations entitled them, but the number receiving these lower rates had decreased under the determinations from 344 to 102.

Thus the net result seems to be an advance for the women as a whole. There has been no leveling down of wages to a mini-

num. Some women upon reinstatement after an absence were compelled to accept only the rate to which they were legally entitled, although it was lower than they received during their earlier service, but whenever the wage rates of old employes have been changed since the minimum-wage rulings, the employes were benefited.

In studying the effect of the fixing of minimum-wage rates, it should be borne in mind that regardless of minimum-wage determinations there are constant changes in business organization from year to year which have a material bearing upon the opportunities and conditions of employment. In the period considered a general business

depression was felt by Portland mercantile establishments which complicated somewhat the problem of determining the effect of the minimum wage. The effect of this depression was to reduce the numbers employed, and this reduction affected men as well as women, though to a less degree, as the non-selling male force is not as adjustable as the non-selling female force. The wage determinations have not put men in positions vacated by women. All the changes arising from decreased business, reorganization of departments, and increased rates of pay resulted in an increase in the female labor cost and also in the total labor cost of 3 mills per dollar of sales.

DEPARTMENT OF COMMERCE.

Bureau of Foreign and Domestic Commerce, Washington—September Trade Analysis by Principal Articles.

November 10, 1915.

A new export level of \$300,000,000, reached for the first time in September, 1915, gives special interest to the statistics of foreign trade for that month, just published. To enable the Bureau of Foreign and Domestic Commerce, Department of Commerce, to comply with the numerous requests for advance information as to the articles making up that trade, the following condensation of tables shortly to appear in the "Summary of Foreign Commerce" for September has been prepared:

Articles and Classes Exported.	September		Nine Months Ending With September	
	1914	1915 (In millions of dollars)	1914	1915
Agricultural implements	0.7	1.1	20.6	10.4
Animals—Cattle1	.2	.5	2.4
Horses	1.0	8.0	3.1	75.0
Mules0	2.0	.4	18.8
Brass and manufactures4	5.2	4.9	31.8
Breadstuffs	46.4	39.6	172.8	423.4
Carriages—Automobiles	1.2	10.7	22.7	85.6
Carriages—All other6	2.1	9.5	18.9
Chemicals, drugs, etc.	2.4	8.4	20.2	54.2
Copper and manufactures	5.8	9.6	95.6	83.9
Cotton, raw	5.8	28.5	242.2	307.3
Cotton, manufactured	3.7	8.6	34.1	71.1
Electrical machinery, etc.	1.5	2.3	15.2	17.2
Explosives7	18.4	4.9	84.3
Fiber manufactures5	1.6	8.2	13.2
Fish and fish products8	1.4	6.6	10.7
Fruits and nuts	3.0	3.8	16.2	23.1
Rubber goods9	2.6	8.6	15.5
Iron and steel mfrs.	12.5	38.4	152.8	251.1
Leather boots and shoes	1.3	5.5	12.4	29.8
Leather manufacturers, other	2.3	9.4	26.7	94.6
Meats	10.8	18.5	97.7	194.8
Dairy products4	1.2	2.5	15.7
Naval stores6	.9	12.2	9.3
Oilcake and oilcake meal9	3.2	11.8	23.0
Oils, mineral	13.0	12.4	108.2	106.2
Oils, vegetable8	1.9	11.2	23.8
Paints, colors and varnish6	.8	5.3	6.6
Paper and manufacturers of	1.9	2.1	15.2	15.9
Photographic goods3	.9	6.5	8.6
Sugar, refined	3.2	3.6	5.8	24.8
Tobacco manufacturers8	.7	5.4	4.9
Tobacco, raw	3.7	6.0	32.5	39.0
Wood, lumber and other manufacturers	4.0	5.3	65.3	40.3
Wool manufacturers4	2.5	3.5	25.2
Zinc manufacturers	2.5	3.3	3.2	21.5
Total, including articles not enumerated..	156.1	300.7	1,467.4	2,532.5

Increased arrivals of raw materials and diminished purchases of manufactures are the leading facts disclosed by an examination of the import statistics for September, 1915. The following table, prepared by the Bureau of Foreign and Domestic Commerce shows the principal articles and groups of articles imported during September and the nine months ending with September, compared with corresponding periods of earlier years:

Articles and Classes Imported.	September		Nine Months	
	1914	1915	Ending With September 1914	1915
	(In millions of dollars)			
Animals, chiefly cattle	2.1	2.6	17.3	13.3
Art works	2.3	1.5	14.2	9.6
Breadstuffs.	1.6	2.1	25.5	14.1
Chemicals, drugs, etc.	5.0	8.1	61.9	65.2
Cocoa, crude	1.2	2.2	15.5	23.4
Coffee.	6.7	9.5	78.0	79.3
Copper in ore.....	.8	1.6	9.5	10.3
Copper manufactures8	4.5	23.7	22.0
Cotton, raw	1.1	1.6	19.2	19.9
Cotton, manufactured	4.1	3.2	48.8	30.6
Earthen, stone and chinaware.....	.6	.5	7.0	5.0
Fertilizers.	1.0	.3	18.7	7.1
Fibers, unmanufactured	3.0	4.6	39.3	35.2
Fibers, manufactured	6.3	5.1	60.5	46.2
Fish.	2.1	1.7	12.5	11.1
Fruits and nuts.....	2.5	2.4	35.5	27.6
Furs and manufactures of.....	.9	1.3	8.6	8.5
Hats and hat materials.....	.7	.8	7.5	7.2
Hides and skins.....	6.7	11.5	98.5	90.4
India rubber and substitutes.....	7.2	10.3	57.8	83.4
Iron and steel manufactures.....	2.2	1.4	22.9	14.8
Leather and manufactures of.....	1.9	1.2	18.9	11.4
Meat and dairy products.....	3.5	1.8	39.7	22.1
Oils, mineral.9	1.1	9.0	7.9
Oils, vegetable	2.0	2.2	21.6	18.2
Paper for printing	1.1	1.2	9.2	10.2
Paper and manufacturers of, other.....	.8	.7	11.5	7.4
Precious stones (diamonds, etc.).....	.6	2.4	17.8	14.7
Seeds.	2.1	2.2	15.9	19.2
Silk, raw.	9.5	8.9	72.9	61.6
Silk, manufactured.	2.4	2.2	23.8	18.1
Spices.3	.3	4.3	5.0
Spirits, wines and liquors.....	1.2	.7	12.6	8.5
Sugar.	18.3	12.4	112.0	157.4
Tea.	2.6	3.3	12.9	14.6
Tobacco, unmanufactured	3.7	1.3	27.3	16.1
Tobacco, manufactured3	.3	3.2	3.0
Toys.5	.3	5.2	2.7
Wood and manufactures of.....	5.6	6.0	46.7	43.3
Wool, unmanufactured	3.2	4.7	53.8	68.0
Wool manufactures	3.1	1.1	36.4	13.6
Total imports, including articles not enumerated.	139.7	151.2	1,410.1	1,302.1

FAULTY INSPECTION.

The Journal has for years contended that the United States Steamboat Inspection Service could not be depended upon to give a square deal to the public. To repeat that accusation at this time would seem a waste of effort. Numerous investigations upon the latest slaughter of the innocents are now proceeding. Let us hope that the present investigation will prove different from similar affairs in the past. Let us also hope that Secretary Redfield of the Department of Commerce will begin looking about for competent and qualified successors to at least two of his unfaithful, time-serving be-

reau chiefs. Public interest has long demanded such a change. Unfortunately, the public has been aroused to its own interest only because of the notorious, self-evident inefficiency of our Inspection Service as witnessed in the "Eastland" tragedy. But the public should be made to understand that, to bring about this desirable change, a great deal more is required than a mere fleeting protest or a gasp of indignation. This is not intended as a reflection upon the Secretary of Commerce, but rather upon the system which has made possible a retention of such men for so many, many years. —The Coast Seamen's Journal.

Smiles.

A COOL STAND.

Apropos of a railroad wreck due to a defective bridge, Jerome S. McWade, the Duluth sociologist, said the other day:

"The railroad's cool stand about this bridge reminds me of a worse case—a case about a toll bridge in the South.

"The toll bridge was rotten, and a woman fell through a hole in it, and was drowned. Her indignant townspeople held a mass meeting, and in response to their resolution of protest the company wrote:

"Gentlemen: Your resolution about our bridge has been duly received. It will be laid before the board at our annual meeting, eleven months hence. In the meanwhile, to prevent, if possible, a recurrence of the small accident to which said resolution refers, would it not be better if all your citizens used the company's other bridge, three miles to the north of town? The water there is scarcely deep enough to drown a man of full height.'"—New York Tribune.

A MUCH MIXED RELATIONSHIP.

Last leap year I did not want to embarrass my best girl to make her propose to me, so I asked her to be my wife, and she said, "I would rather be excused," and I, like an idiot, excused her. But I got even with the girl. I married her mother. Then my father married the girl. Now I don't know who I am.

When I married the girl's mother the girl became my daughter, and when my father married my daughter he is my son. When my father married my daughter she was my mother. If my father is my son and my daughter is my mother, who in thunder am I? My mother's mother (which is my wife) must be my grandmother, and I being my grandmother's husband, I am my own grandfather.—National Monthly.

A HERO'S CHOICE.

The bugle sounded. Into the barrack square marched the regiment, then formed a hollow square, and waited.

For it was an important occasion. Patrick Dolan, a scarred and sunburnt warrior, was

to receive some little token of his country's gratitude. A particularly notable act of bravery had brought Patrick into the limelight.

"Men," said the officer commanding, "I am proud to pin this medal on the breast of Patrick Dolan—a Briton and a hero! And, under the special order, I shall also place a \$20 bill to his credit in the bank, as some little reward for his gallant conduct."

Patrick stepped forward, and, as heroes do, looked uncomfortable. Still, there was one request he wanted to make.

"If—if it's all the same to you, sorr," he blurted out, "I'd rather ye'd pin the \$20 note on me chist, and place the medal to me credit at the bank, sorr!"—Answers, London.

BUMP, BUMP, BUMP!

A South Dakota railroad is noted for its excreable roadbed. A new brakeman was making his first run over the road at night and was standing in the center of the car, grimly clutching the seats to keep erect.

Suddenly the train struck a smooth piece of track and slid along without a sound. Seizing his lantern, the brakeman ran for the door.

"Jump for your lives!" he shouted. "She's off the track."—Ex.

NOT HEADED THAT WAY.

A good many years ago a steamer was sailing down the river, with a shrewd old Yankee captain in command. Suddenly the engines stopped, and there was nothing doing for several minutes. The passengers began to talk it over among themselves, and one of them, a portly, persistent sort of person, advanced pompously to the captain.

"What seems to be the trouble, cap?" he inquired. "Why have we stopped?"

"To much fog," answered the skipper curtly. "We can't see up the river."

"But I can see the stars overhead quite plainly," argued the persistent party.

"Mebbe ye can," admitted the captain, grimly, "but unless the bilers bust we ain't goin' that way."—National Monthly.

Poetical Selections.

FORGET IT.

Forget the slander you have heard,
Forget the hasty, unkind word;
Forget the quarrel and the cause,
Forget the whole affair, because
Forgetting is the only way.
Forget the storm of yesterday,
Forget the chap whose sour face
Forgets to smile in any place;
Forget the trials you have had,
Forget the weather if it's bad,

Forget the knocker, he's a freak,
Forget him seven days a week.
Forget you're not a millionaire,
Forget the gray streaks in your hair;
Forget the home team lost the game,
Forget the pitcher was to blame.
Forget the coffee when it's cold,
Forget to kick; forget to scold,
Forget the plumber's awful charge,
Forget the iceman's bill is large,
Forget the coal man's awful ("weights")

Forget the heat in summer days.
 Forget wherever you may roam,
 Forget the duck who wrote this poem;
 Forget that he in social bliss,
 Forgot himself when he wrote this.
 Forget to ever get the blues,
 But don't forget to pay your dues.

—Exchange.

NOT AFRAID OF PA.

Us boys ain't scared o' pa so much;
 He only makes a noise,
 An' says he never did see such
 Onmanageable boys.
 But when ma loks around I see
 Just somethin' long an' flat,
 An' always make a point to be
 Some better after that.

Pa promises an' promises,
 But never does a thing;
 But what ma says she does she does;
 An' when I go an' bring
 Her slipper or her hairbrush when
 She says she'll dust my pants,
 I think I would be better then
 If I had one more chance.

Pa always says nex' time 'at he
 Will have a word to say,
 But ma she is more apt to be
 A-doin' it right away;
 Pa turns around at us an' glares
 As fierce as he can look,
 But when we're out of sight, upstairs,
 He goes back to his book.

Ma doesn't glare as much as pa
 Or make as big a fuss,
 But what she says is law is law,
 And when she speaks to us
 She's lookin' carelessly around
 F'r somethin' long and flat,
 And when we notice it, we're bound
 To be good after that.

So we ain't scared o' pa at all,
 Although he thinks we are;
 But when we hear ma come and call,
 No difference how far
 We are away we answer quick,
 An' tell her where we're at,
 When she stoops down and starts to pick
 Up somethin' long and flat.

—James W. Foley.

In Memoriam

MEMBERS.

Mr. Philip Doyle, Reg. No. 61626, age 24, of Lodge No. 483, Alton, Ill., was born at Grafton, Ill., 11th of May, 1891, died Sept. 27th, from burns caused by lamp explosion. Single. Member for eight years.

Wm. C. Suakenburg, Reg. No. 99212, age 31, of Lodge No. 37, New Orleans, La., was born in New Orleans, 1884, died 1 A. M. Oct. 20, 1915, from poison. Single. Member two years.

Joe Roberts, Reg. No. 80330, age 23 of Lodge No. 74, Houston, Tex., was born in

Houston, Tex. Died Oct. 20, 1915, from Typhoid Fever. Single. Member for four years and ten months.

RELATIVES OF MEMBERS.

Mrs. Pauline Munsch Laine, age 65 years was mother of Bro. Geo. Munsch of Lodge No. 37. Was born in Germany, March 25, 1850, died Oct. 26, 1915, from complication.

Y. Grimland, age 83, father of Bro. Bob Grimland of Lodge No. 74. Was born in Norway, March 11, 1833. Died Oct. 4, 1915, from old age.

Lodge Notices

Elmore—Young.

Would like to know the whereabouts of Brother Bert Elmore, as his old side partner would like to hear from him.

B. A. YOUNG,
 1618 Caperton St.,
 Shreveport, La.

Siegler—Dundon.

Anyone knowing the whereabouts of E. R. Seigler will confer a favor by notifying the undersigned or having the brother communicate with me.

J. D. DUNDON,
 529 Second St.,
 Pittsburgh, Pa.

Chollar—Lodge 576.

Any secretary taking up the card of Broth-

er R. F. Chollar, Reg. No. 48759, will please hold same and correspond with the secretary of Lodge 576, Wichita Falls, Texas., as this brother left here owing a bill.

R. A. CAMPBELL, C. S., L. 576.

Parkinson—More.

Will A. K. Parkinson please communicate with J. W. More, U. S. S. Macheis, care New York postmaster?

Grimes—Lodge 312.

Anyone knowing the whereabouts of Brother E. A. Grimes, Reg. No. 96087, boiler maker, will please notify the secretary of Lodge 312, as this brother left here owing several bills.

W. P. FAWCETT, S. 312.

McGovern—His Brother.

Anyone knowing the whereabouts of Broth-

er Peter McGovern will please notify the undersigned, as there is business of importance to transact.

T. B. MCGOVERN,
2716 Franklin St.,
Omaha, Neb.

Lower—Postmaster.

Brother F. A. Lower, Reg. No. 81123, communicate with the postmaster at Parsons, Kansas. He wishes to get in touch with you.

E. P. BUTLER, S. L. 292.

LIST OF MEMBERS PREVIOUSLY ADVERTISED

Thompson—Lodge No. 587.

F. W. Thompson, Reg. No. 20987, has been suspended by this local for non-payment of dues. He also owes about \$40 here.

T. C. MADDY,
June Journal. Secretary Lodge No. 587.

C. S. Burk—Lodge No. 82.

Any secretary taking up card of Brother C. S. Burk, Reg. No. 102470, will please hold same and correspond with secretary of Lodge No. 82, as this brother misrepresented facts to secure transportation to Kansas City, amounting to \$1.25, and we had to pay this bill out of the treasury of the local.

A. G. EVERETT,
June Journal. Secretary Lodge No. 82.

Robert Canton—Lodge No. 384.

Anyone knowing the whereabouts of Robert Canton, boiler maker's helper, will please notify the secretary of Lodge No. 384, as this brother left this lodge without paying his bills that the lodge went good for.

A. W. JOHNSON,
July Journal. Secretary Lodge No. 384.

Douglas et al.—Lodge No. 587.

Lodge No. 587 has suspended M. E. Douglas, Reg. No. 100307, for non-payment of dues. We have also bills aggregating to \$80 against this brother. T. C. MADDY, Secretary and Treasurer Lodge No. 587.
July Journal.

D. J. Fitzgibbons et al.—Lodge No. 99.

Any secretary taking up the card of D. J. Fitzgibbons, Reg. No. 67599, or F. G. Hayes, Reg. No. 21882, will please correspond with the secretary of Lodge No. 99, Newark, Ohio, as these brothers borrowed money from this local which they forgot to return.

CECIL C. ROBERTS,
July Journal. Secretary Lodge No. 99.

Cooper et al.—Lodge No. 491.

And secretary taking up the books or cards of any of the following brothers will please hold same and notify the secretary of Lodge No. 491, as they left town owing the amounts placed after their names. C. E. Cooper, Reg. No. 41907, \$12.35; A. J.

Conley, Reg. No. 39115, \$3.95; John Crawford, Reg. No. 62321, \$34.70; W. J. Mills, Reg. No. 98504, \$6.40; John Peters, Reg. No. 80223, \$5.50.

Fraternally,
J. C. CARROLL, S. L. 491.
June Journal.

C. J. Dowd—Lodge No. 199.

Anybody knowing the whereabouts of C. J. Dowd, Reg. No. 96128, helper, left Lodge No. 199 without a card, and also owing a board bill of \$29 and other bills. Last stamp in his book issued by Lodge No. 113. Please notify the undersigned.

E. S. MCGINNIS, S. L. 199.
August Journal.

C. E. Cooper—Lodge No. 528.

Any secretary taking up the card of Brother C. E. Cooper, Reg. No. 41907, will please hold same and correspond with the undersigned, as this brother left here in 1913 and left unpaid bills that Brother Ed Swanson stood good for and had to pay.

J. H. THOMAS, S. L. No. 528.
August Journal.

Seigler—Lodge No. 549.

Any secretary taking up the card of Brother E. R. Seigler, Reg. No. 68353, please hold same and correspond with secretary of Lodge No. 549, as this brother left here owing a bill of \$3.00, which a brother stood for.

PERRY COOPER, S. L. 549.
October Journal.

Ennis—Lodge No. 346.

Any secretary taking up the clearance card of J. J. Ennis, Reg. No. 24751, will please hold same and correspond with the secretary of Lodge No. 346, as this brother left here owing some bills he misrepresented.

GEO. W. SINGER, S. L. 346.
October Journal.

Hiehl—Lodge No. 588.

Any secretary taking up the card of Brother F. S. Hiehl, Reg. No. 43811, will please hold same and correspond with the secretary of Lodge No. 588, as this brother borrowed money. Last stamps and clearance card issued by Lodge No. 70.

JOHN McNANEY, S. L. 588.
October Journal.

LOST AND FOUND.

Lost Due Book—Hicks.

Brother W. F. Hicks, Reg. No. 82422, lost his due book while in Norfolk, Va.; anyone finding same please return it to the undersigned.

M. W. RATTIFF, C. F. S., L. 551.

Lost Due Book—Granberger.

Anyone finding the due book of John Granberger, Reg. No. 69358, paid up to August 31, 1915, issued out of Lodge 32, will confer a favor by returning same to the undersigned. WAITER E. DWYER, S. L. 32.

Index to Volume 27

A COMPILATION OF LABOR NEWS.

Page	Page	Page
<p>Would Defeat Sea Treaty. 46 President Gompers Talks in Southern City on Workers Hopes and Aims 46 State Equips Health Train. 47 Favors Old Age Pensions. 47 Would End Wire Monopoly 47 Defends Compensation Law 48 Steel Cars Favored. 48 Against "Surprise Tests" 48 O. K. Compensation Law. 48 Labor Editor Jailed. 48 Stir up Hornets Nest. 48 Poisons in Industry. 49 Applaud Wilson's Answer. 49 Honor a Veteran. 49 Free Labor Comes First. 50 Professional List Grows. 50 School Sanitation Urged. 50 Watch New Constitution. 50 Navy Yard Economy Praised. 50 Peonage Law Illegal. 50 Citizens Must be Aroused. 51 To Pay Union Rates. 51 Survey for Alaska Railroad Will Act Together. 51 State Declares Dividend. 51 Urge Boys to Join Union. 51 Block Armor Inquiry. 51 Collect Compensation. 51 War Budget Greatest Yet. 52 Complain of Discrimination 52 Extend Compensation Act. 52 To Test Woman's Law. 52 Wireless to Run Trains. 52 Congress Passes Immigra- tion Bill; Is Now Before President Wilson. 121 Hatters Case Discussed. 122 Favor Compensation Law. 122 Dangers on Great Lakes. 122 A Warlike Salon. 123 Holland Trade Unionists Tells Story of Belgium's Misery Because of War. 123 Coal Baron's Retract. 124 Miners Adopt New Plan. 124 Ask Unionists Aid. 124 State Has Safety Exhibit. 124 A Strike no Conspiracy. 124 Court Can't Define "Min- ing". 125 Will Urge Labor Laws. 125 Poetic Justice. 125 Against Convict Labor. 125 To Build Alaska Railroad. 125 More Co-operative Stores. 125 Hatters Lose Case in High- est Court. 125 Workers Robbed by Agents 126 Echo of Stockton Strike. 126 Offers Unemployed Plan. 126 Approve of Unions. 127 Service Not a Commodity. 127 Stock For Employes; U. S. to Take Phones. 127 Navy Yard Wages Not Cut. 127 Navy Yard Gets Award. 127 Sustaining Tubercular Poor 127 Report on Immigration. 128 Public Cup Abolished. 128 Safety-at Sea Pact Falls. 128 Start a Co-Op. Bakery. 128 Printers Start Paper. 128 Wages Reduced by Judge. 128 Public Officials "Too Busy". 128 Hatters Petition Congress for Relief. 203 Liability Law to Stand. 206 Holds Life Cheap. 206 Tuberculosis Decreases. 206 Would Raise Wages. 206 Vote For Suffrage. 207 Unionists State Position. 207 Protest Postoffice Cuts. 207</p>	<p>Low Wage Advocates Scored. 207 Are Applying Co-Op. The- ory. 207 Vote Investigation of Judge Dayton. 208 State Police Bill Certain. 208 "Phossy Jaw" Outlawed. 208 Accident Toll Greatest. 208 Wages-by-Law Disastrous. 292 Millions of Illiterates. 293 Roll Call Vote on Burnett Immigration Bill. 293 Discusses Restriction. 295 Protest Wage Rule of Judge. 295 Sustain Right to Picket. 295 Operators Evade Damages. 295 Refuse a Re-Hearing. 295 "Personal Safety" Urged. 296 Unionists Fight Reaction. 296 Would Nullify Labor Law. 296 Real Efficiency Favored. 296 Miners Kill 2,451 in Year. 296 "Sixty Hour" Law a Farce. 296 Oppose Qualification. 296 Favors State Compensa- tion. 297 Public Pays Transporta- tion. 297 Insist on Union Label. 297 Labor Law Cases Advanced. 297 Victims of Gunmen Sue. 297 Will Test Relief Fund. 297 Attempt to Adjust Strike. 297 Unions Give Greatest Aid. 369 Wages by Law and Law- yers. 370 The A. F. of L. Exhibit. 370 W. U. Employes "Spot- ters". 370 Evils of Convict Leases. 371 How "Spotters" Split Un- ions. 371 New Loan Shark Bill. 371 R. R. Officials Conscien- tious?. 372 Oppose 15 Cents an Hour. 372 Lawyers Paid \$294,113. 372 Dan Harris Has Passed Away. 372 Porters Must Live on Tips. 372 Railroads Are Not So Poor. 372 Bishop Pleads for Boy- hood. 373 Defeat Contract System. 373 Eight-Hour Day Upheld. 373 Setback for Labor Agent. 373 Holds Seaman's Act Is Ef- fective November 4. 373 How About Reputation. 373 Denies Right to Picket. 373 Secure Eleven New Laws. 373 Change Attack on Schools. 373 Grundy Is a Bitter Loser. 448 Miners Long Strike Ends. 448 Injunctions Wrong Labor. 449 R. R. Tried to Incite Riot. 449 Follows U. S. Supreme Court. 449 Protests Lawson's Trial. 449 "Spotters" Law Illegal. 450 Unionism Pays, Is World's Story. 450 Roads New Revenue High- er. 450 Lone Miner Defeats Com- pany. 450 Convict Labor to End. 450 Pass Prison Reform Bill. 450 To Urge Pension Theory. 450 Violate Labor Laws. 450 Do Unskilled Eat Less?. 450 German Mills Use Wind and Steam Power. 450 "Speeding Up" Systems. 518 Amend Compensation Act. 519</p>	<p>"Breaking Contracts Can't Crush Unions. 519 Injunction Refused, Un- ions Views Upheld. 520 Women Unionists Adjourn. 520 Lawson Case Is Discussed. 520 Win Injunction Suit - Strikers May Picket. 521 Women in Iron Industries. 521 Rockefeller Millions Taint Public Press. 521 To Annul Treaties Hit by Seaman's Law. 522 Illness a Tax on Workers. 522 Pension State Employes. 522 Oppose Dangerous Law. 522 Good Compensation Act. 523 Rockefeller Aide Protests. 523 Lauds A. F. of L. Exhibit. 523 Workers Advance Steadily. 523 Walking Lengthens Life. 523 Unions Should be Cau- tious. 524 Workers Pension Needed. 524 Porto Rican Protest Heard. 524 Private Detectives Scored. 524 Want Wage Law Enforced. 524 Compensation Not Limited. 524 Favors U. S. Owned Rail- roads. 524 Rockefeller Is Generous. 525 Amend Compensation Law. 525 Pensions For Laborers. 525 Regulate Private Agencies. 525 To Check Strikebreakers. 525 Adopt "State Use" System. 525 Violate Contract Labor Act. 525 To Investigate Official. 525 Vacation for "Laborers". 525 Labor Temple for Dallas. 525 Injunction Rule Is Kingly. 529 Coolie-Manned Ships Sold. 599 John R. Lawson Given Life Term. 600 Would Jail Rockefellers. 600 Miners Want Eight Hours. 600 Journeymen Tailors Union Resumes A. F. of L. Af- filiation. 601 Can't Collect "Damages". 601 Mother's Pension Urged. 601 Protecting Child Workers. 602 Gompers Compels Peace. 602 Says Picketing Is Legal. 602 Mexican Workers Strike. 602 Land for City Unemployed. 602 Labor Must Combat Law- son Precedent. 603 Clayton Law Reverses Principles of Decision in Danbury Hatters case. 603 "Average Wage" Is De- fined. 604 Enact Co-Operative Bill. 604 Regulating Child Labor. 604 State Text Books. 604 Canadian Workers to Con- fer. 604 One Kind of Economy. 604 Rail Fatalities Decrease. 605 Typhoid Takes 30,000 Year- ly. 605 Conciliators Named. 605 Many Disputes Adjusted. 605 Wage Boards Can't Meet. 605 Triumph for Arbitration. 689 Ohio Unionists Oppose Pri- vate Compensation. 689 Theory of Compensation. 690 Defend Seamen's Law Now. 690 Arbitration Is Urged. 690 Minimum Wage Law De- clared Invalid. 690 Records Broken in Steel. 691 Need Not Take Risk. 691 Have a Right to Picket. 691</p>

Page	Page	Page
Wants Miners Money.....691	Victorious Longshoremen.....788	Unionism the Key.....361
Otis Must Pay Damages...691	Preference to Unionists...788	Defends Tax on Rich....362
Why Safety Law Is Op- posed.....691	Railroads Vast Earnings...788	Union Policies Contrasted.362
"Theoretical" Wages.....692	Rockefeller Reduces Hours 788	Suspend Ship Inspectors.362
Accident Board Ruling...692	Testing Disputes Act....789	Death on the Rail.....362
Show Increased Earnings.692	Uncle Sam's Free Land...789	Judge Supports Unionists.362
Unionists to Confer.....692	To Distribute Eastland Fund.....789	To Vote on Compensation.362
Lawson Verdict Appealed.692	Want Right of Appeal...789	Southern Newspapers Fav- ors Trade Unions.....934
Loses in Times of Peace...692	Immense Ship Profits...789	Banks Warned Against Usury.....934
Lease System Opposed...692	Machinists' New Editor...789	Special Privilege Surprised.935
Labor Law Forces Change 692	Score Organized Charity...789	Reject Alleged M. O.....935
Metal Trades Thanked...692	Australian Unions Gain...790	Evils of Child Labor Shown.....935
Picketing Is Legal.....693	Unionism Most Effective.790	New Pacific Boat Line...935
Miners "Short Weighted".693	Merchant Marine Increases 790	Labor's Two Assets.....935
Large Fund for Education.693	Would Revise "Pen" Meth- ods.....860	Large Earning of U. S. Steel.....935
End Strike by Force Is Hinted in Canada...693	Must Pay for Police.....860	Exports Make Record...935
Trade Union Methods Win.693	Railroads Act Together...861	Record for Railroad Earn- ings.....936
A Stirring Appeal.....693	Explains Compensation Law.....861	Buys 175,000 Tons of Rails.936
A Wise Judge.....694	Lawson Released on Bail.861	Suspends Steam Boats Probe.....936
Hope of U. S. Is Educa- tion.....787	Medics Stand by Wage Scale.....861	Adopt Minimum Wage Law.....936
Locomotive Inspection Rules.....787	Far Western Unionists Meet.....861	
Altgeld's Memory Honored in Chicago.....787	Associated Press Denies.861	

ADVERTISEMENTS.

Actina Appliance Co., Jan., Feb. and March...Inside Back Cover	560, 640, 720, inside back cover of October and Nov.	Sweet-Orr Co., Inc., pages.....79-321
Aldrich Publishing Co., Inside Back Cover (The Boiler Maker) Jan., Feb., March, May, June, July, Aug., Sept.....309, 772, 880	Daniel, J. M., inside back cover May, June and July, and page.....68	The Boiler Maker.....959
American Arch Co., pages 1, 81, 161, 241, 321, 401, 481, 561, 641, 721, 801	Eckert, J. L., outside back cover, Sept. Oct. and Nov.	Champion Blower & Forage Co.....959
Boot and Shoe Workers' Union Label; Pages 80, 180, 240, 320, 400, 480, 560, 640, 720, Inside Back Cover, Oct. and Nov.	Faessler Mfg. Co., (J), In- side back cover, Jan., Feb. March, May, June, July, Aug. and Sept....309	G. & C. Merriam Co.....959
Commercial National Bank, (The), pages..... 80, 160, 240, 320, 400, 480,	Larned, Carter & Co. (Headlight Overalls) In- side the front cover, Jan., Feb., March, April, May, June, July, August, Sept., Oct. and November	Burlington Watch Co.....960
	G. & C. Merriam.....880	Boot and Shoe Workers' Label.....958
	Stifel & Son, J. L., pages. 2, 82, 162, 242, 322, 402, 482, 562, 642, 722, 802	The Commercial National Bank.....958
		Laying Out for Boiler Makers.....958
		Oxweld Railroad Service Co.....958
		American Arch Co.....881
		Stifels Indigo.....882
		The Railway Educational Bureau.....882

AGREEMENTS.

McCallum Machine Co.....32	New York, Ontario & Western R. R. and Ma- chinists, Boiler Makers, etc.....772	Hudson Co., and Em- ployees.....843
Agreement between the Savannah & Northwest- ern R. R. Co., and B. M., etc.....771	Federated agreement be- tween The Delaware &	Agreement Between Chi- cago Junction Ry. and the Brotherhood of Boil- er Makers.....919
Agreement between the		

AMONG OUR EXCHANGES.

Temperance, not Prohibi- tion, Is Developing the Highest Utilities in Man.52	Alien Labor and Public Work.....133	Freedoms Battle Won....375
The Sun and the Wind....53	The American Federation of Labor.....124	The Shoe Pinches.....375
Real Work to do.....53	Keep on Learning.....124	The Hygiene of Gas Light- ing.....376
Spies Discovered in Labor Council in an Ohio City.53	Substantial Progress.....124	Labor Should be Content.376
Replies to Naval Critics...54	Colorado Miners Strike Commission.....135	One of the Most Peculiar People in World.....376
Bad Teeth a Cause of Can- cer.....54	Community's Duty to the Poor.....208	Paying the Fiddler.....377
Boiler Makers' Banquet Proves a Success.....54	First Week of Boiler Mak- ers' Strike Ends With Very Few Important De- velopments Noted.....209	Paying the Price.....451
Why Should Light Come From Left Side?.....55	Government Lock Gates Being Built With Non- Union Labor.....210	Reactionary Legislation .451
The "Air Towel".....55	Employment Bureau Sharks.....210	A Good Fighter.....452
Learning to Know Each Other.....55	Timber for Small Articles.211	Peace Hath Her Victories.452
The Freight Rate Decision and Public Ownership...55	The Advantage of High Dues.....211	O, You Knocker, You Sore- head, Read This.....452
The Right of Petition Must Not Be Abridged.....56	Labor's Worst Enemies...297	One More Feather in the Plumage of the L. W. W.453
The Girl and the Young Man.....56	Watch Your Step.....298	John Bunny.....453
Spots Before the Eyes...57	What China Might Do If She Were Aroused.....298	A Source of Danger.....453
War.....129	How Do You Play?.....298	Pride and Sense.....454
Boiler Makers' Express Their Appreciation.....181	Unionism in Canada.....374	Smoker and Concert...525
For Peace, Justice and De- mocracy.....181	Real Light.....374	New Copper Alloy Discov- ered Here Leads to a Big Industry.....526
Occupational Eye Diseases.182	Capital and Labor Are Real Partners.....375	We Must Protect Our- selves.....526
Treating Men as Men.....183		The Voice That Reaches.526
		Power of Organized Labor.527
		Industrial and Other Un- rests.....527
		The Chairman of the Indus- trial Commission.....528

The Re-Awakening of Pennsylvania.....	528
Judge Lindsey's Triumph.....	528
Freight Car Rooms.....	529
Canadian Government to Open Road.....	529
New Union Is Formed, Cupid Grants Charter.....	529
Democratizing the Navy.....	529
Typhoid Fever in Chicago.....	529
First Time in History of Nation for Labor to be so Recognized.....	606
Flies and Sick Babies.....	606
Accomplishing Economy.....	606
More Official Arrogance.....	606
No Glory for the Defeated Hero.....	606
In Colorado.....	607
The Little Things.....	607
Public Sympathy as an As-	

set.....	607
Grievances.....	694
Evil Spirits at Work.....	694
Buttermilk and Bacteria.....	694
Found Them Out.....	695
The Mirror and the World.....	695
Signs of the Times.....	695
Sentenced Miner Charges Frame Up.....	696
Larkins Silly Prattle.....	696
Misleading Issues.....	790
Treachery Unmasked.....	791
Unions and Wages.....	791
The Saving Habit.....	791
Weariness.....	792
A Mare Island Indictment of the Speeding Up System.....	792
From "Resolution" to Injunction.....	862

Ship Building.....	863
The Love of Health.....	863
What Would They Do.....	864
The Ship-Purchase Bill.....	864
Railroad Finance.....	864
A Labor Protest to the Governor—Ohio State Journal.....	936
Ship Building in Japan—The Milwaukee Journal.....	936
Are We Failing?—The Milwaukee Journal.....	937
Why Has Co-Operation Been a Failure in America?—International Molders Journal.....	937
Startling If True—Coast Seaman's Journal.....	937
Faulty Inspection The Coast Seamen's Journal.....	945

CONTRIBUTED.

Speech of Hon. Frank P. Walsh, Chairman of U. S. Industrial Commission Before A. F. of L. Convention.....	3
Speech of Pres. Gompers in Reply to Addresses of Fraternal Delegates.....	5
Address of Hon. W. B. Wilson, Sec. of Dept. of Labor, Before the A. F. of L. Convention at Philadelphia.....	83
Address of Fraternal Delegate From the Canadian Trades and Labor Before the A. F. of L. Convention.....	85
The Voluntary Nature of the Labor Movement.....	90
To Prevent Unemployment.....	92
The Danger of Shifting Duties.....	168

To Fight Tuberculosis Among Workmen.....	164
Trade Unionism, Progress and Liberty.....	243
Australian Labor Regulating Schemes.....	323
A Spirit Helpful to Labor.....	403
Fixing Wages by Law or Unionism.....	405
A. F. of L. Rejoinder.....	406
Lawson a Convict—Rockefeller a Saint.....	483
Lawson's Trial, the Infamy of It.....	563
Sycophancy and Callousness.....	564
Labor Amendments Presented to the New York Constitutional Convention.....	565
The Deeper Unpreparedness.....	643

Chairman Walsh's Chicago Speech on the Lawson Trial.....	644
Report of the U. S. Commission on Industrial Relations.....	648
Synopsis of Report of United States Commission on Industrial Relations.....	722
Third Section of Report of Basil M. Manley, Director of Research and Investigation.....	808
Press Abstract of Report of the Colorado Strike.....	818
Extracts from the Report of the A. F. of L. Executive Council.....	883
The Rockefeller Industrial Representation Plan.....	893
Robbery and Oppression Legalized.....	895

CORRESPONDENCE.

Communication from Pres. Wharton of the Railway Dept.....	33
187, 271, 351, 355, 433, 509	
Jos. Koenig, Algiers, La.....	519
W. H. Sims & Comm., Sedalia, Mo.....	35
Wm. LeCompte, Newport News, Va.....	86, 117
Mrs. Wagner, Sedalia, Mo.....	36
Mrs. Jno. Cure, Teague, Texas.....	36, 39
Jas. A. Peacock.....	36
M. Pease, Tulsa, Okla.....	36
J. H. Noonan.....	38
E. B. Wolf & Comm., Vallejo, Cal.....	38
Jas. A. Flannery, Carbon-dale, Pa.....	38
L. A. Freeman, Ft. Worth, Tex.....	39, 120, 186, 288, 436, 512
R. Dale, Milwaukee, Wis.....	39, 197
Jack Hurley, Brainerd, Minn.....	39
I. J. Cundiff, Chicago, Ill.....	40, 44, 119
S. M. Rankin, Elizabeth, N. J.....	40
Wm. Carey, Tulsa, Okla.....	40
F. P. Reinemeyer, I. S. T.....	41
L. A. Riffenrath, C. S. L.....	41
Note by the Editor.....	42
D. B. McInnes, L. 585.....	42, 112, 196, 279, 359, 440, 513, 596, 679, 783
J. Du Bruccq, Milwaukee Wis.....	42
J. G. Brown, Brainerd, Minn.....	42, 273, 278, 360, 443
M. J. Donohue, Sedalia, Mo.....	43
Thos. J. Cavan, Wilkes Barre, Pa.....	44, 596, 846
J. A. Franklin, Int. Pres.....	44, 194, 197

Jno. S. Coghlan, Chicago, Ill.....	45, 785
Application for Pardon for Brother W. J. O'Brien.....	45
Edw. E. Ivey, Decatur, Ill.....	45, 113
Roy Drummond, Miami, Ariz.....	110
Correspondent, Champaign, Ill.....	111
Jno. M. Slater, Green Bay, Wis.....	111, 356
Chas. E. Cook, Miles City, Mont.....	112, 445
A. J. Dixon, Rocky Mt., N. C.....	113, 681
J. H. Shuman, Sanford, Fla.....	113
Robt. Henderson, Roslindale, Mass.....	114, 117, 190
Geo. Randall, Waycross, Ga.....	114
Michael Cleary, Chicago, Ill.....	114
Wm. S. Frohlinger, C. S. L.....	114
D. L. O'Brien, Ludlow, Ky.....	115, 189, 282
L. E. Whitehead, Nevada, Mo.....	115
A. Thompson, Lima, Ohio.....	115
G. Spratley, Beaumont, Tex.....	115
Wm. J. Irwin, Danville, Ill.....	116, 282, 368, 513, 595, 598
Chas. A. Leahy, Chicago, Ill.....	116
C. R. Kizer, Silvis, Ill.....	116, 189
Jack Gribben, Chattanooga, Tenn.....	116
Correspondent from Danville, Ill.....	117
T. F. Richards, Newport News, Va.....	117
W. H. Keenan, Balboa, C. Z.....	117

Correspondence from Norwood, Mass.....	778
W. A. Saunders, Mechanicsville, N. Y.....	119
Frank Bann & Comm., Pittsburgh, Pa.....	121
Frank Comerford, Chicago, Ill.....	182
W. A. King, St. Joseph, Mo.....	184
Wm. J. McGee, Cincinnati, Ohio.....	185, 277
Mr. and Mrs. C. T. Burke.....	185
Jno. V. Richardson, Mo. Valley, Ia.....	186
Chas. MacGowan, Silvis, Ill.....	187
T. O. Riley, Pt. Arthur, Tex.....	188
District Lodge 15.....	189
W. H. Healy, Newport News, Va.....	189, 678
L. J. Flohr, Waycross, Ga.....	189
A. G. Smith, Chicago, Ill.....	190, 192, 446
Robt. T. Howe, L. 298.....	190
Chas. J. Younger, Decatur, Ill.....	190, 358, 779
J. Bowman, Newark, O.....	190
M. W. Lake, Washington, Ind.....	191
E. J. Buekler, Miami, Ariz.....	191
E. Richardson, Toledo, O.....	192
A. B. Page, C. S. L.....	193
Eugene Brennan, L. 249.....	195
Frank Snare, S. L. 451.....	197
Peter Shtipon & Comm., Brooklyn, N. Y.....	199
Geo. F. Chadburn, Winnipeg, Man.....	201
A Note from the Editor.....	201
Comm. from A. F. of L.....	216
John O'Toole, Sec'y Australian Boilermakers Union.....	267, 268
C. J. Maes, L. 128.....	202, 281, 366

Page	Page	Page
Walter Carrigan, Cushing, Ok.	Richard Leahy, Tulsa, Ok.	Wm. H. Dreyer, Spencer, N. C.
273	445, 678	683, 779
T. H. Flynn, Pittsburgh, Pa.	W. H. Lane, Honolulu, I.	E. P. Edmonson, Elkins, W. Va.
273	445	683
J. P. Ryan, 8th I. V. P.	J. J. Bower, Princeton, W. Va.	Walter Schultz, Chicago, Ill.
275, 363, 364	446	683
Correspondent, Pittsburgh, Pa.	F. C. McDowell, L. 551.	Geo. Amberger, Chicago, Ill.
276	446	684
Geo. Gauss, Denver, Colo.	W. O. Hollis, Wichita Falls, Tex.	Robt. T. Howe, Portsmouth, Va.
277	446	684, 786
Jas. J. Carroll, Valley Jct., Ia.	Edw. Osborn, Chicago, Ill.	H. K. Larkins, Fairbury, Neb.
278	447	684
S. E. Harris, Denison, Tex.	Wm. Martin, Peoria, Ill.	Bud Nash, Seattle, Wash.
282	447	685
F. Jargens, Danville, Ill.	F. M. Purser, Big Springs, Tex.	J. E. Dixon, Cushing, Ok.
282	447	686
F. G. Maybury, Elkins, W. Va.	Correspondent, L. 311.	A Friend, Ft. Worth, Tex.
282	447	686
L. Kevie, San Francisco, Cal.	W. F. Dupen, Bluefield, W. Va.	A Word About Government Inspection.
282	447	686
Jno. Mulligan, Preston, Id.	J. J. Caddagan, Moberly, Mo.	Geo. S. Warden, Pueblo, Colo.
283	448	687, 777
R. L. King, Pres. L. 170.	J. M. Craig, Ft. Worth, Tex.	A. J. Haur, Clifton Forge, Va.
283	511	688
A. Hinsman, 1st I. V. P.	Thos. Nolan, 2nd I. V. P.	Geo. O'Brien, Vinita, Ok.
283	513, 515, 516	774
R. A. Lines, Springfield, Mo.	J. H. Thomas, Deer Lodge, Mont.	B. Z. Millikan, Fairbury, Neb.
287	513	775, 779
A. F. Bingham, Springfield, Mo.	David McArthur, C. S. L. 55.	C. P. Hosies, Deer Lodge, Mont.
289, 591, 774	513, 785, 786	775
Wm. Kelby, Chicago, Ill.	Jno. Burke, Chicago, Ill.	A. D. Ross, Shawnee, Ok.
292	513	776, 780
Jas. Rose, East St. Louis, Ill.	R. D. Hoot, Birmingham, Ala.	Thos. J. Sheridan, L. 25.
292	513	777
E. M. Daywalt, Richmond, Va.	G. Spratley, Pittsburg, Kas.	Nelson M. Warren, Grand Rapids, Mich.
292	513	778
C. F. Gillenwater, C. S. L. 180.	S. V. Acosta, Baton Rouge, La.	J. J. Freibott, C. S. L. 507.
292	513, 680	778
J. P. Merrigan, Montreal, Que.	Ed Worthamith, Argenta, Ark.	J. J. Cunningham, Lowell, Mass.
274	515	781
S. T. Sample, Pratt Kas.	C. W. Creamer, Holsington, Kas.	Jno. O'Toole, New Castle, Australia.
353	515	782, 783
Geo. J. Thomas, Portsmouth, Va.	E. S. Ryan, Jacksonville, Fla.	Henry Seikman, L. 27.
354	516	783
Frank Roberts, S. L. 413.	O. C. Garvey & Comm.	Jas. Withmore, East St. Louis, Ill.
354-779	516	783
A. W. Rickett, Tacoma, Wash.	John Lee Martin, Jackson, Ohio.	Secretary L. 103.
354	516	784
A. W. Witz, Casper, Wyo.	W. E. Dwyer, K. C., Mo.	Jos. Ernst, Danville, Ill.
354	516, 688	784
W. L. Young, Huntington, W. Va.	Ralph Hastings, Brainerd, Minn.	David McArthur, Newport News, Va.
355	517, 786	785
Jno. Cullen, Elmwood Pl., Ohio.	Jos. Arnold, Albany, N. Y.	S. E. Garriss, Denison, Tex.
355	517, 617	786
Jno. Ernst, Buffalo, N. Y.	Frank L. Bongen, Lafayette, Ind.	C. Dixon, Tulsa, Okla.
357	517	786
Harry L. Gunn, Lima, O.	Leo. Gayen, Miami, Ariz.	Thos. J. Sheridan, L. 25.
357	518	845, 896
Dan N. Generson, B. A. L. 585.	Jno. L. Callahan, Milwaukee, Wis.	Executive Councils' Action.
358	517, 782	845, 896
W. T. Pentecost, Nashville, Tenn.	E. J. Buehler, Los Angeles, Cal.	Thos. J. Cavan, L. 547.
358	517	846
W. P. Kilroy, Washington, D. C.	Thos. J. Lillis, Jersey City, N. J.	S. M. Rankin, L. 176.
359	518	846
R. C. McCutchan, Winnipeg, Man.	Timothy Donohue, Lowell, Mass.	H. E. Phelps, L. 57.
361	518	846
Theo. W. Evert, Livingston, Mont.	E. T. Brennan, Huntington, W. Va.	E. W. McMichael, Columbus, Ga.
365, 682	519	846
J. J. Lawler, Cushing, Ok.	R. W. Smith, Local 473.	Peder M. Pederson, Kelley Lake, Minn.
365	519	848
R. H. VanHoose, Paraiso, C. Z.	Tom Hall, A. F. of L. Organizer.	T. H. Cardwell, Big Spgs., Tex.
366	519	848
C. S. L. 471.	C. S. Davis, Gassaway, W. Va.	Navy Yard Mechanic.
368	519	848
Metal Trades Dept.	Geo. P. Smith, F. S. L. 450.	Thos. J. Newcomb, Carbon- dale, Pa.
368, 435	519	848
J. F. Murray, Roanoke, Va.	Dan P. McKillop, L. 104.	Robt. T. Howe, Port- smouth, Va.
369	519	849
S. F. Sloan, Wichita, Kas.	A. W. Rickett, S. L. 568.	N. Heglund, Bay City, Mich.
369	519	849
Wm. H. Cassman, Lafayette, Ind.	R. S. Hopkins, L. 19.	J. P. Taylor, Raleigh, N. C.
369	519	849
T. C. Maddy, L. 587; 869, 439, 677.	Building Trades Council.	Ray Freeman, Casper, Wyo.
369	519	850
Mrs. Mary Anna Ryan, Oswego, N. Y.	C. A. McDonald.	Edw. O'Brien, Memphis, Tenn.
202	519	850
J. F. Wrightman, Pawhuska, Ok.	W. O. Wilburn, Wichita, Kas.	Robt. S. Hopkins, L. 19.
202	519	851
Irwin Shipman, Sapulpa, Ok.	Frank Stover, K. C., K.	W. L. Harkins, L. 323.
272	519, 778	851
C. M. Blair, Long Pine, Neb.	E. H. Friend, Grand Jct., Colo.	E. C. Poore, Memphis, Tenn.
486	519	851
J. M. Devlin, Wichita, Kas.	Geo. W. Pring, Des Moines, Ia.	A. A. Williams, L. 551.
437, 513	519	852
From A. F. of L.	J. J. Evans, Pueblo, Colo.	Geo. Parkes, Boston, Mass.
437	519	852
Edw. Freeman, Albany, N. Y.	S. E. Harris, Denison, Tex.	H. E. Phelps, Portsmouth, Va.
438	519	853
Geo. Bennett, Richmond, Cal.	J. N. Shirley, Holsington, Kas.	W. A. Rooksberry, L. 69.
439	519	853
B. S. R. Harrison, C. F. S. L. 103.	C. S. Wheeler, Holsington, Kas.	Chas. J. Younger, L. 447.
440	519	854
Thos. J. Farley, Tomahawk, Wis.	Jas. Callahan, St. Louis, Mo.	H. Halter, Clifton, Ariz.
441	519	854
H. E. Phelps, Porthmouth, Va.	Jos. Galloway, Knoxville, Tenn.	Harry Shannon, Osawat- mie, Kas.
441, 590	519	856
J. Berryman, Concord, N. H.	Christ Smith, Middletown, N. Y.	David Lewis, Newcastle, Pa.
442	519	856
A. L. Waint, Washington, D. C.	Lodge 123.	Jas. L. Callahan, St. Louis, Mo.
442	519	857
Geo. W. Goethals, Govern- nor.	S. P. Critzer, Richmond, Va.	T. J. Cavan, Wilkes Barre, Pa.
442	519, 682	858
	C. F. Kenny, Algiers, La.	Dan P. McKillop, L. 104.
	682	859
		E. Wortsmith, Argenta, Ark.
		859
		A Criticism of Naval Con- struction.
		920

E. S. Ryan, Secretary-Treasurer Dis. L. 28....	922
Lodge 427, Salida, Colo....	423
Lodge 417, North Bay, Ont.	428-931
A. Stewart, Lodge 191....	924
Rocky Mt., N. C., Boiler Maker.	925
Lodge 476, Dalhart, Tex....	925
F. S. Kidneigh, Denver, Colo.	925
Lodge 863, East St. Louis, Ill.	925-929

Lodge 11, Minneapolis, Minn.	926-929-932-934
Lodge 220, Chicago, Ill....	926
Lodge 3, St. Paul, Minn....	926
Jack Cummings, LaFayette, Ind.	927
Robt. S. Hopkins, Lodge 19.	927-931
E. T. Chester, Lodge 132.	928
S. E. Harris, Denison, Tex.	929
Lodge 483, Alton, Ill.	929
Jas. J. Berryman, Concord, N. H.	930

Dan B. McInnes, East Boston, Mass.	930
Emma Anderson, Philadelphia, Pa.	931
H. E. Phelps, L. 57.	931
Jas. Callahan and Comm., St. Louis, Mo.	932
Lodge 69, Little Rock, Ark.	932
Lodge 576, Wichita Falls, Tex.	932
W. L. Forrest, Madison, Wis.	933
Lodge 578, Hagerstown, Md.	934

EDITORIAL

New Years Greeting.....	7
Votes to Continue Harrison & I. C. Strikes.....	7
The European War Shows the Need for Government Ownership of Wires.....	8
The Colorado Mine Workers Strike Declared off..	8
Still Trying to Boost Our Military Establishment..	9
Navy Yards Make Good Showing.	11
The A. F. of L. to Own a Headquarters Building..	11
A Federal Judge Orders Agreement Restored	12
Commission on Industrial Relations Submits Preliminary Report	18
Railroads Get Increase in Freight Rates	18
Death of Former Int. Secretary Treasurer Gilthorpe.	93
A Lockout in the Oil Fields of Oklahoma	93
Amendment to Locomotive Boiler Inspection Law Passes House	95
Kansas Boiler Makers Hold a Conference	95
Trying to Knock Out Women's Minimum Wage Law.	96
Industrial Commission to Investigate Rockefeller Foundations.	96
Too Many Lawyers in Congress Says One	97
U. S. Supreme Court Awards Damages to Hat Manufacturers.	97
Standard Time Humbug Shows Up Again	98
Mr. Ford of Profit-Sharing Fame Denounces Millionaire Philanthropists	99
Secretaries Should Send in Deposited Clearance Cards Promptly	100
M. O. & G. Strike Declared Off.	101
Death of First International Vice-President Hinzman's Mother	101
Personal Mention	101
The Correction of an Error.	102
More Financial Benefits Needed.	165
A Large and Successful Engineering Feat Completed.	166
An Unwarranted Decision.	166
A Congressman Charges Government Waste in Buying Armor	167
Southern Pacific Must Sell Ships.	167
The United States Should Be Prepared	167
We Should Do More Than Establish Employment Bureaus.	168
Railroads Still Take Heavy Toll in Killed and Wounded.	169

Congress Seeking to Prevent Child Labor.....	169
Fluctuations in Employment the Problem of Today.	170
The Strike in the Oil Fields.	170
A Talk With Our Members.	171
Panama-Pacific International Exposition Opens.	245
Fake Employment Agencies.	246
Federal Industrial Commission to Investigate Strikers.	246
Newport News Strike Settled.	247
The Federal Locomotive Boiler Inspection Law Amended.	247
Express Companies Still Losing Business and Profits.	248
The Taylor System Fad on the Wane	249
State Laws Cannot Prevent Shipment of Beer.	250
President Wilson Says the World Could Dispense With "High Society" and Not Miss It.	251
A Talk With Our Secretaries.	251
Death of Brother A. E. Strode's Father	252
A New Illustrated Catalog.	252
Changes Should Be Well Considered Before Being Indorsed.	253
Spreading False News.	329
Time to Call a Halt.	329
Big Business Dreads and Fights Unions	330
Railroad High Finance.	331
American Standard of Wages Too Low, Says a Professor.	332
U. S. to Build Alaskan Road at Once	332
Our Lodges Should Affili-ate With State Federations.	333
A Novel Experiment in Managing an Industry.	334
Industrial Unionism, Amalgamation, etc.	334
The Bonus System Tried and Found Wanting in Equity and Justice	409
Independent Dealers Attack the United Cigar Stores Company.	410
Employees of the La France Engine Co. Strike	411
Federal Arbitrators Make An Award of Wage Increase for Engineers and Firemen.	411
A Large Increase in Building Program of Navy.	412
A. F. of L. Withdraws Indorsement of the Tailors' Union Label.	412
Ex-Mayor Harrison of Chicago Favors Public Ownership.	413

An Outrageous Verdict....	414
Secretary of Labor Wilson Calls a Conference on Labor.	415
Pullman Car Company Growing Wealthy on Tips.	415
A. F. of L. to Wage a Campaign Against Detective Agencies.	415
Chicago Labor Officials Indicted.	416
Death of a Prominent Labor Editor	417
An Open Shop Tank Building Firm Loses Work.	417
Our Position Indorsed....	417
Organized Labor's Exhibit at the Frisco Exposition.	487
An Unwise Move.....	487
Richmond, Va., Unions Are Progressing.	488
Ford Issues An Enormous Amount of Watered Stock.	489
A Voice From the Forgotten Past	489
Members Should Furnish Changes of Address....	490
Chairman Walsh Arouses the Ire of Big Business.	491
Reactionary Standpatters Again Seeking Control.	491
U. S. Government Railroad Building in Alaska a Big Job	493
Are U. S. Submarines Below Standard	493
Members of An Organization Must Obey Its Laws.	494
Convention of Hatters' Union Ignore Loewe & Co. Verdict	494
Another Union Hater Passes Away	495
American Neutrality	495
Idaho Sets a Splendid Example.	567
The Importance of Keeping Your Address Correct.	568
Strikes Declared Off.	568
Was the McNamara Grand Jury a Hand Picked One.	570
Burleson Again Recommends Government Ownership of Wires.....	571
American Exports Reach a Huge Total	572
A Federal District Court Whitewashes the Steel Trust.	572
American Ship Yards to Hum.	573
An Organized Effort to Evade Seaman's Law....	574
Some of the Contract Shops of St. Louis Try An Open Shop Stunt....	575
President Franklin's Sons Sick.	576
Visitors at Headquarters.	576

Page	Page	Page
<p>The Eastland Disaster Due to Incompetent Inspection. 659</p> <p>Strike On In New Orleans Contract Shop 660</p> <p>Strike at the Kansas City Terminal Settled 661</p> <p>The Federation of Labor Issues a New Publication. 662</p> <p>Reactionary Standpatters in Control 662</p> <p>Plans a Submarine Battle Cruiser. 663</p> <p>Strike on at Halifax, N. S. 663</p> <p>The Boiler Makers Seek Recognition From the Illinois State Federation. 663</p> <p>An Indefensible Proposition. 664</p> <p>Kansas Federation of Labor Holds Convention. 665</p> <p>A Synopsis of the Report of the Industrial Commission. 665</p> <p>Send in Correspondence Early. 665</p> <p>The Miners Decide to Reject Amalgamation. 666</p> <p>Labor Day Universally Celebrated. 745</p> <p>President Gompers Advises That Strikes Be Used Sparingly 746</p>	<p>Physical Examinations An Unjust Requirement for Employment. 747</p> <p>Will the Ship Builders Awake. 748</p> <p>The Colorado Supreme Court Repudiates Judge Hillyer. 749</p> <p>Are Railroad Employes Paying the Freight. 749</p> <p>To Use Electricity for Propelling Battle Ships. 750</p> <p>The Executive Council to Convene. 750</p> <p>Personal Mention 751</p> <p>Souvenir Publications. 751</p> <p>With Our Advertisers. 751</p> <p>Making a Farce of Boiler Inspection in Ohio. 827</p> <p>Molders Overwhelmingly Reject Amalgamation. 828</p> <p>A Rockefeller "Model Union" Put In Force In Colorado. 828</p> <p>The Executive Council Indorses Movement to Erect Monument to the Memory of Brother Gilthorpe. 829</p> <p>The Strike at New Orleans Settled. 830</p> <p>More Future Changes to Be Made in the Journal. 830</p> <p>Trying to Create Sentiment for a Tariff Commission. 831</p>	<p>The Dangers Arising From Oil Tank Cars. 832</p> <p>The Panama Canal Closed By Landslides 832</p> <p>Organized Labor in New York Will Oppose New Constitution. 833</p> <p>International Officers Visit Federal Prisoners 833</p> <p>Our National Banking Laws Still Need Amending 834</p> <p>Facilities for a Technical Education Are Increasing. 835</p> <p>General President Kirby of the Carpenters Dead. 836</p> <p>Christmas Greeting 897</p> <p>Private Ammunition and Armor Makers Should Be Eliminated from Government Contract 898</p> <p>Forms a Permanent Industrial Relations Committee. 899</p> <p>The Fast Boat Record. 900</p> <p>A Closer Co-Operation Between the Farmer and Labor Unions 900</p> <p>The American Federation of Labor Headquarters Building. 901</p> <p>Our Advertisers 902</p> <p>Organized Labor Overwhelms Reactionary Constitution. 903</p>

IN MEMORIAM.

<p>Members.</p> <p>Wade C. Gamer, L. 382. 67</p> <p>Peter Hanley, L. 130. 67</p> <p>Rudolph Polite, L. 37. 145</p> <p>J. H. Wingo, L. 4. 145</p> <p>W. L. Wurzback, L. 45. 145</p> <p>Jno. Rowan, L. 15. 145</p> <p>Wm. Gilthorpe, L. 32. 145</p> <p>Thos. Scheler, L. 463. 145</p> <p>Wm. Sloan, L. 281. 224</p> <p>Chas. J. Rogillio, L. 305. 224</p> <p>Ole Isaacson, L. 166. 308</p> <p>Ottmar Rebstock, L. 80. 308</p> <p>M. Mosley, L. 196 H. D. 308</p> <p>E. A. Merton, L. 305. 308</p> <p>E. K. Malley, L. 30. 308</p> <p>Daniel Jos. Collins, L. 615. 308</p> <p>D. A. Tierney, L. 305. 389</p> <p>Clyde J. Masters, L. 556. 467</p> <p>Michael Boskavich, L. 39. 467</p> <p>Axil Rose, L. 39. 467</p> <p>Wm. Messersmith, L. 161. 547</p> <p>Chas. Galvan, L. 37. 547</p> <p>F. E. Walters, L. 447. 627</p> <p>Leo R. Mahoney, L. 241. 627</p> <p>Leslie C. Carden, L. 657. 868</p> <p>Geo. E. Smith, L. 389. 868</p> <p>W. Skelland, L. 194. 868</p> <p>Phillip Doyle, L. 483. 947</p> <p>Wm. C. Saukenburg, L. 37. 947</p> <p>Joe Roberts, L. 74. 947</p>	<p>Master Roy Lee Pack, Son of Brother and Mrs. R. L. Pack of L. 143. 145</p> <p>Chas. Flick, Sr., Father of Bro. Chas. Flick, L. 37. 145</p> <p>Mrs. Nervesta McNeill, Mother of Chas. McNeill, L. 143. 145</p> <p>Mabel Stovall, Wife of Brother L. Stovall 224</p> <p>Mrs. Hennessy, Mother of Brother Hennessy 224</p> <p>Jas. Ceurry, Jr., Son of Brother Jas. Ceurry of L. 37. 224</p> <p>Fred Lutchgens, Brother of Brother Henry Lutchgens. 224</p> <p>Fred Kull, Father of Brother Frank Kull. 224</p> <p>Grelley Pedicod, Bro. of H. Pedicod. 224</p> <p>Anna Mae Ray, Daughter of Brother Ray. 224</p> <p>Mrs. Lena Martin, Mother of Brother Martin, L. 227. 308</p> <p>Mrs. Wm. Powers, Wife of Brother Wm. Powers, L. 206. 308</p> <p>Patrick Shea, Father of Jos. Shea, L. 442. 308</p> <p>Master Ethan Allen Johnson, Son of Brother and Mrs. E. A. Johnson, L. 200. 308</p> <p>Alex Kruiński, Brother of Philip Kruiński, L. 227. 308</p> <p>Wm. Jones, Father of Wm. Jones, L. 292. 389</p> <p>Mrs. Jno. Hunter, Sister of Bro. Wm. Baker, L. 206. 389</p> <p>Jas. M. Daniels, Father of Hobart Daniels, L. 549. 389</p> <p>Jas. F. Clucas, Father of</p>	<p>Brother Wm. H. Clucas of L. 227. 467</p> <p>Amelia Hentz, Mother of Brother Chas. Hentz, L. 360. 467</p> <p>Mrs. L. J. Frost, Wife of Brother L. J. Frost of L. 587. 467</p> <p>Catherine Norton, Wife of Dan Norton of L. 227. 547</p> <p>Chas. Ottman, Father of Jos. Ottman, L. 37. 547</p> <p>Jas. McGowan, son of Brother A. McGowan, L. 37. 547</p> <p>Jack McGrevy, Brother of Wm. McGrevy, of L. 587. 547</p> <p>Lemuel Hunt, Father-in-Law of Brother Wm. Springer, L. 400. 627</p> <p>Mrs. Anna Hartmann, Mother of Brother Edward Hahl, L. 37. 628</p> <p>Mrs. Belcher, Mother of Jas. Belcher, of L. 447. 628</p> <p>Mrs. Lela Ida Blount, Mother of Brother E. Y. Blount, L. 222. 709</p> <p>Mrs. Wm. Hammett, Mother of Brother J. T. Baggett, L. 222. 709</p> <p>N. W. Alford, Father-in-Law of Brother G. M. Johnson, L. 222. 709</p> <p>Wm. H. King, Father of Brothers N. A. and E. B. King, L. 100. 799</p> <p>Mrs. Annie Hannon, Mother of Brother John Hannon, L. 191. 868</p> <p>Mrs. Pauline Munsch Laine, Mother of Brother Geo. Munsch, L. 37. 947</p> <p>Y. Grimland, Father of Brother Bob Grimland, L. 74. 947</p>
---	--	---

LADIES' AUXILIARY.

<p>A Communication From Mrs. Jas. W. Sandy, Chicago, Ill. 751</p> <p>A Communication From Mrs. A. F. Bingham, Springfield, Mo. 118</p>	<p>A Com. From Mrs. Wm. Specht. 119</p> <p>A Communication From Mrs. Luella Van Fleck, Parsons, Kas. 185</p> <p>A Communication From Mrs. Smith, Parsons, Kas. 274</p>	<p>A Communication From Mrs. O. M. Diedrich, Chicago, Ill. 589</p> <p>A Communication From Mrs. Mollie Geary, Chicago, Ill. 593</p>
--	--	---

LEGAL NOTICES.

Page Pages.....244 and 745 Page Page

LIST OF MEMBERS PREVIOUSLY ADVERTISED.

Pages, 68, 149, 225, 308, 389, | 468, 548, 628, 629, 799, | 800. 869

LODGE NOTICES.

Dust, et al., L. 418..... 68	Fisher-Lodge 363..... 468	Sheldon, L. 493..... 799
Paul Sorgen, L. 322..... 68	McLaughlin-Relatives..... 468	Seigler, L. 549..... 799
Huff, L. 360..... 68	Richea-His Wife..... 468	McGrath & Steinhaus, L. 302..... 799
Fitzpatrick, L. 47..... 68	Burke-Lodge 82..... 468	Walsh, L. 209..... 799
McManus, L. 592..... 68	Cooper, et al., L. 491..... 468	Looney, L. 209..... 799
Richardson, L. 100..... 68	Walpale, L. 591..... 469	Notice-Nelson Warren..... 799
J. D. Landault-Mrs. Jno. Cure..... 68	F. C. Hassee, L. 39..... 469	Heath-Daughter..... 799
Swain, L. 567..... 68	Thompson, L. 587..... 469	Ennis, L. 246, 111..... 799
Robertson, L. 178..... 68	Millarn, L. 447..... 548	Huell, L. 588..... 799
S. W. Hill-Son..... 145	Duson-Tornice..... 548	Kelley, L. 223..... 799
Mason, L. 499..... 145	Fitzgibbons, L. 99..... 548	Jeffries-Magoon..... 799
Czatlenski, L. 32..... 145	Varney, L. 80..... 548	Farley-O'Neil..... 799
Tupen-Loeb..... 145	Canton, L. 384..... 548	Feeney-Lauderback..... 868
Huggins-Marshall..... 145	Shrout, L. 82, 521 and 82..... 548	Franks-Maley..... 868
Thompson-His Wife..... 145	Douglas, et al., L. 576..... 548	Sullivan-Mother..... 868
Thomas-His Brother..... 197	Chas. J. Younger..... 628	Kerul, L. 32..... 869
Anderson-Disbrow..... 225	J. A. Schofield, L. 419..... 628	O'Brien, L. 39..... 869
Stewart et al., L. 66..... 225	Notice Cristobal, C. Z..... 628	Cooper, et al., L. 491..... 869
C. W. Huggins-Mrs. Wil- liams..... 225	Dowd, L. 199..... 628	Kellett, L. 132..... 869
E. L. Chafin, L. 578..... 308	Shrout, L. 82..... 628	Blismore-Young..... 947
J. E. Welch, L. 568..... 308	Cooper, L. 528..... 628	Seigler-Dundon..... 947
Horstmeier, L. 381..... 308	Cleary-Father..... 628	Chollar, Lodge 576..... 947
Costlow, et al., L. 292..... 389	Quinn-McCrone..... 628	Parkinson-Moore..... 947
Connors-Zobel..... 389	F. Schultz, L. 10..... 628	Grimes, Lodge 312..... 947
Broderick-Walker..... 389	Linden, L. 528..... 628	McGovern, His Brother..... 947
	Gleason-Kinley..... 709	Lower, Post Master..... 948
	McBryde, L. 20..... 709	
	Rawlings-Hinzman..... 709	

LOST AND FOUND.

L. 20, Senn (lost due book). 68	G. Ledergerber (lost due book)..... 149	Found, due book, I. S. T.... 469
L. 596, Reynolds (lost due book). 68	McIvers, D. (lost due book)..... 149	Lercher-I. S. T..... 548
L. 267, Hoag (lost due book). 68	Geo. Tannehill (lost due book and card)..... 225	Lakins, L. 88..... 628
Found, due book, F. P. Reinemeyer, I. S. T.... 68	B. Costa (lost due book)..... 469	Wehman (lost due book)..... 709
Found, due book, Jones, William Griffin (lost due book)..... 149	Edw. E. Ivey (lost due book)..... 469	J. Corey (lost due book)..... 709
	J. C. Busch (lost due book)..... 469	McDermott (lost due book)..... 709
		Due Book, Hicks..... 948
		Due Book, Granberger..... 948
		List of Members Previous-ly Advertised..... 948

MECHANICAL ARTICLES.

Mechanical Articles, 16, 17, | 104, 174, 175, 176, 256, 339, | 419, 499, 578, 669, 752, 837, 904

NEWS OF GENERAL INTEREST.

A Communication From the Secretary of the Australian Boiler Makers and Ship Builders..... 57	Valley of Wars..... 214	The Proceedings of the National Academy of Sciences..... 302
Napoleon..... 58	Who Dug This Canal?..... 215	A One Piece Steel End Freight Car..... 308
Burlap Wrappings on Steel Pipe..... 59	Terrible Oath for Plumbers..... 215	A Co-Operative Mail Order House..... 308
Discuss Workmen's Compensation..... 59	The Conditions of Industrial Accidents..... 215	Wages and Hours of Labor in the Building and Repairing of Steam Cars, 1907 to 1913..... 304
Moving Chicago Steel Grain Tanks..... 60	Tuberculosis and the Workingman..... 216	The World's Largest Gun, Made at Watervliet..... 378
Released on Receipt "To Prevent Unemployment"..... 92	Among Our Exchanges..... 216	"Catching" Tuberculosis or Infection..... 378
The Criminal "Speeding Up" System Must Stop..... 136	A Communication From the A. F. of L..... 216	A Notorious Spying System..... 379
First Time in History..... 137	U. S. Department of Labor..... 217	A New Heavy Freight Service Locomotive..... 380
Hydraulic Riveting the Steel Structure of the White Star Liner "Britannic"..... 138	Entries in Los Angeles Labor Temple Contest..... 218	Locked Out Miners of Ohio Will Raise Own Vegetables..... 380
U. S. Department of Labor Children's Bureau, Washington..... 141	How Labor Unions Have Fought Tuberculosis..... 219	An Enormous Steel Coal Car..... 381
European Tour Contest..... 141	Loan Plan for Small Borrowers..... 219	"If You Must Drink"..... 381
A New Canadian Consolidation Locomotive..... 142	The Declaration of America..... 220	An Example for America..... 382
A Western Maryland High Power Locomotive..... 143	Labors' Representatives Demand Compensation Commission..... 220	Mass Meeting of Organized Labor..... 382
Chlorin-Bleached Flour..... 143	Mr. Hill's Logic..... 244	U. S. Department of Labor, Bureau of Labor Statistics, Washington..... 383
The Infections of Immigrant Ships..... 145	U. S. Commission Industrial Relations..... 299	One Day Rest in Seven..... 384
Handling Merchandise With Spiral Chutes..... 212	Ex-President Taft Discusses Prohibition..... 299	Three Years Under the New Jersey Compensation Law..... 384
Women's Trade Union League Convention Call..... 214	Half of Workers' Wages Insufficient Compensation..... 301	
	An Italian Four Cylinder Prairie Locomotive..... 301	
	The Largest Locomotive Crane in U. S..... 302	

Page	Page	Page			
An I. W. W. Assault Upon the Character of Our Members in the Oil Fields of Oklahoma.....	385	Wireless Locomotive For Switching Service.....	585	ances.....	698
The Vocational School vs. America.....	408	Is Tuberculosis Curable?.....	535	The Baby's Vacation.....	699
The Riegel Firebox on Pacific Type Locomotive.....	454	The Optimist.....	536	A Modern American 20 Cubic Yard Air Dump Car.....	700
U. S. Dept. of Labor, Bureau of Labor Statistics.....	455	A Coal Storage Steel Tank.....	537	Photographs in Railway Locomotive Smoke Abatement.....	701
Don't Worry Over Mistakes.....	456	Punch Press Wheel Guards.....	538	Decisions of Court Affecting Labor.....	704
A Kansan Tabulates Ready Reference For Parcel Post.....	456	The Western Union Telegraph Co. Breaks Its Agreement.....	538	Labor Organization in Canada, 1915.....	705
Care of the Baby in Summer 456, 532, 540.....	613	A Novel Electric Walking Jib Crane.....	539	Destroy the Fly.....	706
Standing of Candidates in Los Angeles Labor Temple Contest.....	457	Fines for Offenders Favor Well-to-Do.....	608	The "Aerotug" Driven by An English Crude Oil Engine.....	793
Danger Signals of Tuberculosis.....	458	A Glenn, Four Cylinder, Compound Locomotive.....	608	A Novel Safety Sectional Boiler Flue Expander.....	793
Oil Storage Tank Fire Extinguisher by a Unique Foam System.....	459	The Cuba Ferry.....	609	Electric Spot Welders.....	794
Labor Legislation of 1914.....	461	German East African Locomotive.....	609	The Unique Stern Wheel and Push and Pull Motor Tug "Tabasquena".....	796
Device Keeps Train Safe.....	461	Two English Darlington Locomotives.....	611	Convention Call, A. F. of L.....	797
Take a Look at Yourself.....	462	Industrial Accident Statistics.....	612	Continuous Rail Crossing for Track Intersections.....	865
The Importance of Manners.....	462	What Tuberculosis Costs in Wages.....	616	A Half Million Gallon Water Tank and Tower.....	866
Government Aid to Home Owning and Housing of Working People in Foreign Countries.....	462	Correctional System of Springfield, Ill.....	616	A Remarkable 75-Ton Freight Car of Unique Design.....	866
To Play a Bigger Part.....	463	An Italian Four Cylinder Prairie Locomotive.....	617	A Giant Sectional Boiler Flanging Press.....	867
Strength Record Broken by New Steel Cable.....	463	The Latest American Submarines.....	617	The Russian State Railway Loco.....	938
Retail Prices of Food, 1907 to December, 1914.....	530	Congressman Buchanan's View of War.....	618	Modern Electric Arc Welding.....	939
Minimum Wage Legislation in U. S. and Foreign Countries.....	531	The Union Label as a Means of Reducing the Cost of Living.....	621	An Emery Wheel Safety First Valve.....	942
Care of the Baby in Summer.....	533, 540, 613	Foreign Food Prices as Affected by the War.....	623	A Giant Hydraulic Forging Test.....	943
		Pipe Wrenches Without Screws.....	697	Effect of Minimum Wage Determination in Oregon.....	943
		History of Controversy in the Cloak Trade in New York and Its Settlement.....	697	Exports for Sept., 1915.....	944
		Novel Safety Boiler Appli-			

PHOTOGRAPHS.

A Group of Members, Lodge 16.....	39	Members Lodge 249.....	355	Foreman and Apprentices, Tacoma, Wash.....	594
Photo of Check, Lodge 592.....	41	Alfred Abbott, Lodge 458.....	356	Mr. and Mrs. John Cure and Niece.....	595
Burlap Wrappings on Steel Pipe.....	59	Vancouver Lodge.....	357	E. H. Eriand, Grand Junction, Colo.....	597
Moving Chicago Steel Grain Tanks.....	61	Photo of Banquet, Lodge 450.....	359	A Glenn 4-Cylinder Compound Locomotive.....	608
Members of Lodge 434.....	111	Burial of Brother Alec Macavoy.....	364	A German East Africa Locomotive.....	610
White Star Liner "Brittanic".....	138	Two Views of Barrel Tanks Cushing, Okla.....	365	One Style of English Darlington Locomotive (Two Views).....	611-612
Hydraulic Riveting on the White Star Liner "Brittanic".....	139	Members of Lodge 471.....	366	An Italian 4-Cylinder Prairie Locomotive.....	617
White Star Liner "Brittanic" After Being Launched.....	140	Committee, G. F. Calvert, Thos. Nolan and Geo. J. Thomas.....	371	U. S. Submarine Torpedo Boat.....	618
A New Canadian Consolidation Locomotive.....	142	The World's Largest Gun Made at Watervliet.....	378	John Kuhn, Lodge 578.....	622
Western Maryland High Power Locomotive.....	143	A New Heavy Freight Service Locomotive.....	380	Group of Members of Lodge 384.....	624
Wm. J. Giltthorpe.....	146	An Enormous Steel Coal Car.....	381-382	Pipe Wrenches Without Screws—Two Views.....	697
Members of Lodge 96.....	186	Group of Scallies at Fort Worth, Texas.....	436	Novel Safety Boiler Appliances.....	698
Job at Ten Mile Station From Jacksboro, Tex., in the Jungle.....	186	Members of Lodge 581.....	441	A Modern American Dump Car.....	700
One of the Struck Jobs, Texas Oil Fields.....	186	Riegel Firebox on Pacific Type Locomotive (Three Views).....	454-455	Railway Locomotive Smoke Abatement (Three Views).....	701-703
Two Views of Sabine Netches Lock Gates, Port Arthur, Tex.....	188	Two Views Oil Storage Tank Fire Extinguisher by a Unique Foam System.....	459-460	Strike Adjustment Committee, Baton Rouge, La.....	764
Delegates to Convention, District Lodge 31.....	191	D. J. Corcoran, Lodge 206.....	512	Group of Members Lodge 439.....	775
Handling Merchandise With Spiral Chutes.....	212-213	Robert Rodgers, Lodge 14.....	515	Members of Lodge 293 (Two Views).....	776
Three Groups of Members of Lodge 592.....	275	L. J. Flohr, Lodge 424.....	516	Son of A. E. Strode, Campaign, Ill.....	777
Kennicott's Job, Cushing, Okla.....	276	Members of Lodge 360.....	517	Members of Lodge 384.....	778
Three Views of Pipe Line Job at Preston, Idaho.....	283	Members of Lodge 187, Miami, Ariz.....	518	Members of Lodge 371.....	781
An Italian Four Cylinder Prairie Locomotive.....	301	Two Views of Booth, Panama-Pacific Exposition.....	530-531	Lodge 216, El Paso, Tex.....	785
Largest Locomotive Crane in U. S.....	302	Wireless Locomotive Switch Engine.....	525	A Novel Motor Tug.....	793
One Piece Steel End Freight Car.....	303	A Coal Storage Tank.....	537	A Self-Feeding Flue Expander.....	793
		Punch Press Wheel Guards.....	538	An Electric Spot Welding Machine.....	795
		A Novel Electric Walking Jib Crane.....	540	Two Views of Motor Tug "Tabasquena".....	796
		Two Views of Boiler Explosion.....	591		
		Members of Lodge 153.....	592		

	Page		Page		Page
Members of Lodge 592.....	854	W. J. Southern	856	Group of Members of Lodge	926
Members of Lodge 382.....	847	Boiler Makers and Friends	857	363, East St. Louis, Ill.....	926
Members in Labor Day Pa-	849	Lodge 204	860	Photo of Brother Robt. J.	927
rade, Norfolk, Va.....	849	Members of Lodge 66.....	865	Hanna, Lodge 19.....	927
Float, Norfolk, Va.....	849	A New Device for a Continu-	865	A Large Ocean Steamer	928
Labor Day Committee,	849	ous Rail at Railway	866	Blown Ashore at Galveston,	928
Portsmouth, Va.....	849	Crossings	866	Tex.	928
Group of Members Lodge	850	A Giant Tower Tank	867	A Group of Members at	930
596.....	850	A Special Designed Freight	867	Galveston, Lodge 132.....	930
Members Lodge 568.....	851	Car.....	867	Group of Members of L.	930
Members Lodge 551.....	852	A Giant Boiler Flanging	867	245, Concord, N. H.....	930
Members Lodge 57.....	853	Press.....	867	Float of Boiler Makers at	933
Members and Families,	854	Four Views of Flanging Ma-	868	Madison, Wis.....	933
Lodge 105	854	chines.	868	A Loco. Built for the Rus-	938
Members of Lodge 204.....	855	A Group of the Interna-	918	sian Ry.	938
Group of Boiler Makers and	856	tional Officers of Our	918	Modern Electric Arc Weld-	940
Machinists, Newcastle,	856	Brotherhood.....	918	ing.....	942
Pa.....	856	A Group of Members of	924	An Emery Wheel Guard.....	942
B. & O. Boiler Makers On	856	Lodge 191 of Esqui-	924	A Giant Hydraulic Press.....	943
Outing, Lodge 493.....	856	mault, B. C., Can.....	924		

POETICAL SELECTIONS.

The Cry of the Dreamer...	65	The Factory Child.....	224	The Breaking Plow.....	467
What Have We Done....	65	Keep the Furrow Straight.	224	Ashamed of Your Mother.	546
Use Well Thy Freedom....	65	Cling to Those Who Cling	306	Memories of the Old Vir-	546
Fools is Right.....	66	to You.....	306	ginia Reel.....	546
The Joy.....	66	Heart Strings.....	306	The Voiceless.....	546
Human Progress.....	66	The Farmer.....	307	The Voice of the People....	547
Tell Him Now.....	66	Will the Light Be White...	307	What I Live for.....	547
The Mint Bed of Virginia...	67	Disarmament.....	307	Pure.....	626
Never Mind the Knocker...	67	The Stay at Home.....	307	Be What Mother Thinks	626
Meddler's Itch.....	148	The Cheerful Spirit.....	307	You Are.....	626
The Stumbler.....	148	Two Kinds.....	388	Excelsior.....	626
They've Given Pa a Raise...	148	In the Palace of Content....	388	A Call for Men.....	627
All is Well.....	148	An Old Man's Job.....	388	What's the Use.....	627
Don't Stop at the Station	149	Tell Her So.....	388	The Man of Choice.....	627
of Despair.....	149	Face the Sun.....	389	Five Dollars a Week.....	708
The Verdict.....	149	Before it is too Late.....	466	They Say.....	708
What's the Use?.....	149	Opportunity.....	466	Welcome.....	708
It Can't be Done.....	149	Safety First.....	466	The Secret.....	798
The Kicker.....	223	The Bravest Battle.....	466	The Other Fellows Job....	798
Around, Trouble.....	223	Joy.....	467	Forget It.....	946
The Song That Reached My	223	The True Aristocrat.....	467	Not Afraid of Pa.....	947
Heart.....	223				

QUOTATIONS.

Pages 14, 15, 103, 103, 172,	418, 497, 498, 576, 577, 667,	668, 752	836
178, 254, 255, 337, 338, 417,			

INTERNATIONAL OFFICERS' REPORTS.

F. P. Reinemeyer, I. S. T.,	842	J. A. Franklin, Interna-	225	Auditor's Report for 1914.	225
19, 179, 257, 420, 579,	842	tional President	269	Communications from In-	913
580.....	842109, 180, 182, 268, 269	626	ternational Secretary	913
Thos. Nolan, 2nd I. V. P.,	838	J. P. Merrigan, I. V. P.,	626	Reinemeyer.....	913
19, 106, 258, 421, 500, 580,	838 176, 257, 424, 583, 756	626	Report of International	905
670, 754.....	838	Proposed Amendment to	626	Vice-President Nolan.....	905
M. A. Maher, 7th I. V. P.,	678	Constitution.....	626	Communication from In-	908
.....24, 345, 678	678180, 181, 268, 269	626	ternational Vice-Presi-	908
Jno. Dick, Deputy Organ-	768	Jos. P. Ryan, 8th I. V. P.,	626	dent Hinzman.....	908
izer.....	768262, 345, 431, 674, 763, 840	626	Report of R. C. McCut-	914
Joe Reed, Deputy Organizer,	842	J. F. Schmitt, 9th I. V. P.,	626	eon.....	914
.....26, 184, 508, 842	842264, 766	626	Report from Vice-President	908
Chas. F. Scott, Deputy Or-	506	Wm. Atkinson, 5th I. V. P.	626	Merrigan.....	908
ganizer.....	506339, 505, 672	626	Report of Third Interna-	912
Report of Delegates to the	28	John J. Dowd, 6th I. V. P.,	626	tional Vice - President	912
A. F. of L. Convention.....	28341, 759	626	Weyand.....	910-912
The American Federation	32	Louis Weyand, 4th I. V. P.	626	Communication from In-	912
of Labor Convention,	3223, 429, 586, 671, 758	626	ternational Vice-Presi-	912
Building Trades Depart-	32		626	dent Schmitt.....	912
ment.....	32		626		

SMILES.

Pages 45, 63, 64, 65, 144, 211,	387, 464, 465, 543, 544, 545,	624, 625, 626, 707.....	946
320, 222, 304, 305, 306, 396,			

STRIKES NOW IN FORCE.

Pages 15, 103, 173, 255, 338,	418, 498, 577, 668, 752, 836, 903
-------------------------------	-----------------------------------

TRIALS, FINES, ETC.

Dierich, Lodge 305.....	309	Correction by Richard	629	Sullivan, et al, Lodge 284	629
Roberts, Lodge 305.....	468	Leahy.....	549	Chas. Boland, Lodge 113...	629
E. L. Chafin, Lodge 587.....	469	Mitchel, et al., Lodge 37...	549	C. W. Brice, Lodge 587....	629
E. A. Grimes, Lodge 495.....	469, 549	Gus Wink, Lodge 39.....	549	Adams, et al., Lodge 592..	709
.....469, 549	469	Beleinski, et al., Lodge 592.	549	Hazlett, et al., Lodge 39..	709
Dalley, et al., Lodge 592..	469			Marosky, Lodge 377.....	709

Oxweld Railroad Service Company

RAILWAY EXCHANGE BUILDING

80 E. Jackson Boulevard

Chicago, Ill.

By Insisting Upon Purchasing Union Stamp Shoes



You help better shoemaking conditions.
You get better shoes for the money.
You help your own labor position.
You abolish child labor.

Do not be misled by retailers who say: "This shoe does not bear the union stamp, but is made under union conditions." This is false—no shoe is union made unless it bears the union stamp.

Boot and Shoe Workers' Union

246 SUMMER STREET, BOSTON, MASS.

JOHN F. TOBIN, President.

CHAS. L. BAINE, Sec.-Treas.

THE COMMERCIAL NATIONAL BANK OF KANSAS CITY, KANSAS

Capital, Surplus and Undivided Profits, \$725,000.00. Deposits, \$5,500,000.00.

We cordially invite the Boiler Makers and Ship Builders of the United States who desire to transact banking business with us (which can be done readily by mail) to write to any of their officers and ask any questions they may desire to ask about our reliability and standing.

P. W. GOEBEL, President
G. J. BISHOP, Asst. Cashier

C. L. BROKAW, Vice-President and Cashier
H. L. LARSON, Asst. Cashier

You Will Eventually

Purchase a copy of "Laying Out for Boilermakers"

Why Not Now?

And devote a part of the long winter evenings to improving your knowledge of laying out so that when the opportunity of a better position presents itself you will be prepared to accept it. We receive many appreciative letters from satisfied purchasers of this book and we know you will be, too.

Price, \$5.00

Don't delay any longer, but send in your order to

J. B. Casey, Room 9, Law Bldg., Kansas City, Kansas

ALL ABOUT BOILERMAKING

The best, most interesting and timely information about the Boiler Making Industry is published every month in the magazine — THE BOILER MAKER.

This magazine is devoted exclusively to YOUR interests and prints everything worth knowing about Boiler Designing, Building and Repairing. THE BOILER MAKER would be a big help to you in your work and keep you in touch with all the new methods and improvements.

Fill in the coupon below, mail it to us and we will send you a copy FREE.

THE BOILER MAKER
17 BATTERY PLACE NEW YORK

COUPON

The Boiler Maker,
17 Battery Place, New York City.

Gentlemen:

Please send me a copy of THE BOILER MAKER FREE.

Name.....

Address.....

Occupation.....

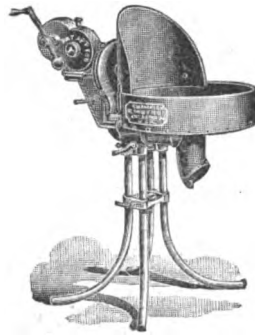

NO. 401 WITH SHIELD.

No. 401—Champion Steel Rivet Forge is used by the great majority of railroads, bridge builders, boiler and structural iron workers of the world. Constructed from structural steel, making it strong and durable. Its gearing is the 400 Champion "Patented" high-speed spiral gearing. It runs noiseless. Highest grade adjustable ball bearings. It is quickly taken apart and assembled. Produces blasts to weld 3/2 to 4-inch iron in ten minutes. Crank turns either way.

Champion Blower & Forge Co.
Lancaster, Pa., U. S. A.

Just the Information We Need

**WEBSTER'S
NEW INTERNATIONAL
-THE MERRIAM WEBSTER**

Every day in your talk and reading, on the street car, in the office, shop, and school some new question is sure to come up. You seek quick, accurate, encyclopedic, up-to-date information.

This NEW CREATION will answer all your questions with final authority. 400,000 Words Defined. 2700 Pages. 6000 Illustrations. Cost \$400,000. The only dictionary with the new divided page. A "Stroke of Genius."

Write for specimen pages, illustrations, etc.

Mention this publication and receive FREE a set of pocket maps.

G. & C. MERRIAM CO.
Springfield, Mass., U. S. A.

The Burlington SMASHES ALL WATCH PRICES



Look!

- ☞ 19 Ruby and Sapphire Jewels—
- ☞ Adjusted to the second—
- ☞ Adjusted to temperature—
- ☞ Adjusted to isochronism—
- ☞ 25-year gold strata case—
- ☞ Genuine Montgomery Railroad Dial—
- ☞ New Ideas in Thin Cases.

**Only
\$2.50
A Month**

And all of this for \$2.50—only \$2.50 per month—a great reduction in watch prices—direct to you—positively the exact prices the wholesale dealer would have to pay. We do not care to quote these prices here, but write—write before you buy. Think of the high grade, guaranteed watch we offer here at such a remarkable price. Indeed, the days of exorbitant watch prices have passed.

See It First

You don't pay a cent to anybody until you see the watch. We won't let you buy a Burlington Watch without seeing it. Look at the splendid beauty of the watch itself. Thin model, handsomely shaped—aristocratic in every line. Then look at the works. There you see the pinnacle of watch making. You understand how this wonder timepiece is adjusted to the very second.

Every fighting vessel in the U. S. Navy has the Burlington Watch aboard. This includes every torpedo boat—every submarine as well as the big Dreadnaughts.

Send Your Name on This Free Coupon

Get the Burlington Watch Book by sending this coupon now. You will know a lot more about watch buying when you read it. You will be able to "steer clear" of the double-priced watches which are no better. Send the coupon today for the watch book and our offer.

Burlington Watch Co.

19th St. & Marshall Blvd., Dept. 4009, Chicago, Ill.

Burlington Watch Co.
19th Street and Marshall Blvd.
Dept. 4009 Chicago, Ill.

Please send me (without obligation and prepaid) your free book on watches with full explanation of your cash or \$2.50 a month offer on the Burlington Watch.

Name.....

Address.....

This book should be returned
the Library on or before the last da
stamped below.

A fine of five cents a day is incurr
by retaining it beyond the specifi
time.

Please return promptly.

~~SEP 1 1900~~







