

TT 520
.S4
Copy 1







Prof. S. Schorr

THE AMERICAN DESIGNER and CUTTER

A Complete, Practical and
Up-to-date Work on the
Art of Designing, Cutting,
Grading, Fitting, Sketching
and Practical Tailoring of
all kinds of Womens', Miss-
es', Juniors', Childrens'
and Infants' Garments

By
Prof. S. SCHORR



Publishers
AMERICAN PATIERN COMPANY
New York, U. S. A.

7-15-15

COPYRIGHT 1915, BY SAUL SCHORR

Entered according to act of Congress in the office
of the Librarian of Congress at Washington,
D. C., and any infringements on the
Copyright will be prosecuted to
the fullest extent of
the law.

31

100

AUG 16 1915

©CL.A411102

14-11184

Preface

THE freely expressed wishes of my numerous correspondents and pupils, induced me to put into book form this compilation of several year's observation, experiment and practice in the art of Designing and Garment cutting.

This book is devoted to the art of designing, cutting, grading, fitting, sketching and practical tailoring of all kinds of Ladies', Misses', Juniors', Childrens' and Infants' Garments.

I trust the trade will here acknowledge an honest attempt at finding a work of a permanent nature, that no matter how fashion may fluctuate, will conveniently be at hand as a guide to the principles of designing and garment cutting to ensure artistic results.

I have given such details of instruction as should make this not only an invaluable handbook for the student, but a most useful work of reference for the experience Designer, Cutter and Pattern-Maker who wishes to be up to date in this important department.

I am convinced that any person of average intelligence can become a master of the art through the medium of this publication, whether it be a practical Designer, Cutter or Pattern-maker, or one totally unacquainted with the art of designing and garment cutting.

I have spared neither labor nor expense in making the volume worthy of the highest place in the Designer's and Cutter's library, and in introducing this book to a world-wide audience believing that it will be of great service in helping to achieve success as Designer, Cutter and Pattern-Maker.

THE AUTHOR

Introduction.

THIS work is a result of many years' study, research, and experiment, in which no pains have been spared to perfect.

The student will find the system extremely simple and entirely free from complication; no scale, chart and divisions of any kind is used, simple the ordinary inch measure.

The method by which the location of all points on the draft are found in numerical order in the descriptive text is new in principle and by its simplicity is systematized, time economized and trouble absolutely eliminated.

This important and thoroughly comprehensive work is new in principle and is at the same time simpler and more direct than any other system before the trade.

SAUL SCHORR

What a Designer Should Know

What a Designer requires to do is to bring ideas into new associations and in order to do this he must be ever on the alert to gather them from the books of bygone age, as well as from the passing crowd. These ideas must be not only brought into new associations, but they must be blended with the prevailing ideas of fashions, or they will not be acceptable.

Of course the Designer needs to realize that there are certain fundamental rules that must be obeyed; for instance, there must be unity between the design of one part and another. There must be order in the arrangement, and there must be a proportion running through it all, for these three, unity, order and proportion, are the laws of beauty.

These we may obey, and still gather an idea for a skirt from one costume, a sleeve from an other, a collar from a third and a body part from a fourth illustration, blending the whole into one harmonious whole by some style of ornamentation which acts as a connecting link between the various parts.

Ladies' Tailor Qualifications

The qualifications necessary to become a successful ladies' tailor are many and various. He must be an artistic nature with an eye to beauty, so that he will be able to blend his colors to match the ladies' complexion, and to arrange the seams, braiding, etc., so as to produce the best effect on his customer.

He must have a knowledge of materials and the latest method of decoration. He must be gentlemanly in manners and conversation, courteous and obliging, and be possessed with an abundance of tact and ability to please, and treat his customers with respect.

He should be able to take his measure easy and graceful, and he should avoid all undue handling of his customer. He should never stand directly in front of her, and he should abstain from all unnecessary conversation.

He should also have a practical and technical knowledge of his trade, and be able to design garments, and produce them up-to-date and to fit the figure.

These qualities, assiduously cultivated, will enable the aspirant to achieve success.

System

One of the most important things to consider in order to become a proficient Designer, Cutter or Pattern-Maker is the ability to cut perfect fitting patterns. Every Designer and Cutter who is interested in the elevation of his industry and the satisfaction of his patrons, should make it a study to be competent in his pattern cutting. The knowledge of a system of cutting is necessarily the first step towards a practical position.

The intelligent student of designing and garment cutting will require some guidance as to the principles, or basis, upon which the system is constructed. It is not sufficient that he should merely understand the location of a few construction lines, and the few divisional quantities that produce them.

There are many mature Designers and Cutters now in practice who look back with surprise upon the number of systems (so-called) that they experimented with. The explanation of this very foolish practice consist in the fact that such students, though letter-perfect, so far as the actual working of their system is concerned, are absolutely devoid of all knowledge of the principle (if any) upon which it has been found.

It is only the student who has been well grounded in this essential information who can logically estimate the results of his practice. If the principles upon which a system is based are unreliable, there can be no hope of anything approaching uniform success in its use, but if the principles are right the casual troubles that arise can be expeditiously and effectually rectified.

Good Lines

The designer and cutter of to-day must be an artist to fully grasp what is the good line. As soon as this idea is grasped it is necessary to change again after the caprices of fashion. That what is considered the perfect line to-day is altogether changed for to-morrow. The eyes must be always open.

It is difficult to follow this movement. Happily many ladies are content if their costume fits well, but the greater part of dressy ladies desire that the lines must be perfect.

Contrasts

In ladies' garments marked contrasts often produce the very best results, and the introduction of a little velvet or brade in the trimming, or the use of some special make of button, gives the entire garment a character which pronounces it a stylish creation.

In the selection of the lining excellent effects can be produced by employing complimentary colors such as a green lining for a russet coat, or a citrine lining for a blue coat, or a primrose lining for a heliotrop cloth, and so on.

Excellent effects are often obtained by the use of white silk or satin linings, or such shades as silver gray, which goes well with any cloth.

I think these contrasts are more succesful than the best of matches.

Fashions

Fashions in fema'e garments change rapidly, and as most ladies' demaed to be dressed in harmony with the latest style, it becomes desirable for the designer and ladies' tailor to keep him self well posted up in what is being worn. This may be done in several ways. In the first place he should carefully note what is being worn at the centres of fashion he visits, and particularly study the exhibits of those firms of note who have made a reputation for this class of trade.

Then it is very important that he should take in some fashion periodical, which illustrate the latest features of fashion in such a way as to render them easy of applicaton to tailor-made garments; and that is what is most wanted.

Style

As in garment designing, so in cutting, style has ever played an important part in the trade. Style is the artistic finish given to the garment in order that it may have character about it. The run of the seams, the finish of the edges, together with the size and finish of the lapels, collar and sleeves, must all be appropriate to the material used, and to the purpose the garment in intended for. Fashion plates are the means of portraying the character or style of the garments, and are interpretations of the style of the garments favored by the various classes of the cmmunity it is our duty to cater for.

PART ONE

WOMEN'S GARMENTS

How to Take Measurement

Fig. 1. Place the tape measure from the centre of back neck over the shoulder, continue down the front of shoulder, under the arm, and straight across the centre back seam in a horizontal line. Place a pin or make a light chalk mark where the tape measure meets the centre back seam horizontally.

Fig. 2. **Scye Depth Measure:** Measure from the centre of back neck to the point where the pin had been placed or where the chalk mark has been made.

Fig. 3. **Back Waist Length Measure:** From the centre of back neck down to the natural waist length. Continue down to the full length as desired.

Fig. 4. **Bust Measure:** Around the body under the arms, over the fullest part in front and well upon shoulder blades in back.

Fig. 5. **Waist Measure:** Around the body at the waist.

Fig. 6. **Hip Measure:** Around the body about 6 inches below the waist line.

For sleeve length the measure from arm pit to wrist straight down under the arm (inside seam).

How to take Measurements

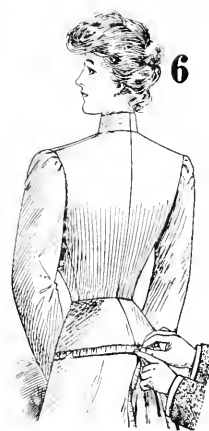
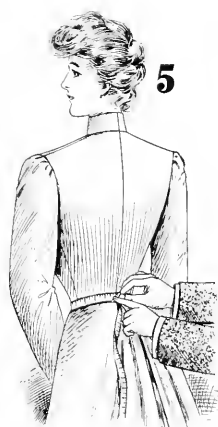
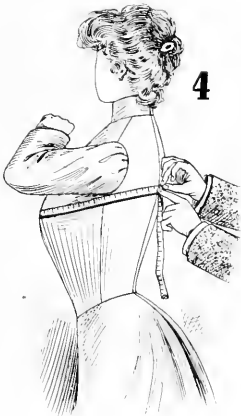
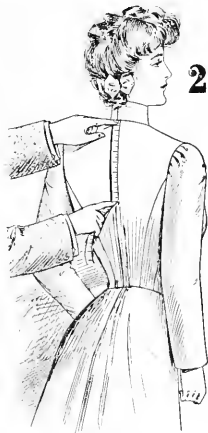
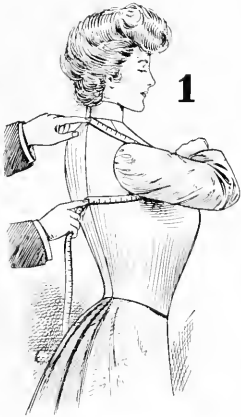

Comparative Proportions for Normal Womans' Sizes

Size is the measurement over the breast, and is 3 inches less than the Bust measure.

Bust measure is 3 inches more than the Size.

Example: Size 36 measures 39 inches Bust. Size 42 measures 45 inches Bust.

Waist measure. To find the Waist measure add $\frac{1}{2}$ of the size and $\frac{1}{4}$ of the size less 2 inches.

Example: Size 36. Half is 18 and half of this is 9, together 27 less 2 inches is 25 inches the Waist measure.

Example: Size 38. Half is 19 and half of this is $9\frac{1}{2}$, together $28\frac{1}{2}$ less 2 inches is $26\frac{1}{2}$ inches the Waist measure.

Hips measure is 4 inches more than the Size.

Example: Size 36 measures 40 inches Hips. Size 40 measures 44 inches Hips.

Neck Measure. $\frac{1}{4}$ Size and 5 inches more will give the bodice size of neck.

Example: Size 36. One-quarter of 36 is 9 and 5 inches more is 14 inches the bodice size of neck.

Example: Size 42. One-quarter of 42 is $10\frac{1}{2}$ and 5 inches more is $15\frac{1}{2}$ inches the bodice size of neck.

Back width measure. $\frac{1}{4}$ Size and $4\frac{1}{2}$ inches more will give the Back width measure.

Example: Size 36. One-quarter of 36 is 9 and $4\frac{1}{2}$ inches more is $13\frac{1}{2}$ inches the Back width measure.

Scye depth measure is 1 inch less than $\frac{1}{8}$ total height.

Example: 5 feet 6 inches height. One-eighth of 66 is $8\frac{1}{4}$ less 1 inch is $7\frac{1}{4}$ inches the Scye depth measure.

Example: 5 feet 4 inches height. One-eighth of 64 is 8 less 1 inch is 7 inches the Scye depth measure.

Back waist-length measure is 1 inch less than $\frac{1}{4}$ total height.

Example: 5 feet 6 inches height. One-quarter of 66 is $16\frac{1}{2}$ less 1 inch is $15\frac{1}{2}$ inches the Back waist-length.

Example: 5 feet 2 inches height. One-quarter of 62 is $15\frac{1}{2}$ less 1 inch is $14\frac{1}{2}$ inches the Back waist-length measure.

Sleeve length is $2\frac{1}{2}$ inches more than the Back waist-length measure or $1\frac{1}{2}$ inches more than $\frac{1}{4}$ total height.

Example: By $15\frac{1}{2}$ inches Back waist-length measure is the Sleeve length measure 18 inches.

Example: By 5 feet 6 inches height is the Sleeve length measure 18 inches.

Skirt length in front is $\frac{1}{2}$ total height and 9 inches more; side length is $\frac{1}{2}$ total height and $10\frac{1}{2}$ inches more; back length is $\frac{1}{2}$ total height and 11 inches more.

Example: 5 feet 6 inches. Skirt measure is: front 42 inches, side $43\frac{1}{2}$ inches, back 44 inches.

**Table of Proportionate Measurements
For Women**

Size		32	34	36	38	40	42	44
Height		5 Feet 2 inch.	5 Feet 4 inch.	5 Feet 6 inch.	5 Feet 6 inch.	5 Feet 6 inch.	5 Feet 6 inch.	5 Feet 6 inch.
Sleeve depth		6¾	7	7¼	7¼	7¼	7¼	7¼
Back waist length		14½	15	15½	15½	15½	15½	15½
Bust		35	37	39	41	43	45	47
Waist		22	23½	25	26½	28	29½	31
Hips		36	38	40	42	44	46	48
Neck		13	13½	14	14½	15	15½	16
Back width		12½	13	13½	14	14½	15	15½
Sleeve		17	17½	18	18	18	18	18
Skirt	Front length	40	41	42	42	42	42	42
	Side length	41½	42½	43½	43½	43½	43½	43½
	Back length	42	43	44	44	44	44	44

Systematical Outline

MEASUREMENTS

Scye depth $7\frac{1}{4}$ inches	Waist 26 inches.
Back waist-length $15\frac{1}{2}$ inches.	Hips 41 inches.
Bust 40 inches.	Sleeve 18 inches.

TO DRAFT

- | | |
|--|---|
| A Draw a straight line as from A to D. | Square out from M as represented. |
| B from A is the Scye depth Measure, in this case $7\frac{1}{4}$ inches. | N from M is $\frac{3}{8}$ inch less than the Scye depth measure, in this case $6\frac{7}{8}$ inches. |
| C from A is the Back waist-length measure, in this case $15\frac{1}{2}$ inches. | O from N is $\frac{1}{2}$ inch on line drawn from L through N. |
| D from C is 6 inches always.
Square out from A for the top line, from B for the bust line, from C for the waist line and from D for the hip line as represented. | P is the half-way between M and N. |
| E from B is the half Bust measure and 4 inches more, in this case 24 inches. | Q from I is $\frac{3}{4}$ inch. |
| F is the half-way between B and E. | R is located by drawing a line from A through Q. |
| G is the half-way between E and F. | S from G is $3\frac{1}{4}$ inches.
Square out from S as represented. |
| H is the half-way between B and F. | T from S is $1\frac{3}{4}$ inches less than the distance from G to R. |
| I from A is $5\frac{1}{2}$ inches always.
Square out from E, F, G and I as represented. | U from R is $\frac{3}{8}$ inch more than the distance from L to O on line drawn from R through T. Cut off the point at R of $\frac{3}{8}$ inch as represented. |
| J from I is $2\frac{1}{4}$ inches. | V from S is 2 inches. Connect U--V. |
| K from A is the half of the distance from B to H, in this case 3 inches.
Square out from K as represented. | W from R is 2 inches.
Square out from W as represented |
| L is located by drawing a line from A to J. | X from W is $\frac{3}{4}$ inch more than the distance from A to K, in this case $3\frac{3}{4}$ inches. |
| M from H is 2 inches. | Y is located by a line squared out from E. |
| | Z is located by a line squared out from F. |

NOTICE

To all Diagrams --- designed in this Systematical Outline --- are seam-allowances of $\frac{3}{8}$ inch allowed.

In all Diagrams --- designed in this Systematical Outline --- is the half Waist measure with 7 inches less than the half Bust measure. (See Waist Suppression on Page 20.)

In all Diagrams --- designed in this Systematical Outline --- is the half Hips measure with $\frac{1}{2}$ inch more than the half Bust measure. (See Hips Development on Page 20.)

Systematical Outline

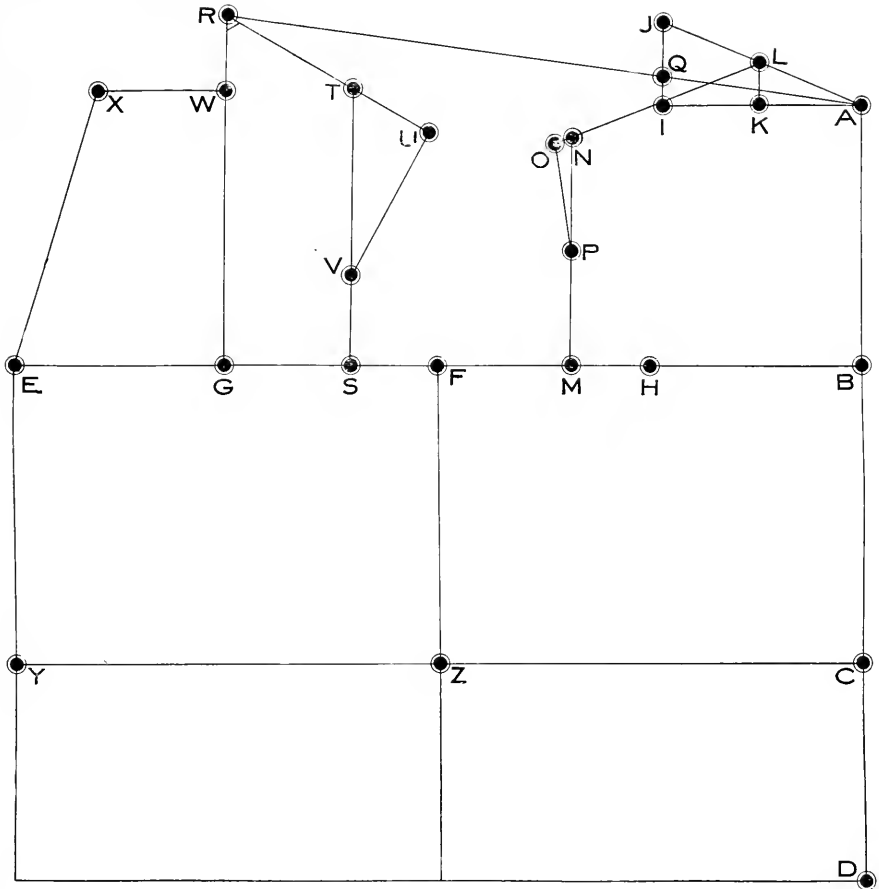

Tight-Fitting with One Dart

First lay up all points to your measure as described in Systematical Outline, then continue as follows:

1 from Z is $\frac{1}{2}$ inch.

2 from Y is $2\frac{1}{4}$ inches.

Draw lines from C to 1 and from 1 through 2 as represented for the fashionable waist line.

3 from C is 2 inches.

4 from D is $1\frac{3}{4}$ inches.

5 from 3 is 1 inch less than the distance from A to K.

6 from 4 is $\frac{3}{4}$ inch more than the distance from 3 to 5.

Shape back part as represented.

7 from 5 is $\frac{3}{4}$ inch.

8 from 6 is 1 inch.

9 from F is $\frac{3}{4}$ inch.

10 from 1 is $\frac{3}{4}$ inch.

11 is located by drawing a line from 9 through 10.

12 is the half-way between H and 9.

13 is the half-way between 7 and 10.

14 is located by drawing a line from 12 through 13.

15 from 12 is 1 inch.

16 from 13 is $\frac{1}{2}$ inch.

17 from 13 is $\frac{1}{2}$ inch.

18 from 14 is 1 inch.

19 from 14 is 1 inch.

20 from 11 is $\frac{1}{2}$ inch.

21 from P is $\frac{1}{2}$ inch.

22 from 21 is $\frac{3}{8}$ inch for seam.

23 from 15 is $\frac{3}{8}$ inch for seam.

Shape both side-gores as represented.

24 from 10 is $\frac{3}{4}$ inch, and is from 9 the same length as 9 to 10.

25 from 11 is $1\frac{1}{2}$ inches.

Shape lines 9-24-25 as represented.

26 from 2 is $1\frac{3}{4}$ inches.

27 is located by drawing a line from E through 26.

28 from G is $3\frac{1}{4}$ inches.

29 from 28 is 2 inches on line drawn parallel with line 1-2.

30 is located by drawing a line from 29 parallel with line E-26.

31 from 30 is $1\frac{1}{4}$ inches.

32 from 30 is $2\frac{3}{4}$ inches.

33 from 29 is the same length as 31 from 29.

Draw a line from 24 to 33 for the run of the waist line.

34 is located by drawing a line from 31 parallel with line E-27.

35 from 34 is $\frac{3}{4}$ inch more than the distance from 31 to 32.

36 from 27 is $\frac{3}{8}$ inch.

Shape the center of front; finish on the front the neck gorge, shoulder, armhole and dart as represented.

37 from 10 is the same length as 25 from 24.

38 from 35 is $1\frac{1}{4}$ inches.

39 from 31 is the same length as 38 from 33.

Finish the bottom as represented.

WAIST SUPPRESSION.

By applying this System the half Waist measure is with 7 inches less than the half Bust measure. For instance, 20 half Bust has 13 half Waist measure, 24 half Bust has 17 half Waist measure, 17 half Bust has 10 half Waist measure, etc.

It is very easy to change the draft to your actual Waist measure, by following the instructions as below:

The difference between the half actual Waist measure and the half systematical Waist measure is to be added to by larger actual waist measure and to be taken off by smaller actual waist measure at the front dart.

For instance by drafting a pattern with 40 bust measure the half of the systematical waist measure will be 13 inches, and if the half of your actual waist measure is $13\frac{1}{2}$ inches, then you have to take out at the front dart $\frac{1}{2}$ inch less: in this case take out on the draft from 30 to 32 only $2\frac{1}{4}$ inches.

By drafting a pattern of 44 Bust measure the half of the systematical waist measure will be 15 inches, and if the half of your actual waist measure is only $14\frac{1}{2}$ inches then you have to take out at the front dart $\frac{1}{2}$ inch more; in this case take out $3\frac{1}{4}$ inches on draft from 30 to 32.

HIPS DEVELOPMENT.

By applying this System the half Hips measure is with $\frac{1}{2}$ inch more than the half Bust measure. For instance 20 half Bust has $20\frac{1}{2}$ half Hips measure, 24 half Bust has $24\frac{1}{2}$ half Hips measure, etc.

It is very easy to change the draft to your actual Hips measure by following the instruction as below:

The difference between the half actual Hips measure and the half systematical Hips measure is to be added to by larger actual Hips measure and to be taken off by smaller actual Hips measure on the hip line equally divided at points 8, 19, 18, 25 and 20.

For instance by drafting a pattern of 40 Bust measure the half of the systematical Hips measure will be $20\frac{1}{2}$ inches, and if the half of your actual Hips measure is $22\frac{1}{2}$ inches, then you have to allow 2 inches on the hip line equally divided at points 8, 19, 18, 25 and 20, and vice-versa.

Tight-Fitting with One Dart

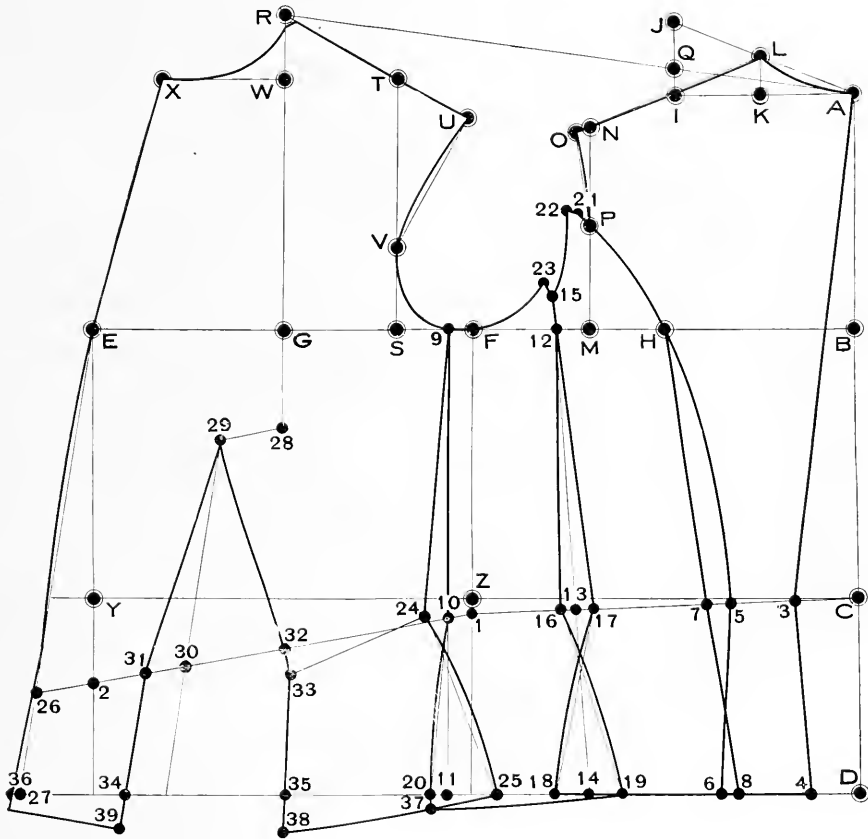

Tight-Fitting with Two Darts

First lay up all points to your measure as described in Systematical Outline, then continue as follows:

1 from Z is $\frac{1}{2}$ inch.

2 from Y is $2\frac{1}{4}$ inches.

Draw lines from C to 1 and from 1 through 2 as represented for the fashionable waist line.

3 from C is 2 inches.

4 from D is $1\frac{3}{4}$ inches.

5 from 3 is 1 inch less than the distance from A to K.

6 from 4 is $\frac{3}{4}$ inch more than the distance from 3 to 5.

Shape back part as represented.

7 from 5 is $\frac{3}{4}$ inch.

8 from 6 is 1 inch.

9 from F is $\frac{3}{4}$ inch.

10 from 1 is $\frac{3}{4}$ inch.

11 is located by drawing a line from 9 through 10.

12 is the half-way between H and 9.

13 is the half-way between 7 and 10.

14 is located by drawing a line from 12 through 13.

15 from 12 is 1 inch.

16 from 13 is $\frac{1}{2}$ inch.

17 from 13 is $\frac{1}{2}$ inch.

18 from 14 is 1 inch.

19 from 14 is 1 inch.

20 from 11 is $\frac{1}{2}$ inch.

21 from P is $\frac{1}{2}$ inch.

22 from 21 is $\frac{3}{8}$ inch for seam.

23 from 15 is $\frac{3}{8}$ inch for seam.

Shape both side-gores as represented.

24 from 10 is $\frac{3}{4}$ inch, and is from 9 the same length as 9 to 10.

25 from 11 is $1\frac{1}{2}$ inches.

Shape lines 9-24-25 as represented.

26 from 2 is $1\frac{3}{4}$ inches.

27 is located by drawing a line from E through 26.

28 from G is $3\frac{1}{4}$ inches.

29 is located by drawing a line through 31 parallel with line 1-2.

30 is located by drawing a line from 29 through 28.

31 is the half-way between 29 and 30.

32 is the half-way between 29 and 31.

33 is located by drawing a line from 32 parallel with line 29--26.

34 from 33 is $\frac{5}{8}$ inch.

35 from 33 is $\frac{5}{8}$ inch.

36 from 32 is the same length as 34 from 32.

37 from 35 is 1 inch less than the distance from A to K.

38 from 37 is 2 inches.

39 from 31 is the same length as 37 from 31.

Draw a line from 24 to 39 for the run of the waist line.

40 is located by drawing a line from 34 parallel with line 26--27.

41 from 40 is $1\frac{1}{4}$ inches.

42 from 41 is $\frac{1}{4}$ inch more than the distance from 35 to 37.

43 from 42 is $2\frac{1}{2}$ inches.

Shape the center of front; finish on the front the neck, shoulder, armhole and darts as represented.

44 from 10 is the same length as 25 from 24.

45 from 43 is $1\frac{1}{4}$ inches.

46 from 37 is the same length as 45 from 39.

47 from 27 is $\frac{3}{8}$ inch.

Finish the bottom as represented.

Tight-Fitting with Two Darts

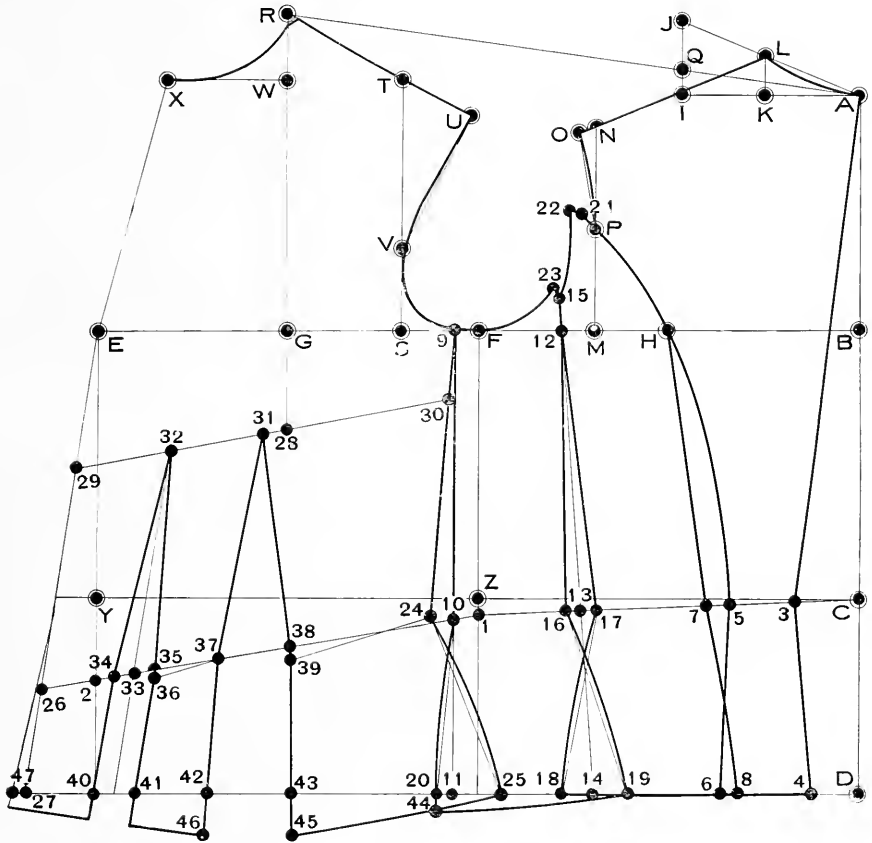

Tight-Fitting Back and Semi-Fitting Front

First lay up all points to your measure as described in Systematical Outline, then continue as follows:

1 from Z is $\frac{1}{2}$ inch.

2 from Y is $2\frac{1}{4}$ inches.

Draw lines from C to 1 and from 1 through 2 as represented for the fashionable waist line.

3 from C is 2 inches.

4 from D is $1\frac{3}{4}$ inches.

5 from 3 is 1 inch less than the distance from A to K.

6 from 4 is $\frac{3}{4}$ inch more than the distance from 3 to 5.

Shape back part as represented.

7 from 5 is $\frac{3}{4}$ inch.

8 from 6 is 1 inch.

9 from F is $\frac{3}{4}$ inch.

10 from 1 is $\frac{3}{4}$ inch.

11 is located by drawing a line from 9 through 10.

12 is the half-way between H and 9.

13 is the half-way between 7 and 10.

14 is located by drawing a line from 12 through 13.

15 from 12 is 1 inch.

16 from 13 is $\frac{1}{2}$ inch.

17 from 13 is $\frac{1}{2}$ inch.

18 from 14 is 1 inch.

19 from 14 is 1 inch.

20 from 11 is $\frac{1}{2}$ inch.

21 from P is $\frac{1}{2}$ inch.

22 from 21 is $\frac{3}{8}$ inch for seam.

23 from 15 is $\frac{3}{8}$ inch for seam.

Shape both side-gores as represented.

24 from 10 is $\frac{3}{4}$ inch, and is from 9 the same length as 9 to 10.

25 from 11 is $1\frac{1}{2}$ inches.

Shape lines 9-24-25 as represented.

26 from 2 is 2 inches.

Draw line from E through 26.

27 from G is $3\frac{1}{4}$ inches.

28 from 27 is 2 inches on line drawn parallel with line 1-2.

29 is located by drawing a line from 28 parallel with line E-26.

30 is located by drawing a line from 28 through 29.

31 from 29 is $\frac{1}{2}$ inch.

32 from 30 is $\frac{3}{8}$ inch.

33 from 29 is $2\frac{1}{2}$ inches.

34 from 28 is the same length as 31 from 28.

Draw a line from 24 to 34 for the run of waist line.

35 from 30 is $3\frac{1}{4}$ inches.

Finish the front as represented.

36 from 10 is the same length as 25 from 24.

37 from 35 is $1\frac{1}{4}$ inches.

38 from 31 is the same length as 37 from 34.

Finish the bottom as represented.

Tight-Fitting Back and Semi-Fitting Front

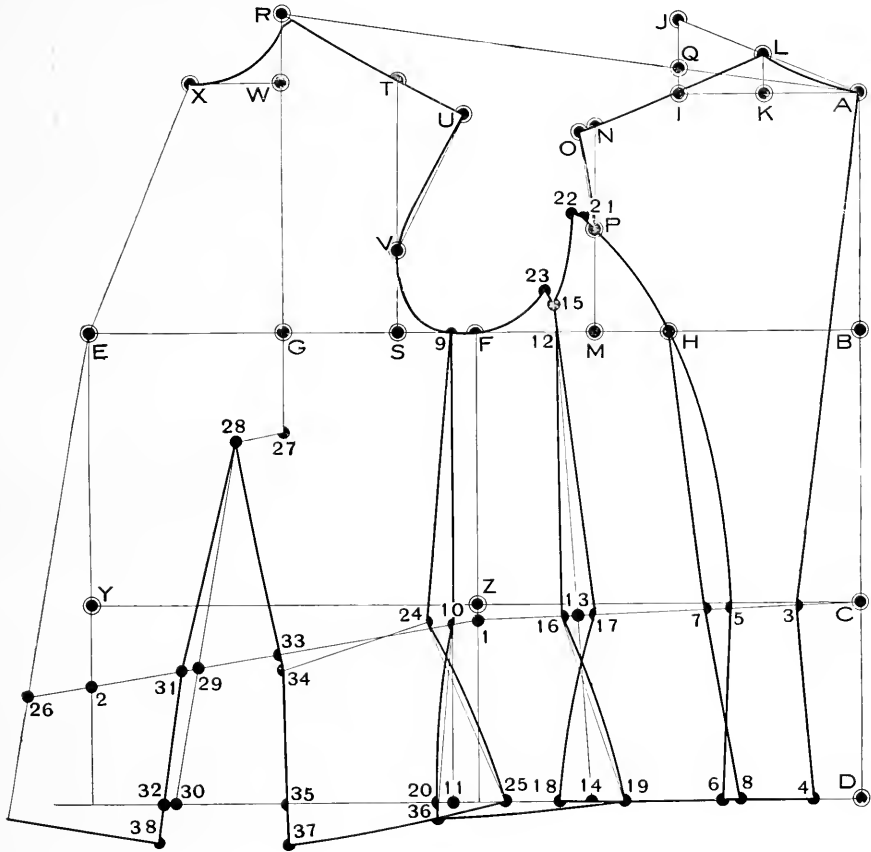

Blouse

First lay up all points to your measure as described in Systematical Outline, then continue as follows :

1 from Z is $\frac{1}{2}$ inch.

2 from Y is $2\frac{1}{4}$ inches.

Draw lines from C to 1 and from 1 to 2 for the fashionable waist line as represented.

3 from C is 2 inches.

4 is the half-way between F and M.

5 from 4 is $\frac{3}{4}$ inch.

6 from 1 is 4 inches

Finish the back as represented.

7 from 4 is $\frac{3}{4}$ inch.

8 is located by drawing a line from X through E, and is from E the same length as

2 from E.

Finish the front as represented.

Blouse

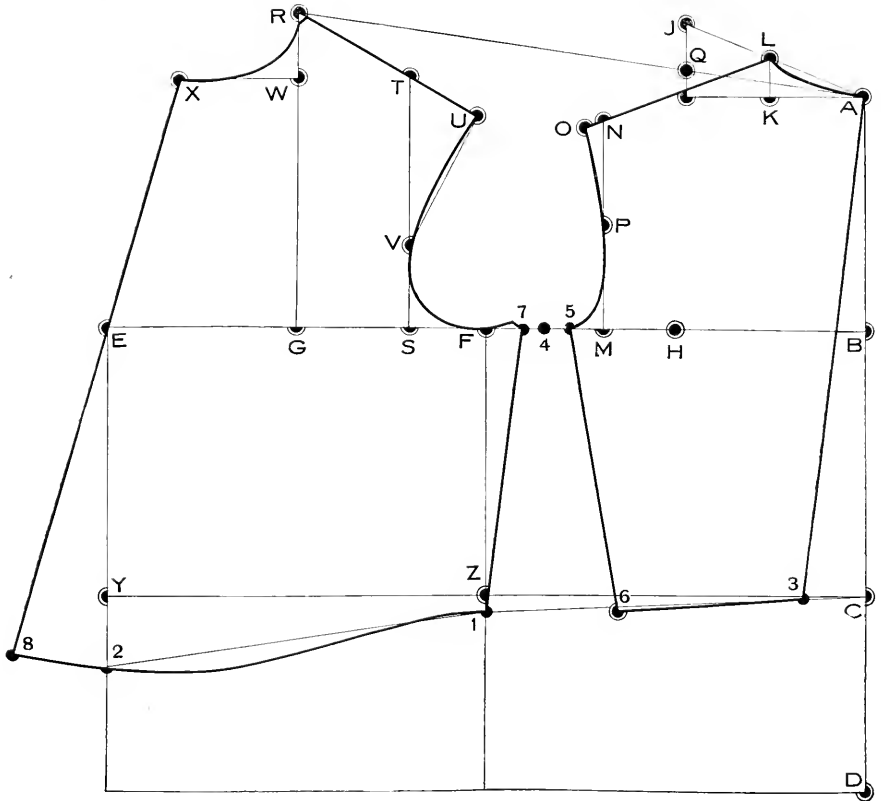

Basque or Tunic Skirt

Measurers

Waist 26 inches. Hips 42 inches.

To Draft

- A. Draw a straight line as from A to 1.
 B from A is the half Waist measure, in this case 13 inches,
 C from B is 6 inches.
 D from A is 2 inches.
 E from D is 1 inch on line squared down from D.
 F is located by a line swept from B, pivoting at A.
 G is located by a line swept from C, pivoting at A, and is from C $\frac{1}{2}$ inch more than the half Hips measure, in this case $21\frac{1}{2}$ inches.
 B-C is the front line, and F-G is the back line.

To Lengthen the Skirt

- 1 is located by drawing a line from B through C to the length measure as desired.
 2 is located by drawing a line from F through G to the length measure as desired.
 3 is the center between B and F.
 4 from 1 is $1\frac{1}{2}$ inches less than the half distance between 1 and 2, and is from 3 the length as desired.
 5 is located by drawing a line from 3 to 4.
 6 from 5 is 1 inch.
 7 from 4 is the half difference between the width of bottom from 1 to 2 and the width of bottom as required.
 8 from 4 is the half difference between the width of bottom from 1 to 2 and the width of bottom as required.

Cut out the space 6-7-8-6 as represented, and join together 6-7 with 6-8 to get the Dart on the waist line as represented on the bottom draft 3-6-3.

NOTICE: On this draft are seams **not** allowed.

Basque or Tunic Skirts

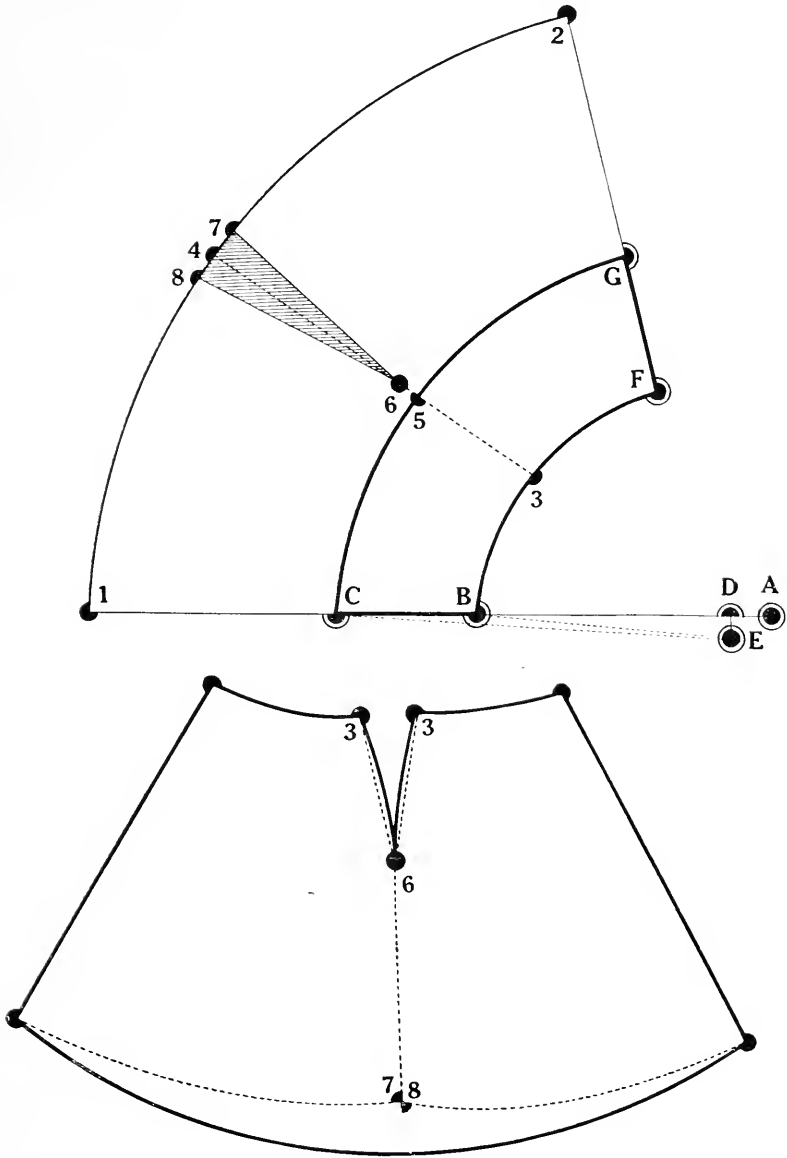

Tight-Fitting Eton with One Dart

First lay up all points to measure as described in Systematical Outline, then continue as follows:

1 from Z is $\frac{1}{2}$ inch.

2 from Y is $2\frac{1}{4}$ inches.

Draw lines from C to 1 and from 1 through 2 for the fashionable waist line as represented.

3 from C is 2 inches.

4 is the half-way between F and M.

5 from 4 is $\frac{3}{4}$ inch.

6 from 1 is 4 inches.

Finish the back as represented.

7 from 4 is $\frac{3}{4}$ inch.

8 from 2 is $1\frac{3}{4}$ inches.

Draw a line from E to 8.

9 from G is $3\frac{1}{4}$ inches.

10 from 9 is $1\frac{1}{2}$ inches on line drawn from 9 parallel with line 1-2.

11 is located by drawing a line from 10 parallel with line E-8.

12 from 11 is $1\frac{1}{4}$ inches.

13 from 11 is $2\frac{3}{4}$ inches.

14 from 10 is the same length as 12 from 10.

Finish the Front as represented.

If you wish to have a close back, take off $\frac{3}{8}$ inch seam at the back center from A to 3.

Tight-Fitting Eton with One Dart

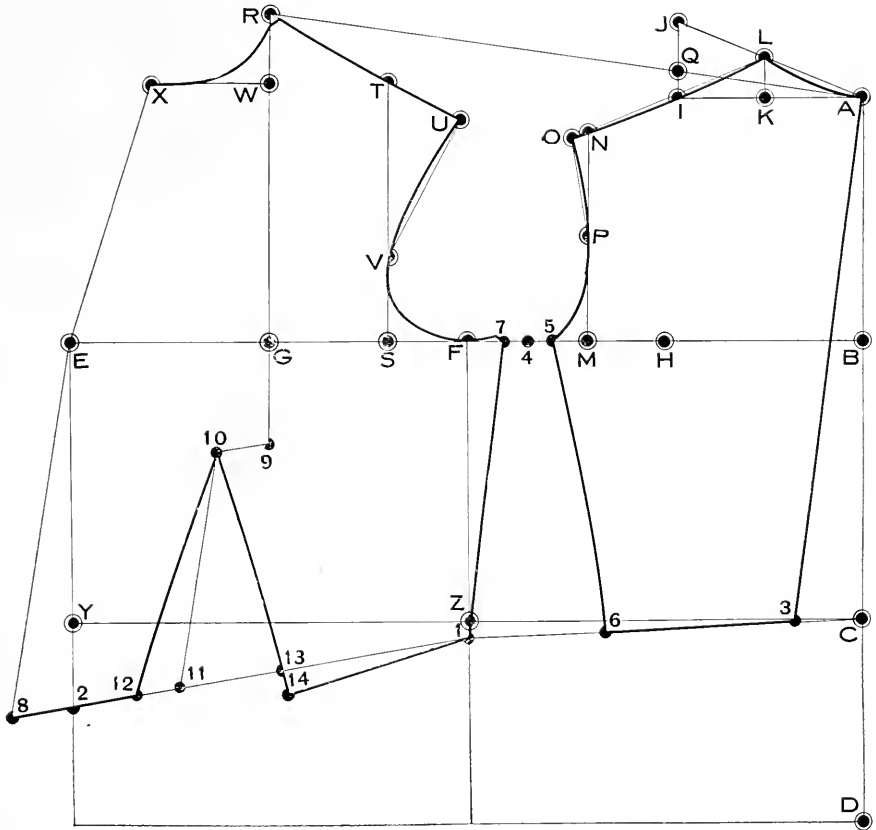

Tight-Fitting Eton with Two Darts

First lay up all points to your measure as described in Systematical Outline, then continue as follows:

1 from Z is $\frac{1}{2}$ inch.

2 from Y is $2\frac{1}{4}$ inches.

Draw lines from C to 1 and from 1 to 2 for the fashionable waist line as represented.

3 from C is 2 inches.

4 is the half-way between F and M.

5 from 4 is $\frac{3}{4}$ inches.

6 from 1 is 4 inches.

Finish the back as represented.

7 from 4 is $\frac{3}{4}$ inch.

8 from 2 is $1\frac{3}{4}$ inches.

Draw a line from E to 8.

9 from G is $3\frac{1}{4}$ inches.

10 is located by drawing a line through 9 parallel with line 1-2.

11 is located by drawing a line from 10 through 9.

12 is the half-way between 10 and 11.

13 is the half-way between 10 and 12.

14 is located by drawing a line from 13 parallel with line E-8.

15 from 14 is $\frac{5}{8}$ inch.

16 from 14 is $\frac{5}{8}$ inch, and is from 13 the same length as 15 from 13.

17 from 16 is 1 inch less than the distance between A and K.

18 from 17 is 2 inches.

19 from 12 is the same length as 17 from 12.

Finish the front as represented.

Tight-Fitting Eton with Two Darts

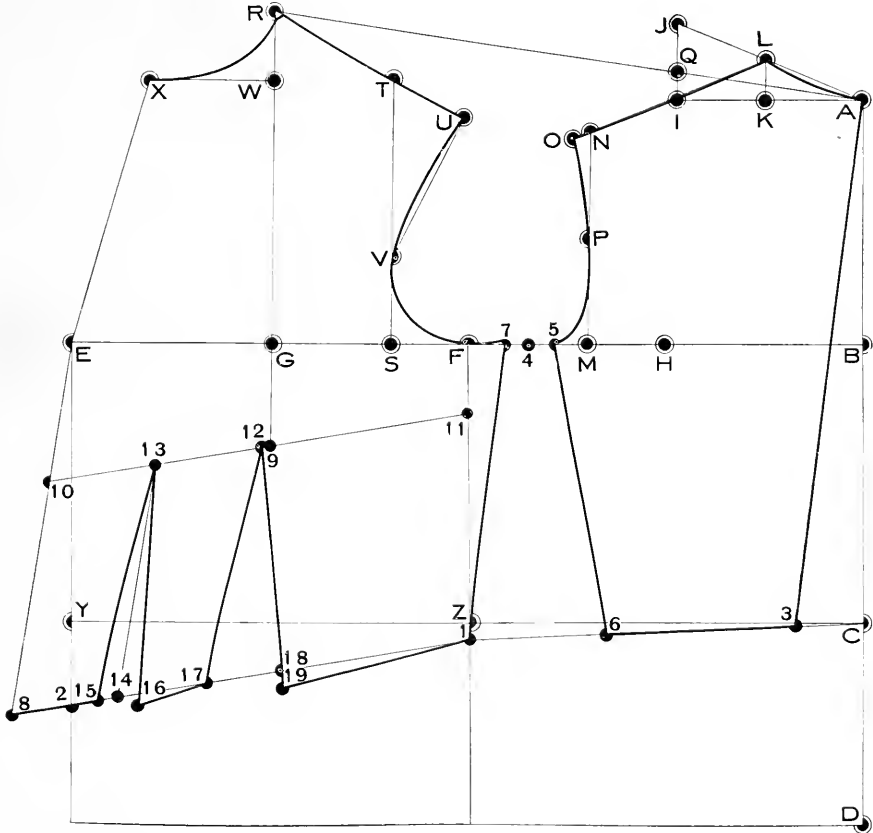

Tight-Fitting Eton with One Side-Gore

First lay up all points to your measure as described in Systematical Outline, then continue as follows:

1 from Z is $\frac{1}{2}$ inch.

2 from Y is $2\frac{1}{4}$ inches.

Draw lines from C to 1 and from 1 through 2 for the fashionable waist line as represented.

3 from C is 2 inches.

4 from P is $\frac{3}{4}$ inch.

5 from H is $\frac{3}{4}$ inch.

6 from 3 is the same as K from A.

Finish the back part as represented.

7 from 6 is $\frac{3}{4}$ inch.

8 from 4 is $\frac{1}{2}$ inch.

9 from 8 is $\frac{3}{8}$ inch for seam.

10 from F is $1\frac{1}{2}$ inches.

11 from 1 is $2\frac{1}{4}$ inches.

Finish the side gore as represented.

12 from 10 is $\frac{3}{4}$ inch.

13 from 1 is $\frac{1}{4}$ inch.

14 from 2 is $1\frac{3}{4}$ inches.

Draw a line from E to 14.

15 from G is $3\frac{1}{4}$ inches.

16 from 15 is $1\frac{1}{2}$ inches on line drawn parallel with line 1-2.

17 is located by drawing a line from 16 parallel with line E-14.

18 from 17 is $1\frac{1}{4}$ inches.

19 from 17 is $2\frac{3}{4}$ inches.

20 from 16 is the same length as 18 from 16.

Finish the front as represented.

Tight-Fitting Eton with One Side-Gore

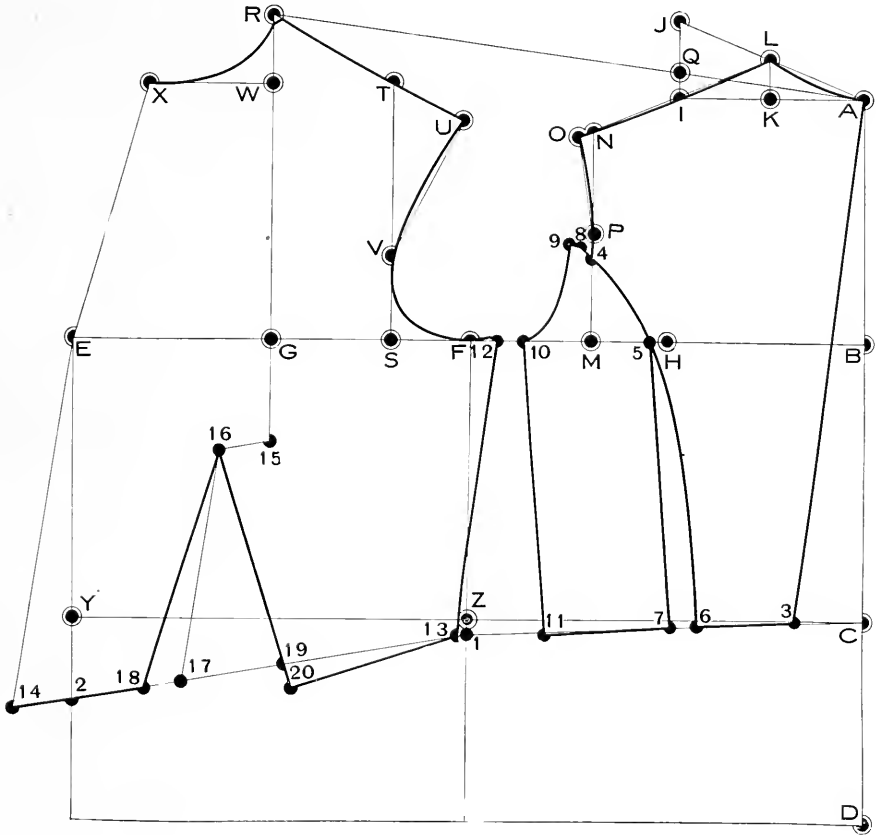

Tight-Fitting Eton with French Seam

First lay up all points to your measure as described in Systematical Outline, then continue as follows:

1 from Z is $\frac{1}{2}$ inch.

2 from Y is $2\frac{1}{4}$ inches.

Draw lines from C to 1 and from 1 through 2 for the fashionable waist line as represented.

3 from C is 2 inches.

4 from O is $\frac{3}{4}$ inch.

5 is the half-way between L and 4, or located accordingly style and taste.

6 from 3 is the same as K from A.

7 is located by drawing a line from 5 to 6 as represented.

8 from 6 is $\frac{3}{4}$ inch.

9 from 5 is $\frac{3}{8}$ inch and is $\frac{1}{4}$ inch higher from the line L-O.

10 from 4 is $\frac{3}{8}$ inch and is $\frac{1}{4}$ inch higher from line L-4.

11 from P is $\frac{3}{4}$ inch.

12 from F is $1\frac{1}{2}$ inches.

13 from 1 is $2\frac{1}{4}$ inches.

Finish the back part and the back side gore as represented.

14 from 12 is $\frac{3}{4}$ inch.

15 from 1 is $\frac{1}{4}$ inch.

16 from 2 is $1\frac{3}{4}$ inches.

Draw a line from E to 16.

17 from G is $3\frac{1}{4}$ inches.

18 from 17 is $1\frac{1}{2}$ inches on line drawn parallel with line 1-2.

19 is located by drawing a line from 18 parallel with line E-16.

20 from 19 is $1\frac{1}{4}$ inches.

21 from 19 is $2\frac{3}{4}$ inches.

22 from 18 is the same length as 20 from 18.

23 from R is the same length as L to 5.

Draw a line from 23 to 18.

24 from 23 is $\frac{3}{4}$ inch.

Draw a line from 24 parallel with line 23-18 as represented.

Finish the front as represented.

Tight-Fitting Eton with French Seam

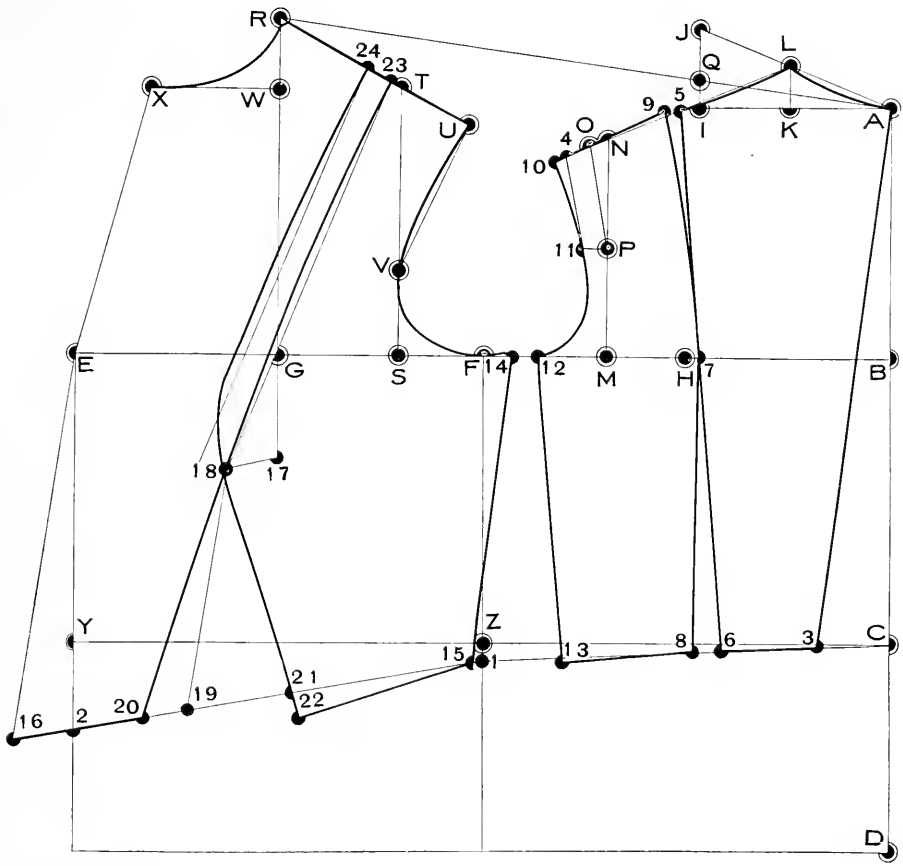

Tight-Fitting French Seam

First lay up all points to your measure as described in Systematical Outline, then continue as follows:

1 from Z is $\frac{1}{2}$ inch.

2 from Y is $2\frac{1}{4}$ inches.

Draw lines from C to 1 and from 1 through 2 for the fashionable waist line as represented.

3 from C is 2 inches.

4 from D is $1\frac{3}{4}$ inches.

5 from O is $\frac{3}{4}$ inch.

6 from P is $\frac{3}{4}$ inch.

Draw a line from 5 to 6.

7 is the half-way between 5 and L, or make the width to style or taste.

8 from 3 is 1 inch less than A to K.

9 is located by drawing a line from 7 to 8 as represented.

10 from 4 is $\frac{3}{4}$ inch more than 3 to 8.

11 from 8 is $\frac{3}{4}$ inch.

12 from 10 is 1 inch.

13 from F is $\frac{3}{4}$ inch.

14 from 1 is $\frac{3}{4}$ inch.

15 is located by drawing a line from 13 through 14.

16 is the half-way between 9 and 13.

17 is the half-way between 11 and 14.

18 is located by drawing a line from 16 through 17.

19 from 17 is $\frac{1}{2}$ inch.

20 from 17 is $\frac{1}{2}$ inch.

21 from 18 is 1 inch.

22 from 18 is 1 inch.

23 from 15 is $\frac{1}{2}$ inch.

24 from 7 is $\frac{3}{8}$ inch, and is $\frac{1}{4}$ inch higher from the line L-5.

25 from 5 is $\frac{3}{8}$ inch, and is from 6 the same length as O from P.

26 from 16 is 1 inch.

27 from 26 is $\frac{3}{8}$ inch for seam.

Finish the back and side gores as represented.

28 from 14 is $\frac{3}{4}$ inch, and is from 13 the same length as 14 from 13.

29 from 15 is $1\frac{1}{2}$ inches.

30 from 2 is $1\frac{3}{4}$ inches.

31 is located by drawing a line from E through 30.

32 from 31 is $\frac{3}{8}$ inch.

33 from G is $3\frac{1}{4}$ inches.

34 from 33 is 2 inches on line drawn from 33 parallel with line 1-2.

35 is located by drawing a line from 34 parallel with line E--30.

36 from 35 is $1\frac{1}{4}$ inches.

37 from 35 is $2\frac{3}{4}$ inches.

38 from 34 is the same length as 36 from 34.

39 is located by drawing a line from 36 parallel with line E--31.

40 from 39 is $4\frac{3}{4}$ inches.

41 from R is the same width as L to 7.

Draw a line from 41 to 34.

42 from 41 is $\frac{3}{4}$ inch for seams.

Draw a line from 42 parallel with line 41-34.

43 from 14 is the same length as 29 from 28.

44 from 40 is $1\frac{1}{4}$ inches.

45 from 36 is the same length as 44 from 38.

Finish the front as represented.

Tight-Fitting French Seam

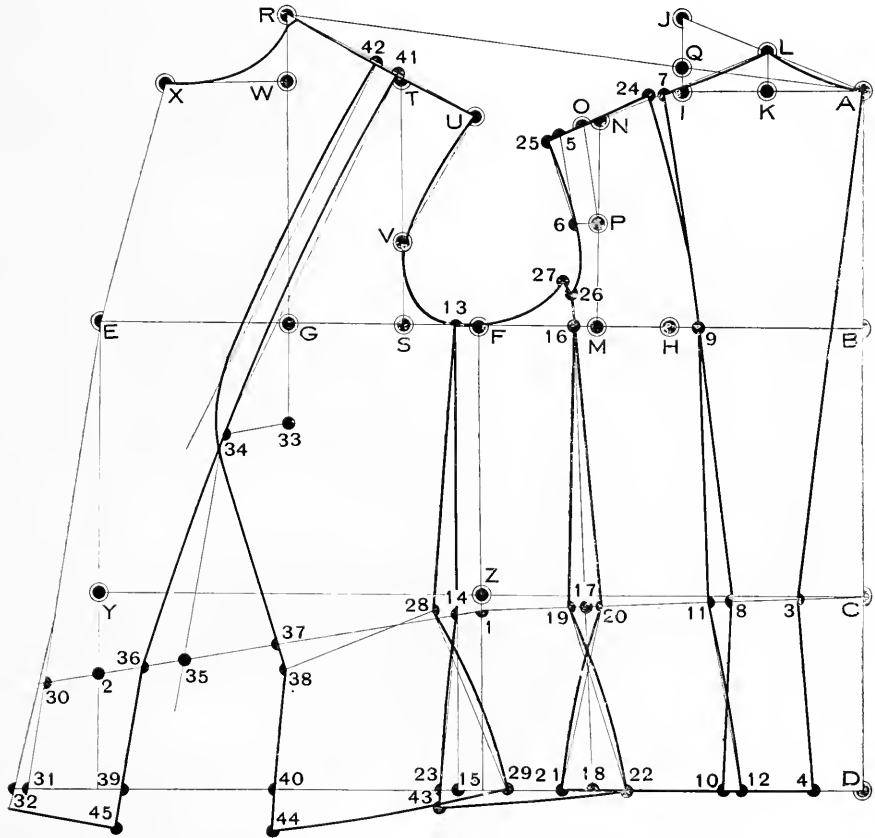

Tight-Fitting Double French Seam

First lay up all points to your measure as described in Systematical Outline, then continue as follows:

- 1 from Z is $\frac{1}{2}$ inch.
- 2 from Y is $2\frac{1}{4}$ inches.
- Draw lines from C to 1 and from 1 through 2 for the fashionable waist line as represented.
- 3 from C is 2 inches.
- 4 from D is $1\frac{3}{4}$ inches.
- 5 from O is $\frac{3}{4}$ inch.
- 6 from P is $\frac{3}{4}$ inch.
- Draw line from 5 to 6.
- 7 from L is the half of distance from A to K.
- 8 from 3 is the half of distance from A to K.
- 9 is located by drawing a line from 7 to 8.
- 10 from 4 is $\frac{3}{4}$ inch more than the distance from 3 to 8.
- 11 from 8 is $\frac{1}{4}$ inch.
- 12 from 10 is $\frac{1}{2}$ inch.
- 13 from 5 is $\frac{1}{2}$ inch more than L to 7.
- 14 from 11 is $\frac{1}{2}$ inch more than 3 to 8.
- 15 is located by drawing a line from 13 to 14.
- 16 from 12 is $\frac{3}{4}$ inch more than 11 to 14.
- Finish the middle back part as represented.
- 17 from 14 is $\frac{1}{2}$ inch.
- 18 from 16 is $\frac{1}{2}$ inch.
- 19 from F is $\frac{3}{4}$ inch.
- 20 from 1 is $\frac{3}{4}$ inch.
- 21 is located by drawing a line from 19 through 20.
- 22 is the half-way between 15 and 19.
- 23 is the half-way between 17 and 20.
- 24 is located by drawing a line from 22 through 23.
- 25 from 23 is $\frac{1}{2}$ inch.
- 26 from 23 is $\frac{1}{2}$ inch.
- 27 from 24 is 1 inch.
- 28 from 24 is 1 inch.
- 29 from 21 is $\frac{1}{2}$ inch.
- 30 from 13 is $\frac{3}{8}$ inch, and is $\frac{1}{4}$ inch higher from line L-5.
- 31 from 5 is $\frac{3}{8}$ inch, and is from 6 the same length as O from P.
- 32 from 22 is 1 inch.
- 33 from 32 is $\frac{3}{8}$ inch for seam.
- Finish the side gores as represented.

- 34 from 20 is $\frac{3}{4}$ inch, and is from 19 the same length as 20 from 19.
- 35 from 21 is $1\frac{1}{2}$ inches.
- 36 from 2 is $1\frac{3}{4}$ inches.
- 37 is located by drawing a line from E through 36.
- 38 from 37 is $\frac{3}{8}$ inch.
- 39 from G. is $3\frac{1}{4}$ inches.
- 40 is located by drawing a line through 39 parallel with line 1-2.
- 41 is located by drawing a line from 40 through 39.
- 42 is the half-way between 40 and 41.
- 43 is the half-way between 40 and 42.
- 44 is located by drawing a line from 43 parallel with line E-36.
- 45 from 44 is $\frac{5}{8}$ inch.
- 46 from 44 is $\frac{5}{8}$ inch, and is from 43 the same length as 45 from 43.
- 47 is located by drawing a line from 45 parallel with line E-37.
- 48 from 47 is $1\frac{1}{4}$ inches.
- 49 from 46 is 1 inch less than the distance from A to K.
- 50 from 48 is $\frac{1}{4}$ inch more than the distance from 46 to 49.
- 51 from 49 is 2 inches.
- 52 from 42 is the same length as 49 from 42.
- 53 from 50 is $2\frac{1}{4}$ inches.
- 54 from R is $\frac{3}{8}$ inch more than the distance from L to 7.
- Draw line from 54 to 43.
- 55 from 54 is $\frac{3}{4}$ inch for seams.
- Draw a line from 55 parallel with line 54-43.
- 56 from U is the same width as 30 to 31.
- 57 from 56 is $\frac{3}{4}$ inch for seams.
- Draw a line from 57 to 42.
- Draw a line from 56 parallel with line 57-42.
- 58 from 20 is the same length as 35 from 34.
- 59 from 53 is $1\frac{1}{4}$ inches.
- 60 from 49 is the same length as 59 from 52.
- 61 from 48 is the same length as 60 from 50.
- 62 from 45 is the same length as 61 from 46.
- Finish the front as represented.
- By cutting out the pattern allow extra $\frac{3}{8}$ inch for seams all way down at lines 7--8--10, and 7--11--12.

Tight-Fitting Double French Seam

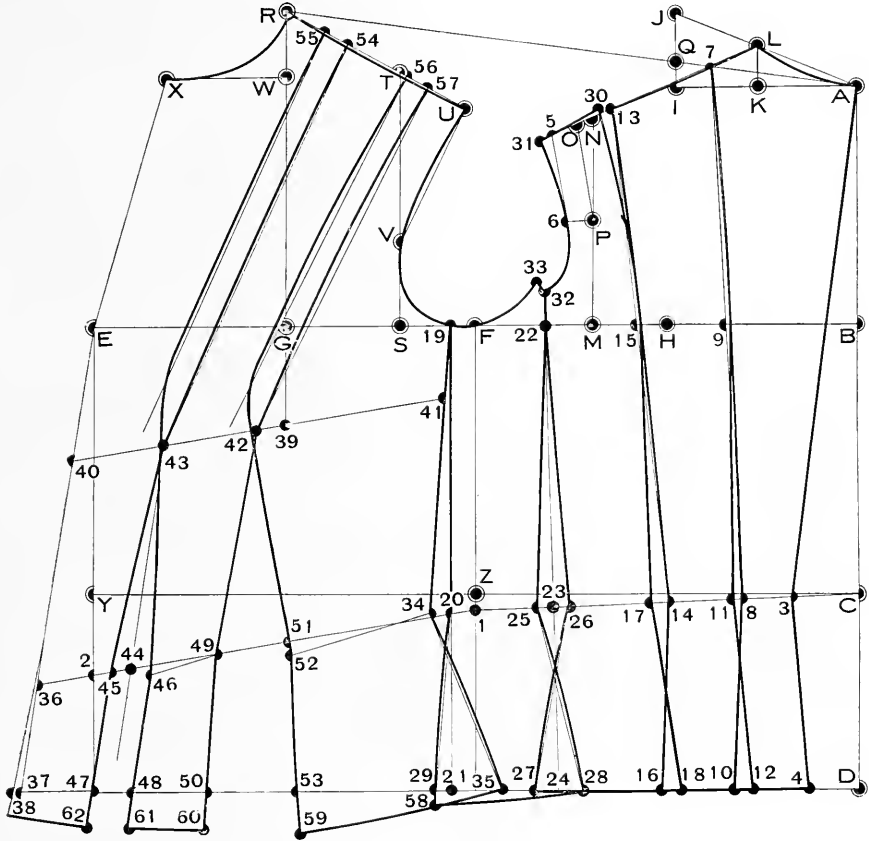

Tight-Fitting 18 Gores

First lay up all points to your measure as described in Systematical Outline, then continue as follows:

- 1 from Z is $\frac{1}{2}$ inch.
- 2 from Y is $2\frac{1}{4}$ inches.
- Draw lines from C to 1 and from 1 through 2 for the fashionable waist line as represented.
- 3 from C is 2 inches.
- 4 from D is $1\frac{3}{4}$ inches.
- 5 from O is $\frac{3}{4}$ inch.
- 6 from P is $\frac{3}{4}$ inch.
- Draw a line from 5 to 6.
- 7 from L is the half of distance from A to K.
- 8 from 3 is the half of distance from A to K.
- 9 is located by drawing a line from 7 to 8.
- 10 from 4 is $\frac{3}{8}$ inch more than the distance from 3 to 8.
- Finish the back part as represented.
- 11 from 8 is $\frac{1}{4}$ inch.
- 12 from 10 is $\frac{1}{2}$ inch.
- 13 from 5 is $\frac{1}{2}$ inch more than L to 7.
- 14 from 11 is the same width as 3 to 8.
- 15 is located by drawing a line from 13 to 14.
- 16 from 12 is $\frac{3}{4}$ inch more than 11 to 14.
- Finish the middle back part as represented.
- 17 from 14 is $\frac{1}{2}$ inch.
- 18 from 16 is $\frac{1}{2}$ inch.
- 19 from F is $1\frac{1}{4}$ inches.
- 20 from 1 is $1\frac{1}{4}$ inches.
- 21 is located by drawing a line from 19 through 20.
- 22 is one-third of 15-19.
- 23 is the half-way between 15-22.
- 24 is one-third of 17-20.
- 25 is the half-way between 17-24.
- 26 is located by drawing a line from 22 through 24.
- 27 is located by drawing a line from 23 through 25.
- 28 from 25 is $\frac{3}{8}$ inch.
- 29 from 25 is $\frac{3}{8}$ inch.
- 30 from 24 is $\frac{1}{4}$ inch.
- 31 from 24 is $\frac{1}{4}$ inch.
- 32 from 20 is $\frac{1}{4}$ inch.
- 33 from 27 is $\frac{1}{2}$ inch.
- 34 from 27 is $\frac{1}{2}$ inch.
- 35 from 26 is $\frac{1}{2}$ inch.
- 36 from 26 is $\frac{1}{2}$ inch.
- 37 from 21 is $\frac{1}{4}$ inch.
- 38 from 13 is $\frac{3}{8}$ inch, and is $\frac{1}{4}$ inch higher from line L-5.
- 39 from 5 is $\frac{3}{8}$ inch, and is from 6 the same length as O from P.
- 40 from 23 is 1 inch.
- Finish the side gores as represented.

- 41 from 20 is $\frac{1}{4}$ inch, and is from 19 the same length as 32 from 19.
- 42 from 21 is 1 inch.
- 43 from 2 is $1\frac{3}{4}$ inches.
- 44 is located by drawing a line from E through 43.
- 45 from 44 is $\frac{3}{8}$ inch.
- 46 from G is $3\frac{1}{4}$ inches.
- 47 is located by drawing a line through 46 parallel with line 1-2.
- 48 is located by drawing a line from 47 through 46.
- 49 is the half-way between 47 and 48.
- 50 is the half-way between 46 and 47.
- 51 is the half-way between 48 and 49.
- 52 is located by drawing a line from 50 parallel with line E-43.
- 53 from 52 is $\frac{3}{8}$ inch.
- 54 from 52 is $\frac{3}{8}$ inch, and is from 50 the same length as 53 from 50.
- 55 is located by drawing a line from 53 parallel with line E-44.
- 56 from 55 is $1\frac{1}{4}$ inches.
- 57 from 54 is 1 inch less than the distance from A to K.
- 58 from 56 is $\frac{1}{4}$ inch more than 57 from 54.
- 59 from 57 is $1\frac{1}{2}$ inches, and is from 49 the same length as 57 from 49.
- 60 from 58 is $1\frac{3}{4}$ inches.
- 61 is the half-way between 41 and 59.
- 62 is located by drawing a line from 51 through 61.
- 63 from 61 is $\frac{1}{4}$ inch.
- 64 from 61 is $\frac{1}{4}$ inch.
- 65 from 62 is $\frac{1}{4}$ inch.
- 66 from R is $\frac{3}{8}$ inch more than the distance from L to 7.
- Draw a line from 66 to 50.
- 67 from 66 is $\frac{3}{4}$ inch for seams.
- Draw a line from 67 parallel with line 66-50.
- 68 from U is the same width as 38 to 39.
- 69 from 68 is $\frac{3}{4}$ inch for seams.
- Draw a line from 69 to 49.
- Draw a line from 68 parallel with line 69-49.
- 70 is the half-way between S and V.
- 71 from 32 is the same length as 42 from 41.
- 72 from 61 is $1\frac{1}{4}$ inches.
- 73 from 57 is the same length as 72 from 59.
- Finish the front as represented.
- By cutting out the pattern allow extra for seams all way down as follows:
 - $\frac{3}{8}$ inch at line 7-9-8-10.
 - $\frac{3}{8}$ inch at line 7-9-11-12.
 - $\frac{3}{8}$ inch at line 70-51-63-65.
 - $\frac{3}{8}$ inch at line 70-51-64-62.
 - $\frac{1}{4}$ inch at line 19-32-71.
 - $\frac{1}{4}$ inch at line 22-31-35.
 - $\frac{1}{4}$ inch at line 40-23-29-32.

Tight-Fitting 18 Gores

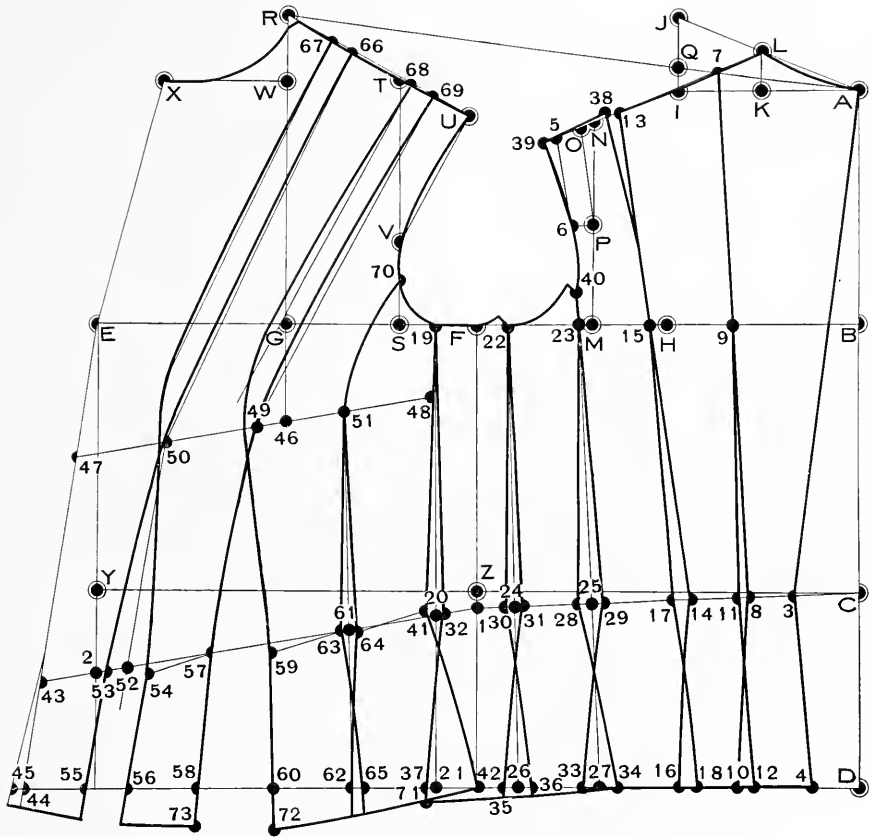

Tight-Fitting 22 Gores

First lay up all points to your measure as described in Systematical Outline, then continue as follows:

- 1 from Z is $\frac{1}{2}$ inch.
- 2 from Y is $2\frac{1}{4}$ inches.
- Draw lines from C to 1 and from 1 through 2 for the fashionable waist line as represented.
- 3 from C is 2 inches.
- 4 from D is $1\frac{3}{4}$ inches.
- 5 from O is $\frac{3}{4}$ inch.
- 6 from P is $\frac{3}{4}$ inch.
- Draw a line from 5 to 6.
- 7 from O is 2 inches.
- 8 from L is one-third of distance from L to 7.
- 9 from 3 is $1\frac{5}{8}$ inch less than K from A.
- 10 from 4 is $\frac{3}{4}$ inch more than 3 to 9.
- 11 is located by drawing a line from 8 to 9.
- Finish the back part as represented.
- 12 from 9 is $\frac{1}{4}$ inch.
- 13 from 10 is $\frac{3}{8}$ inch.
- 14 is the half-way between 7 and 8.
- 15 from 12 is $\frac{3}{8}$ inch less than 3 to 9.
- 16 from 13 is $\frac{3}{4}$ inch more than 15 from 12.
- 17 is located by drawing a line from 14 to 15.
- 18 from 15 is $\frac{1}{4}$ inch.
- 19 from 16 is $\frac{3}{8}$ inch.
- 20 from 18 is the same as 3 to 9.
- 21 from 19 is $\frac{3}{4}$ inch more than 18 to 20.
- 22 is located by drawing a line from 7 to 20.
- 23 from 20 is $\frac{1}{4}$ inch.
- 24 from 21 is $\frac{1}{2}$ inch.
- 25 from F is $1\frac{1}{4}$ inches.
- 26 from 1 is $1\frac{1}{4}$ inches.
- 27 is located by drawing a line from 25 through 26.
- 28 from 25 is one-third of distance from 25 to 22.
- 29 is the half-way between 22 and 28.
- 30 is one-third of distance from 26 to 23.
- 31 is the half-way between 30 and 23.
- 32 is located by drawing a line from 28 through 30.
- 33 is located by drawing a line from 29 through 31.
- 34 from 31 is $\frac{3}{8}$ inch.
- 35 from 31 is $\frac{3}{8}$ inch.
- 36 from 30 is $\frac{1}{4}$ inch.
- 37 from 30 is $\frac{1}{4}$ inch.
- 38 from 26 is $\frac{1}{4}$ inch.
- 39 from 33 is $\frac{3}{8}$ inch.
- 40 from 33 is $\frac{1}{2}$ inch.
- 41 from 32 is $\frac{3}{8}$ inch.
- 42 from 32 is $\frac{1}{2}$ inch.
- 43 from 27 is $\frac{1}{4}$ inch.
- 44 from 7 is $\frac{3}{8}$ inch, and is $\frac{1}{4}$ inch higher than line L-O.
- 45 from 5 is $\frac{3}{8}$ inch, and is the same length from 6 as O from P.
- 46 from 29 is 1 inch.
- Finish the side gores as represented.
- 47 from 26 is $\frac{1}{4}$ inch.
- 48 from 27 is 1 inch.
- 49 from 2 is $1\frac{3}{4}$ inches.
- 50 is located by drawing a line from E through 49.

- 51 from 50 is $\frac{3}{8}$ inch.
- 52 from G is $3\frac{1}{4}$ inches.
- 53 is located by drawing a line through 52 parallel with line 1-2.
- 54 is located by drawing a line from 53 through 52.
- 55 from 53 is one-fifth of the distance from 23 to 54.
- 56 from 55 is one-fifth of the distance from 53 to 54.
- 57 from 56 is one-fifth of the distance from 53 to 54.
- 58 from 57 is one-fifth of the distance from 53 to 54.
- 59 is located by drawing a line from 55 parallel with line E-49.
- 60 from 59 is $\frac{1}{2}$ inch.
- 61 from 59 is $\frac{1}{2}$ inch.
- 62 from 61 is $1\frac{1}{4}$ inches less than K from A.
- 63 from 62 is 1 inch.
- 64 from 63 is the same as 62 from 61.
- 65 from 64 is $\frac{3}{4}$ inch.
- 66 is the half-way between 65 and 47.
- 67 is located by drawing a line from 58 through 66.
- 68 from 66 is $\frac{1}{4}$ inch.
- 69 from 66 is $\frac{1}{4}$ inch.
- 70 is located by drawing a line from 60 parallel with line E-50.
- 71 from 70 is 1 inch.
- 72 from 71 is $\frac{1}{4}$ inch more than 62 from 61.
- 73 from 72 is $1\frac{1}{8}$ inches.
- 74 from 73 is $\frac{1}{4}$ inch more than 64 from 63.
- 75 from 74 is $\frac{7}{8}$ inch.
- 76 from 67 is $\frac{1}{4}$ inch.
- 77 from R is $\frac{3}{8}$ inch more than 8 from L.
- Draw a line from 77 to 55.
- 78 from 77 is $\frac{3}{4}$ inch for seams.
- Draw a line from 78 parallel with line 77-55.
- 79 from 78 is $\frac{3}{4}$ inch more than 14 from 8.
- Draw a line from 79 to 56.
- 80 from 79 is $\frac{3}{4}$ inch for seams.
- Draw a line from 80 parallel with line 79-56.
- 81 from U is the same as 45 from 44.
- 82 from 81 is $\frac{3}{4}$ inch for seams.
- Draw a line from 82 to 57.
- Draw a line from 81 parallel with line 82-57.
- 83 is the half-way between S and V.
- 84 from 38 is the same length as 48 from 47.
- 85 from 75 is $1\frac{1}{4}$ inches.
- 86 from 64 is the same length as 85 from 65.
- Finish the front and bottom as represented.
- By cutting out the pattern allow extra for seams all way down as follows:
 - $\frac{3}{8}$ inch at line 8-9-10.
 - $\frac{3}{8}$ inch at line 8-12-13.
 - $\frac{3}{8}$ inch at line 14-15-16.
 - $\frac{3}{8}$ inch at line 14-18-19.
 - $\frac{1}{4}$ inch at line 46-35-39.
 - $\frac{1}{4}$ inch at line 28-37-41.
 - $\frac{1}{4}$ inch at line 25-38-84.
 - $\frac{3}{8}$ inch at line 83-69-67.
 - $\frac{3}{8}$ inch at line 83-68-76.

Tight-Fitting 22 Gores

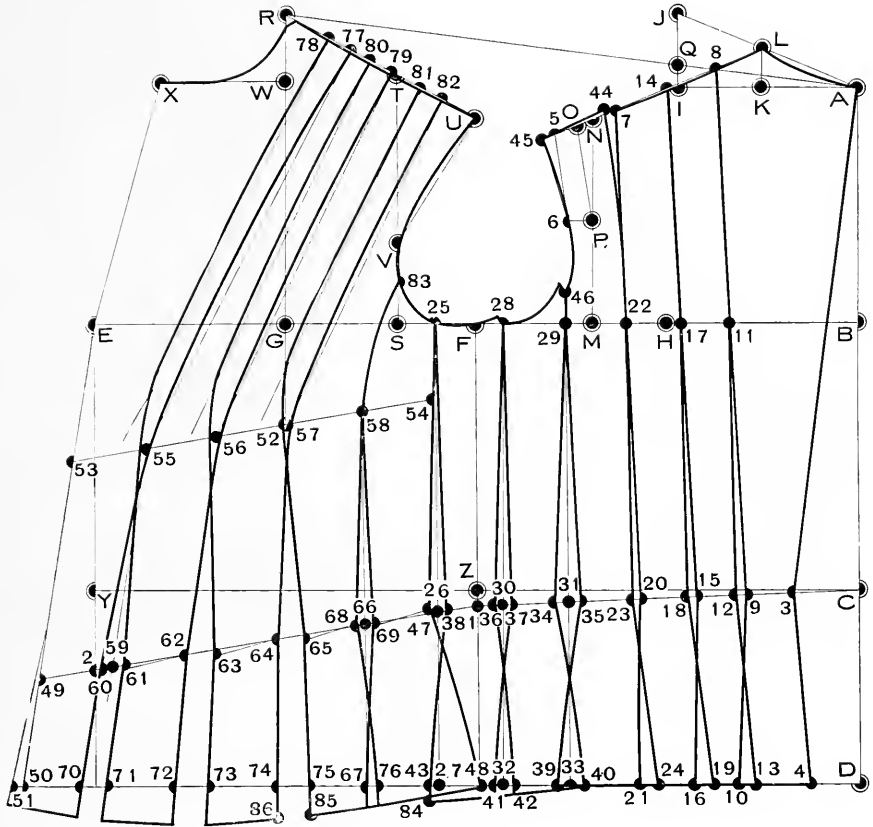

Semi-Fitting Back and Loose Front

First lay up all points to your measure as described in Systematical Outline, then continue as follows:

1 from Z is $\frac{1}{2}$ inch.

2 from Y is $2\frac{1}{4}$ inches.

Draw lines from C to 1 and from 1 through 2 for the fashionable waist line as represented.

3 from C is $1\frac{1}{2}$ inches.

4 from 3 is a $\frac{1}{4}$ inch.

5 from D is 1 inch.

6 from P is $\frac{3}{4}$ inch.

7 from H is $\frac{3}{4}$ inch.

8 from 4 is 1 inch more than the distance from A to K.

9 from 5 is $\frac{3}{4}$ inch more than the distance from 4 to 8.

Finish the back as represented.

10 from 8 is $\frac{1}{2}$ inch.

11 from 9 is $1\frac{1}{2}$ inches.

12 from 6 is $\frac{1}{2}$ inch.

13 from F is $\frac{3}{4}$ inch.

14 from 1 is $\frac{3}{4}$ inch.

15 is located by drawing a line from 13 through 14.

16 from 14 is $\frac{1}{2}$ inch.

17 from 1 is $\frac{1}{2}$ inch, and is from F the same length as 16 from 13.

18 from 15 is $\frac{1}{2}$ inch.

19 from 15 is 1 inch, and is from 17 the same length as 18 from 16.

20 is located by line squared out from E.

21 from 2 is $\frac{1}{2}$ inch.

Draw line from E through 21.

Finish the front and side gore as represented.

Semi-Fitting with Dart in Front

First lay up all points to your measure as described in Systematical Outline, then continue as follows:

- 1 from Z is $\frac{1}{2}$ inch.
- 2 from Y is $2\frac{1}{4}$ inches.

Draw lines from C to 1 and from 1 through 2 for the fashionable waist line as represented.

- 3 from C is $1\frac{1}{2}$ inches.
- 4 from 3 is a $\frac{1}{4}$ inch.
- 5 from D is 1 inch.
- 6 from P is $\frac{3}{4}$ inch.
- 7 from H is $\frac{3}{4}$ inch.
- 8 from 4 is 1 inch more than the distance from A to K.
- 9 from 5 is $\frac{3}{4}$ inch more than the distance from 4 to 8.

Finish the back as represented.

- 10 from 8 is $\frac{1}{2}$ inch.
- 11 from 9 is $1\frac{1}{2}$ inches.
- 12 from 6 is $\frac{1}{2}$ inch.
- 13 from F is $\frac{3}{4}$ inch.
- 14 from 1 is $\frac{3}{4}$ inch.
- 15 is located by drawing a line from 13 through 14.
- 16 from 14 is $\frac{1}{2}$ inch.

Finish the side gore as represented.

- 17 from 1 is $\frac{1}{2}$ inch, and is from F the same length as 16 from 13.
- 18 from 15 is 1 inch.
- 19 from 2 is 2 inches.

Draw line from E through 19.

- 20 from G is $3\frac{1}{4}$ inches.
- 21 from 20 is $1\frac{1}{2}$ inches on line drawn parallel with line E--19.
- 22 is located by drawing a line from 21 parallel with line E--19.
- 23 is located by drawing a line from 21 parallel with line E--19.
- 24 from 22 is $\frac{1}{2}$ inch.
- 25 from 24 is 3 inches.
- 26 from 21 is the same length as 24 from 21.
- 27 from 23 is $\frac{3}{8}$ inch.
- 28 from 27 is $3\frac{3}{4}$ inches.

Finish the front as represented.

- 29 from 16 is the same length as 18 from 17.
- 30 from 28 is $1\frac{1}{4}$ inches.
- 31 from 24 is the same length as 30 from 26.

Finish the bottom as represented.

Semi-Fitting with Dart in Front

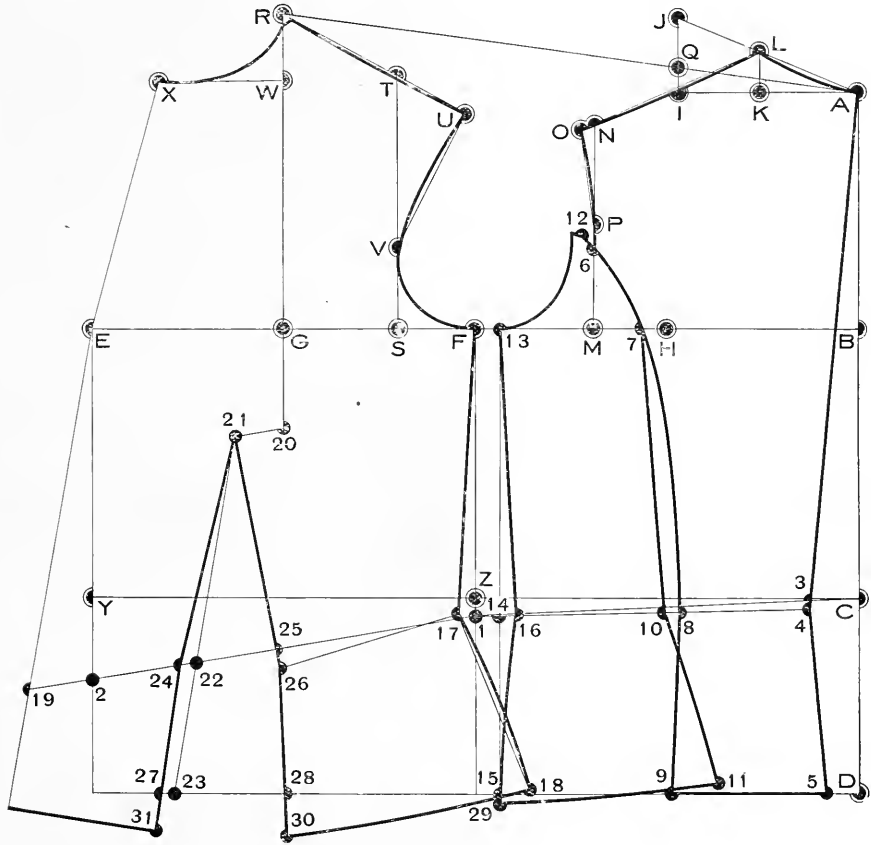

Semi-Fitting French Seam

First lay up all points to your measure as described in Systematical Outline, then continue as follows:

1 from Z is $\frac{1}{2}$ inch.

2 from Y is $2\frac{1}{4}$ inches.

Draw lines from C to 1 and from 1 through 2 for the fashionable waist line as represented.

3 from C is $1\frac{1}{2}$ inches.

4 from 3 is $\frac{1}{4}$ inch.

5 from D is 1 inch.

6 from O is $\frac{3}{4}$ inch.

7 from P is $\frac{3}{4}$ inch.

Draw a line from 6 to 7.

8 is the half-way between 6 and 4, or make the width to style or taste.

9 from 4 is 1 inch more than the distance from A to K.

10 from 5 is $\frac{3}{4}$ inch more than the distance from 4 to 9.

11 is located by drawing a line from 8 to 9 as represented.

Finish the back as represented.

12 from 9 is $\frac{1}{2}$ inch.

13 from 10 is $1\frac{1}{2}$ inch.

14 from F is $\frac{3}{4}$ inch.

15 from 1 is $\frac{3}{4}$ inch.

16 is located by drawing a line from 14 through 15.

17 from 15 is $\frac{1}{2}$ inch.

18 from 8 is $\frac{3}{8}$ inch.

19 from 6 is $\frac{3}{8}$ inch.

20 from 18 is $\frac{1}{4}$ inch.

21 from 7 is the same length as O from P.

Finish the side gore as represented.

22 from 1 is $\frac{1}{2}$ inch.

23 from 16 is 1 inch.

24 from 2 is 2 inches.

25 from G is $3\frac{1}{4}$ inches.

26 from 25 is $1\frac{1}{2}$ inches on line drawn from 25 parallel with line 1--2

27 is located by drawing a line from 26 parallel with line E--24.

28 is located by drawing a line from 26 through 27.

29 from 27 is $\frac{1}{2}$ inch.

30 from 28 is $\frac{3}{8}$ inch.

31 from 29 is 3 inches.

32 from 26 is the same length as 29 from 26.

33 from 30 is $3\frac{3}{4}$ inches.

34 from R is the same width as L to 8.

Draw a line from 34 to 26.

35 from 34 is $\frac{3}{4}$ inch for seams.

Draw a line from 35 parallel with line 34--26.

36 from 16 is $\frac{1}{4}$ inch.

37 from 22 is the same length as 36 from 17.

38 from 33 is $1\frac{1}{4}$ inches.

39 from 29 is the same length as 38 from 32.

Finish the front and bottom as represented.

Semi-Fitting French Seam

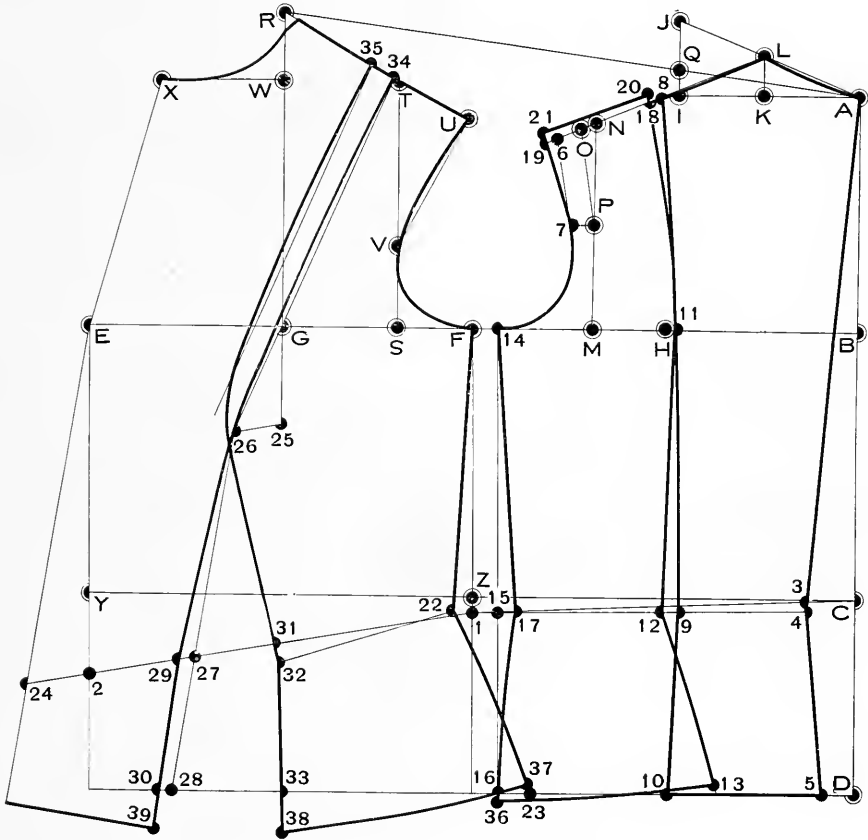

Semi-Fitting Hipless Effect

First lay up all points to your measure as described in Systematical Outline, then continue as follows:

1 from Z is $\frac{1}{2}$ inch.

2 from Y is $2\frac{1}{4}$ inches.

Draw lines from C to 1 and from 1 through 2 for the fashionable waist line as represented.

3 from C is 3 inches.

4 from 1 is 3 inches.

5 from 2 is 3 inches.

Draw lines from 3 to 4 and from 4 to 5 as represented.

6 from 3 is $1\frac{1}{4}$ inches.

7 from D is 1 inch.

8 from P is $\frac{3}{4}$ inch.

9 from H is $\frac{3}{4}$ inch.

10 from 6 is $1\frac{1}{4}$ inch more than K from A.

11 from 7 is $\frac{3}{4}$ inch more than 10 from 6.

Finish the back as represented.

12 from 10 is $\frac{1}{4}$ inch.

13 from 11 is $1\frac{1}{2}$ inches.

14 from F is $\frac{3}{4}$ inch.

15 from 4 is $\frac{3}{4}$ inch.

16 is located by drawing a line from 14 through 15.

17 from 15 $\frac{1}{4}$ inch.

Finish the back-side gore as represented.

18 from 4 is $\frac{1}{4}$ inch.

19 from 16 is 1 inch.

20 from 2 is 2 inches.

21 from G is $3\frac{1}{4}$ inches.

22 from 21 is $1\frac{1}{2}$ inches on line drawn from 21 paralld with line 18-5.

23 is located by drawing a line from 22 paralld wth line E-20.

24 is located by drawing a line from 22 through 23.

25 from 23 is $\frac{1}{4}$ inch.

26 from 23 is $\frac{3}{4}$ inch, and is from 22 the same length as 25 from 22.

27 is located by drawing a square line up from the hip line to 26.

28 from V is $\frac{3}{4}$ inch.

Finish the front as represented.

29 from A is the length of garment as desired.

30 is located by a line squared out from 29.

31 is located by a line squared out from 29.

32 is located by a line squared out from 29.

33 from 12 is the same length as 30 from 10.

34 from 17 is the same length as 35 from 18.

35 is located by a line squared out from 29.

36 from 32 is $1\frac{1}{4}$ inches.

37 is located by drawing a line from 25 through 24, and is from 25 the same length as 36 from 26.

38 from R is 1 inch.

Allow for button stand 2 inches for single breasted and 3 inches for double breasted.

Finish the bottom as represented.

Semi-Fitting Hipless Effect

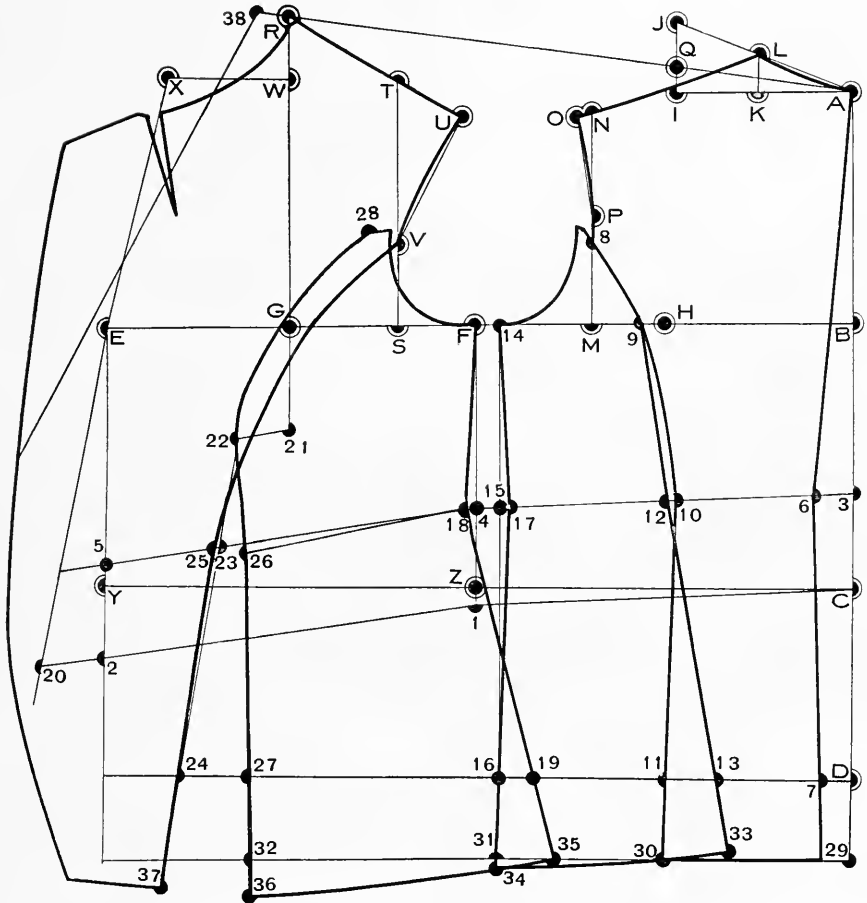

Semi-Fitting Coat with Underarm Gore.

First lay up all points to your measure as described in Systematical Outline, then continue as follows:

- 1 from Z is $\frac{1}{2}$ inch.
- 2 from Y is $2\frac{1}{4}$ inches.

Draw lines from C to 1 and from 1 to 2 for the fashionable waist line as represented.

- 3 from C is $1\frac{1}{2}$ inches.
- 4 from 3 is $\frac{1}{4}$ inch.
- 5 from D is 1 inch.
- 6 from M is $\frac{3}{4}$ inch.
- 7 from 6 is $\frac{3}{4}$ inch.
- 8 from 4 is 3 inches more than K from A.
- 9 is located by drawing a curved line from 7 to 8 as represented.
- 10 from 5 is $\frac{3}{4}$ inch more than 8 from 4.

Finish the back as represented.

- 11 from 7 is $1\frac{1}{2}$ inches.
- 12 from 9 is $1\frac{1}{2}$ inches.
- 13 from 8 is 2 inches.
- 14 from 10 is $1\frac{3}{4}$ inches.
- 15 is located by drawing a shaped line from 11 to 14 as represented.
- 16 from 2 is 2 inches.

Draw a line from E through 16 for the run of front center.

- 17 from G is $3\frac{1}{4}$ inches
- 18 from 17 is $\frac{1}{2}$ inch.
- 19 is located by drawing a line from 18 parallel with line E---16.
- 20 is located by drawing a line from 18 through 19.
- 21 from 19 is $\frac{1}{2}$ inch.
- 22 from 21 is 3 inches.
- 23 from 18 is the same length as 21 from 18.
- 24 from 20 is $\frac{3}{8}$ inch.
- 25 from 24 is $3\frac{3}{4}$ inches.
- 26 from V is $\frac{3}{4}$ inch.
- 27 from 26 is $\frac{3}{4}$ inch.
- 28 from A is the length of garment as desired.
- 29 is located on line squared out from 28.
- 30 from 15 is the same length as 29 from 8.
- 31 is located on line squared out from 28.
- 32 from 31 is $1\frac{1}{4}$ inches.
- 33 from 21 is the same length as 32 from 23.

Finish the front and underarm gore as represented.

Semi-Fitting Coat with Underarm Gore.

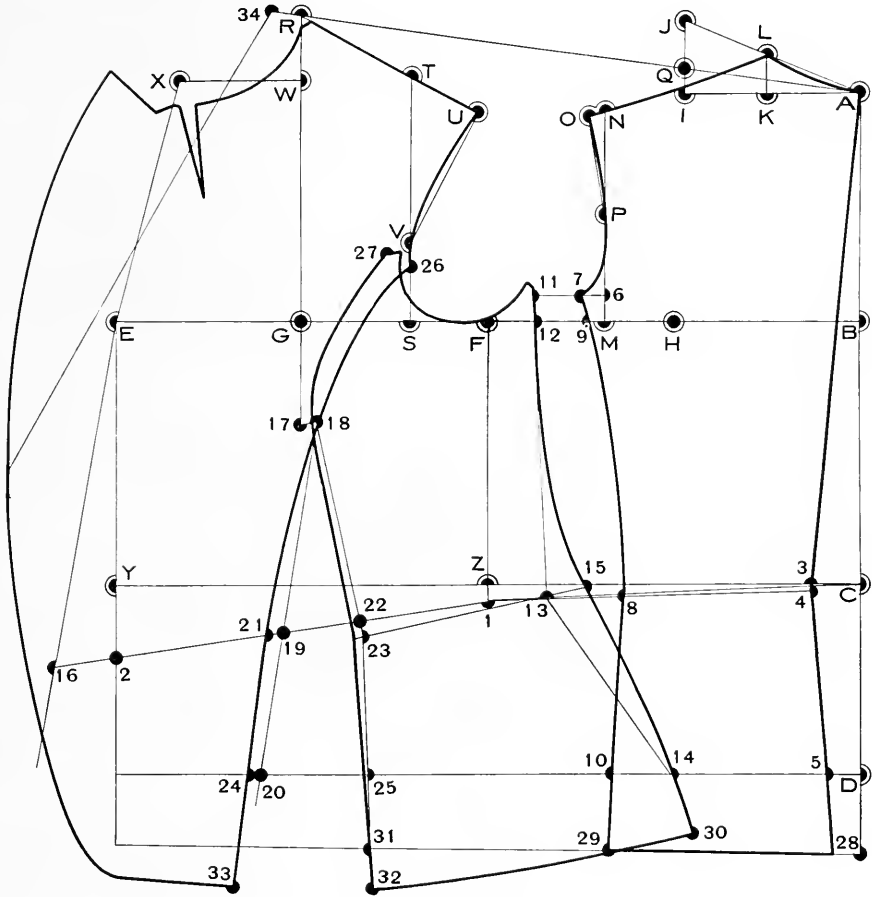

Sac Coat with Loose Front

First lay up all points to your measure as described in Systematical Outline, then continue as follows:

- 1 from Z is $\frac{1}{2}$ inch.
- 2 from Y is $2\frac{1}{4}$ inches.

Draw lines from C to 1 and from 1 to 2 for the fashionable waist line as represented.

- 3 from C is $1\frac{1}{2}$ inches.
- 4 from 3 is $\frac{1}{4}$ inch.
- 5 from D is 1 inch.
- 6 from M is $\frac{3}{4}$ inch.
- 7 from 6 is $\frac{3}{4}$ inch.
- 8 from 4 is 3 inches more than K from A.
- 9 is located by drawing a curved line from 7 to 8 as represented.
- 10 from 5 is $\frac{3}{4}$ inch more than 8 from 4.

Finish the back as represented.

- 11 from 8 is $\frac{1}{2}$ inch.
- 12 from 10 $1\frac{3}{4}$ inches.
- 13 from F is $\frac{1}{2}$ inch.
- 14 from 1 is $\frac{1}{2}$ inch.
- 15 from 14 is $2\frac{1}{2}$ inches and is located by drawing a line from 13 through 14.
- 16 from 14 is $\frac{3}{8}$ inch.
- 17 from 14 is $\frac{3}{8}$ inch.
- 18 from 2 is $\frac{1}{2}$ inch.
- 19 from A is the length of garment as desired.
- 20 is located on line squared out from 19.
- 21 is located by drawing a line from E through 18.
- 22 from 11 is the same length as 20 from 8.
- 23 from R is 1 inch.
- 24 is located by a line squared down from S and is $2\frac{1}{2}$ inches below the fashionable waist line.
- 25 from 24 is $\frac{1}{2}$ inch.
- 26 is located by drawing a line from 25 through 15 and is the half of the pocket size, in this case 3 inches.
- 27 is located by drawing a line from 26 through 25 and is the full pocket size, in this case 6 inches.
- 28 from S is 1 inch.
- 29 from G is $\frac{1}{2}$ inch.
- 30 is located by drawing a line from 28 through 29, and is in this case 5 inches long.

Finish the draft as represented.

Sac Coat with Loose Front

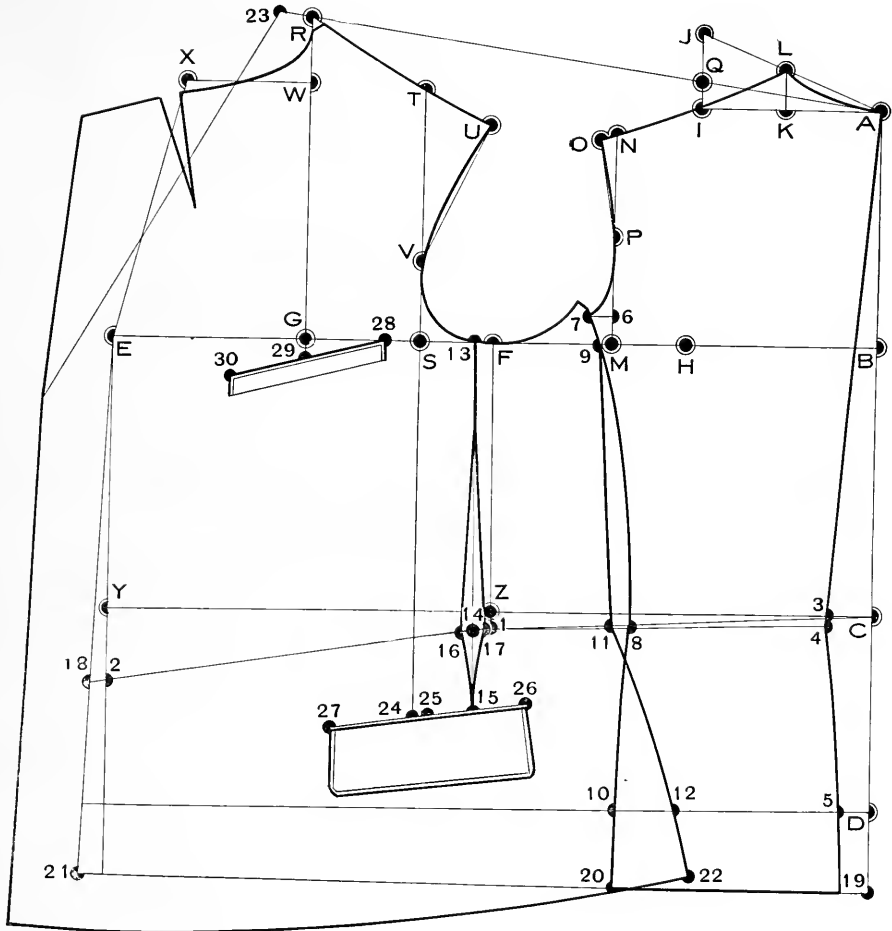

Sac Coat with Shaped Front

First lay up all points to your measure as described in Systematical Outline, then continue as follows:

- 1 from Z is $\frac{1}{2}$ inch.
- 2 from Y is $2\frac{1}{4}$ inches.

Draw lines from C to 1 and from 1 to 2 for the fashionable waist line as represented.

- 3 from C is $1\frac{1}{2}$ inches.
- 4 from 3 is $\frac{1}{4}$ inch.
- 5 from D is 1 inch.
- 6 from M is $\frac{3}{4}$ inch.
- 7 from 6 is $\frac{3}{4}$ inch.
- 8 from 4 is 3 inches more than K from A.
- 9 is located by drawing a curved line from 7 to 8 as represented.
- 10 from 5 is $\frac{3}{4}$ inch more than 8 from 4.

Finish the back as represented.

- 11 from 8 is $\frac{1}{2}$ inches.
- 12 from 10 is $1\frac{3}{4}$ inches.
- 13 from F is $\frac{1}{2}$ inches.
- 14 from 1 is $\frac{1}{2}$ inch.
- 15 from 14 is $2\frac{1}{2}$ inches and is located by drawing a line from 13 through 14.
- 16 from 14 is $\frac{1}{2}$ inch.
- 17 from 14 is $\frac{1}{2}$ inch.
- 18 from 2 is 2 inches.
- 19 from G is $3\frac{1}{4}$ inches.
- 20 from 19 is $1\frac{1}{2}$ inches on line drawn from 19 parallel with line 1--2.
- 21 is located by drawing a line from 20 parallel with line E--18.
- 22 is located by drawing a line from 20 through 21.
- 23 from 21 is $\frac{1}{2}$ inch.
- 24 from 22 is $\frac{3}{8}$ inch.
- 25 from 23 is 3 inches and is from 20 the same length as 23 from 20.
- 26 from 24 is $3\frac{3}{4}$ inches
- 27 from A is the length of garment as denired.
- 28 is located on line squared out from 27.
- 29 is located on line squared out from 27.
- 30 from 11 is the same length as 28 from 8.
- 31 from 29 is $1\frac{1}{4}$ inches.
- 32 from 23 is the same length as 31 from 25.
- 33 from R is $3\frac{3}{4}$ inches.
- 34 from 33 is $\frac{3}{4}$ inch for seams.

Finish the draft as represented.

How to make Shoulder Dart

To make a shoulder dart we must have first a french seam front.

Put the two parts together so that they should lap over $\frac{3}{4}$ inch from A to C and B to D as represented.

How to make Shoulder-Dart

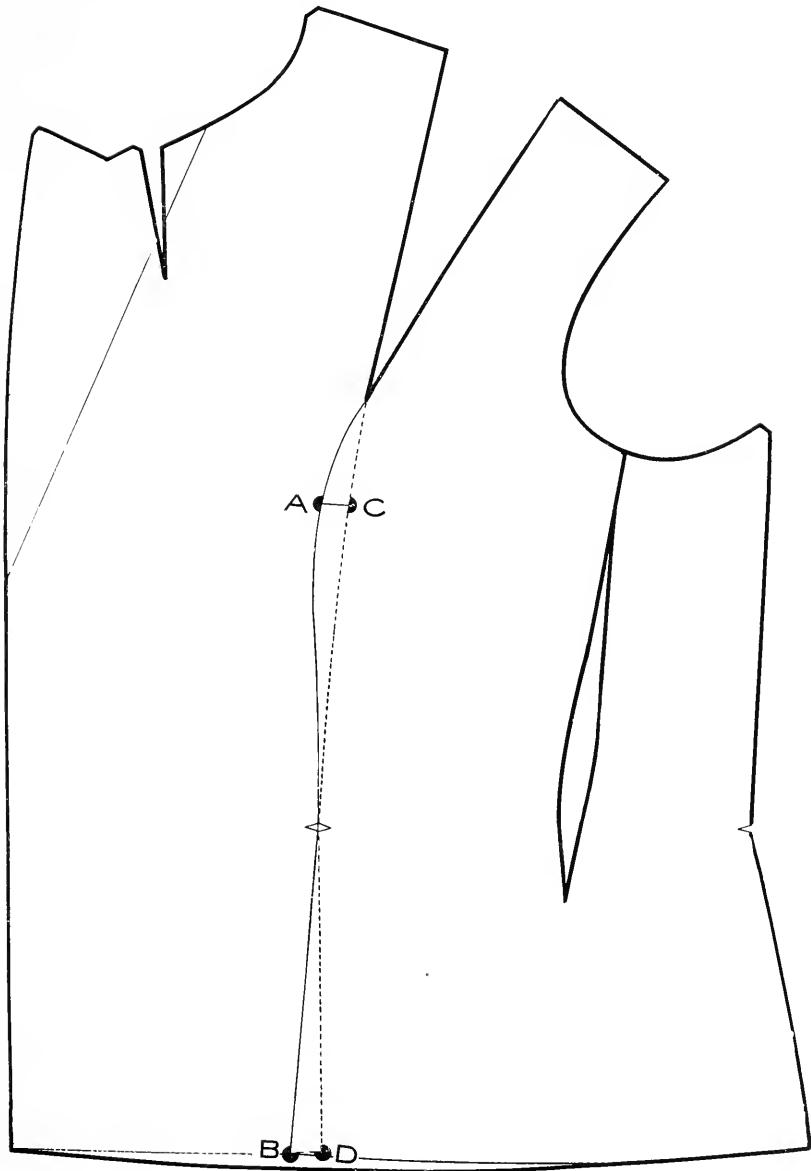

Loose Box Coat

First lay up all points to your measure as described in Systematical Outline, then continue as follows:

1 from Z is $\frac{1}{2}$ inch.

2 from Y is $2\frac{1}{4}$ inches.

Draw lines from C to 1 and from 1 through 2 as represented.

3 is the half-way between F and M.

4 from 3 is $\frac{5}{8}$ inch.

5 from 3 is $\frac{5}{8}$ inch.

6 from 1 is $\frac{1}{4}$ inch more than 5 from F.

7 from 6 is $1\frac{1}{4}$ inches.

8 from C is $\frac{3}{4}$ inch.

9 from A is $\frac{3}{4}$ inch.

10 from L is $\frac{1}{4}$ inch.

11 from R is $\frac{3}{4}$ inch.

12 from 2 is $\frac{1}{2}$ inch.

Draw a line from E through 12.

13 from A is the length of garment as desired.

14 is located by a line squared out from 13.

15 from 14 is $\frac{1}{2}$ inch.

16 from 4 is the same length as 15 from 5.

17 is located by a line squared out from 13.

18 from 17 is $1\frac{1}{4}$ inches.

19 from 11 is 1 inch.

Allow for button stand 3 inches for single breasted, 4 inches for double breasted.

Finish the draft as represented.

If you wish to have the back center without seam, take off $\frac{3}{8}$ inch seam at the back center.

Loose Box Coat

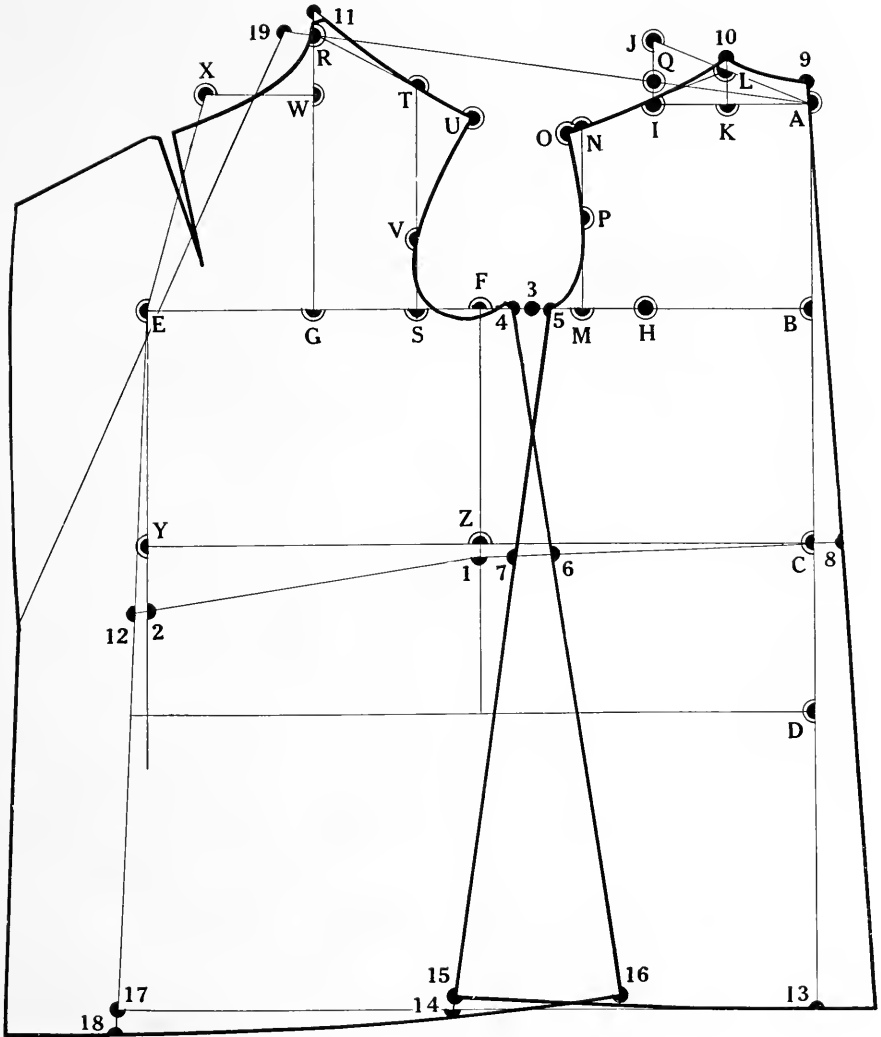

Loose Box Coat with Front-Shoulder Dart

First lay up all points to your measure as described in Systematical Outline, then continue as follows:

- 1 from Z is $\frac{1}{2}$ inch.
- 2 from Y is $2\frac{1}{4}$ inches.

Draw Lines from C to 1 and from 1 through 2 as represented.

- 3 is the half-way between F, and M.
- 4 from 3 is $\frac{5}{8}$ inch.
- 5 from 3 is $\frac{3}{8}$ inch.
- 6 from 1 is $\frac{1}{4}$ inch more than 5 from F.
- 7 from 6 is $1\frac{1}{4}$ inches.
- 8 from C is $\frac{3}{4}$ inch.
- 9 from A is $\frac{3}{4}$ inch.
- 10 from L is $\frac{1}{4}$ inch.
- 11 from R is $\frac{3}{4}$ inch.
- 12 from 2 is 2 inches.

Draw a line from E through 12 as represented.

- 13 from G is $3\frac{1}{4}$ inches.
- 14 from 13 is $1\frac{1}{2}$ inches on line drawn from 13 parallel with line 1-2.
- 15 is located by a line drawn from 14 parallel with line E-12.
- 16 is located by a line drawn from 14 parallel with line E-12.
- 17 from 16 is $\frac{1}{2}$ inch.
- 18 from 17 is 3 inches.
- 19 from 14 is the same length as 17 from 14.
- 20 from 15 is $\frac{3}{8}$ inch.
- 21 from 20 is $3\frac{1}{4}$ inches.
- 22 from A is the full length as desired.
- 23 is located by a line squared up from 22.
- 24 is located by a line squared up from 22.
- 25 is located by a line squared up from 22.
- 26 from 24 is $\frac{1}{2}$ inch.
- 27 from 4 is the same length as 26 from 5.
- 28 from 25 is $1\frac{1}{4}$ inches.
- 29 from 17 is the same length as 28 from 19.
- 30 from R is inch.

Allow for button stand 3 inches for single breasted, 4 inches for double breasted.

Finish the draft as represented.

If you wish to have the back centre without seam, take off $\frac{3}{8}$ inch seam at the back centre

To get the front-shoulder dart make the front with french-seam as follows:

- 31 from 11 is $3\frac{3}{4}$ inches.

Draw a line from 31 to 14.

- 32 from 31 is $\frac{3}{4}$ inch for seams.

Draw a line from 32 parallel with line 31-14 as represented.

To get the shoulder dart bring the front parts together as described an illustrated on pages 60 and 61.

Loose Box Coat with Front-Shoulder Dart

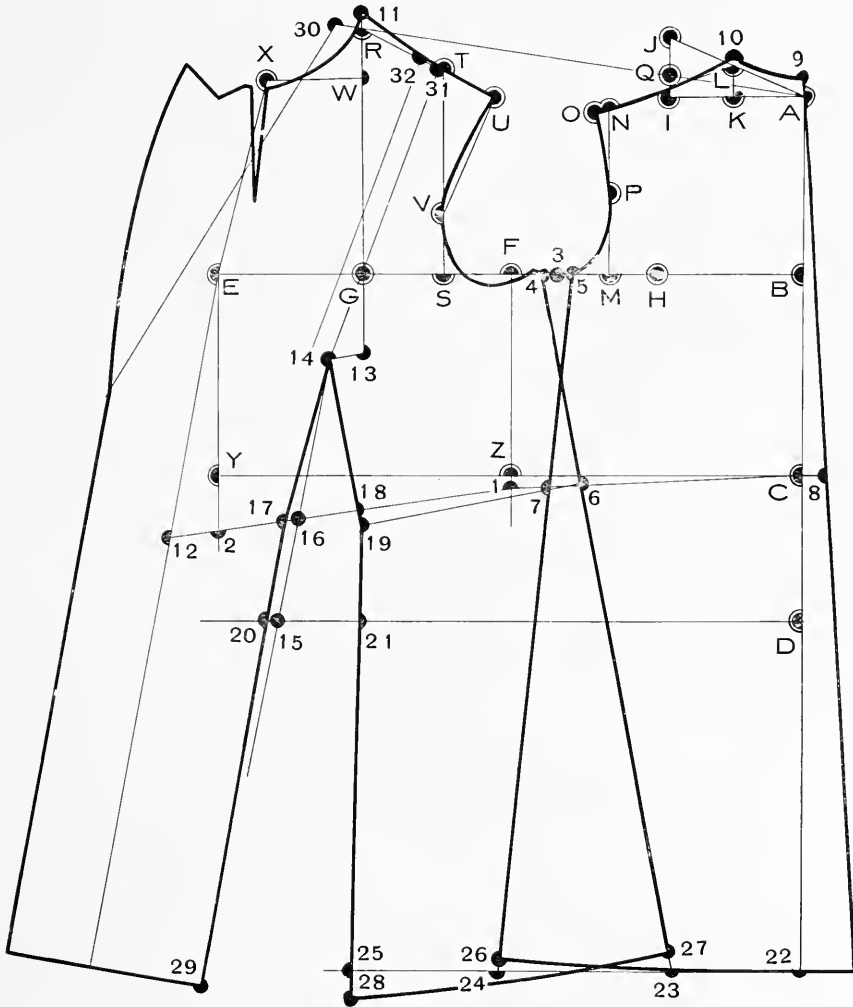

Coat Sleeve

1 Draw a straight line as from 1 to 2.

2 from 1 is the Sleeve length measure (inside seam).

Square a line up from 2.

3 from 1 is a quarter of the full bust measure plus 1 inch on a line squared up from 1.

4 is located by a line squared out from 3 as represented.

5 is the center of 1-2.

6 is located by a line squared up from 5.

7 is the center of 2-4.

8 is the center of 1-3.

Square out a line from 8 as represented.

9 from 9 is 2 inches.

10 from 8 is the same length as 8 from 1.

11 from 1 is 2 inches.

Draw lines between 11-10 and from 10 through 3.

12 is the center of 10-11.

13 is the center of 3-10.

14 from 12 is $\frac{3}{4}$ inch.

15 from 13 is $1\frac{1}{2}$ inches.

16 from 3 is $\frac{1}{2}$ inch.

17 from 3 is $\frac{1}{3}$ inch.

18 from 6 is 2 inches.

19 from 5 is 3 inches.

20 from 7 is 2 inches.

Draw a line from 4 through 20.

21 from 20 is 1 inch.

22 from 20 is 1 inch.

23 from 4 is $\frac{1}{2}$ inch.

24 from 21 is $\frac{1}{2}$ inch.

Draw all construction lines as represented.

Shape the top sleeve as represented by lines between 11-10-17-18-4-22-5-11.

Shape the under sleeve as represented by lines between 9-16-18-23-24-19-9.

Coat Sleeve

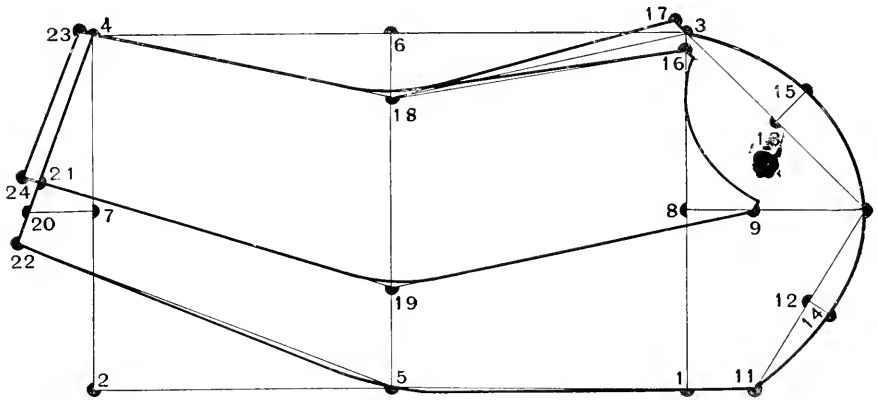
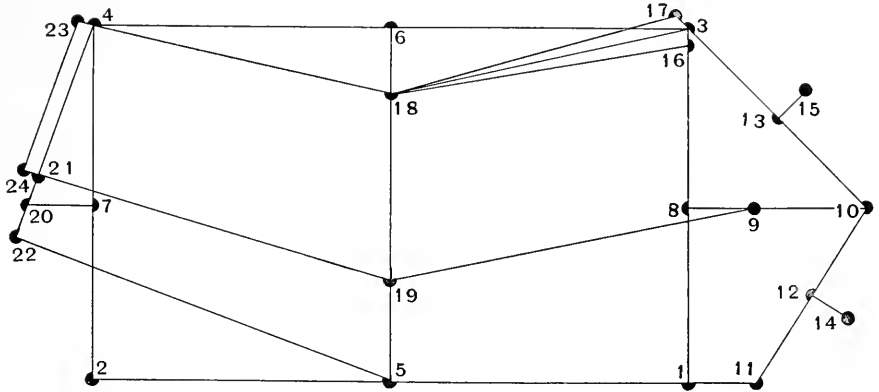

Sleeve with fulness on top

To make the sleeve with more fulness on the head, proceed as follows :

Mark the top-sleeve as shown by A-B-C-D-E.

The shape of the sleeve remains always the same between A-B-C-D and fulness is allowed only at points E, F, G, H as desired.

Finish the top-sleeve as represented.

The under-sleeve is not to be changed ; it remains always the same.

One Piece Sleeve

with fulness on the top and Cuff

To make one piece sleeve place the top and under sleeves together at the back seam so, that they should overlap $\frac{3}{4}$ inch for figuring the seams off, and finish the sleeve as represented.

The cuff is represented by heavy, broken lines.

Sleeve with fulness on top

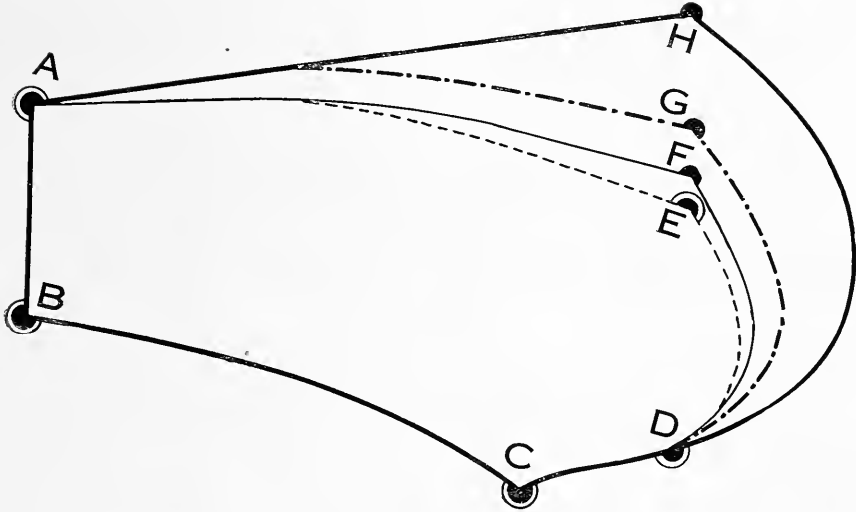

One Piece Sleeve with fulness on the top and Cuff

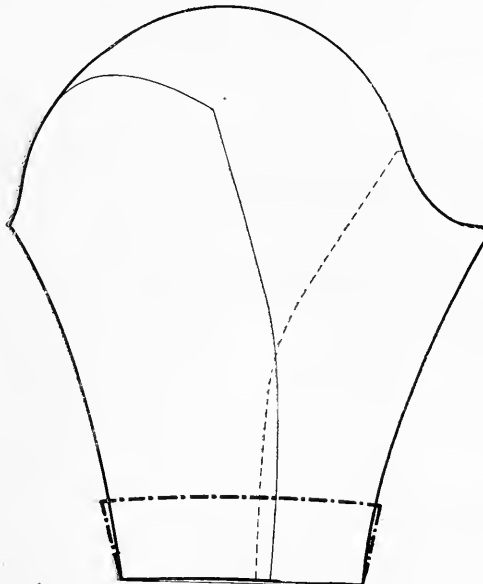

One Piece Sleeve with fulness on the bottom

Bishop Sleeve

Place the top- and under sleeve together at the back seam so, that they should overlap $\frac{3}{4}$ inch for figuring the seams off, and finish as represented by the upper diagram.

The lower diagram shows how to make this sleeve by direct drafting as follows:

1. Square bot-ways from 1 as represented.
- 2 from 1 is the sleeve length measure (inseam).
- 3 from 1 is one-quarter of the full Bust measure plus $\frac{1}{4}$ inch.
- 4 is the center between 1 and 2.
- 5 is the same as 1-3 on line squared out from 4.
- 6 is the center between 1-3.
- 7 from 2 is the same as 6 from 1.
- 8 from 7 is 2 inches on line squared out from 7.
- 9 from 6 is the same as 6 from 1 on line squared out from 6.
- 10 from 3 is 2 inches.

Connect 1-9-10 by lines.

- 11 is the center between 1 and 9.
- 12 is the center between 9 and 10.
- 13 from 11 is $1\frac{1}{4}$ inches.
- 14 from 12 is $\frac{3}{4}$ inch.
- 15 from 4 is 2 inches.
- 16 from 5 is 3 inches.
- 17 from 8 is 1 inch.
- 18 from 8 is 1 inch.
- 19 from 6 is 2 inches.

Connect points as represented.

Shape the sleeve at the top and front seam as represented.

- 20 is the center between 5 and 16.
- 21 is the center between 3 and 6.
- 22 is located by drawing a line from 20 through 21.
- 23 is located by drawing a line from 22 through 20.

Fold the paper at the line 22-20-23 and trace over the under sleeve as represented by the heavy, broken line between points 8-20-21-22-19-1, and finish the sleeve as represented

One Piece Sleeve

with fulness on the bottom

Bishop Sleeve

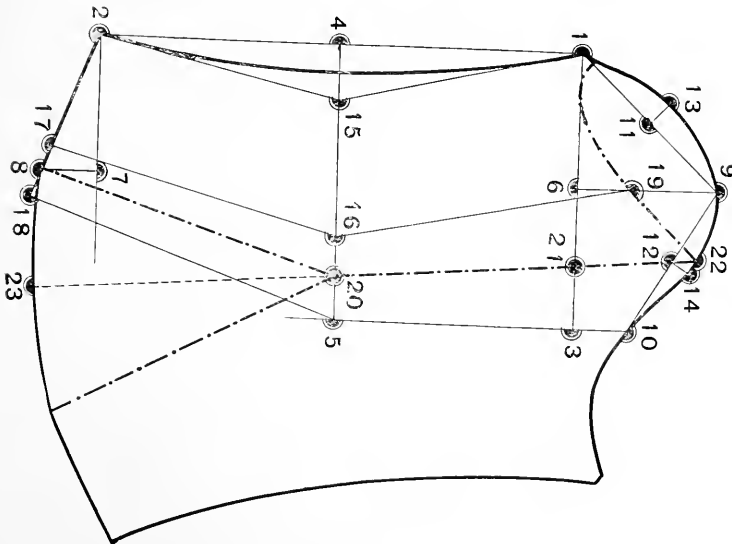
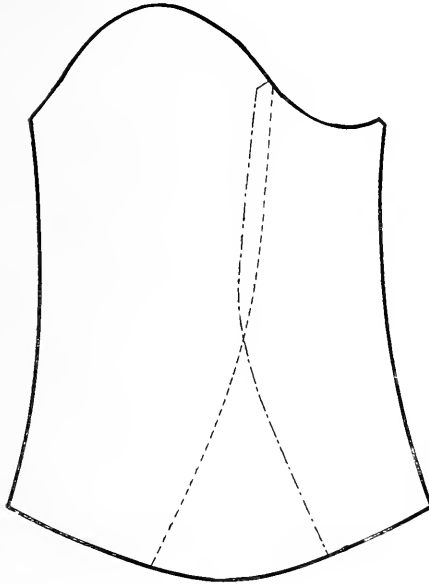

One Piece Tight Sleeve

First make a Bishop Sleeve as described on page 70 and then continue as follows:

A-B. Draw a straight line from A to B.

C is the center between A and B.

D from C is the sleeve length measure (inseam) on line squared down from C.

E from D is the half wrist measure plus $\frac{3}{8}$ inch for a seam on line squared out from D.

F from D is the same as E from D on line drawn from E through D.

Finish the sleeve as represented.

One Piece Tight Sleeve

with seam at the middle of the under arm

First make One Piece Tight Sleeve as described above and then continue as follows

A-B-C-D is the original sleeve.

E-F is about the middle of the under-sleeve.

Cut through the sleeve at E-F and place the piece B-C-E-F on the other side of the sleeve so, that B-C should be placed to A-D accordingly the notches, and mark over the new sleeve as represented.

By using this kind of a sleeve be careful that the side seam of the garment should correspond with the seam of the sleeve.

One Piece Tight Sleeve

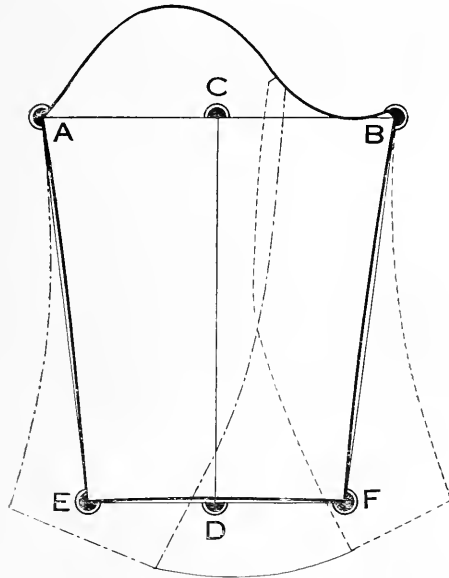

One Piece Tight Sleeve with seam at the middle of the under arm

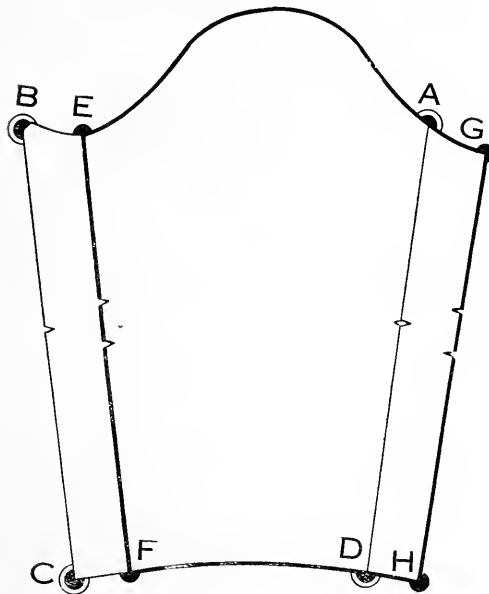

Collars and Lapels

Allow for button stand at the center of front for single breasted 1 to 2 inches, for double breasted 3 to 4 inches.

Showl Collar

Diagram 1

- 1 is the shoulder point.
- 2 from 1 is 1 inch.
- 3 is the end of the break of lapel.
- 4 from 2 is $\frac{1}{4}$ inch more than the width of the back neck on line drawn from 3 through 2.
Square up and down from 4.
- 5 from 4 is $1\frac{1}{4}$ inches.
- 6 from 2 is $1\frac{1}{4}$ inches.
- 7 from 4 is the width of the collar desired.
Allow about $\frac{1}{4}$ inch for spring at point 7.
Shape the collar and lapel as represented.

Single Breasted Lapel and Notch Collar

Diagram 2

From 1 to 7 are the same points as described by the Showl Collar (Diagram 1), then finish the lapel and collar as indicated.

Double Breasted Lapel and Notch Collar

Diagram 3

From 1 to 7 are the same points as described by the Showl Collar (Diagram 1), then finish the lapel and collar as indicated.

Two Piece Collar

Diagram 4

First mark the front and back, then continue as follows:

- 1 is the shoulder point.
- 2 from 1 is $1\frac{1}{4}$ inches.
- 3 is the end of the break of lapel.
- 4 from 2 is the width of the collar desired.
- 5 from 2 is $1\frac{1}{4}$ inches.
- 6 is located by drawing a line from 2 to 3.
Shape the collar and lapel as indicated by points 2-3-4.
Finish the front collar as represented.
Trace over the lapel by breaking the paper on the crease line 2-3, and finish the lapel as represented.
- 7-8 is the back neck.
- 9 from 7 is $2\frac{1}{2}$ inches.
- 10 from 9 is the same width as 8 from 7 on the line squared out from 9.
- 11 from 10 is the same length as 4 from 5 on the front and is located inside from the back shoulder so much as point 4 is outside from the front shoulder.
Finish the back collar as represented.

Collars and Lapels

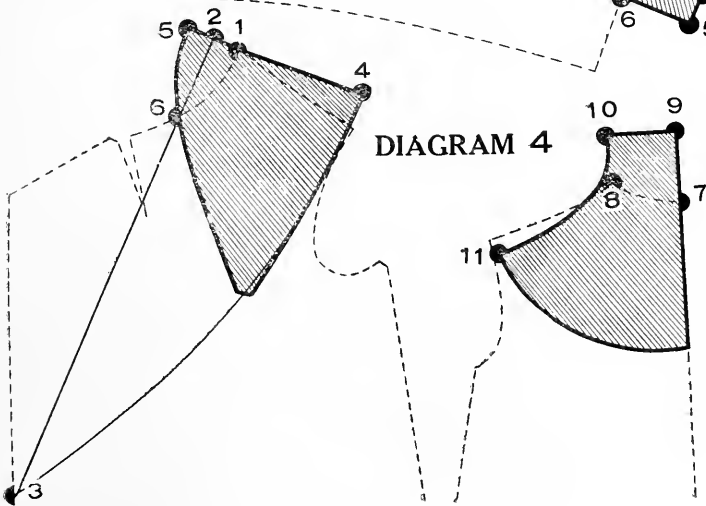
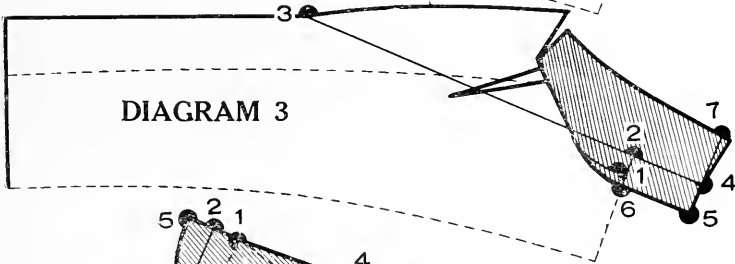
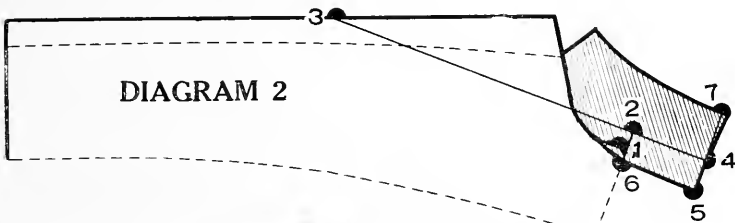
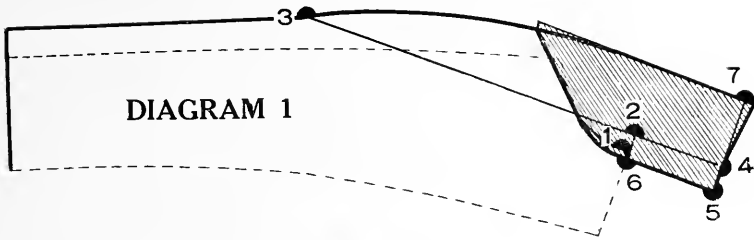

Collars

Ulster Collar

Diagram A

- 1-2. Draw a line from 1 through 2 to 3.
 - 3 from 2 is $\frac{3}{4}$ inch more than the width of the back neck.
 - 4 from 3 is $1\frac{1}{4}$ inches on line squared down from 3.
 - 5 from 1 is $1\frac{1}{4}$ inches on line squared down from 1.
- Draw a straight line from 5 to 4.
Draw a line for the collar stand from 5 through 2 to 3.
- 6 from 3 is the collar width as desired on line squared out from 3.
 - 7 from 6 is $\frac{3}{4}$ inch for spring.
- Shape the collar as indicated.

Standing or Military Collar

Diagram B

- 1-2. Draw a line from 1 through 2 to 3.
 - 3 from 2 is $\frac{3}{4}$ inch more than the width of the back neck.
- Square up and down from 3.
- 4 from 3 is 1 inch.
 - 5 from 3 is 1 inch.
 - 6 from 1 is $1\frac{3}{4}$ inches.
- Shape the collar as represented.

Standing Rolling Ulster Collar

Diagram C

- 1-2. Draw a line from 1 through 2 to 3.
 - 3 from 2 is $\frac{3}{4}$ inch more than the width of the back neck.
 - 4 from 3 is $1\frac{1}{4}$ inches on line squared down from 3.
 - 5 from 1 is $1\frac{1}{4}$ inches.
- Shape the collar stand from 5 through 2 to 3.
- 6 from 4 is the width of collar desired on line squared down from 4.
 - 7 from 6 is $\frac{3}{4}$ inch for spring.
- Shape the collar as indicated.
The stand at 5-2-3 is to be stretched.

Standing Rolling Military Collar

Diagram D

- 1-2. Draw a line from 1 through 2 to 3.
 - 3 from 2 is $\frac{3}{4}$ inch more than the width of the back neck.
- Square up and down from 3.
- 4 from 3 is 1 inch.
 - 5 from 3 is 1 inch.
 - 6 from 1 is $1\frac{3}{4}$ inches.
 - 7 from 5 is the width of the roll collar as desired.
 - 8 from 7 is $\frac{1}{2}$ inch for spring.

- 9 from 6 is the width as desired.

Finish the collar as represented.

The outer leaf of the collar line 9-7-8 must be slightly stretched.

Roll and Button High Collar

Diagram E

- 1 is the shoulder point.
 - 2 from 1 is $1\frac{1}{4}$ inches.
 - 3 is the end of the break of lapel.
 - 4 is located by drawing a line from 3 to 2.
- Draw a line from 4 through 1 to 5.
- 5 from 1 is $\frac{3}{4}$ inch more than the width of the back neck.
 - 6 from 5 is $1\frac{1}{4}$ inches on line squared down from 5.
 - 7 from 5 is the width of the collar desired on line squared up from 5.
 - 8 from 7 is $\frac{1}{2}$ inch for spring.
- Finish the collar as represented.

Standing Lay Down Collar from two pieces

Diagram F

- 1-2-3-4 is the standing collar, which was produced accordingly Diagram B.
 - 5 from 1 is $1\frac{1}{4}$ inches, and is the same length from 2 as 1 from 2.
 - 6 from 2 is the width of the collar desired on line draw from 2 through 3.
 - 7 from 6 is $\frac{1}{2}$ inch for spring.
- Finish the collar as represented.

Storm Collar

Diagram G

For producing this collar take a standing collar and cut it in three pieces.

- 1-2 is the bottom of the standing collar.
 - 3-4 is the top of the standing collar.
 - 5-6 are located by dividing the bottom of three part.
 - 7-8 are produced by dividing the top line of the collar of three parts.
- Depart the pieces at points 7 and 8 so far as much fullness you desire and finish the collar as represented.
- Allow for seams between the pieces.

Flat Collar

Diagram H

For producing this collar put together the front and back at the shoulder so, that they should overlap $\frac{3}{4}$ inch for taking the seams off, and mark the collar to the shape desired.

Collars

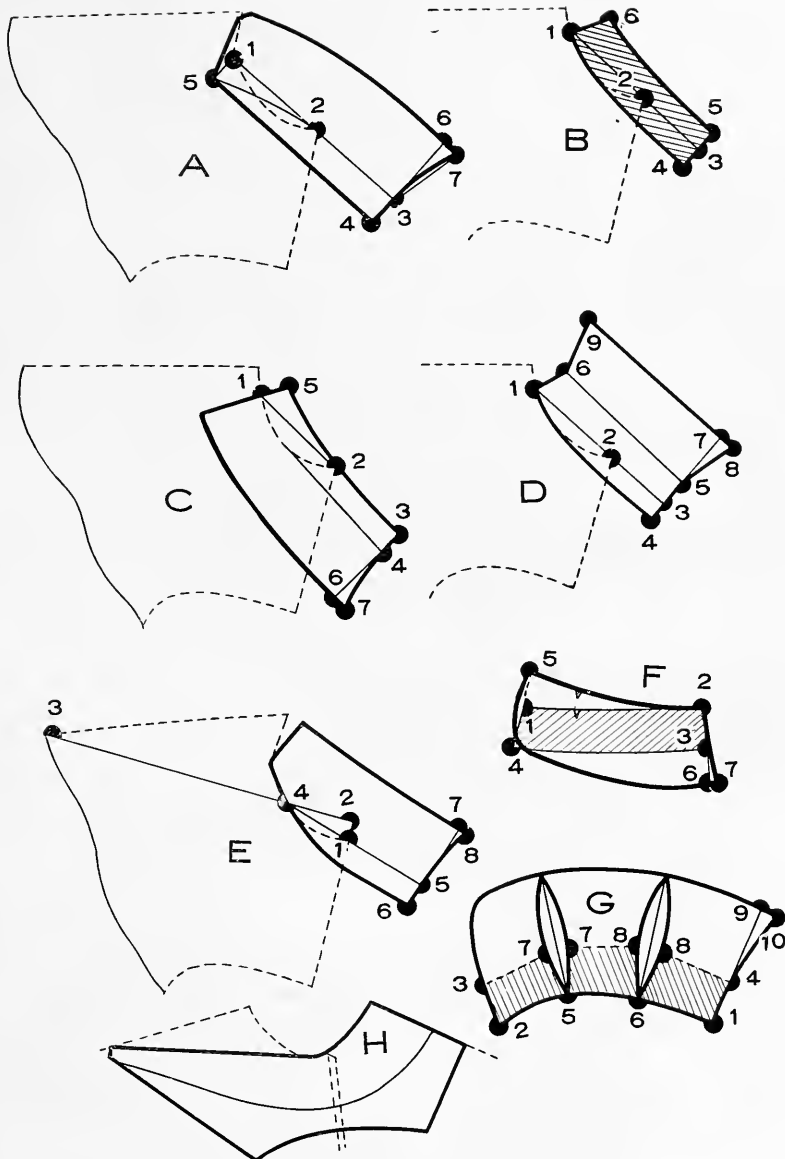

Circular Cape

Diagram 1.

- A** Draw a line from A through B.
B from A is the Back waist-length measure.
C from B is by applying a tight-fitting back pattern 2 inches, by a semi fitting back pattern 1 $\frac{1}{2}$ inches, and by a loose box coat back pattern draw line A-B on the back center line of the pattern.
D is located by placing the back and front together at the shoulder so, that figuring the seams off they should overlap $\frac{3}{4}$ inch, and finish the circular cape as represented.

Cape with One Shoulder Dart

Diagram 2.

- To produce a cape with one shoulder dart continue on the circular cape (Diagr. 1) as follows:
E is the center between A and D.
F is located by a line squared out from E.
G is located by a line drawn from E through F.
H from F is the length of shoulder.
I from G is the half amount of fullness, which we want to take out for producing a shoulder dart.
J from G is the same as I from G.
 Open the shoulder seam F-H.
 Take out fullness H-I-J-H.
 Join together lines H-I with H-J, and it will form a shoulder dart F-H-F as represented on Diagram 2.
 Allow for seams at the shoulder dart, and finish as represented.

Cape with Two Shoulder Darts

Diagram 3.

- To Produce a cape with two shoulder darts continue on the circular cape (Diagr. 1) as follows:
K from F is $\frac{1}{2}$ inch.
L from G is $\frac{1}{2}$ inch.
M from K is the shoulder length on line drawn from K to L.
N from K is 1 $\frac{1}{2}$ inches.
O from M is 3 inches and from N is the shoulder length.
P is located by drawing a line from M through O.
Q from L is to be taken out fullness as desired.
R from L is to be taken out fullness as desired.
S from P the same as Q from L.
T from P is the same as R from L.
 Open the shoulder seams from K to M and from N to O.
 Take out fullness R-M-Q and S-O-T.
 Join together lines R-M with Q-M, also S-O with T-O to form the two shoulder darts.
 Allow for seams at the darts, and finish as represented.

Capes

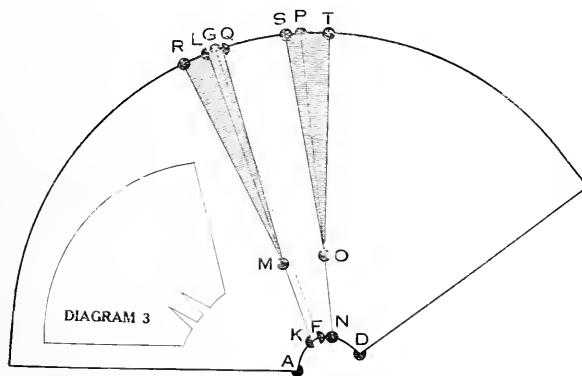
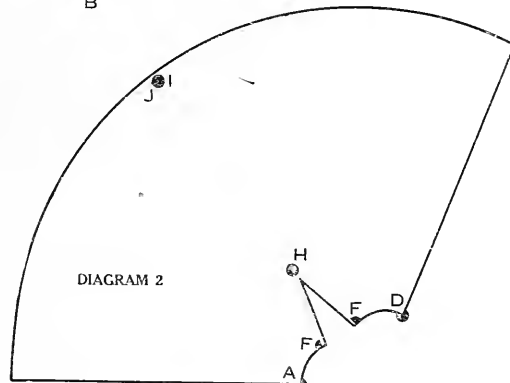
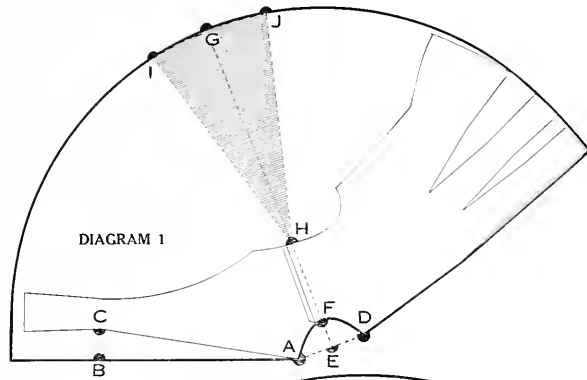

Yoke

To produce a yoke lay the back and front together at the shoulder so, that they should overlap $\frac{3}{4}$ inch for figuring the seams off, and finish the yoke as represented.

Hood

The hood is constructed from a cape as follows :

A-B is 10 inches, or more or less accordingly style or taste.

C from **B** is 1 inch less than **A-B**, in this case say 9 inches.

D from **C** is one third of the length of line **B-C**, in this case say 3 inches.

E from **D** is 1 inch.

Finish the hood as represented.

Yoke

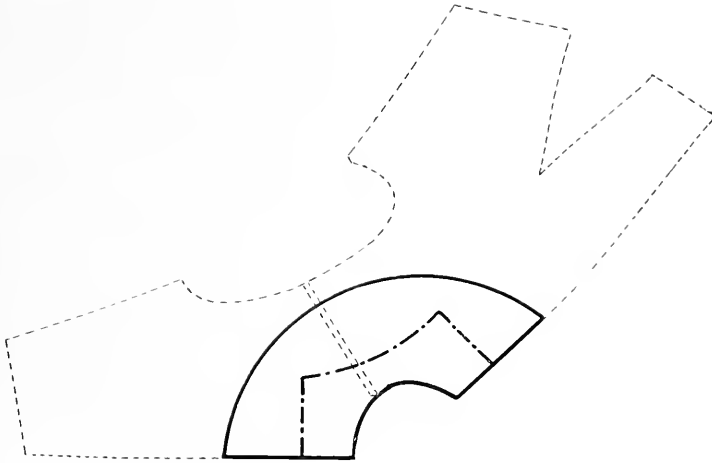

Hood

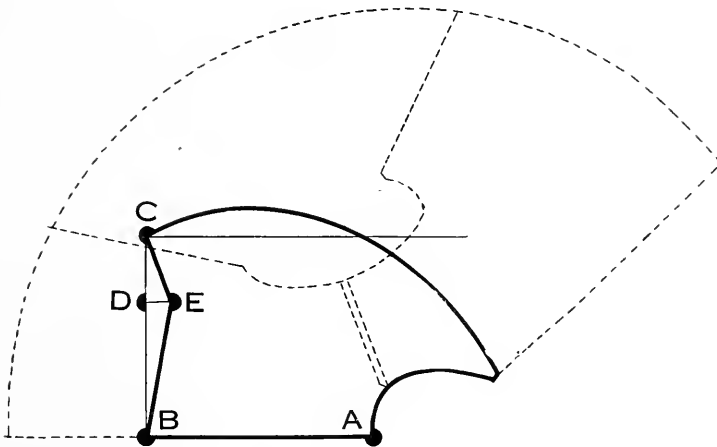

Cape Coat

To produce a Cape Coat proceed as follows :

Take a loose box coat pattern and mark the front as it is represented by points 1 - 2 - 3 - 4 - 5 - 6 - 1.

Place the back part so that points 9 and 10 should be with points 3 and 4 in one direction, and in the same time be careful that points 7 and 8 should be in the same direction as points 1 and 2.

Mark the back pattern as represented by points 7 - 8 - 9 - 10 - 11 - 12 - 7,

13 is the center between 1 and 7.

14 from 4 is allowed for fulness desired.

Shape the side seam as represented by points 13 - 2 - 14.

The front of the Cape Coat is 6 - 13 - 2 - 14 - 5 - 6.

The back of the Cape Coat is 12 - 13 - 2 - 14 - 11 - 12.

Cape Coat

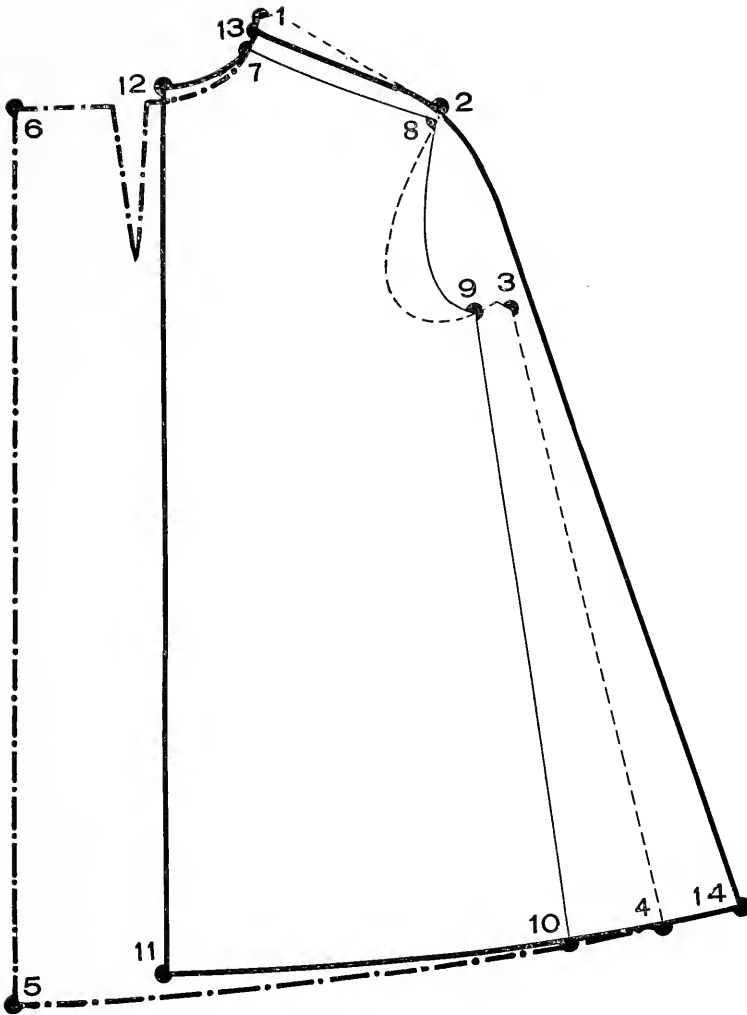

Cape with Kimono Sleeves

First produce a Cape Coat as described on page 82, then continue as follows:

Draw a straight line from 13 through 2 till 15.

15 from 13 is the sleeve length desired.

15 from 2 is the same length as 15 from 2.

Draw a curved line from 15 to 16 as represented.

The front is 13 - 2 - 15 - 16 - 14 - 5 - 6 - 13.

The back is 13 - 2 - 15 - 16 - 14 - 11 - 12 - 13.

Cape with Kimono Sleeves

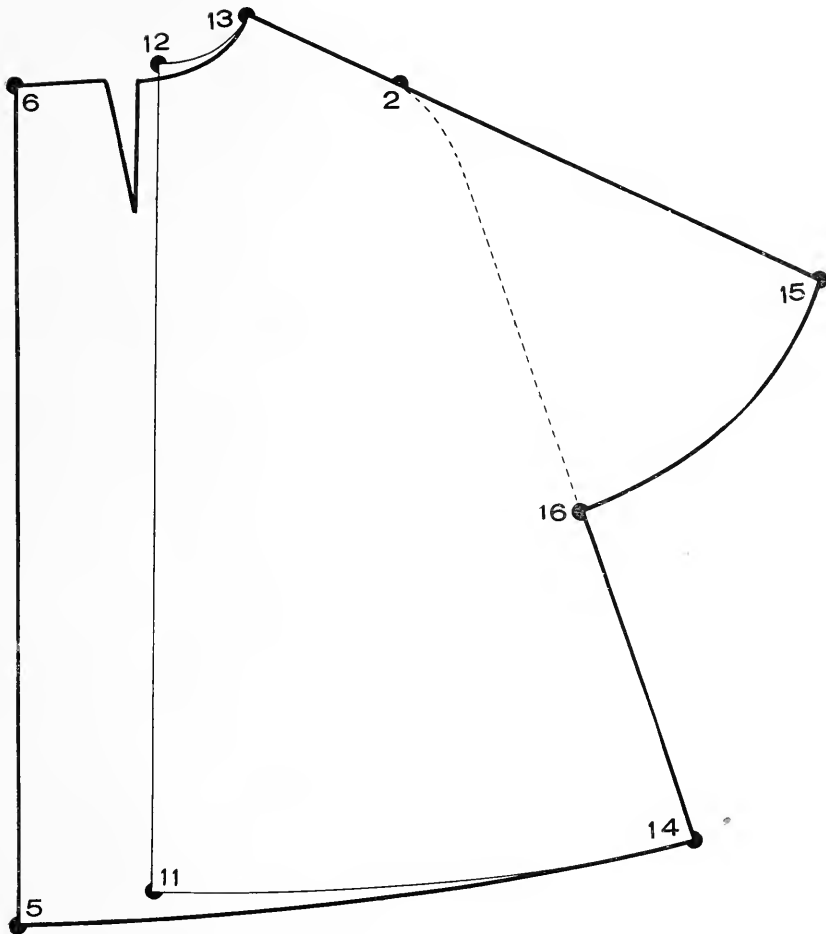

Coat with Kimono Sleeves

- A.** Square both ways from A as represented.
- B** from A is the Scye depth measure.
- C** from A is the Back waist length measure.
- D** from A is the full length desired.
- E** from B is the half Bust measure plus 4 inches.
- G** from E is $\frac{1}{4}$ part of B-E.
- I** from A is $5\frac{1}{2}$ inches.
- J** from I is $2\frac{1}{4}$ inches.
- K** from A is the half of E-G.
- L** is located by a line squared out from K.
- M** from B is $\frac{1}{4}$ part of B-E plus 2 inches.
- N** from M is $\frac{3}{8}$ inch less than B from A.
- Q** from I is $\frac{3}{4}$ inch.
- R** is located by drawing a line from A through Q.
- S** from G is $3\frac{1}{4}$ inches.
- T** from S is $1\frac{3}{4}$ inches less than R from G.
- W** from R is 2 inches.
- X** from W is $\frac{3}{4}$ inch more than K from A.
- Y** is located by a line squared down from E.
- 1** from A is $\frac{3}{8}$ inch.
- 2** from C is $1\frac{1}{2}$ inches.
- 3** is located by a line drawn from A through 2.
- 4** is the center between S and M.
- 5** is located by a line squared down from 4.
- 6** from 4 is $\frac{1}{2}$ inch.
- 7** from 5 is $1\frac{3}{4}$ inches.
- 8** is located by a line drawn from 6 through 7 and a line squared out from 1-3.
- 9** from L is $28\frac{1}{4}$ inches.
- 10** from 7 is $\frac{3}{4}$ inch.
- 11** is located by drawing a line from 10 parallel with line C-Y and a line squared down from 9.
- Finish the back as represented.
- 12** from 4 is $\frac{1}{2}$ inch.
- 13** from 5 is $1\frac{3}{4}$ inches.
- 14** is located by drawing a line from 12 through 13.
- 15** is located by drawing a line from R through T and is the same length as L-9.
- 16** is located by a line squared out from 15 and is $\frac{1}{2}$ inch wider from 15 than 11 from 9.
- 17** from 13 is $2\frac{1}{2}$ inches. 14 from 17 is the same length as 8 from 10.
- 18** from 17 is the same length and shape as 11 from 10.
- 19** is located by a line squared down from G.
- 20** from 19 is $\frac{3}{4}$ inch.
- 21** is located by a line squared down from 20-Y.
- 22** from 21 is $2\frac{1}{4}$ inches.
- Allow 2 inches for single breasted button stand and finish the front as represented.
- Seam allowances of $\frac{3}{8}$ inch allowed.
- For a whole back take off at the back center $\frac{3}{8}$ inch seam as represented.

Coat with Kimono Sleeves

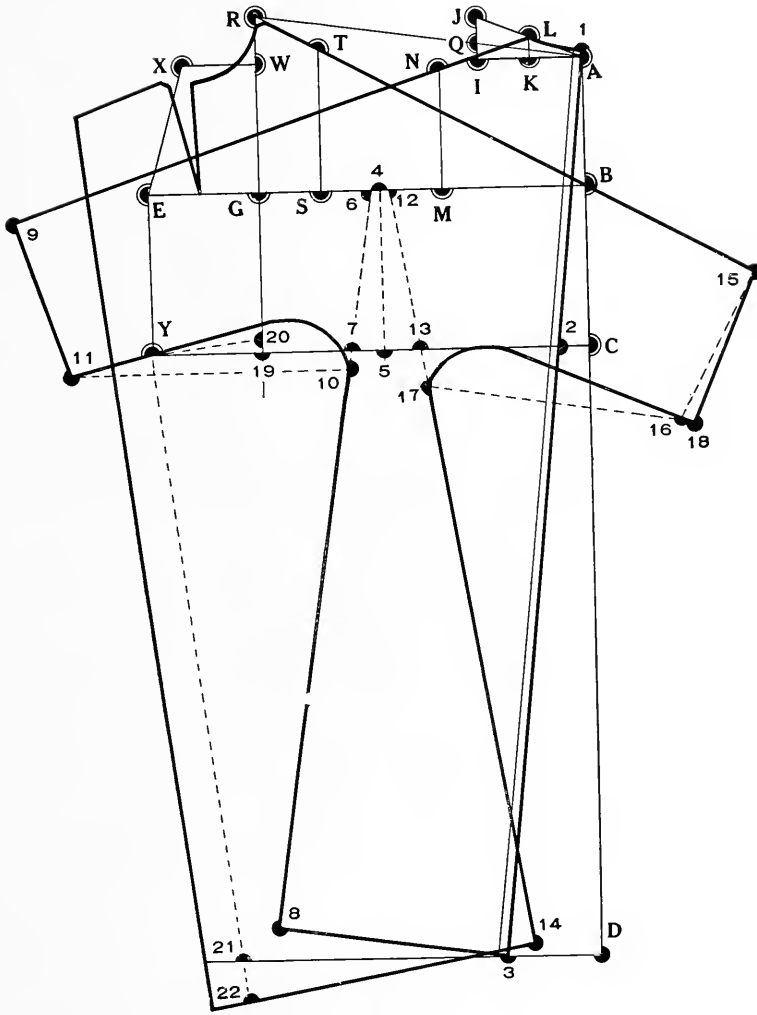

Raglan Coat

First lay up all points as described in Systematic Outline, then continue as follows:

- 1 is located by a line squared down from F.
- 2 is located by a line squared down from E.
- 3 from C is 1 inch.
- 4 from D is $\frac{1}{2}$ inch.
- 5 from F is $\frac{3}{4}$ inch.
- 6 from Z is $1\frac{1}{4}$ inches.

Finish the back as represented.

- 7 from F is $\frac{3}{4}$ inch.
- 8 from Z is $1\frac{1}{4}$ inches.
- 9 from I is 1 inch.
- 10 from G is 1 inch.
- 11 from R is $1\frac{3}{4}$ inches.
- 12 from 10 is the same length as 11 from 10 on line squared up from 10, and is located by a line swept forward from R pivoting at point 10.
- 13 from 10 is $2\frac{1}{4}$ inches.
- 14 from R is $\frac{3}{4}$ inch.

Draw a line from 14 to the arm scye below point V as represented.

- 15 is located by drawing a curved line $\frac{3}{4}$ inch above the line drawn from 14 to below V.
- 16 from 12 is the same as 15 from 11.
- 17 from 13 is $\frac{3}{4}$ inch.

Draw a line from $\frac{3}{4}$ inch below L to the arm scye at the back as represented, and shape above this line 1 inch.

- 18 from E is $\frac{3}{4}$ inch.
- 19 from 2 is $\frac{1}{2}$ inch.

Draw a line from 18 through 19 for the front centre. Allow 2 inches for button stand.

- 20 from 13 is 1 inch, and draw the crease line.
- 21 from A is the desired length.
- 22 is located by drawing a line from 18 through 19.
- 23 from 22 is $1\frac{1}{4}$ inches.

Cut off the shoulder pieces from the front and back and add these pieces to the top sleeve as represented to make the raglan sleeve.

In this draft are $\frac{3}{8}$ inch seams allowed except where the shoulder pieces were cut off, has to be allowed for seams.

Raglan Coat

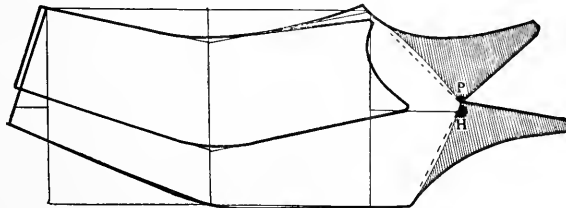
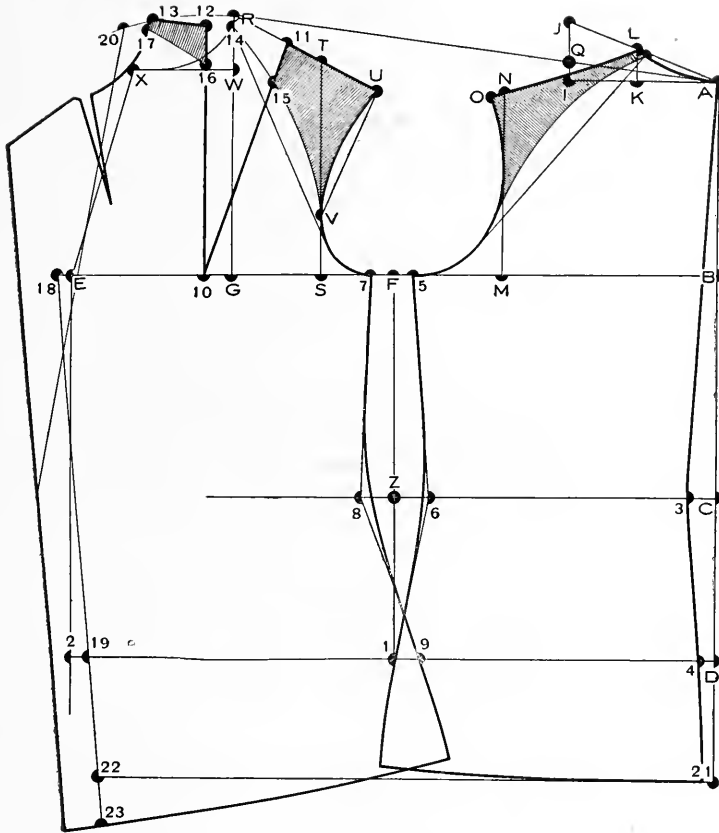

Deep Armhole Coat

Diagram 1

First draft and cut out a coat with Kimono sleeves as described on page 86, then continue as follows:

Lay together the front and back at the shoulder seam so, that they should overlap $\frac{3}{4}$ inch for taking the seams off, and mark the coat from one piece.

1 - 2 - 3 - 4 - 5 - 6 - 7 - 1 is the front.

8 - 9 - 10 - 11 - 12 - 13 - 14 - 8 is the back.

Diagram 2

15 is the center between 7 and 8.

16 from 15 is $\frac{3}{4}$ inch, more or less accordingly style or taste.

17 from 15 is the same as 16 from 15.

18 from 4 is 2 inches, more or less accordingly style or taste.

19 from 11 is the same as 18 from 4.

Shape the seams from 16 to 18 and from 17 to 19 accordingly style or taste as represented.

20 from 16 is the same length as the shaped line is from 16 to 18 and is shaped inside accordingly fullness desired under the arm.

21 from 17 is the same length as the shaped line is from 17 to 19 and is shaped inside the same way as point 20.

Finish the draft as represented.

By cutting out the patterns allow for seams at lines 16 - 18, 16 - 20, 17 - 19 and 17 - 21.

Deep Armhole Coat

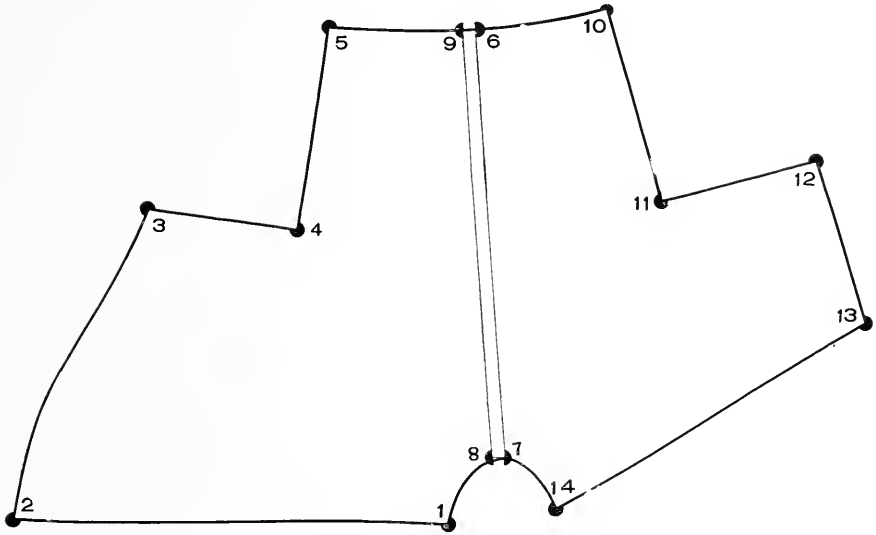

Diagram 1

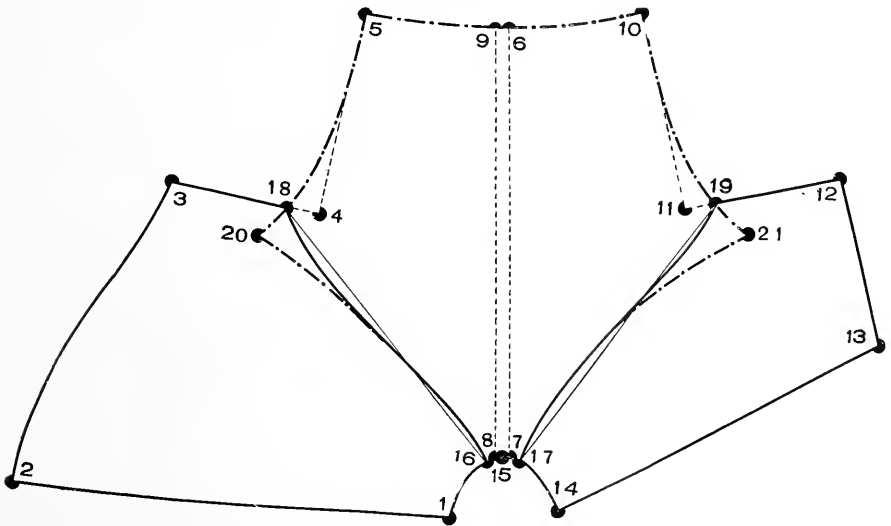

Diagram 2.

One Piece Coat

This pattern is constructed from a semi-fitting block pattern as follows:

Lap over the two front parts at the bust of $\frac{3}{4}$ inch for taking the seams off as represented by A and B, and open the patterns at the hip line of 1 inch as C to D.

By applying this method be careful that the notches at the waist line should be in the same direction as E-F.

Put together the front and back at the side seam at G-H.

Lay over the two back patterns at the shoulder of $\frac{3}{4}$ inch for taking the seams off as represented by I and J, and put together the same pattern at the hip line at K.

Be careful that the notches at the waist line should be in the same direction as L-M.

Continue the line N-O to the length desired.

If a whole back is required, take off $\frac{3}{8}$ inch seam at points P-Q and connect the same with a straight line.

Allow for button stand as much desired.

R is the end of the crease line.

S is 1 inch from the neck point.

Finish the draft as represented.

One Piece Coat

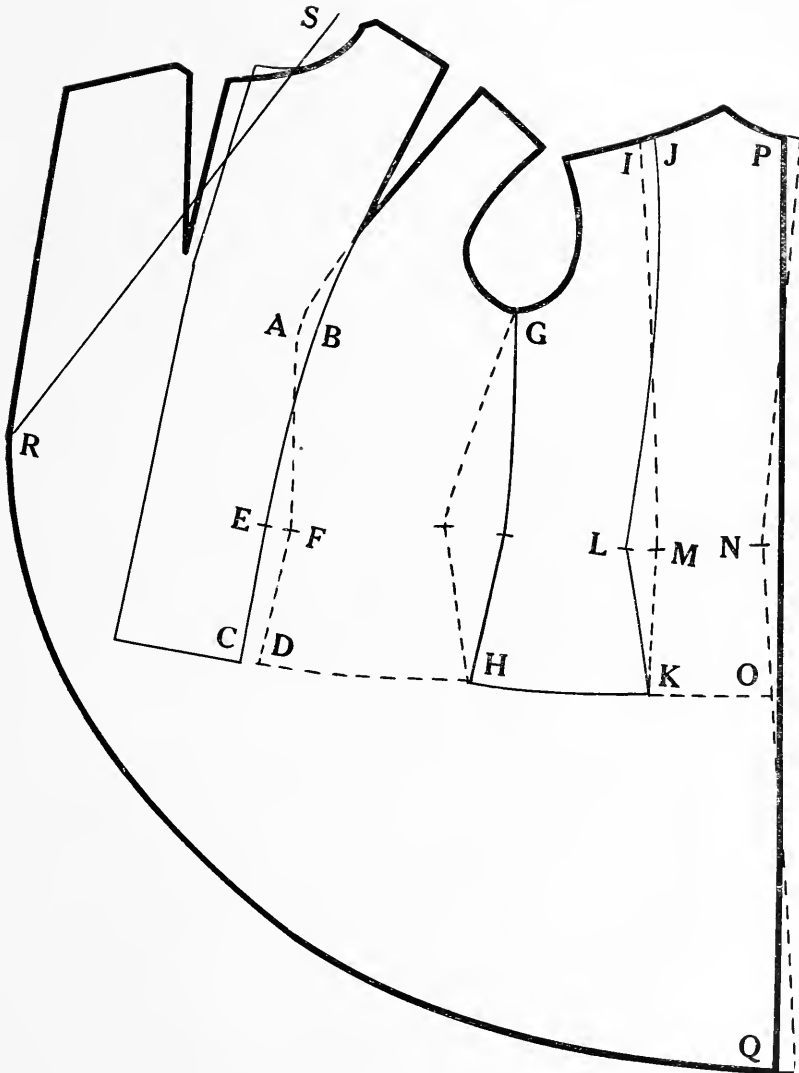

New Market

To make a New Market Coat or a Skirted Jacket proceed as follows :

Cut out the pattern as represented by the upper diagram,

Cut off the skirt at the waist line as represented by 1 - 2 - 3 - 4 - 5.

Put the skirt pieces together so, that they should overlap $\frac{3}{4}$ inch at the waist and hip for taking off the seams and mark the skirt in one piece as represented by heavy line on the diagram below.

New Market

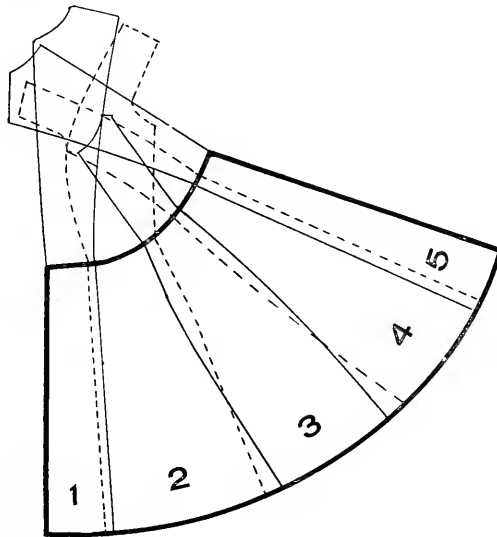
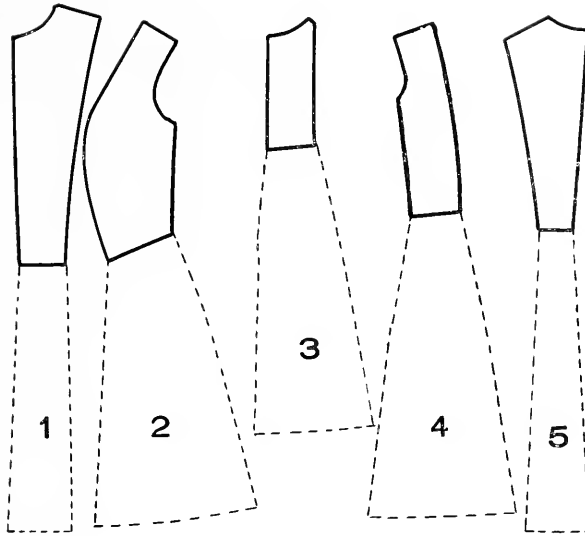

Inverness

First lay up all points as described in Systematic Outline, then continue as follows:

1 from Z is $\frac{1}{2}$ inch.

2 from Y is $2\frac{1}{4}$ inches.

Connect points C-1 and 1-2 for the fashionable waist line.

3 from A is the full length measure.

Square out from 3 as represented.

4 is located by a line squared down from M.

5 from C is $\frac{3}{4}$ inch.

6 from A is $\frac{3}{4}$ inch.

7 from L is $\frac{1}{4}$ inch.

8 from 4 is $\frac{1}{2}$ inch.

9 is located by drawing a line from P through 8.

Finish the back as represented.

10 from 2 is $\frac{1}{2}$ inch.

11 is located by drawing a line from E through 10.

12 from 4 is 3 inches.

13 is located by drawing a line from M through 12, and is from M the same length as 9 from M.

14 from 11 is 1 inch.

15 from M is 3 inches.

16 from R is $\frac{3}{4}$ inch.

17 is the center of A-B.

Draw a line from 16 through 17.

18 from F is the Sleeve length measure.

19 is located by a line swept from 18 pivoting at point 16.

20 is located by a line swept from 18 pivoting at point 16.

21 from 19 is 1 inch.

Allow for button stand $2\frac{1}{2}$ inches for single breasted, $3\frac{1}{2}$ inches for double breasted.

22 from 16 is 1 inch.

23 is the length of the crease line.

Draw a line from 22 to 23.

Finish the draft as represented.

16-20-18-21 is the cape.

Inverness

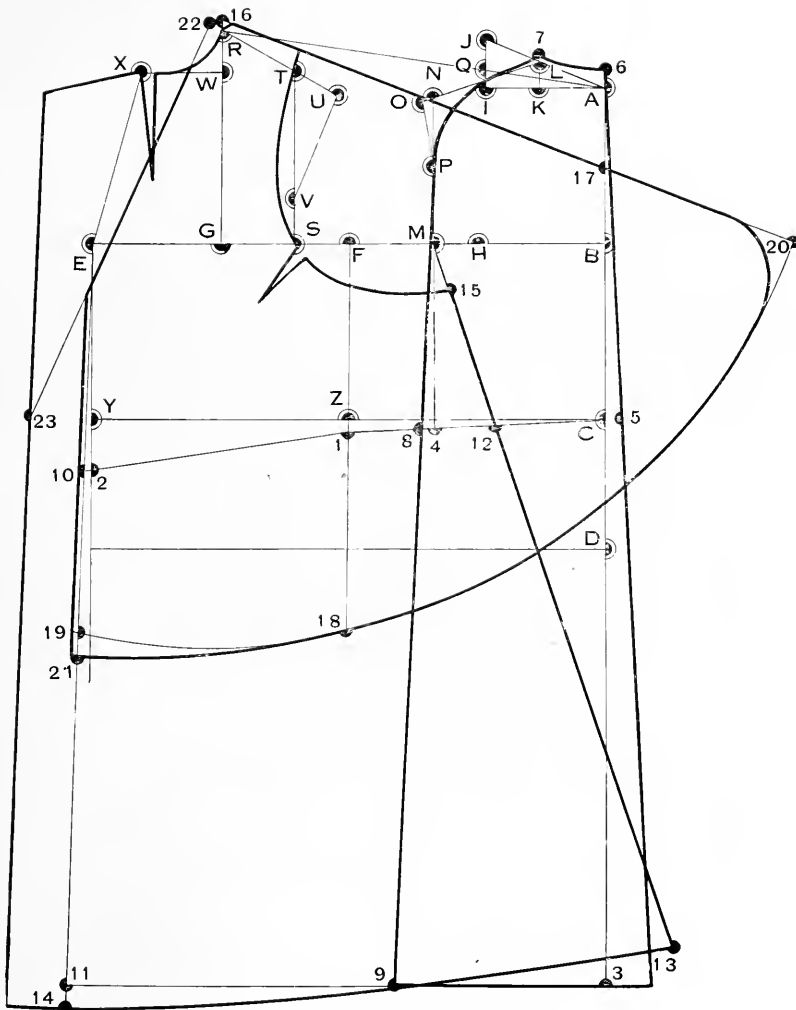

Opera Cloak

Measures

Scye depth $7\frac{1}{4}$ inches.
 Back waist length $15\frac{1}{2}$ inches.
 Full length 50 inches.

Bust 40 inches.
 Waist 26 inches.
 Hips 41 inches.

To Draft

1. Square both ways from 1 as represented.
- 2 from 1 is the Scye depth measure.
- 3 from 1 is the Back waist length measure.
- 4 from 3 is 6 inches.
- 5 from 1 is the full length measure.
 Square out lines from 2, 3, 4 and 5 as represented.
- 6 from 1 is $5\frac{1}{2}$ inches.
- 7 from 6 is $2\frac{1}{4}$ inches on line squared out from 6.
- 8 from 2 is one-quarter of the Bust measure plus 2 inches, in this case 12 inches.
- 9 is located by a line squared down from 8.
- 10 from 8 is half of the distance 2-8, in this case 6 inches.
 Square up from 10 as represented.
- 11 from 6 is $\frac{3}{4}$ inch.
- 12 is located by drawing a line from 1 through 11.
- 13 is the center of 2-8.
- 14 from 13 is 2 inches.
- 15 from 14 is $\frac{3}{8}$ inch less than the Scye depth measure on line squared up from 14.
- 16 from 1 is half of the distance 2-13, in this case 3 inches.
- 17 is located by a line squared up from 16.
- 18 from 15 is $\frac{1}{2}$ inch on line drawn from 17 through 15.
- 19 is the center of 14-15.
- 20 from 2 is $\frac{1}{2}$ inch.
- 21 from 8 is the same as 16 from 1.
- 22 from 21 is the same as 21 from 14.
- 23 from 22 is $3\frac{1}{4}$ inches.
- 24 from 23 is the same as 13 from 2, in this case 6 inches.
- 25 from 23 is the same as 12 from 10 on line squared up from 23.
- 26 from 22 is $1\frac{3}{4}$ inches less than 25 from 23.
- 27 from 25 is the same as 18 from 17 on line drawn from 25 through 26.
- 28 from 14 is 1 inch.
- 29 from 22 is 1 inch.
- 30 from 21 is about $1\frac{3}{4}$ inches on line squared up from 21.
 Sweep line from 29 to 28 pivoting at point 30.
- 31 from 25 is 2 inches.
- 32 from 31 is $\frac{3}{4}$ inch more than 16 from 1 on line squared out from 31.
- 33 is located by a line squared out from 24.
- 34 from 9 is $\frac{1}{2}$ inch.
- 35 from 33 is $2\frac{1}{4}$ inches.
- 36 from 35 is $\frac{1}{2}$ inch.
- 37 is located by a line drawn from 24 through 36.
- 38 from 37 is 1 inch.
 Finish the draft as represented.

Opera Cloak

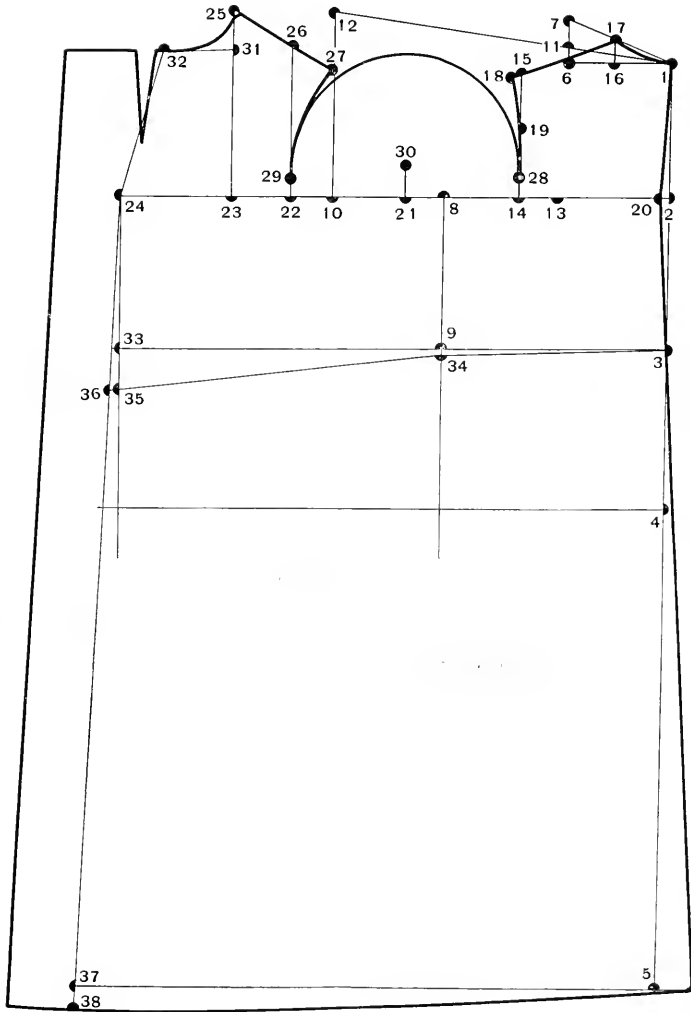

Manipulation of Fronts and Backs

The Back

The back part is drawn by heavy lines, and is constructed with a seam at the back center.

If no seam is wanted at the back center proceed as follows:

Draw a straight line from 1 through 2 to 5.

Cut off the piece 5 - 3 - 2 - 5 and add the same to the back as represented from 4 to 6.

Take off the seam $\frac{3}{8}$ inside from line 1 - 5 as represented by line 7.

The Front

The front part is drawn by heavy lines and is constructed with a seam at the front center.

If no seam is wanted at front center, proceed as follows:

Continue the straight chest line as represented by a straight line 8 - 13 - 14.

Take out at the front dart so much fulness as much you gained at the front center by drawing the line 8 - 13 - 14.

Take out fulness as follows:

15 from 11 is the same as 13 from 9.

16 from 12 is the same as 14 from 10.

Take off the seam $\frac{3}{8}$ inch inside from line 8 - 13 - 14 as represented by line 17.

Manipulation of Fronts and Backs

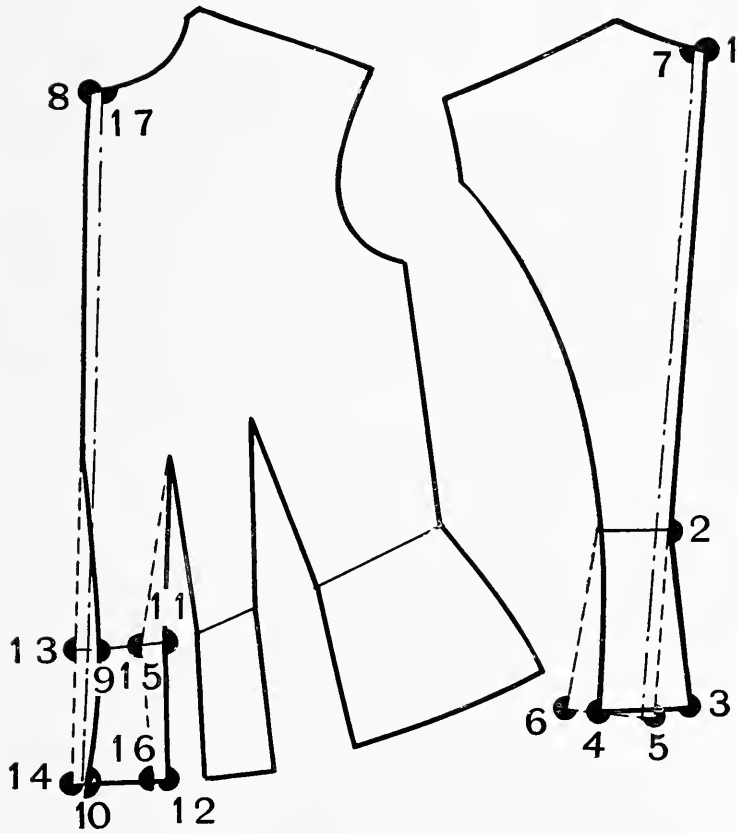

Single Breasted Vest

First lay up all points to measure as described in Systematic Outline, then continue as follows:

- 1 from Z is $\frac{1}{2}$ inch.
- 2 from Y is $2\frac{1}{4}$ inches.

Draw lines from C to 1 and from 1 through 2 for the fashionable waist line as represented.

- 3 from C is 2 inches.
- 4 is the half-way between F and M.
- 5 from 4 is $\frac{3}{4}$ inch.
- 6 from 1 is 4 inches.

Finish the back as represented.

- 7 from 4 is $\frac{3}{4}$ inch.
- 8 from 2 is $1\frac{3}{4}$ inches.

Draw line from E to 8.

- 9 from G is $3\frac{1}{4}$ inches.
- 10 from 9 is $1\frac{1}{2}$ inches on line drawn from 9 parallel with line 1-2.
- 11 is located by drawing a line from 10 parallel with line E-8.
- 12 from 11 is $1\frac{1}{4}$ inches.
- 13 from 11 is $2\frac{3}{4}$ inches.
- 14 from 10 is the same length as 12 from 10.
- 15 from 12 is about 5 inches on line drawn from 12 parallel with line 10-11.
- 16 from 14 is the same as 15 from 12 on line drawn from 14 parallel with line 10-11.
- 17 from 1 is $2\frac{1}{4}$ inches.
- 18 from the neck gorge is $\frac{3}{4}$ inch.
- 19 from U is $\frac{1}{2}$ inch.

Allow 1 inch for button stand and finish the front as represented.

- 20 from 3 is 3 inches.
- 21 from 6 is 3 inches.

Take out $\frac{1}{4}$ inch above line 3-6 and 1 inch below the line 3-6 and finish the skirt as represented.

Single Breasted Vest

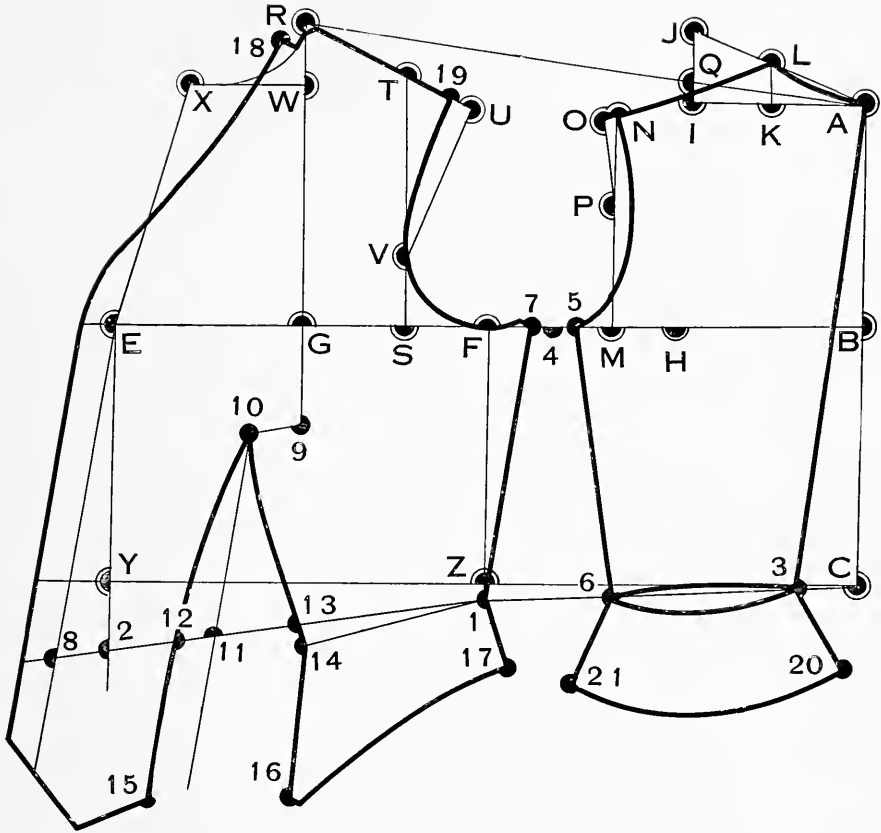

Tight-Fitting Double Breasted Vest

First lay up all points to measure as described in Systematic Outline, then continue as follows:

1 from Z is $\frac{1}{2}$ inch.

2 from Y is $2\frac{1}{4}$ inches.

Draw lines from C to 1 and from 1 through 2 for the fashionable waist line as represented.

3 from C is 3 inches.

4 from 1 is 3 inches.

Draw line from 3 to 4.

5 from C is 2 inches.

6 is located by drawing a line from A to 5.

7 from 3 is $1\frac{1}{2}$ inches.

8 is the center between F and M.

9 from 8 is $\frac{3}{4}$ inch.

10 from 1 is $2\frac{1}{2}$ inches.

11 from 4 is 2 inches.

12 is the center between 6 and 9.

13 is the center between 7 and 11.

14 from 10 is $\frac{3}{8}$ inch less than the center between 10 and 5.

15 from 14 is $\frac{3}{4}$ inch.

Finish the back as represented.

16 from 8 is $\frac{3}{4}$ inch.

17 from 4 is 1 inch.

18 from 2 is $1\frac{3}{4}$ inches.

19 from G is $3\frac{1}{4}$ inches.

20 from 19 is $1\frac{1}{2}$ inches on line drawn from 19 parallel with line 1-2.

21 is located by drawing a line from 20 parallel with line E-18.

22 from 21 is $1\frac{1}{4}$ inches.

23 from 22 is about 5 inches on line drawn from 22 parallel with line 20-21.

24 from 21 is $2\frac{3}{4}$ inches.

25 from 20 is the same length as 22 from 20.

26 from 25 is the same as 23 from 22 on line drawn from 25 parallel with line 20-21.

27 from the neck gorge is $\frac{3}{4}$ inch.

28 from the front center line E-18 is $2\frac{1}{2}$ inches for button stand.

29 from U is $\frac{1}{2}$ inch.

Make the french cut as described on page 36, and finish the front as represented.

Tight-Fitting Double Breasted Vest

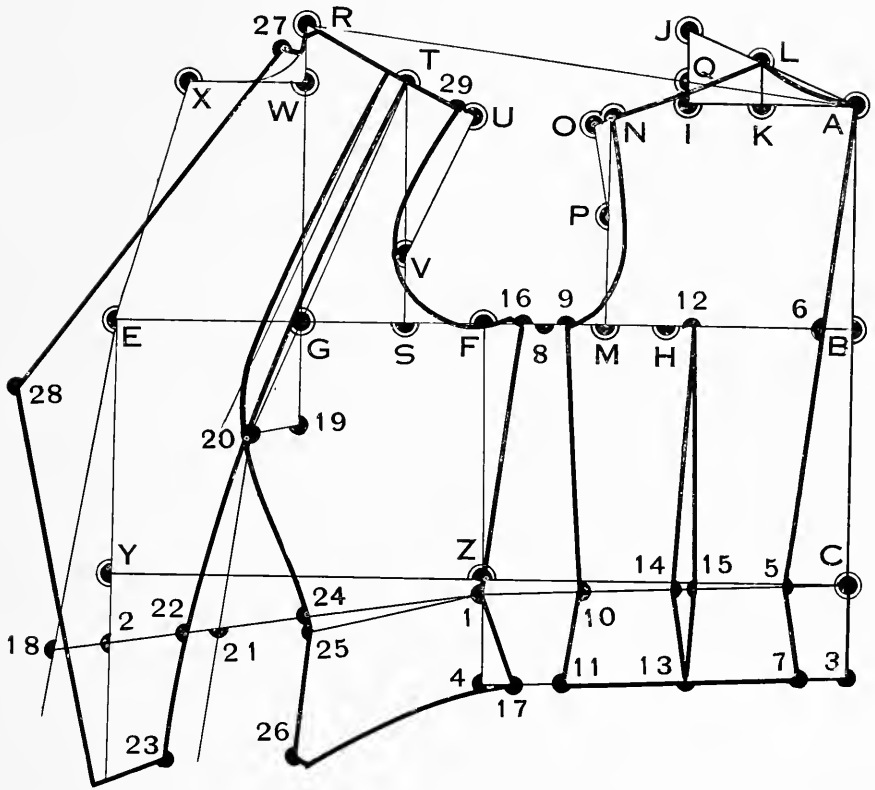

By applying the System for Stout or Maternity sizes pay attention to the Waist Suppression and Hips Development as described on page 20.

Table of Proportionate Measurements
For Stout or Maternity Sizes

SIZE		37	39	41	43	45	47	49
Height		5 Feet 6 inches	5 Feet 6 inches	5 Feet 6 inches	5 Feet 6 inches	5 Feet 6 inches	5 Feet 6 inches	5 Feet 6 inches
Sleeve depth		7¼	7¼	7¼	7½	7¾	8	8¼
Back waist length		15½	15½	15½	15½	15½	15½	15½
Bust		39	41	43	45	47	49	51
Waist		30	31½	33	34½	36	37½	39
Hips		45	47	49	51	53	55	57
Neck		14	14½	15	15½	16	16½	17
Back width		14	14½	15	15½	16	16½	17
Sleeve (inside seam)		18	18	18	17¾	17½	17¼	17
S K I R T	Front length	42	42	42	42	42	42	42
	Side length	43	43	43	43	43	43	43
	Back length	43	43	43	43	43	43	43

Semi-Fitting French Seam

For Stout or Maternity Sixes

Measures

Scye depth $7\frac{1}{4}$ inches.
 Back waist length $15\frac{1}{2}$ inches.
 Bust 39 inches.
 Waist 30 inches.
 Hips 45 inches

To Draft

First lay up all points to the above measurement as described in Systematic Outline, then continue as follows:

1 from Z is $\frac{1}{2}$ inch.

2 from Y is $2\frac{1}{4}$ inches.

Draw lines from C to 1 and from 1 through 2 for the fashionable waist line as represented.

3 from C is $1\frac{1}{2}$ inches.

4 from 3 is $\frac{1}{4}$ inch.

5 from D is 1 inch.

6 from O is $\frac{3}{4}$ inch.

7 from P is $\frac{3}{4}$ inch.

Draw a line from 6 to 7.

8 is the half-way between 6 and 4, or make the width to style or taste.

9 from 4 is 1 inch more than the distance from A to K.

10 from 5 is $\frac{3}{4}$ inch more than the distance from 4 to 9.

11 is located by drawing a line from 8 to 9 as represented.

Finish the back as represented.

12 from 9 is $\frac{1}{2}$ inch.

13 from 10 is $1\frac{1}{2}$ inches.

14 from F is $\frac{3}{4}$ inch.

15 from 1 is $\frac{3}{4}$ inch.

16 is located by drawing a line from 14 through 15.

17 from 15 is $\frac{1}{2}$ inch.

18 from 8 is $\frac{3}{8}$ inch.

19 from 6 is $\frac{3}{8}$ inch.

20 from 18 is $\frac{1}{4}$ inch.

21 from 7 is the same length as O from P.

Finish the side gore as represented.

22 from 1 is $\frac{1}{2}$ inch.

23 from 16 is 1 inch.

24 from 2 is 2 inches.

25 from C is $3\frac{1}{4}$ inches.

26 from 25 is $1\frac{1}{2}$ inches on line drawn from 25 parallel with line 1-2.

27 is located by drawing a line from 26 parallel with line E-24.

28 is located by drawing a line from 26 through 27.

29 from 27 is $\frac{1}{2}$ inch.

30 from 28 is $\frac{3}{8}$ inch.

31 from 29 is 3 inches.

32 from 26 is the same length as 29 from 26.

33 from 30 is $3\frac{3}{4}$ inches.

34 from R is the same width as L to 8.

Draw a line from 34 to 26.

35 from 34 is $\frac{3}{4}$ inch for seams.

Draw a line from 35 parallel with line 34-26.

36 from 16 is $\frac{1}{4}$ inch.

37 from 22 is the same length as 36 from 17.

38 from 33 is $1\frac{1}{4}$ inches.

39 from 29 is the same length as 38 from 32.

The Systematic waist measure is 14 inches less than the Bust measure, in this case 39 less 14 is 25 inches the Systematic waist measure; the actual waist measure is in this case 30 inches, the half of the difference ($2\frac{1}{2}$ inches) is to be added to the dart as follows:

40 from 31 is $2\frac{1}{2}$ inches.

41 from 26 is the same length as 32 from 26.

42 from 33 is $\frac{1}{2}$ inch more than 40 from 31.

43 from 41 is the same length as 38 from 32.

The Systematic Hip measure is 1 inch more than the Bust measure, in this case 39 plus 1 is 40 inches, the half of this is 20, add to this the same as it is 40 from 31, in this case 20 plus $2\frac{1}{2}$ is $22\frac{1}{2}$ inches the half Hip measure.

Compare this $22\frac{1}{2}$ with the half of the actual Hip measure ($22\frac{1}{2}$); if there is any difference, it has to be taken off by smaller hip, and to be added by larger hip at points 36, 37, 10 and 13 equally divided.

Finish the diagram as represented.

Semi-Fitting French Seam

For Stout or Maternity Sixes

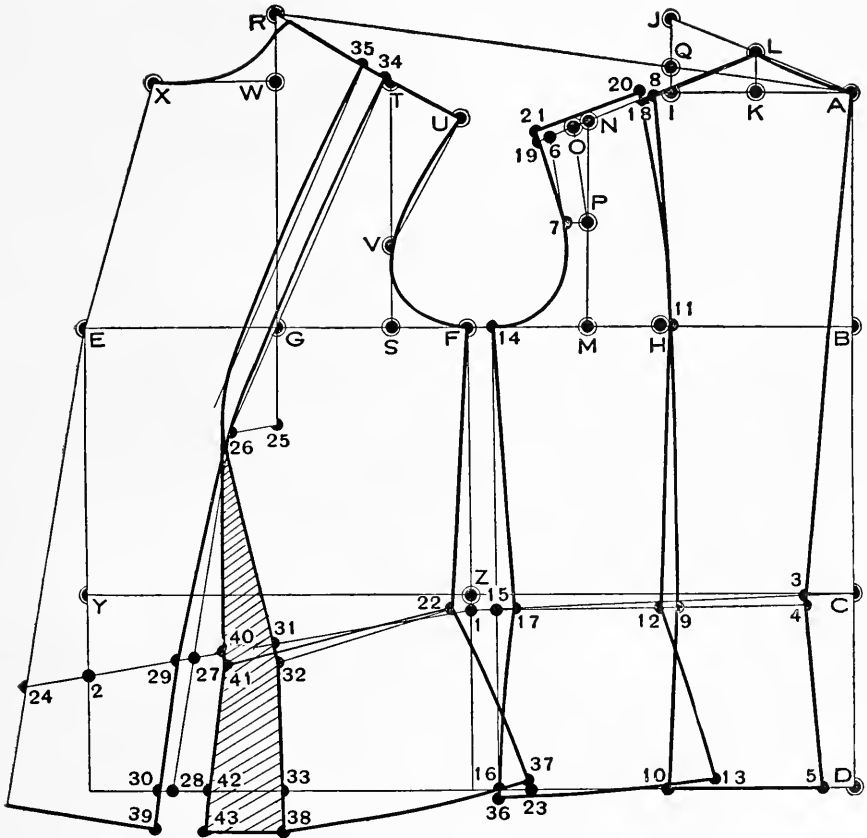

Shirt Waist

First lay up all points to your measure as described in Systematical Outline, then continue as follows:

1 from Z is $\frac{1}{2}$ inch.

2 from Y is $2\frac{1}{4}$ inches.

Draw lines from C to 1 and from 1 to 2 for the fashionable waist line as represented.

3 from C is 4 inches.

4 from 1 is 4 inches.

5 is located by a line squared up from D.

Draw lines between 3-4 and 5 as represented.

6 from C is 2 inches.

7 from 4 is $\frac{3}{4}$ inch.

Draw lines A-6-7 for tight-fitting back, and for loose back draw line from A to 7.

8 is the center of F-M.

9 from 8 is $\frac{1}{2}$ inch.

10 from 8 is $\frac{1}{2}$ inch.

11 from 1 is 4 inches.

12 is the center of 1-11.

13 from 12 is $2\frac{1}{2}$ inches.

14 is located by drawing a line from X through E and is from E the same length as 5 from E.

Finish front and back as represented.

The back center for tight-fitting back is A-6-7 and for gathering the back at the waist allow fulness in the waist by drawing a line from A to 3 as represented.

Shirt Waist

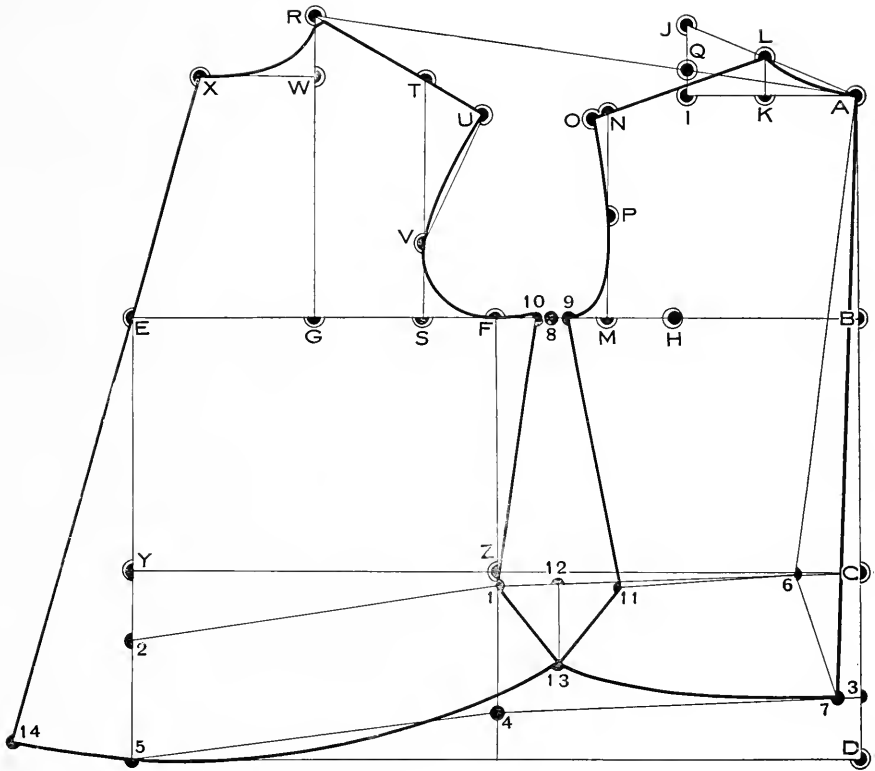

Shirt Waist with Side Gore

First lay up all points to measure as described in Systematical Outline then continue as follows:

1 from Z is $\frac{1}{2}$ inch,

2 from Y is $2\frac{1}{4}$ inches.

Draw lines from C to 1 and from 1 to 2 for the fashionable waist line as represented.

3 from C is 4 inches.

4 from 1 is 4 inches.

5 is located by a line squared up from D.

6 from C is 2 inches.

7 from 3 is $1\frac{3}{4}$ inches.

8 from M is $1\frac{1}{4}$ inches.

9 from 8 is $\frac{1}{2}$ inch.

10 from 6 is 1 inch more than the space from A to K.

11 from 7 is 1 inch more than the space from 6 to 10.

12 is located by shaping the line from 9 to 10,

Finish the back part as represented.

13 from 10 is $\frac{3}{4}$ inch.

14 from 11 is $1\frac{1}{2}$ inches and is from 13 the same length as 11 from 10

15 from F is $\frac{3}{4}$ inch.

16 from 1 is $\frac{3}{4}$ inch.

Draw line from 15 to 16.

17 from 16 is $\frac{3}{4}$ inch.

18 from 1 is 1 inch.

19 is the centre of 17-18.

20 from 19 is $2\frac{1}{2}$ inches.

21 is located by drawing a line from X through E, and is from E the same length as 5 from E

Finish the side gore and front as represented.

Shirt Waist with Side Gore

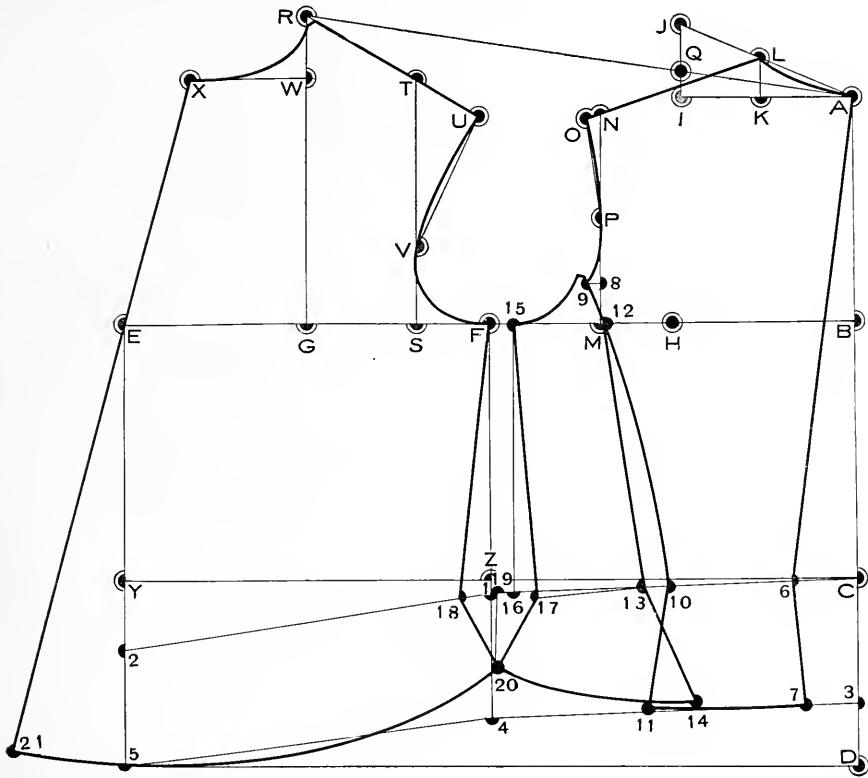

Tight-Fitting Waist Lining

First lay up all points to measure as described in Systematical Outline, then continue as follows:

1 from Z is $\frac{1}{2}$ inch.

2 from Y is $2\frac{1}{4}$ inches.

Draw lines from C to 1 and from 1 through 2 for the fashionable waist line as represented.

3 from C is 4 inches.

4 from 1 is 4 inches.

5 is located by a line squared up from D.

Draw lines between 3-4 and 5 as represented.

6 from C is 2 inches.

7 from 3 is $\frac{3}{4}$ inch.

8 is the centre of F-M.

9 from 8 is $\frac{3}{4}$ inch.

10 from 8 is $\frac{3}{4}$ inch.

11 from 1 is 4 inches.

12 is the centre of 1-11.

13 from 12 is $2\frac{1}{2}$ inches.

Finish back part as represented:

14 from 2 is $1\frac{3}{4}$ inches.

15 is located by drawing a line from E through 14.

16 from G is $3\frac{1}{4}$ inches.

17 from 16 is $1\frac{1}{2}$ inches on line drawn parallel with line 1-2.

18 is located by drawing a line from 17 parallel with line E-14.

19 from 18 is $1\frac{1}{4}$ inches.

20 from 18 is $2\frac{3}{4}$ inches.

21 from 17 is the same length as 19 from 17.

22 is located by drawing a line from 19 parallel with line 14-15.

23 from 22 is $4\frac{3}{4}$ inches.

24 from 15 is $\frac{3}{8}$ inch.

Finish the front and back as represented.

Tight-Fitting Waist Lining

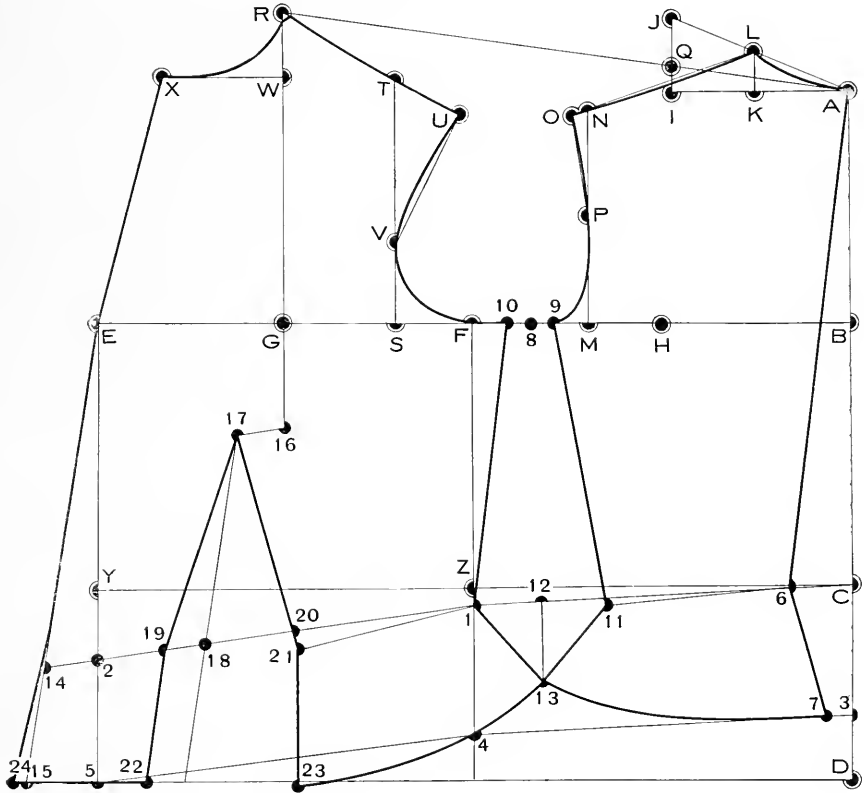

Tight-Fitting Waist Lining with Side Gore

First lay up all points to measure as described in Systematical Outline, then continue as follows:

1 from Z is $\frac{1}{2}$ inch.

2 from Y is $2\frac{1}{2}$ inches.

Draw lines from C to 1 and from 1 through 2 for the fashionable waist line as represented.

3 from C is 4 inches.

4 from 1 is 4 inches.

5 is located by a line squared up from D.

Draw lines between 3-4 and 5 as represented.

6 from C is 2 inches.

7 from 3 is $1\frac{3}{4}$ inch.

8 from 12 is $1\frac{1}{4}$ inches.

9 from 8 is $\frac{1}{2}$ inch.

10 from 6 is 1 inch more than the distance from A to K.

11 from 7 is 1 inch more than the distance from 6 to 10.

12 is located by shaping a line from 9 to 10.

Finish back part as represented.

13 from 10 is $\frac{3}{4}$ inch.

14 from 11 is $1\frac{1}{2}$ inches, and is from 13 the same length as 11 from 10.

15 from F is $\frac{3}{4}$ inch,

16 from 1 is $\frac{3}{4}$ inch.

Draw line from 15 to 16.

17 from 16 is $\frac{3}{4}$ inch.

18 from 1 is 1 inch.

19 is the centre of 17-18.

20 from 19 is $2\frac{1}{2}$ inches.

21 from 2 is $1\frac{3}{4}$ inches.

22 is located by drawing a line from E through 21.

23 from G is $3\frac{1}{4}$ inches.

24 is located by drawing a line through 26 parallel with line 1-2.

25 is located by drawing a line from 24 through 26.

26 is the centre of 24-25.

27 is the centre of 24-26.

28 is located by drawing a line from 27 parallel with line E-21.

29 from 28 is $\frac{5}{8}$ inch.

30 from 28 is $\frac{5}{8}$ inches.

31 is located by drawing a line from 29 parallel with line 21-22.

32 from 31 is $1\frac{1}{4}$ inches.

33 30 is 1 inch less than the distance from A to K.

34 from 32 is $\frac{1}{4}$ inch more than the distance from 30 to 33.

35 from 33 is 2 inches.

36 from 26 is the same length as 33 from 26.

37 from 34 is $2\frac{1}{4}$ inches.

38 from 22 is $\frac{3}{8}$ inch.

Shape front and side gore as represented.

Tight-Fitting Waist Lining with Side Gore

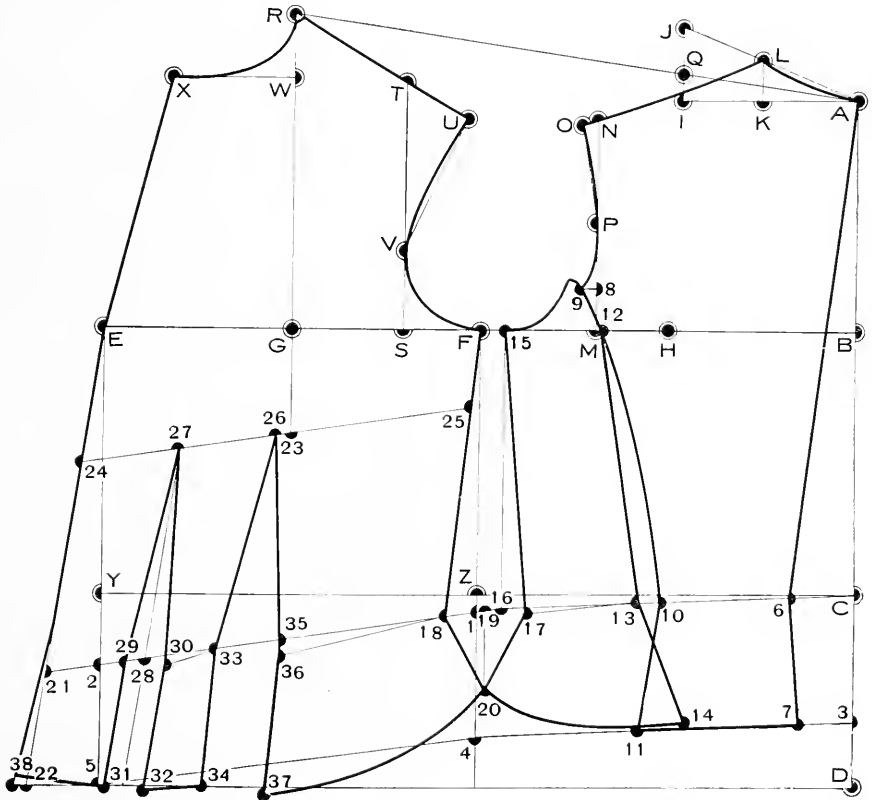

Sleeve Construction for Waist

- 1 Draw a straight line as from 1 to 2.
- 2 from 1 is the sleeve length measure.
- Square a line up from 2.
- 3 from 1 is a quarter of the full bust measure on a line squared up from 1.
- 4 is located by a line squared out from 3 as represented.
- 5 is the centre of 1-2.
- 6 is located by a line squared up from 5.
- 7 is the centre of 2-4.
- 8 is the centre of 1-3.

Square out a line from 8 as represented.

- 9 from 8 is 2 inches.
- 10 from 8 is the same length as 8 from 1.
- 11 from 1 is 2 inches.
- Draw lines between 11-10 and from 10 through 3.
- 12 is the centre of 10-11.
- 13 is the centre of 3-10.
- 14 from 12 is $1\frac{1}{2}$ inches.
- 15 from 13 is $\frac{3}{4}$ inch.
- 16 from 3 is $\frac{1}{2}$ inch.
- 17 from 3 is $\frac{1}{2}$ inch.
- 18 from 6 is 2 inches.
- 19 from 5 is 3 inches.
- 20 from 7 is 2 inches.

Draw a line from 4 through 20.

- 21 from 20 is 1 inch.
- 22 from 20 is 1 inch.
- 23 from 4 is $\frac{1}{2}$ inch.
- 24 from 21 is $\frac{1}{2}$ inch.

Draw all construction lines as represented.

Sleeve for Waist

First lay up all points to measure as described in Sleeve Construction for waist then continue as follows:

Shape the top sleeve as represented by lines between 11-10-17-18-4-22-5-11.

Shape the under sleeve as represented by lines between 9-16-18-23-24-19-9.

Sleeve Construction for Waist

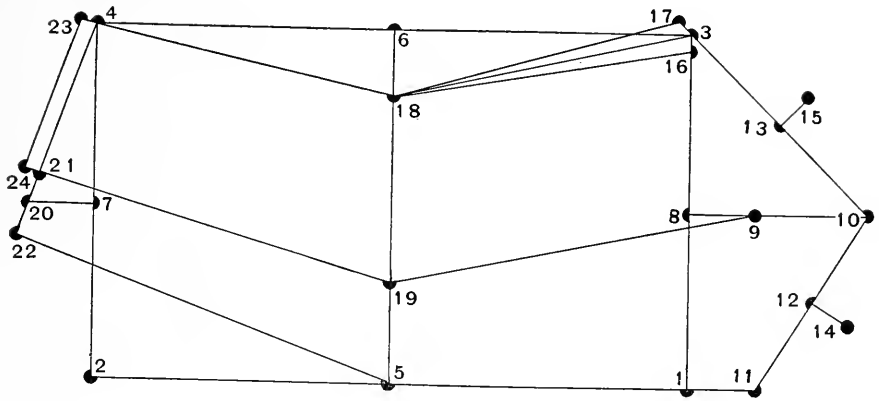

Sleeve for Waist

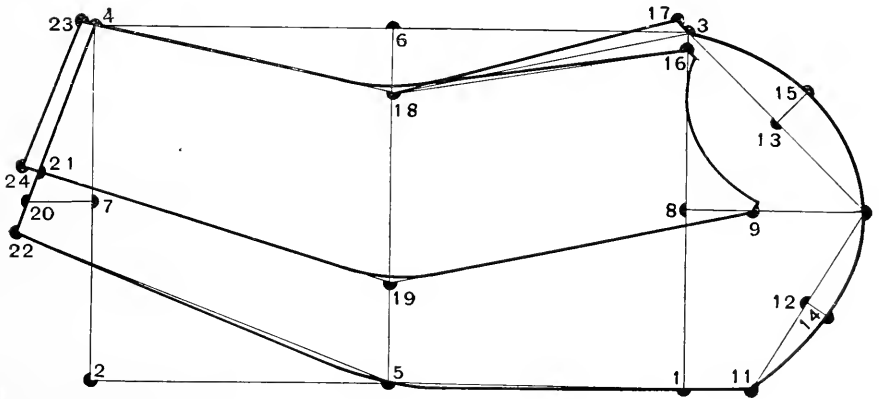

One Piece Sleeve
with fulness on the bottom
Bishop Sleeve

Place the top- and under sleeves together at the back seam so, that they should overlap $\frac{3}{4}$ inch for taking the seams off, and finish as represented.

One Piece Sleeve
with fulness on the top and Cuff

Place the top- and under sleeves together at the back seam so, that they should overlap $\frac{3}{4}$ inch for taking the seams off, and finish the sleeve as represented.

The Cuff is represented by heavy, broken lines.

One Piece Sleeve
with fulness on the bottom
Bishop Sleeve

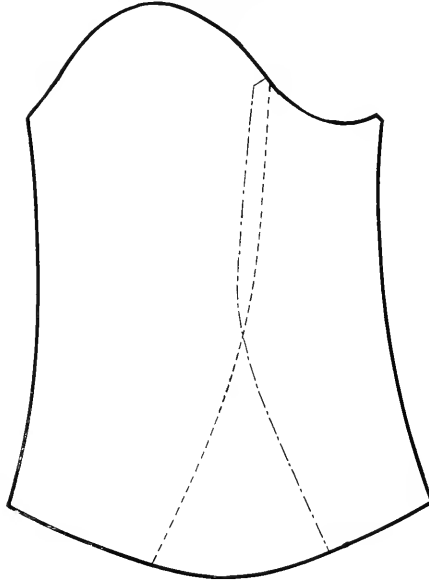

One Piece Sleeve
with fulness on the top and Cuff

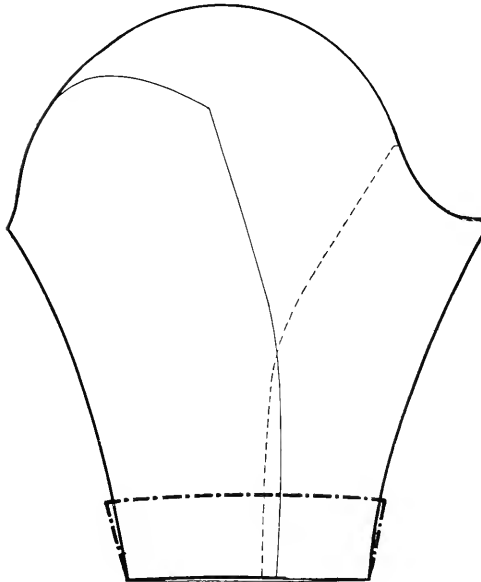

One Piece Tight Sleeve

First make a Bishop Sleeve as described on page 120 and then continue as follows:

A-B. Draw a straight line from A to B.

C is the center between A and B.

D from C is the sleeve length measure (inside seam) on line squared down from C.

E from D is the half wrist measure plus $\frac{3}{8}$ inch for a seam on line squared out from D.

F from D is the same as E from D on line drawn from E through D.

Finish the sleeve as represented.

One Piece Tight Sleeve

with seam at the middle of the under arm

First make One Piece Tight Sleeve as described above and then continue as follows:

A-B-C-D is the original sleeve.

E-F is about the middle of the under-sleeve.

Cut through the sleeve at E-F and place the piece B-C-E-F on the other side of the sleeve so, that B-C should be placed to A-D accordingly the notches, and mark over the new sleeve as represented.

By using this kind of a sleeve be careful that the side seam of the garment should correspond with the seam of the sleeve.

One Piece Tight Sleeve

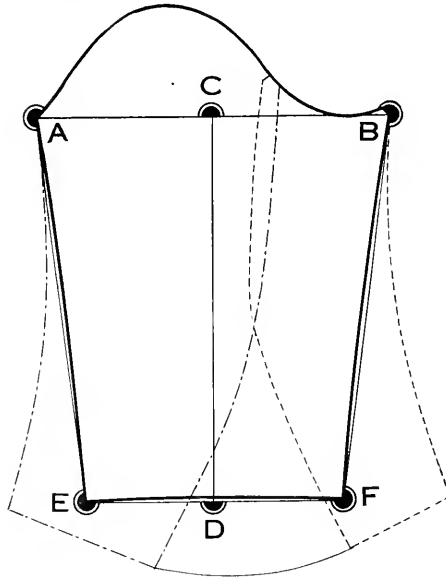

One Piece Tight Sleeve with seam at the middle of the under arm

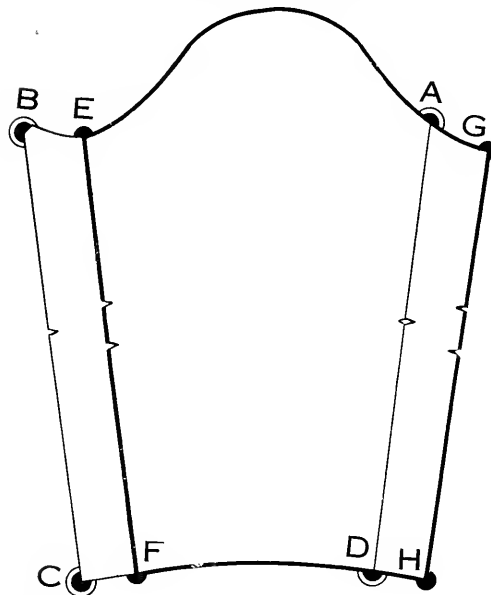

Standing or Military Collar

- A. Square both ways from A as represented.
 B from A is the half neck measure plus $\frac{3}{4}$ inch for two seams.
 C is the center of A-B.
 D from A is 3 inches.
 E from B is 3 inches on line squared up from B.
 F is the center of line drawn from D to E.
 G from E is $\frac{3}{4}$ inch.
 H from D is $\frac{3}{4}$ inch.
 I from F is $\frac{3}{4}$ inch.
 J from B is $\frac{3}{4}$ inch.
 K from A is $\frac{3}{4}$ inch.

Shape the Collar as represented.

Line A-C is the back center.

High Standing Collar

- A. Square both ways from A.
 B from A is the half neck measure plus $\frac{3}{8}$ inch for one seam.
 C from A is 3 inches.
 D from B is 3 inches on line squared up from B.
 E from D is $\frac{3}{4}$ inch.
 F from B is $\frac{3}{4}$ inch.
 G from C is $\frac{3}{4}$ inch.

Fold the paper on line E-F, which is the front center.

Shape the collar as represented.

Standing or Military Collar

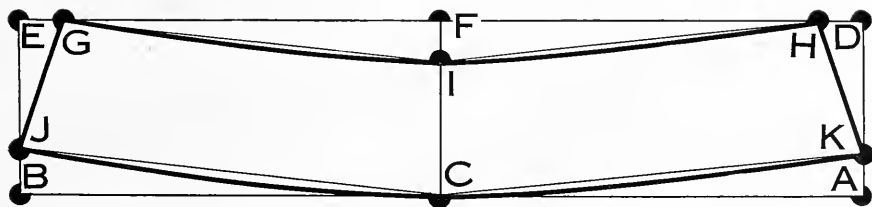

High Standing Collar

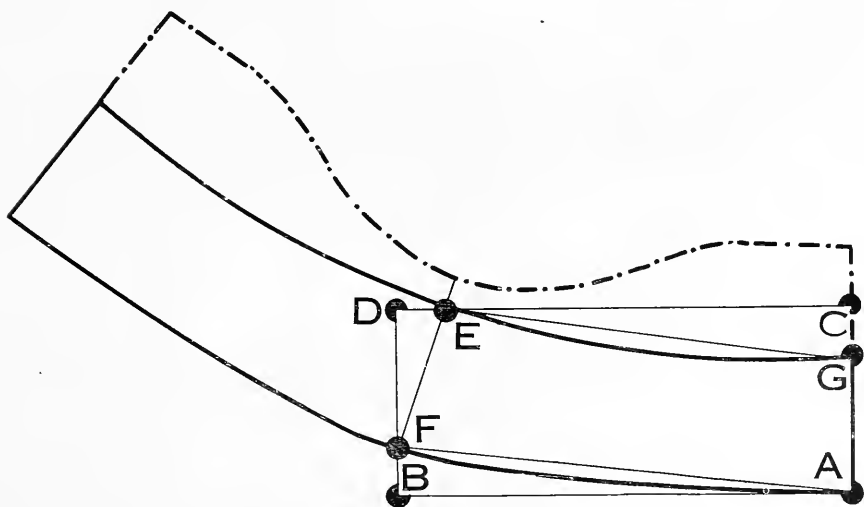

Dutch Collar

Diagram 1

Lay the Front and Back together at the shoulder so, that they should overlap $\frac{3}{4}$ inch for taking the seams off and finish the collar as represented.

Norman Collar

Diagram 2

Lay the Front and Back together at the shoulder so, that they should overlap $\frac{3}{4}$ inch for taking the seams off and continue as follows :

A is the neck point.

B is the point where the collar should end.

C from **A** is a straight line drawn parallel with the front center of the garment and is from **A** the same length as **B** from **A**.

Sailor Collar

Diagram 2

Lay the Front and Back together at the shoulder so, that they should overlap $\frac{3}{4}$ inch for taking the seams off and finish the collar as represented.

Collars for Waist

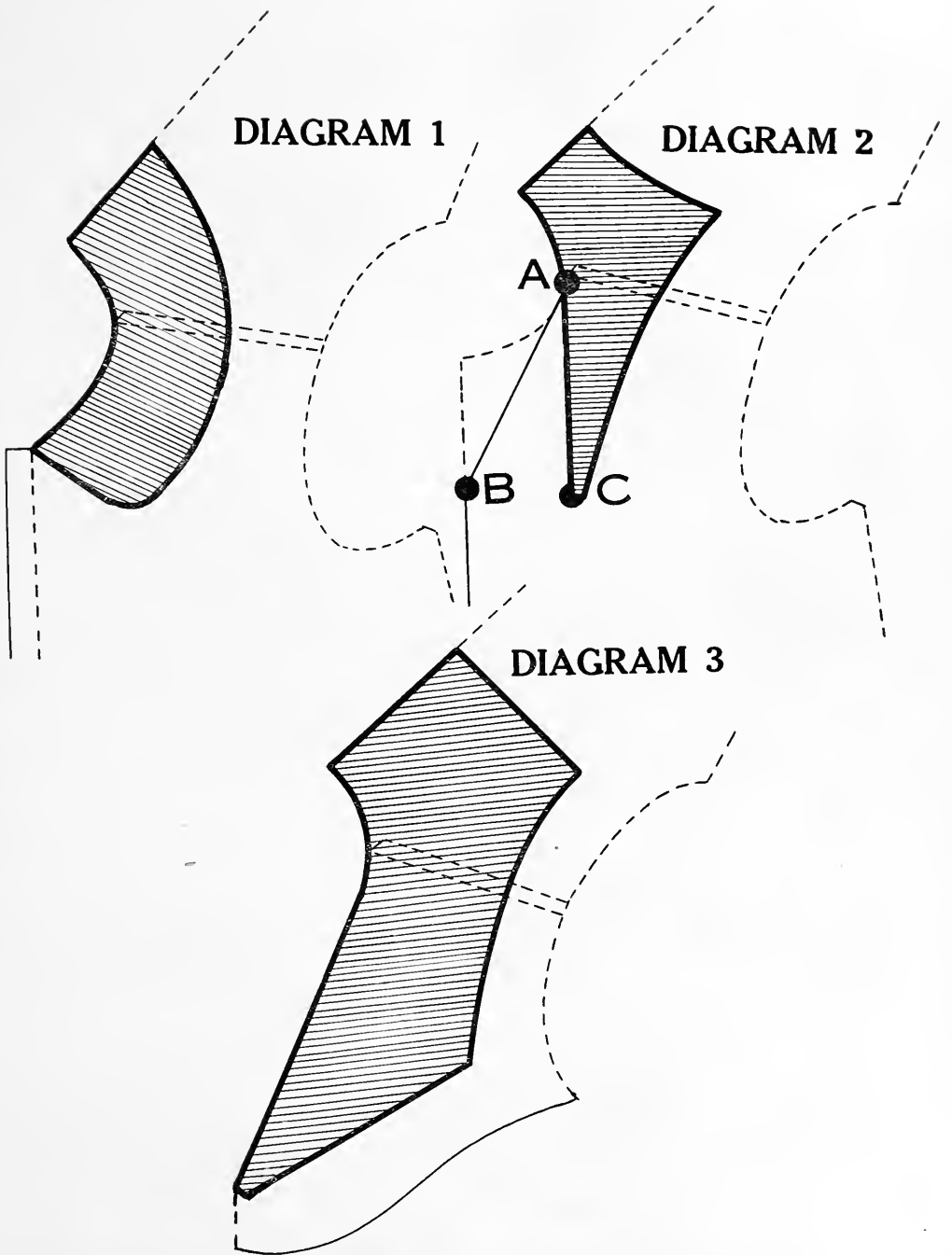

Yoke

To produce a Yoke lay the back and front together at the shoulder so, that they should overlap $\frac{3}{4}$ inch for figuring the seams off, and finish the Yoke as represented,

Shield

To produce a Shield lay the back and front together at the shoulder so, that they should overlap $\frac{3}{4}$ inch for figuring the seams off, and finish the shield as represented.

Yoke

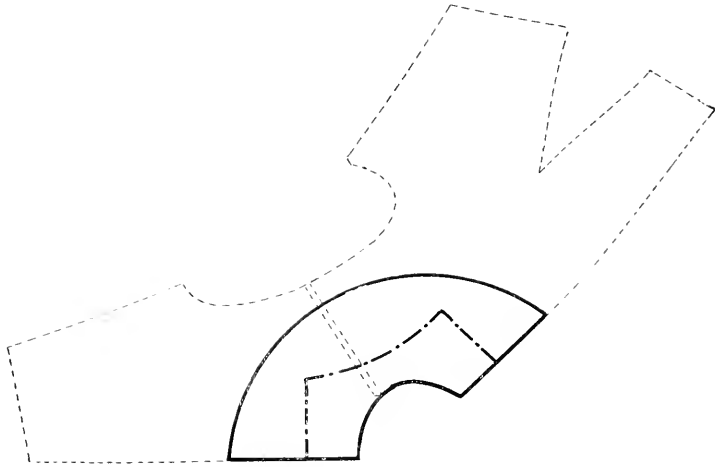

Shield

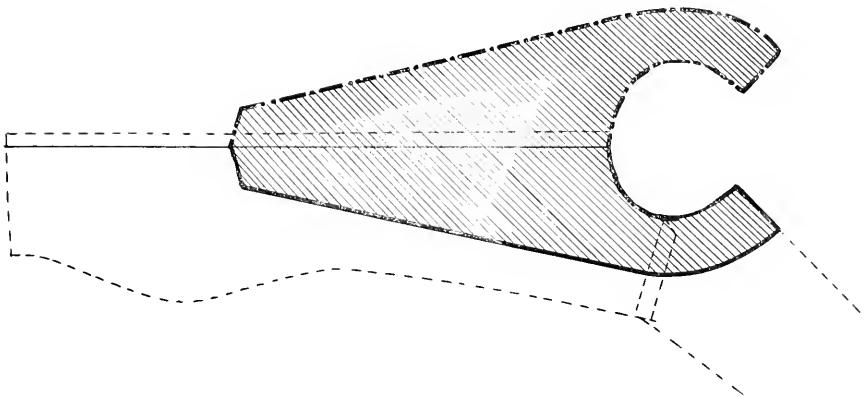

Waist with Kimono or Butterfly Sleeves

First lay up all points as described in Systematic Outline, then continue as follows;

1 from Z is $\frac{1}{2}$ inch.

2 from Y is $2\frac{1}{4}$ inches.

Draw the fashionable waist line from C to 1 and to 2.

3 from C is 2 inches.

4 is the center between F and M.

5 from 4 is $\frac{3}{4}$ inch.

Draw a line from 5 to 1.

6 from 1 is $2\frac{1}{4}$ inches.

7 from 5 is the same length as 1 from 5 on line drawn from 5 through 6.

Draw a line from 3 to 7.

8 from L is $\frac{3}{8}$ inch on line drawn from O through L.

9 from 8 is $\frac{1}{2}$ on line squared up from 8.

10 from O is $\frac{3}{8}$ inch.

11 from 9 is the sleeve length desired. (For the full length of a regular 36 size is $29\frac{1}{2}$ inches.)

12 from 11 is the width of sleeve desired on line squared down from 11. (By a full length sleeve for regular 36 size is 6 inches.)

13 is the center between 11 and 12.

14 from 5 is 2 inches, more or less accordingly style or taste.

15 from 12 is $\frac{1}{2}$ inch on line drawn from 14 through 12.

Finish the back as represented.

16 from R is $\frac{1}{2}$ inch.

17 from U is $\frac{1}{4}$ inch.

18 from 16 is the same length as 11 from 9 on line drawn from 16 through 17.

19 from 18 is the same width as 12 from 11 on line squared down from 18.

20 is the center between 18 and 19.

21 from 5 is the same length as 14 from 5.

22 from 21 is the same length as 15 from 14 on line drawn from 21 through 19.

23 from E is the same length as 2 from E on line drawn from X through E.

Finish the front as represented.

Waist with Kimono or Butterfly Sleeves

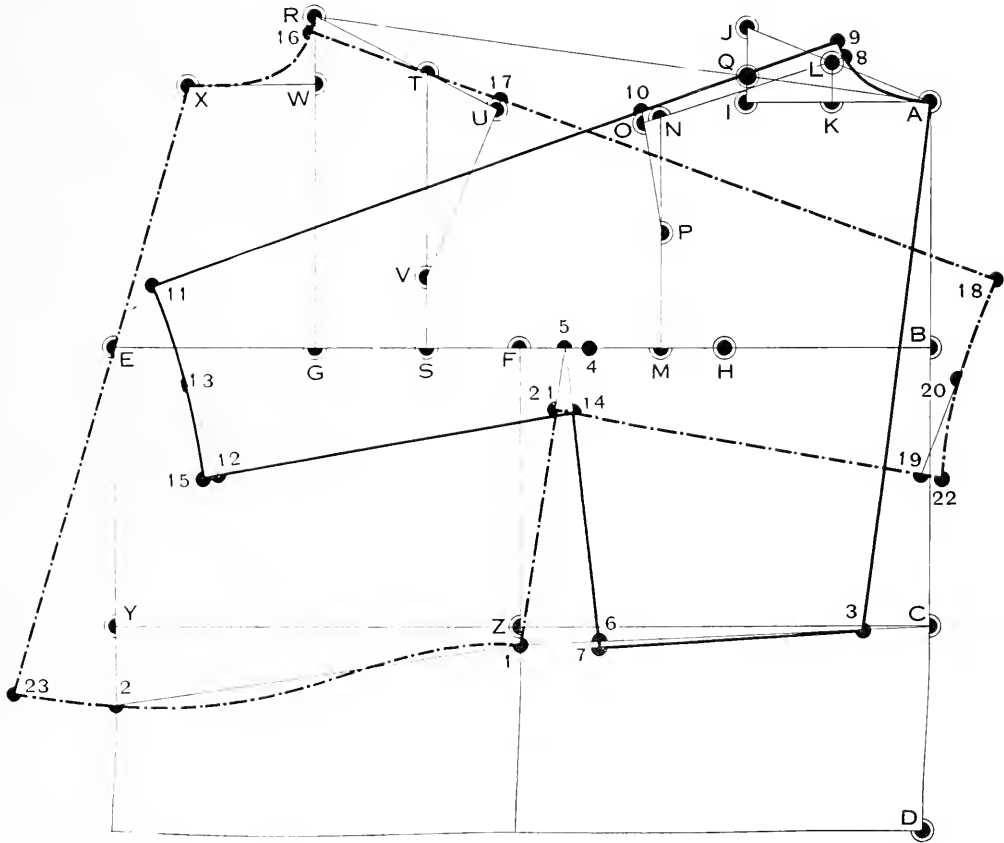

One Piece Butterfly Waist

First draft and cut out a waist pattern with kimono sleeves as described on page 130, then continue as follows:

Lay together the front and back at the shoulder seam so, that they should overlap $\frac{3}{4}$ inch for taking the seams off and mark the waist from one piece.

1-2-3-4-5-6-7-1 is the front.

8-9-10-11-12-13-14-8 is the back.

Waist with Raglan Sleeve

To produce this pattern, first mark a waist with Kimono sleeves from one piece as described above, then continue as follows:

15 is the center between 7 and 8.

16 from 15 is $\frac{3}{4}$ inch, more or less accordingly style or taste.

17 from 15 is the same as 16 from 15.

18 from 4 is 2 inches, more or less accordingly style or taste.

19 from 11 is the same as 18 from 4.

Shape the seams from 16 to 18 and from 17 to 19 accordingly style or taste as represented.

20 from 16 is the same length as the shaped line is from 16 to 18 and is shaped inside accordingly fulness desired under the arm.

21 from 17 is the same length as the shaped line is from 17 to 19 and is shaped inside the same way as point 20.

Finish the draft as represented.

By cutting out the pattern allow for seams at lines 16-18, 16-20, 17-19 and 17-21.

One Piece Butterfly Waist

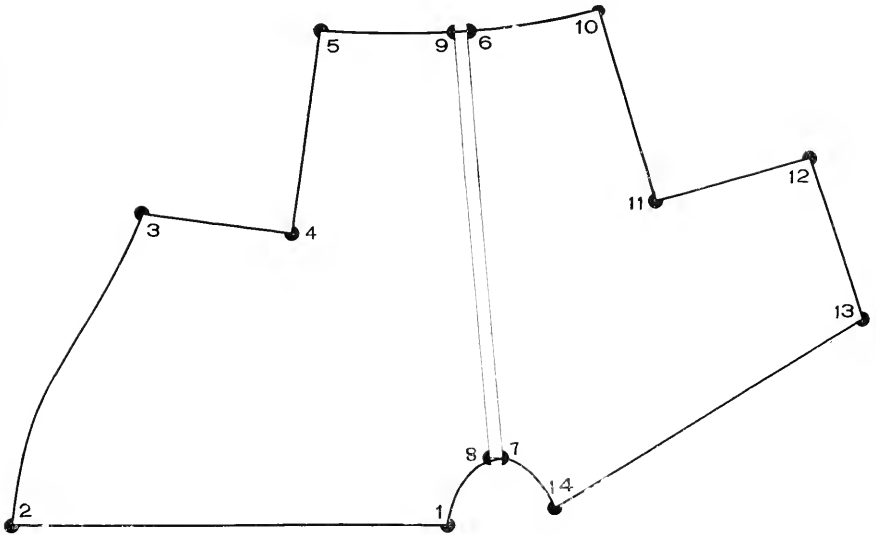

Waist with Raglan Sleeve

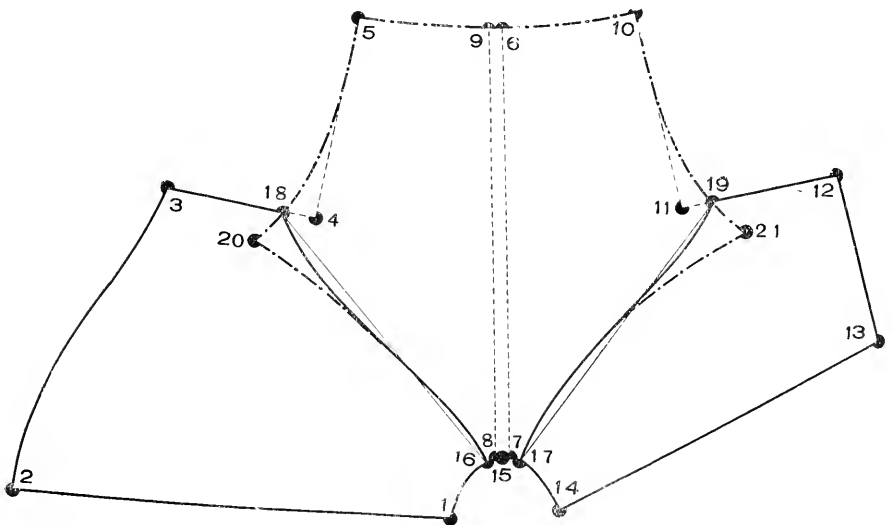

Measurement for Skirts

1-1 Around the waist.

2-2 Around the hips about 6 inches below the waist line.

3-4 Front length till the floor.

1-5 Side length till the floor.

6-7 Back length till the floor.

Measurement for Skirts

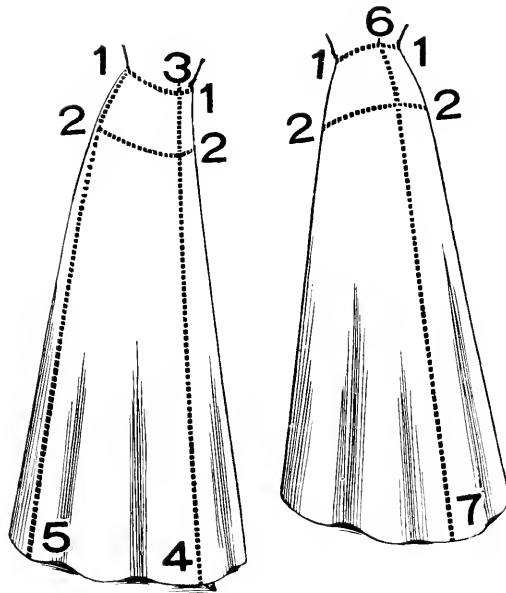

Systematic Outline for Skirts

Measurement

Waist 26 inches, Hips 42 inches,
Front length $43\frac{1}{2}$ inches, Back length 44 inches.

A. Square both ways from A as represented.

B from A is the the half waist measure plus 3 inches, in this case 16 inches.

C from B is 4 inches on line squared out from B.

Draw a line from A through C and longer.

D from A is 6 inches.

E from D is the half Hips measure on line drawn from D parallel with line A-C, in this case 21 inches.

F is located by a line squared out from E.

G from F is $1\frac{1}{4}$ inches.

H from A is the front length, in this case 42 inches.

I from the center of line A-G is the side length, in this case $43\frac{1}{2}$ inches.

J from G is the back length on line drawn from G through E.

Finish the bottom as represented.

NOTICE : In all Drafts — designed in this Systematic Outline — are seams NOT allowed.

Systematic Outline for Skirts

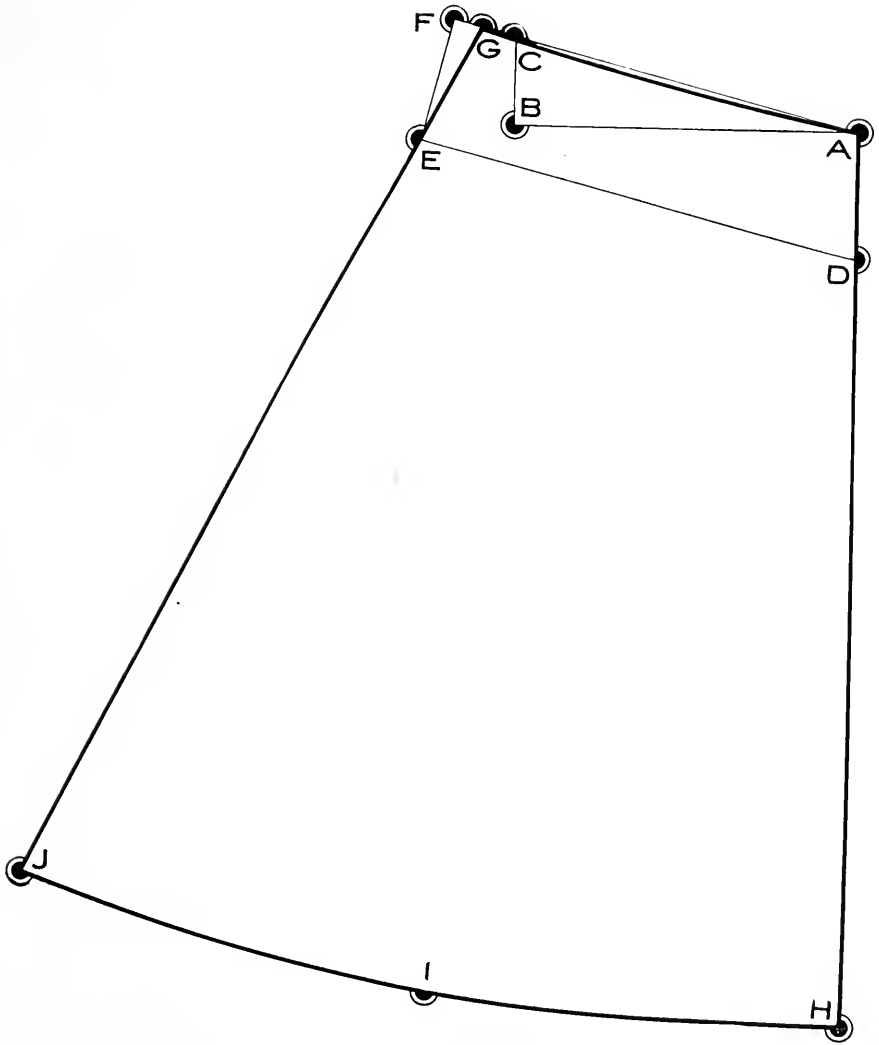

Two Gore Skirt

High Waisted

First lay up all points as described in Systematic Outline for Skirts, then continue as follows :

1 is the center of A-G.

2 from H is the center of H-J less $1\frac{1}{2}$ inches.

3 is located by a line drawn from 2 through 1.

4 from 1 is 2 inches.

5 from A is $2\frac{1}{2}$ inches.

6 from G is $2\frac{1}{2}$ inches.

Connect points 5-4-6.

7-8 is the difference between the actual half waist measure and the measure of line A-G, and is divided by point 1 of two equal parts.

9 is the center of 1-7.

10 is the center of 1-8.

11 is located by a line squared out from 9.

12 is located by a line squared out from 10.

13 from 3 is 1 inch.

Finish the skirt as represented.

Two Gore Skirt

High Waisted

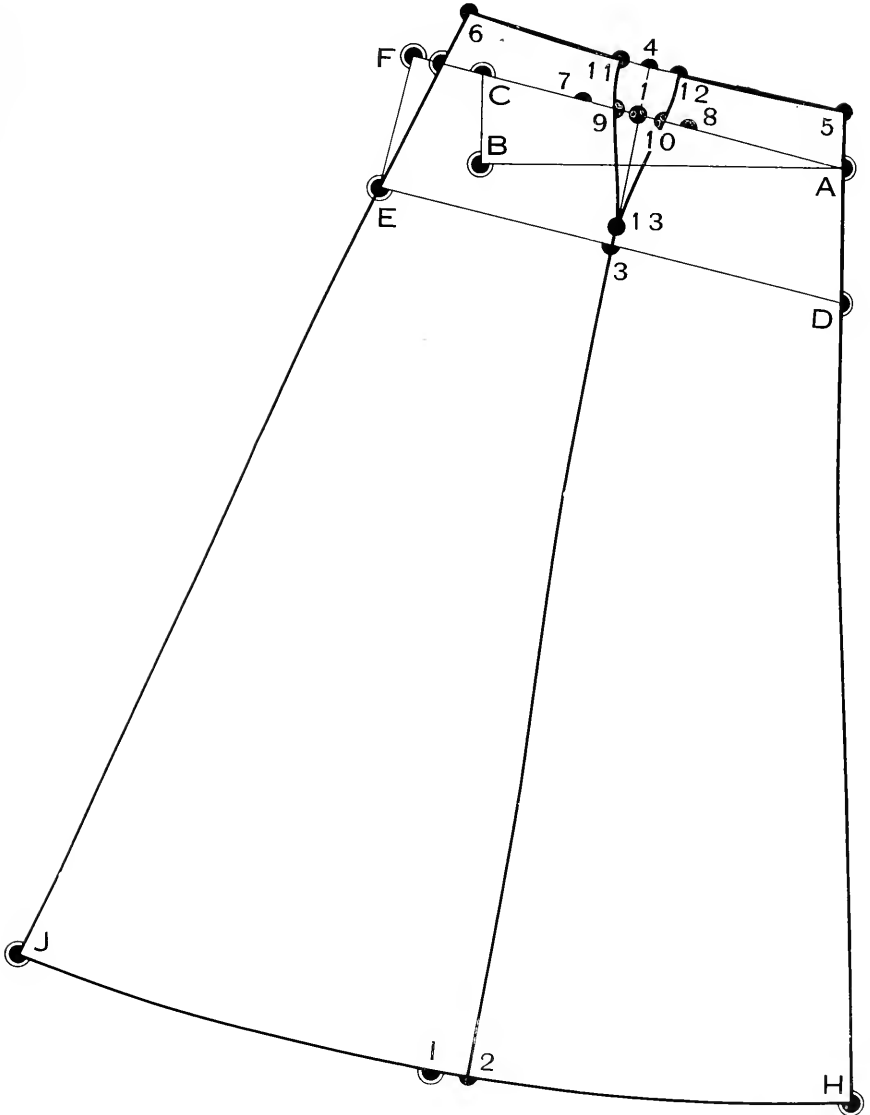

Three or Four Gore Skirt

High Waisted

The draft for a three or four gore skirt is the same as for a two gore skirt.

(See page 138.)

The difference is in placing the seams.

For a two gore skirt allow seams only on the sides, and no seam at the front and back.

For a three gore skirt no seam on the front. Seams at the sides and back only.

For a four gore skirt seams on the front, sides and back.

Three or Four Gore Skirt

High Waisted

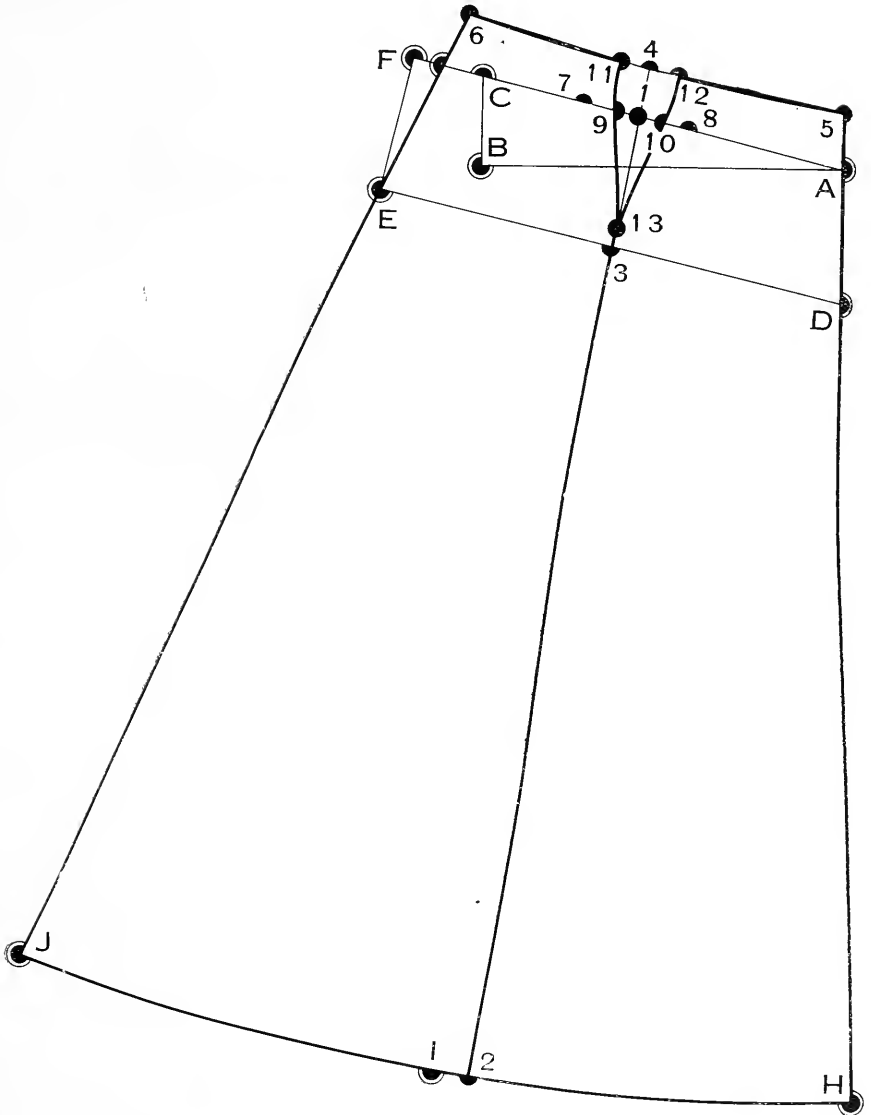

Four Gore (Panel) Skirt

First lay up all points to measure as described in Systematical Outline for Skirts, then continue as follows:

- 1 from A is 3 inches.
- 2 from G is 3 inches.
- 3 from H is 5 inches.
- 4 from J is 5 inches.
- 5 is the centre of 1-2.
- 6 is the centre of D-E.

Draw lines between 1-3,5-6 and 2-4 as represented.

Measure the waist line from A to G and the difference between this measure and the actual waist measure is to be taken out in darts at points 1-5-2 as represented.

For instance from A to G measures 18 inches; the half actual waist measure is 13 inches; the surplus is 5 inches. This amount is to be taken out in darts. At the front (point 1) take out the least and at the side (point 5) take out the most.

In this case take out at point 1 a half inch, at point 2 two inches, and at point 5 two and half inches as represented.

NOTICE: No seams or turning-in is allowed for in this Systematical Outline.

Allow for all seams.

Five Gore Skirt

First lay up all points to your measure as described in Systematic Outline, then continue as follows:

- 1 from A is 3 inches.
- 2 is the center between 1 and G.
- 3 from H is $5\frac{1}{2}$ inches. (Twice as 1-A less $\frac{1}{2}$ inch.)
- 4 from J is 3 inches.
- 5 is the center between 3 and 4.
- 6 is located by drawing a line from 2 to 5.

The difference between the actual half waist measure and the measure of line A-G is to be taken out in darts as follows:

For instance 5 inches is to be taken out.

Take out $\frac{1}{2}$ inch at point 1 equal divided on both sides, and $4\frac{1}{2}$ inches at point 2 equal divided on both sides.

- 7 from 2 is $2\frac{1}{4}$ inches.
- 8 from 2 is $2\frac{1}{4}$ inches.
- 9 from 7 is $\frac{3}{4}$ on line squared up from 7.
- 10 from 8 is $\frac{3}{4}$ inch on line squared out from 8.
- 11 from 6 is $\frac{3}{4}$ inch.

Finish the draft as represented.

Six Gore Skirt

First lay up all points to measure as described in Systematic Outline for Skirts, then continue as follows:

1 from A is 3 inches.

3 from G is the same as 1 from A.

2 is the center between 1 and 3.

4 from H is twice as much as 1 from A less $\frac{1}{2}$ inch, in this case $5\frac{1}{2}$ inches.

5 from J is the same as 4 from H.

6 from 4 is the center between 4 and 5 less $1\frac{1}{2}$ inches.

Draw lines between 1-4, 2-6, 3-5.

The difference between the measure of the waist line from A to G and the half actual waist measure is to be taken out in darts at points 1, 2, 3.

At the front take out the least and at the side take out the most dart.

For instance 5 inches is the difference.

Take out at point 1 $\frac{1}{2}$ inch, at point 2 $2\frac{1}{2}$ inches, at point 3 2 inches equal divided on both sides.

Finish the draft as represented.

Six Gore Skirt

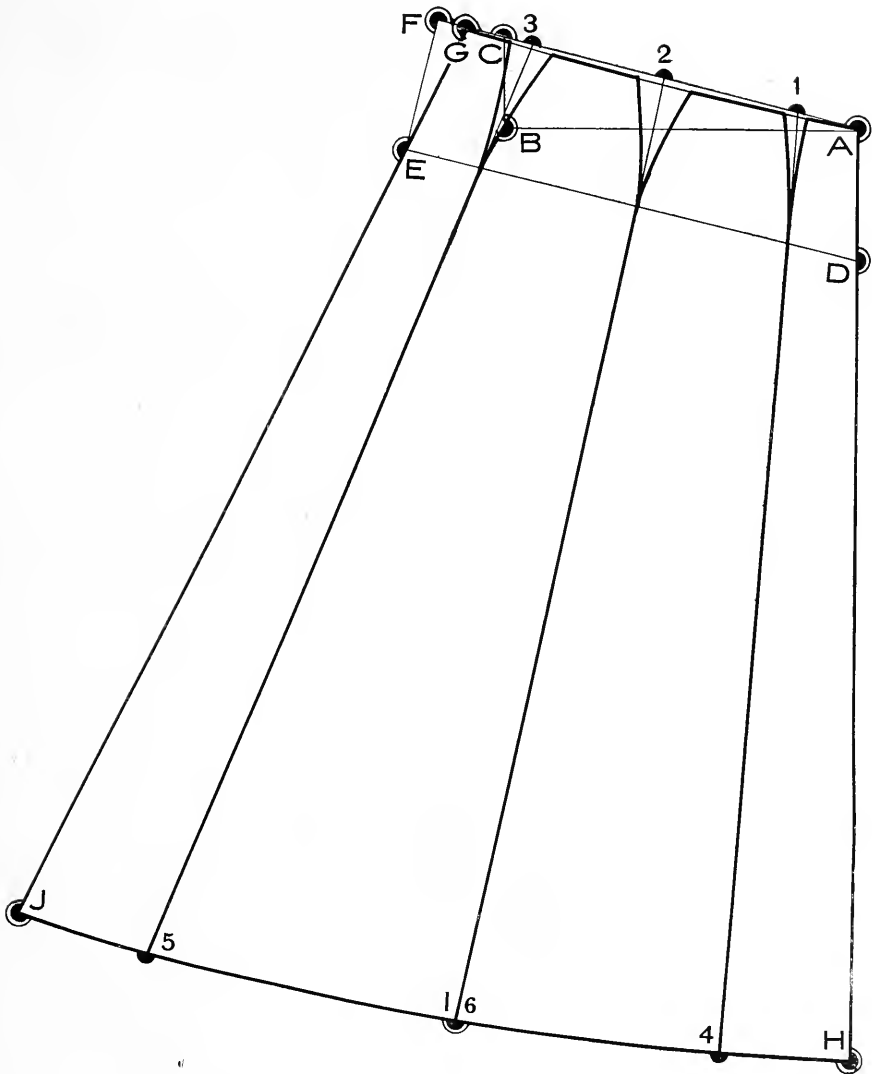

Seven Gore Skirt

First lay up all points to measure as described in Systematical Outline for Skirts, then continue as follows:

1 from A is 3 inches.

2 from 1 is one-third of the line from 1 to G.

3 is the centre between 2 and G.

4 from H is 5 inches.

5 from 4 is 1 inch less than one-third of 4-5.

6 from 5 is 1 inch less than the half-way between 5 and J.

Draw lines between 1-4, 2-5 and 3-6 as represented.

Measure the waist line from A to G and the difference between this measure and the actual waist measure is to be taken out in darts at points 1-2-3 as represented.

For instance from A to G measures 18 inches; the half actual waist measure is 13 inches; the surplus is 5 inches. This amount is to be taken out in darts. At the front (point 1) take out the least and at the side (point 5) take out the most.

In this case take out at point 1 a half inch, at point 2 two inches, and at point 5 two and half inches as represented.

NOTICE: No seams or turning-in is allowed for in this Systematical Outline.

Allow for all seams.

Seven Gore Skirt

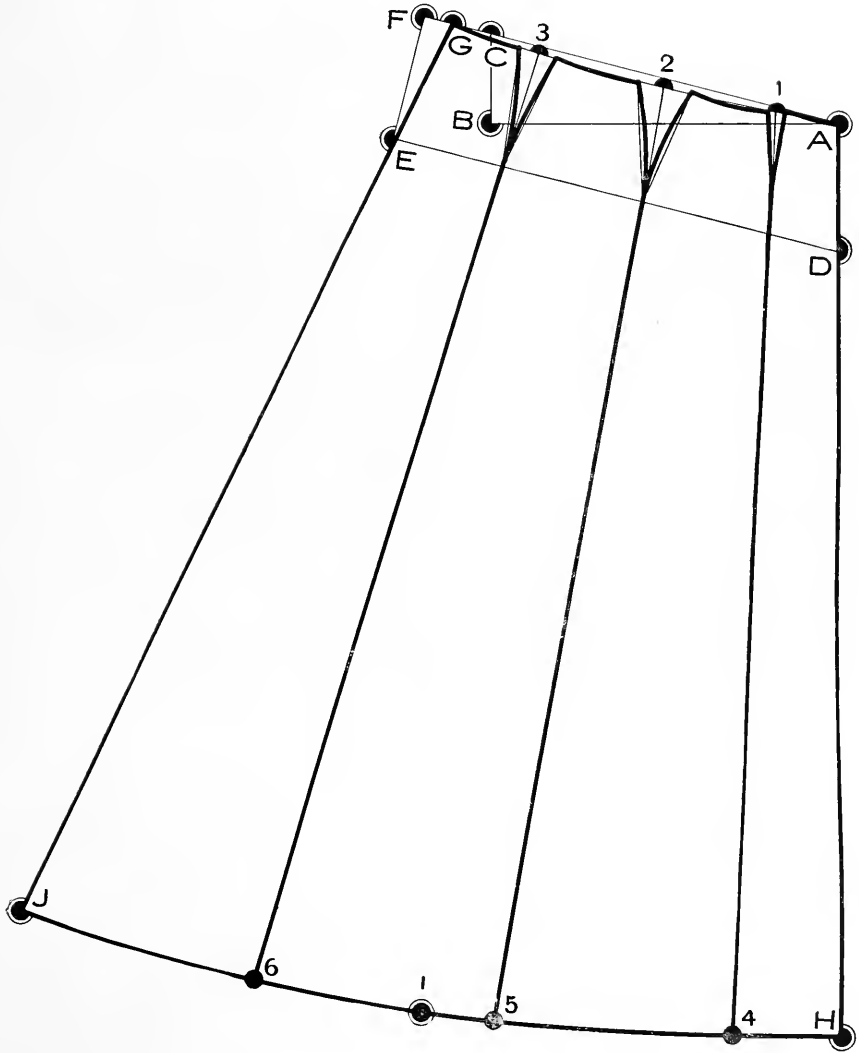

9 Gore Flare Skirt

First lay up all points as described in Systematic Outline, then continue as follows:

1 from A is $2\frac{1}{2}$ inches.

2-3-4 are located by dividing the waist line from 1 to G of four parts.

5 from H is twice as much as 1 from A less $\frac{1}{2}$ inch, in this case $4\frac{1}{2}$ inches.

6 from J is about $2\frac{1}{2}$ inches.

7-8-9 are located by dividing the bottom line from 5 to 6 of four parts.

Draw lines between 1-5, 2-7, 3-8 4-9.

Measure the waist line from A to G and the difference between this measure and the actual half waist measure is to be taken out in darts at points 1, 2, 3, 4.

For instance from A to G is 18 inches; the actual half waist measure is 13 inches, is surplus 5 inches.

This 5 inches is to be taken out in darts; at the front take out the least and at the side the most. In this case take out at point 1 $1\frac{1}{4}$ inch, at point 2 $1\frac{3}{4}$ inches, at point 3 $1\frac{3}{4}$ inches, at point 4 $1\frac{1}{4}$ inches equal divided on both sides.

For making the flares place points 10, 11, 12, 13 as high desired accordingly style or taste, and allow fulness at the bottom towards the back always more and less towards the front.

For instance:

14 from 5 is $\frac{1}{2}$ inch.

15 from 5 is 1 inch.

16 from 7 is 1 inch.

17 from 7 is $1\frac{1}{2}$ inches.

18 from 8 is $1\frac{1}{2}$ inches.

19 from 8 is 2 inches.

20 from 9 is 2 inches.

21 from 9 is $2\frac{1}{2}$ inches.

If you wish flaring at the back and a slit, proceed as follows:

22 from G is 13 inches.

23 from J is in this case 3 inches.

Make the slit about $1\frac{1}{2}$ inches wide and finish the draft as represented.

9 Gore Flare Skirt

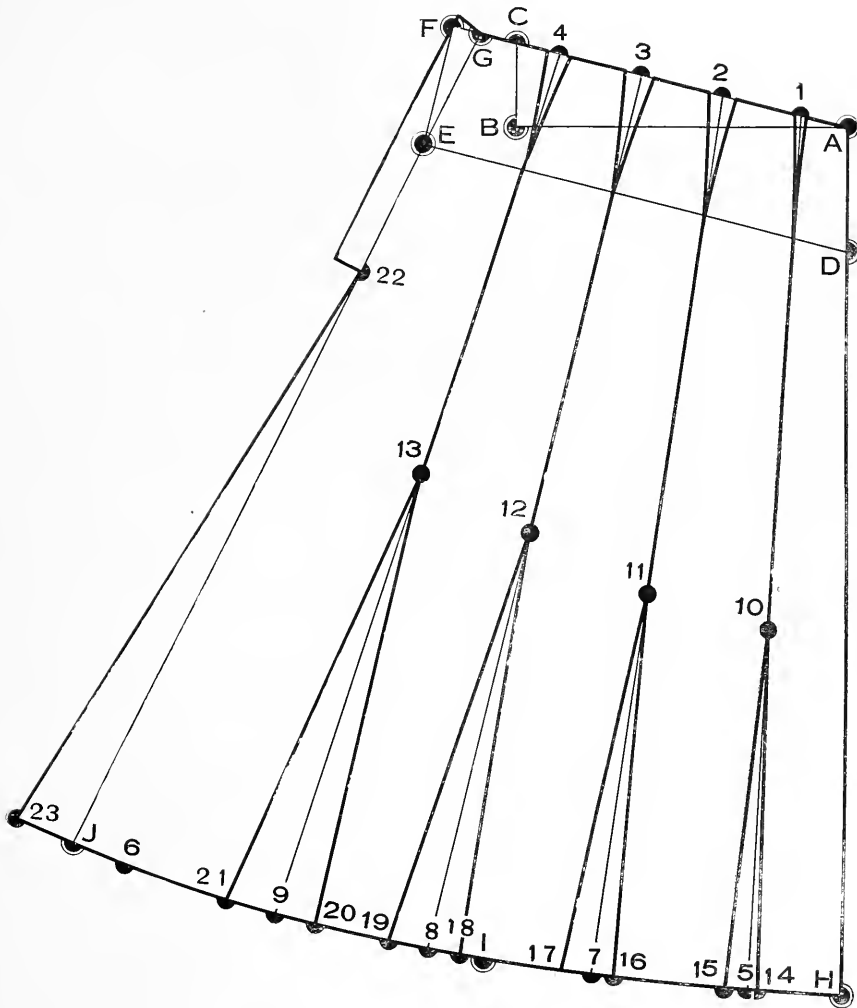

11 Gore Flounce Skirt

First lay up all points as described in Systematic Outline for Skirts, then continue as follows:

1 from A is 2 inches.

2, 3, 4, 5 are located by dividing the waist line from 1 to G of five parts.

6 from H is $3\frac{1}{2}$ inches.

7 from J is $2\frac{1}{2}$ inches.

8, 9, 10, 11 are located by dividing the bottom from 6 to 7 of five parts.

Draw lines between 1-6, 2-8, 3-9 4-10, 5-11.

Measure up the waist line from A to G and the difference between this measure and the half actual waist measure is to be taken out in darts as represented.

12, 13, 14, 15, 16, 17, 18 are located by marking the height of the flounce.

Cut out the flounce (18-12-H-J-18) in one piece.

Allow fulness at the bottom of the flounce towards the back always more as represented by the shaded lines and cut out the new flounce from one piece as represented by double lines.

11 Gore Flounce Skirt

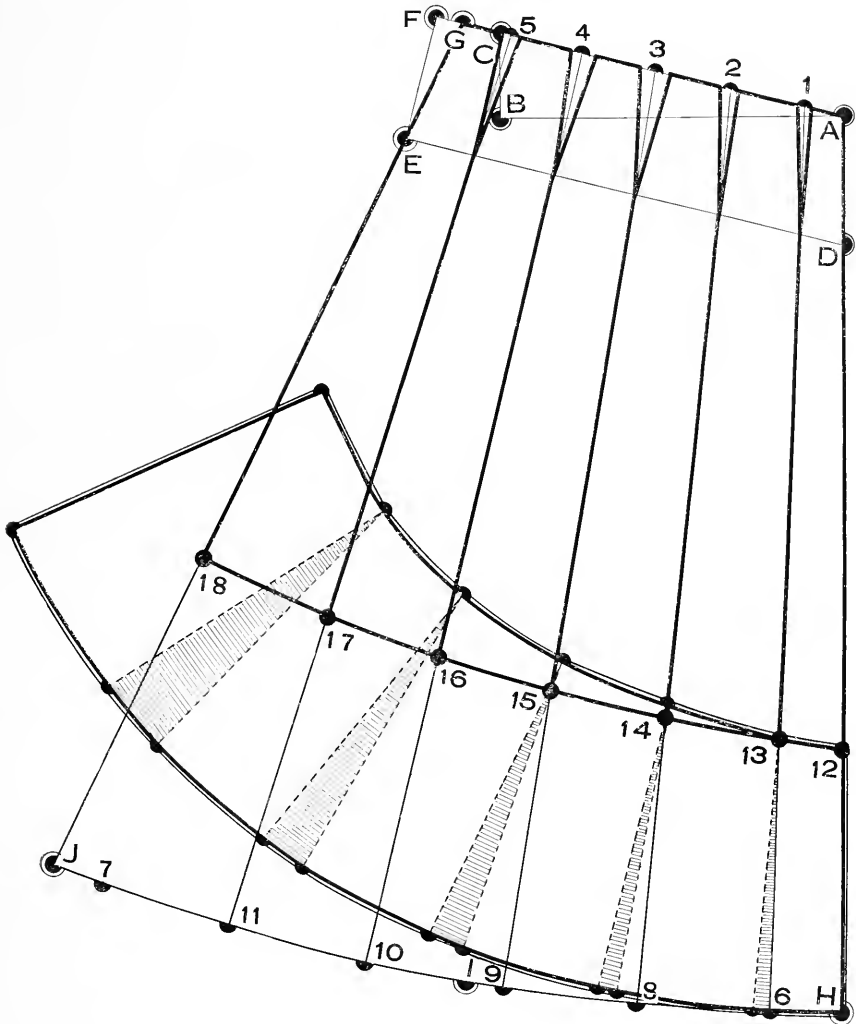

13 Gore Plaited Skirt

First lay up all points as described in Systematic Outline for Skirts, then continue as follows:

1 from A is $1\frac{1}{2}$ inches, more or less accordingly style or taste.

2, 3, 4, 5, 6 are located by dividing the waist line from 1 to G of six equal parts.

7 from H is 3 inches, or twice as much as 1 is from A.

8 from J is $2\frac{1}{2}$ inches.

9, 10, 11, 12, 13 are located by dividing the bottom of six equal parts.

Connect points 1-7, 2-9, 3-10, 4-11, 5-12, 6-13 for the side seams.

The difference between the actual half waist measure and the measure of the waist line from E to G is to be taken out in darts divided at points 1, 2, 3, 4, 5, 6 as represented.

By applying an inverted plait in the back proceed as follows;

14 from G is 3 inches.

15 from J is 6 inches.

Fold your paper at line G-J till line 14-15 and trace over the waist line, that the plait should not be short at the waist line.

Allow plaits at each side of the gores as deep plaits desired. For instance at the top $1\frac{1}{2}$ inches, and at the bottom $2\frac{1}{2}$ inches on each side.

Finish the skirt as represented.

13 Gore Plaited Skirt

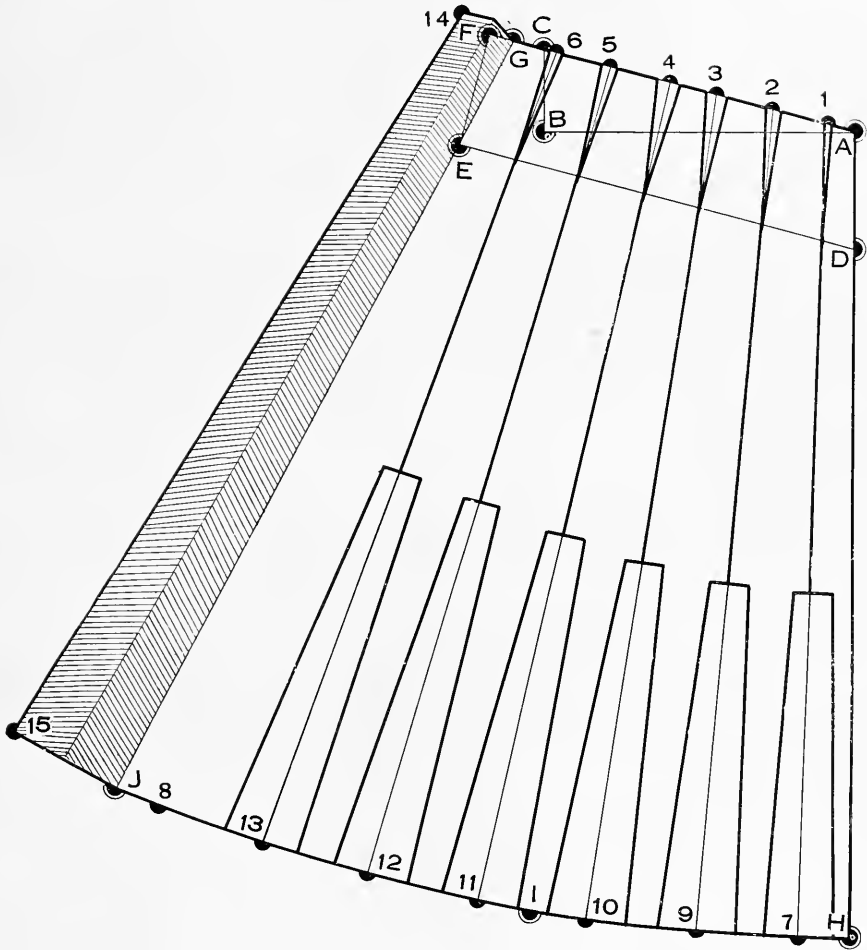

Circular Skirt

- A.** Draw a straight-line as from A to 1.
B from A is the half waist measure.
C from B is 6 inches.
D from A is 2 inches.
E from D is 1 inch on line square down from D.
F is located by a line swept from B, pivoting at E, and is from B the half Waist measure.
G is located by a line swept from C, pivoting at E, and is from C the half Hip measure plus $\frac{1}{2}$ inch.
1 from B is the front length.
2 from F is the back length.
3 is the center of B-F.
4 from 3 is the side length, and is from 1 about 2 inches less than from the middle of 1-2.

Circular Skirt with One Dart

- First draft a Circular Skirt as described above, then continue on the same draft as follows:
5 is located by drawing a line from 3 to 4.
6 from 5 is 1 inch.
7 from 4 is the half of fulness to be taken out.
8 from 4 is the same as 7 from 4.
 Cut out the fulness between 8-6-7, and join together lines 6-7 with 6-8 to produce the dart at the waist line as represented by points 3-6-3.

NOTICE: On this draft are seams NOT allowed.

Circular Skirt

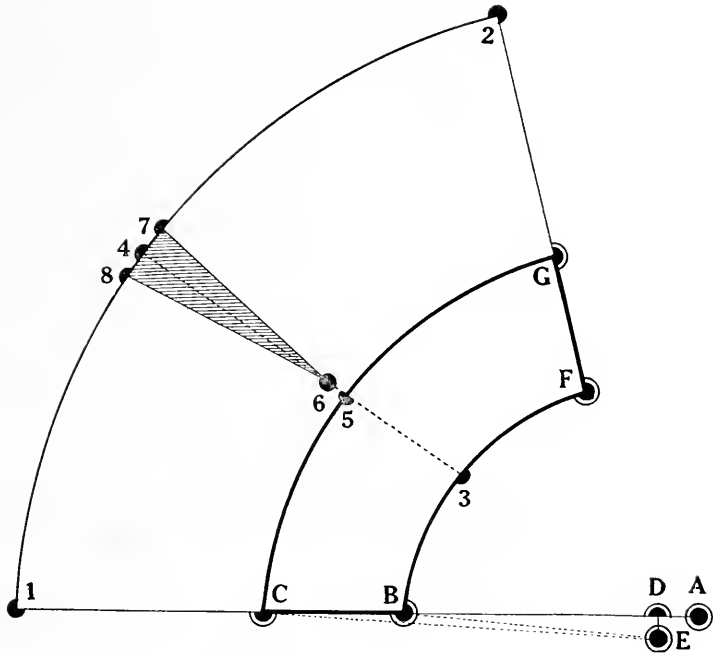

Circular Skirt with One Dart

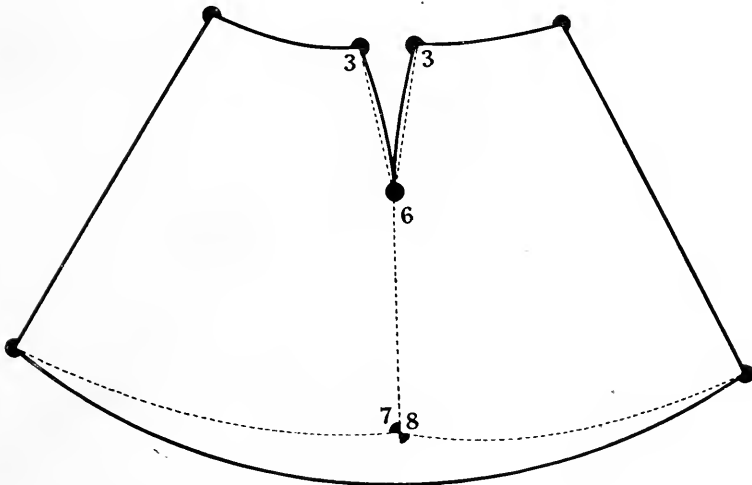

Circular Skirt in Gores

First draw a plain skirt in gores as many gores desired.

Allow at the bottom to each gore fulness as much more desired than the bottom width of the Systematical Outline is, and draw straight lines from the hip line down to the bottom as represented.

That the fulness should fall nicely, allow always more fulness towards the back and less towards the front.

Circular Skirt in Gores

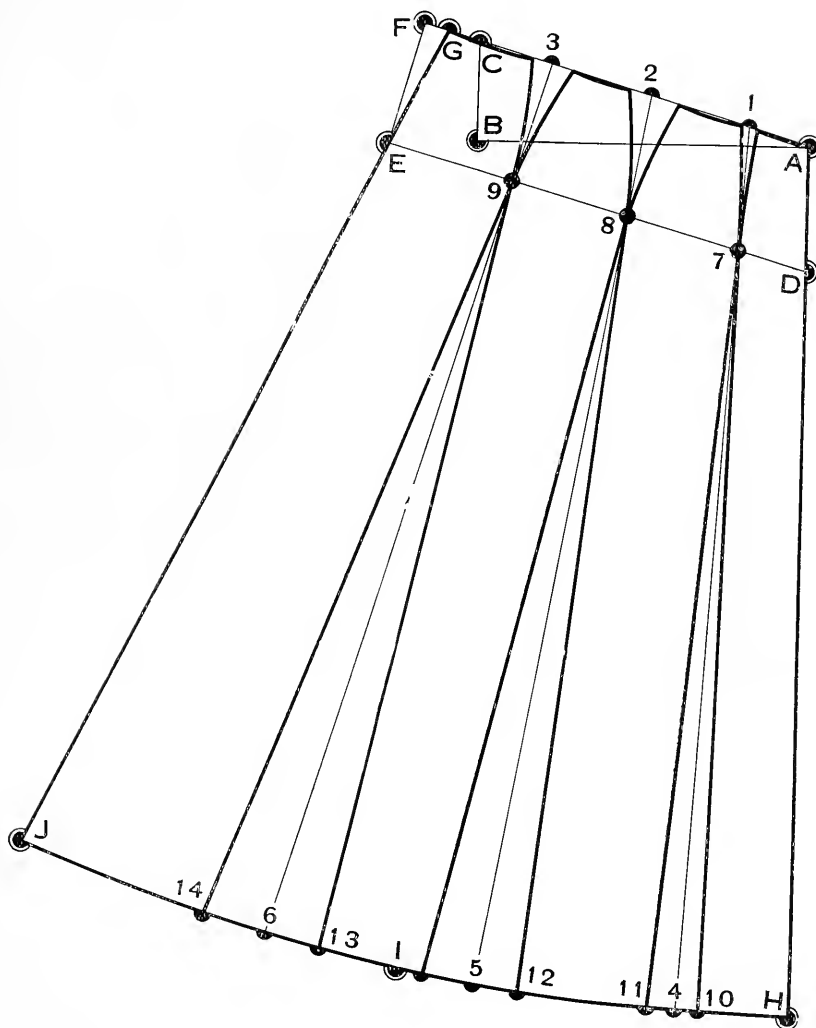

Princess Skirt

This draft represents a seven gore princess skirt.

First lay up all points as described in Systematic Outline for Skirts, then continue as follows:

1 from **A** is 3 inches.

2 and **3** are located by dividing the waist line from **1** to **G** of three equal parts.

4 from **H** is twice as much as **1** from **A** less $\frac{1}{2}$ inch.

5 from **J** is $2\frac{1}{2}$ inches.

6 and **7** are located by dividing the bottom from **4** to **5** of three equal parts.

8-9-10 are located by drawing lines from **1** to **4**, **2** to **6**, **3** to **7**.

11-12-13-14-15-16 are located by taking out darts at points **1**, **2**, **3**, as described on previous pages.

17-18-19-20 are the center of each gore at the hip line.

Make the girdle as high desired.

For instance:

21 from **A** is 3 inches.

22 from **2** is $2\frac{1}{2}$ inches.

23 from **G** is $3\frac{1}{2}$ inches.

24 is located by drawing a line from **18** through **12**.

25 is located by drawing a line from **17** through **11**.

26 is located by drawing a line from **18** through **13**.

27 is located by drawing a line from **19** through **14**.

28 is located by drawing a line from **19** through **15**.

29 is located by drawing a line from **20** through **16**.

Finish the draft as represented.

Princess Skirt

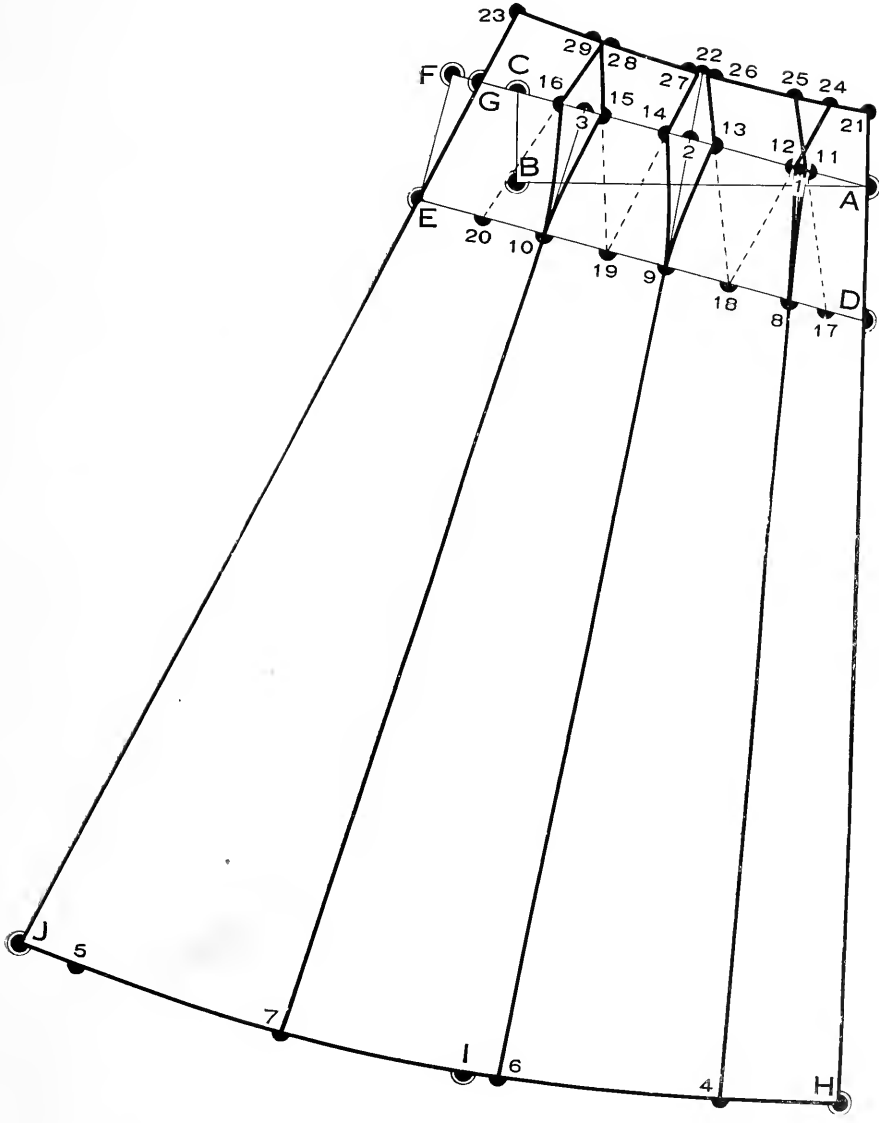

Systematic Outline for Skirts with fixed bottom width

First lay up all points to measure as described in Systematic Outline for Skirts (page 136), then continue as follows:

1 from H is the fixed bottom width.

2 is located by drawing a line from 1 through E.

3 from 2 is the same as 2 from G on line drawn from 1 through E.

4 is the center between A-C.

Draw a line from 4 through 3.

5 from 3 is 6 inches.

6 is the center between D-E.

Draw a line from 6 through 5.

7 from 6 is the same as E from 6 on line drawn from 6 through 5.

8 is located by drawing a line from 1 through 7.

Measure the back length from 8 to 1 and finish the waist and bottom lines as represented.

This Systematic outline can be used to produce Circular Skirts too.

Systematic Outline for Skirts with fixed bottom width

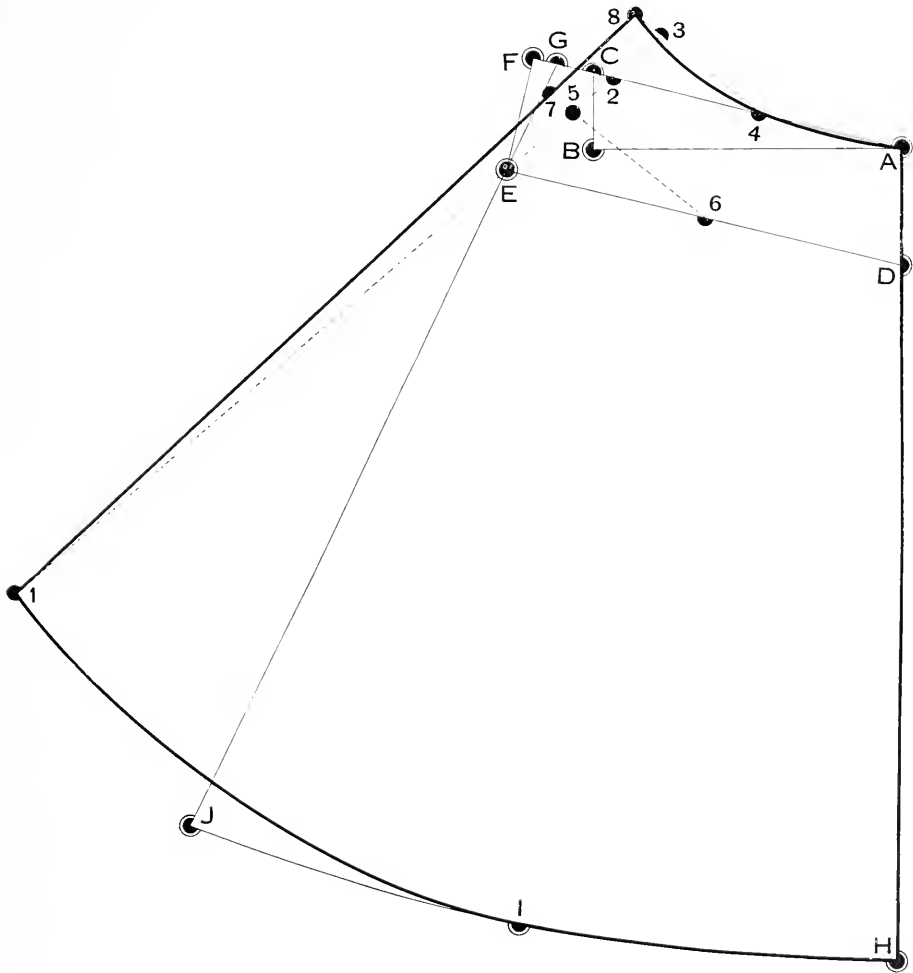

Skirt for Stout Measurement

Measures:

Waist 40 inches.
Hips 50 inches.

Front length 40 inches.
Side length 39 inches.
Back length 38 inches.

To Draft

A. Square both ways from A as represented.

B from A is the half waist measure plus 3 inches, in this case 23 inches.

C from B is 2 inches on line squared out from B.

Draw a line from A through C.

D from A is 6 inches.

E from D is the half hip measure, in this case 25 inches on line drawn from D parallel with line A-C.

F is located by a line squared out from E.

G from F is $1\frac{1}{4}$ inches.

H from A is the front length measure, in this case 40 inches.

I from the middle of line A-G is the side length, in this case 39 inches.

J is located by drawing a line from G through E and is from G the back length, in this case 38 inches.

This diagram represents for instant a five gore stout skirt.

1 from A is the width desired for the front panel, in this case 4 inches.

2 is the center between 1 and G.

3 from H is twice as much as 1 from A less $\frac{1}{2}$ inch, in this case $7\frac{1}{2}$ inches.

4 is the center between 3 and J.

Draw lines from 1 to 3 and from 2 to 4.

The difference between the measure of the waist line from A to G and the half actual waist measure is to be taken out in Darts at points 1 and 2 as represented.

Note that the front dart by stout skirts is larger than by normal skirts.

To make wider the bottom, allow fulness at points 3 and 4.

Bear in mind that fulness is to be allowed towards the back always more.

For instance:

5 from 3 is $1\frac{1}{2}$ inches.

6 from 3 is $1\frac{1}{2}$ inches.

7 from 4 is $2\frac{1}{2}$ inches.

8 from 4 is $2\frac{1}{2}$ inches.

Draw lines from the hip line to points 5, 6, 7, 8 and finish the draft as represented.

Skirt for Stout Measurement

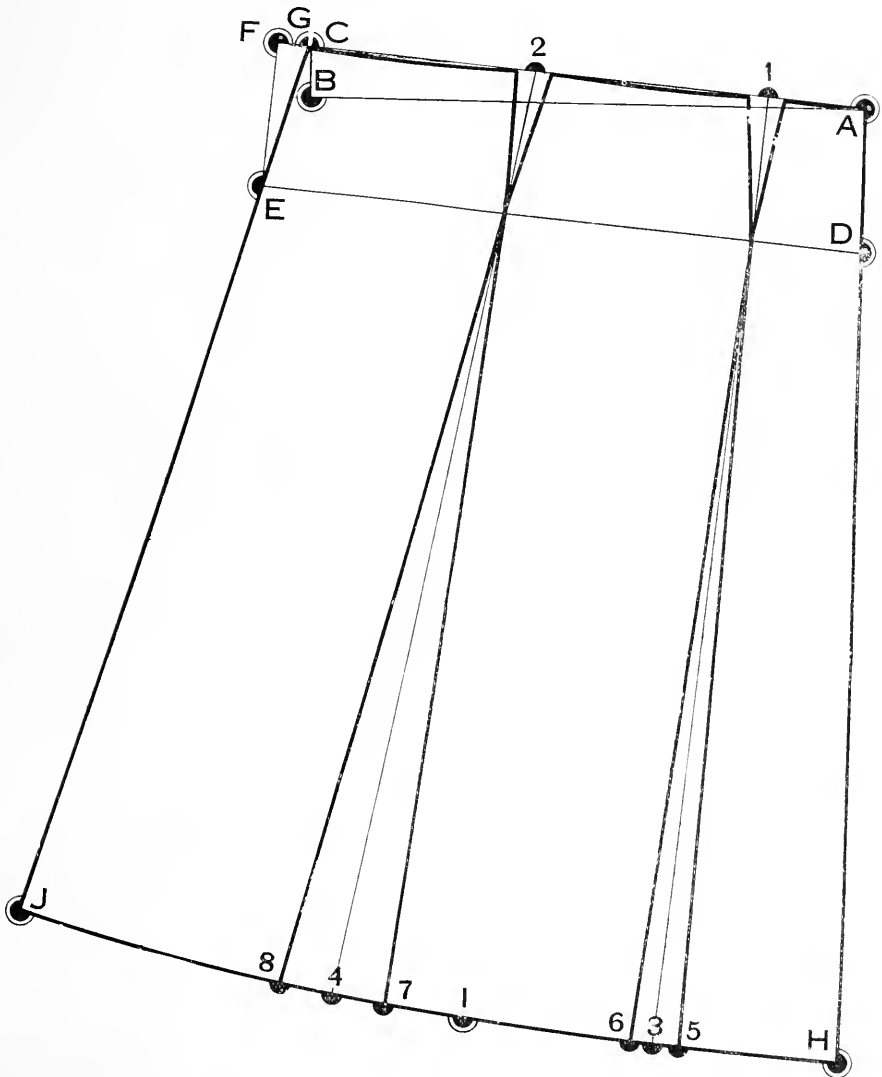

Princess Slip

First cut out a tight-fitting or a semi-fitting garment till the hip line, then mark each gore separate on a piece of paper as represented.

This is a tight-fitting french seam princess slip.

A-B, C-D, E-F, G-H, I-J is the waist line.

K-L, M-N, O-P, Q-R, S-T is the hip line.

To continue the lines from the hip line down proceed as follows :

1 from C is $\frac{1}{2}$ inch.

2 from D is $\frac{1}{2}$ inch.

3 from E is $\frac{1}{2}$ inch.

4 from F is $\frac{1}{4}$ inch.

5 from G is 1 inch.

Draw lines from A through K, from B through L, from 1 through M, from 2 through N, from 3 through O, from 4 through P, from 5 through Q, from H through R, from I through S, from J through T.

Finish the length as desired.

Princess Slip

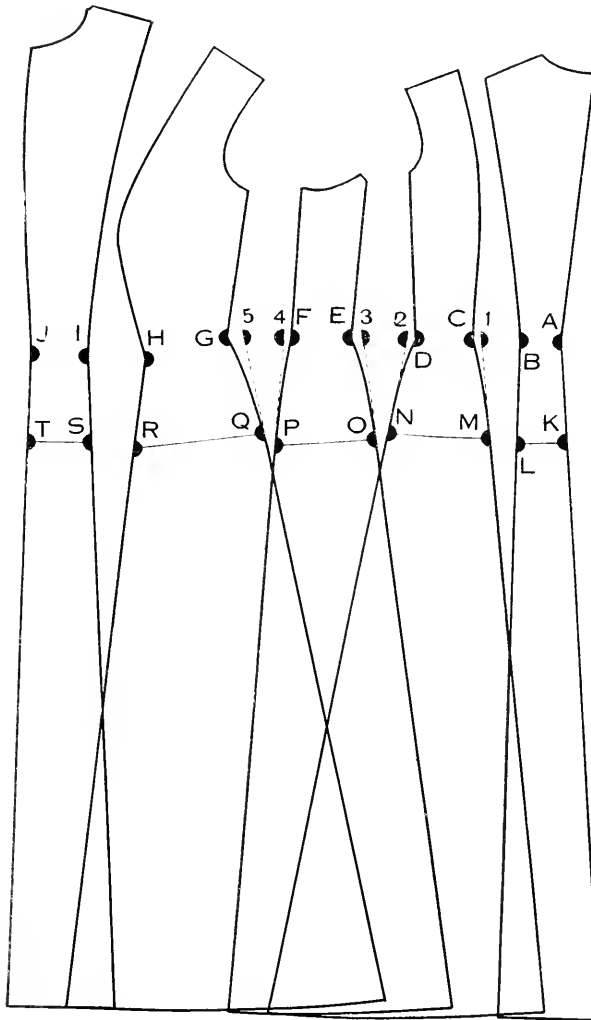

This System is taught by the author only.

It has been copyrighted, and any infringement will be legally contested.

PART TWO

MISSES' GARMENTS

The System for Misses' Garments is the same as for Womans' Garments; it is only constructed by special measurement.

Table of Proportionate Measurements
For Misses' Sizes

SIZE (AGE)		14	16	18	20
Height		5 Feet 2 in.	5 Feet 4 in.	5 Feet 6 in.	5 Feet 6 in.
Scye depth		6 ³ / ₄	7	7 ¹ / ₄	7 ¹ / ₄
Back waist length		14 ¹ / ₂	15	15 ¹ / ₂	15 ¹ / ₂
Bust		35	37	39	41
Waist		23	24	25	26
Hips		37	39	41	43
Neck		13	13 ¹ / ₂	14	14 ¹ / ₂
Back width		13	13 ¹ / ₂	14	14 ¹ / ₂
Sleeve (Inside seam).		17	17 ¹ / ₂	18	18
S k i r t	Front length	39	40	41	41
	Side length	40 ¹ / ₂	41 ¹ / ₂	42 ¹ / ₂	42 ¹ / ₂
	Back length	41	42	43	43

Systematical Outline

For Misses' Garments

Measurement

Scye depth 7 inches.
Back waist-length 15 inches.
Bust 37 inches.

Waist 24 inches.
Hips 39 inches.
Sleeve $17\frac{1}{2}$ inches.

To Draft

A. Draw a straight line as from A to D.

B from A is the Scye depth measure, in this case 7 inches.

C from A is the Back waist-length measure, in this case 15 inches.

D from C is 6 inches always.

Square out from A for the top line, from B for the Bust line, from C for the waist line and from D for the hip line as represented.

E from B is the half Bust measure and 4 inches more, in this case $22\frac{1}{2}$ inches.

F is the half-way between B and E.

G is the half-way between E and F.

H is the half-way between B and F.

I from A is $5\frac{1}{2}$ inches always.

Square out from E, F, G and I as represented.

J from I is $2\frac{1}{4}$ inches.

K from A is the half of the distance from B to H, in this case $2\frac{1}{8}$ inches.

Square out from K as represented.

L is located by drawing a line from A to J.

M from H is 2 inches.

Square out from M as represented.

N from M is $\frac{3}{8}$ inch less than the Scye depth measure, in this case $6\frac{5}{8}$ inches.

O from N is $1\frac{1}{2}$ inch on line drawn from L through N.

P is the half-way between M and N.

Q from I is $\frac{3}{4}$ inch.

R is located by drawing a line from A through Q.

S from G is $3\frac{1}{4}$ inches.

Square out from S as represented.

T from S is $1\frac{3}{4}$ inches less than the distance from G to R.

U from R is $\frac{3}{8}$ inch more than the distance from L to O on line drawn from R through T. Cut off the point at R of $\frac{3}{8}$ inch as represented.

V from S is 2 inches. Connect U-V.

W from R is 2 inches.

Square out from W as represented.

X from W is $\frac{3}{4}$ inch more than the distance from A to K, in this case $3\frac{5}{8}$ inches.

Y is located by a line squared out from E.

Z is located by a line squared out from F.

Notice

In all Diagrams designed in this Systematical Outline are seam-allowances of $\frac{3}{8}$ inch allowed.

In all Diagrams designed in this Systematical Outline is the half Waist measure 7 inches less than the half Bust measure. (See Waist Suppression on page 174.)

In all Diagrams designed in this Systematical Outline is the half Hips measure $1\frac{1}{2}$ inch more than the half Bust measure. (See Hips Development on page 174.)

Systematic Outline

For Misses' Garments

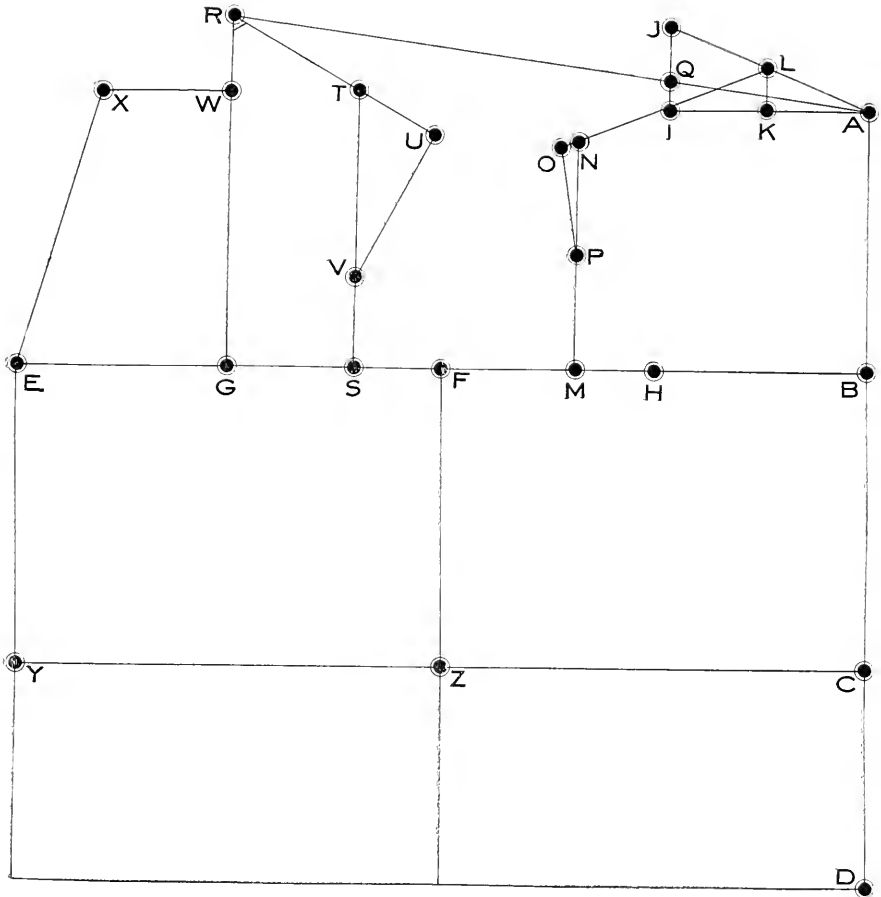

Tight Fitting French Seam

For Misses' Garments

First lay up all points to your measure as described in Systematical Outline, then continue as follows:

- 1 from Z is $1\frac{1}{2}$ inch.
 2 from Y is $2\frac{1}{4}$ inches.
 Draw lines from C to 1 and from 1 through 2 for the fashionable waist line as represented.
 3 from C is 2 inches.
 4 from D is $1\frac{3}{4}$ inches.
 5 from O is $\frac{3}{4}$ inch.
 6 from P is $\frac{3}{4}$ inch.
 Draw a line from 5 to 6.
 7 is the half-way between 5 and L, or make the width to style or taste.
 8 from 3 is 1 inch less than A to K.
 9 is located by drawing a line from 7 to 8 as represented.
 10 from 4 is $\frac{3}{4}$ inch more than 3 to 8.
 11 from 8 is $\frac{3}{4}$ inch.
 12 from 10 is 1 inch.
 13 from F is $\frac{3}{4}$ inch.
 14 from 1 is $\frac{3}{4}$ inch.
 15 is located by drawing a line from 13 through 14.
 16 is the half-way between 9 and 13.
 17 is half-way between 11 and 14.
 18 is located by drawing a line from 16 through 17.
 19 from 17 is $\frac{1}{2}$ inch.
 20 from 17 is $\frac{1}{2}$ inch.
 21 from 18 is 1 inch.
 22 from 18 is 1 inch.
 23 from 15 is $\frac{1}{2}$ inch.
 24 from 7 is $\frac{3}{8}$ inch, and is $\frac{1}{4}$ inch higher from the line L-5.
 25 from 5 is $\frac{3}{8}$ inch, and is from 6 the same length as O from P.
 26 from 16 is 1 inch.
 27 from 26 is $\frac{3}{8}$ inch for seam.
 Finish the back and side gores as represented.
 28 from 14 is $\frac{3}{4}$ inch, and is from 13 the length as 14 from 13.
 29 from 15 is $1\frac{1}{2}$ inches.
 30 from 2 is $1\frac{3}{4}$ inches.
 31 is located by drawing a line from E through 30.
 32 from 31 is $\frac{3}{8}$ inch.
 33 from G is $3\frac{1}{4}$ inches.
 34 from 33 is 2 inches on line drawn from 33 parallel with line 1-2.
 35 is located by drawing a line from 34 parallel with line E-30.
 36 from 35 is $1\frac{1}{4}$ inches.
 37 from 35 is $2\frac{3}{4}$ inches.
 38 from 34 is the same length as 36 from 34.
 39 is located by drawing a line from 36 parallel with line E-31.
 40 from 39 is $4\frac{1}{4}$ inches.
 41 from R is the same width as L to 7.
 Draw a line from 41 to 34.
 42 from 41 is $\frac{3}{4}$ inch for seams.
 Draw a line from 42 parallel with line 41-34.
 43 from 14 is the same length as 29 from 28.
 44 from 40 is $1\frac{1}{4}$ inches.
 45 from 36 is the same length as 44 from 38.
 Finish the front as represented.

Waist Suppression

By applying this System the half Waist measure is 7 inches less than the half Bust measure. For instance by 37 Bust figure the half waist as follows: Half Bust $17\frac{1}{2}$ less 7 is $11\frac{1}{2}$ the half waist. Now change the draft as follows:

Systematic half Waist measure is $11\frac{1}{2}$ inches.

Actual half Waist measure is 12 inches.

There is missing $\frac{1}{2}$ inch in Waist. This $\frac{1}{2}$ inch is to be added to the waist and also to the Hips by the dart at points 37 and 40.

Point 37 from 35 will be only $2\frac{1}{4}$ inches, and point 40 from 39 is $4\frac{1}{4}$ inches.

Hip Development

By applying this System the half Hip measure is $\frac{1}{2}$ inch more than the half Bust measure; in this case the Systematic Hip measure is 19 inches. By correcting the Waist measure the half Hip measure gained $\frac{1}{2}$ inch, therefore the half Hip measure is now $19\frac{1}{2}$ inches, and as the actual half hip measure is also $19\frac{1}{2}$ inches, there is nothing else to change at the Hip.

If the actual half Hip measure would be for instance 20 inches, a half inch ought to be added at the points 43, 29, 21, 22 equal divided and vica verse.

Tight Fitting French Seam

For Misses' Garments

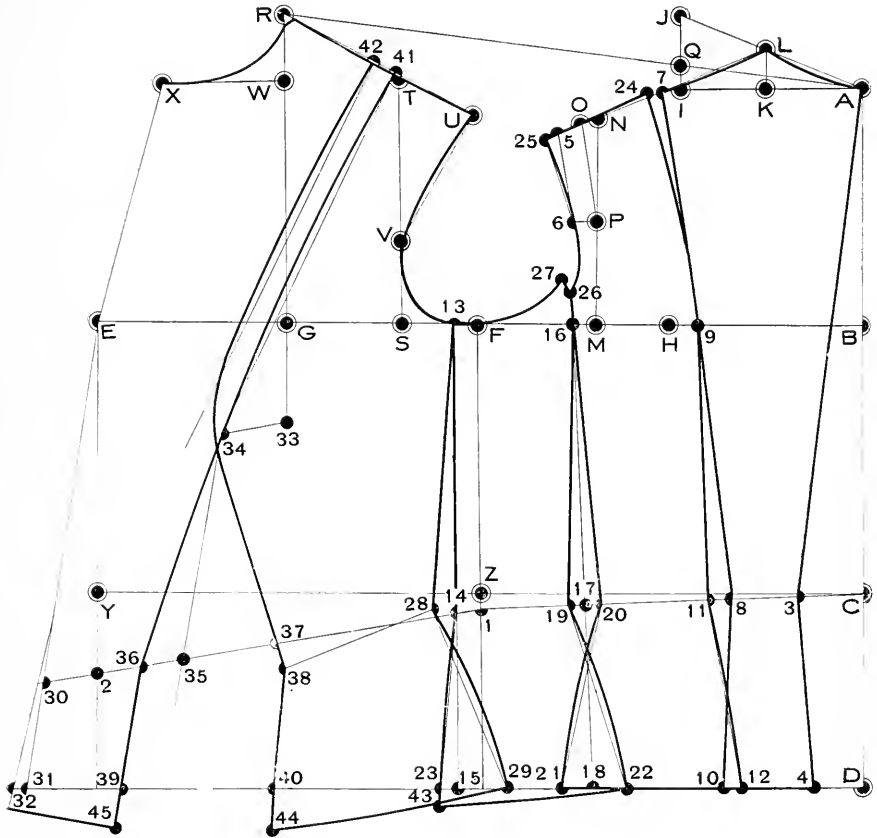

Semi-Fitting with dart in Front

For Misses' Sizes

First lay up all points to your measure as described in Systematic Outline for Misses' Garments, then continue as follows:

1 from Z is $1\frac{1}{2}$ inch.

2 from Y is $2\frac{1}{4}$ inches.

Draw lines from C to 1 and from 1 through 2 for the fashionable waist line as represented.

3 from C is $1\frac{1}{2}$ inches.

4 from 3 is $\frac{1}{4}$ inch.

5 from D is 1 inch.

6 from P is $\frac{3}{4}$ inch.

7 from H is $\frac{3}{4}$ inch.

8 from 4 is 1 inch more than the distance from A to K.

9 from 5 is $\frac{3}{4}$ inch more than the distance from 4 to 8

Finish the back as represented.

10 from 8 is $\frac{1}{2}$ inch.

11 from 9 is $1\frac{1}{2}$ inches.

12 from 6 is $\frac{1}{2}$ inch.

13 from F is $\frac{3}{4}$ inch.

14 from 1 is $\frac{3}{4}$ inch.

15 is located by drawing a line from 13 through 14.

16 from 14 is $\frac{1}{2}$ inch.

Finish the side gore as represented.

17 from 1 is $\frac{1}{2}$ inch, and is from F the same length as 16 from 13.

18 from 15 is 1 inch.

19 from 2 is 2 inches.

Draw line from E through 9.

20 from G is $3\frac{1}{4}$ inches.

21 from 20 is $1\frac{1}{2}$ inches on line drawn parallel with line E-19

22 is located by drawing a line from 21 parallel with line E-19.

23 is located by drawing a line from 21 parallel with line E-19.

24 from 22 is $\frac{1}{2}$ inch.

25 from 24 is 3 inches.

26 from 21 is the same length as 24 from 21.

27 from 23 is $\frac{3}{8}$ inch.

28 from 27 is $3\frac{1}{4}$ inches.

Finish the front as represented.

29 from 16 is the same length as 18 from 17.

30 from 28 is $1\frac{1}{4}$ inches.

31 from 24 is the same length as 30 from 26.

Finish the bottom as represented.

Semi-Fitting with dart in Front

For Misses' Sizes

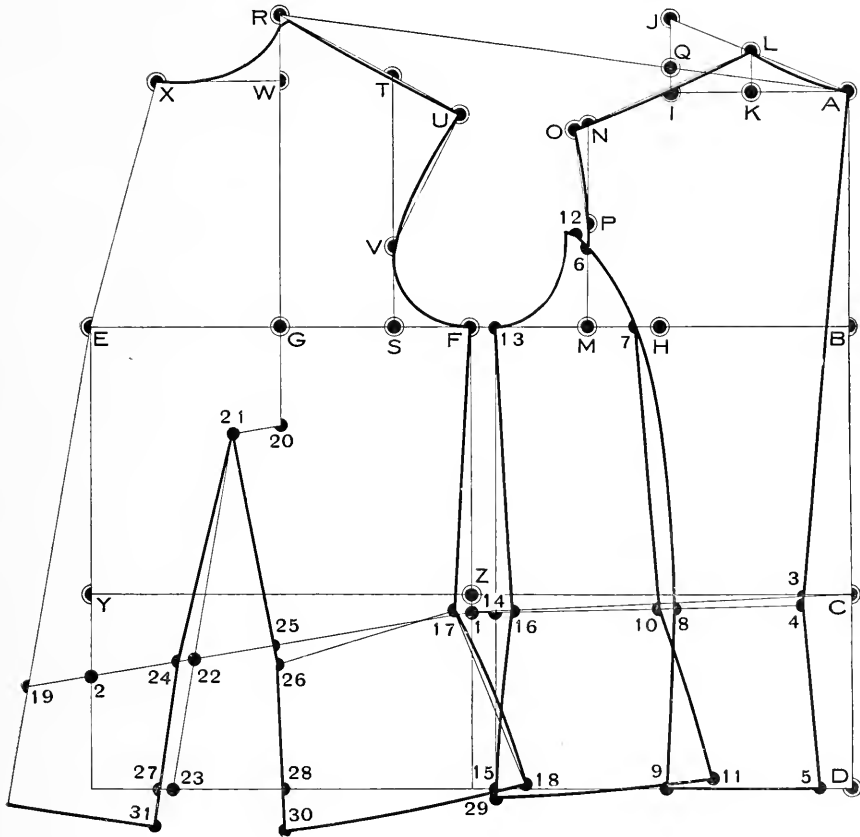

Sac Coat with Loose Front

For Misses' Sizes

First lay up all points to your measure as described in Systematic Outline, then continue as follows:

1 from Z is $\frac{1}{2}$ inch.

2 from Y is $2\frac{1}{4}$ inches.

Draw lines from C to 1 and from 1 to 2 for the fashionable waist line as represented.

3 from C is $1\frac{1}{2}$ inches.

4 from 3 is $\frac{1}{4}$ inch.

5 from D is 1 inch.

6 from M is $\frac{3}{4}$ inch.

7 from 6 is $\frac{3}{4}$ inch.

8 from 4 is 3 inches more than K from A.

9 is located by drawing a curved line from 7 to 8 as represented.

10 from 5 is $\frac{3}{4}$ inch more than 8 from 4.

Finish the back as represented.

11 from 8 is $\frac{1}{2}$ inch.

12 from 10 is $1\frac{3}{4}$ inches.

13 from F is $\frac{1}{2}$ inch.

14 from I is $\frac{1}{2}$ inch.

15 from 14 is $2\frac{1}{2}$ inches and is located by drawing a line from 13 through 14,

16 from 14 is $\frac{3}{8}$ inch.

17 from 14 is $\frac{3}{8}$ inch.

18 from 2 is $\frac{1}{2}$ inch.

19 from A is the length of garment desired.

20 is located on line squared out from 19.

21 is located by drawing a line from E through 18.

22 from 11 is the same length as 20 from 8.

23 from R is 1 inch.

24 is located by a line squared down from S and is $2\frac{1}{2}$ inches below the fashionable waist line.

25 from 24 is $\frac{1}{2}$ inch.

26 is located by drawing a line from 25 through 15 and is the half of the pocket size, in this case 3 inches.

27 is located by drawing a line from 26 through 25 and is the full pocket size, in this case 6 inches.

28 from S is 1 inch.

29 from G is $\frac{1}{2}$ inch.

30 is located by drawing a line from 28 through 29, and is in this case 5 inches long.

Finish the draft as represented.

Sac Coat with Loose Front

For Misses' Sizes

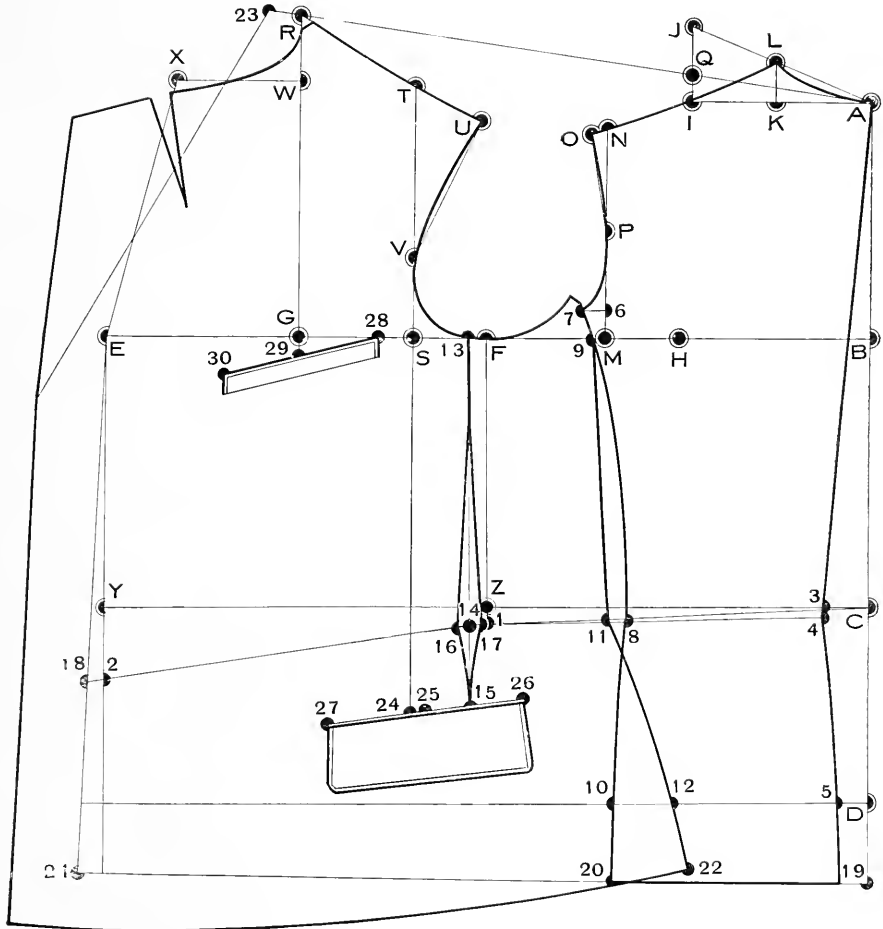

Loose Box Coat

For Misses' Sizes

First lay up all points as described in Systematical Outline for Misses' sizes, then continue as follows:

1 from Z is $\frac{1}{2}$ inch.

2 from Y is $2\frac{1}{2}$ inches.

Draw lines from C to 1 and from 1 through 2 as represented.

3 is the half way between F and M.

4 from 3 is $\frac{5}{8}$ inch.

5 from 3 is $\frac{5}{8}$ inch.

6 from 1 is $\frac{1}{4}$ inch more than 5 from F.

7 from 6 is $1\frac{1}{4}$ inches.

8 from C is $\frac{3}{4}$ inch.

9 from A is $\frac{3}{4}$ inch.

10 from L is $\frac{1}{4}$ inch.

11 from R is $\frac{3}{4}$ inch.

12 from 2 is $\frac{1}{2}$ inch.

Draw a line from E through 12.

13 from A is the length of garment desired.

14 is located by a line squared out from 13.

15 from 14 is $\frac{1}{2}$ inch.

16 from 4 is the same length as 15 from 5.

17 is located by a line squared out from 13.

18 from 17 is $1\frac{1}{4}$ inches.

19 from 11 is 1 inch.

Allow for button stand 3 inches for single breasted, 4 inches for double breasted.

Finish the draft as represented.

If you wish to have the back center without any seam, take off $\frac{3}{8}$ inch at the back center.

Loose Box Coat

For Misses' Sizes

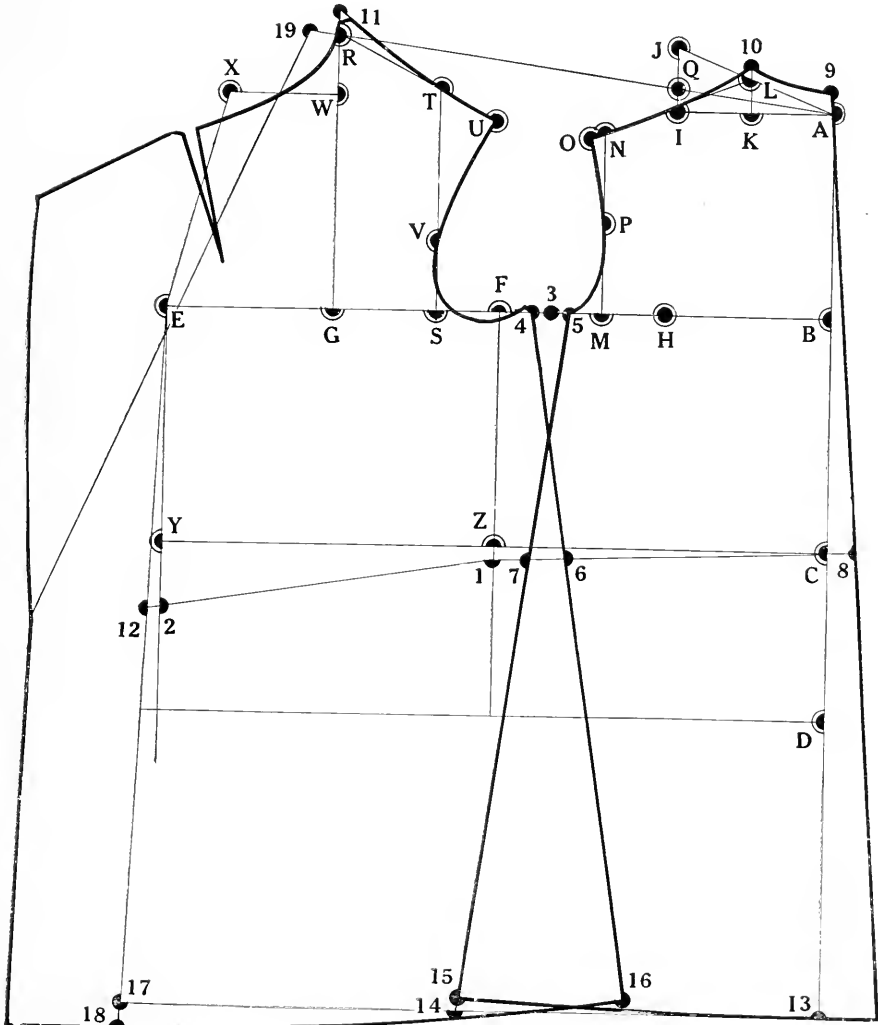

Blouse

For Misses' Sizes

First lay up all points to your measure as described in Systematic Outline for Misses' Sizes, then continue as follows :

1 from Z is $\frac{1}{2}$ inch.

2 from Y is $2\frac{1}{4}$ inches.

Draw lines from C to 1 and from 1 to 2 for the fashionable waist line as represented.

3 from C is 2 inches.

4 is the half-way between F and M.

5 from 4 is $\frac{3}{4}$ inch.

6 from 1 is 4 inches.

Finish the back as represented

7 from 4 is $\frac{3}{4}$ inch.

8 is located by drawing a line from X through E, and is from E the same length as 2 from E.

Finish the front as represented.

Blouse

For Misses' Sizes

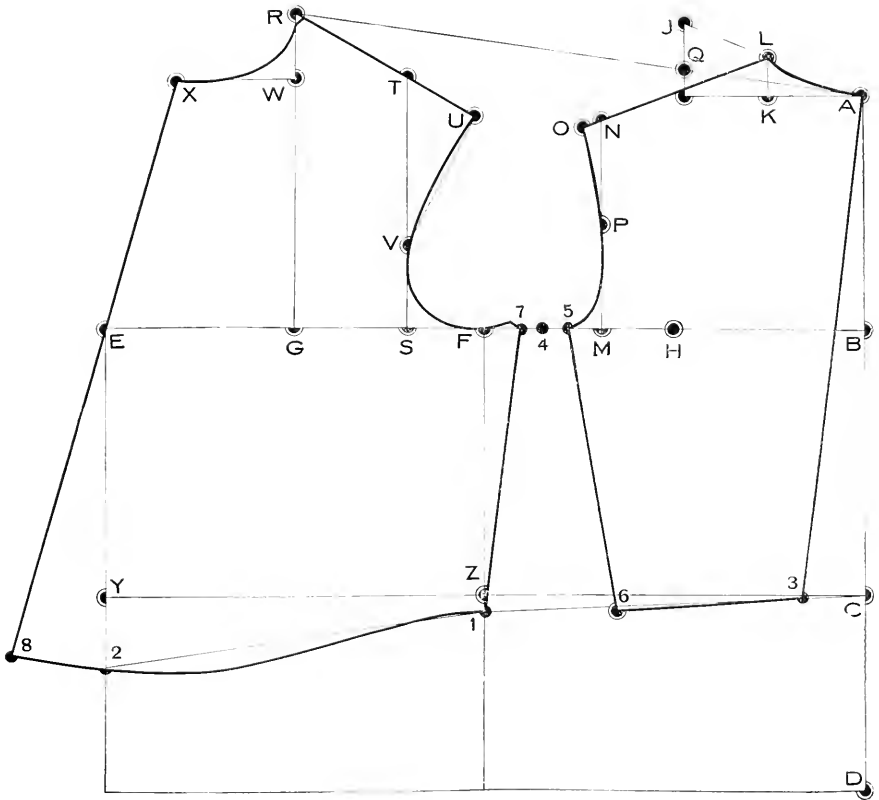

Sleeve Construction for Misses' Garments

Measurement for size 16

Bust 37 inches.

Sleeve length (inside seam) $17\frac{1}{2}$ inches.

1 Draw a straight line as from 1 to 2.

2 from 1 is the sleeve length measure.

Square a line up from 2.

3 from 1 is a quarter of the full bust measure on line squared up from 1 plus 1 inch.

4 is located by a line squared out from 3 as represented.

5 is the center of 1-2.

6 is located by a line squared up from 5.

7 is the center of 2-4.

8 is the center of 1-3.

Square out a line from 8 as represented.

9 from 8 is 2 inches.

10 from 8 is the same length as 8 from 1.

11 from 1 is 2 inches.

Draw lines between 11-10 and from 10 through 3.

12 is the center of 10-11.

13 is the center of 3-10.

14 from 12 is $\frac{3}{4}$ inch.

15 from 13 is $1\frac{1}{4}$ inches.

16 from 3 is $\frac{1}{2}$ inch.

17 from 3 is $\frac{1}{2}$ inch.

18 from 6 is 2 inches.

19 from 5 is 3 inches.

20 from 7 is 2 inches.

Draw a line from 4 through 20.

21 from 20 is 1 inch.

22 from 20 is 1 inch.

23 from 4 is $\frac{1}{2}$ inch.

24 from 21 is $\frac{1}{2}$ inch.

Draw all construction lines as represented.

Sleeve for Misses' Garments

First lay up all points to measure as described above, then continue as follows :

Shape the top sleeve as represented by lines between 11-10-17-18-4-22-5-11.

Shape the under sleeve as represented by lines between 9-16-18-23-24-19-9.

Sleeve Construction for Misses' Garments

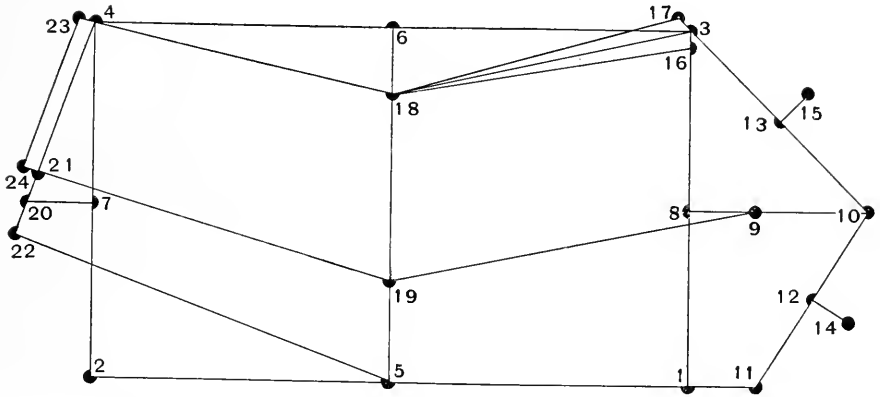

Sleeve for Misses' Garments

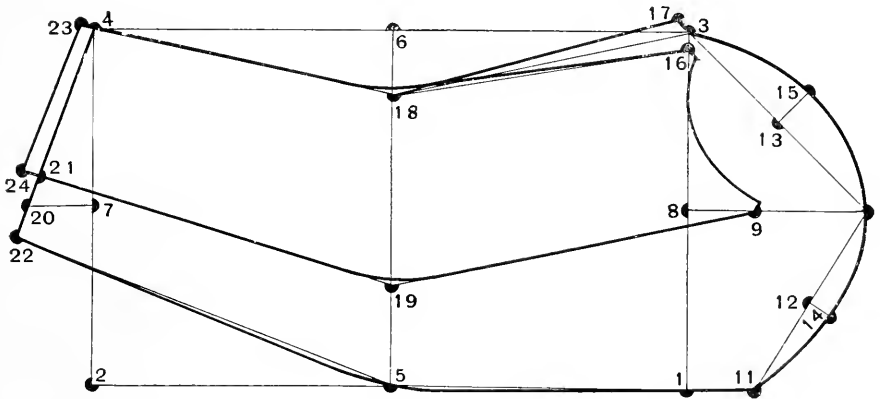

Systematic Outline for Misses' Skirts

Measurement

Waist 24 inches, Hips 39 inches, Front length 40 inches,
Side length $41\frac{1}{2}$ inches, Back length 42 inches.

A. Square both ways from A as represented.

B from A is the half waist measure plus 3 inches., in this case 15 inches.

C from B is 4 inches on line squared out from B.

Draw a line from A through C and longer.

D from A is 6 inches.

E from D is the half Hips measure on line drawn from D parallel with line A-C. in this case
 $19\frac{1}{2}$ inches.

F is located by a line squared out from E.

G from F is $1\frac{1}{4}$ inches.

H from A is the front length, in this case 40 inches.

I from the center of line A-G is the side length, in this case $41\frac{1}{2}$ inches..

J from G is the back length on line drawn from G through E, in this case 42 inches.

Finish the bottom as represented.

NOTICE: In all Drafts — designed in this Systematic Outline — are seams
NOT allowed.

Systematic Outline for Misses' Skirts

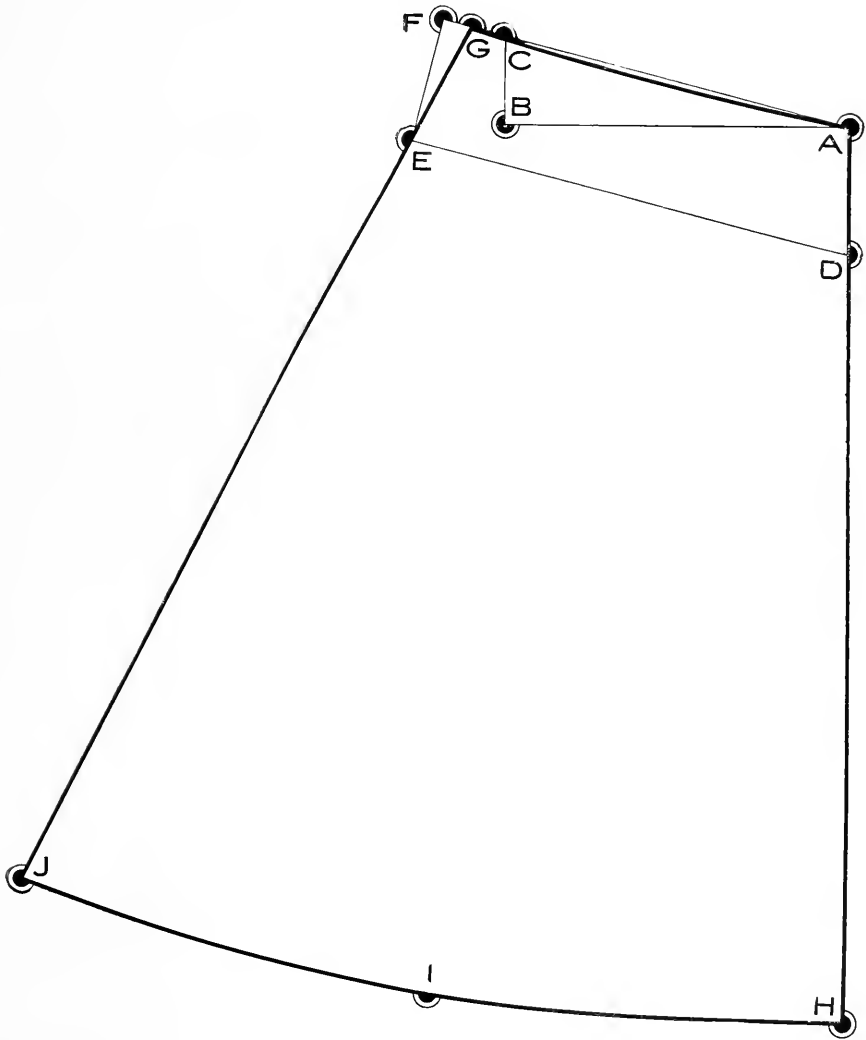

Seven Gore Skirt

For Misses' Sizes

First lay up all points as described in Systematic Outline for Misses' skirts, then continue as follows :

1 from A is 3 inches.

2 from 1 is one-third of the line from 1 to G.

3 is the center between 2 and G.

4 from H is $5\frac{1}{2}$ inches.

5 from 4 is 1 inch less than one-third of 4-5.

6 from 5 is 1 inch less than the half-way between 5 and J.

Draw lines between 1-4, 2-5 and 3-6 as represented.

Measure the waist line from A to G and the difference between this measure and the half actual waist measure is to be taken out in darts at points 1-2-3 as represented.

At the front (point 1) take out the least and at the side (point 5) take out the most dart.

NOTICE : No seams or turning are allowed.

Allow for all seams.

Seven Gore Skirt

For Misses' Sizes

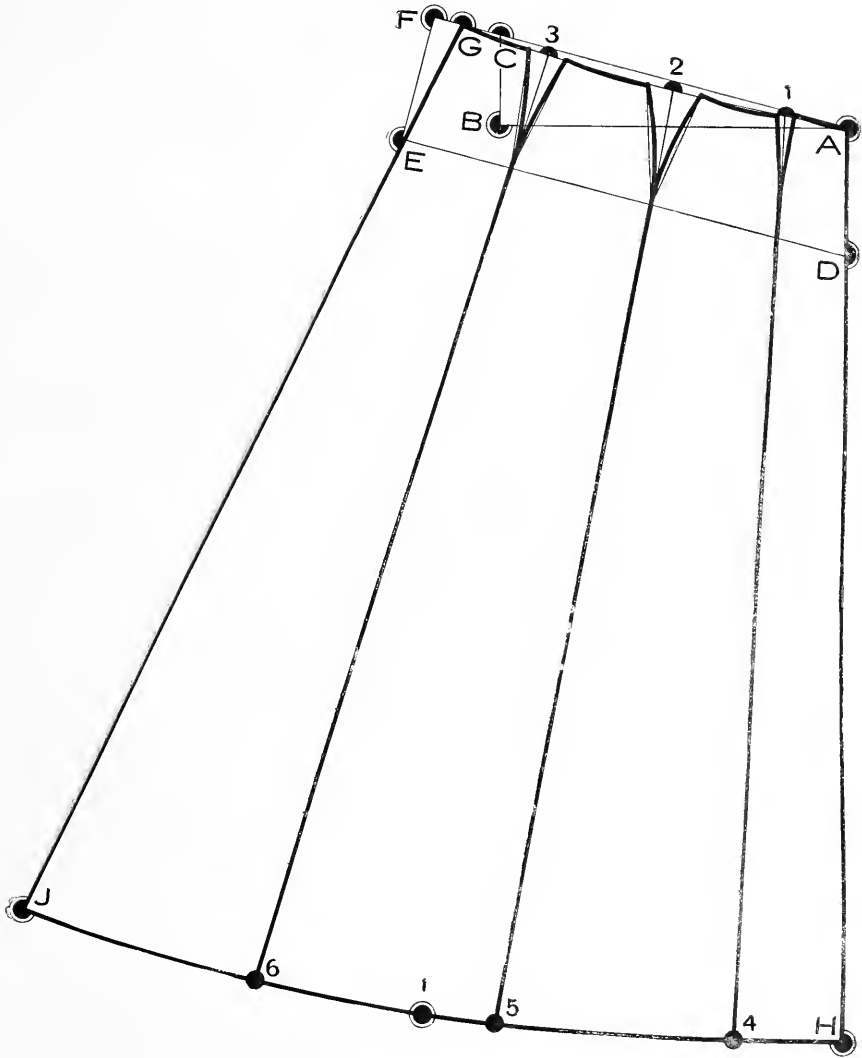

Collars for Misses' Garments are constructed the same way as
for Womens' Garments.

PART THREE

JUNIORS' GARMENTS

The System for Juniors Garments' is the same as for Womans' Garments; it is only constructed by special measurement.

Table of Proportionate Measurements For Juniors' Sizes

SIZE (AGE)		12	13	14	15	16	17	18
Height		5 Feet	5 Feet 1 in.	5 Feet 2 in.	5 Feet 3 in.	5 Feet 4 in.	5 Feet 5 in.	5 Feet 6 in.
Scye depth		6 ³ / ₈	6 ¹ / ₂	6 ⁵ / ₈	6 ³ / ₄	6 ⁷ / ₈	7	7 ¹ / ₈
Back waist length		13 ³ / ₄	14	14 ¹ / ₄	14 ¹ / ₂	14 ³ / ₄	15	15 ¹ / ₄
Bust		32	33	34	35	36	37	38
Waist		23	23 ¹ / ₂	24	24 ¹ / ₂	25	25 ¹ / ₂	26
Hips		34	35	36	37	38	39	40
Neck		12 ¹ / ₂	12 ³ / ₄	13	13 ¹ / ₄	13 ¹ / ₂	13 ³ / ₄	14
Back width		12 ¹ / ₂	12 ³ / ₄	13	13 ¹ / ₄	13 ¹ / ₂	13 ³ / ₄	14
Sleeve (Inside seam).		15 ¹ / ₂	16	16 ¹ / ₂	17	17 ¹ / ₂	18	18
S k i r t	Front length	30	32	34	36	38	40	42
	Side length	31	33	35	37	39	41	43
	Back length	31	33	35	37	39	41	43

Semi-Fitting French Seam

For Juniors' Sizes

First lay up all points to your measure as described in Systematic Outline (page 172), then continue as follows:

- 1 from Z is $\frac{1}{2}$ inch.
 2 from Y is $2\frac{1}{4}$ inches.
 Draw lines from C to 1 and from 1 through 2 for the fashionable waist line as represented.
 3 from C is $1\frac{1}{2}$ inches.
 4 from 3 is $\frac{1}{4}$ inch.
 5 from D is 1 inch.
 6 from O is $\frac{3}{4}$ inch.
 7 from P is $\frac{3}{4}$ inch.
 Draw a line from 6 to 7.
 8 is the half-way between 7 and 4, or make the width to style or taste.
 9 from 4 is 1 inch more than the distance from A to K.
 10 from 5 is $\frac{3}{4}$ inch more than the distance from 4 to 9.
 11 is located by drawing a line from 8 to 9 as represented.
 Finish the back as represented.
 12 from 9 is $\frac{1}{2}$ inch.
 13 from 10 is $1\frac{1}{2}$ inches.
 14 from F is $\frac{3}{4}$ inch.
 15 from I is $\frac{3}{4}$ inch.
 16 is located by drawing a line from 14 through 15.
 17 from 15 is $\frac{1}{2}$ inch.
 18 from 8 is $\frac{3}{8}$ inch.
 19 from 6 is $\frac{3}{8}$ inch.
 20 from 18 is $\frac{1}{4}$ inch.
 21 from 7 is the same length as O from P.
 Finish the side gore as represented.
 22 from 1 is $\frac{1}{2}$ inch.
 23 from 16 is 1 inch.
 24 from 2 is 2 inches.
 25 from G is $3\frac{1}{4}$ inches.
 26 from 25 is $1\frac{1}{2}$ inches on line drawn from 25 parallel with line 1-2.
 27 is located by drawing a line from 26 parallel with line E-24.
 28 is located by drawing a line from 26 through 27.
 29 from 27 is $\frac{1}{2}$ inch.
 30 from 28 is $\frac{3}{8}$ inch.
 31 from 29 is 3 inches.
 32 from 26 is the same length as 29 from 26.
 33 from 30 is $3\frac{3}{4}$ inches.
 34 from R is the same width as L to 8.
 Draw a line from 11 from 34 to 26.
 35 from 34 is $\frac{3}{4}$ inch for seams.
 Draw a line from 35 parallel with line 34-26.
 36 from 16 is $\frac{1}{4}$ inch.
 37 from 22 is the same length as 36 from 17.
 38 from 33 is $1\frac{1}{4}$ inches.
 39 from 29 is the same length as 38 from 32.
 Finish the front and bottom as represented.

Semi-Fitting French Seam

For Juniors' Sizes

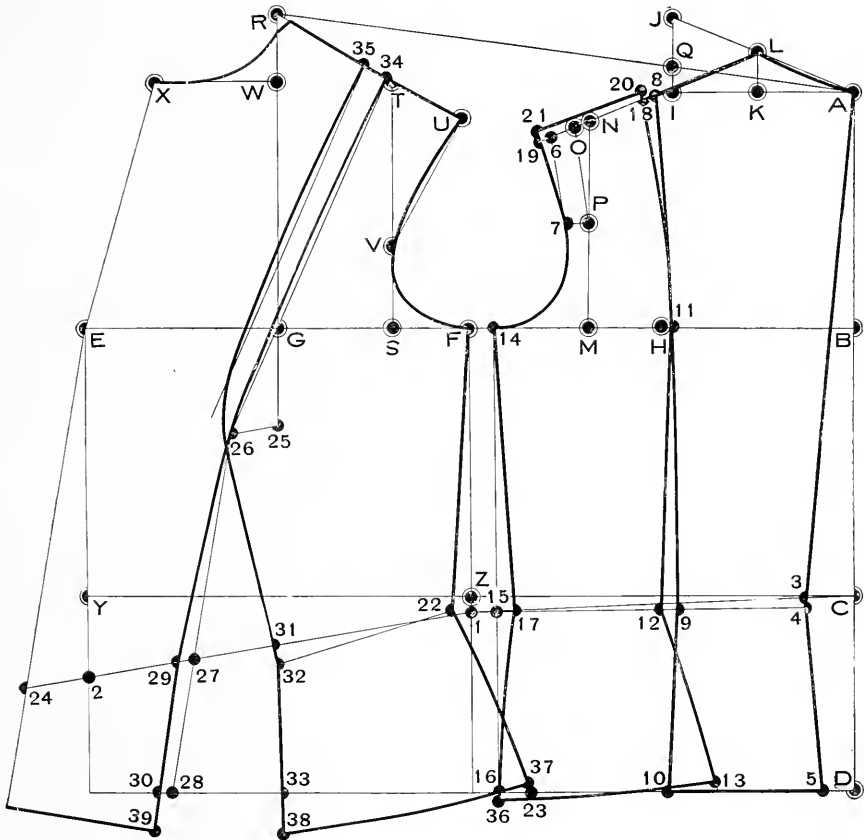

Loose Box Coat

For Juniors' Sizes

First lay up all points as described in Systematic Outline (page 172), then continue as follows:

1 from Z is $1\frac{1}{2}$ inch.

2 from Y is $2\frac{1}{2}$ inches.

Draw lines from C to 1 and from 1 through 2 as represented.

3 is the half-way between F and M.

4 from 3 is $\frac{5}{8}$ inch.

5 from 3 is $\frac{5}{8}$ inch.

6 from 1 is $\frac{1}{4}$ inch more than 5 from F.

7 from 6 is $1\frac{1}{4}$ inches.

8 from C is $\frac{3}{4}$ inch.

9 from A is $\frac{3}{4}$ inch.

10 from L is $\frac{1}{4}$ inch.

11 from R is $\frac{3}{4}$ inch.

12 from 2 is $1\frac{1}{2}$ inch.

Draw a line from E through 12.

13 from A is the length of garment desired.

14 is located by a line squared out from 13.

15 from 14 is $\frac{1}{2}$ inch.

16 from 4 is the same length as 15 from 5.

17 is located by a line squared out from 13.

18 from 17 is $1\frac{1}{4}$ inches.

19 from 11 is 1 inch.

Allow for button stand 2 to 3 inches for single breasted, and 3 to 4 inches for double breasted.

Finish the draft as represented.

If you wish to have the back center without any seam, take off $\frac{3}{8}$ inch at the back center,

Loose Box Coat

For Juniors' Sizes

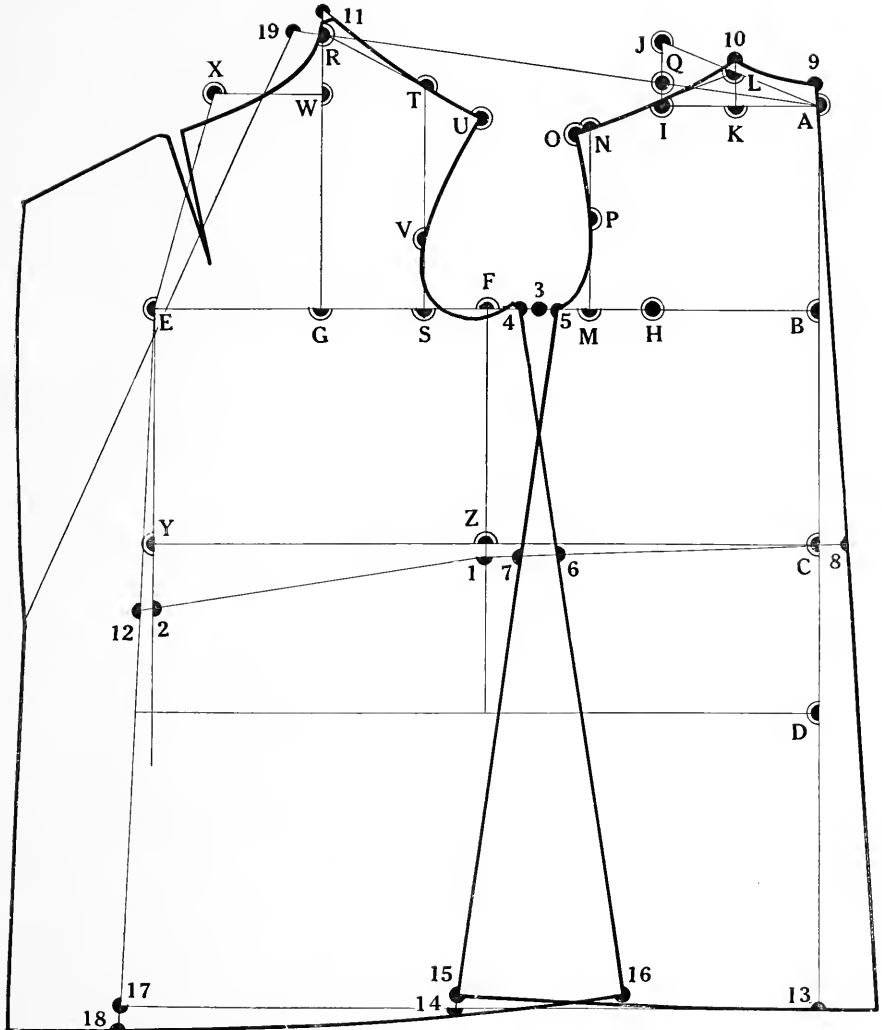

Blouse

For Juniors' Sizes

First lay up all points to your measure as described in Systematic Outline for Misses' Sizes, then continue as follows :

1 from Z is $\frac{1}{2}$ inch.

2 from Y is $2\frac{1}{4}$ inches.

Draw lines from C to 1 and from 1 to 2 for the fashionable waist line as represented.

3 from C is 2 inches.

4 is the half-way between F and M.

5 from 4 is $\frac{3}{4}$ inch.

6 from 1 is 4 inches.

Finish the back as represented.

7 from 4 is $\frac{3}{4}$ inch.

8 is located by drawing a line from X through E, and is from E the same length as

2 from E.

Finish the front as represented.

Blouse

For Juniors' Sizes

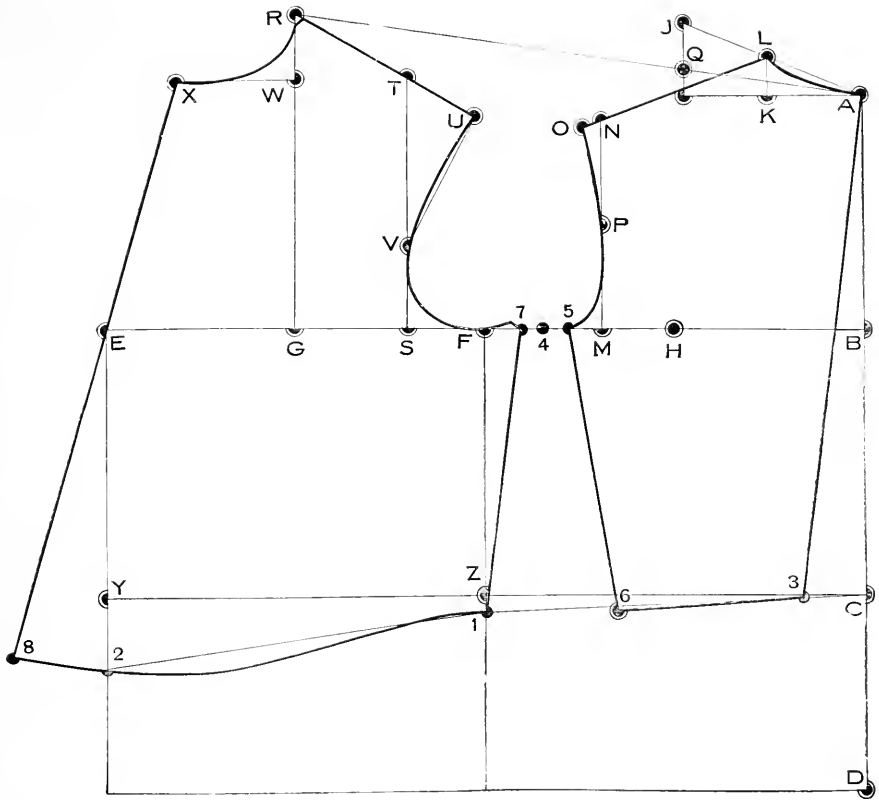

Sleeve Construction for Juniors' Garments

Measurement for Size 15

Bust 35 inches.

Sleeve length (inside seam) 17 inches.

1 Draw a straight line as from 1 to 2.

2 from 1 is the sleeve length measure.

Square a line up from 2.

3 from 1 is a quarter of the full bust measure on line squared up from 1 plus 1 inch.

4 is located by a line squared out from 3 as represented.

5 is the center of 1-2.

6 is located by a line squared up from 5.

7 is the center of 2-4.

8 is the center of 1-3.

Square out a line from 8 as represented.

9 from 8 is 2 inches.

10 from 8 is the same length as 8 from 1.

11 from 1 is 2 inches.

Draw lines between 11-10 and from 10 through 3.

12 is the center of 10-11.

13 is the center of 3-10.

14 from 12 is $\frac{3}{4}$ inch.

15 from 13 is 1 inch.

16 from 3 is $\frac{1}{2}$ inch.

17 from 3 is $\frac{1}{2}$ inch.

18 from 6 is 2 inches.

19 from 5 is 3 inches.

20 from 7 is 2 inches.

Draw a line from 4 through 20.

21 from 20 is 1 inch.

22 from 20 is 1 inch.

23 from 4 is $\frac{1}{2}$ inch.

24 from 21 is $\frac{1}{2}$ inch.

Draw all construction lines as represented.

Sleeve for Juniors' Garments

First lay up all points to measure as described above, then continue as follows

Shape the top sleeve as represented by lines between 11-10-17-18-4-22-5-11.

Shape the under sleeve as represented by lines between 9-16-18-23-24-19-9.

Sleeve Construction for Juniors' Garments

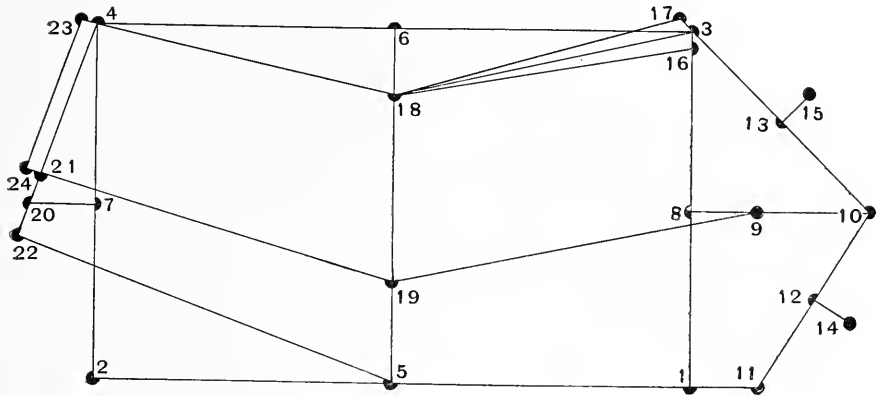

Sleeve for Juniors' Garments

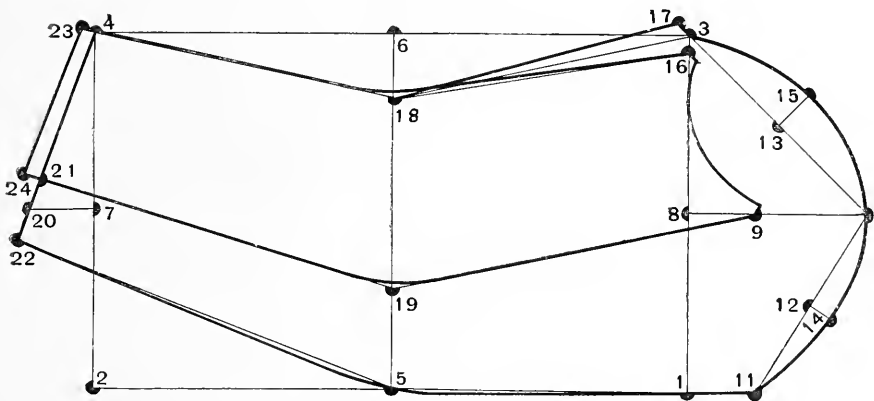

Juniors' Five Gore Skirt

Measurement

Waist $24\frac{1}{2}$ inches, Hips 37 inches, Front length 36 inches,
Side length 37 inches, Back length 37 inches.

A. Square both ways from A as represented.

B from A is the half waist measure plus 3 inches, in this case $15\frac{1}{4}$ inches.

C from B is 4 inches on line squared out from B.

Draw a line from A through C and longer.

D from A is 6 inches.

E from D is the half Hips measure on line drawn from D parallel with line A-C, in this case $18\frac{1}{2}$ inches.

F is located by a line squared out from E.

G from F is $1\frac{1}{4}$ inches.

H from A is the front length, in this case 36 inches.

I from the center of line A-G is the side length, in this case 37 inches.

J from G is the back length on line drawn from G through E, in this case 37 inches.

Finish the bottom as represented.

1 from A is 3 inches.

2 is the center between 1 and G.

3 from H is $5\frac{1}{2}$ inches. (Twice as 1-A less $\frac{1}{2}$ inch.)

4 from J is 3 inches.

5 is the center between 3 and 4.

6 is located by drawing a line from 2 to 5.

The difference between the actual half waist measure and the measure of line A-G is to be taken out in darts as follows:

For instance A-G is 17 inches.

The half actual waist measure is $12\frac{1}{4}$ inches.

Surplus is $4\frac{3}{4}$ inches.

Take out $\frac{1}{2}$ inch at point 1 equal divided on both sides, and $4\frac{1}{4}$ inches at point 2 equal divided on both sides.

7 from 2 is $2\frac{1}{8}$ inches.

8 from 2 is $2\frac{1}{8}$ inches.

9 from 7 is $\frac{3}{4}$ inch on line squared up from 7.

10 from 8 is $\frac{3}{4}$ inch on line squared up from 8.

11 from 6 is $\frac{3}{4}$ inch.

Finish the draft as represented.

Juniors' Five Gore Skirt

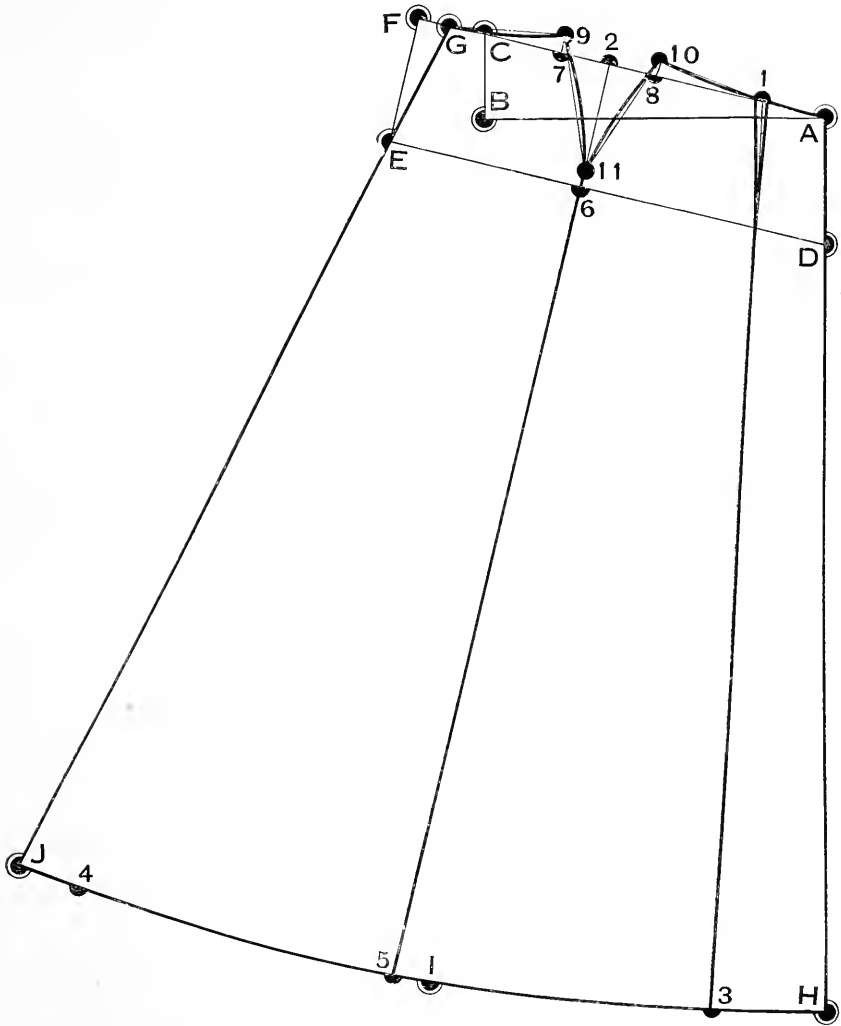

Juniors' Circular Skirt

Measurement

Waist $24\frac{1}{2}$ inches, Hips 37 inches, Front length 36 inches,
Side length 37 inches, Back length 37 inches.

- A.** Square both ways from A as represented.
- B** from A is the half waist measure plus 3 inches, in this case $15\frac{1}{4}$ inches.
- C** from B is 4 inches on line squared out from B.
Draw a line from A through C and longer.
- D** from A is 6 inches.
- E** from D is the half Hips measure on line drawn from D parallel with line A-C, in this case $18\frac{1}{2}$ inches.
- F** is located by a line squared out from E.
- G** from F is $1\frac{1}{4}$ inches.
- H** from A is the front length, in this case 36 inches.
- I** from the center of line A-G is the side length, in this case 37 inches.
- J** from G is the back length on line drawn from G through E, in this case 37 inches.
Finish the bottom as represented.
- 1** from H is the fixed bottom width.
- 2** is located by drawing a line from 1 through E.
- 3** from 2 is the same as 2 from G on line drawn from 1 through E.
- 4** is the center between A-G.
Draw a line from 4 through 3.
- 5** from 3 is 6 inches.
- 6** is the center between D-E.
Draw a line from 6 through 5.
- 7** from 6 is the same as E from 6 on line drawn from 6 through 5.
- 8** is located by drawing a line from 1 through 7.
Measure the back length from 8 to 1 and finish the waist and bottom lines as represented.
Measure up the waist line from A to 8, and the difference between this measure and the actual half waist measure is to be taken out in dart or darts as described on previous pages.

Juniors' Circular Skirt

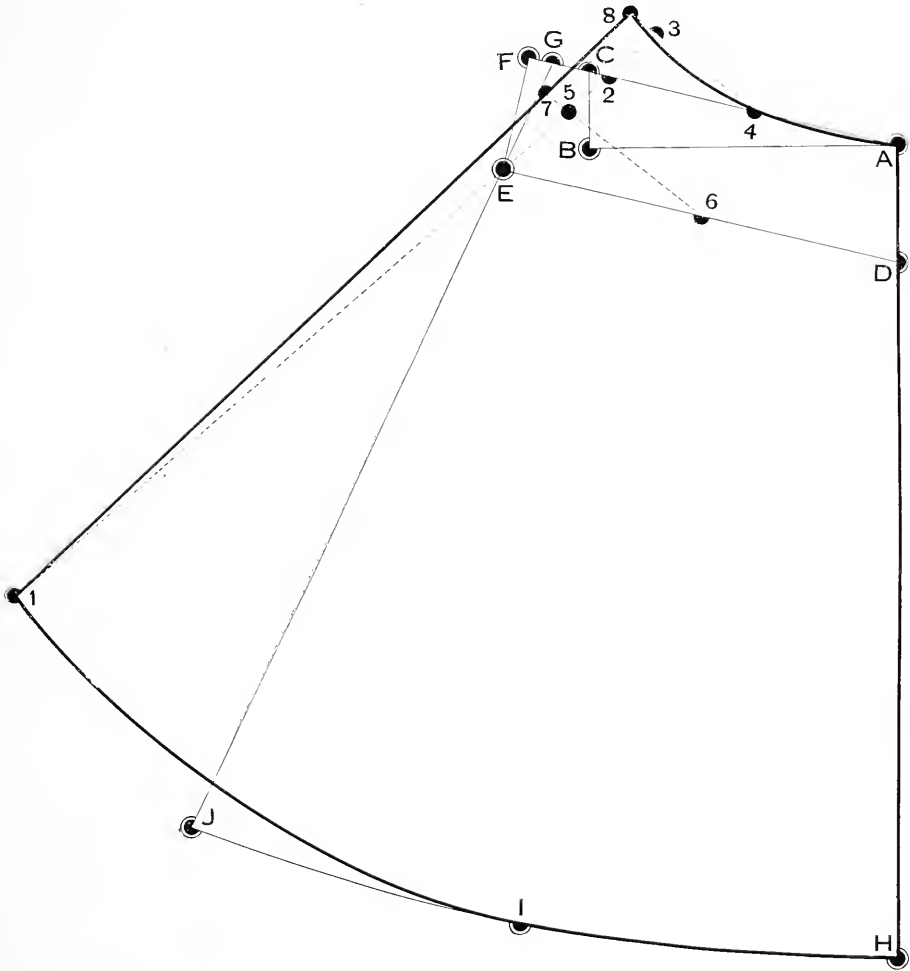

Collars for Juniors' Garments are constructed the same way as for Womens' Garments.

PART FOUR

CHILDRENS' GARMENTS

Measurement for Children are taken in the same way as for Women, Misses and Juniors.

Table of Proportionate Measurements

For Childrens' Sizes

SIZE (AGE)	Normal Sizes					Intermediate Sizes					
	6	8	10	12	14	6	7	8	9	10	
Height	3 Feet 8 in.	4 Feet 1 in.	4 Feet 1 in.	4 Feet 8 in.	5 Feet	3 Feet 10 in.	4 Feet	4 Feet 2 in.	4 Feet 1 in.	4 Feet 6 in.	
Scye depth	5 ¹ / ₄	5 ¹ / ₂	5 ³ / ₄	6	6 ¹ / ₄	5 ³ / ₈	5 ¹ / ₂	5 ⁵ / ₈	5 ³ / ₄	5 ⁷ / ₈	
Back waist length	11	12	13	14	15	11 ¹ / ₂	12	12 ¹ / ₂	13	13 ¹ / ₂	
Breast	26	27 ¹ / ₂	29	30 ¹ / ₂	32	26	26 ³ / ₄	27 ¹ / ₂	28 ¹ / ₄	29	
Waist	24	25	26	27	28	24	24 ¹ / ₂	25	25 ¹ / ₂	26	
Hips	32	33 ¹ / ₂	35	36 ¹ / ₂	38	32	32 ³ / ₄	33 ¹ / ₂	34 ¹ / ₄	35	
Neck	11 ¹ / ₂	12	12 ¹ / ₂	13	13 ¹ / ₂	11 ¹ / ₂	11 ³ / ₄	12	12 ¹ / ₄	12 ¹ / ₂	
Back width	10 ¹ / ₂	11	11 ¹ / ₂	12	12 ¹ / ₂	10 ¹ / ₂	10 ³ / ₄	11	11 ¹ / ₄	11 ¹ / ₂	
Sleeve (Inside seam)	12	13	14	15	16	12 ¹ / ₂	13	13 ¹ / ₂	14	14 ¹ / ₂	
Skirt	Front length	19	21	23	25	27	20	21	22	23	24
	Side length	19	21	23	25	27	20	21	22	23	24
	Back length	19	21	23	25	27	20	21	22	23	24

Systematic Outline

For Childrens' Sizes

Measurement

Breast 29 inches, Waist 26 inches, Hips 35 inches,
Scye depth $5\frac{3}{4}$ inches, Back waist length 13 inches.

To Draft

A. Square both ways from A as represented.
B from A is one third of the full Breast measure, in this case $9\frac{5}{8}$ inches.

C from B is $\frac{1}{2}$ inch.

D from C is the Scye depth measure, in this case $5\frac{3}{4}$ inches. (In lack of the Scye depth measure is D from C $\frac{3}{8}$ inch more than the center of A-C.)

E from D is the back waist length measure, in this case 13 inches.

F From E is 4 inches.

Square out lines from C for the Breast line, from E for the waist line and from F for the Hip line as represented.

G from C is the half Breast measure plus $3\frac{5}{8}$ inches, in this case ($14\frac{1}{2}$ plus $3\frac{5}{8}$) $18\frac{1}{8}$ inches.

H from C is the same as C from A.

I is located by a line squared out from H.

J from I is the same as D from C, in this case $5\frac{3}{4}$ inches.

K from D is one quarter part of line drawn from D to I, in this case $2\frac{3}{4}$ inches.

Draw a line from K to J.

L is the center between C-H.

M from L is $1\frac{3}{4}$ inches.

N is located by a line squared up from M.

O from N is $\frac{1}{2}$ inch.

P is the center between M-N.

Draw a line from O to P.

Q from H is $\frac{1}{2}$ inch more than the center between H-G, in this case $4\frac{1}{2}$ inches.

R is located by a line squared up from Q.

S from R is $\frac{3}{4}$ inch less than D-K, in this case 2 inches.

T from J is 1 inch, and is from S on line drawn from S through T $\frac{3}{8}$ inch longer than line K-D, this $\frac{3}{8}$ inch is to be taken off in corner at point S as represented.

U from H is $1\frac{3}{4}$ inches.

V from U is $1\frac{3}{4}$ inches on line squared out from U.

Draw a line from T to V.

W from S is 2 inches.

X from W is the same as D-K on line squared out from W.

Y from G is $\frac{1}{8}$ inch.

Z is located by drawing a line from X through Y.

NOTICE: In all Diagrams — designed in this Systematic Outline — are $\frac{3}{8}$ inch seams allowed.

Table of Aliquot Parts

Breast Measure	22 $\frac{1}{4}$	23	23 $\frac{3}{4}$	24 $\frac{1}{2}$	25 $\frac{1}{4}$	26	26 $\frac{3}{4}$	27 $\frac{1}{2}$	28 $\frac{1}{4}$	29	30 $\frac{1}{2}$	32
One Half	11 $\frac{1}{8}$	11 $\frac{1}{2}$	11 $\frac{7}{8}$	12 $\frac{1}{4}$	12 $\frac{5}{8}$	13	13 $\frac{3}{8}$	13 $\frac{3}{4}$	14 $\frac{1}{8}$	14 $\frac{1}{2}$	15 $\frac{1}{4}$	16
One Third	7 $\frac{3}{8}$	7 $\frac{5}{8}$	7 $\frac{7}{8}$	8 $\frac{1}{8}$	8 $\frac{3}{8}$	8 $\frac{5}{8}$	8 $\frac{7}{8}$	9 $\frac{1}{8}$	9 $\frac{3}{8}$	9 $\frac{5}{8}$	10 $\frac{1}{8}$	10 $\frac{3}{8}$

Systematic Outline

For Childrens' Sizes

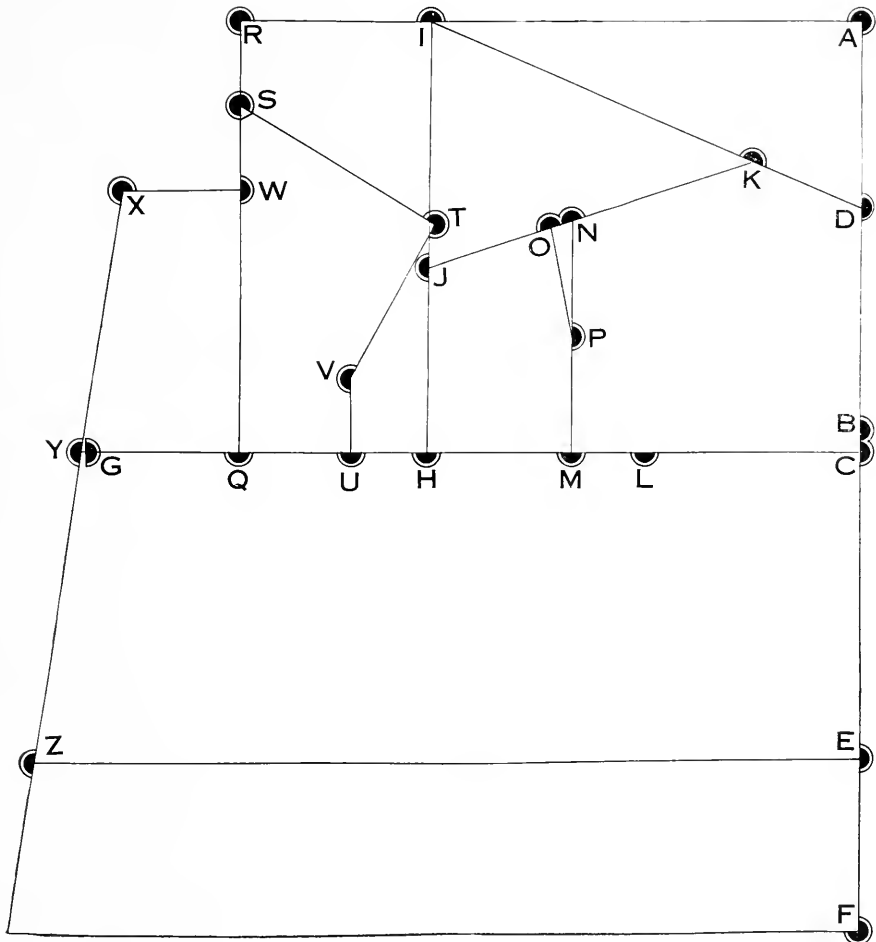

Childrens' Tight-Fitting

First lay up all points as described in Systematic Outline for Childrens' Sizes (page 210), then continue as follows:

- 1 from E is $1\frac{1}{2}$ inches.
- 2 from F is $1\frac{1}{8}$ inches.
- 3 from 1 is $\frac{3}{4}$ inch less than K from D.
- 4 from 2 is $\frac{3}{4}$ inch more than 3 from 1.

Finish the back as represented.

- 5 from 3 is $\frac{1}{2}$ inch.
- 6 from 4 is $\frac{1}{2}$ inch.
- 7 is located by a line squared down from H.
- 8 is located by a line squared down from H.
- 9 is the center between H-L.
- 10 is the center between 5-7.
- 11 is located by a line drawn from 9 through 10.
- 12 from 10 is $\frac{1}{4}$ inch.
- 13 from 11 is $\frac{1}{2}$ inch.
- 14 from 10 is $\frac{1}{4}$ inch.
- 15 from 11 is $\frac{1}{2}$ inch.
- 16 from 8 is $\frac{5}{8}$ inch.
- 17 from P is $\frac{1}{2}$ inch.
- 18 from 9 is $\frac{3}{4}$ inch.

Finish the side gores as represented.

- 19 from 7 is $\frac{1}{2}$ inch.
- 20 from 8 is $\frac{5}{8}$ inch.
- 21 from Q is $2\frac{1}{2}$ inches on line drawn from Q parallel with line X-Z.
- 22 is located by a line drawn from Q through 21.
- 23 is located by a line drawn from Q through 21.
- 24 from 23 is $\frac{1}{8}$ inch.
- 25 from 23 is $\frac{1}{8}$ inch.

Finish the front as represented.

Childrens' Tight-Fitting

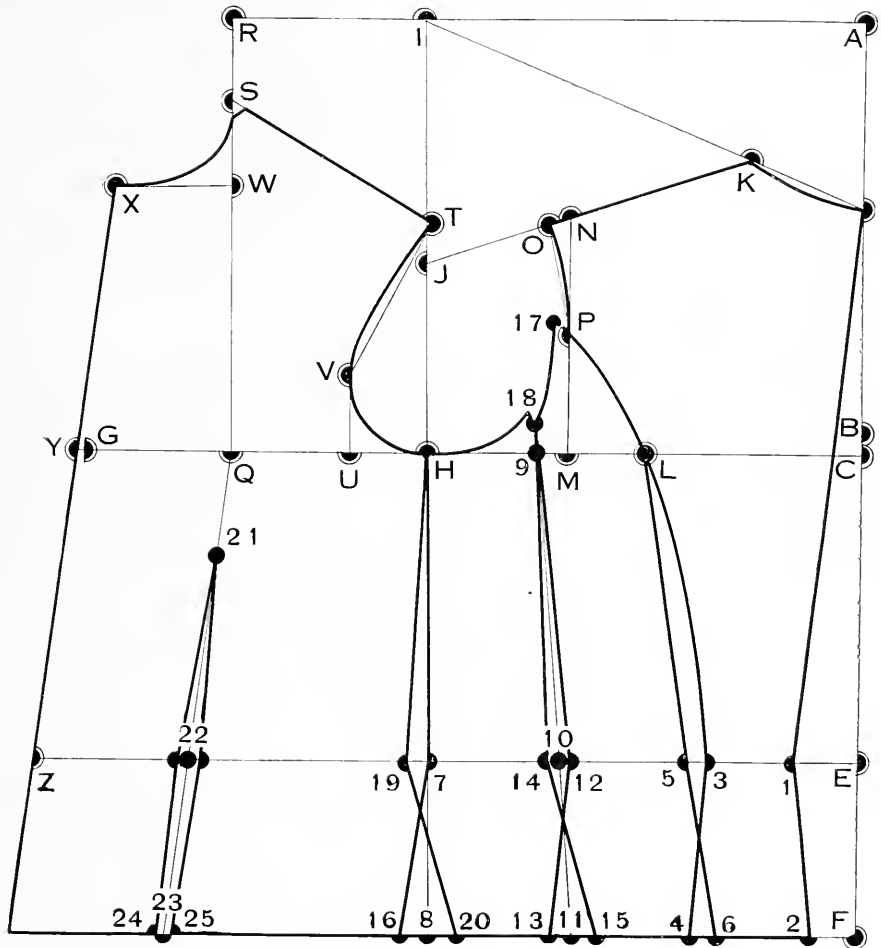

Childrens' Semi-Fitting

First lay up all points as described in Systematic Outline for Childrens' Sizes (page 210), then continue as follows:

1 from E is $1\frac{1}{2}$ inches.

from F is $1\frac{1}{8}$ inches.

3 from 1 is $\frac{1}{4}$ inch more than K from D.

4 from 2 is $\frac{3}{4}$ inch more than 3 from 1.

5 from L is $\frac{3}{4}$ inch.

6 from P is $\frac{3}{4}$ inch.

Finish the back as represented.

7 from 3 is $\frac{1}{2}$ inch.

8 from 4 is $\frac{3}{4}$ inch.

9 from 6 is $\frac{1}{2}$ inch.

10 from H is $\frac{3}{4}$ inch.

11 is located by a line squared down from 10.

12 is located by a line squared down from 10.

13 from 11 is $\frac{3}{8}$ inch.

14 from 12 is 1 inch.

Finish the side gore as represented.

15 from 11 is $\frac{3}{8}$ inch.

16 from 12 is 1 inch.

Finish the front as represented.

Childrens' Semi-Fitting

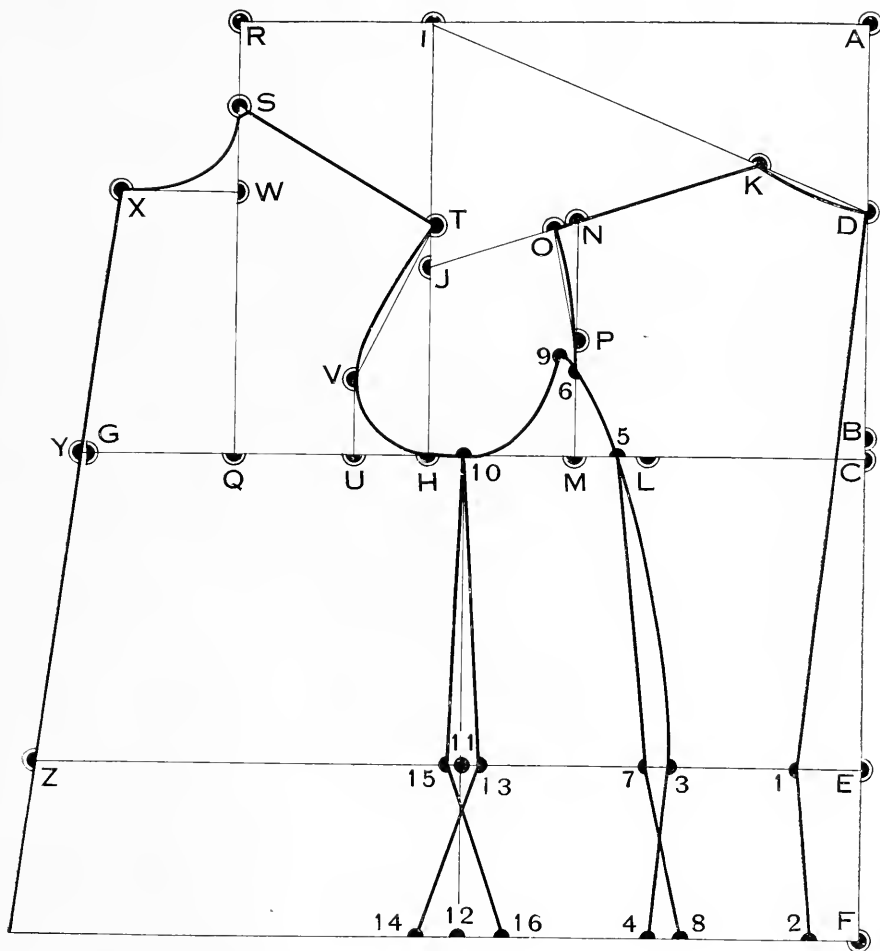

Childrens' Sack Coat

First lay up all points as described in Systematic Outline for Childrens' Sizes (page 210),

then continue as follows:

- 1 from E is $1\frac{1}{2}$ inches.
- 2 from F is $1\frac{1}{8}$ inches.
- 3 from M is $\frac{3}{4}$ inch.
- 4 from 1 is $1\frac{1}{4}$ inches less than M from C.
- 5 from 2 is $\frac{3}{4}$ inch more than 4 from 1.
- 6 from 3 is $\frac{3}{4}$ inch on line drawn from 4 through 3.

Finish the back as represented.

- 7 from 3 is $\frac{3}{4}$ inch.
- 8 from 4 is $\frac{1}{2}$ inch.
- 9 from 5 is $\frac{3}{4}$ inch.
- 10 from 7 is $\frac{3}{4}$ inch on line drawn from 8 through 7.
- 11 from S is $\frac{1}{4}$ inch.
- 12 is located by a line drawn from X through Y.
- 13 from 12 is $\frac{1}{4}$ inch.

For button stand allow $1\frac{1}{2}$ to 2 inches for single breasted, $2\frac{1}{2}$ to $3\frac{1}{2}$ inches for double breasted.

Finish the front as represented.

Childrens' Sack Coat

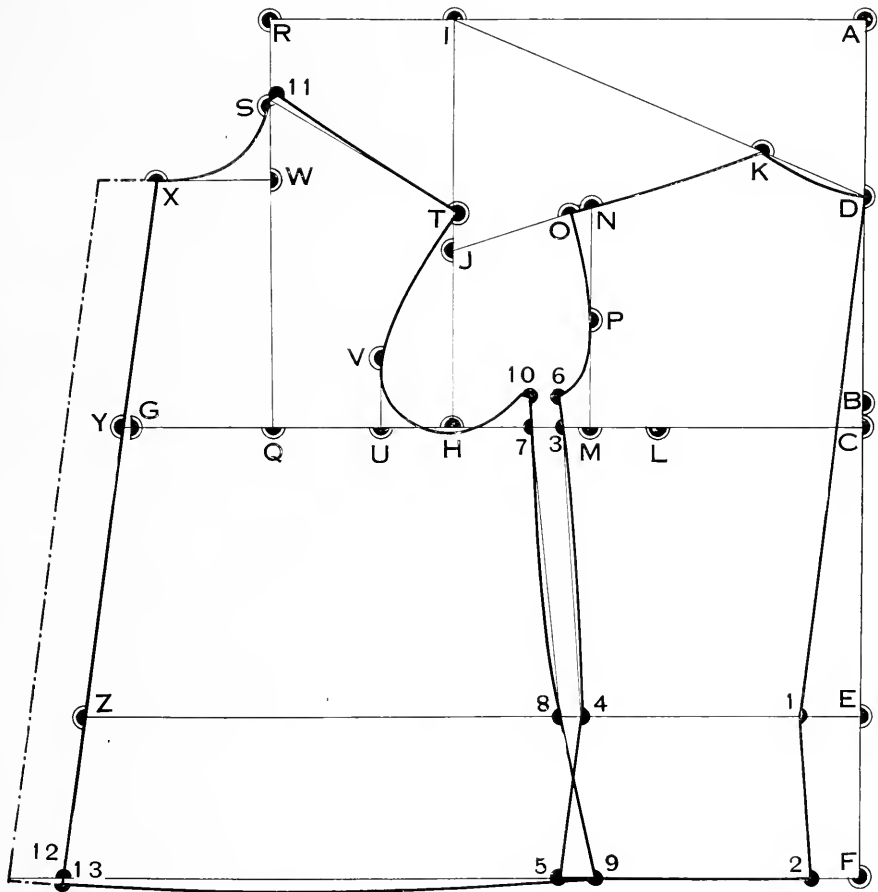

Childrens' Loose Box Coat

First lay up all points as described in Systematic Outline for Childrens' Sizes (page 210).

then continue as follows:

- 1 from E is $\frac{3}{4}$ inch.
- 2 from D is $\frac{1}{2}$ inch.
- 3 from K is $\frac{1}{4}$ inch.
- 4 is the center between H-M.
- 5 from 4 is $\frac{3}{8}$ inch.
- 6 from E is 1 inch more than 5 from C.
- 7 from 4 is $\frac{3}{8}$ inch.
- 8 from 6 is 1 inch.
- 9 from S is $\frac{1}{4}$ inch.
- 10 from D is the full length desired.

Square out line from 10 as represented.

- 11 is located by drawing a line from 5 through 6 and is $\frac{1}{4}$ inch above the bottom line.
- 12 is located by drawing a line from 7 through 8 and is from 7 the same length as 11 from 5.
- 13 is located by a line squared out from 10.
- 14 from 13 is $\frac{1}{4}$ inch.

Allow for button stand $1\frac{1}{2}$ to 2 inches for single breasted and 3 to $3\frac{1}{2}$ inches for double breasted.

Finish the draft as represented.

Childrens' Loose Box Coat

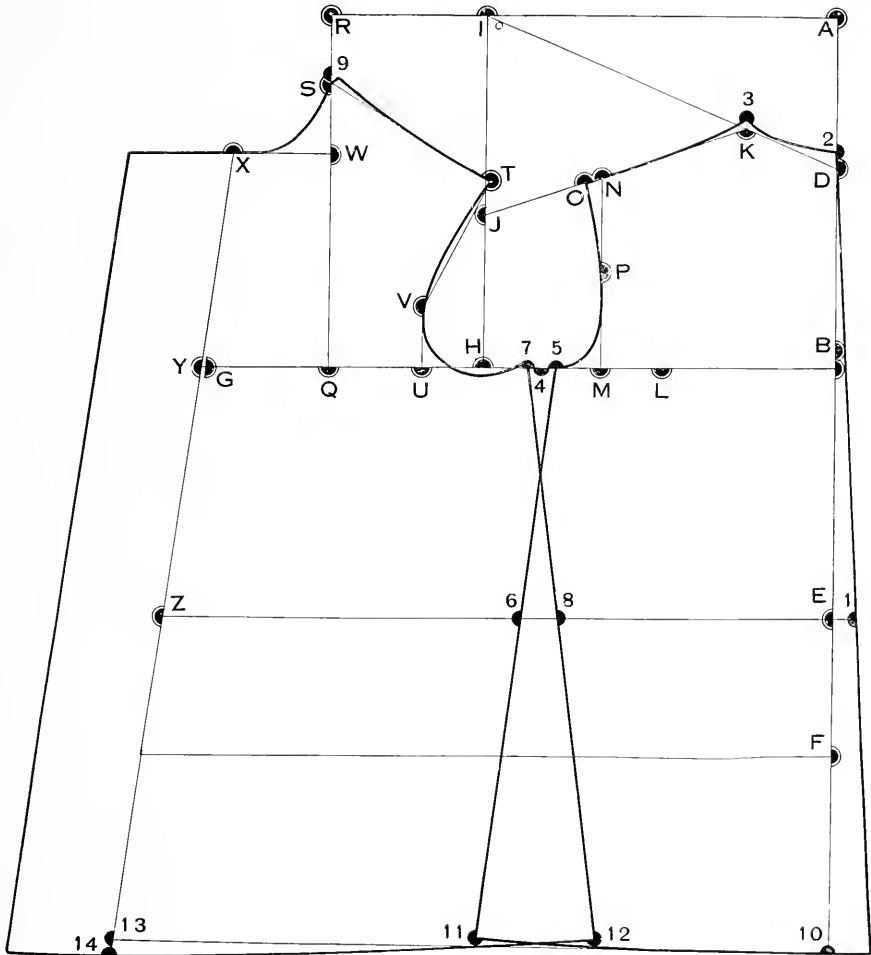

Sleeve Construction for Childrens' Garments

Measurement

Breast 29 inches, Sleeve length 14 inches.

To Draft

- A.** Square both ways from A as represented.
- B** from A is the Sleeve length (inside seam), in this case 14 inches.
- C** from A is one third of the full breast measure plus $\frac{1}{2}$ inch, in this case ($9\frac{5}{8}$ plus $\frac{1}{2}$) $10\frac{1}{8}$ inches.
- D** from B is the same as C from A on line squared up from B.
Draw a line from C to D.
- E** is the center between A - B.
- F** is located by a line squared up from E.
- G** is the center between B - D.
- H** from G is $1\frac{3}{4}$ inches on line squared out from G.
- I** is the center between A - C.
- J** from I is the same as I from A on line squared down from I.
- K** from I is 2 inches.
- L** from A is 2 inches.
Draw lines from L to J and from J through C.
- M** is the center between L - J.
- N** from M is $\frac{3}{4}$ inch.
- O** is the center between J - C.
- P** from O is 1 inch.
- Q** from C is $\frac{1}{2}$ inch on line drawn from J through C.
- R** from F is $1\frac{1}{2}$ inches.
Draw lines between Q - R - D.
- S** from C is $\frac{1}{2}$ inch.
Draw a line from S to R.
- T** from H is 1 inch on line drawn from D through H.
- U** from E is $\frac{3}{4}$ inch.
- V** from H is 1 inch.
- W** from U is $2\frac{3}{4}$ inches.
Draw lines between K - W - V.

Sleeve for Childrens' Garments

First lay up all points to measure as described above, then continue as follows:
Shape the top sleeve as represented by lines between L - N - J - P - C - Q - R - D - T - U - L.
Shape the under sleeve as represented by lines K - S - R - 1 - 2 - W - K.

Sleeve Construction for Children's Garments

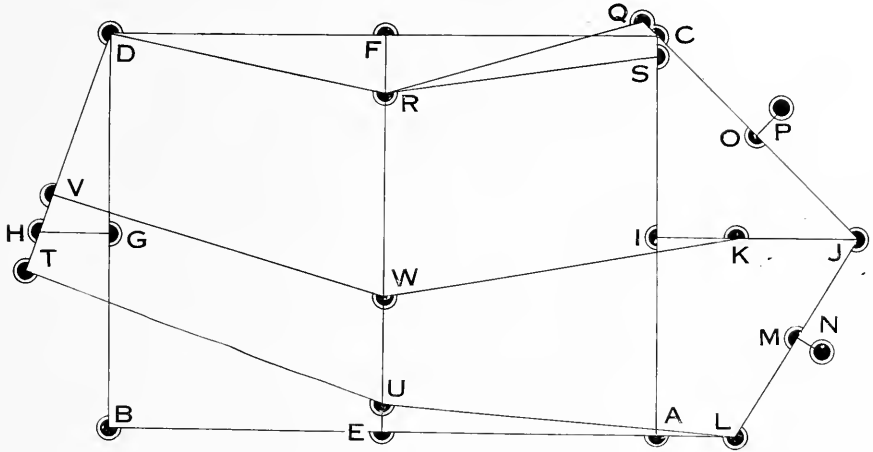

Sleeve for Children's Garments

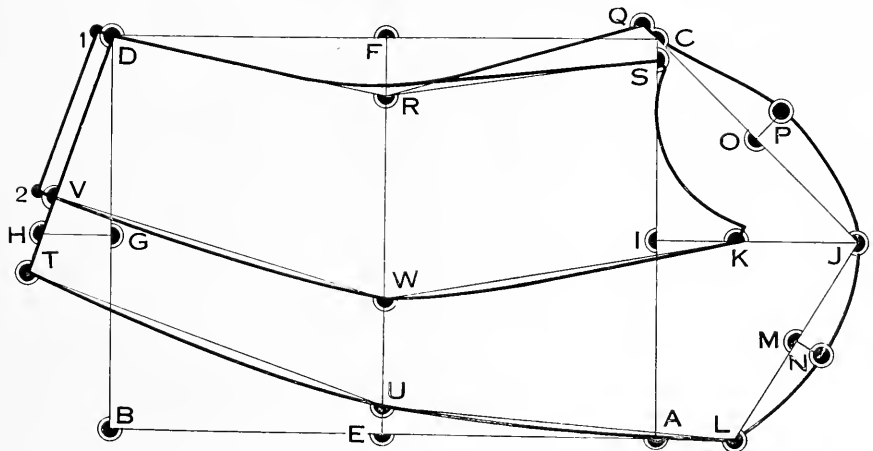

Tight-Fitting Waist Lining

For Childrens' Sizes

First lay up all points to your measure as described in Systematic Outline for Childrens' Sizes, then continue as follows:

- 1 from E is $1\frac{1}{2}$ inches.
- 2 is the center between H-M.
- 3 from 2 is $\frac{3}{4}$ inch.
- 4 from 1 is one quarter of the waist measure less $\frac{3}{4}$ inch. For instance the waist measure is 26 inches; in this case will be point 4 from point 1 ($6\frac{1}{2}$ less $\frac{3}{4}$) $5\frac{3}{4}$ inches.

Finish the back as represented.

- 5 from 2 is $\frac{3}{4}$ inch.
- 6 is located by a line squared down from 5.
- 7 is located by a line drawn from Q parallel with line X-Z.
- 8 from Q is $2\frac{1}{2}$ inches.

Measure up the waist line from 1 to 4 and 6 to Z; deduct from this measure the half actual waist measure plus $2\frac{1}{4}$ inches for seams, and the surplus is to be taken out in dart.

For instance by drafting a size 10 the waist line from 1 to 4 and 6 to Z measures $15\frac{3}{4}$ inches; the half actual waist measure is 13 plus $2\frac{1}{4}$ for seams, will be $15\frac{1}{4}$ inches; surplus is $\frac{1}{2}$ inch, which is to be taken out in dart as follows:

- 9 from 7 is $\frac{1}{4}$ inch.
- 10 from 7 is $\frac{1}{4}$ inch.

Finish the front as represented.

Remember that $\frac{3}{8}$ seams are allowed all over in this draft.

Tight-Fitting Waist Lining

For Childrens' Sizes

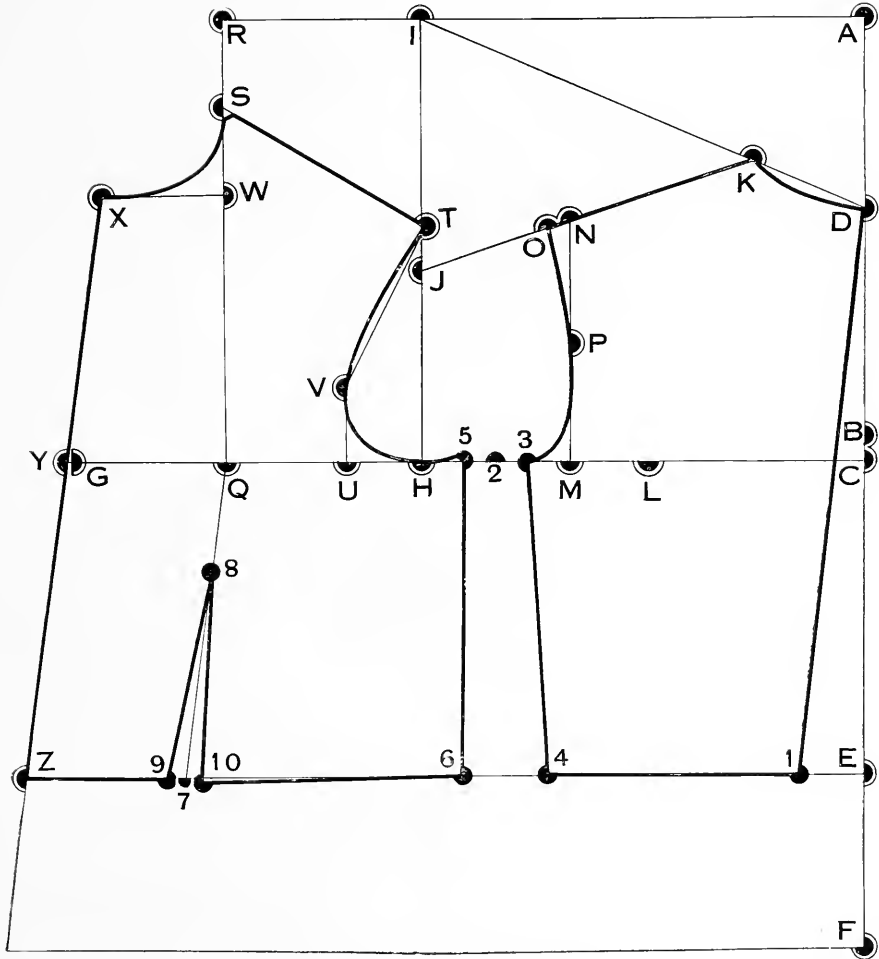

Waist

For Childrens' Sizes

First lay up all points to your measure as described in Systematic Outline (page 210), then continue as follows:

1 from E is $\frac{3}{4}$ inch.

2 from 1 is 1 inch on line drawn from D through 1.

3 is the center between H-M.

4 from 3 is $\frac{1}{2}$ inch.

5 is located by a line squared down from 4.

6 from 5 is 1 inch on line drawn from 4 through 5.

Finish the back as represented.

7 from 3 is $\frac{1}{2}$ inch.

8 is located by a line squared down from 7.

9 from 8 is 1 inch on line drawn from 7 through 8.

10 from Z is $1\frac{1}{4}$ inches.

Draw a line from X through 10.

11 from Z is $1\frac{1}{2}$ inches, more or less accordingly style or taste.

Finish the front as represented.

Waist

For Childrens Sizes

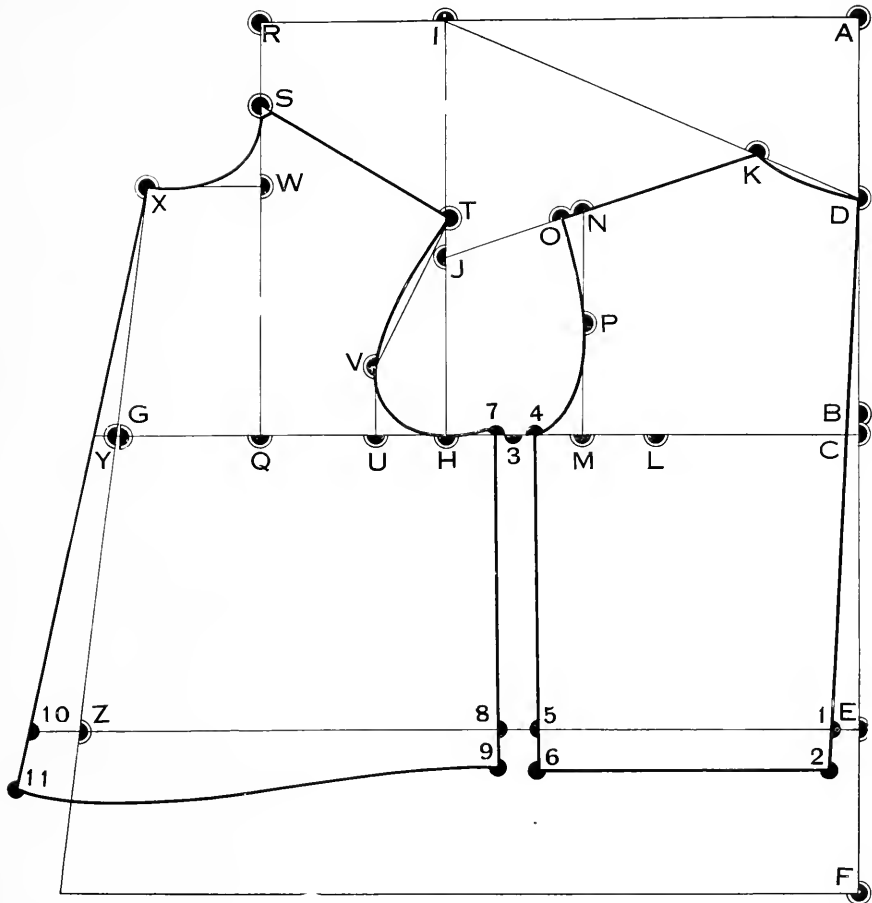

Childrens' Coat Dress

First lay up all points as described in Systematic Outline for Childrens' Sizes (page 210), then continue as follows:

1 from D is the full length desired.

Square out from 1 as represented.

2 is the center between H-M.

3 from 2 is $\frac{3}{4}$ inch.

4 from E is 1 inch more than 3 from C.

5 is located by drawing a line from 3 through 4 and is $\frac{1}{4}$ inch above the line squared out from 1.

Finish the back as represented.

6 from 2 is $\frac{3}{4}$ inch.

7 is located by drawing a line from 6 through 4 and is from 6 the same length as 5 from 3.

8 from Z is $\frac{3}{4}$ inch.

Draw a line from X through 8 for the front center line.

9 is located by drawing a line from X through Y.

10 from 9 is $\frac{3}{8}$ inch.

Finish the front as represented.

Childrens' Coat Dress

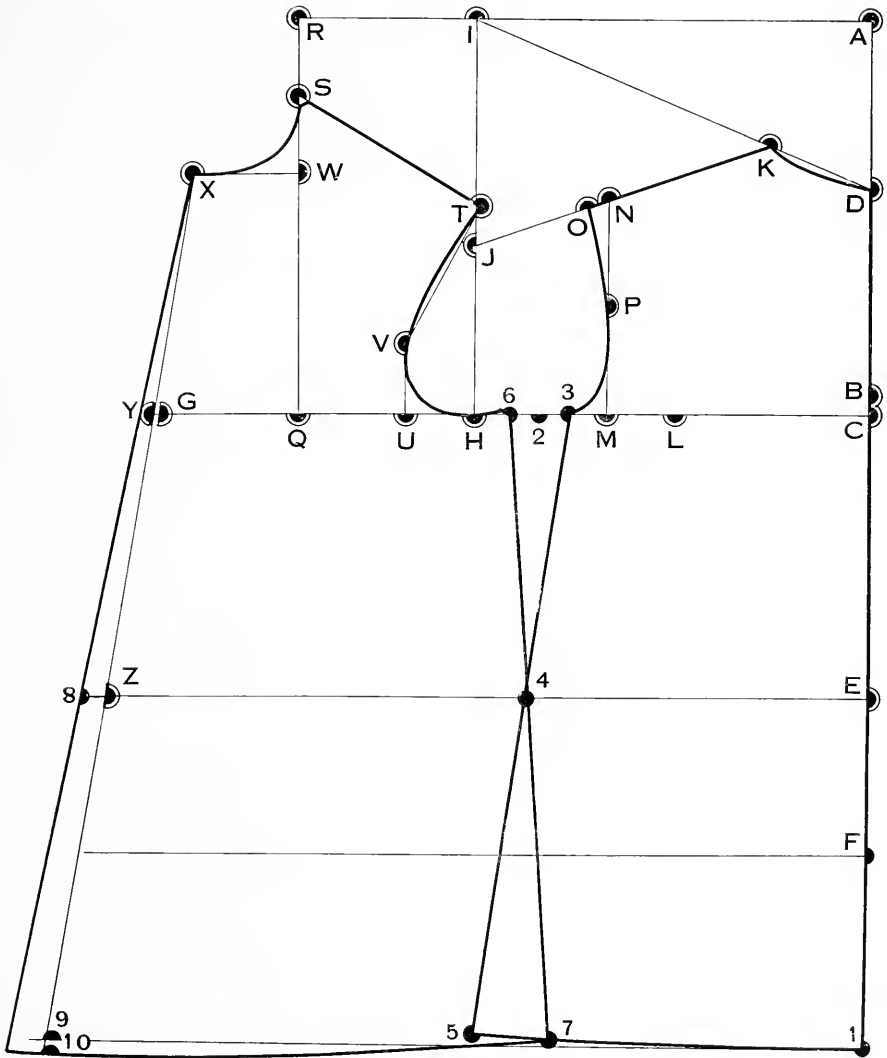

Standing or Military Collar

For Childrens' Sizes

- A. Square both ways from A as represented.
- B from A is the half neck measure plus $\frac{3}{4}$ inch for two seams.
- C is the center of A - B.
- D from A is 3 inches.
- E from B is 3 inches on line squared up from B.
- F is the center of line drawn from D to E.
- G from E is $\frac{3}{4}$ inch.
- H from D is $\frac{3}{4}$ inch.
- I from F is $\frac{3}{4}$ inch.
- J from B is $\frac{3}{4}$ inch.
- K from A is $\frac{3}{4}$ inch.

Shape the collar as represented.

Line I - C is the back center.

High Standing Collar

For Childrens' Sizes

- A. Square both ways from A.
- B from A is the half neck measure plus $\frac{3}{8}$ inch for one seam.
- C from A is 3 inches.
- D from B is 3 inches on line squared up from B.
- E from D is $\frac{3}{4}$ inch.
- F from B is $\frac{3}{4}$ inch.
- G from C is $\frac{3}{4}$ inch.

Fold the paper on line E - F, which is the front center.

Shape the collar as represented.

Standing or Military Collar

For Childrens' Sizes

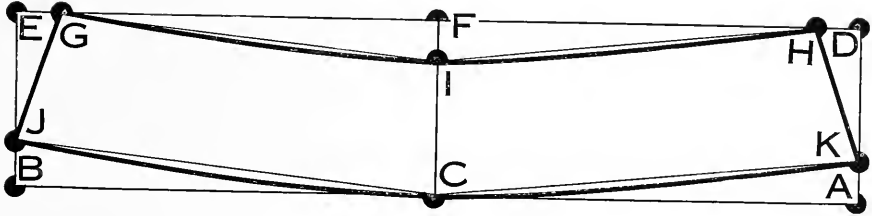

High Standing Collar

For Childrens' Sizes

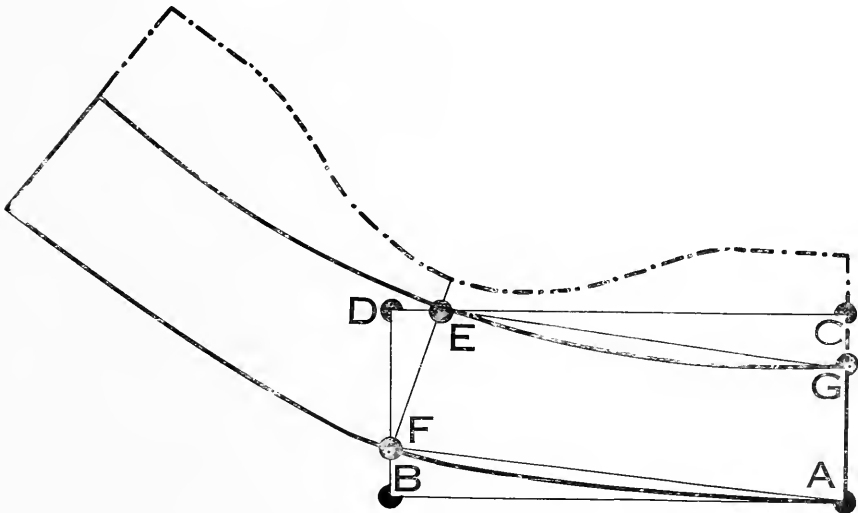

Childrens' One Piece Sleeve

with fulness on the bottom

Place the top- and under sleeves together at the back seam so, that they should overlap $\frac{3}{4}$ inch for taking the seams off, and finish as represented.

Childrens' One Piece Sleeve

with fulness on the top and Cuff

Place the top- and under sleeves together at the back seam so, that they should overlap $\frac{3}{4}$ inch for taking the seams off, and finish the sleeve as represented.

The cuff is represented by heavy, broken lines.

Childrens' One Piece Sleeve
with fulness on the bottom

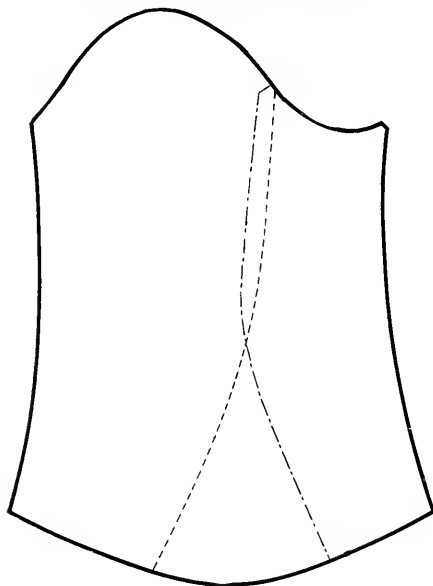

Childrens' One Piece Sleeve
with fulness on the top and Cuff

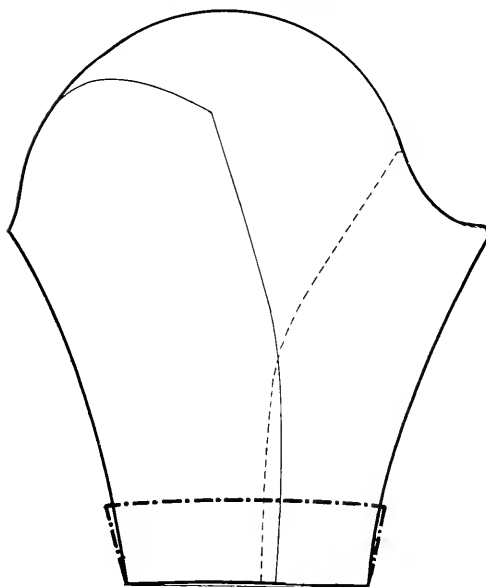

Childrens' One Piece Tight Sleeve

Place the top- and under sleeves together at the back seam so, that they should overlap $\frac{3}{4}$ inch for taking the seams off, then continue as follows :

A-B. Draw a straight line from A to B.

C is the center between A and B.

D from C is the sleeve length measure on line squared down from C.

E from D is the half wrist measure plus $\frac{3}{8}$ inch for a seam on line squared out from D.

F from D is the same as E from D on line drawn from E through D.

Finish the sleeve as represented.

Childrens' One Piece Tight Sleeve

with seam at the middle of the under arm

First make One Piece Tight Sleeve as described above and then continue as follows:

A-B-C-D is the original sleeve.

E-F is about the middle of the under sleeve.

Cut through the sleeve at E-F and place the piece B-C-E-F on the other side of the sleeve so, that B-C should be placed to A-D accordingly notches, and mark over the new sleeve as represented.

By using this kind of a sleeve be careful that the side seam of the garment should correspond with the seam of the sleeve.

Childrens' One Piece Tight Sleeve

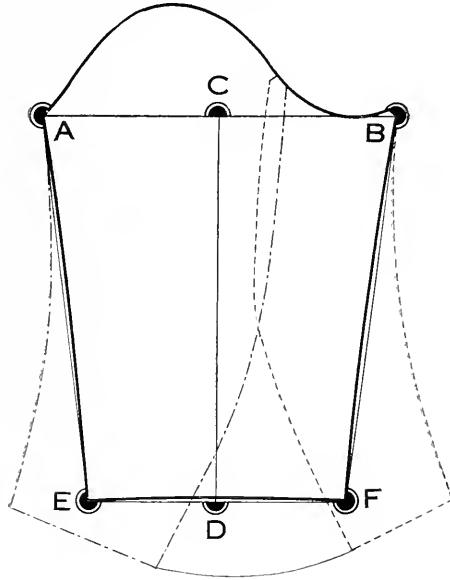

Childrens' One Piece Tight Sleeve with seam at the middle of the under arm

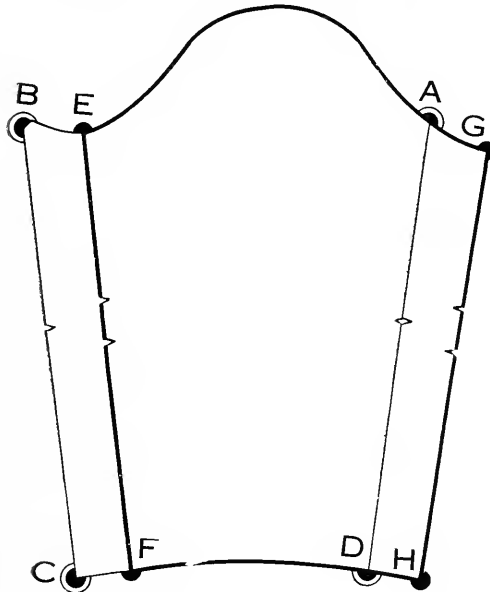

Collars

For Childrens' Sizes

Ulster Collar

Diagram A

- 1-2. Draw a line from 1 through 2 to 3.
 - 3 from 2 is $\frac{3}{4}$ inch more, than the width of the back neck.
 - 4 from 3 is $1\frac{1}{4}$ inches on line squared down from 3.
 - 5 from 1 is $1\frac{1}{4}$ inches on line squared down from 1.
 - Draw a straight line from 5 to 4.
 - Draw a line for the collar stand from 5 through 2 to 3.
 - 6 from 3 is the collar width as desired on line squared out from 3.
 - 7 from 6 is $\frac{3}{4}$ inch for spring.
- Shape the collar as indicated.

Standing or Military Collar

Diagram B

- 1-2. Draw a line from 1 through 2 to 3.
 - 3 from 2 is $\frac{1}{4}$ inch more than the width of the back neck.
 - Square up and down from 3.
 - 4 from 3 is 1 inch.
 - 5 from 3 is 1 inch.
 - 6 from 1 is $1\frac{3}{4}$ inches.
- Shape the collar as represented.

Standing Rolling Ulster Collar

Diagram C

- 1-2. Draw a line from 1 through 2 to 3.
 - 3 from 2 is $\frac{3}{4}$ inch more than the width of the back neck.
 - 4 from 3 is $1\frac{1}{4}$ inches on line squared down from 3.
 - 5 from 1 is $1\frac{1}{4}$ inches.
 - Shape the collar stand from 5 through 2 to 3.
 - 6 from 4 is the width of collar desired on line squared down from 4.
 - 7 from 6 is $\frac{3}{4}$ inch for spring.
- Shape the collar as indicated.
The stand at 5-2-3 is to be stretched.

Standing Rolling Military Collar

Diagram D

- 1-2. Draw a line from 1 through 2 to 3.
- 3 from 2 is $\frac{3}{4}$ inch more than the width of the back neck.
- Square up and down from 3.
- 4 from 3 is 1 inch.
- 5 from 3 is 1 inch.
- 6 from 1 is $1\frac{3}{4}$ inches.
- 7 from 5 is the width of the roll collar as desired.
- 8 from 7 is $\frac{1}{2}$ inch for spring.

- 9 from 6 is the width as desired.

Finish the collar as represented.

The outer leaf of the collar line 9-7-8 must be slightly stretched.

Roll and Button High Collar

Diagram E

- 1 is the shoulder point.
 - 2 from 1 is $1\frac{1}{4}$ inches.
 - 3 is the end of the break of lapel.
 - 4 is located by drawing a line from 3 to 2.
 - Draw a line from 4 through 1 to 5.
 - 5 from 1 is $\frac{3}{4}$ inch more than the width of the back neck.
 - 6 from 5 is $1\frac{1}{4}$ inches on line squared down from 5.
 - 7 from 5 is the width of the collar desired on line squared up from 5.
 - 8 from 7 is $\frac{1}{2}$ inch for spring.
- Finish the collar as represented.

Standing Lay Down Collar

from two pieces

Diagram F

- 1-2-3-4 is the standing collar, which was produced accordingly Diagram B.
 - 5 from 1 is $1\frac{1}{4}$ inches, and is the same length from 2 as 1 from 2.
 - 6 from 2 is the width of the collar desired on line draw from 2 through 3.
 - 7 from 6 is $\frac{1}{2}$ inch for spring.
- Finish the collar as represented.

Storm Collar

Diagram G

For producing this collar take a standing collar and cut it in three pieces.

- 1-2 is the bottom of the standing collar.
- 3-4 is the top of the standing collar.
- 5-6 are located by dividing the bottom of three part.
- 7-8 are produced by dividing the top line of the collar of three parts.

Depart the pieces at points 7 and 8 so far as much fullness you desire and finish the collar as represented.

Allow for seams between the pieces.

Flat Collar

Diagram H

For producing this collar put together the front and back at the shoulder so, that they should overlap $\frac{3}{4}$ inch for taking the seams off, and mark the collar to the shape desired.

Collars

For Childrens' Sizes

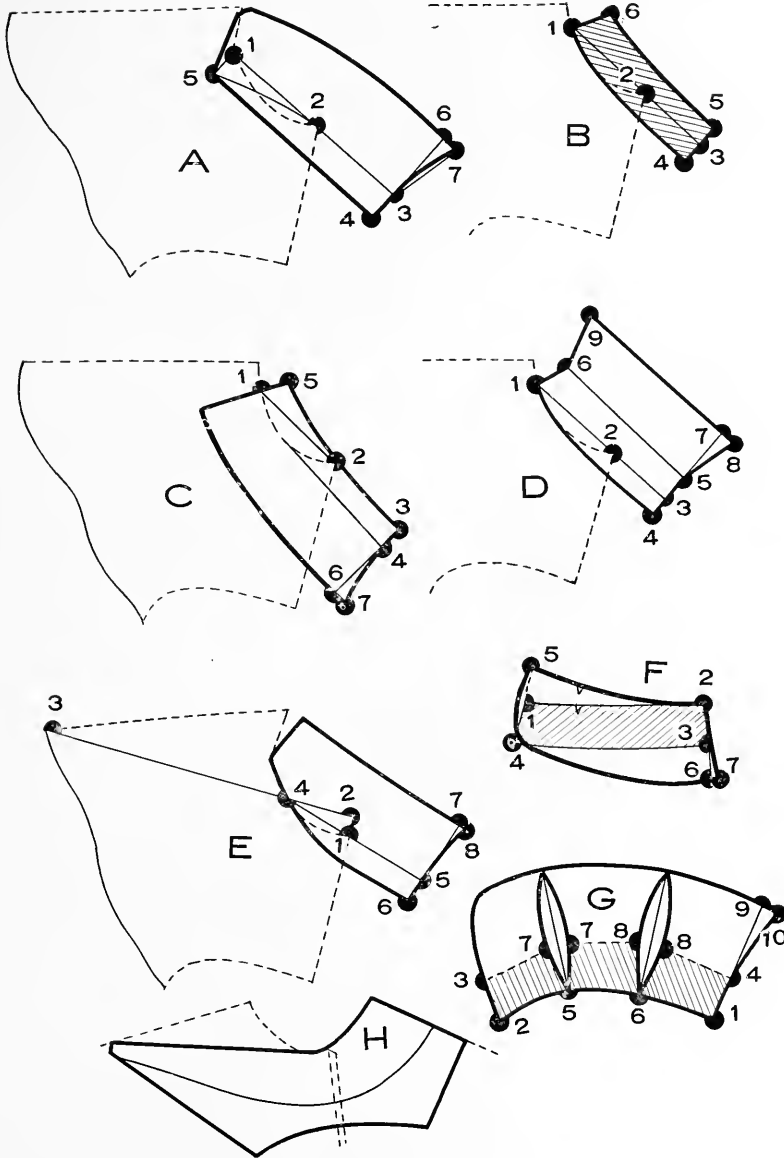

Systematic Outline for Childrens' Skirts

Measurement

Waist 26 inches, Hips 35 inches, Front length 23 inches,
Side length 23 inches, Back length 23 inches.

To Draft

A. Square both ways from A as represented.

B from A is the half waist measure, in this case 13 inches.

C from B is $5\frac{1}{2}$ inches on line squared out from B.

Draw a line from A through C.

D from A is 4 inches.

E from D is the half Hip measure, in this case $17\frac{1}{2}$ inches on line drawn from D parallel with line A-C.

F is located by a line squared out from E.

G from F is $1\frac{1}{4}$ inches.

H is the center between A - G.

I from H is $\frac{1}{2}$ inch.

Finish the waist line A-I-G as represented.

J from A is the front length measure, in this case 23 inches.

K from I is the side length measure, in this case 23 inches.

L from G is the back length measure, in this case 23 inches on line drawn from G through E.

Finish the draft as represented.

Systematic Outline for Childrens' Skirts

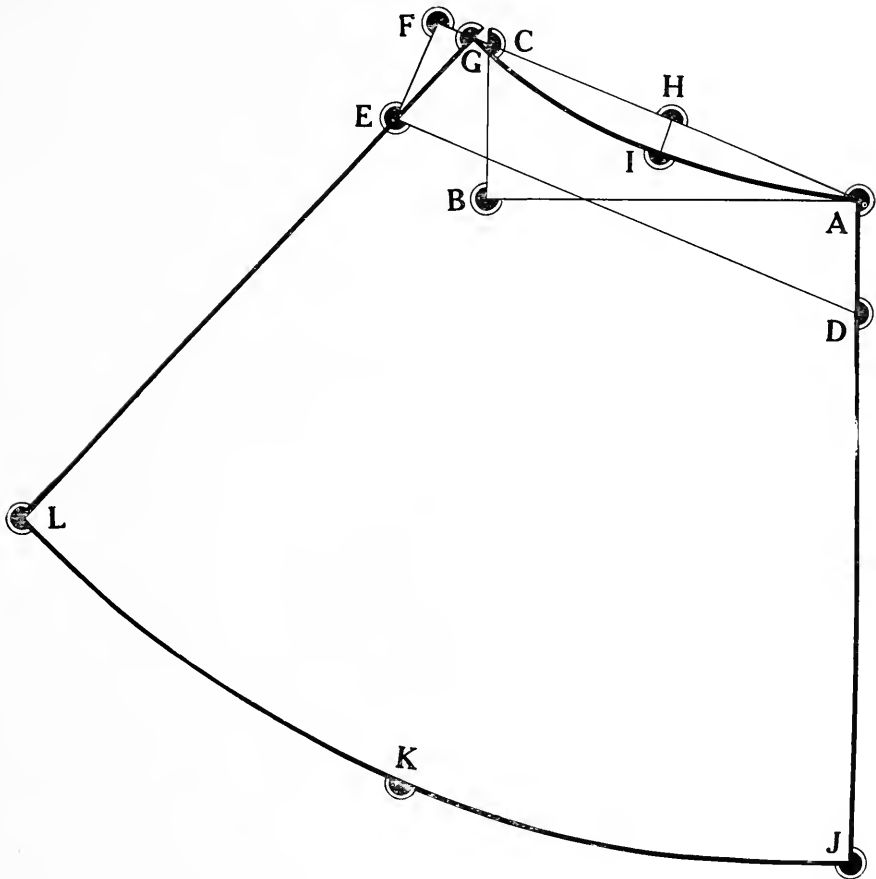

Childrens' Five Gore Skirt

First lay up all points as described in Systematic Outline for Childrens' Skirts (page 236), then continue as follows:

1 from A is 3 inches.

2 is the center between 1-G.

3 from J is $5\frac{1}{2}$ inches (twice as much as 1 from A less $\frac{1}{2}$ inch).

4 is the center between 3-L.

Draw lines between 1-3 and 2-4.

Measure up the waist line from A to G and the difference between this measure and the half actual waist measure is to be taken out in darts as represented.

Childrens' Five Gore Skirt

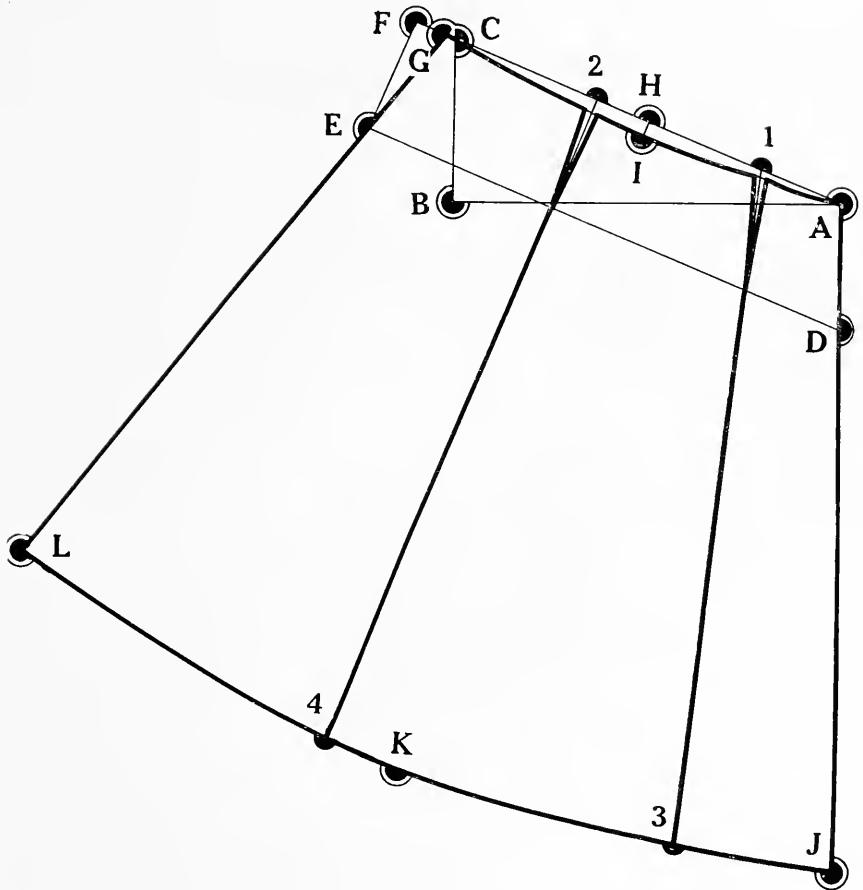

Remember that by Childrens the Breast measure increases and decreases from size to size $1\frac{1}{2}$ inches, during by Ladies, Misses and Juniors 2 inches.

PART FIVE

INFANTS' GARMENTS

Collars for Infants' Garments are Constructed the same way
as for Childrens' Garments.

Table of Proportionate Measurements

For Infants' Sizes

SIZE (AGE)		1	2	3	4	5	6
Height		2 Feet 10 in.	3 Feet —	3 Feet 2 in.	3 Feet 4 in.	3 Feet 6 in.	3 Feet 8 in.
Scye depth		4 ⁵ / ₈	4 ³ / ₄	4 ⁷ / ₈	5	5 ¹ / ₈	5 ¹ / ₄
Back waist length		8 ¹ / ₂	9	9 ¹ / ₂	10	10 ¹ / ₂	11
Bust		22 ¹ / ₄	23	23 ³ / ₄	24 ¹ / ₂	25 ¹ / ₄	26
Waist		21 ¹ / ₂	22	22 ¹ / ₂	23	23 ¹ / ₂	24
Hips		28 ¹ / ₄	29	29 ³ / ₄	30 ¹ / ₂	31 ¹ / ₄	32
Neck		10 ¹ / ₄	10 ¹ / ₂	10 ³ / ₄	11	11 ¹ / ₄	11 ¹ / ₂
Back width		9 ¹ / ₄	9 ¹ / ₂	9 ³ / ₄	10	10 ¹ / ₄	10 ¹ / ₂
Sleeve length (Inside seam)		8 ¹ / ₂	9	9 ¹ / ₂	10	10 ¹ / ₂	11
S L E E V E	Front length	16 ¹ / ₂	17	17 ¹ / ₂	18	18 ¹ / ₂	19
	Side length	16 ¹ / ₂	17	17 ¹ / ₂	18	18 ¹ / ₂	19
	Back length	16 ¹ / ₂	17	17 ¹ / ₂	18	18 ¹ / ₂	19

Systematic Outline

For Infants' Sizes

Measurement

Breast $24\frac{1}{2}$ inches, Waist 23 inches, Hips $30\frac{1}{2}$ inches,
Scye depth 5 inches, Back waist length 10 inches.

To Draft

A Square both ways from A as represented.

B from A is one third of the full Breast measure, in this case $8\frac{1}{8}$ inches.

C from B is $\frac{1}{2}$ inch.

D from C is the Scye depth measure, in this case 5 inches. (In lack of the Scye depth measure is D from C $\frac{5}{8}$ inch more than the center of A-C.)

E from D is the back waist length measure, in this case 10 inches.

F From E is 4 inches.

Square out lines from C for the Breast line, from E for the waist line and from F for the Hip line as represented.

G from C is the half Breast measure plus $3\frac{5}{8}$ inches, in this case ($12\frac{1}{4}$ plus $3\frac{5}{8}$) $15\frac{7}{8}$ inches.

H from C is the same as C from A.

I is located by a line squared out from H.

J from I is the same as D from C.

K from D is one quarter part of line drawn from D to I.

Draw a line from K to J.

L is the center between C-H.

M from L is $1\frac{3}{4}$ inches.

N is located by a line squared up from M.

O from N is $\frac{1}{2}$ inch.

P is the center between M-N.

Draw a line from O to P.

Q from H is $\frac{1}{2}$ inch more than the center between H-G.

R is located by a line squared up from Q.

S from R is $\frac{3}{4}$ inch less than D-K.

T from J is 1 inch, and is from S on line drawn from S through T $\frac{3}{8}$ inch longer than line K-D, this $\frac{3}{8}$ inch is to be taken off in corner at point S as represented.

U from H is $1\frac{3}{4}$ inches.

V from U is $1\frac{3}{4}$ inches on line squared out from U.

Draw a line from T to V.

W from S is 2 inches.

X from W is the same as D-K on line squared out from W.

Y from G is $1\frac{1}{8}$ inch.

Z is located by drawing a line from X through Y.

NOTICE: In all Diagrams — designed in this Systematic Outline — are $\frac{3}{8}$ inch seams allowed.

Table of Aliquot Parts

Breast Measure	$22\frac{1}{4}$	23	$23\frac{3}{4}$	$24\frac{1}{2}$	$25\frac{1}{4}$	26	$26\frac{3}{4}$	$27\frac{1}{2}$	$28\frac{1}{4}$	29	$30\frac{1}{2}$	32
One Half	$11\frac{1}{8}$	$11\frac{1}{2}$	$11\frac{7}{8}$	$12\frac{1}{4}$	$12\frac{5}{8}$	13	$13\frac{3}{8}$	$13\frac{3}{4}$	$14\frac{1}{8}$	$14\frac{1}{2}$	$15\frac{1}{4}$	16
One Third	$7\frac{3}{8}$	$7\frac{5}{8}$	$7\frac{7}{8}$	$8\frac{1}{8}$	$8\frac{3}{8}$	$8\frac{5}{8}$	$8\frac{7}{8}$	$9\frac{1}{8}$	$9\frac{3}{8}$	$9\frac{5}{8}$	$10\frac{1}{8}$	$10\frac{5}{8}$

Systematic Outline

For Infants' Sizes

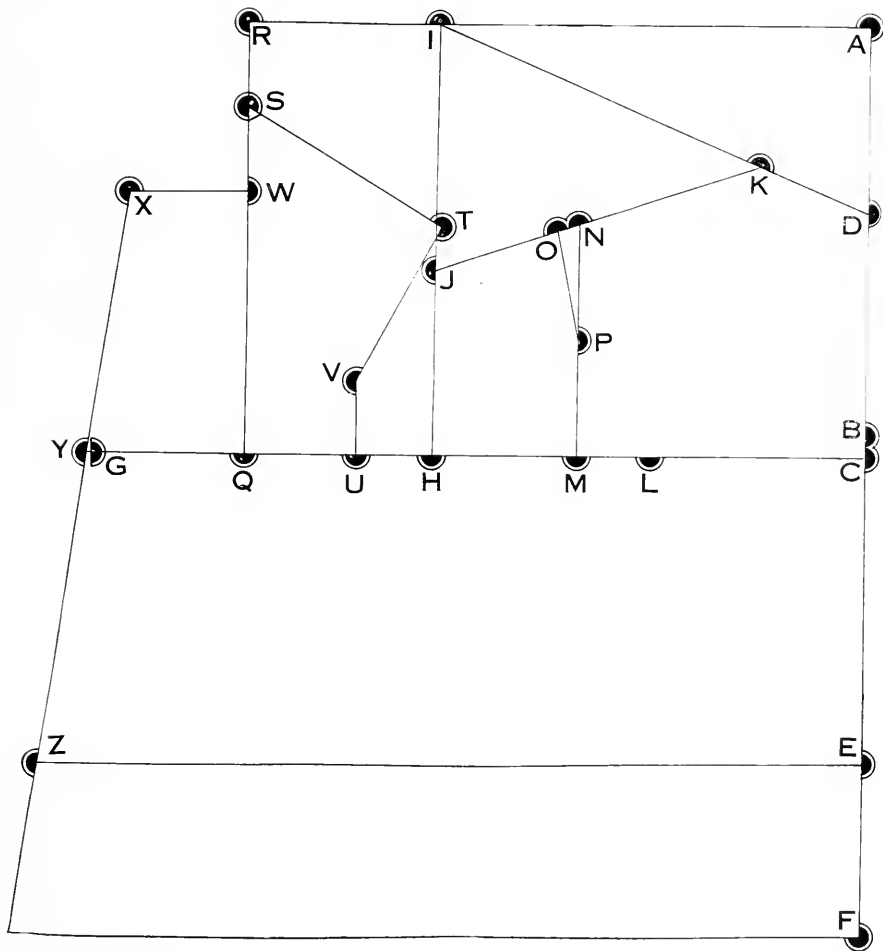

Infants' Loose Box Coat

First lay up all points as described in Systematic Outline for Infants' Sizes (page 244), then continue as follows:

- 1 from E is $\frac{3}{4}$ inch.
- 2 from D is $\frac{1}{2}$ inch.
- 3 from K is $\frac{1}{4}$ inch.
- 4 is the center between H-M.
- 5 from 4 is $\frac{3}{8}$ inch.
- 6 from E is 1 inch more than 5 from C.
- 7 from 4 is $\frac{3}{8}$ inch.
- 8 from 6 is 1 inch.
- 9 from S is $\frac{1}{4}$ inch.
- 10 from D is the full length desired.

Square out line from 10 as represented.

- 11 is located by drawing a line from 5 through 6 and is $\frac{1}{4}$ inch above the bottom line.
- 12 is located by drawing a line from 7 through 8 and is from 7 the same length as 11 from 5.
- 13 is located by a line squared out from 10.
- 14 from 13 is $\frac{1}{4}$ inch.

Allow for button stand $1\frac{1}{2}$ to 2 inches for single breasted and 3 to $3\frac{1}{2}$ inches for double breasted.

Finish the draft as represented.

Infants' Loose Box Coat

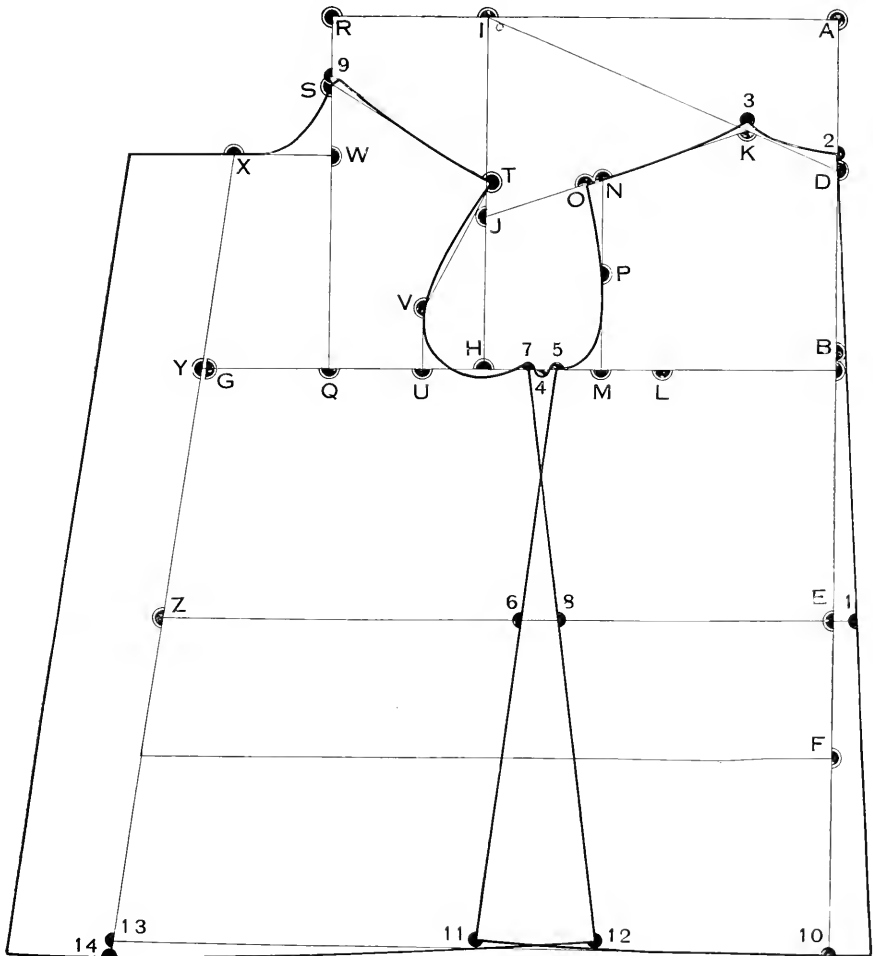

Sleeve Construction for Infants' Garments

Measurement

Breast $24\frac{1}{2}$ inches, Sleeve length 11 inches.

To Draft

A. Square both ways from A as represented.

B from A is the Sleeve length (inside seam), in this case 11 inches.

C from A is one third of the full breast measure plus $\frac{1}{2}$ inch, in this case $(8\frac{1}{8}$ plus $\frac{1}{2}$) $8\frac{5}{8}$ inches.

D from B is the same as C from A on line squared up from B.

Draw a line from C to D.

E is the center between A - B.

F is located by a line squared up from E.

G is the center between B - D.

H from G is $1\frac{3}{4}$ inches on line squared out from G.

I is the center between A - C.

J from I is the same as I from A on line squared down from I.

K from I is 2 inches.

L from A is 2 inches.

Draw lines from L to J and from J through C.

M is the center between L - J.

N from M is $\frac{3}{4}$ inch.

O is the center between J - C.

P from O is 1 inch.

Q from C is $\frac{1}{2}$ inch on line drawn from J through C.

R from F is $1\frac{1}{2}$ inches.

Draw lines between Q - R - D.

S from C is $\frac{1}{2}$ inch.

Draw a line from S to R.

T from H is 1 inch on line drawn from D through H.

U from E is $\frac{3}{4}$ inch.

V from H is 1 inch.

W from U is $2\frac{3}{4}$ inches.

Draw lines between K - W - V.

Sleeve for Infants' Garments

First lay ap all points to measure as described above, then continue as follows:

Shape the top sleeve as represented by lines between L - N - J - P - C - Q - R - D - T - U - L.

Shape the under sleeve as represented by lines K - S - R - 1 - 2 - W - K.

Sleeve Construction for Infants' Garments

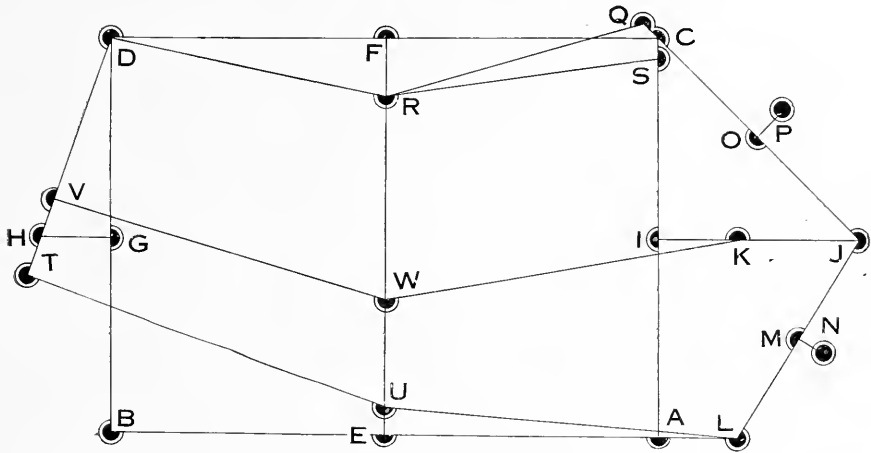

Sleeve for Infants' Garments

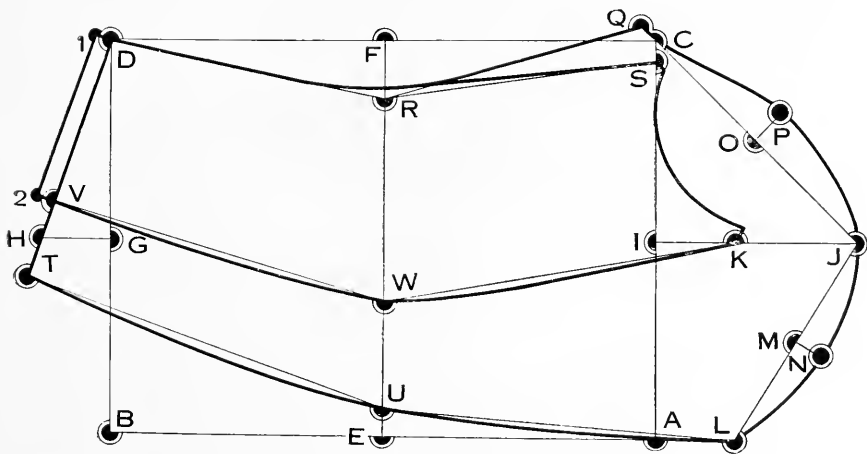

Infants' Coat Dress

First lay up all points as described in Systematic Outline for Infants' Garments (page 244), then continue as follows:

1 from D is the full length desired.

Square out from 1 as represented.

2 is the center between H-M.

3 from 2 is $\frac{3}{4}$ inch.

4 from E is 1 inch more than 3 from C.

5 is located by drawing a line from 3 through 4 and is $\frac{1}{4}$ inch above the line squared out from 1.

Finish the back as represented.

6 from 2 is $\frac{3}{4}$ inch.

7 is located by drawing a line from 6 through 4 and is from 6 the same length as 5 from 3.

8 from Z is $\frac{3}{4}$ inch.

Draw a line from X through 8 for the front center line.

9 is located by drawing a line from X through Y.

10 from 9 is $\frac{3}{8}$ inch.

Finish the front as represented.

Infants' Coat Dress

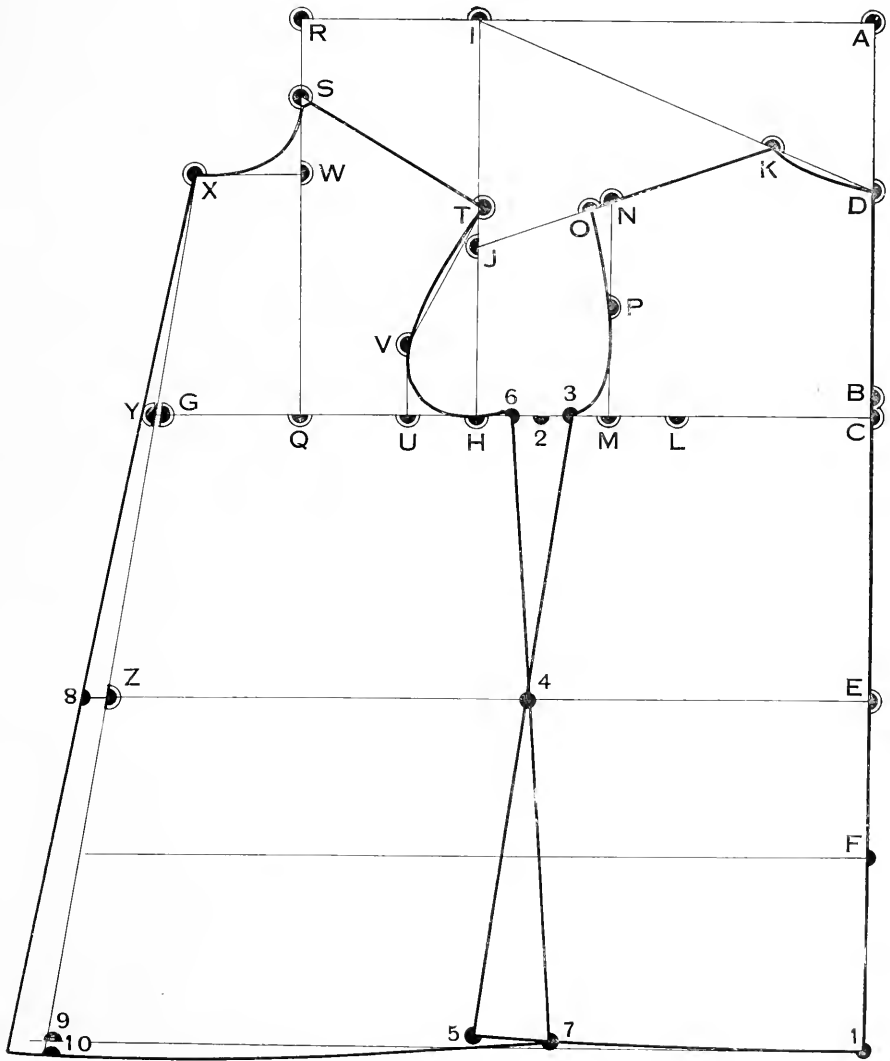

Infants' One Piece Sleeve

with fulness on the bottom

Place the top- and under sleeves together at the back seam so, that they should overlap $\frac{3}{4}$ inch for taking the seams off, and finish as represented.

Infants' One Piece Sleeve

with fulness on the top and Cuff

Place the top- and under sleeves together at the back seam so, that they should overlap $\frac{3}{4}$ inch for taking the seams off, and finish the sleeve as represented.

The cuff is represented by heavy, broken lines.

Infants' One Piece Sleeve
with fulness on the bottom

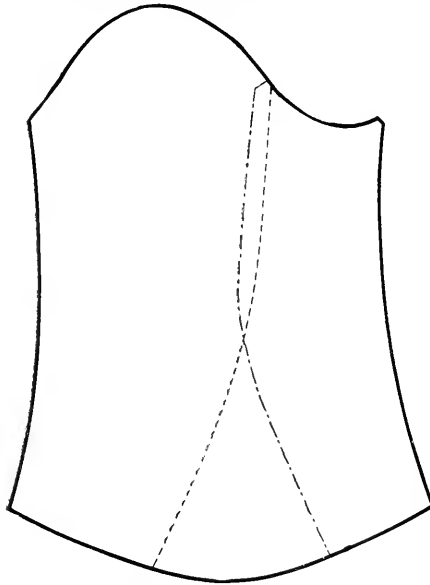

Infants' One Piece Sleeve
with fulness on the top and Cuff

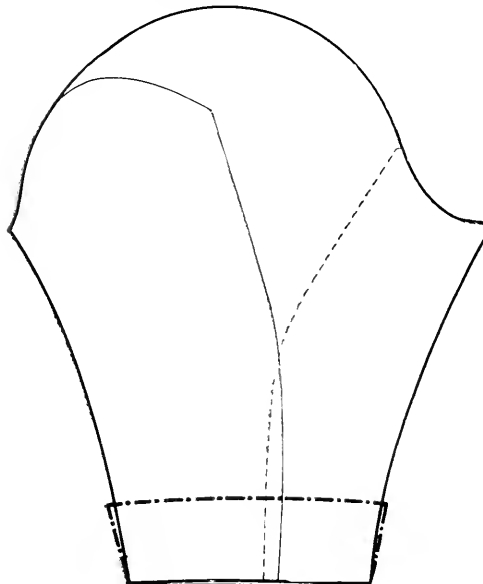

Infants' Yoke

To produce a Yoke lay the back and front together at the shoulder so, that they should overlap $\frac{3}{4}$ inch for figuring the seams off, and finish the Yoke as represented.

Infants' Shield

To Produce a Shield lay the back and front together at the shonlder so, that they should overlap $\frac{3}{4}$ inch for figuring the seams off, and finish the Shield as represented.

Infants' Yoke

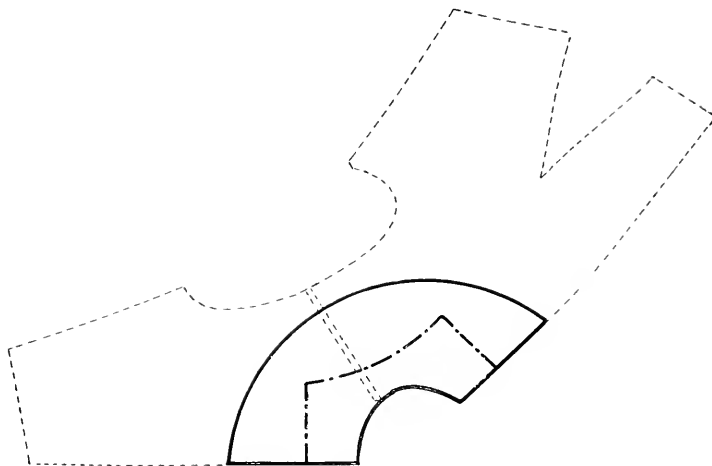

Infants' Shield

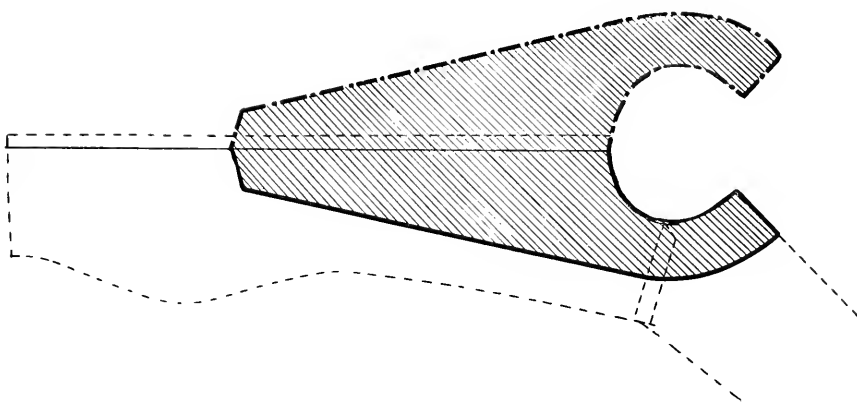

Hood

The hood is constructed from a cape as follows:

A-B is 10 inches, more or less accordingly style or taste.

C from **B** is 1 inch less than **A-B**, in this case say 9 inches.

D from **C** is one-third of the length of line **B-C**, in this case say 3 inches.

E from **D** is 1 inch.

Finish the hood as represented.

Hood

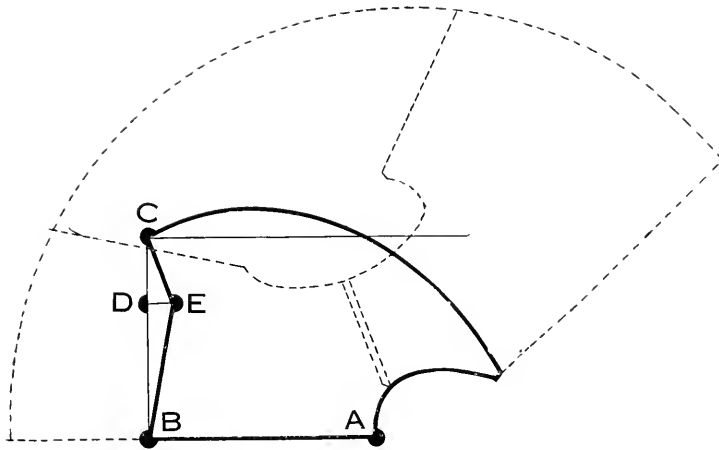

Collars for Infants' Garments are constructed the same way as for Childrens' Garments.

PART SIX

GRADING

Art of Grading

Graduation may be described as the art of grading a number of different sized garments from a single model, and in ladies' garment cutting it is frequently a great assistance to the grader.

This, indeed, the production of pattern sets, is the most practical use to which the system of grading lends itself.

Assuming that a single pattern has been so corrected by alterations as to produce a correct fit combined with a perfection of style, it naturally follows that the cutter is anxious to produce a complete set of patterns embodying the same excellencies.

By no other plan of working can such a desirable result be arrived at more expeditiously than through grading.

But to attain success the grader must have at his command a logical and truly scientific method of working. It must be exact, practical and comprehensive in minute detail.

In wholesale manufacturing every garment is made up in different sizes.

The medium size is for:

Ladies' Garments	36 Bust
Misses'	" 16 Years
Juniors'	" 15 "

Childrens' Garments	10 Years
Infants'	" 4 "

Whatever shape or style of garment it may be—tight fitting, semi-fitting or loose—no matter how many pieces the pattern is cut into, the grading is the same as diagrams will show under this heading.

Revers, shapes, lapels, scallops, tabs, gathers, plaits, folds, tucks, etc. are never graded; regarding this use your own judgment.

In the diagrams the inside lines show how to grade a smaller size and the outside lines show to grade a larger size.

The sizes are in:

Ladies' Garments	from	32	to	44
Misses'	"	"	14	" 20
Juniors'	"	"	13	" 19
Childrens'	"	"	6	" 14
Infants'	"	"	2	" 6

The amount which is taken off for smaller size or added to for larger size is from size to size, for instance from 36 to 38 or vice-versa.

If you wish to grade for 2 sizes larger or smaller, for instance from 36 to 40 than you have to add to, resp. to take off the double amount as marked on diagrams.

Scale of Regular Stock Patterns

Showing how many inches the garment increases and decreases in proportion from size to size.

Measures	Ladies'	Misses' and Juniors'	Childrens' and Infants'
Around Bust	2	2	1½
Around Waist	1¾	1½	1
Around Hips	2	2	1½
Scye depth	The same	⅛	¼
Waist length	The same	½	1
Across Back	½	½	½
Across Chest	½	½	½
Aroudd Neck	½	½	½
Front Length	⅛	⅝	1
Underarm length	The same*	½	¾
Length of Shoulder	⅛	⅛	⅛
Hight of Shoulder	¼	¼	½
Sleeve length	The same	Mis. ½ Jun. 1	1
Around Muscle of Arm	½	½	½
Around Elbow	½	½	½
Around Wrist or Cuff	⅜	⅜	⅜
Armhole	¾†	¾	¾
Length of Entire Body	1	Mis. 2 Jun. 3	4

*Underarm-Length from size 40 up ¼ inch shorter at the armhole.

†Armhole from size 40 up ¼ inch lower.

Grading of Ladies' Tighth-Fitting with dart

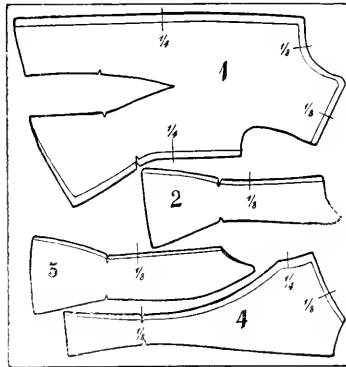

Increases and Decreases for Each Size	Across Bust	Across Waist	Across Chest	Across Back	Height of Shoulder	Length of Shoulder	Neck Curve	Armhole
1. Front	$\frac{1}{2}$	$\frac{1}{2}$	$\frac{1}{4}$		$\frac{1}{2}$	$\frac{1}{2}$	$\frac{1}{2}$	$\frac{2}{2}$
2. Front Side	$\frac{1}{2}$	$\frac{1}{2}$						$\frac{1}{2}$
3. Back Side	$\frac{1}{2}$	$\frac{1}{2}$						$\frac{1}{2}$
4. Back	$\frac{1}{4}$	$\frac{1}{2}$		$\frac{1}{4}$	$\frac{1}{2}$	$\frac{1}{2}$	$\frac{1}{2}$	$\frac{1}{2}$
Total	1	$\frac{2}{2}$	$\frac{1}{4}$	$\frac{1}{4}$	$\frac{1}{4}$	$\frac{1}{2}$	$\frac{1}{4}$	$\frac{3}{4}$

Grading of Ladies' Semi-Fitting with Side Piece

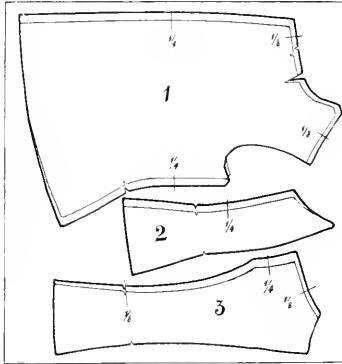

Increases and Decreases for Each Size	Across Bust	Across Waist	Across Chest	Across Back	Height of Shoulder	Length of Shoulder	Neck Curve	Armhole
1. Front	$\frac{1}{2}$	$\frac{1}{2}$	$\frac{1}{4}$		$\frac{1}{2}$	$\frac{1}{2}$	$\frac{1}{2}$	$\frac{3}{4}$
2. Side Piece	$\frac{1}{4}$	$\frac{1}{4}$						$\frac{1}{2}$
3. Back	$\frac{1}{4}$	$\frac{1}{2}$		$\frac{1}{4}$	$\frac{1}{2}$	$\frac{1}{2}$	$\frac{1}{2}$	$\frac{1}{4}$
Total	1	$\frac{7}{2}$	$\frac{1}{4}$	$\frac{1}{4}$	$\frac{1}{4}$	$\frac{1}{2}$	$\frac{1}{4}$	$\frac{3}{4}$

Grading of Ladies' Eton

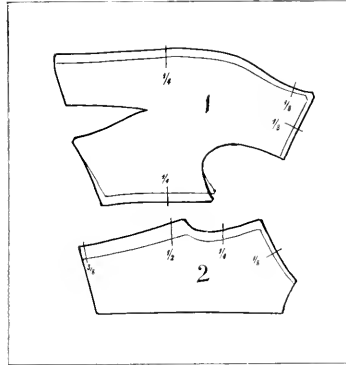

Increases and Decreases for Each Size	Across Bust	Across Waist	Across Chest	Across Back	Height of Shoulder	Length of Shoulder	Neck-Curve	Armhole
1. Front	$\frac{1}{2}$	$\frac{1}{2}$	$\frac{1}{4}$		$\frac{1}{8}$	$\frac{1}{8}$	$\frac{1}{8}$	$\frac{3}{8}$
2. Back	$\frac{1}{2}$	$\frac{3}{8}$		$\frac{1}{4}$	$\frac{1}{8}$	$\frac{1}{8}$	$\frac{1}{8}$	$\frac{3}{8}$
Total	1	$\frac{7}{8}$	$\frac{1}{4}$	$\frac{1}{4}$	$\frac{1}{4}$	$\frac{1}{8}$	$\frac{1}{4}$	$\frac{3}{4}$

Grading of Ladies' Semi-Fitting French Seam

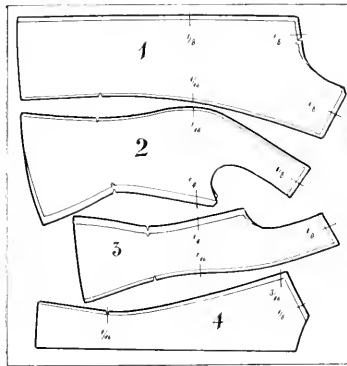

Increases and Decreases for Each Size	Across Bust	Across Waist	Across Chest	Across Back	Height of Shoulder	Length of Sleeve	Neck Curve	Armhole
1. 1st Part Front	$\frac{3}{16}$	$\frac{3}{16}$	$\frac{3}{16}$		$\frac{1}{8}$	$\frac{1}{16}$	$\frac{1}{8}$	
2. 2nd Part Front	$\frac{5}{16}$	$\frac{5}{16}$	$\frac{1}{16}$		$\frac{1}{8}$	$\frac{1}{16}$		$\frac{3}{8}$
3. Back Side	$\frac{5}{16}$	$\frac{5}{16}$		$\frac{1}{16}$	$\frac{1}{8}$	$\frac{1}{16}$		$\frac{3}{8}$
4. Back	$\frac{3}{16}$	$\frac{1}{16}$		$\frac{3}{16}$	$\frac{1}{8}$	$\frac{1}{16}$	$\frac{1}{8}$	
Total	1	$\frac{7}{8}$	$\frac{1}{4}$	$\frac{1}{4}$	$\frac{1}{4}$	$\frac{1}{8}$	$\frac{1}{4}$	$\frac{3}{4}$

Grading of Ladies' Tight-Fitting French Seam

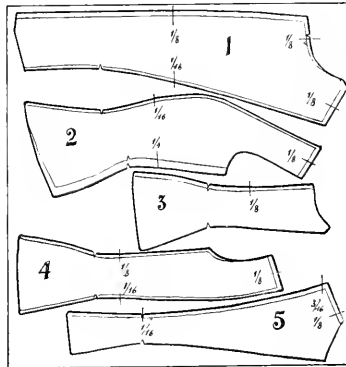

Increases and Decreases for Each Size	Grading Measurements							
	Across Bust	Across Waist	Across Chest	Across Back	Height of Shoulder	Length of Shoulder	Neck-Curve	Armhole
1. 1st Part Front	$\frac{3}{16}$	$\frac{3}{16}$	$\frac{3}{16}$		$\frac{1}{8}$	$\frac{1}{16}$	$\frac{1}{8}$	
2. 2nd Part Front	$\frac{5}{16}$	$\frac{7}{16}$	$\frac{1}{16}$		$\frac{1}{8}$	$\frac{1}{16}$		$\frac{3}{8}$
3. Under arm Gore	$\frac{1}{8}$	$\frac{1}{8}$						$\frac{1}{8}$
4. Back Side	$\frac{3}{16}$	$\frac{3}{16}$		$\frac{1}{16}$	$\frac{1}{8}$	$\frac{1}{16}$		$\frac{1}{4}$
5. Back	$\frac{3}{16}$	$\frac{1}{16}$		$\frac{3}{16}$	$\frac{1}{8}$	$\frac{1}{16}$	$\frac{1}{8}$	
Total	1	$\frac{7}{8}$	$\frac{1}{4}$	$\frac{1}{4}$	$\frac{1}{4}$	$\frac{1}{8}$	$\frac{1}{4}$	$\frac{3}{4}$

Grading of Ladies' Tight-Fitting Double French Seam

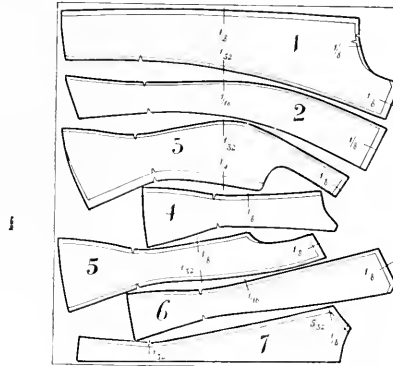

Increases and Decreases for Each Size	Across Bust	Across Waist	Across Chest	Across Back	Height of Shoulder	Length of Shoulder	Neck-Curve	Armhole
1. 1st Part Front	$\frac{5}{32}$	$\frac{5}{32}$	$\frac{5}{32}$		$\frac{1}{2}$	$1\frac{1}{32}$	$\frac{1}{7}$	
2. 2nd Part Front	$\frac{1}{16}$	$\frac{1}{16}$	$\frac{1}{16}$		$\frac{1}{2}$	$1\frac{1}{16}$		
3. 3rd Part Front	$\frac{9}{32}$	$\frac{9}{32}$	$1\frac{3}{32}$		$\frac{1}{2}$	$1\frac{3}{32}$		$\frac{3}{4}$
4. Under arm Gore	$\frac{1}{7}$	$\frac{1}{2}$						$\frac{1}{2}$
5. Back Side	$\frac{5}{32}$	$\frac{5}{32}$		$1\frac{3}{32}$	$\frac{1}{2}$	$1\frac{3}{32}$		$\frac{1}{4}$
6. Middle Back	$\frac{1}{16}$	$\frac{1}{16}$		$1\frac{1}{16}$	$\frac{1}{2}$	$1\frac{1}{16}$		
7. Back	$\frac{5}{32}$	$1\frac{3}{32}$		$\frac{5}{32}$	$\frac{1}{2}$	$1\frac{3}{32}$	$\frac{1}{2}$	
Total	1	$\frac{7}{2}$	$1\frac{1}{4}$	$1\frac{1}{4}$	$1\frac{1}{4}$	$1\frac{1}{2}$	$1\frac{1}{2}$	$3\frac{1}{4}$

How to Grade Misses' Sizes from Ladies' Size Patterns

Size 20 is the same as size 38.

Size 18 is the same as size 36.

Size 16 is the same as size 34, but $\frac{1}{2}$ inch shorter in the waist length.

Size 14 is the same as size 32, but 1 inch shorter in the waist length.

Grading of Misses' and Juniors' Tight-Fitting with dart

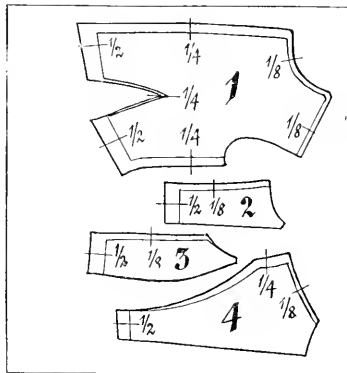

Increases and Decreases for Each Size	Across Bust	Across Waist	Across Chest	Across Back	Height of Shoulder	Length of Shoulder	Neck Curve	Armhole	Length Waist
1. Front	$\frac{1}{2}$	$\frac{1}{2}$	$\frac{1}{4}$		$\frac{1}{8}$	$\frac{1}{2}$	$\frac{1}{2}$	$\frac{3}{4}$	$\frac{1}{2}$
2. Front Side	$\frac{1}{8}$	$\frac{1}{8}$						$\frac{1}{2}$	$\frac{1}{2}$
3. Back Side	$\frac{1}{8}$	$\frac{1}{8}$						$\frac{1}{2}$	$\frac{1}{2}$
4. Back	$\frac{1}{4}$			$\frac{1}{4}$	$\frac{1}{8}$	$\frac{1}{8}$	$\frac{1}{8}$	$\frac{1}{2}$	$\frac{1}{2}$
Total	1	$\frac{3}{4}$	$\frac{1}{4}$	$\frac{1}{4}$	$\frac{1}{4}$	$\frac{1}{8}$	$\frac{1}{4}$	$\frac{3}{4}$	$\frac{1}{2}$

N. B. The Dart $\frac{1}{4}$ inch higher or lower as represented.

Grading of Misses' and Juniors' Tighth-Fitting French Seam

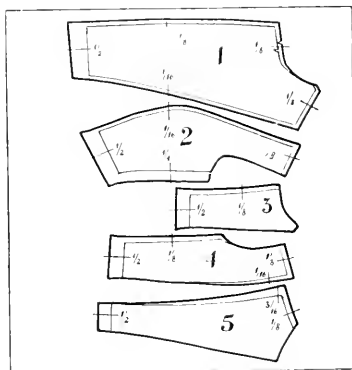

Increases and Decreases for Each Size	Across Bust	Across Waist	Across Chest	Across Back	Height of Shoulder	Length of Shoulder	Neck-Curve	Armhole	Length Waist
1. 1st Part Front	$\frac{3}{16}$	$\frac{3}{16}$	$\frac{3}{16}$		$\frac{1}{8}$	$\frac{1}{16}$	$\frac{1}{8}$		$\frac{1}{2}$
2. 2nd Part Front	$\frac{5}{16}$	$\frac{5}{16}$	$\frac{1}{16}$		$\frac{1}{8}$	$\frac{1}{16}$		$\frac{3}{8}$	$\frac{1}{4}$
3. Under arm Gore	$\frac{1}{8}$	$\frac{1}{8}$						$\frac{1}{8}$	$\frac{1}{2}$
4. Back Side	$\frac{3}{16}$	$\frac{1}{8}$		$\frac{1}{16}$	$\frac{1}{8}$	$\frac{1}{16}$		$\frac{1}{4}$	$\frac{1}{2}$
5. Back	$\frac{3}{16}$	The Same		$\frac{3}{16}$	$\frac{1}{8}$	$\frac{1}{16}$	$\frac{1}{8}$		$\frac{1}{2}$
Total	1	$\frac{3}{4}$	$\frac{1}{4}$	$\frac{1}{4}$	$\frac{1}{4}$	$\frac{1}{8}$	$\frac{1}{4}$	$\frac{3}{4}$	$\frac{1}{2}$

Grading of Childrens' and Infants' Semi-Fitting

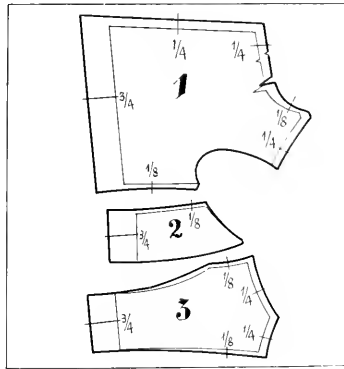

Increases and Decreases for Each Size	Across Bust	Across Waist	Across Chest	Across Back	Height of Shoulder	Length of Shoulder	Neck Curve	Armhole	Length Waist
1. Front	$\frac{3}{4}$	$\frac{1}{2}$	$\frac{1}{4}$		$\frac{1}{4}$	$\frac{1}{2}$	$\frac{1}{2}$	$\frac{3}{4}$	$\frac{3}{4}$
2. Side Piece	$\frac{1}{2}$	$\frac{1}{2}$						$\frac{1}{2}$	$\frac{3}{4}$
3. Back	$\frac{1}{4}$	The same		$\frac{1}{4}$	$\frac{1}{4}$	$\frac{1}{2}$	$\frac{1}{2}$	$\frac{1}{4}$	1
Total	$\frac{3}{4}$	$\frac{1}{2}$	$\frac{1}{4}$	$\frac{1}{4}$	$\frac{1}{2}$	$\frac{1}{2}$	$\frac{1}{4}$	$\frac{3}{4}$	1

Grading of Childrens' and Infants' Box Coat

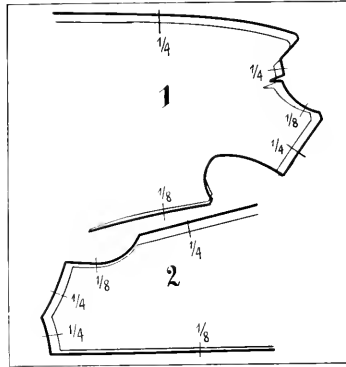

Increases and Decreases for Each Size	Across Bust	Across Waist	Across Chest	Across Back	Height of Shoulder	Length of Shoulder	Neck Curve	Armhole	Length Waist at the neck
1. Front	$\frac{3}{8}$ "	$\frac{3}{8}$ "	$\frac{1}{4}$ "		$\frac{1}{4}$ "	$\frac{1}{2}$ "	$\frac{1}{2}$ "	$\frac{3}{8}$ "	
2. Back	$\frac{3}{8}$ "	$\frac{3}{8}$ "		$\frac{1}{4}$ "	$\frac{1}{4}$ "	$\frac{1}{2}$ "	$\frac{1}{2}$ "	$\frac{3}{8}$ "	$\frac{1}{4}$ "
Total	$\frac{3}{4}$ "	$\frac{3}{4}$ "	$\frac{1}{4}$ "	$\frac{1}{4}$ "	$\frac{1}{2}$ "	$\frac{1}{2}$ "	$\frac{1}{4}$ "	$\frac{3}{4}$ "	$\frac{1}{4}$ "

Grading of Ladies', Misses', Juniors', Childrens' and Infants' Sleeve

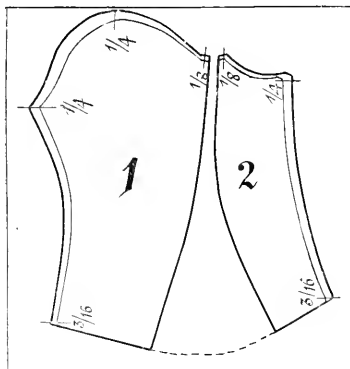

Increases and Decreases for Each Size	Wrist or Cuff	Muscle of arm	LENGTH				
			Ladies'	Misses'	Juniors'	Childrens'	Infants'
1. Top Sleeve	$\frac{3}{16}$	$\frac{1}{4}$	The same	$\frac{1}{2}$	1	1	1
2. Under Sleeve	$\frac{3}{16}$	$\frac{1}{4}$	The same	$\frac{1}{2}$	1	1	1
Total	$\frac{3}{8}$	$\frac{1}{2}$	The same	$\frac{1}{2}$	1	1	1

Grading of Cape, Yoke, Collar, Cuff

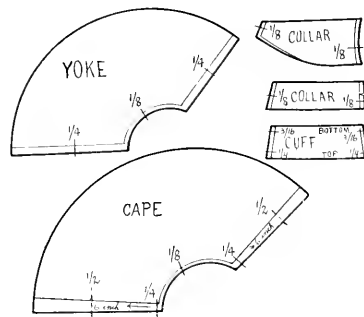

Increases and Decreases for Each Size

Cape: Neck $\frac{1}{4}$, Around Bust 1 inch.

Yoke: Neck $\frac{1}{4}$, Front $\frac{1}{4}$, Back $\frac{1}{4}$ inch.

Collar: Neck $\frac{1}{4}$ inch.

Cuff: Length on top $\frac{1}{2}$, on bottom $\frac{3}{8}$ inch.

Length of Garments

	Ladies' Size 36	Misses' Size 16	Juniors' Size 14	Childrens' Size 10	Infants' Size 4
Short Jacket	19	18	17	20	16
Half Three-Quarter Coat	32	27	26		
Three-Quarter Coat	36	32	31	30	22
Full Three-Quarter Coat	42	38	37	36	28
Cravanet	54	50	49		
Negligee Gown	60	58	57		
Kimono or Dressing Sacque	22	20	19		
Chemise	42	42	41	38	
Night Gown	58	56	55	40	

Grading of Length

	Childrens'	Infants'
Short Jacket	1	1
Three-Quarter Coat	2	2
Full Three-Quarter Coat	2	2

Skirts

Measures	Ladies' Size 36	Misses' Size 16	Juniors' Size 14	Childrens' Size 10
Around belt	25	24	24	26
Around Hips	43	41	38	32
Front Length	42	40	34	23
Side Length	43½	41½	35	23
Back Length	44	42	35	23

Grading of Skirt

Measures	Ladies'	Misses'	Juniors'	Childrens'
Around Belt	1½	1	1	½
Around Hips	2	2	2	1½
Length	The same	1	2	2

This is divided equally among all the gores, as many as there may be.

PART SEVEN

SPECIAL MEASUREMENT

Foundation of Garment Cutting

The method of Cutting may be divided in various ways, as for instance Proportinate and Special measures system, but looked at from the practical stand-point, they may be divided into two plans, viz, the cutting of a special pattern for each customer and the using of one model pattern for many different customers, adapting it as occasion may demand, either by judgement or the indications of special measures.

Cutting by model patterns is one of the most successful methods, and whilst much may be said in favor of the specially drafted pattern for each individual customer, yet there are also a considerable number of arguments to be advanced in favor of the model pattern being used as the basis of operation. To begin with, it is much easier to retain the same style in all the garments produced by this method than from any other; and when one has a pattern that will produce a really reliable, good-fitting, smart hanging, stylish garment, it is surprising what a large number of customers it can be used for, and what a very varied selection of garment it can be made to produce.

The first essential in all this is to get a good fitting model, and there are many methods of doing this. Some cutters make it a point of honor to produce their own models, carefully testing them at each stage by first of all cutting the garment out in linen and then altering and adjusting it so that every detail is brought to meet their views of style and fit. There are others who find it much more advantageous to avail themselves of the skill of more experienced practitioners, and in this way they are enabled to obtain the very best talent, which would otherwise be quite beyond them.

There are others who adopt a third plan, and that is to procure a simple pattern, to test it by experiment, and then use it as the basis for grading a full set of sizes. This requires some skill, and if done well it will produce most satisfactory results.

The cutter has necessarily to decide which style of model he will use as his basis. There are some who would vote for tight-fitting jacket pattern for his purpose; but in view of the popularity of the semi-fitting style at the present time,

there are those who prefer that fashion. Others again, use the bodice lining as their basis, and adapt the various parts according to the requirements of the garment and figure. Each plan has its advantages. Possibly, on the whole a semi-fitting model of a jacket is about the most useful type for the cutter of the present time, enabling him to cut the most fashionable style of pattern which will produce a smart, stylish garment.

The principles underlying all the systems of Cutting now in use are grouped under two headings.

1. Proportionate measurement.
2. Special measurement.

The Proportionate measurement of cutting are those in which all points of the draft are obtained by fixed proportions of the breast circumference.

The principle disadvantages of a Proportionate measure system are:

1. That it does not provide for disproportion or variations in attitude, as erect, stooping, high or low shouldered, full or flat breasted, etc.
2. That it does not provide for difference in shoulder or scye for figures of same breast measures.

That it leaves too much to the judgement of the cutter and too much to chance.

The Proportionate measurement basis of Cutting would only be reliable if womankind were all of strictly proportionate formation. In such a case divisions of the circumference of breast would produce correct outlines.

Special measures, they give to the cutter such confidence and assurance in their application as cannot be otherwise obtained, and in all kinds of garments are productive of the best possible results.

Special measures help to one to judge customer's form well.



How to take Special Measurement

1. **Bust measure.**—Around the body under the arms, over the fullest part in front, and well up on shoulder blades in back.
2. **Waist measure.**—Around the body at smallest part in waist.
3. **Hips measure.**—Around the body 6 inches below the waist line.
4. **Lower shoulder measure.**—This measure is found by placing the end of the tape at the center about 4 inches down the back seam from the center back of neck, passing the other end over the shoulder and under the arm back to the starting point.
5. **Upper shoulder measure.** This measure is found by placing the end of the tape at the center of back neck, passing the other end down the front of shoulder and under the arm back to the starting point.
6. **Back waist-length measure.** From center back of neck down to the natural waist line, and continue down to the full-length desired.
7. **Front waist-length measure.** From center back of neck to the waist of center of front.
8. **Bust depth measure.** From center back of neck to the brow of bust.
9. **Side waist-length measure.**—From center back of neck, over the shoulder to the waist line at side.

For the sleeve length take the inside seam from the arm pit to the wrist.

How to take Special Measurement

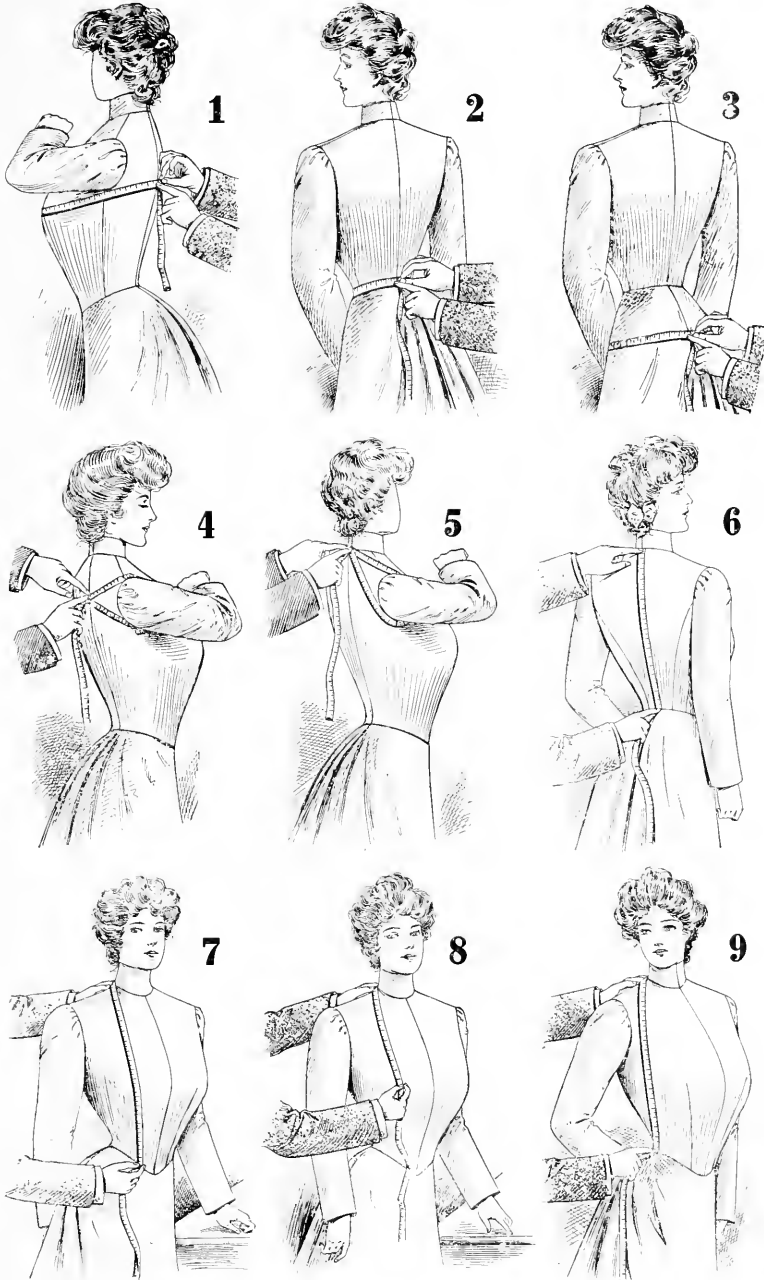

Systematic Outline

By Special Measurement

Measurement

Bust 40 inches.
Waist 26 inches.
Hips 41 inches.
Lower shoulder 25 inches.
Upper shoulder $25\frac{3}{4}$ inches.

Back waist-length $15\frac{1}{2}$ inches.
Front waist-length $23\frac{1}{2}$ inches.
Bust depth 15 inches.
Side waist length 21 inches.
Sleeve length 18 inches.

Scale is the half Lower shoulder measure, in this case $12\frac{1}{2}$ inches.

Half Scale is $6\frac{1}{4}$ "
One-Quarter Scale is $3\frac{1}{8}$ "

Excess is the difference between the Lower -- and Upper shoulder measures, in this case $\frac{3}{4}$ inch.

To Draft

A. Draw a straight line as from A to D.

B from A is the half Scale plus $\frac{3}{8}$ inch plus half Excess, in this case $6\frac{1}{4}$ plus $\frac{3}{8}$ plus $\frac{3}{8}$ together $7\frac{1}{4}$ inches.

C from A is the back waist-length measure, in this case $15\frac{1}{2}$ inches.

D from C is 6 inches.

Square out from A for the top line, from B for the Bust line, from C for the waist line and from D for the hip line as represented.

E from B is the half Bust measure plus 4 inches, in this case 24 inches.

F from B is the Scale less $\frac{1}{2}$ inch, in this case 12 inches.

G from F is the half Scale plus one-quarter Scale less $3\frac{3}{8}$ inches, in this case $6\frac{1}{4}$ plus $3\frac{1}{8}$ is $9\frac{3}{8}$ less $3\frac{3}{8}$ is G from F 6 inches.

H from B is the half Scale less $\frac{1}{4}$ inch, in this case 6 inches.

I from A is $5\frac{1}{2}$ inches.

Square out from E, F, G and I as represented.

J from I is $2\frac{1}{4}$ inches.

K from A is one-quarter Scale less $\frac{1}{8}$ inch, in this case 3 inches.

Square out from K as represented.

L is located by drawing a line from A to J.

M from H is 2 inches.

Square out from M as represented.

N from M is half Scale plus $\frac{3}{8}$ inch, in this case $6\frac{7}{8}$ inches.

O from N is $\frac{1}{2}$ inch on line drawn from L through N.

P is the center between M and N.

Q from I is $\frac{3}{4}$ inch.

R is located by drawing a line from A through Q.

S from G is one-quarter Scale plus $\frac{1}{8}$ inch, in this case $3\frac{1}{4}$ inches.

Square out from S as represented.

T from S is half Scale plus $1\frac{3}{4}$ inches, in this case 8 inches.

U from R is $\frac{3}{8}$ inch more than the distance from L to O on line drawn from R through T. Cut off the point at R of $\frac{3}{8}$ inch as represented.

V from S is 2 inches.

W from R is 2 inches.

Square out from W as represented.

X from W is one-quarter scale plus $\frac{3}{8}$ inch, in this case $3\frac{3}{4}$ inches.

Y is located by a line squared out from E.

Z is located by a line squared out from F

NOTICE

In all Diagrams — designed in this Systematic Outline — are $\frac{3}{8}$ inch seams allowed.

In all Diagrams — designed in this Systematic outline — is the half waist measure 7 inches less than the half Bust measure. (See Waist Suppression on page 20.)

In all Diagrams — designed in this Systematic Outline — is the half hip measure $\frac{1}{2}$ inch more than the half Bust measure. (See Hip Development on page 20.)

Systematic Outline

By Special Measurement

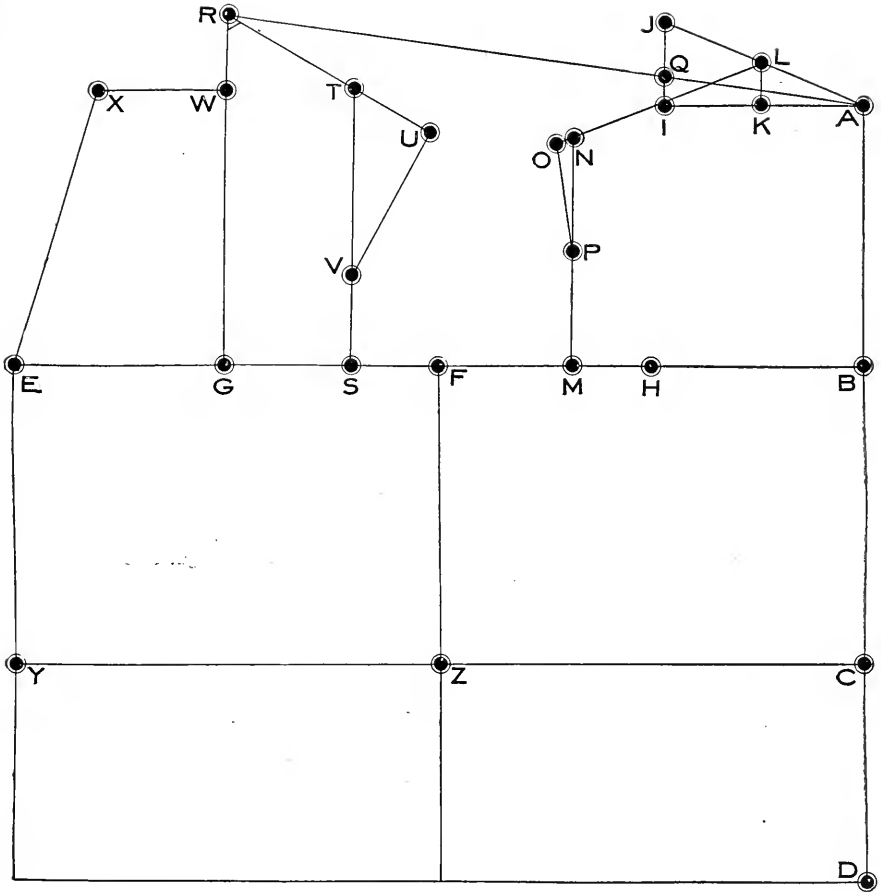

Tight-Fitting French Seam

By Special Measurement

First lay up all points to your measure as described in Systematic Outline for Special Measurement (Page 282), then continue as follows:

- 1 from R is the Side waist-length measure plus $1\frac{3}{4}$ inches and less the width of the back neck as from A to L, in this case 21 plus $1\frac{3}{4}$ is $22\frac{3}{4}$ less $3\frac{1}{4}$ is 1 from R $19\frac{1}{2}$ inches.
- 2 from R is the Front length-measure plus $\frac{7}{8}$ inch and less the width of the back neck as from A to L, in this case $23\frac{1}{2}$ plus $\frac{7}{8}$ is $24\frac{3}{8}$ less $3\frac{1}{4}$, is 2 from R $21\frac{1}{8}$ inches.
Draw lines from C to 1 and from 1 through 2 for the fashionable waist line as represented.
- 3 from C is 2 inches.
- 4 from D is $1\frac{3}{4}$ inches.
- 5 from O is $\frac{3}{4}$ inch.
- 6 from P is $\frac{3}{4}$ inch.
Draw a line from 5 to 6.
- 7 is the half-way between 5 and L, or make the width to style or taste.
- 8 from 3 is 1 inch less than A to K.
- 9 is located by drawing a line from 7 to 8 as represented.
- 10 from 4 is $\frac{3}{4}$ inch more than 3 to 8.
- 11 from 8 is $\frac{3}{4}$ inch.
- 12 from 10 is 1 inch.
- 13 from F is $\frac{3}{4}$ inch.
- 14 from 1 is $\frac{3}{4}$ inch.
- 15 is located by drawing a line from 13 through 14.
- 16 is the half-way between 9 and H.
- 17 is the half-way between 11 and 14.
- 18 is located by drawing a line from 16 through 17.
- 19 from 17 is $\frac{1}{2}$ inch.
- 20 from 17 is $\frac{1}{2}$ inch.
- 21 from 18 is 1 inch.
- 22 from 18 is 1 inch.
- 23 from 15 is $\frac{1}{2}$ inch.
- 24 from 7 is $\frac{3}{8}$ inch, and is $\frac{1}{4}$ inch higher from the line L-5.
- 25 from 5 is $\frac{3}{8}$ inch, and is from 6 the same length as O from P.
- 26 from 16 is 1 inch.
- 27 from 26 is $\frac{3}{8}$ inch for seam.
Finish the back and side gores as represented.
- 28 from 14 is $\frac{3}{4}$ inch, and is from 13 the same length as 14 from 13.
- 29 from 15 is $1\frac{1}{2}$ inches.
- 30 from 2 is $1\frac{3}{4}$ inches.
- 31 is located by drawing a line from E through 30.
- 32 from 31 is $\frac{3}{8}$ inch.
- 33 from R is the Bust depth measure plus $1\frac{1}{4}$ inches and less the width of the back neck as from A to L, in this case 15 plus $1\frac{1}{4}$ is $16\frac{1}{4}$ less $3\frac{1}{4}$, is point 33 from R 13 inches.
- 34 from 33 is 2 inches on line drawn from 33 parallel with line 1-2.
- 35 is located by drawing a line from 34 parallel with line E-30.
- 36 from 35 is $1\frac{1}{4}$ inches.
- 37 from 35 is $2\frac{3}{4}$ inches.
- 38 from 34 is the same length as 36 from 34.
- 39 is located by drawing a line from 36 parallel with line E-31.
- 40 from 39 is $4\frac{3}{4}$ inches.
- 41 from R is the same width as L to 7.
Draw a line from 41 to 34.
- 42 from 41 is $\frac{3}{4}$ inch for seams.
Draw a line from 42 parallel with line 41-34.
- 43 from 14 is the same length as 29 from 28.
- 44 from 40 is $1\frac{1}{4}$ inches.
- 45 from 36 is the same length as 44 from 38.
Finish the front as represented.

Tight-Fitting French Seam

By Special Measurement

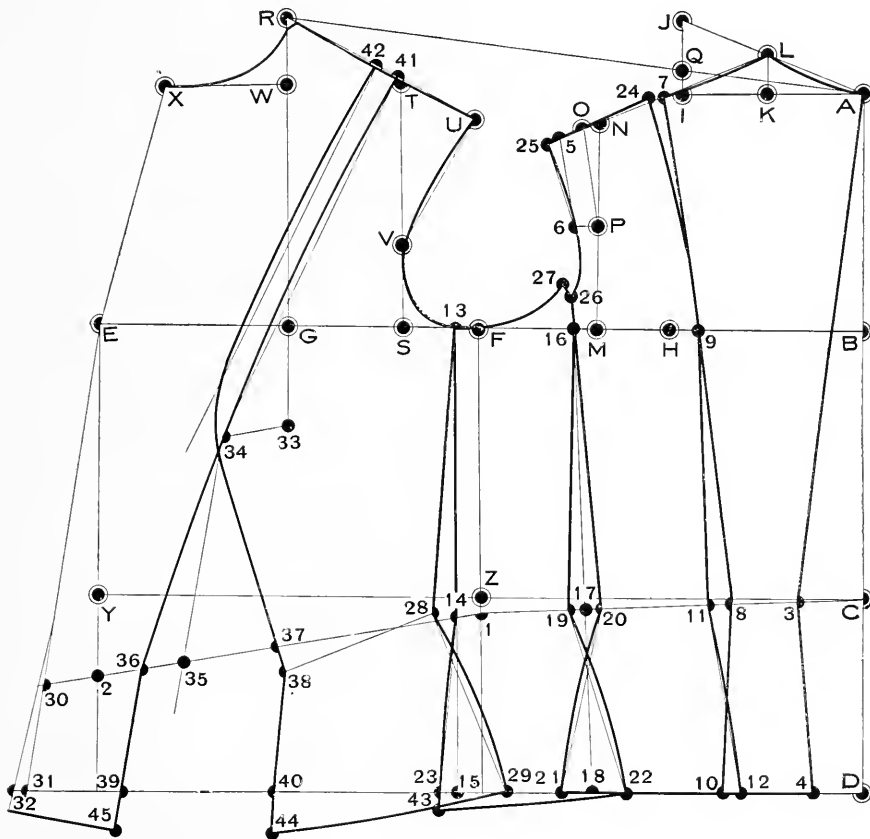

Semi-Fitting with Dart in Front

By Special Measurement

First lay up all points to your measure as described in Systematic Outline for Special Measurement (Page 282), then continue as follows:

- 1 from R is the Side waist-length measure plus $1\frac{3}{4}$ inches and less the width of the back neck as from A to L, in this case 21 plus $1\frac{3}{4}$ is $22\frac{3}{4}$ less $3\frac{1}{4}$ is 1 from R $19\frac{1}{2}$ inches.
 2 from R is the Front length-measure plus $\frac{7}{8}$ inch and less the width of the back neck as from A to L, in this case $23\frac{1}{2}$ plus $\frac{7}{8}$ is $24\frac{3}{8}$ less $3\frac{1}{4}$, is 2 from R $21\frac{1}{8}$ inches.

Draw lines from C to 1 and from 1 through 2 for the fashionable waist line as represented.

- 3 from C is $1\frac{1}{2}$ inches.
 4 from 3 is $\frac{1}{4}$ inch.
 5 from D is 1 inch.
 6 from P is $\frac{3}{4}$ inch.
 7 from H is $\frac{3}{4}$ inch.
 8 from 4 is 1 inch more than the distance from A to K.
 9 from 5 is $\frac{3}{4}$ inch more than the distance from 4 to 8.

Finish the back as represented.

- 10 from 8 is $\frac{1}{2}$ inch.
 11 from 9 is $1\frac{1}{2}$ inches.
 12 from 6 is $\frac{1}{2}$ inch.
 13 from F is $\frac{3}{4}$ inch.
 14 from 1 is $\frac{3}{4}$ inch.
 15 is located by drawing a line from 13 through 14.
 16 from 14 is $\frac{1}{2}$ inch.

Finish the side gore as represented.

- 17 from 1 is $\frac{1}{2}$ inch, and is from F the same length as 16 from 13.
 18 from 15 is 1 inch.
 19 from 2 is 2 inches.

Draw line from E through 19.

- 20 from R is the Bust depth measure plus $1\frac{1}{4}$ inches and less the width of the back neck as from A to L, in this case 15 plus $1\frac{1}{4}$ is $16\frac{1}{4}$ less $3\frac{1}{4}$, is point 20 from R 13 inches.
 21 from 20 is $1\frac{1}{2}$ inches on line drawn parallel with line E-19.
 22 is located by drawing a line from 21 parallel with line E-19.
 23 is located by drawing a line from 21 parallel with line E-19.
 24 from 22 is $\frac{1}{2}$ inch.
 25 from 24 is 3 inches.
 26 from 21 is the same length as 24 from 21.
 27 from 23 is $\frac{3}{8}$ inch.
 28 from 27 is $3\frac{3}{4}$ inches.

Finish the front as represented.

- 29 from 16 is the same length as 18 from 17.
 30 from 28 is $1\frac{1}{4}$ inches.
 31 from 24 is the same length as 30 from 26.

Finish the bottom as represented.

Semi-Fitting with Dart in Front

By Special Measurement

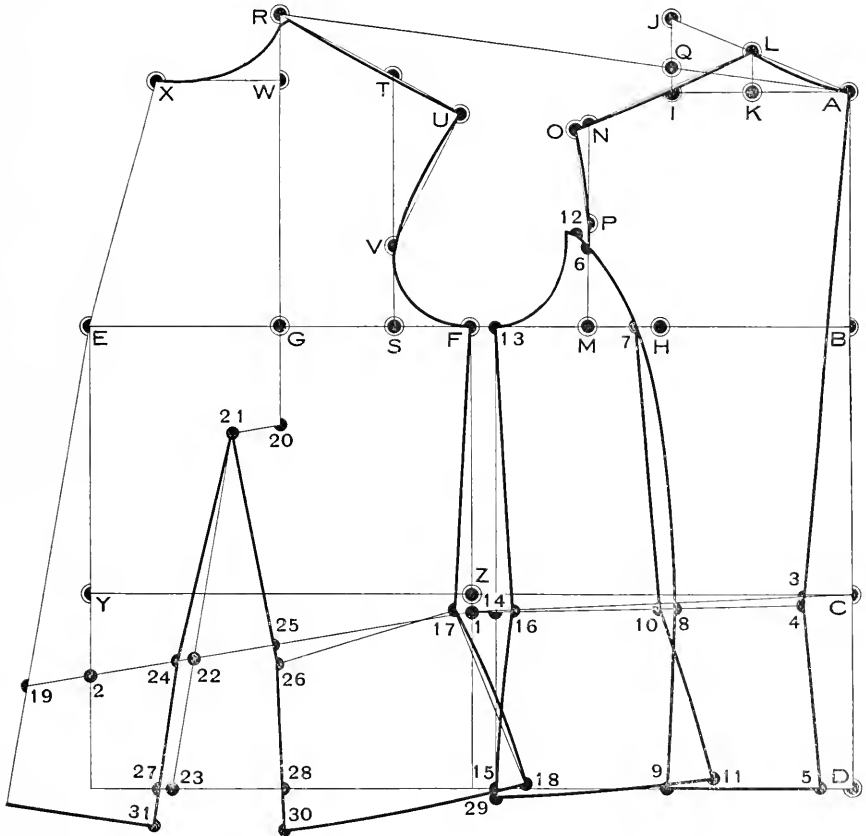

Systematic Outline

By Special Measurement

No Seam Allowances

Measurement

Bust 40 inches.
Waist 26 inches.
Hips 41 inches.
Lower shoulder 25 inches.
Upper shoulder $25\frac{3}{4}$ inches.

Back waist-length $15\frac{1}{2}$ inches.
Front waist-length $23\frac{1}{2}$ inches.
Bust depth 15 inches.
Side waist length 21 inches.
Sleeve length 18 inches.

Scale is the half Lower shoulder measure, in this case $12\frac{1}{2}$ inches.

Half Scale is $6\frac{1}{4}$ "

One-Quarter Scale is $3\frac{1}{8}$ "

Excess is the difference between the Lower and Upper shoulder measures, in this case $\frac{3}{8}$ inch.

To Draft

A. Draw a straight line as from A to W.

B from A is $5\frac{1}{2}$ inches on line squared up from A.

C from B is $2\frac{1}{4}$ inches on line squared out from B.

Draw a line from A to C.

D from A is the half Scale plus $\frac{5}{8}$ inch plus half Excess, in this case $6\frac{1}{4}$ plus $\frac{5}{8}$ plus $\frac{3}{8}$ is $7\frac{1}{4}$ inches.

Square out line from D as represented.

E from D is the Scale less $\frac{1}{2}$ inch, in this case 12 inches.

F from D is the half Scale plus 1 inch, in this case $6\frac{1}{4}$ plus 1 is $7\frac{1}{4}$ inches.

G from E is one-quarter Scale less $\frac{1}{2}$ inch, in this case $3\frac{1}{8}$ less $\frac{1}{2}$ is $2\frac{7}{8}$ inches.

H from D is the half Bust measure plus 1 inch, in this case 20 plus 1 is 21 inches.

I from E is $1\frac{1}{2}$ inches.

Square lines from F, I, E, G and H as represented.

J from F is half Scale plus $\frac{1}{2}$ inch, in this case $6\frac{1}{4}$ plus $\frac{1}{2}$ is $6\frac{3}{4}$ inches.

K from A is one-quarter Scale less $\frac{1}{2}$ inch, in this case $3\frac{1}{8}$ less $\frac{1}{2}$ is $2\frac{7}{8}$ inches.

L from J is $\frac{1}{2}$ inch on line drawn from K through J.

M is the center between J and F.

Draw a line from L to M.

N from G is half Scale plus $2\frac{3}{8}$ inches plus half Excess, in this case $6\frac{1}{4}$ plus $2\frac{3}{8}$ plus $\frac{3}{8}$ is $9\frac{1}{4}$ inches.

O from E is half Scale plus $1\frac{3}{8}$ inches, in this case $6\frac{1}{4}$ plus $1\frac{3}{8}$ is $7\frac{7}{8}$ inches.

P from N is the same length as L from K on line drawn from N through O.

Q from E is 2 inches.

Draw a line from P to Q.

R from N one-quarter Scale, in this case $3\frac{1}{8}$ inches on line squared out from N.

Draw a line from R to H.

S from R is $2\frac{1}{4}$ inches.

T from A is the Back waist-length measure, in this case $15\frac{1}{2}$ inches.

U from N is the Side waist-length measure less the back neck as from A to K.

V from N is the Front waist-length measure less the back neck as from A to K.

Z from N is the Bust depth measure less the back neck as from A to K.

Draw lines from T to U and from U to V.

Y and **X** are located by a line squared up from W.

Systematic Outline By Special Measurement

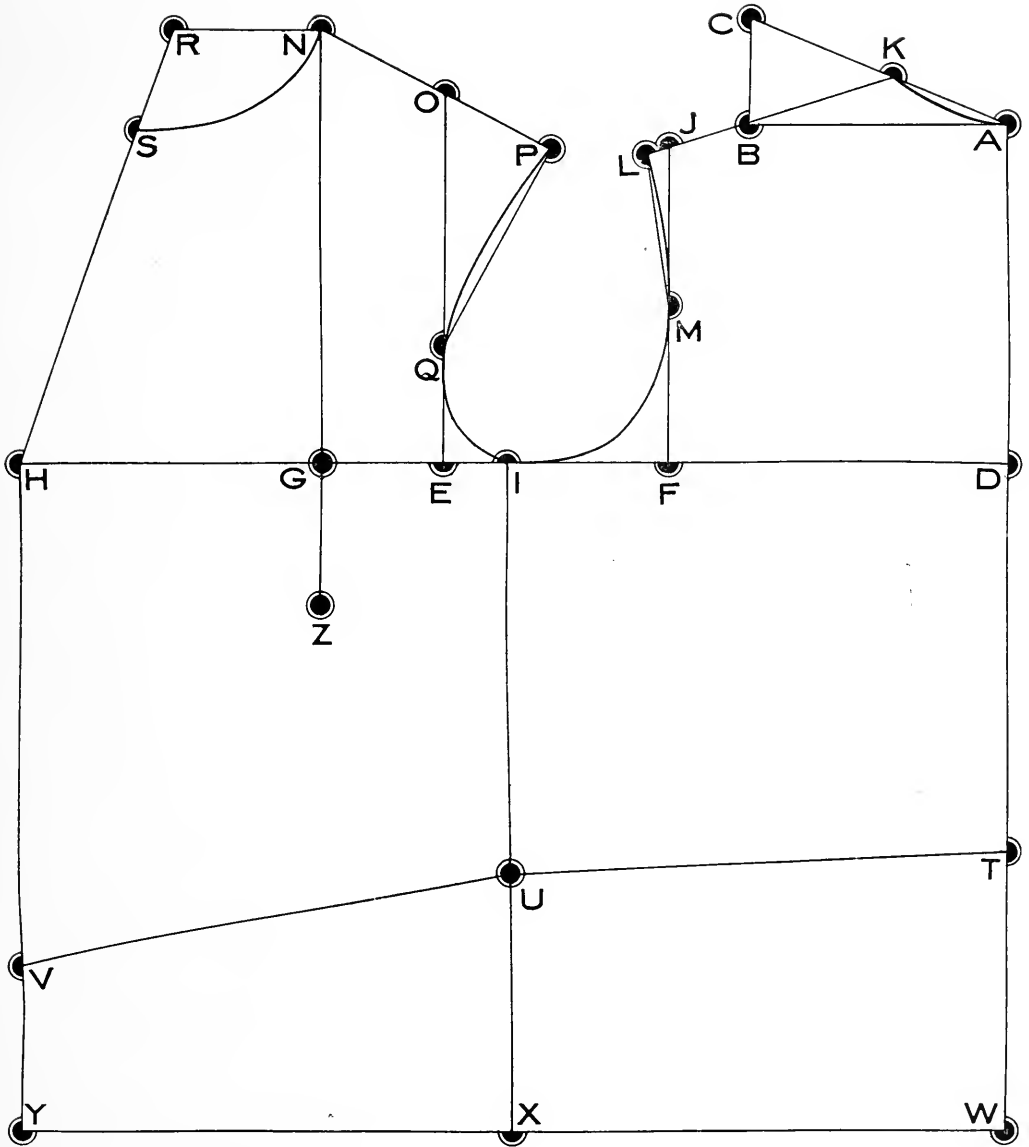

Tight-Fitting Jacket

By Special Measure System

Seams are not allowed

First lay up all points to your measure as described in Systematic Outline (page 288), then continue as follows:

- 1 from T is 2 inches.
- 2 from W is $1\frac{3}{4}$ inches.
- 3 from 1 is 1 inch less than K from A.
- 4 is located by drawing a curved line from M to 3 as represented.
- 5 from 2 is $\frac{3}{4}$ inch more than 3 from 1. Finish the back as represented.
- 6 from 3 is $\frac{3}{4}$ inch.
- 7 from 5 is 1 inch.
- 8 is the center between 1 and 4.
- 9 is the center between U and 6.
- 10 is located by drawing a line from 8 through 9.
- 11 from 9 is $\frac{1}{4}$ inch.
- 12 from 9 is $\frac{1}{2}$ inch.
- 13 is located by drawing a line from 12 through 8.
- 14 from 10 is 1 inch.
- 15 from 10 is 1 inch.
- 16 from X is $\frac{1}{2}$ inch. Finish both side gores as represented.
- 17 from U is $\frac{3}{4}$ inch and is from 1 the same length as U from 1.
- 18 from X is $1\frac{1}{2}$ inches.
- 19 from V is $1\frac{3}{4}$ inches.
- 20 is located by drawing a line from H through 19.
- 21 from Z is $\frac{3}{4}$ inch less than K from A.
- 22 is located by drawing a line from 21 parallel with line H-20.
- 23 is located by drawing a line from 21 through 22. Measure up the waist line from 1 to 3 and continue 6 to 12, 11 to U and 17 to 19; the total is in this case $17\frac{3}{4}$ inches. The half of the actual waist measure is in this case 13 inches; there is a surplus $4\frac{3}{4}$ inches, which amount is to be taken out in dart.
- 24 from 22 is one-third of the Dart, in this case $1\frac{1}{2}$ inches.
- 25 from 23 is the same as 24 from 22.
- 26 from 24 is the Dart, in this case $4\frac{3}{4}$ inches.
- 27 is located by drawing a line from 21 through 26 and is from 21 the same length as 24 from 21.
- 28 from 25 is $\frac{3}{4}$ inch more than 26 from 24. Measure up the hip line from 2 to 5

and continue 7 to 14, 15 to 16, 18 to 28 and 25 to 20. The difference between this total and the half of the actual hips measure is to be added to by larger size hips and to be taken off by smaller size hips equally divided at points 16, 18, 14, 15 and 7.

- 29 from 20 is $\frac{3}{8}$ inch. Finish the front as represented.
- 30 from A is the full length desired.
- 31 is located by a line squared out from 30.
- 32 is located by drawing a line from 1 through 2.
- 33 is located by drawing a line from the middle of 3-6 through 5.
- 34 is located by drawing a line from the middle of 3-6 through 7 and is the same length from 6 as 33 from 3.
- 35 is located by drawing a line from 9 through 14.
- 36 is located by drawing a line from 9 through 15, and is from 11 the same length as 35 from 12.
- 37 is located by drawing a line from U through 18.
- 38 is located by drawing a line from $\frac{1}{4}$ inch outside from U through 16, and is from U the same length as 37 from 17.
- 39 is located by drawing a line from 27 through 28 and is $1\frac{1}{4}$ inches below 31.
- 40 is located by a line drawn from 24 through 25, and is from 24 the same length as 39 from 27. Allow for single breasted button stand $1\frac{1}{2}$ inches.

The Collar and Lapel

- 41 from N is 1 inch.
- 42 is the length of the crease line desired. Draw a line from 42 through 41 and longer.
- 43 from N is $\frac{1}{4}$ inch.
- 44 from 43 is $1\frac{1}{4}$ inches more than K from A on line drawn from 43 parallel with line 42-41-45.
- 45 is located by a line squared up from 44.
- 46 is located by a line squared out from 44 and make the width of collar as desired.
- 47 from 46 is about $\frac{1}{2}$ inch for the spring of collar. Finish the draft as represented. No seams or turnings - in allowed for on this draft.

Tight-Fitting Jacket

By Special Measure System

Seams are not allowed

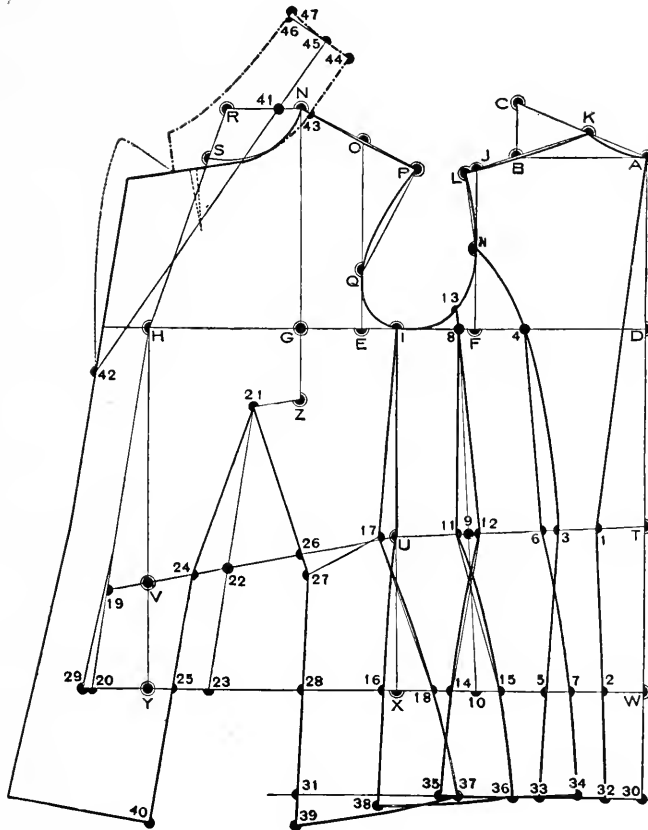

Taking Special Measurement

For Direct Short Measure System

(How to apply this measurement to the System see pages 308 and 309.)

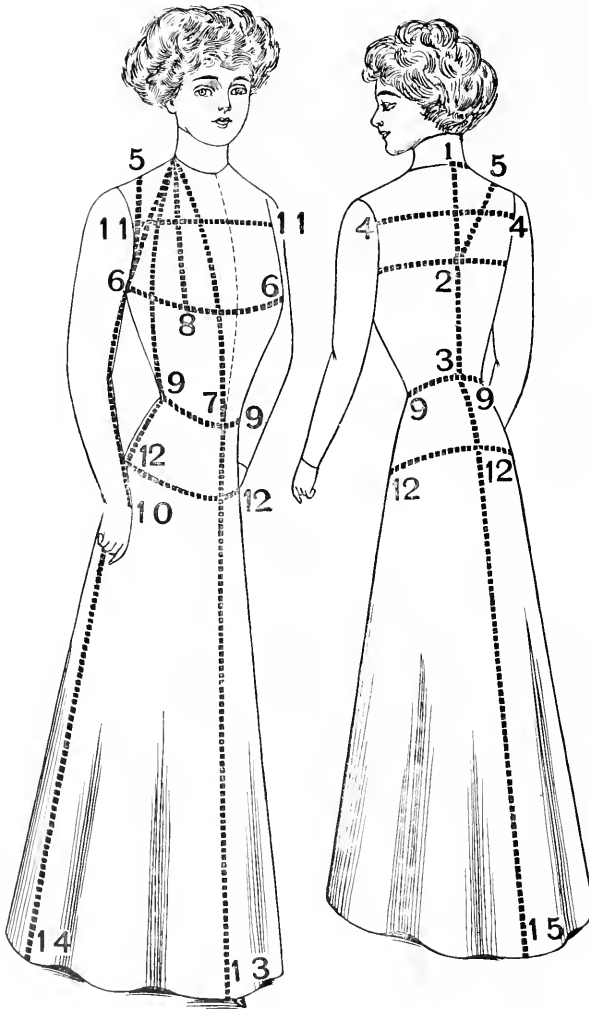

Measurement

For Body

- 2-6-2 Around bust
- 3-9-3 Around waist
- 12-12 Around hips
- 1-2 Back seye depth
- 1-3 Back waist length
- 2-5-6 Over shoulder
- 1-6 Front shoulder
- 1-7 Front waist length
- 1-8 Bust depth
- 1-9 Side waist length
- 11-11 Across chest
- 6-6 Across bust
- 6-10 Sleeve length

For Skirt

- 3-9-3 Around waist
- 12-12 Around hips
- 7-13 Front length
- 9-14 Side length
- 9-15 Back length

PART EIGHT

RIDING AND SPORTING GARMENTS

Riding Skirts



In the middle of the last century they were simply several widths of material plaited into the waist and cut long enough to flow gracefully to at least 12 inches below the feet of the wearer. These, although graceful, were not practical, and, from the standpoint of safety, it was found a veritable death-trap when the lady had the misfortune to be thrown from her horse; the surplus material which formed the graceful folds had a knack of twisting themselves round the pommel of the saddle, and the lady would be dragged along the ground till she was kicked to death.

Then came a revolution, and trains were made shorter and shorter, and closer and closer, till they arrived at what was

thought to be the utmost limit of safety, when they were quite close-fitting over the seat, and long enough to almost cover the foot, the toe just showing out from the hem of the train.

Experience in the hunting-field suggested improvements on these; ladies cut out large holes from the underpart of the train for additional safety, whilst others cleared the whole of the underpart from the seat downwards away, and just left enough to folds over the leg at either side, and so still further simplified it.

The most important item in a riding skirt is a clean saddle, that is, there must be no wrinkles or creases under the wearer's seat or legs and more particularly about the spot where the knees come in contact with the pommel.

Such superfluous material means pain to the rider and soreness for some time after a ride, and so such superfluity must be avoided.

The question is, if these things should be present, how can we locate where the fulness starts and finishes? Well, this is how to do it.

Having placed the skirt on the customer and the customer on the horse, and furthermore, made sure that the skirt is in the right position, proceed by fitting the upper side.

When this has been accomplished, rip up the back seam and the front seam from foot to knee, and throw the front clean over the horse, thus exposing the wearer. Mention, of course, that you intend to do this, but first of all ask the young lady who put the skirt on whether the customer is properly clad. Once the under part is exposed on the interior then the rest is simple.

Having fitted the underside replace the topside and carefully readjust.

Side Saddle Safety Riding Skirt

Front

These diagrams represent a model of a side saddle safety riding skirt, which reproduced by the inch tape, will fit a lady with 26 inches waist, 43 inches hips, 20 $\frac{1}{2}$ inches side to knee and 13 inches rise measurement.

Seams are not allowed.

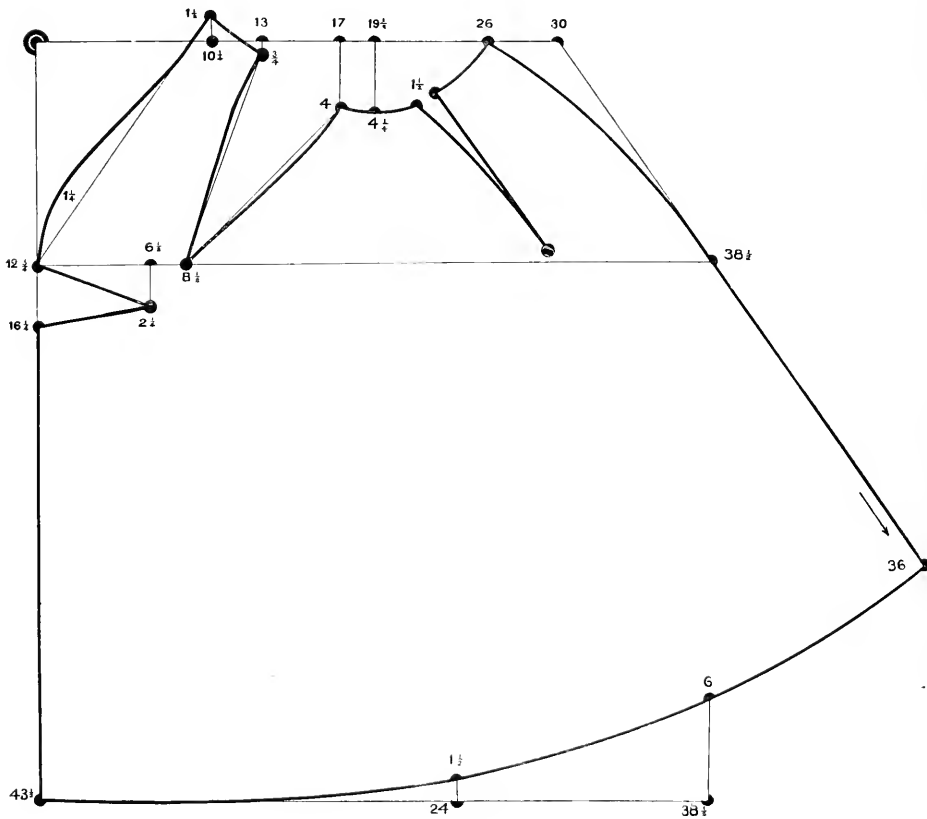

Side Saddle Safety Riding Skirt

Back

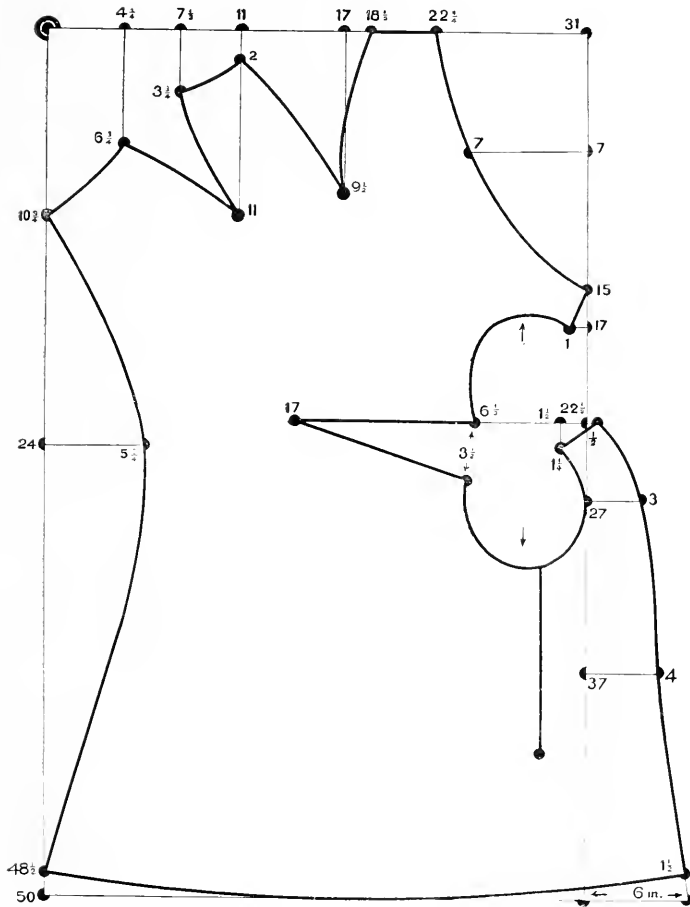

In this particular skirt there is a hole for the pommels and is made like a placquette of a skirt with press studs.

If the rider is thrown, these studs come into action and prevent the rider being hung up on the pommel.

Apron Riding Skirts

To Draft

This diagram represents a model of an Apron Riding Skirt, which reproduced by the inch tape, will fit a lady 24 waist, 40 seat. Seam allowances of one-quarter of an inch are allowed.

Front

A. Draw a line as from A to I.

B from A is $7\frac{1}{2}$ inches.

C from A is 9 inches.

D from A is 11 inches.

E from A is 15 inches.

F from A is 16 inches.

G from A is 23 inches.

H from A is 34 inches.

I from A is 51 inches.

Square out lines from A, B, D, F, and H as represented.

J from A is $21\frac{1}{2}$ inches.

K from A is 30 inches.

L from B is 8 inches.

M from B is 30 inches.

N from D is 10 inches.

O from D is 28 inches.

P from F is 5 inches.

Q from F is $5\frac{3}{4}$ inches.

R from F is 28 inches.

S from F is 34 inches.

T from H is 50 inches.

U from H is 1 inch.

Draw lines from J to L and K to M.

1 is the center of J-L.

2 from 1 is $1\frac{1}{4}$ inches.

3 is the center of K-M.

4 from 3 is 2 inches.

5 is located by drawing a line from D to R.

6 from 5 is 13 inches.

Take out 1 inch between 5 and 6 as represented.

Draw lines from N to Q, from T to I and from T through S as represented.

7 is the center of N-Q.

8 from 7 is $1\frac{1}{2}$ inches.

9 is the center of T-I.

10 from 9 is 7 inches.

11 from S is 1 inch.

Finish the front part as represented.

Back

Square out lines from C, G and H as represented.

V from C is 14 inches.

W from G is 20 inches.

X from H is $3\frac{1}{2}$ inches.

Y from H is 16 inches.

Continue the line T-I as represented.

Z from I is 14 inches.

Connect V-W and W-Z.

12 from C is 8 inches. Connect E-12.

13 from E is 3 inches.

14 from 13 is $2\frac{1}{2}$ inches.

15 from 14 is 4 inches.

16 from C is 11 inches.

17 from G is $10\frac{1}{2}$ inches.

Connect 16-17.

18 from 13 is 6 inches.

19 from 16 is 6 inches.

Finish waist line as represented.

20 is the center of V-W.

21 from 20 is $1\frac{1}{4}$ inches.

22 from 1 is $\frac{1}{2}$ inch.

Finish the back part as represented.

23 is the place for two holes.

24 is the place for inside thigh fastening.

25 is the inside elastic loop.

26 is a tab.

27 is double cloth for knee.

28 is pocket.

29 is inside elastic loop.

30 is a button.

31 is the edge of lining shown by dash-line.

23 is the position is saddle.

Apron Riding Skirt

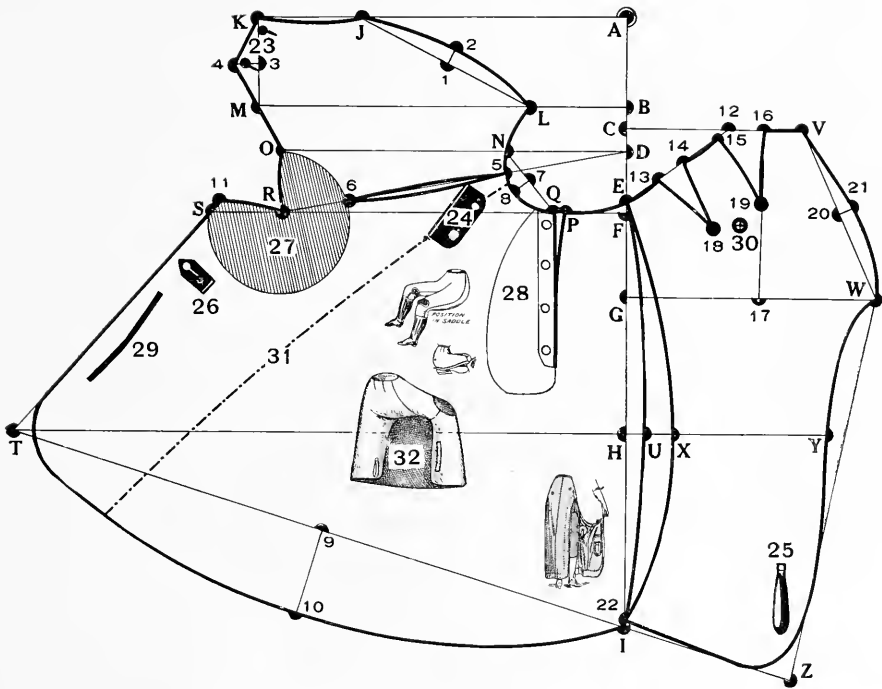

Hints on Making Apron Riding Skirts

One of the most convenient and becoming of the safety riding skirts is the Apron Riding Skirt. One position of it is cut very much on the trouser principle, and, altogether, it is easy to make, comfortable for wear, as well as safe in case of accident.

The shaded portion at 27 is the position of knee when the apron is finished. The main thing is to secure plenty of room for the knee when the wearer is in the saddle, and to keep the lap portion short and hollow. For that reason a shaped seam is put from 5 through 6 to R.

The Figure 11 joins point O, and you will find 11 somewhat longer than the other half of cut, and both have slightly round edges. These two edges, when sewn together, produce a considerable cavity into which the knee fits. The fullness produced by extra length of side 11 must be sewn on and afterwards pressed back from outer edge, and so help to give shape there. The large vees on underside will be sewn with tapering effect towards 17, and the surplus material caused by the closing up of these cuts be distributed by the iron downwards over line 17.

The lines V-W and J-I, are the seat-seam when the apron is on, and that from I to E is the side seam. These seams will be sewn in the ordinary manner and pressed open, the opened seam being either stitched down by machine or felled down raw edge so far as the side seam is concerned. As a rule the seat portion is lined to just cover the seam with the same piece of material which goes through the front, as per dot and dash line 31, to bottom behind T. That lining must, of course, have all the shape given it that the cloth has had at 5-6, 6-11-R, and the piece of cloth which joins the underside Z-W.

The shaped part from J-K-4-M-O, is made up with two holes, and buttons put on a broad elastic tab, which is fixed firmly on a linen stay just below front waist on the lap portion. This tab is shown at 24, close to lap cut 5: in consequence of this arrangement, where O joins 11 and where W joins J, firm linen stays must be placed, and those points must be well tacked through the linen, so that the strain put upon those positions shall not split the material.

The placquet-hole is merely cut down and piped with a piece of the same material, or bound in with a strip of lining. A facing can be put on the underside of opening, and a pocket put in as in the ordinary skirt; the placquet finished in this way is shown at 28 on diagram.

The edges 11-T and Y-Z are stayed with a strip of linen or staytape, then turned in and stitched. If you line the front of skirt the edge 11-T will be faced with the lining before you stitch the edge down; if not, both can be felled raw edge; if the cloth of apron is of melton or other firm edge material.

When the flap portion L-J-O is fastened up on 24, the leg of the rider will be through the circle so formed, and so the apron fits cleanly and firmly round the leg, whether the wearer be on horseback or on foot, just as we see it fitting round the knee on inset diagram point 32. You will notice on that diagram two loops of different shape; these appear to be on the outside of skirt in that diagram but such is not the case; they are shown there with a view of aiding you to comprehend their position when the wearer is in the saddle. The true position of those loops is seen at 29 at 25 of the large diagram; they are made of $\frac{3}{4}$ inch or 1 inch elastic; that at 29 is fastened to a linen stay placed underneath the front lining and caught in the outer edge, and felled round its inner edge to skirt. 29 is about 8 inches long, fastened at both ends, and left somewhat loose in center, so that the foot of rider can easily fit into it, and, as you will note, is placed with its bottom and about two-thirds the distance down from 11 to T, that is to say, somewhere about one-third the length of front seam up from the bottom of skirt. 25 is a double piece of similar elastic fastened to a linen stay felled on the under side; the double end of loop reaches nearly to the bottom, say within 3 or at most 4 inches of bottom; the looped portion should be about 6 or 7 inches long, and be strongly secured to skirt; into these loops the feet of the rider can be thrust at will, and be easily removed in case of necessity.

About 29 you notice a cloth tab, or you may put an elastic tab there, and, on the whole, we would advise that as the better plan. Well this tab is fitted there with the object of enabling the wearer of the apron when off the horse to fasten that part of apron up at back of waist, where a button should be placed at the end of waist cuts; this has the effect of hiding the upper parts of legs when the wearer is walking. While on the horse the skirt or apron appears as we show it at small diagram, only the single portion comes against the side of the horse.

The waist should be finished thickly, and with a neat band — if band be put at all — or the top of skirt turned in and stitched round.

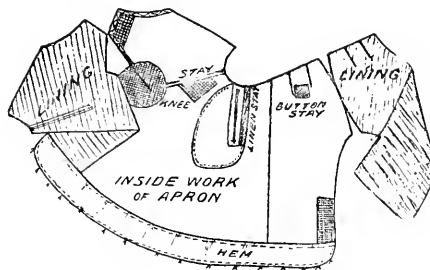

Cutting Riding Skirts by Model Patterns

In the cutting of riding skirts it is necessary to adjust the pattern to the length, the size of waist, and the size of the seat.

In altering the length we have to bear in mind that this will also effect the distance from the waist to the knee that goes over the pommel, so that the length must be increased half above the knee and half below.

For instance, suppose the length of the skirt has to be increased 2 inches, we open out the pattern at M M that amount, but we also open it out at P P half that quantity, or 1 inch. For the underside we open it out 1 inch at N and 1 inch at O; this will produce the proper adjustment at the side seam and also at the seat-seam, K L.

In making corrections for the size of waist we want to bear in mind the adjustment necessary to the seat, for the two may go together, though this does not necessarily follow, it is best to adjust the size of the seat first, and this is done equally at the four seams K, I, G, F. This being done, the waist comes last, and the variations necessary are made as per dot and dash line, always endeavoring to take out larger vees where there is extra prominence to provide for, and vice versa.

The outline used on this diagram is of an apron riding skirt that is both popular and successful.



Cutting Riding Skirts by Model Patterns

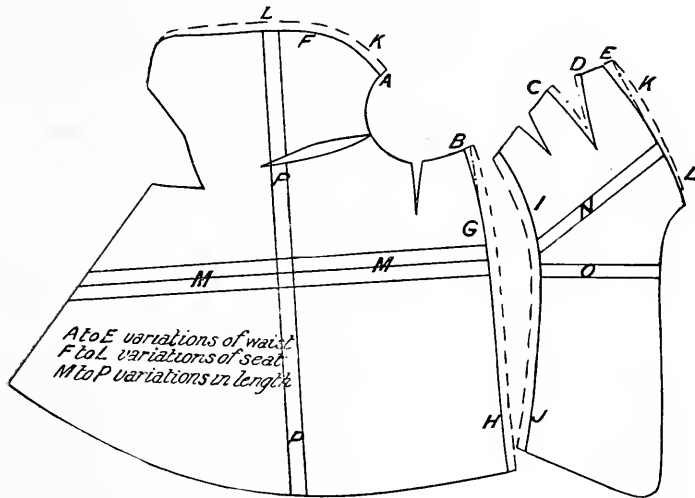

Ride Astride Skirt

This diagram will produce a pattern to fit a lady measuring 24 inches waist, 40 inches hips, 39 inches side length.

Variations may be made as follows:

In length add to or take off from the bottom.

In size of waist, alter the size of the V-s at the waist, enlarging or reducing them as the waist is smaller or larger.

In the size of hips, alter at sideseam. In making variations for the side of hips, be careful to make the size of waist correct.

Instruction for Drafting

Backpart

Draw a straight line from A to B and measure $41\frac{3}{4}$ inches. Square line from A to K and measure from A to C $3\frac{3}{8}$, to D $3\frac{1}{4}$, to E $4\frac{3}{8}$, to F $6\frac{1}{2}$, to G 8, to H $10\frac{1}{2}$ to I 13, to J $20\frac{3}{8}$, to K $26\frac{3}{8}$ inches.

Square down from C, D, E, F, G, H, I, J and K.

L from A is $7\frac{1}{2}$ inches.

M from C is $2\frac{1}{2}$ inches.

N from D is $2\frac{1}{8}$ inches.

O from E is $1\frac{7}{8}$ inches.

P from E is $5\frac{1}{4}$ inches.

Q from F is $1\frac{1}{4}$ inches.

R from G is $\frac{7}{8}$ inch,

S from G is $4\frac{1}{8}$ inches.

T from I is $5\frac{1}{2}$ inches.

U from J is 15 inches.

V from K is $36\frac{3}{8}$ inches.

Connect points as represented and finish the backpart.

Frontpart

Draw a straight line from A to B and measure $41\frac{3}{4}$ inches. Square line from A to 7 and measure from A to 1 $\frac{7}{8}$, to 2 $5\frac{3}{8}$, to 3 $15\frac{7}{8}$, to 4 $20\frac{1}{2}$, to 5 $23\frac{1}{4}$, to 6 $30\frac{1}{8}$, to 7 $36\frac{3}{4}$ inches. Square down from points 1, 2, 3, 4, 5, 6 and 7.

L from A is $7\frac{1}{2}$ inches.

8 from I is $2\frac{7}{8}$ inches.

9 from 2 is $1\frac{1}{8}$ inches.

10 from 3 is $3\frac{7}{8}$ inches.

11 from 3 is $17\frac{3}{8}$ inches.

12 from 4 is $3\frac{3}{8}$ inches.

13 from 5 is 5 inches.

14 from 6 is $15\frac{3}{8}$ inches.

15 from 7 is $34\frac{1}{4}$ inches.

Connect points as represented and finish the frontpart.

W-X-Y-Z is an 8 inch square gusset.

This ride astride skirt is cut in five parts: two fronts, two backs, and an 8 inch square gusset. Opening is arranged at left side seam and in this is a pocket inserted.

One-Quarter inch seam are allowed.

Ride Astride Skirt

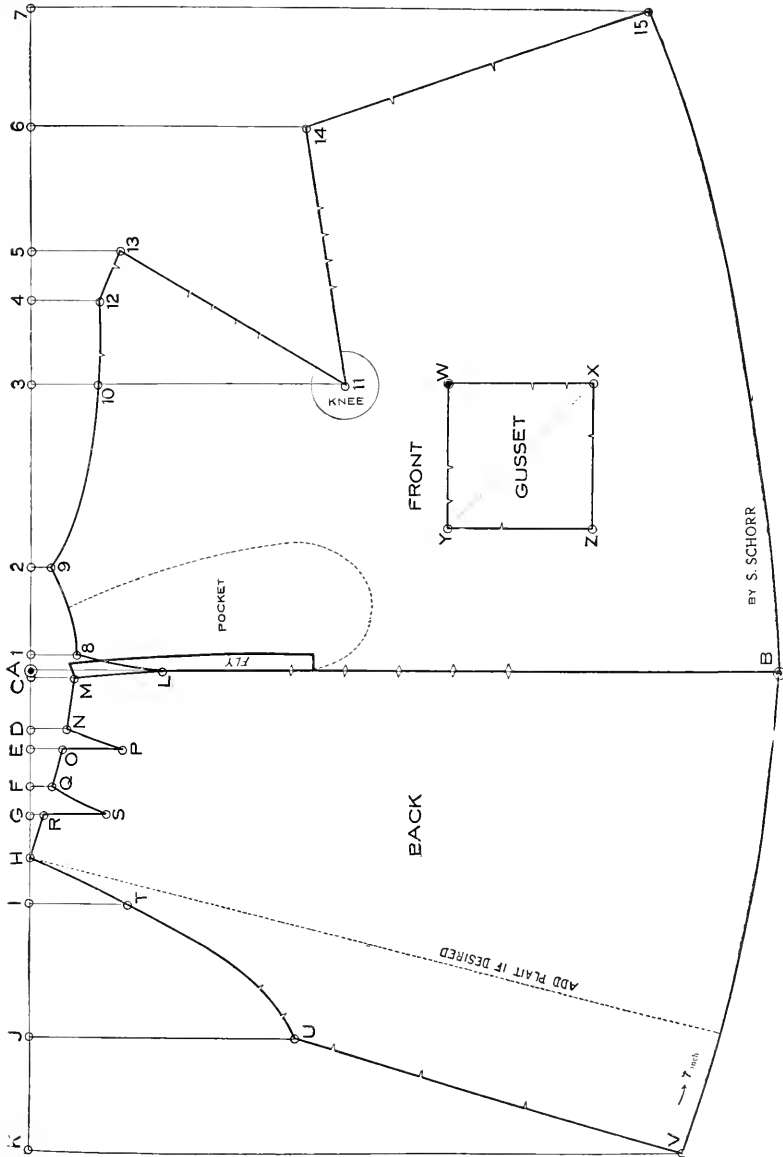

Making Ride Astride Skirts

In cutting from the pattern, a reduced model of which is here placed before the reader, you will make what variations in measurement are necessary, and leave on what inlays will be useful in case extra width or length is required here or there; above all, be sure to locate all balance-marks, either by nicks, or by placing mark-threads at various points instead. Perhaps of more importance than the balance-marks are those lines indicated by AA and BB in Diagram 1. This diagram represents the front and back pieces, and here we have illustrated the marking of inlays and balance-marks; and, as just mentioned, the lines AA and BB are two highly important points for consideration: the former defines the amount of material or spring which is allowed in order to cause the skirt, when the wearer is off the horse, to fall in graceful folds or plaits and which, during the act of riding, affords sufficient room to permit of ease or comfort without in any way marring the freedom of action which is so essential to the rider while on horseback.

The line of mark-threads, BB, on the front piece, defines the front of skirt when the rider is astride the horse, and follows the lap-cut, C, through the knee point, DD, right to bottom.

We cannot lay too much stress on the importance of care in putting the pieces together, and in sewing the seams; unless these are properly put together you will experience all kinds of trouble, and the wearer of the skirt will never experience that comfort she has a right to expect from the competent tailor.

The first two seams with which we shall deal are the lap-cut, C, and the knee-cut, DD. During the operations of baisting, seaming and pressing these cuts, it is essential you should bear in mind the reason they have been provided and the special function they have to perform. The lap-cut in all styles of riding trains, is provided, in order to obviate a lot of loose material during the act of riding; therefore it requires to be kept short during the whole process of making up, and, in addition to that, it should be kept thin there.

The knee-cut, on the other hand, is provided with the double object of clearing away loose material at one place and to give length or looseness at another; thus the part of diagram 1 marked with a cross, both front and back, is the leg-seam of this particular and when DD is sewn together, as we illustrate it at Diagram 2, a considerable prominence or length is given at the point indicated by the star. This will now form a receptacle for the knee, while the leg cut, C, just in the act of being sewn, will shorten and keep clean, or, in other words, free from looseness in that part of the front.

The other waist-cuts are also put there with a double object: first, to afford spring over the hip, and, secondly, to obviate the necessity for a lot of drawing in along the waist line.

Reference of diagram 2 will show you how the sewing of the cut, C, has a tapering off at its lower end. In sewing the other waist cut this feature must be general, and when pressing the seams open be sure you disperse the loose material at bottom with the iron, so as to throw it downwards over the round of seat.

Just above EE, on Diagram 1, you will notice balance-marks, which should be kept together when the seams are being joined. F is the linen stay to strengthen placquethole. G being a facing of cloth which can either be left on when cutting out or sewn on afterwards.

We come, now, to what is, perhaps, the most important item in the make-up of this style of skirt, viz., the insertion of the piece shown at Diagram 3. The object of this is to give spring at the crutch. You will notice a series of notches in the little square of cloth represented by Diagram 3. On the front and back halves of skirt you will find notches to correspond, a single notch at seat-seam, a double one at front or lap-seam. Sew this piece in strongly and press the seam well open.

Diagrams 4 and 5 show these notches placed together, so that when all four sides are joined we obtain a considerable amount of stride in consequence of its insertion.

In the absence of a lining at crutch, the seams of the piece inserted ought to be felled down to keep them from rising or doubling over.

Diagram 5 shows the front and back pieces joined together at what might be called the leg seam, L being the piece shown at diagram 3, sewn to one-half of the train H I shows the same piece sewn into the front of skirt only.

At J and K, diagram 5, we have the notches of diagram 3 fitting exactly those on front and back pieces shown at Diagram 1 and 2.

An important point for consideration is that shown at M Diagram 5 This gives the position of knee, and should be well worked out to give shape and freedom at the part, while for the purpose of strengthening, a piece of linen might be felled on there.

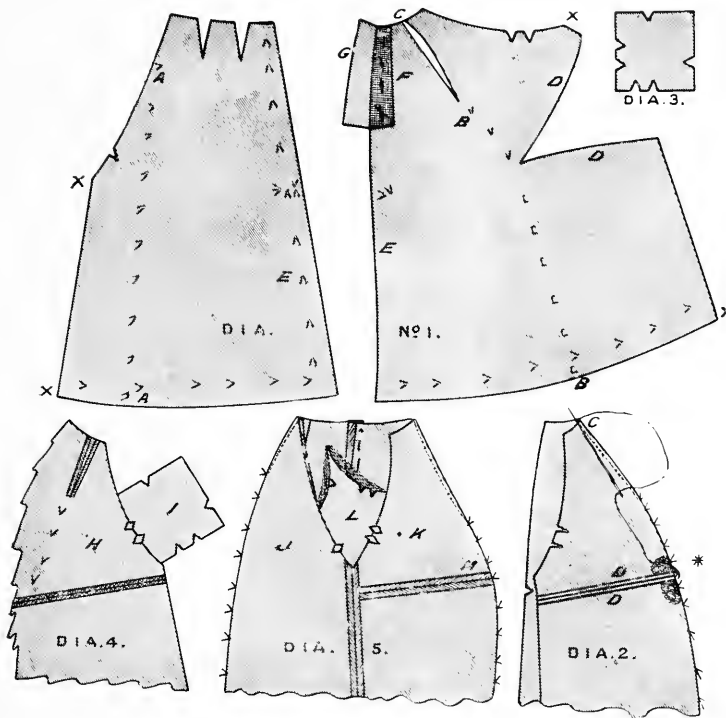

The waist can be finished off with an ordinary band, or the top turned in and stitched; in either case, be sure not to make the waist measure over tight; a little freedom is preferable in these riding skirts.

The placquet can be finished off as in the case of the ordinary skirt; hooks and eyes or patent socket fasteners can be used. The turn-up at bottom should be well pressed, and any looseness of material there well shrunk before the upturn is fastened along its upper edge; whether this is done by felling the cloth or by machine stitching through the outside of skirt.

If thought advisable, the front of skirt can be lined through, and the other seams felled down, or you may dispense with the linings and treat all seams by felling; indeed, where the skirt is made from firm edge material this latter plan is the best.

Riding Coat

By Direct Short Measure System

No Seams allowed

(How to take measurement to this system see page 292.)

Measures

Around Bust 40 inches.
 Around Waist 26 inches.
 Around Hips 41 inches.
 Back scye depth $7\frac{1}{4}$ inches.
 Back waist length $15\frac{1}{2}$ inches.
 Across back 14 inches.
 Over shoulder $16\frac{1}{4}$ inches.

Front shoulder $12\frac{1}{4}$ inches.
 Front waist length $23\frac{1}{2}$ inches.
 Bust depth 15 inches.
 Side waist length $21\frac{1}{4}$ inches.
 Across Chest 15 inches.
 Across Bust 19 inches.
 Sleeve length 18 inches.

- 1 Draw a straight line from 1 to 5,
- 2 from 1 is the back scye depth, in this case $7\frac{1}{4}$ inches.
- 3 from 1 is the back waist length, in this case $15\frac{1}{2}$ inches.
- 4 from 3 is 6 inches.
- 5 from 2 is the full length, in this case 44 in.
- 6 from 2 is the half across back, and $\frac{1}{4}$ inch more, in this case $7\frac{1}{4}$ inches.
- 7 from 2 is $\frac{1}{4}$ full bust measure plus $\frac{1}{2}$ inch, in this case $10\frac{1}{2}$ inches.
- 9 from 2 is the half around bust measure and 1 inch more, in this case 21 inches.
- 8 from 9 is the average chest measure, consisting of half across Chest measure ($7\frac{1}{2}$) and half across Bust measure ($9\frac{1}{2}$) added together and divided in half, in this case $8\frac{1}{2}$ in.
- 10 from 9 is one-quarter of line 2-9.
- 11 is located by drawing a square line down from 7.
- 12 from 1 is $\frac{1}{8}$ Full Bust measure, in this case $2\frac{1}{2}$ inches.
- 13 from 12 is $\frac{3}{4}$ inch on line squared up from 12.
- 14 from 6 is 1 inch less than the Back Scye-depth measure, in this case $6\frac{1}{4}$ inches.
- 15 from 14 is $\frac{1}{2}$ inch.
- 16 from 3 is 1 inch.
- 17 is located by drawing a line from 1 to 16.
- 18 is about the center of 13-15.
- 19 from 8 is the front shoulder measure less the back neck from 1 to 12.
- 20 from 8 is the over shoulder measure less the width from 17 to 18.
- 21 from 19 is $\frac{1}{4}$ inch less than 13-15.
- 22 from 8 is $1\frac{1}{2}$ inches.
- 23 from 19 is the same as 1-12.
- 24 from 23 is the same as 1-12.
- 25 from 19 is the front waist length measure less the back neck from 1 to 12.
- 26 from 19 is the bust depth measure less the width of back neck from 1 to 12.
- 27 from 19 is the side waist length measure less the back neck from 1 to 12.
- 28 from 16 is one-sixth part of 7-17.
- 29 from 15 is $2\frac{1}{2}$ inches.
- 30 is located by drawing a curved line from 29 to 28 as represented.
- 31 is located by drawing a square line down from 28.
- 32 from 28 is 1 inch.
- 33 from 31 is $\frac{3}{4}$ inch.
- 34 from 27 is $\frac{3}{4}$ inch.
- 35 from 27 is $\frac{3}{4}$ inch.
- 36 is the half-way from 7 to 30.
- 37 is the half-way from 32 to 34.
- 38 is located by drawing a line from 36 through 37.
- 39 from 37 is $\frac{1}{2}$ inch.
- 40 from 37 is $\frac{1}{2}$ inch.
- 41 from 38 is $\frac{3}{4}$ inch.
- 42 from 38 is $\frac{3}{4}$ inch.
- 43 from 11 is $\frac{1}{2}$ inch.
- 44 from 11 is 1 inch.
- 45 from 25 is 2 inches.
- 46 is located by drawing a line from 9 through 45.
- 47 from 26 is $1\frac{1}{2}$ inches.
- 48 is located by drawing a line from 47 parallel with line 9-46.
- 49 from 48 is one-third of the front waist suppression.
- 50 from 49 is the front waist suppression.
- 51 from 47 is the same length as 47-49.
- 52 is located by drawing a line from 49 parallel with line 45-46.
- 53 is located by drawing a line from 51 parallel with line 7-11.
- 54 is located by drawing a line from the middle 3-16 through point 4.
- 55 is located by a square line down from 28.
- 56 is located by drawing a line from the middle of 28-32 through point 33 and is the same length from 32 as 28-55.
- 57 is located by drawing a line from 37 through 41.
- 58 is located by drawing a line from 37 through 42 and is the same length from 39 as 40-57.
- 59 is located by drawing a line from 27 through 43.
- 60 is located by drawing a line from 27 through 44 and is the same length from 35 as 34-59.
- 61 is located by connecting the line 51-53.
- 62 from 61 is $\frac{3}{4}$ inch.
- 63 from 49 is the same length as 51-62.
- 64 from 19 is 1 inch.

Add for single breasted button stand, and shape lapel and bottom as represented.

From centre line to tabe make 6 inches more than from centre line to button, or 10 inches as shown.

Riding Coat

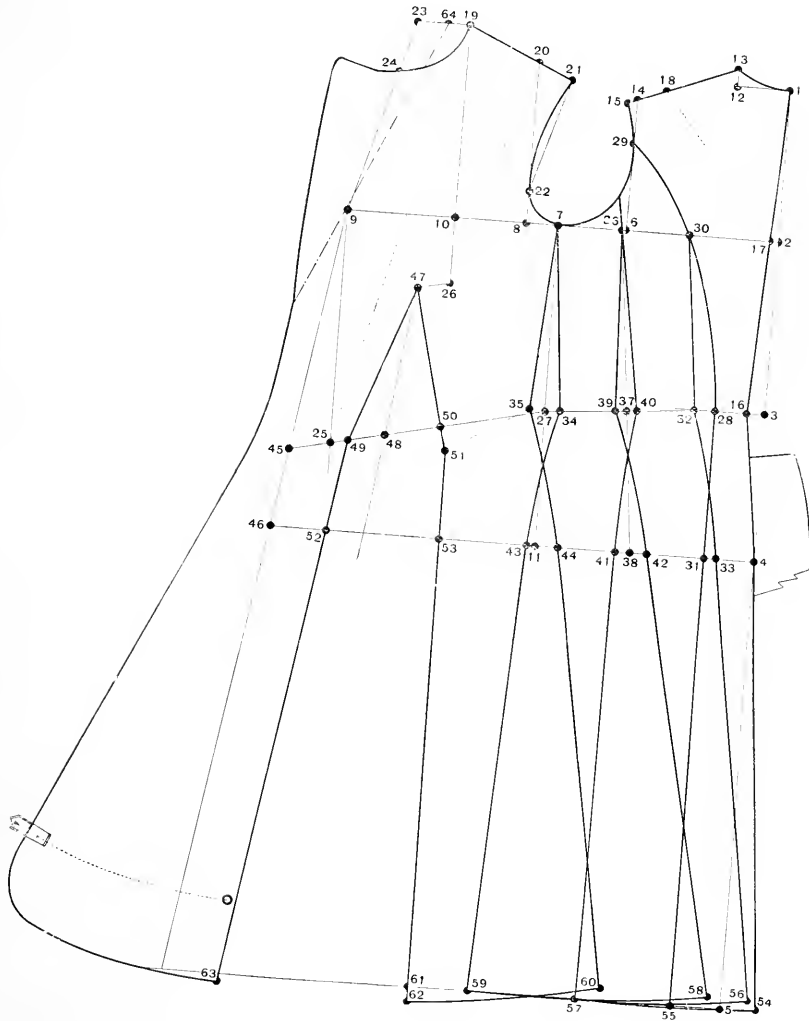

Riding Coat

By Direct Short Measure System

$\frac{3}{8}$ inch Seams are allowed

(How to take measurement to this system see page 292.)

Measures

Around Bust 40 inches.
 Around Waist 26 inches.
 Around Hips 41 inches.
 Back scye depth $7\frac{1}{4}$ inches.
 Back waist length $15\frac{1}{2}$ inches.
 Across back 14 inches.
 Over shoulder $16\frac{1}{4}$ inches.

Front shoulder $12\frac{1}{4}$ inches.
 Front waist length $23\frac{1}{2}$ inches.
 Bust depth 15 inches.
 Side waist length $21\frac{1}{4}$ inches.
 Across Chest 15 inches.
 Across Bust 19 inches.
 Sleeve length 18 inches.

To Draft

A, Square both ways from A as represented.
B from A is the Scye depth measure, in this case $7\frac{1}{4}$ inches.
C from A is the waist length measure, in this case $15\frac{1}{2}$ inches.
D from C is 6 inches.
 Square out lines from B, C and D.
E from B is the half Bust measure plus 4 inches, in this case 24 inches.
F is the center between B and E.
G is the center between E and F.
H from B is the across back measure, in this case 7 inches.
I from A is $5\frac{1}{2}$ inches.
J from I is $2\frac{1}{4}$ inches on line squared out from I.
K from A is the half E-G, in this case 3 inches.
L is located by a line squared out from K.
M from H is 1 inch.
N from M is $\frac{3}{8}$ inch less than B from A on line squared out from M, in this case $6\frac{7}{8}$ in.
O from N is $\frac{1}{2}$ inch on line drawn from L through N.
P is the center of M-N.
S from E is the average chest measure, consisting of half across Chest ($7\frac{1}{2}$) and half across Bust ($9\frac{1}{2}$) added together and divided in half ($8\frac{1}{2}$) plus $\frac{3}{4}$ inch, in this case $9\frac{1}{4}$ in.
R is located by applying the Front shoulder measure from A to L and continued from S to R plus $1\frac{1}{4}$ inches, in this case $12\frac{1}{4}$ plus $1\frac{1}{4}$ is $13\frac{1}{2}$ inches.
T is located by applying the over shoulder measure from B to the middle of the back shoulder L-O and continued from S to T plus $1\frac{1}{4}$ inches, in this case $17\frac{1}{2}$ inches.
U from R is $\frac{3}{8}$ longer than L-O on line drawn from R through T; this $\frac{3}{8}$ inch is to be taken off at point R as represented.
V from S is 2 inches.
W from R is 2 inches.
X from W is $\frac{3}{4}$ inch more than K from A, in this case $3\frac{1}{4}$ inches.
Y is located by a line squared down from E.
Z is located by a line squared down from F.
I is located on line squared down from F by applying the Side waist length measure

A to L and continued from R to I plus $1\frac{1}{4}$ inches, in this case $22\frac{1}{2}$ inches.
2 is located on line squared down from E by applying the Front waist length measure from A to L and continued from R to 2 plus 1 inch, in this case $24\frac{1}{2}$ inches.
3 from C is $1\frac{1}{2}$ inches.
4 from D is 1 inch.
5 from M is $\frac{3}{4}$ inch.
6 from 5 is $\frac{3}{4}$ inch.
7 from 3 is 6 inches.
8 is located by shaping from 6 to 7.
9 from 4 is $6\frac{3}{4}$ inches.
10 from 7 is $\frac{1}{2}$ inch.
11 from 9 is 2 inches.
12 from F is $\frac{1}{2}$ inch.
13 from I is $\frac{1}{2}$ inch.
14 from 13 is 3 inches.
15 from 13 is $\frac{3}{8}$ inch.
16 from 13 is $\frac{3}{8}$ inch.
17 from 2 is 2 inches.
18 is located on line squared down from G by applying the Bust depth measure from A to L and continued from R to 18 plus $1\frac{1}{4}$ inches, in this case $16\frac{1}{4}$ inches.
19 from 18 is $1\frac{1}{2}$ inches.
20 is located by line drawn from 19 parallel with line E-17.
21 is located by line drawn from 19 parallel with line E-17.
22 from 20 is $\frac{1}{2}$ inch.
23 from 21 is $\frac{3}{8}$ inch.
24 from 22 is 3 inches.
25 from 19 is the same length as 22 from 13.
26 from 23 is 3 inches.
27 from A is the full length desired.
28 is located on line squared out from 27.
29 is located on line squared out from 27.
30 from 29 is $1\frac{1}{4}$ inches.
31 from 22 is the same length as 30 from 25.
32 is about 16 inches below the waist line.
33 from 32 is about 9 inches.

Allow for a single-breasted button stand 2 inches, and for a vent at the back about 2-3 inches, and finish the draft as represented.

Riding Coat

By Direct Short Measure System

$\frac{3}{8}$ inch Seams are allowed

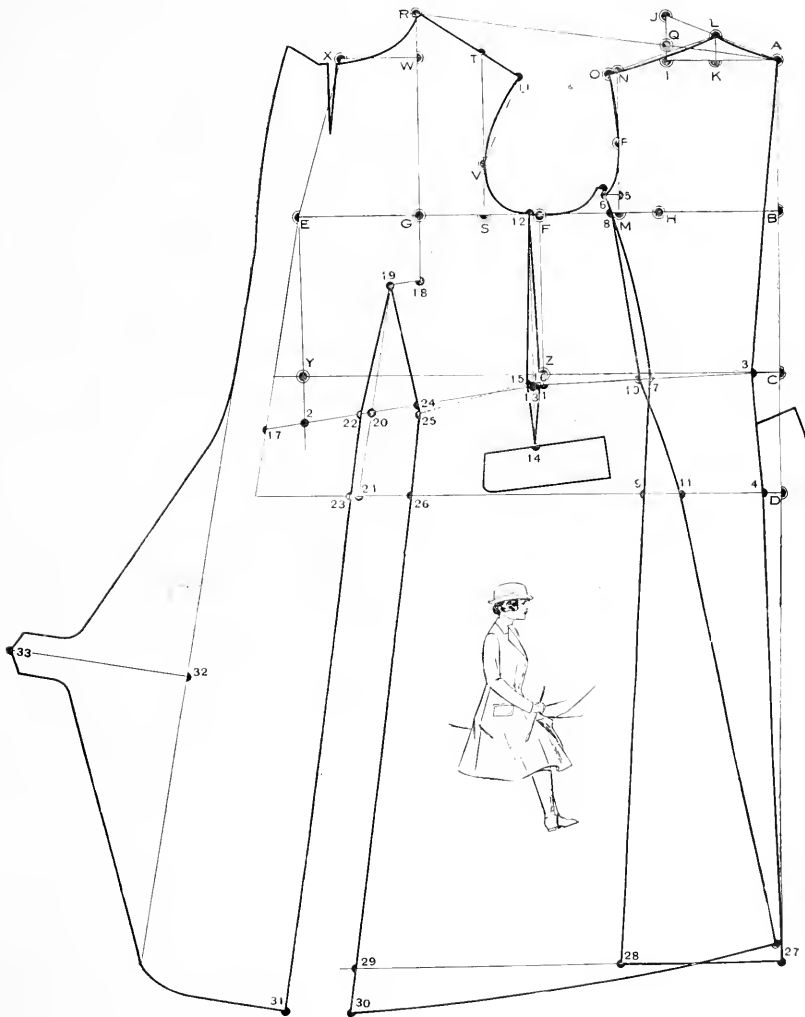

Pantaloen Skirt

The Pantaloen or Harem Skirt consists of the divided hose and outside skirt. Both garments may be made from the same material, although the divided part is frequently made from a thinner stuff.

The outside skirt is illustrated with diagram **A** is the newest style of ladies outdoor walking skirt.

Diagram of Divided Hose or Pantaloen

Measures:

Waist 24 inches Side length 42 inches
Hips 40 inches Rise 12 inches

Forepart

- 1 Draw a straight line from 1 to 4.
- 2 from 1 is the Hip line 6 inches always.
- 3 from 1 is the Rise measure and 2 inches more, 14 inches.
- 4 from 1 is the side length 42 inches.
Square out lines from 1, 2, 3, 4 as represented.
- 5 from 1 is $\frac{1}{8}$ Hip measure less $\frac{1}{2}$ inch, $4\frac{1}{2}$ inches.
- 6 from 2 is $\frac{1}{8}$ Hip measure, 5 inches.
- 7 from 3 is $\frac{1}{8}$ Hip measure, 5 inches.
Connect points 5-6-7.
- 8 from 7 is the half distance of 3-7 and $\frac{1}{2}$ inch more, 3 inches.
- 9 is located by squaring down from 8.
- 10 from 6 is $\frac{1}{4}$ Hip measure, 10 inches.
- 11 from 9 is $\frac{1}{2}$ Hip measure, 20 inches.
- 12 is located by drawing a line from 11 through 10.

5-12 should be $\frac{1}{4}$ waist; take out the balance in V-s as represented.

13 from 7 is half distance of 7-8, $1\frac{1}{2}$ inches.

Shape fork as represented.

14 from 12 is the side length 42 inches.
Shape bottom as represented.

Underpart

15 from 10 is $1\frac{1}{2}$ inches,

16 is located by drawing a line from 14 through 15 and is the same length as 14-12.

17 from 5 is $\frac{1}{2}$ inch.

18 from 17 is 3 inches on line drawn from 8 through 17.

17-18 should be $\frac{1}{4}$ waist; take out the balance in V-s as represented.

19 from 8 is 4 inches.

Connect points 9-19.

9-19 is the same length as 9-8.

Shape fork as represented.

Allow for all seams.

The Bearers

The diagram marked **B** shows that the top of the forepart has been reduced 3 inches.

The underpart, diagram **C** shows the bearer is $12\frac{1}{2}$ inches at the sideseam or opening and the depth at the fork is 3 inches.

The bearer is shaped as shown on the diagram, and is sewn with sideseam of forepart; the underpart forms the fall at the back or, in other words, the backpart of a lady's divided skirt is the reverse of a man's pair of whole-fall trousers.

Pantaloon Skirt

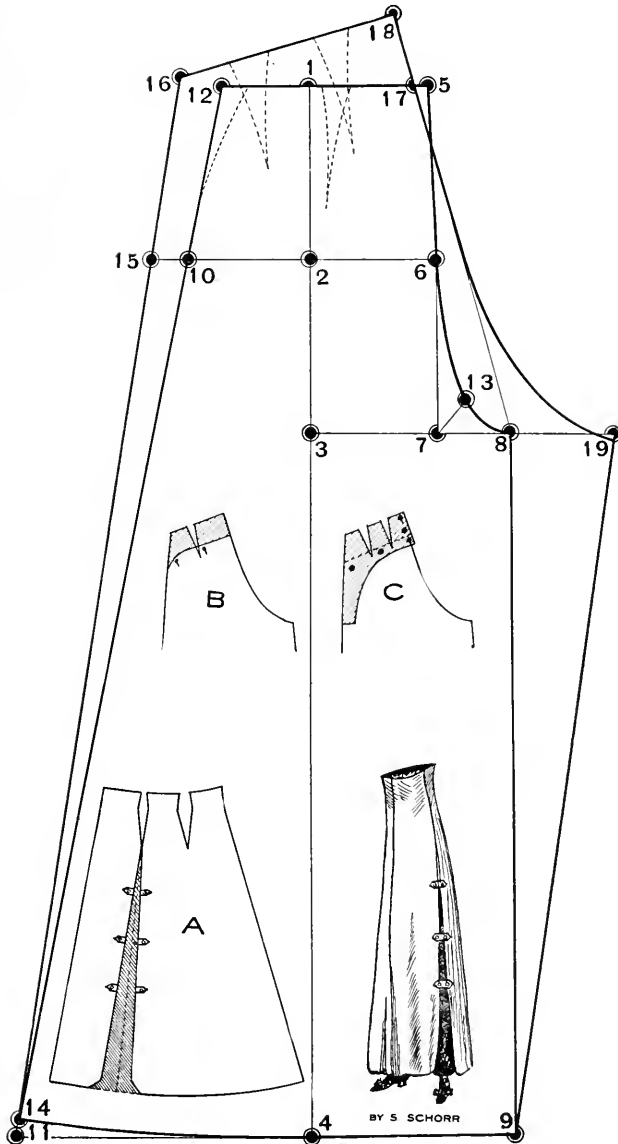

Ladies Riding Breeches

Measures

Side length 40 inches, Rise (from waist to seat of chair) 12 inches, Leg length (difference between side length and rise) 28 inches, Full length as desired, say 36 inches, Waist 24 inches, Seat 42 inches, Knee 15 inches, Small knee 13 inches, Calf 15 inches, Bottom (at the full length of breeches) 12 inches.

(Measurement of Knee, Small knee, Calf and Bottom are taken by the lady herself.)

To Draft

Forepart

A. Square both ways from A as represented.
B from A is the Rise measure, in this case 12 inches.

Square out from B as represented.

C from B is $\frac{1}{4}$ full seat measure, in this case $10\frac{1}{2}$ inches.

D from B is $\frac{1}{3}$ full seat measure plus $\frac{1}{4}$ inch, in this case $14\frac{1}{4}$ inches.

E from B is the center of B-D less $\frac{1}{8}$ inch, in this case 7 inches.

F is located by a line squared up from C.

G from C is the same as E from B, in this case 7 inches.

H from C is the half of C-D plus $\frac{1}{4}$ inch, in this case $21\frac{1}{8}$ inches.

Shape D-H-G as represented.

Square both ways from E as represented.

I from E is 3 inches.

J from E is 9 inches.

K from J is 1 inch on line squared out from J.

L is located by drawing a line from I through K and longer.

M from L is the half leg length measure, less 1 inch, in this case 13 inches.

N from M is $2\frac{1}{2}$ inches.

O from N is $3\frac{1}{2}$ inches.

P from about the middle of the waist line A-F down is the full length desired plus 1 inch, in this case 37 inches.

Q from M is $\frac{1}{4}$ Knee measure, in this case $3\frac{3}{4}$ inches.

R from N is $\frac{1}{4}$ Small knee measure, in this case $3\frac{1}{4}$ inches.

S from O is $\frac{1}{4}$ Calf measure, in this case $3\frac{3}{4}$ inches.

T from P is $\frac{1}{4}$ Bottom measure, in this case 3 inches.

U from M is $\frac{1}{4}$ Knee measure less $1\frac{3}{4}$ inches, in this case 2 inches.

V from P is $\frac{1}{4}$ Bottom measure less $1\frac{1}{4}$ inches, in this case $1\frac{3}{4}$ inches.

W is located by drawing a line from U to V.

X is located by drawing a line from U to V.

Y is the center on line drawn from U to B.

Z from Y is 1 inch.

1 from B is $\frac{1}{2}$ inch.

2 from A is $\frac{1}{12}$ of the full waist measure, in this case 2 inches.

3 from F is $\frac{3}{4}$ inch.

Draw a line from 2 to 3.

4 from 3 is $\frac{1}{8}$ full waist measure plus $\frac{1}{4}$ inch, in this case $3\frac{1}{4}$ inches.

5 from 2 is $\frac{1}{8}$ full waist measure plus $\frac{1}{4}$ inch, in this case $3\frac{1}{4}$ inches.

Form the dart about 4 inches deep.

Finish the forepart as represented.

Underpart

6 from G is 1 inch.

Draw a line from D through 6 and longer.

Sweep out from 2 pivoting at U.

7 is located by a line squared out from line D-6 to a point on line sweeped from point 2, where it meets point 8.

8 from 7 is 1 inch more, than 3 from 2, in this case $9\frac{1}{2}$ inches.

9 from P is 1 inch.

10 is located by a line squared out from 9.

11 is located by a line squared out from 9.

12 from D is $1\frac{3}{4}$ inches.

13 from 12 is $\frac{1}{4}$ inch.

14 from Q is $\frac{3}{4}$ inch.

15 from R is $\frac{1}{2}$ inch.

16 from R is $\frac{1}{2}$ inch.

17 from 10 is $1\frac{3}{4}$ inches.

18 from 1 is $2\frac{1}{2}$ inches.

19 is located by measuring the knee measure plus 1 inch from Q to U and 14 to 19, in this case 16 inches.

20 is located by measuring the small knee measure plus 1 inch from R to W and 15 to 20, in this case 14 inches.

21 is located by measuring the Calf measure plus 1 inch from S to X and 16 to 21, in this case 16 inches.

22 is located by measuring the bottom measure plus 3 inches from T to V and 17 to 22, in this case 15 inches.

23 from 9 is 1 inch.

24 from 9 is 1 inch.

25 from N is $1\frac{1}{4}$ inches.

26 from 19 is 1 inch.

27 from 8 is $\frac{1}{8}$ full waist measure plus $\frac{3}{4}$ inch, in this case $3\frac{3}{4}$ inches.

28 from 7 is $\frac{1}{8}$ full waist measure plus $\frac{3}{4}$ inch, in this case $3\frac{3}{4}$ inches.

29 from 7 is $\frac{1}{4}$ inch.

Allow for button stand $1\frac{1}{2}$ inches outside of 26-22.

Finish the underpart as represented.

One-Quarter inch seams are allowed.

Ladies Riding Breeches

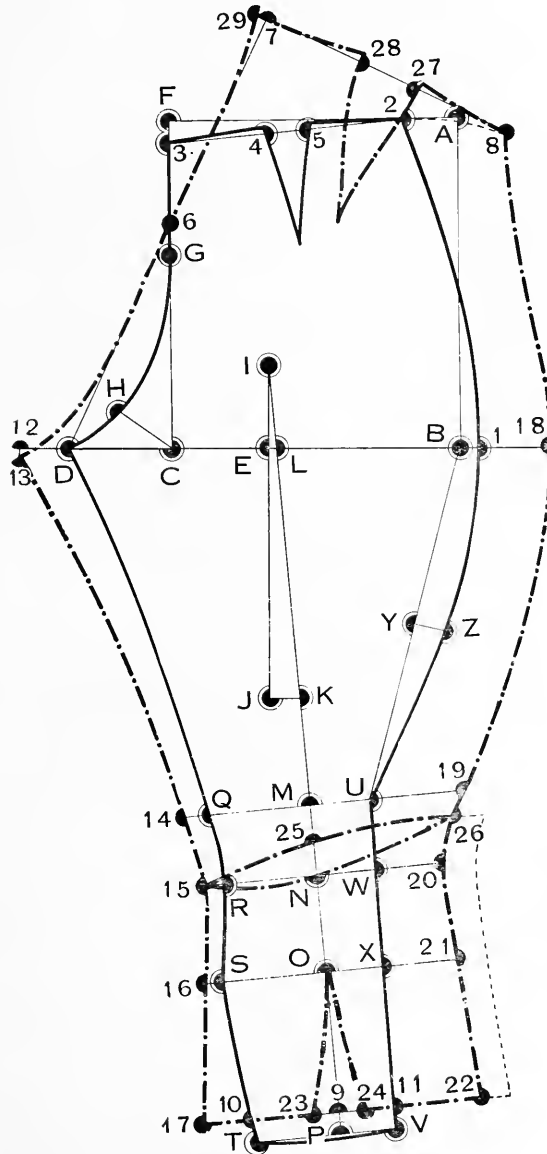

Leggings

Measurement: Small knee 13 inches, Calf 15 inches, Length $13\frac{1}{2}$ inches.

(No seams or turnings are allowed.)

A. Square both ways from A as represented.

B from A is the length, in this case $13\frac{1}{2}$ in.
Line A-B is the front center of leg.

C from A is 3 inches.

Square out lines from B and C as represented.

D from A is the half Small knee measure, in this case $6\frac{1}{2}$ inches.

E from C is the half Calf measure, in this case $7\frac{1}{2}$ inches.

F is located by a line squared down from B.

Curve back line D, E and $\frac{1}{4}$ inch inside F as represented.

G from B is $1\frac{1}{2}$ inches.

H from G is 3 inches for turn over.

I from A is 3 inches for turn over.

Curve line of bottom from $\frac{1}{4}$ inch inside F through G, towards H.

Curve line I-H.

The button stand position is shown by a heavy line 1 inch inside the front center line A-B.

Mark holes and buttons in the position shown on the diagram.

Curve the top line in the direction suggested.

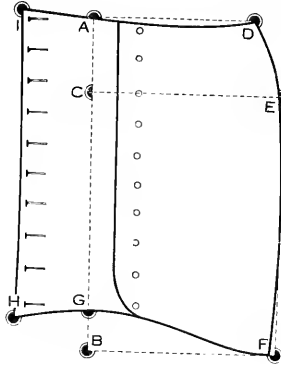

Gaiters

Measurement: Height of Instep $3\frac{1}{4}$ inches, Instep to Heel 6 inches, Heel to Front 8 inches, Length $14\frac{1}{2}$ inches, Small knee 12 inches, Calf 13 inches, Ankle 8 inches.

(No seams, or turnings in, allowed.)

A. Square both ways from A as represented.

B from A is the Length measure, in this case $14\frac{1}{2}$ inches.

C from A is 3 inches.

D from B is the Height of Instep measure, in this case $3\frac{1}{4}$ inches.

E from D is 1 inch.

Square out lines from B, C and E as represented.

F from A is the half Small knee measure, in this case 6 inches.

G from C is the half Calf measure, in this case $6\frac{1}{2}$ inches.

H from E is the half Ankle measure, in this case 4 inches.

I from D is the Instep to Heel measure, in this case 6 inches.

J from I is the Heel to Front measure, in this case 8 inches.

K from J is 1 inch on line squared out from J.
Draw a line from K to D.

Form outline as represented.

L is the center of E-H.

Square both ways from L as represented for the edge of button stand.

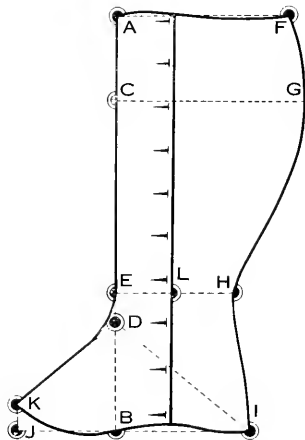

PART NINE

PRACTICAL TAILORING

In dealing with the making up of ladies' coats we must take into consideration the fact that we have the prominence of the bust to clothe, the waist to define in varied degrees, and the hips to drape in graceful lines consonant with fashion's fleeting eccentricities, in order that our clients may be up to date.

In order to obtain these results, special attention is given to the materials from which ladies' coats are made, and also the manipulation of seams and shoulders, in order that the anatomical requirements may be met.

Begin the thread-marking inlays, position of pockets, buttons, etc. The hollow of sidebody and waist of forepart needs to be shrunk, and the inlays strained out at these parts in order that the seams may lay fair. Insert pockets, and waist front dart, keeping balance marks fair.

The canvas in shoulders is best put in on the bias, with a straight piece down fronts fastened to dart-seam. The canvas should be shrunk before insertion. An extra piece of bias canvas is put through shoulders, and should be padded on to under canvas rather easy. This extra canvas should on no account be stitched on by the machine.

Both canvases through shoulders are slashed and wedged alternately at shoulder and scye, in order that a shapely shoulder may be obtained. When coat is of the seam over shoulder style, the under canvas is seamed through shoulders, which assists in the shaping of the shoulder, and it is arranged to be well on bias at the scye. A bridge is put across crease-row and kept fairly close. Pad lapels to a nice curl. Steady fronts with staytape, which is neatly felled on, and press out carefully.

Bast on facings, allowing plenty of length to linings, ease in shoulders, etc.

The lining of tight-fitting coats require more length in waist on account of the suppression at that part, and then the prominence of hips.

Fasten facings to canvas up front dart and fell linings neatly in.

The waist of panel backs is best shrunk to clear away the loose material formed at that part.

The use of wadding should be avoided as much as possible on making ladies' coats; thinness and neatness are the prevailing features of ladies' tailoring.

It is always well to take the under collar from the bias of the cloth, as it is much easier to stretch and shrink it than when cut in any other way. The under collar is the part in which the form has introduced. The top collar is best cut from the straight, with the center of the back placed on the double edge; this avoids a seam, and also provides the stripes running in an effective manner. Once the form has been obtained in the under collar it is seldom very difficult to get the top collar to fit properly.

In matter of putting on the collar depends very largely upon the style of cut; what is known as the crooked cut is very different from the straight cut of neck. For a straight cut a much longer collar is required, whilst for a crooked cut a shorter collar is required. We will endeavor to describe the moderate cut. For a moderate cut shoulder the collar should be put on slightly short across the back neck, and it should be pulled on in the hollow of the gorge, and kept slightly short just a front. This is a rule which is followed in all the best classes of trade.

The sleeves require to be made up as thin as possible. When finished with a vent at the cuffs be sure of get run of cuff in harmony with hindarm-ream. Baist a piece of fine canvas through cuff, turn over facing and serge along, and stitch cuff.

The selection of buttons forms another interesting feature of ladies' coats, some styles having large buttons, either plain or fancy makes.

It is always best to study the purpose garment is intended for before selecting buttons; they are included in the ornamental features of ladies' coats, and must harmonise with the other parts.

Ladies' coats require special care when pressing. Very little water must be used, for on no account must a ladies coat be "boiled". It is best to use a piece of linen, and by applying a little moisture, and using a good hot iron; press edges from inside if possible, and all other parts press thoroughly, then take a damp-rag well wrung out and remove gloss by lightly applying iron to rag. What is termed by tailors a "half-damp-rag", together with the use of a small iron, is the best plan to remove the gloss in the damping off of a ladies' coat.

The linings of ladies' coats are mostly of fancy makes, or of silk, and very often either white or some other delicate color. These lining must be touched as little as possible with the iron for fear of soiling or destroying their finish.

When light linings are used (white silk, for instance) the coat is finished bar the insertion of the lining, being pressed and damped off. The lining is made up, baisted in, and lightly felled; by this means it is kept clean.

PART TEN

FITTING

Have a method for trying on, just as you have a system for cutting. This is a most important feature.

There are different methods of trying on a garment, and the plan to follow must, to a large extent, be governed by circumstances.

Let us describe the two most popular: First, there is the skeleton baste, in which the various seams are basted and turned on one side; the canvas is put in, and usually one sleeve is basted in. The under-arm-seam is basted on the outside to facilitate fitting and prevent drag.

This style of preparation is often adopted when two or three try-ons are employed.

The other style is the forward baste. In this all the seams are sewn with the exception of the under-arm-seam, the sleeves, shoulders, and collar. The first row of sewing is put in the front edge, by which we mean the facing is seamed on; the linings are basted over, all manipulation is put in. This is the plan usually followed where only one try-on is employed, as it is certainly the best to give a good idea of fit and finish to both fitter and wearer.

At this point we will utter a word of warning: Never attempt to baste garments up by machine, for there is very little time saved by so doing, and you cannot ensure the same accuracy as when basting by hand.

The garment having been prepared for fitting, and examined to see if it is being made up to order, we await the wearer with confidence.

On her arrival the first thing to be done is to get the garment properly on, carefully adjusting it at the top of back-neck, and arranging the underwear so that there is no accumulation of material round the scye. This being done, bring the fronts well over, but before joining the edges together, notice the general hang of the garment. If there is a tendency to drop away in front, the front shoulder is too long; if there is a dragging from the neck downwards, the front is too short; both of which effect should be rectified by ripping the sleeves out and the shoulders, and arranging the balance so that it is in harmony with the wearer's figure at shoulder-seam.

Now take the two front edges and pinch them together between the finger and thumb, and pin the two foreparts together. This being done, make a mark with chalk down the front where the pins are. Also make a mark round the waist. This being done, proceed to examine the various points of the garment in proper sequence.

The back may be done by locating four points. 1-The top of back neck. 2-The back scye. 3-The back waist. 4-The lower part of the back. Next comes the sleeve, and with this we have to note that it is the correct length, width and balance. After the sleeves comes the front, and here, again, we have four points, viz., the top of forepart at neck; the shoulder and front of scye; the front at waist, and the lower part of the front. If this points are gone over systematically, then every part of the garment will come under examination.

In marking alterations, do not hesitate to use pins, or to chalk the existence of a defect. If possible, the garment should be adjusted to wearer's requirements while it is on, and to do this successfully the fitter will require patience and coolness. It is not always easy to tell exactly what is wrong, as sometimes there is a combination of defects, but a study of alterations will give some usefull hints in this matter.

In the matter of trying-on skirts, it is always well to have the seams basted outside, as they are easier to alter. The points to notice in fitting skirts are, balance or hang, fit over hips, and length. It is well to bear in mind that fitting the body is only a small part of the fitter's duty. The real art lies in pleasing the wearer, and giving her what she approves.

It is important that the greatest care should be taken in the cutting, fitting, and manipulation of garment; also it is important that the garment should be carefully examined when finished, to see that all the details are faithfully carried out according to instructions.

The examining of a finished garment is quite as much the work of a master hand as any of the others. When "cocking" a job, a journeyman will soon sum up what a cutter is worth in that direction, and to what extent, if he is so inclined, he can take liberties.

A master hand will take hold of a garment in such a way that it will impress the tailor at once that it is not the first job by a long way that he has examined and that in future he has to be very careful in what state he brings the job to be passed. Whilst, on the other hand the novice or inexperienced man will handle it in an awkward way, as if he were frightened of it. First of all he looks at this, then at that, then at something else; then he comes back again to the first and so on. He does not examine any particular part carefully and methodically.

In examining a garment there should be as much system used as in doing anything else. Begin by examining one part carefully, then another, and so on until the garment is finished. I do not mean that every stitch should be carefully looked into: I think if there is a fair sewing it should be sufficient. Finding fault with every little thing is not examining a job. Finding fault is the easiest thing in the world; everybody can do that; and there is not a job made in the ordinary way but what the cutter can find fault with if he wants.

The perfection of a finished garment does not consist in the smallness or the number of stitches there are in that garment, but in the thought and skill that is put in it in creating a thing that comprises those little things which make a work of art.

First of all in examining a garment, get hold of it in such a way that you create an impression that you know what you are about, and that your desire is not to find fault, but to see a work of art. First of all take the garment in your right hand, place your left hand in the left scye, and see how the front and sleeve hang; see that the canvas and linings are not in too short; that the sleeve hangs fair; reverse the action on to the other side, and examine the same as the other; then put both hands in the scye and see that the collar is on fair; then have a look at the back by holding the garment up, by getting hold of both sleeves at the back; then examine the run of the seams to see that they run is even; that there is no straining where they should be even, and that there is no fulling on of one part when it ought to have been strained. Turn your attention to the inside, and see that the linings are in long in the waist, because if not it will prove detrimental to the fit.

When you are satisfied with these points, and that the sewing is all that is should be, then, for final inspection place it on a form and see how the general fit and hang of the garment is, whether the sleeves are pitched properly, and that they are both the same, with the fulness or platts placed exactly the same on both sides; whether the collar commands the turn, and whether it is too long or too short, and if the collar is of a fancy design, and trimming is carried out according to instructions. See that the run of the smallest part of the waist is correct; that there is no drag or fulness when it should be clean.

PART ELEVEN

ALTERATIONS

In marking alterations, do not hesitate to use pins, or chalk the existence of a defect. If possible, the garment should be adjusted to wearers requirements whilst it is on, and to do this successfully, the fitter will require patience and coolness. It is not always easy to tell exactly what is wrong, as sometimes there is a combination of defects, but a study of the chapter on alterations will give some usefull hints in this matter.

In the matter of trying-on skirts, it is always well to have the seams baisted on the outside, as they are easier to alter. The points to notice in fitting skirts are: balance or hang, fit over the hips, and length.

Alterations arise from errors in size and errors in form. Defects show themselves principally in three ways: creases, folds, twists.

Creases arise from a back of material.
Folds arise from an excess of material.
Twists arise from bad work.

Creases

Creases from neck-point to front of scye (Diagram 1) are caused by an insufficient distance from neck to front of scye; remedy: let out front neck and shoulder at shoulder-point, reducing the shoulder to proper width at scye end.

Creases at side (Diagram 2) arise from insufficient distance from prominence of bust to hips; remedy: let out under the arm and reduce waist to size at back darts.

Crease from side to front (Diagram 3) caused by the front being too small at the bottom, and this probably arises from a too long front shoulder; if so, take off from the front neck and shoulder at the neck-point; but if it is all right at shoulder let out bottom of front.

Creases from top of forearm of sleeve to elbow at back: Take off at the top of the hindarm, and lengthen sleeve at cuff. This is equal to adding on a piece at the top of the forearm.

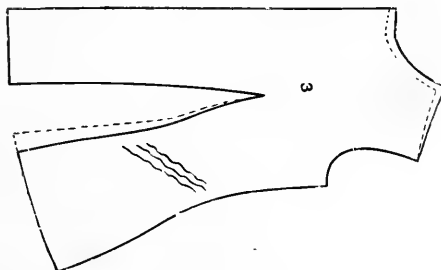
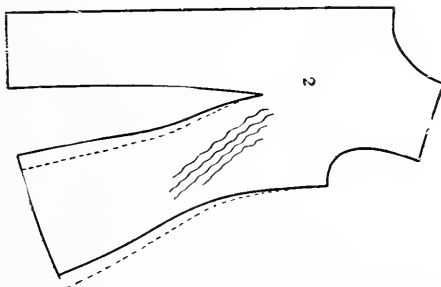
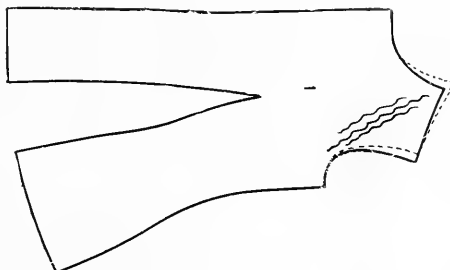

These samples must suffice to illustrate the principle that creases indicate a shortness in the way they run, and to remedy them, more length must be given in the direction they run.

Folds

Folds arise from an excess of material in the opposite way to which they run; those horizontal folds show an excess of length, vertical folds an excess of width. Take the case of a sleeve having several folds at the top of forearm; the remedy for this is to take off a piece from the top of the forearm

Folds over the hips: This is an excess of length produced by the garment being forced upwards owing to a tightness over the hips. The remedy is to let out at the hips, and this will allow the garment to drop into its proper place.

Sometimes this defect arises from a shortness of lining, in which case the lining must be lengthened, or else the jacket must be shortened, and the lining put in the necessary amount fuller. It is always well to remember that the linings should be put in long over the waist.

Folds around the neck: These arise from the lining or facings being put in too narrow. To remedy, hollow out gorge slightly at the shoulder point, but especially let the facing out across the shoulder. The facing should always be put in wider across the shoulders.

Folds across the back: These are caused by too much length in the upper part of the back. The remedy is to shorten the back at the upper part.

Fold from front of scye to prominence of bust: This is perhaps better described as fulness, as the fold is V-shaped. The best way to remedy this is to let out under the arm at the side seam, and take in the back dart, in order to reduce it to the size of waist.

Fulness at front edge: This is caused by the front edge being cut round, and as the round is always relatively longer than the straight, so it is the cause of the fulness. The remedy is to let out at the bottom of front and reduce the size of waist by either enlarging the dart or taking out another dart.

Tight armholes may arise from three different causes; they may be too narrow, they may be too shallow, or they may be too tight on the top. The best remedy for the first one is to let out the underarm-seam: the best remedy for the second one is to lower the armhole; and the best remedy for the third one is to let out at shoulder end. It is not necessary that it should be done on back as well as forepart, as inlays are only left on the forepart as a rule, and that is quite enough for the purpose.

Twisting

Twisted seams are caused by careless work. The seams has not been properly baisted, and the machine has driven the top layer down, and fullled on the lower one. To remedy this the only plan is to rip the seams and sew them so that they go together fairly.

PART TWELVE

SKETCHING

To be able to sketch is of great value to you as a manufacturer, designer, cutter, tailor, salesman, etc. in connection with the womens' wear trade.

You can make yourself more valuable and that means more succes and more money for you.

It is vital importance that each figure should be practiced diligently.

It is well for you to surround yourself with Fashion Magazines and to observe from them the various methods employed by the different artists.

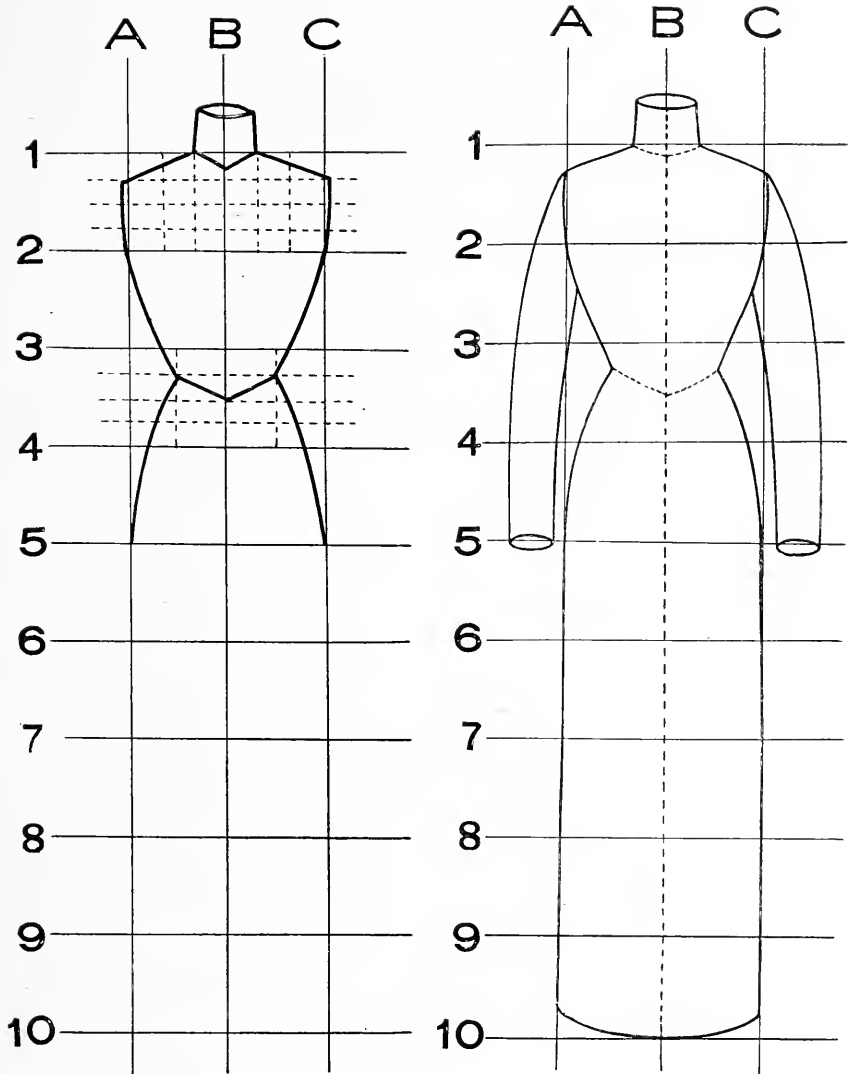

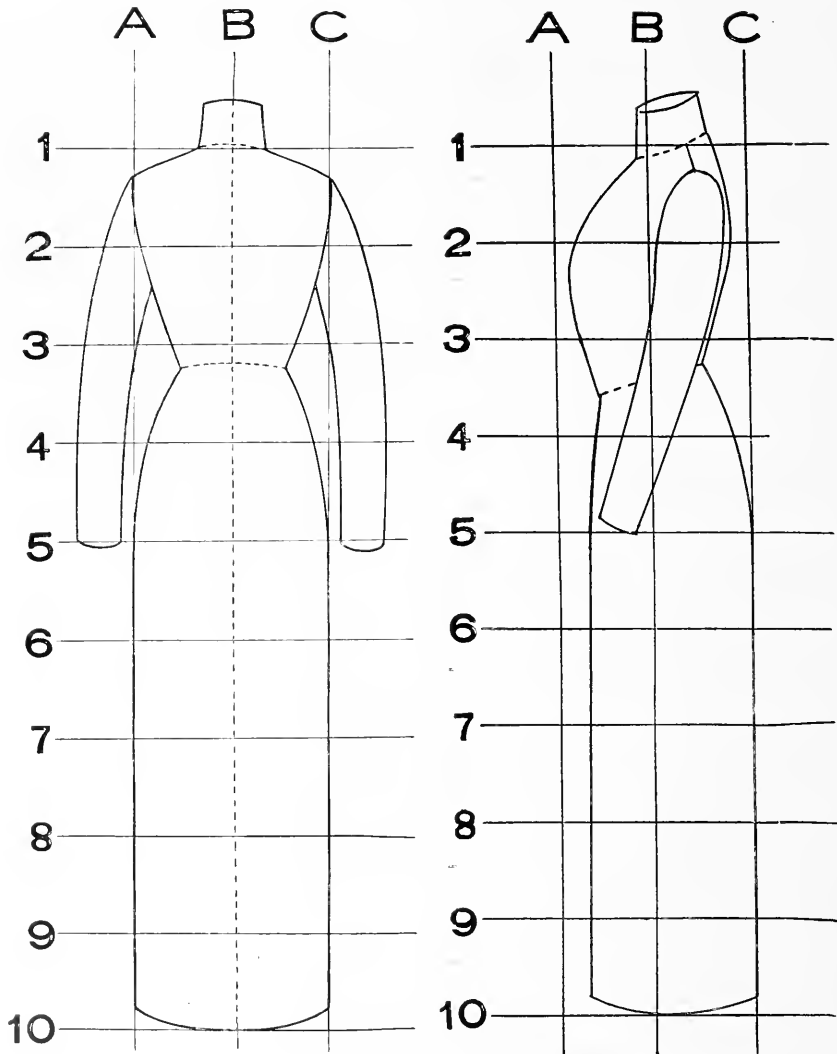

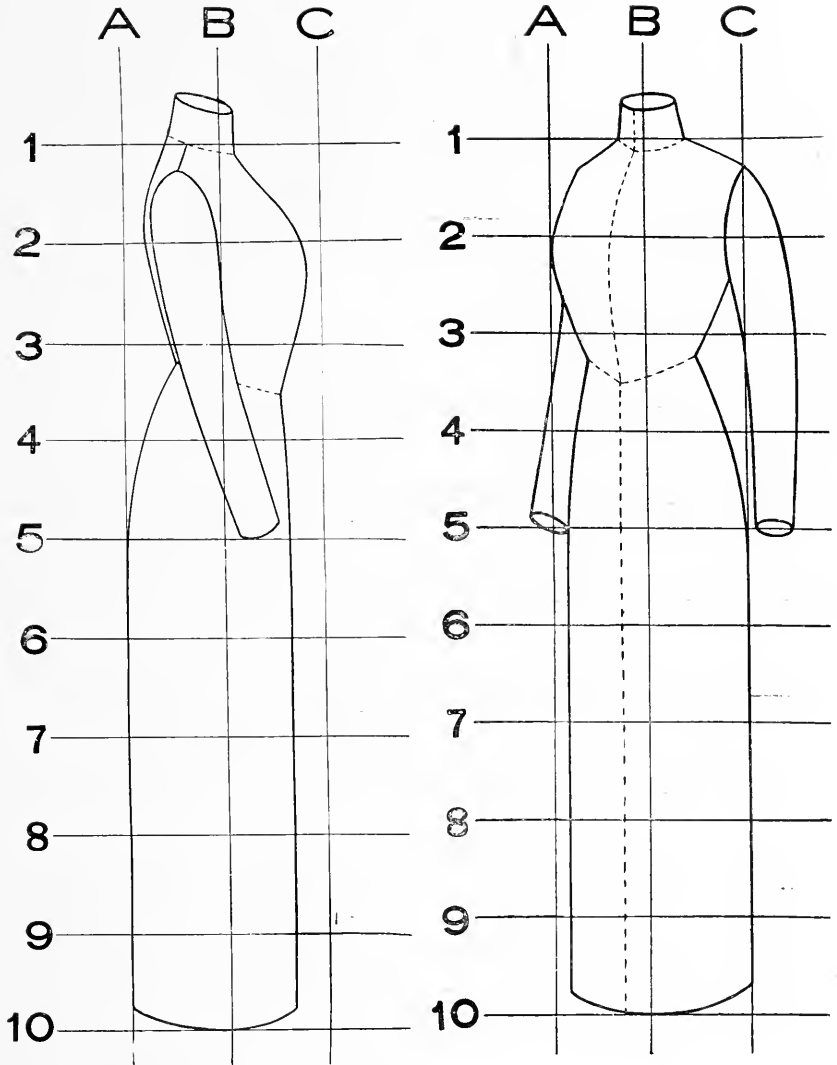

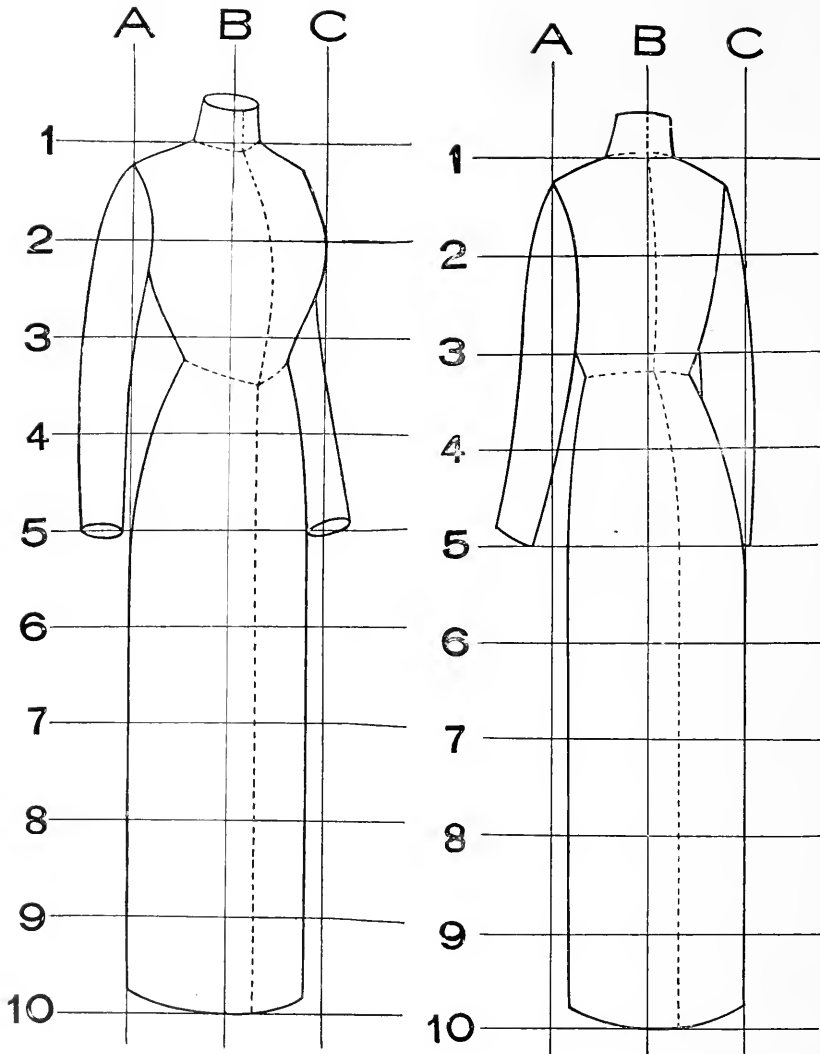

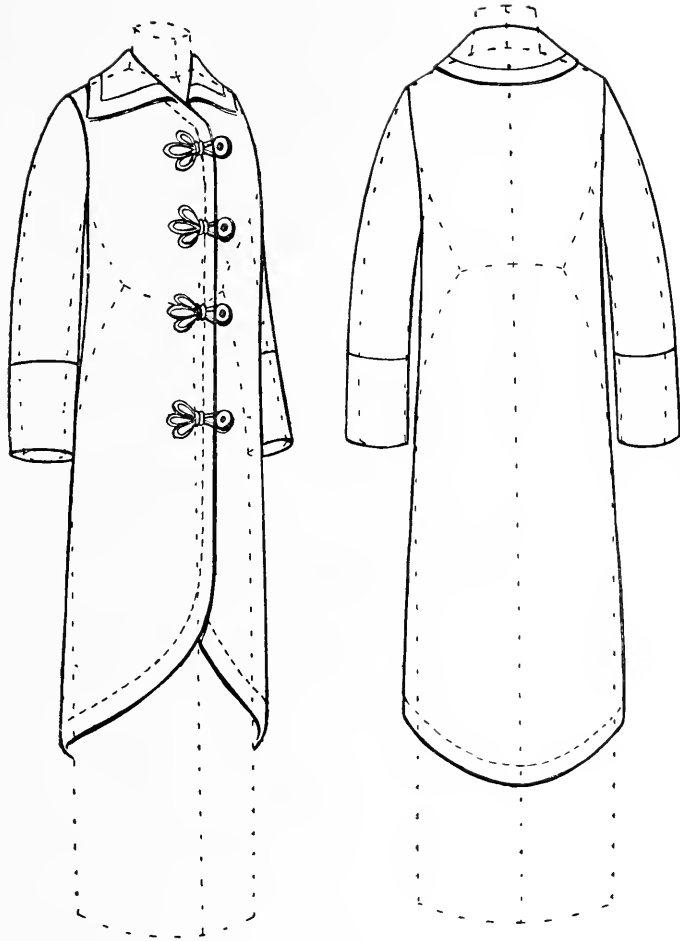

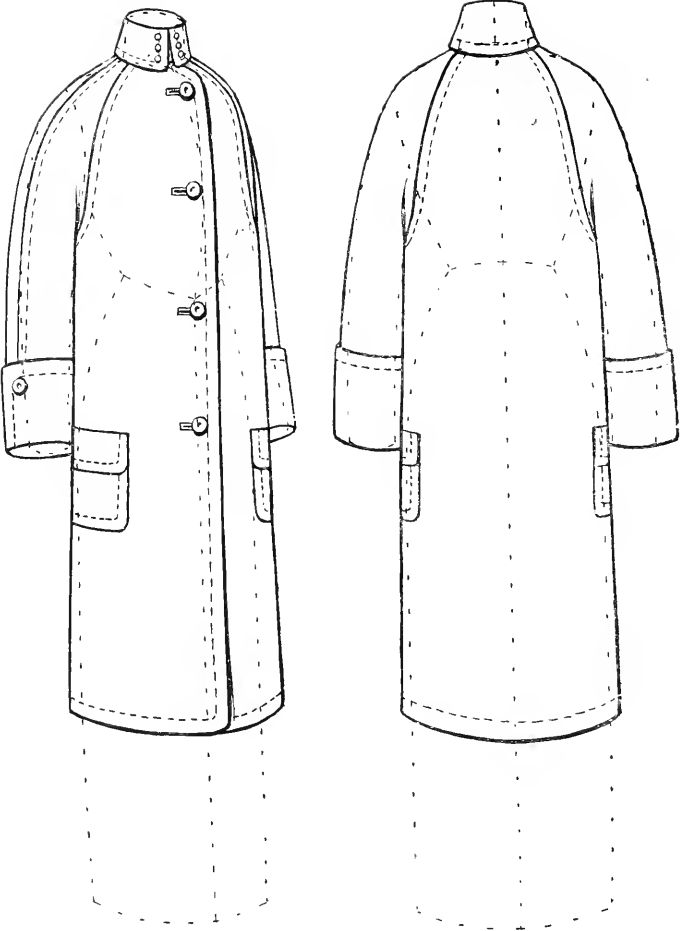

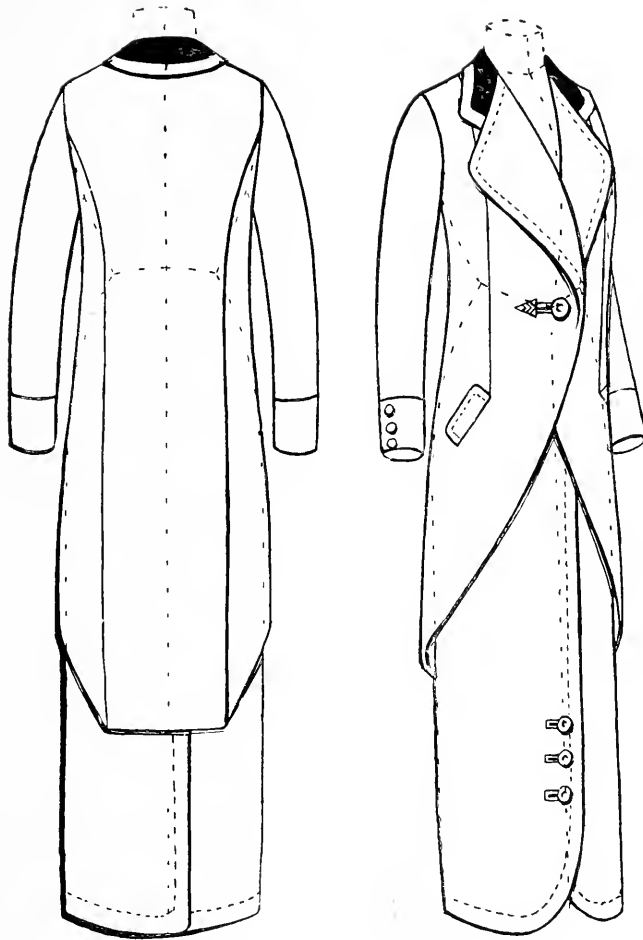



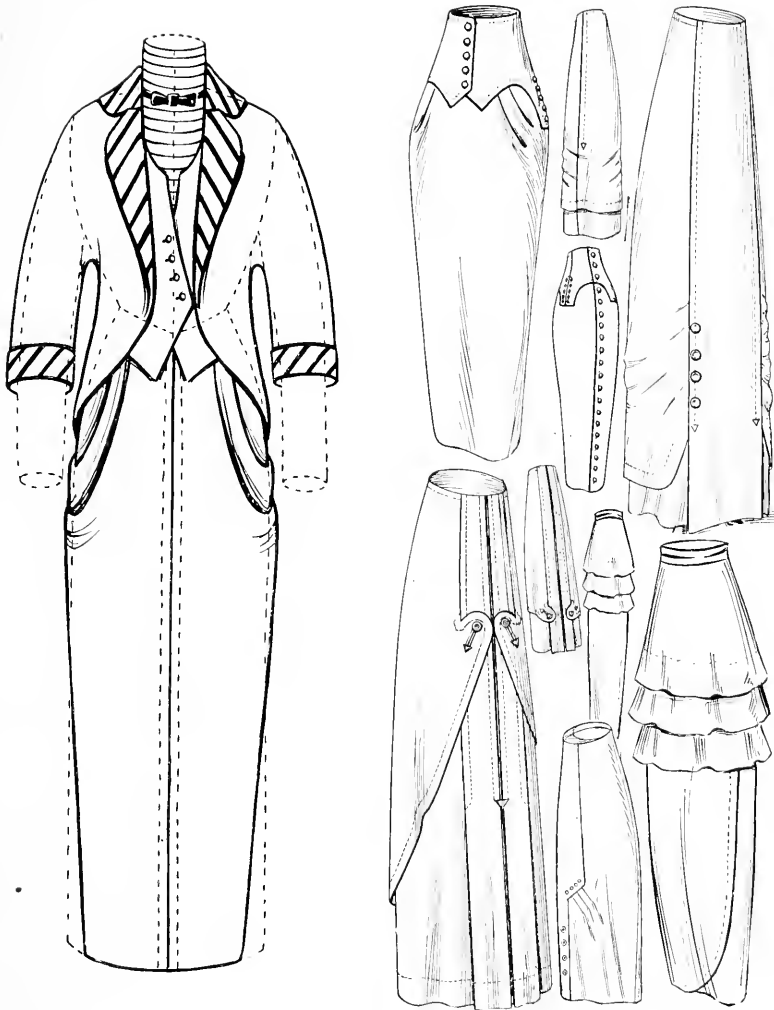

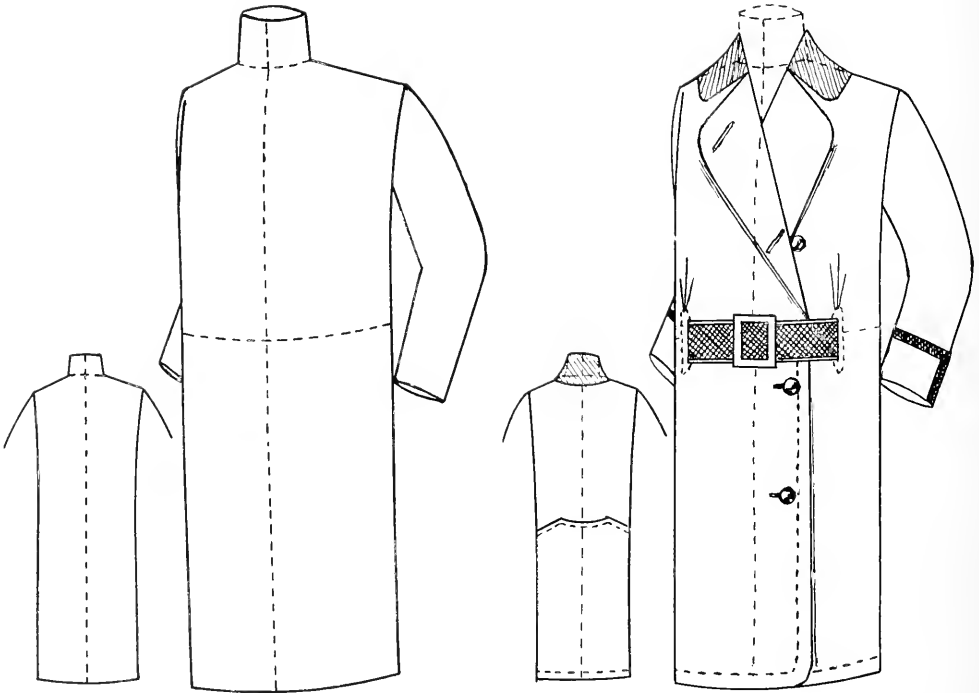

INDEX

Title	5
Preface	7
Introduction	9
What a Designer should know	10
Ladies' Tailors Qualifications	10
System	11
Good lines	11
Contrasts	12
Fashions	12
Style	12

PART ONE Womens' Garments

How to take Measurement	14-15
Comparative Proportions for Normal Women's Sizes	17
Table of Proportionate Measurements for Women	17
Systematic Outline	18-19
Tight-Fitting with one dart	20-21
Tight-Fitting with two darts	22-23
Tight-Fitting back and Semi-Fitting front	24-25
B'ouse	26-27
Basque or Tunic Skirt	28-29
Tight-Fitting Eton with one Dart	30-31
Tight-Fitting Eton with two Darts	32-33
Tight-Fitting Eton with one Side Gore	34-35
Tight-Fitting Eton with French Seam	36-37
Tight-Fitting French Seam with underarm Gore	38-39
Tight-Fitting Double French Seam	40-41
Tight-Fitting 18 Gores	42-43
Tight-Fitting 22 Gores	44-45
Semi-Fitting Back and Loose Front	46-47
Semi-Fitting with Dart in front	48-49
Semi-Fitting French Seam	50-51
Semi-Fitting Hipless Effect	52-53
Semi-Fitting Coat with underarm Gore	54-55
Sack Coat with Loose Front	56-57
Sack Coat with Shaped Front	58-59
How to make Shoulder-Dart	60-61
Loose Box Coat	62-63
Loose Box Coat with Front-Shoulder Dart	64-65
Coat Sleeve	66-67
Sleeve with fulness on top	68-69
One Piece Sleeve	68-69
Bishop Sleeve	70-71
One Piece Tight Sleeve	72-73
One Piece Tight Sleeve with middle seam	72-73
Collars and Lapels	74-75
Collars	76-77
Capes	78-79
Yoke and Hood	80-81
Cape Coat	82-83
Cape with Kimono Sleeve	84-85
Coat with Kimono Sleeve	86-87
Raglan Coat	88-89
Deep Armhole Coat	90-91
One Piece Coat	92-93

New Market	94-95
Inverness	96-97
Opera Cloak	98-99
Manipulation of Fronts and Backs	100-101
Vest	102-105
Stouts	106
Table of Proportionate Measurement for Stouts	107
Semi-Fitting French Seam for Stout	108-109
Shirt Waist	110-111
Shirt waist with Side gore	112-113
Tight-Fitting Waist Lining	114-115
Tight-Fitting Waist Lining with Side gore	116-117
Sleeve for Waist	118-119
One Piece Sleeves	120-123
Standing or Military Collar	124-125
Collars for waists	126-127
Yoke	128-129
Shield	128-129
Waist with Kimono Sleeves	130-131
One Piece Butterfly Waist	132-133
Waist with Raglan Sleeve	132-133
Measurement for Skirts	134-135
Systematic Outline for Skirts	136-137
Two Gore Skirt	138-139
Three and Four Gore Skirt	140-141
Four Gore (Panel) Skirt	142-143
Five Gore Skirt	144-145
Six Gore Skirt	146-147
Seven Gore Skirt	148-149
Nine Gore Flare Skirt	150-151
Eleven Gore Flounce Skirt	152-153
Thirteen Gore Plaited Skirt	154-155
Circular Skirts	156-157
Circular Skirt in Gores	158-159
Princess Skirt	160-161
Skirt with fixed bottom width	162-163
Skirts for Stouts	164-165
Princess Slip	166-167

PART TWO Misses' Garments

Table of Proportionate Measurements for Misses' Sizes	171
Systematic Outline for Misses' Sizes	172-173
Tight-Fitting French Seam	174-175
Semi-Fitting-witting with Dart in Front	176-177
Sack Coat with Loose Front	178-179
Loose Box Coat	180-181
Blouse	182-183
Sleeve	184-185
Systematic Outline for Misses' skirts	186-187
Seven Gore Skirt	188-189

PART THREE Juniors' Garments

Table of Proportionate Measurement for Juniors' Sizes	193
Semi-Fitting French Seam	194-195



Loose Box Coat	196-197
Blouse	198-199
Sleeve	200-201
Five Gore Skirt	202-203
Circular Skirt	204-205

PART FOUR Childrens' Garments

Table of Proportionate Measurements for	
Childrens' Sizes	208-209
Systematic Outline	210-211
Tight-Fitting	212-213
Semi-Fitting	214-215
Sack Coat	216-217
Loose Box Coat	218-219
Sleeve	220-221
Tight-Fitting Waist Lining	222-223
Waist	224-225
Coat Dress	226-227
Military or Standing Collar	228-229
One Piece Sleeves	230-233
Collars	234-235
Systematic Outline for Childrens' Skirts	236-237
Five Gore Skirt	238-239

PART FIVE Infants' Garments

Table of Proportionate Measurements for	
Infants' Sizes	243
Systematic Outline for Infants' Sizes	244-245
Loose Box Coat	246-247
Sleeve	248-249
Coat Dress	250-251
One Piece Sleeves	252-253
Infants' Yoke	254-255
Infants' Shield	254-255
Hood	256-257

PART SIX Grading

Art of Grading	260
Scale of Regular Stock Patterns	261
Tight-Fitting with Dart	262
Semi-Fitting with Side Gore	263
Eton	264
Semi-Fitting French Seam	265
Tight-Fitting French Seam	266
Tight-Fitting Double French Seam	267
How to grade Misses' Sizes from Ladies' Size Patterns	268
Misses' and Juniors' Tight-Fitting	269

Misses' and Juniors' Tight-Fitting French Seam	270
Childrens' and Infants' Semi-Fitting	271
Childrens' and Infants' Loose Box Coat	272
Sleeves	273
Capes, Yokes, Collars, Cuffs	274
Length of Garments	275
Grading Lengths	275
Grading Skirts	276

PART SEVEN Special Measurement

Foundation of Garment Cutting	278-279
How to take Special Measurement	280-281
Systematic Outline for Special Measurement	282-283
Tight-Fitting French Seam	284-285
Semi-Fitting with Dart in Front	286-287
Systematic Outline, No Seams	288-289
Tight-Fitting Jacket, No Seams	290-291
How to take Special Measurement for Direct Short Measure System	292

PART EIGHT Riding and Sporting Garments

Riding Skirts	294-295
Side Saddle Safety Riding Skirt	296-297
Apron Riding Skirt	298-299
Hints on Making Apron Riding Skirts	300-301
Cutting Riding Skirts by Model Patterns	302-303
Ride Astride Skirt	304-305
Making Ride Astride Skirts	306-307
Riding Coat, Special Measure, No Seams	308-309
Riding Coat, Special Measure, with Seams	310-311
Pantaloon Skirt	312-313
Ladies' Riding Breeches	314-315
Leggings	316
Gaiters	316

PART NINE

Practical Tailoring	317-318
---------------------	---------

PART TEN

Fitting	319-320
---------	---------

PART ELEVEN

Alterations	321-322
-------------	---------

PART TWELVE

Sketching	323-334
Index	335-336



15-17

LIBRARY OF CONGRESS



0 013 973 177 3 ●