

FIG. 1. IMHOFF TANKS. SCUM FORMING IN FOREGROUND OR ENTRANCE END. Since this picture was taken a longitudinal bridge has been built, the slopes have been cleaned and the scum has entirely disappeared. (See page 31).

The Operation
of
Sewage Disposal Plants

**A Manual for the Practical Management of Sewage
Disposal Works, with Suggestions as
to Improvements in Design
and Construction**

By FRANCIS E. DANIELS, A. M.
Director of Water and Sewerage Inspection
Board of Health of the State
of New Jersey

ILLUSTRATED
From Photographs by the Author

New York
MUNICIPAL JOURNAL
1914

COPYRIGHT 1914
BY
MUNICIPAL JOURNAL AND ENGINEER.

12-13-66, 4-11-77-DA

78151, S,

TABLE OF CONTENTS.

	Page
Introduction	1
Chapter 1. Grit chambers and screens.....	7
Grit chambers	7
Screens	9
Chapter 2. Tanks.....	17
Sedimentation tanks	18
Septic tanks	23
Imhoff tanks	26
Sludge beds and sludge disposal.....	40
Taking samples in tanks.....	41
Chapter 3. Filters.....	46
Contact filters	46
Sprinkling filters	58
Final settling basins.....	62
Sand filters	62
Land treatment	74
Subsurface irrigation	77
Chapter 4. Disinfection.....	79
Condition of liquid to be disinfected.....	82
Size of dose.....	84
Applying hypochlorite	87
Liquid chlorine	95
Chapter 5. Chemical precipitation and electrolytic treatment	99
Chemical precipitation	99
Electrolytic treatment	105
Chapter 6. Trade Wastes.....	108
Chapter 7. Testing Stations.....	111
Chapter 8. Making Tests.....	114
Physical and chemical.....	115
Bacterial tests	124
Chapter 9. Records of Plant Operation.....	127
General remarks	128

LIST OF ILLUSTRATIONS.

	Page
Sprinkling Filter with Upright Nozzles.....	Frontispiece
A Week's Collection on Horizontal Screen.....	10
Straw Screens at Lakewood.....	11
Screenings Allowed to Accumulate	13
Screen Pit Overflowing.....	15
Open Sedimentation Tank.....	18
Conical Settling Glasses.....	19
Shallow Settling Tank.....	22
Septic Tank under Street.....	24
Open Septic Tank.....	25
Plan Submitted for Imhoff Tank	32
Imhoff Tanks	32
Plan Submitted for Imhoff Tank	32
Approved Plan for Imhoff Tank	34
Sampling Bottle	42
Rod with Bottles Attached	43
False Floor for Contact Bed.....	49
Settling Basins for Contact Effluent	49
Contact Beds with Hand Gates.....	53
Cinder Barriers on Contact Beds.....	54
Contact Beds with Wooden Distributers.....	54
Air Lock Control Apparatus.....	55
Mechanical Control Apparatus.....	56
Sprinkling Filter with Inverted Nozzles.....	60
Sewage Bed of Natural Soil.....	64
Artificial Sewage Bed.....	66
Artificial Sand Bed.....	62
Secondary Sand Beds.....	69
Land Filtration Area.....	72
Neglected Sewage Plant.....	73
Land Filtration Areas.....	76
Broad Irrigation	74
Sewage Plant at Red Bank.....	81
First Disinfection Plant.....	82
Screening and Disinfection Plant.....	85
Interior of Screening and Disinfection Plant.....	85
Automatic Hypochlorite Feed Box.....	92
Hand Control Hypochlorite Feed Box.....	93
Liquid Chlorine Apparatus.....	97
Sludge Presses	104
Experimental Filters	112

PREFACE.

The pages of this book are the result of bringing together in a single volume a series of articles on the practical management and operation of sewage disposal plants, which have already appeared monthly in the Municipal Journal during the past year. During that time there have been received, both by letter and word of mouth, numerous statements from plant attendants and designing engineers, in regard to the practical value of the articles and requesting that they be assembled and published in book form.

It is, therefore, in response to such requests that this material is republished, in the belief that it may form a handy and useful practical manual; and that it may get into the hands of many who have not had the opportunity of reading the monthly installments.

It will be noticed that the book is lacking in an account of the detailed results of the many kinds of sewage disposal processes, and also in a setting forth of the details of the effects upon the various outputs caused by various types of construction and their different modes of management and operation. This is because of the fact that reliable every-day data are not available. Such information is needed and greatly desired; and to show its importance and to urge its accumulation has been one of the purposes of the author.

The main purpose, however, is to assist the plant attendant by pointing out to him many things he should do and some he should leave undone, in order that he may be able to keep his plant up to its highest state of efficiency at a minimum expenditure of cost and energy. Likewise, it has been endeavored to show that poor designs are troublesome, costly and inefficient, in the hope that in the future more attention will be paid to details which have a direct bearing on the operation, as well as those which have a direct bearing upon the fundamental principles of the treatment processes.

The text has been based entirely upon the author's own personal observation and experience for several

years, upon almost all known types and combinations of units, and the photographs, except perhaps two or three, were taken by him. For the pictures contributed the author's thanks are here expressed.

Notwithstanding a year has passed since some of this work has been written, and although it is almost impossible to keep printed matter on these subjects up to date, it is nevertheless hoped that these pages will be carefully read and properly construed, so that some benefit may be derived both by the plant attendant and the designing engineer.

FRANCIS E. DANIELS.

Trenton, N. J., November, 1914.

THE OPERATION of SEWAGE DISPOSAL PLANTS

INTRODUCTION.

Dr. Thresh, medical officer of health for the county of Essex, England, in an address before the Association of Managers of Sewage Disposal Works, made a statement which has often been quoted as follows: "I have so repeatedly seen excellent works give bad results on account of inefficient management, and very defective works give fair results on account of the efficiency of the manager, that I have come to regard the manager as being even more important than the works." The truth of this statement has so frequently been brought to the writer's attention during his personal observation of the sewage disposal plants of the state of New Jersey that when the editor of the *Municipal Journal* requested him to write for publication his experiences with the operation of sewage disposal works, he decided to describe briefly the general principles to be considered by the man in charge of a sewage disposal plant, and to point out to him some of the things to do and some to be left undone. In addition he hopes to make plain, from the point of view of the operation, some defects in design or construction, with the idea of offering helpful suggestions to the designing engineer. In this connection he wishes it to be known that his statements are for the

OPERATION OF SEWAGE DISPOSAL PLANTS.

purpose of aiding those who wish to profit by his experiences, and not for the purpose of criticising those who appear to have made a mistake. A designing engineer should not be surprised, however, if a plant receive unjust criticism, if he has put into it some new departure, the purpose of which is not likely to be understood and has quit the job without leaving a record of what he desires it to accomplish, or how he proposes his "invention" shall be operated.

Almost any human being will sooner or later do the wrong thing when an emergency arises if he has been working simply as a machine, without understanding the principles underlying his operations. For instance, the writer has known the chief engineer of a state institution to mix, for disinfection, the required number of pounds of hypochlorite in a tankful of water. The solution was allowed to settle and the clear liquor was drawn off and used. Instead of putting in a fresh quantity of hypochlorite for a new solution he merely filled the tank with water, because, as he said, there was plenty of "lime" left in the bottom. So there was, plenty of inert lime, but the active hypochlorite had all been dissolved and drawn off the first day, so that no disinfection was obtained after that time until nearly a month later, when the facts were brought to the writer's attention, although the tank had been filled and emptied daily in a purely perfunctory way. On the other hand the writer once knew an old Irishman who had been a faithful plant attendant for one of our New Jersey towns for sixteen years. This old man could neither read nor write and his ideas on many subjects were decidedly primitive, but he had an excellent understanding of the whys and wherefores of his particular plant, and kept everything in a fine and tidy shape, free from nuisance, and with proper alternation of flow on the beds.

We need in immediate charge of every sewage disposal works an intelligent man who thoroughly understands the fundamental principles of sewage disposal and who is personally familiar with every detail of his particular plant. He must *know* when every unit is performing its functions properly and what to do in case of emergency.

INTRODUCTION.

He must be able to tell when his tanks are beginning to let over an undue amount of suspended matter, indicating that a removal of stored up sludge is desirable or necessary. He must know when his various forms of feed or dosing apparatus are working properly, and how to make proper adjustments as soon as a siphon or other apparatus gets out of order. In one of his rounds the writer discovered a suspicious appearance at the outlet of one of four contact beds. The attendant assured him that each bed was working perfectly as he had been at the plant daily for weeks. Upon close investigation the writer found that the discharge siphon in the bed noted was out of order so that at every round this bed did not hold but allowed the dose to run right through without any purification. This had been going on for weeks, almost undoing the work of the other three beds, which were turning out a good effluent, and the attendant was none the wiser.

In order to get the highest efficiency from our sewage disposal plants as they now exist, the attendants must be taught the necessary fundamentals or be displaced by specially trained men. Many a plant when new does not appear to require skilled attention because it is usually of such a size that a future growth of the town for which it was built has been provided for and, therefore, the duty imposed upon the treatment units is comparatively light. The final effluent of such a plant is usually excellent, although in many cases the writer has seen this produced almost wholly by the final sand filters because the preliminary treatment units or the contact beds had not been operated so as to perform their share of the work. Sooner or later such a plant becomes more heavily loaded and then trouble begins and corrective measures are oftentimes costly.

On the other hand, we have a sewage plant in the state of New Jersey which has been so overloaded for years that in the hands of an ordinary attendant it would have long since become a menace to health and a public nuisance; but a laboratory is maintained at the works and the plant is under the constant personal supervision of a specially trained man. By this means it has been possible to prevent the plant from becoming a

OPERATION OF SEWAGE DISPOSAL PLANTS.

nuisance and to have it turn out a very fair effluent in order to tide over the delay in rebuilding, due to financial and legal difficulties.

If the plant attendants of any state or section of country would unite themselves into an association for the purpose of discussing daily practical problems and interchanging ideas on subjects dealing with sewage disposal, I believe much mutual benefit could be secured. Such an association exists in England and much helpful information is acquired at the meetings, both from the papers presented and in the informal discussions of the various problems arising at the different installations.

The general public and even town officials have no conception whatever of the variety of subjects with which a successful plant superintendent should be acquainted. Raikes in his book, *Sewage Disposal Works*, says: "The proper technical training of a competent manager is therefore a gradual process, since it should include both a theoretical and practical knowledge of the whole sewage disposal problem, which can only be gained by constantly reading all available literature on the subject, and carefully studying different types of sewage works in actual operation; but in addition to this, he should possess some knowledge of agriculture, chemistry and bacteriology, as well as hydraulic and mechanical engineering, before he can be considered technically qualified to undertake the control of the costly works now required for purifying the sewage from our large towns.

"It can hardly be expected, however, that the sewage works of small communities should receive the undivided attention of a fully qualified manager, and in such cases the difficulty arising through the inability of a partially trained man to take full responsibility may be largely overcome by appointing a competent consulting specialist to exercise a general control of the works, who would make periodical inspections, and whose experience would enable him to advise as to the best means of checking any tendency to deterioration which he might detect, either in the works themselves or the quality of the effluent, thus preventing the permanent damage which

INTRODUCTION.

would otherwise ensue and ultimately involve considerable expense to rectify.

"A similar course might also be adopted with advantage in the case of many larger communities where difficulties frequently arise through local authorities expecting their surveyor to undertake the whole responsibility involved by the maintenance of sewage works in addition to all the other duties of his office, which may be more than sufficient to occupy his full time and attention; and by occasionally obtaining the opinion of a specialist, who would emphasize the importance of improved methods or any structural alterations necessary, the disastrous results of false economy might be averted to the mutual benefit of all concerned."

The Board of Health of the State of New Jersey endeavors, in its supervision of the sewage disposal plants, to instruct the plant attendants as much as the present facilities will permit; but it is impossible for such a central body to detail men to remain at the works long enough so to instruct the men in charge that they will be prepared for every emergency which may arise. There is, therefore, right in our state as well as elsewhere, a field for the "traveling expert" such as Raikes refers to above. This consulting specialist could have a circuit of plants to care for and he would have opportunity of remaining at each one long enough to learn fully the local conditions; and by frequent and extended tests and records he would, with the help of the local attendants, be in a position to keep each unit up to its requirements, to have the final effluent as satisfactory as possible, and to give valuable advice in regard to changes or improvements. That men fully qualified for this kind of occupation are available the writer knows, because some of them have expressed to him their desire to go into just such work.

If in the succeeding pages of this discussion the writer shall set forth any information which will be of benefit to the plant attendant who is not an expert, but one who is conscientiously striving to do his utmost to produce satisfactory results and endeavoring to overcome his difficulties, he will feel that his efforts have not been wholly wasted. The plan of the discussion will be from

OPERATION OF SEWAGE DISPOSAL PLANTS.

the point of view of a complete modern sewage treatment plant; taking up the various units and processes step by step from the sewer outfall to the point of final discharge of the effluent. Furthermore, only plants receiving sewage from sanitary systems on the separate plan will be considered because the operation of works handling sanitary and storm water sewage combined is somewhat different and not so generally applicable to the American practice.

GRIT CHAMBERS AND SCREENS.

Grit chambers are usually small tanks through which the sewage flows immediately upon leaving the outfall before entering the treatment works proper. The purpose of these chambers is to remove sand and the heavier mineral matters which by themselves are inoffensive to the senses and not capable of being worked over by the subsequent biological processes, but which are highly undesirable in either tanks or contact beds because of the space taken up and the difficulty of removal. Grit chambers are not intended to retain sludge or other decomposable organic matters.

The usual method of obtaining the results desired is to adjust the size and shape of the grit chamber to the sewage flow so that the velocity of the sewage passing through the chamber will be slow enough to allow the grit to settle and yet fast enough to carry through the organic matters. This may or may not be easy. With a system of tight sewers and only the hourly, daily or seasonal variations of flow the problem is not so difficult; but with a system of leaky sewers and uncertain flow fluctuation, it is almost impossible to have a grit chamber which will not at times hold back putrefactive matters and at other times allow sand and grit to escape unless it is given the utmost watchfulness and attention. While grit chambers may not be necessary or even desirable on some of our better constructed sanitary sewerage systems, they are on others quite advantageous if properly designed and properly cared for. We have in some of our New Jersey towns sewerage systems from which in time of storm it is impossible to keep out sand and detritus. At the inlet end of one of our so-called septic tanks after only a few weeks' run the writer found

OPERATION OF SEWAGE DISPOSAL PLANTS.

a deposit of sand and heavy mud, several feet wide, extending across the tank and nearly up to the flow line. There must have been several cubic yards of this material so tightly packed that it was difficult to get a rake down into the mass. Since this deposit had gone into the tank and had to be removed through manholes in the cover the writer advised the installation of a grit chamber and such other measures as could be taken to keep out of the sewers as much sand as possible, to prevent a continuance of this performance.

The duty of the plant attendant in regard to grit chambers is to give them *frequent* attention. Remove the contents often enough to prevent the possibility of grit being washed out, and in some cases it will be necessary to clean these chambers out every little while to prevent local nuisance.

At one of our plants there existed a large double grit chamber which was cleaned out several times a year, yet in summer this was the source of sufficient disagreeable odor to create a considerable nuisance in the neighborhood. Although the size was so great that considerable organic matter was detained, yet it would hardly have been safe to have made the chamber smaller because at times of showers, when most of the grit came in, the increased flow of sewage would have washed the sand through the chamber and into the septic tank.

In this case more attention should have been paid to the sewer system to prevent the entrance of storm water. Low manholes should have been raised and at some points where the street grade would not permit a manhole sufficiently high to keep out storm water, tight covers should have been sealed on and sewer ventilation provided for in other ways. Too little attention is still being given to the construction of tight joints in sewer lines and to the prevention of the entrance of storm water into sanitary sewerage systems which takes in with it entirely too much sand and dirt.

Grit chambers are and should always be built in duplicate so that the process of cleaning can go on without interrupting the sewage flow. In the large installations dredging apparatus is used to remove the sediment;

GRIT CHAMBERS AND SCREENS.

while at the smaller plants, and usually at those not handling storm sewage, the contents of the grit chambers are taken out by shoveling. The material removed can usually be dumped into some low place or spread out on the ground at a point where it is not likely to cause nuisance. If, however, it is foul with organic matter it had best be buried or disposed of along with the tank sludge. As screens are often placed at the outlets of these chambers, they are thereby converted into combination grit and screen chambers. Only one plant of the 130 now in operation in the State of New Jersey has a bona fide grit chamber; all others having appurtenances of this kind arrest the sand in the screen chambers.

SCREENS.

In regard to the screen the first question the attendant must ask is, What is it there for? or what is it supposed to do? Having asked the question, then let him find the answer; because, before he can manage the screen intelligently he must understand thoroughly the purpose for which it was installed.

The purpose of a screen may be one of many, depending not so much upon what comes down the sewer, for that is legion, as upon the processes which follow. They may be used to remove such things as would break or cause stoppages in the pumps; or to arrest a large amount of suspended matters which would cause undue clogging on filtering areas; or to remove light suspended matters which would cause excessive formation of scum in septic or settling tanks (the use of fine screens will entirely prevent the formation of tank scum); or to remove such a large proportion of the suspended matters that only a clarified liquid remains to be discharged or disinfected.

Coarse screens are usually bar screens or gratings. These are made of wooden slats or iron bars or rods set in a frame. They are made either stationary, or movable so that they can be hoisted up for cleaning, and are placed in a vertical, inclined, or horizontal position. Probably the best are the stationary bar types inclined downstream at an angle of about 30 degrees or more with the vertical. These may easily be cleaned by means of hand

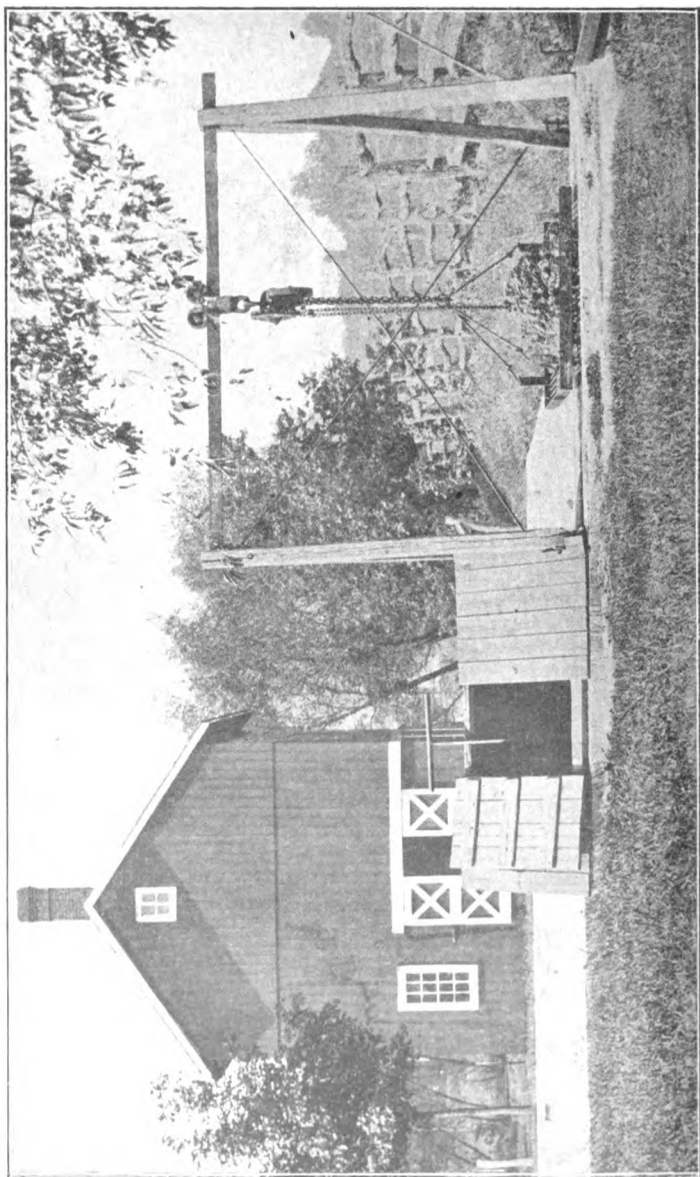

A WEEK'S COLLECTION ON A HORIZONTAL SCREEN. TOP OF TANK AT LEFT.

GRIT CHAMBERS AND SCREENS.

rakes. The vertical ones are sometimes cleaned with rakes while in position, or sometimes they are hoisted out, cleaned off and replaced. The horizontal ones are often more or less in the form of baskets which are hoisted out for cleaning.

Fine screens are usually of woven wire, and by reason of the nature of construction are difficult of being properly cleaned, some of the larger revolving types requiring a constant playing of jets of water to keep the meshes clear.

Perforated metal sheets have been suggested for use as sewage screens so that cleaning could be done by means of a hand squeegee. The writer has not had any personal experience with this kind of screen except in one instance. In this case the screen consisted of a flat sheet of iron perforated by holes nearly one inch in diameter. This sheet was placed in a horizontal position over the receiving compartment of the settling tank and up against the bottom of the sewer outlet, so that the sewage solids from the institution soon piled up around the mouth of the sewer. The first time the attendant forgot to clean off the screen the stoppage continued up the sewer and the water closet in the basement of the building overflowed. The plumber had then to be sent for to clear out the sewer line. The trouble in this case, however, was due not so much to the perforated metal as

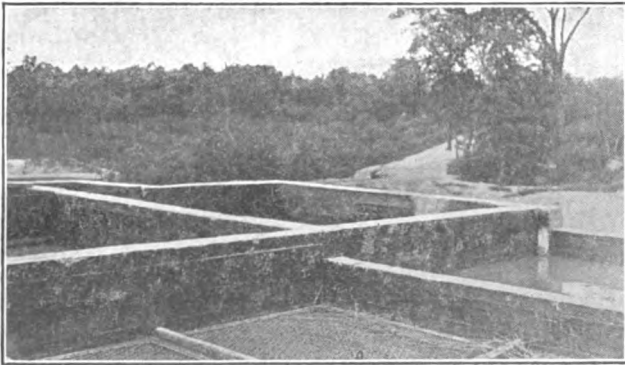

STRAW SCREENS AT LAKEWOOD.

OPERATION OF SEWAGE DISPOSAL PLANTS.

to lack of forethought. The writer has seen exactly similar instances in manholes, into which side connections have been brought through the wall just above the flat bench or bottom. All solids of any considerable size stranded upon the flat surfaces and complete stoppage of the branch sewers resulted.

Occasionally the writer meets designers who advocate and wish to install upward flow screens or filtering materials into which the flow enters from beneath, the claim being that the screenings will, after being intercepted by the obstruction, fall back into the screen pit. This the writer can hardly vouch for because he has not seen it happen. The general testimony is, however, that the screenings stick and are in a position not readily accessible.

The only upward screens in use in New Jersey are at Lakewood. These consist of two frames of coarsely woven wire, between which is placed a layer of straw or salt hay. This strains the sewage quite effectively if properly cared for, but requires close attention and frequent renewal. An objection is that, in addition to the material removed from the sewage, the accumulation of the used hay must be removed and disposed of. Furthermore the upward pressure often breaks holes through the layer and then a considerable flow of sewage passes unscreened.

In regard to the actual management of screens, the fundamental principle is to assist each to perform its proper function and to see that the proper result is obtained. This will usually require daily attention, although in some plants at times the screens have to be cleaned several times a day. Probably the ideal plan is to have some economical mechanical appliance to be constantly at work removing the screenings as fast as they accumulate. Such ingenious and elaborate mechanical screening devices as are in use in Germany and England require special instruction in regard to operation. There are some types of mechanical screens in this country, notably the one at Reading, Pa. In this one the sewage passes through a wire cloth of 40 meshes to the inch, which is kept clean by means of jets of water. At

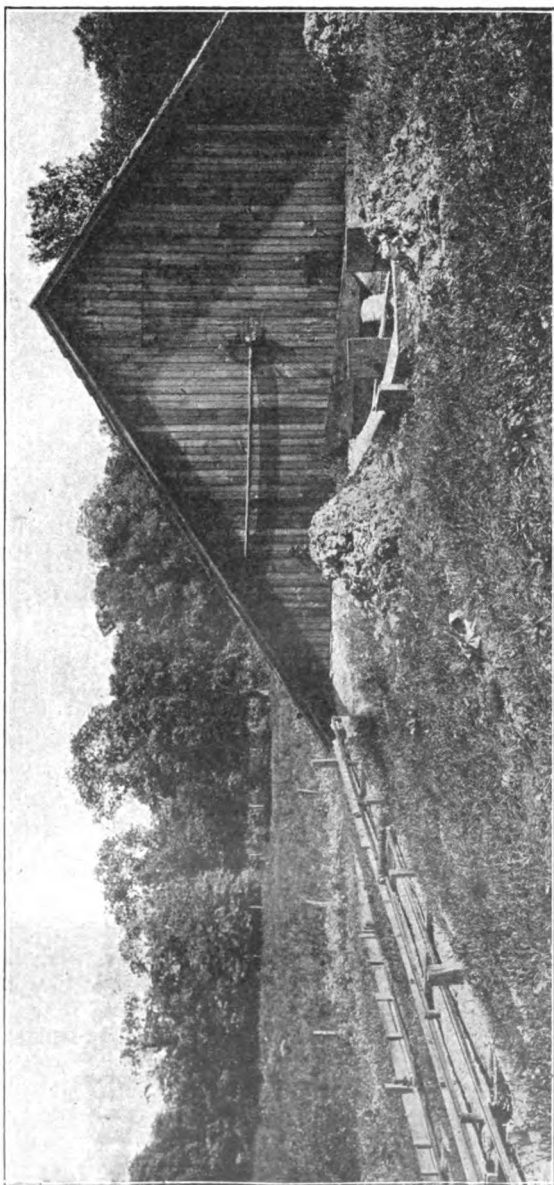

SCREENINGS ALLOWED TO ACCUMULATE AROUND SCREEN PIT.
At left foreground, trickling filters with distributing troughs.

OPERATION OF SEWAGE DISPOSAL PLANTS.

the time of the writer's visit the installation was performing good service. However, he has been informed that upon a recent tour of inspection made by a man in the middle west it happened that of the mechanical screens visited in the United States and Canada not one was found in operation. He only mentions this to show that all of the difficulties in this direction have not yet been satisfactorily overcome.

The writer does not believe it is wise to allow the screens to hold back organic matter which could be better taken care of in the tank. This will not happen with a properly designed apparatus if the screenings are removed often, nor will there be danger of overflows or deposits in the outfall due to backing up of the sewage.

The attendant should be very careful to keep the premises around his screens tidy and cleanly. Screenings should be removed as soon as possible and not allowed to accumulate so as to cause nuisance. They may be buried or composted with lime or otherwise disposed of according to local conditions.

The writer would like here to call the attention of those concerned to the danger of infection from fresh sewage material, such as may be removed from screen chambers. Some of it may, and probably does, contain disease germs, which are still in a very vigorous state. This material should never be carted through streets in open or leaky vessels, nor left exposed in places accessible to flies and domestic animals. The attendant should exercise the utmost care to prevent infecting his food and drink or transporting infection to his household. He should also be careful of cuts or abrasions upon his person while handling this kind of material.

The care to be taken of the screen chamber is also an important part of the attendant's daily duties, and the design of the chamber plays an important part in the screening process. If grit and detritus are arrested in the screen chamber then it must be cleaned out at frequent and regular intervals. For various reasons the cross-section of the screen chamber must be greater than the cross-section of the sewer; but if the chamber be too large, an undue amount of organic matter will be retained which

GRIT CHAMBERS AND SCREENS.

would be better taken care of in the tanks. This has to be removed, usually by letting it flow upon the sludge bed, and it forms an offensive sludge which is somewhat difficult to handle.

At one of our towns a fifteen-inch outfall sewer empties into a screen chamber some 10 feet by 12 feet in plan,

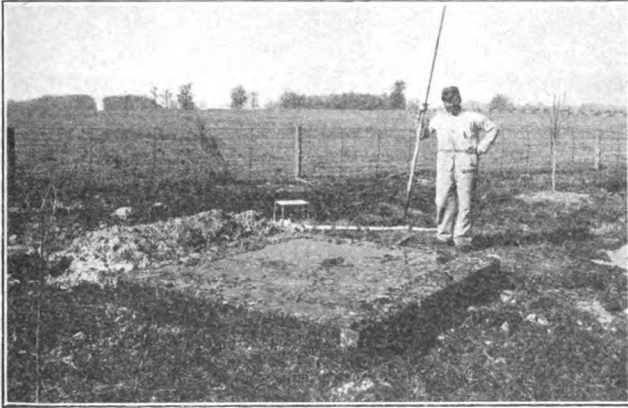

SCREEN PIT OVERFLOWING THROUGH OMISSION OF CLEANING.

separated into two units by a dividing wall, and 8 feet deep to the bottom of the screens. Each unit then tapers into a conical pit to a depth of 6 feet further down. The screens are $4\frac{1}{2}$ feet wide by 8 feet deep, and consist of bars $\frac{3}{8}$ -inch wide, spaced $1\frac{1}{4}$ inches apart in the first set and $\frac{5}{8}$ -inch apart in the second. On account of the low velocity of the sewage, this chamber fills up in a short time with a mass of grit and putrefying organic matter. An attempt to get the fine material over into the septic tank by churning it up was without success. The only thing to be done in this case is to keep the screens free from rags and the larger matter and draw off the sludge upon the sludge bed whenever necessary.

The placing of a horizontal screen and pit under the direct discharge of a sewer outfall carrying a stale sewage in one of our plants was the cause of such a local

OPERATION OF SEWAGE DISPOSAL PLANTS.

nuisance from odors that the screen had to be removed and the sewer connected directly to the pumps. The sewage is now pumped into the septic tank without odors or local nuisance. When the screens were in use at certain times in the year they had to be cleaned off every few minutes.

The writer recently visited a plant and found conditions such that he advised the attendant *not* to clean the screen until it became necessary. The plant was a disinfection plant and the sewage passed through bar screens before entering the disinfection tank. There was no danger of backing up the flow into the sewers, nor of local nuisance from odors, and the screen had not been cleaned, probably, for months. Feces and other matters were being held back by the screen and digested so that a much clearer liquid was obtained to be acted on by the hypochlorite, and for this reason the disinfecting action was much more complete than would have been the case had the screen been cleaned daily.

The writer has always opposed the use of screens except where it is very necessary to have them. Heretofore their use has always resulted in the settlement of large amounts of organic matter in the screen pits, which would be better off for all concerned in the tanks.

The nuisance of screen pits is usually caused not so much by the things which the screen removes as by the substances which are deposited solely on account of the lessened velocity in the pit.

In considering the matter it has occurred to the writer that in many cases the screens could be arranged over the end of the tank and then only what was really desired would be arrested. All other matters could pass along a steep sloping bottom, and slide into the tank along with the rest of the settled matter. In this manner some objectionable objects might be caught without the usual disagreeable features of screen pits.

II TANKS.

Skimming, Sedimentation, Septic and Imhoff Tanks— Principles of Operation and Design—Sludge Dis- posal—Tank Sampling Apparatus.

Our American domestic sewages usually carry about 200 to 800 parts per million of solid matter, of which only about one-third is in suspension. While this amounts to only a minute fraction of one per cent, nevertheless the separation, treatment, and subsequent disposal of the suspended organic matter of domestic sewage still constitutes a considerable problem. The removal of the heavier and coarser suspended solids by grit chambers and screens has been discussed in the first article of this series. It is the purpose here to consider the removal and digestion of the finer materials in suspension, for which numerous forms of tanks have been installed; but before taking up the discussion of the commoner forms of these devices a brief mention may be made of skimming tanks.

Skimming tanks are small chambers so constructed as to allow suspended matters which will float to rise to the surface. These floating materials, consisting of grease, soap, rags, sticks, paper, feces, etc., are skimmed off and removed immediately or composted with lime. They should receive daily attention, and care must be exercised in the handling and disposal of the materials collected.

There is one such installation in the state of New Jersey. The tanks are surrounded by a clump of ever-green trees and the skimmings are composted with lime, together with some screenings collected at the same place. In this way quite a considerable amount of material is removed from the sewage and no nuisance concerning the process has ever been reported.

The ordinary sewage tanks are primarily for the purpose of clarifying the sewage, that is, separating as far as practicable the suspended solids from the liquids in order to lessen the danger of nuisances and to provide

OPERATION OF SEWAGE DISPOSAL PLANTS.

an effluent suitable for the subsequent processes of treatment. In addition they may be used to hold and digest more or less completely the organic matter which has subsided. We have, therefore, settling or sedimentation tanks, liquefying or septic tanks, Emscher or Imhoff tanks, not to mention those for other purposes, such as disinfection, dosing, storage, etc.

SEDIMENTATION TANKS.

The skillful management of sedimentation tanks requires an accurate knowledge of the results to be obtained, close observation and good judgment. The

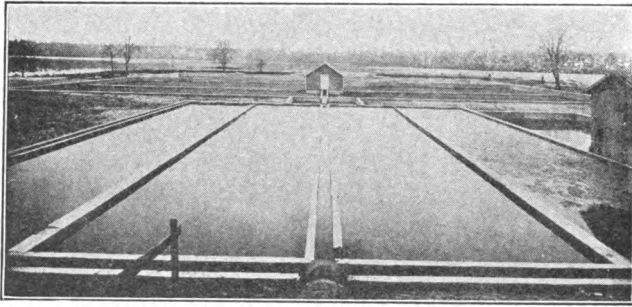

OPEN SEDIMENTATION TANK.

Scum formation beginning in first (right hand) compartment.
Tanks may be operated in series or parallel.

first object is to remove suspended matters from the sewage flow; the second is to collect the sludge in the most advantageous manner for subsequent disposal; and the third is to operate without the production of nuisance.

This type of tank is built either as a single compartment or in multiple units. In the opinion of the writer, it should always consist (except, perhaps in very small installations) of multiple compartments with the proper channels and gates so that the chambers may be run either in series or in parallel, and that one or more compartments may be cut out altogether.

In practice there is no sharp line between a sedimentation tank and a so-called septic tank; and whether it is advisable to allow some putrefaction or so-called septic

TANKS.

action or to prevent it altogether depends upon local conditions, and what the next step in the treatment of the effluent is going to be. In any case the attendant must study his tanks, and, above all, keep a careful watch upon the effluent.

The writer is aware of some of the adverse criticisms of the German conical settling glasses; but he is also personally acquainted with men who are using them

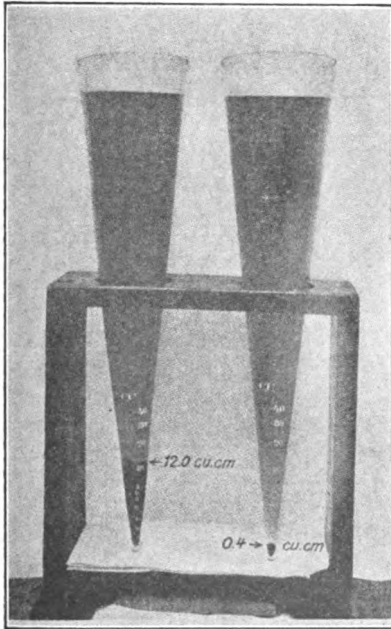

CONICAL SETTLING GLASSES.

daily and who are strongly in favor of them. In the absence of a better substitute to place in the hands of the usual attendant, a more extended use of such apparatus is advised. These glasses are of a tall conical form and hold one liter each. At the bottom are graduations enabling the observer to read off the number of cubic centimeters of matter which has settled out within a given time per liter. By taking a fair sample of the influent and a corresponding sample of the effluent after the detention

time of the tank has elapsed, and allowing each to stand the number of hours it takes the flow to pass through the tank, an approximate idea of the percentage removal of matters capable of settling will be obtained. While this method of testing may be of more practical importance in the operation of Imhoff tanks, yet it is believed it can be used to advantage elsewhere.

OPERATION OF SEWAGE DISPOSAL PLANTS.

In this connection let it be emphasized that the plant attendant should keep a "log" and make *daily* entries of everything bearing upon the operation of his works. More complete and extended data which could easily be furnished by wideawake plant managers are greatly needed. In New Jersey two plants have laboratories and are supervised by trained chemists. At perhaps a score of others the plant attendants are taking considerable interest and are making daily tests. At some other places, however, the attendants seem to be incapable of learning how to make tests or of keeping records.

A case in point comes to mind. At one of our plants sewage was emptied from the outfall sewer into a large double concentric tank. In the outer compartment there was considerable septic action which also continued in its inner well. Furthermore, on account of the low connection between the outer and inner compartments, the level of the liquid in the tanks rose and fell ten feet or more with the intermittent action of pumping operations. The pumps lifted the sewage from the inner well and the discharge was foul smelling and full of finely divided particles. These particles quickly clogged the contact beds, which necessitated the washing of the stone. In order to protect the beds a settling tank was built to receive the pump discharge. This was subsequently enlarged to several times the former capacity, and while the effluent from this tank was considerably clearer it did not improve in odors.

The writer always seriously questioned this method of operation and advised a radical change in the plant, claiming that the pumping should never be in the middle of a sedimentation process but that the pumps should handle either the fresh sewage or the final effluent. He believes that the churning up of a partly digested sediment results in a very considerable lengthening of the time required for the clarification by sedimentation.

Quite recently changes at this plant have been made. The outer compartment has been partitioned off and the sewage, after passing through a bar screen, goes directly into the pump well and is lifted into the sedimen

TANKS.

tation tanks. The odors at the point of discharge seem to have disappeared and the effluent from the tanks certainly looks much clearer than before. The plant attendant claims that there has been a decided improvement; but records of tests and accurate observations are lacking to confirm his views or upon which to base definite conclusions. This is rather unfortunate because the procedure of operation may have to be quite materially changed to meet the new conditions.

It is difficult to give definite directions in regard to the operation of sedimentation tanks, as individual cases almost always require special methods of procedure. In general, however, let the plant attendant by study and trial arrange the flow either in series or in parallel, whichever will give the better effluent, using only enough compartments to accommodate the quantity of sewage delivered.

In some of our coast towns the summer population greatly exceeds that in winter. This necessitates the cutting in or out of tanks to adjust them to the sewage flow. Too few tanks in use results in only partial sedimentation while the use of too many causes the effluent to be dark in color, foul smelling and full of black and finely divided suspended solids.

To run a sedimentation tank without any septic action whatever will require a very frequent discharge of sludge, and it will often be better in the end to permit septic action for a short time rather than clean out so often. This will, however, depend upon local conditions. At one of the New Jersey plants the sedimentation tank is cleaned out and scrubbed with a broom every Saturday. This tank never has a chance of causing a nuisance, and while this is no doubt a commendable practice such a procedure would hardly be feasible in most sewage works. In many of our so-called sedimentation tanks cleaning is done only once or twice a year. These, in the writer's opinion, virtually become septic tanks and will be discussed in the next section under that topic.

The sludge removed from sedimentation tanks is slimy, offensive, does not dry easily, is difficult to handle and if allowed to accumulate is very likely to cause serious

OPERATION OF SEWAGE DISPOSAL PLANTS.

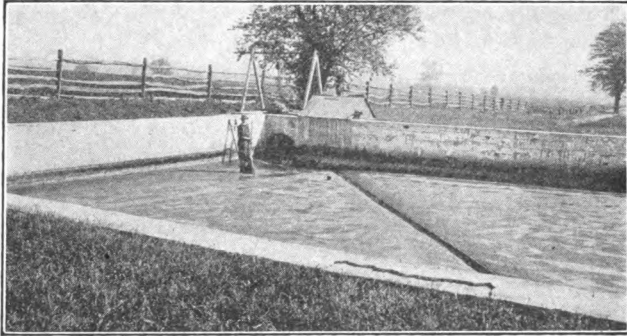

SHALLOW SETTLING TANK CLEANED WEEKLY.
This is the same tank shown on page 10.

local nuisance. Whenever possible, the water drained from undigested sedimentation sludge should be returned to the sewage flow and passed through the secondary treatment. This is done in several of the New Jersey plants. The writer believes that most sedimentation, as well as septic tanks, should be built so as to have reserve compartments, so that whenever one tank needs cleaning it can be cut out but not emptied until needed again. This will allow the sludge to decompose and digest. Sludge digested in this way compares more favorably with the much talked of Imhoff sludge and is decidedly more easily handled and without the nuisance attending fresh sludge.

Sedimentation tanks, like septic tanks, may be open or covered. If covered, there should be plenty of openings so as to facilitate cleaning and inspection. Ample provision should also be made for drawing off or otherwise removing sludge and supernatant liquid. The cutting of reinforced concrete to provide for extra man-holes and sludge pipes has been a troublesome operation, but it has had to be done in several cases in our state.

Some tanks produce a relatively large percentage of scum. When this occurs it is often better to remove it from the top, especially if it has dried and become hard. There is usually no advantage in breaking up this kind of scum and mixing it with water so that it will run

TANKS.

through the sludge pipe, which only results in an increased volume to dry out again on the sludge bed.

On the other hand, at our coast towns sludge and scum alike are broken up with a fire hose and the whole tank contents are flushed out to sea in the early spring. This, however, applies more especially to tanks run on the septic principle.

At each of two installations in the state of New Jersey, the large tank (sedimentation or septic, as you please) was built with a division wall separating it into two compartments, which could be used singly or together. When it became necessary to clean them out it was very provoking to find an opening in the dividing wall left for the purpose of equalizing pressure. It was desired to clean one compartment at a time; but the opening allowed the other side to empty simultaneously. Furthermore, the designing engineer had stated that it was not safe to close the opening to empty one side and keep the other full, as the division wall was not designed for this. With no way to by-pass the incoming sewage this sort of an arrangement is rather trying, and in the face of so many difficulties the useful purpose of such construction is not clear. In one case both sides were drawn down together. In the other, however, the attendant took the chance, closed up the opening and cleaned one side at a time.

All walls should be designed and constructed so as to withstand any pressures likely to be encountered. At one of our plants a man lost his life by the failure of a division wall while cleaning out one side of a tank when the other compartment was full of sewage. In addition to this, the designing engineer should always include in his plans and specifications a fence or other protection around all deep open tanks. Several animals and an eight-year-old boy have been drowned by falling into unprotected sewage tanks in New Jersey.

SEPTIC TANKS.

By the term septic tank the writer means a one-story sewage settling tank, which, in addition to clarifying the liquids, retains the solids and allows them to be digested.

OPERATION OF SEWAGE DISPOSAL PLANTS.

The compartments are not cleaned until they become so filled with solids that the increased velocity of the flow causes it to carry over an undue amount of suspended matters and more space is needed.

As there is no sharp line of demarcation between sedimentation tanks and the septic variety, much of what has been said concerning the former applies with equal force to the latter. The plant attendant must study his tanks, his local conditions, and the exact kind of effluent to be obtained.

The compartments must be arranged to give the best practical sedimentation. This can usually be determined by trial. Put in service a sufficient number of chambers to give a good clarification; but too many compartments should not be in use or else the liquids will become unduly saturated with the products of the decomposition of the settled solids, and local nuisance result. They should, therefore, be cut in or out to adjust the capacity of the works to large fluctuations in the sewage flow. Precautions should also be taken to prevent the back-

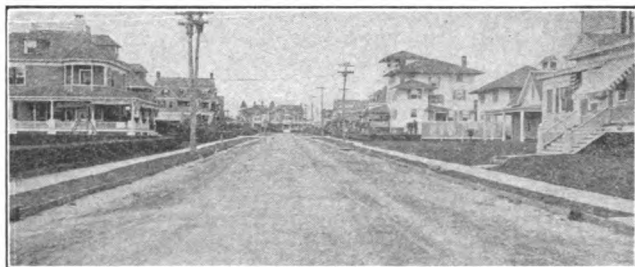

SEPTIC TANK UNDER A CITY STREET.

Note vents at curbs. No complaints from this tank have ever been received.

ing up of sea water into septic tanks, as serious nuisance from odors sometimes happens if this is allowed to occur.

As mentioned before, some tanks produce a large amount of sludge and little scum, some a very thick scum with little sludge, while others have about equal quantities of both. In one of our tanks after a run of

TANKS.

about two years there was no sludge and only about an inch of sand and grit in the bottom. But a very thick scum formed which had to be removed by shoveling off every few months. At another place the writer found less than a foot of sludge in a tank which had been in use for sixteen years.

If possible, septic tank sludge should be allowed to digest thoroughly before it is disposed of. There are three methods of doing this: One is to cut out a full tank and allow it to stand for six months or more before emptying; another is to draw off the bottom layers of the decomposed materials in small portions at frequent intervals; and a third method is to transfer the solids to other tanks built for the purpose of digesting the settled substances.

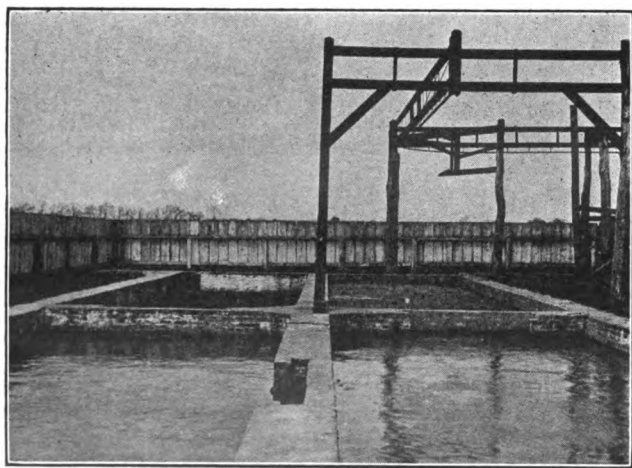

OPEN SEPTIC TANKS, SCUM AND SLUDGE REMOVED IN TRAVELLING BUCKET.

In the first method the scum usually softens and disintegrates, especially if the tank be covered; but even in this case it would be well for the attendant to help the process along by breaking up the floating layer if he can conveniently do so.

OPERATION OF SEWAGE DISPOSAL PLANTS.

The second method requires caution unless the tank is constructed with this particular end in view. The sludge will not run rapidly toward the outlet pipe, and channels carrying clear liquids are likely to develop unless care be taken. If, however, a small portion be run out at a time and the material left behind be allowed to level itself somewhat, a considerable amount of good sludge may thus be drawn off. But care must also be taken to avoid an undue agitation in the tank which would result in a cloudy effluent, to the detriment of subsequent treatment units. Multiple outlet pipes or a pipe with a movable inlet arm are sometimes of advantage in this connection. It is impracticable to construct an ordinary horizontal flow septic tank with a sufficient slope to the bottom to enable the sludge to flow to one point; but hopper bottoms are useful whenever possible.

In regard to separate sludge-digesting tanks the writer has had no personal experience in New Jersey, although from present indications he may advise a trial of that kind of treatment at one of the plants in this state very soon. There are such tanks at the sewage works in Baltimore; but recent data in regard to their operation are not at hand.

IMHOFF TANKS.

We now come to the much talked of Emscher or Imhoff tank. This form is certainly a decided improvement on the previous types of apparatus for the preliminary treatment of sewage; but while it has many good features and advantages it must be borne in mind that it is an apparatus for preliminary treatment only and not a complete "system" of sewage disposal. In many cases the effluent from an Imhoff tank would be quite good enough to be discharged into the stream; in others, however, further treatment of the effluent is needed either for the prevention of nuisance or for the elimination of bacteria. In addition to the patent fee attached, Imhoff tanks are usually more costly to build than those of simpler design. Furthermore, they require such careful management and frequent attention that, in the opinion of the writer, in small installations or in

TANKS.

out-of-the-way locations, where frequent attention may be lacking, they had better be omitted and one of the simpler forms of apparatus used.

Notwithstanding the above limitations, however, the principles of the Imhoff tank are good, and the practical results of the process are excellent. Briefly, the first purpose of the apparatus is to clarify the sewage by sedimentation without allowing the liquids to become foul, and the second is to digest the solids thoroughly so that they may be disposed of as easily as possible, and without offense. The former is accomplished by allowing the sewage to flow through an upper story or compartment, whose base consists of steep slopes so arranged as to form an inclined slot in the bottom so that the settling solids may slide through into a lower story or sludge digesting chamber, while gases liberated from the decomposing sludge cannot reach the fresh flowing sewage in the upper compartment because as the bubbles rise they will be deflected to one side by the projecting slopes and pass out of gas vents arranged for the purpose. The latter aim of the tank is brought about by holding the solids in the lower compartment until properly digested and ripened. By means of the appropriate deep design with steep bottom slopes the properly digested sludge may be drawn out from the bottom of the pile at frequent intervals without disturbing the half-digested or fresh materials in the layers above.

The upper compartment should be so adjusted and proportioned that the sewage is held therein for a comparatively short time, say, two to three hours or less. In this period practically all of the suspended solids capable of settling within a reasonable time will be deposited; but if the sewage is held for a longer time there is danger of putrefaction beginning in the liquids with but little or no additional clarification. Fresh sewage, therefore, entering an Imhoff tank should pass through and emerge in an inoffensive condition.

This important point should always be borne in mind by the plant attendant. The bubbling of gases or the belching up of solids within the flow chamber is a sure sign that something is wrong; but he should not wait

OPERATION OF SEWAGE DISPOSAL PLANTS.

for such indications, because some damage may be done before these things become apparent. Materials lodged upon the slopes generate gases, some of which are dissolved in the liquids and some are trapped under the solids until the pressure is sufficient to cause an upheaval. This results in the contamination of the flowing liquid by both gases and solids and defeats one of the fundamental purposes of Imhoff tanks. The attendant should see that the slopes are kept clean and that the slots are not obstructed. The slopes should be built with surfaces as smooth as practicable, and as steep as possible consistent with other requirements, so that the lodgment of solids will be a minimum. The slots would be quite wide, say, about 10 inches, but they should be well overlapped. Footways should be provided so that the attendant can easily reach all parts of the slopes to clean them down with a long-handled squeegee and to push entirely through the slots any solids which have accumulated on the slopes. This cleaning of slopes by the attendant should be done frequently, say every day or two, depending upon local conditions; but care must be exercised not to agitate the flow chamber or else more harm than good may result. Unless the squeegee is manipulated cautiously some of the finely divided matters will not be pushed through the slot but will be stirred up by the swirling liquids, and then either deposited back where they were or carried out in the tank effluent. A piece of galvanized iron pipe makes a smooth handle for the squeegee and its weight helps to hold down the tool against the buoyancy of the water. It can also be bent into convenient shapes if desired.

To check uneven distribution of flow, baffles are often placed in tanks so as to allow the suspended solids a better chance to settle out, but care must be exercised in the design and arrangement of these or else more harm than good will result. A deep scum board or baffle is likely to cause a rapid current under it which results in stirring things up and retarding sedimentation. Another disadvantage of deep baffles is that they often cause uneven deposits which cover over slots very quickly.

TANKS.

After all, it is very questionable whether baffles are needed or even advisable. The writer has already advised the removal of baffles from one set of Imhoff tanks in the hope of correcting some of the troubles referred to above.

The attendant, however, should not make any structural change in his tanks until he has made careful tests and records of conditions and results so that he may be in a position to know whether the change is beneficial or not. If possible, changes should be made only with the advice and consent of the designing engineer. Every plant should be operated so as to carry out the purpose of the design unless there is good reason for doing otherwise.

Shallow scum-boards may be of service in catching light materials on fresh sewage. These floating substances the attendant should skim off and dump over into the gas vents, as no decomposition should be permitted within the flow chamber.

In designing Imhoff tanks the plan and arrangement of the gas vents should receive careful consideration. Unless the sewage is very carefully screened before entering the tank, the gases liberated by the decomposing sludge will bring up with them considerable quantities of solid matters. These will form a thick stratum in traps or pockets under slope walls and in all the vents unless the gases are released therefrom. Therefore, all slope walls should be brought up well above the flow line in such a manner that there are no traps or pockets and in positions to be easily accessible to the plant attendant. In the opinion of the writer, the solids within a mass of scum strongly charged with gases cannot decompose so readily or properly as they would if the gases were removed and the solids allowed to sink to the bottom. Furthermore, the accumulated trapped gases take up valuable space by displacement, and should they for any cause be suddenly set free there is greater danger of unpleasantness. Some of the gases liberated from a mass of decomposing scum are quite offensive and others, such as marsh gas, hydrogen, and hydrogen sulphide, burn, and when mixed with the right propor-

OPERATION OF SEWAGE DISPOSAL PLANTS.

tion of air are quite explosive. While there is no danger in this regard in open tanks, care should always be exercised in entering unventilated closed sewage tanks of whatever type. (The same caution applies to unventilated sewers or manholes, and illuminating gas sometimes leaks into the sewerage system and causes explosions.)

The attendant must, therefore, give frequent attention to the gas vents to keep the scum down and the gases liberated. In the absence of a better scheme, the writer has used a pole with a short piece of board nailed across the end and manipulated in the manner of the old-fashioned churn dasher. By this means a scum over eight feet thick was completely disintegrated and caused to settle in a short time. If a good water pressure is available, a series of jets may be arranged or a hand hose used to play upon the surface of the liquids in the gas vents to keep down scum formation. In this case daily attention is required right from the start, as the method will not be effective if at any time a heavy scum is allowed to form.

If the distributing inlet channel to a single Imhoff tank or battery of such tanks is large and deep, heavy deposits occur in it, and if these are not frequently removed decomposition sets in and the flow is unnecessarily contaminated; also when the flow is reversed (which should be done frequently to allow a more even deposit of solids), some of this material will be washed out in the effluent.

Several of the features above mentioned are well illustrated by the writer's experiences with the Imhoff tanks in New Jersey. At one place the manholes were inadequate to allow of proper attention and after some months it was decided to remove the entire concrete cover. This was done and the eight feet of scum which had accumulated was churned down, as before mentioned, by pushing down the "dasher" through the mass to make a gas vent and then breaking up the scum from the bottom. A very little attention now prevents its reappearance. It was then found advisable to build up the vent walls to prevent the flooding and mixing of

TANKS.

the contents of both flow and sludge compartments during heavy sewage discharge at times of showers. The tank has also large distributing inlet channels which collect a considerable deposit. There being no provision for draining the deposit into the sedimentation chamber, cleaning has to be done by bailing the material over the inlet weir while the sewage is flowing in; for if this is not done before the flow is reversed the accumulated solids are washed into the contact beds. The installation now, with only a very little daily attention from the careful man in charge, is giving excellent results.

At another plant, after a short run the tank had about four feet of scum in the gas vents, which was churned down as in the case just described. Considerable grease and soapy materials in rounded masses remained floating, and if they do not eventually sink they may have to be removed by skimming. The attendant states, however, that even these particles do disintegrate and sink. Certainly the layer does not increase in thickness, although no material has been removed. A scum was beginning to form on the flow chambers, and upon testing the slopes the slots were found covered over with a very deep decomposing mass of settled solids, the slightest disturbance of which caused a violent ebullition of gases and an upheaval of solids charged with bubbles. After having a longitudinal bridge built across the tank to make the slopes accessible, instructions were given to push the solids through the slots and keep the slopes clean by frequent attention. At the next visit of the writer there was still some deposit on the slopes; but no doubt this was because the tool did not fit the slots so as to shove all of the solids clear through into the lower compartment. At the present writing the tank is in fine condition, and only a little attention is needed every other day. The flow chamber is now free from scum and only a thin layer floats in the gas vents.

Figures 2 and 3 are tracings showing the slope arrangement of two-story tanks from two sets of sewage disposal plans on file. Fig. 2 is a section through a circular tank, 30 feet in diameter. The flow is outward, as in-

OPERATION OF SEWAGE DISPOSAL PLANTS.

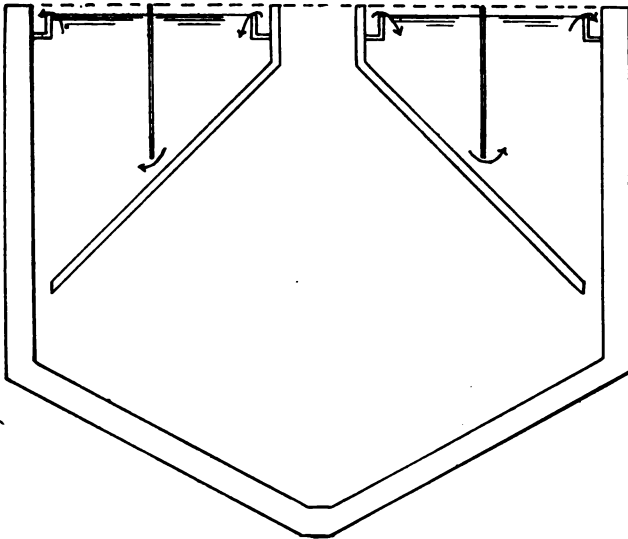

FIG. 2. PLAN SUBMITTED FOR IMHOFF TANK.

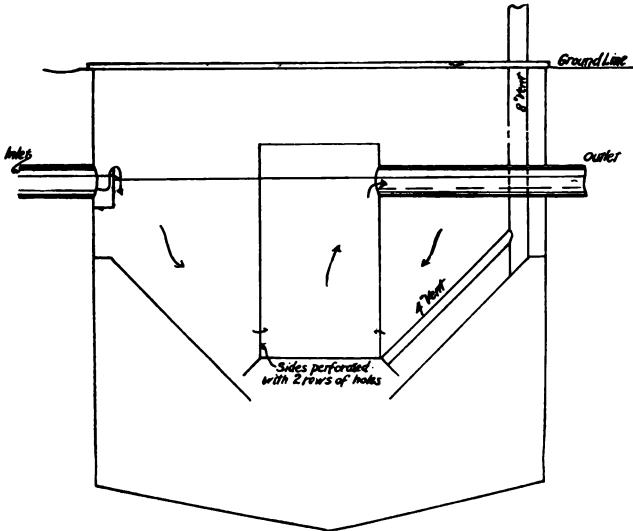

FIG. 3. PLAN SUBMITTED FOR IMHOFF TANK.

TANKS.

dicated. In this the central gas vent is good but no bridge is shown to make the vent easily accessible. Unless little things like these are provided for in the beginning, the operation is likely to be neglected, and this type of tank should receive proper attention from the very start. There may have been some particular reason which led the designing engineer in this case to allow the straight vertical connection between lower and upper stories. The writer would have preferred to have avoided the upward passage of gases by one of the standard methods, such as a contraction of the lower chamber, a fillet-like thickening of lower wall, or another slope with extra gas vent. In a tank of this design it would seem that the greatest deposit of solids will be in a ring near the wall and not at the center where the sludge outlet pipe is located.

In Figure 3 we have a section of a circular two-story tank, 15 feet in diameter. This tank is covered and is almost wholly inaccessible. The flow enters at one side into a trough extending around the tank and over a circular weir, radially toward the center and out by way of a central cylinder, as indicated. The central cylinder is to receive also a disinfectant. It will be noticed that there are two scum traps or pockets, one under the central cylinder and one under the main circular slope. There are four 8-inch gas vents to the larger pocket and two 4-inch vents to the smaller pocket. The writer believes these pockets will fill up with scum, which may interfere with free passage of gas through the slots.

This plant was built square instead of round, was covered with a concrete roof, and the 8-inch vents were brought together under the cover and connected to a central ventilator. There is now no way of determining what is going on in the lower chamber, not even by sounding down a vent pipe. A heavy scum forms in the upper compartment and when cleaning is done the sewage has to be by-passed and the entire contents of both upper and lower chambers pumped out from below. On account of the heavy deposits accumulating in it, the inlet channel was removed entirely. Recently the tank was

OPERATION OF SEWAGE DISPOSAL PLANTS.

cleaned out by the attendant, but little can be learned of the actual conditions within. At present a new scum is forming upon the sewage in the upper compartment and the slot is covered over with a deep mass of solids which cannot be pushed through because the slopes are inaccessible.

Although this plant gives under the present conditions a very fair effluent, it would appear that the real purpose of the two-story design has been defeated.

In another horizontal flow Imhoff tank the central slopes were brought together like a sharp gable roof with only two chimney-like vents. The writer believes

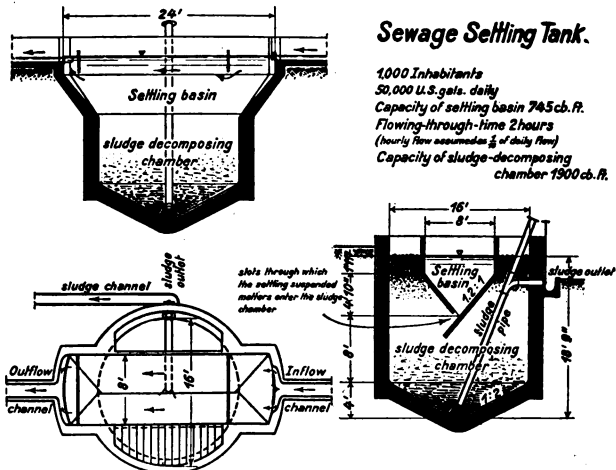

FIG. 4. APPROVED PLAN FOR IMHOFF TANK.

it would have been better to have opened up the slopes the whole length after the style shown in Fig. 4, so as to avoid the scum trap.

The sludge in an Imhoff tank should remain in its chamber until it has become thoroughly decomposed and transformed into a black humus-like mass. The process will take some time, possibly several months, depending upon local conditions; but as the older sludge becomes ripened it should be withdrawn to make room for the

TANKS.

newer deposits. This will require some care and good judgment on the part of the attendant. He must learn by experience when to draw and how much to let out at a time, and every plant may have to have a slightly different routine. Sounding with an iron plate on a wire or some other convenient method may be used to determine the depth and rate of deposit. If sufficient storage capacity has been provided, the top of the deposit should not be allowed to reach nearer the slots than about two feet for fear of the denser strata overlying the sludge extending into the upper chamber and the possible diffusion of decomposition products. The sludge should be withdrawn at frequent intervals and only so much let out as can be conveniently handled on the drying bed, or until there is the slightest indication that only partly decomposed materials are beginning to flow out. The drawing should be done slowly and carefully so as to allow the sludge to settle evenly and not cause a breaking through of fresher materials into the inlet end of the sludge pipe. The attendant will have to learn the difference between good and bad sludge. Good sludge should be dark in color, more or less granular and not sticky or pasty, should not have offensive odor, should be somewhat frothy and a good deal like black garden soil mixed with water. If a pailful be poured out and the pail put in an inclined position, what was in contact with the surfaces of the pail will separate and clear streaks will appear upon the metallic surfaces. Bad sludge is only partly decomposed, is usually lighter in color, has offensive odor, does not dry rapidly, and is somewhat sticky or pasty. This should not be withdrawn, but should be kept in the tank to ripen.

After withdrawing sludge, all sludge pipes should be flushed out with clear water or clarified sewage so as to prevent stoppages from dried deposits. It is also well to backfill the sludge pipes with water or clear sewage if it can be done.

FOAMING.

During the present summer two very interesting occurrences have taken place at two New Jersey sewage disposal plants. The happenings were similar, although one tank was new while the other had been in operation

OPERATION OF SEWAGE DISPOSAL PLANTS.

for about two and a half years. In both cases excessive foaming or frothing occurred in the gas vents, which for a time caused considerable trouble and uneasiness. In one case the froth would boil over the vent walls in a couple of hours and cover the settling compartments, causing a perceptible increase in the turbidity of the effluent. In the other case, on account of the very high walls, the froth did not get over, although it became five or six feet thick during the times it was left undisturbed.

Ordinarily there is no foaming whatsoever in the gas vents of the Imhoff tanks. The solids which are brought up by the gases, when broken up by means of a paddle or jet of water, settle very quickly except for such particles as grease, match-sticks, tomato peels and certain fresh materials which have not yet become sufficiently disintegrated. Under this layer of floating matter is a stratum of comparatively clear and watery liquid, which is incapable of sufficient surface tension to hold the gases in the form of bubbles to constitute a foam.

The sudden behavior of these two tanks was naturally watched with interest and it must be confessed that at present the writer is not in a position to state positively what the cause really was, but after describing events leading up to the occurrences, he will give what he believes to have been the cause in each case, and the precautions to be taken to prevent such happenings in the future.

Take the first case. Here conditions were somewhat abnormal. The plant was constructed at the end of a comparatively short sewerage system, with a new outfall which was almost perfectly water tight. On the day the plant was put in operation the ground water flowing in the outfall was less than a quarter of an inch deep. The tank itself was empty. The sewage, which up to this time had been disposed of on a large broad irrigation area, was of a very strong character and heavily charged with suspended matter.

The connection leading to the old field was broken and the strong sewage was turned into the empty tank on April 1, 1914. For a while nothing unusual happened and the attendant was instructed to break up the scum as it formed. Upon the advent of hot weather the tank

TANKS.

got the better of the attendant and the writer was asked for advice. It was then noted that matters were getting serious. The scum had become several feet thick in the side vents and in the center vents it was over thirteen feet deep. There was no sludge whatever at the bottom of the tank. The side vents are wider than ordinary, which is a very good feature, considering the sewage at this place. The central vents, however, are chimney-shaped and but three in number, located over the A-shaped central slope. This is very unfortunate, as it is impossible to clear out the accumulated scum under the central A-shaped slopes. The troubles are further aggravated by flat horizontal beams under the slopes, which seem to catch and hold scum. Also the work on slopes and vents is interfered with by numerous and very wide concrete foot-ways across the tank. The accumulations had become so great that ebullition was taking place up through the slots.

Since the tank was single, and no portion could be cut out, something had to be done quickly to relieve the situation. The flow was reversed and with the aid of an extra man the scum which could be reached was churned down. It was unfortunate that a water pressure was not available, as this would have been of great assistance. Even a portable pump, using some settled sewage, would have helped. The side vents gave little trouble, but the central chimneys began to foam with great rapidity. Little difficulty would have been experienced with this had a supply of clear water been available, as the foam is easily subsided by a spray of clear water. In order to protect the settling chamber the attendant decided to dip off and remove the foam every day, although it ran over during the night. In a few weeks the tank began to show signs of being quieter, especially as the summer flow of sewage was comparatively light. The attendant was told not to remove any more scum unless there was danger of an overflow. Conditions are now getting to be more nearly normal, although on account of lodged scum under the slopes there is a constant bubbling of gas along the line of the slots.

While the writer has no positive proof as to the cause

OPERATION OF SEWAGE DISPOSAL PLANTS.

of the foaming, he has this theory: The filling completely with such a strong sewage put so much matter in the sludge compartment that, when violent ebullition occurred, the liquids were so viscous that the gas bubbles would not break and a froth resulted—the whole mass “working over” much like a barrel of cider. After the tank has “worked” itself out, the supernatant liquid loses its viscosity and the gas bubbles break without causing any foam. Then as new matters come in they are not added fast enough to upset this equilibrium, and in this regard the tank takes care of itself. If, however, it should be drawn down very low and refilled with raw sewage, a repetition is likely to occur, as will be shown presently.

The writer believes that before the tank was put in commission, a fire hose should have been turned into the sewer and the tank filled with clean water, after which the sewage should have been turned on. This would have given a supernatant liquid of low viscosity from the start, which would have allowed the gas bubbles to break. It is further believed that even after the foaming had begun, had clean water been available and about a half tankful carefully run into the gas vents, the troubles would have been lessened, or the foaming could have been effectually kept in check by a constant or frequent spray of clean water.

Usually there is considerable ground water in a plant before starting, but where this is not the case it would appear that the tanks should be filled with clean water before turning in the sewage.

On account of the lack of water and the trouble caused by the foaming, the writer was unable to test out his theory.

It might be mentioned that kerosene breaks the bubbles and keeps down the foam excellently for a short time, but as solid matters are brought up they mix with and absorb the oil, so that the remedy is only temporary and foaming again begins. The scum mixed with the oil is also harder to settle. The application of lime seemed to have no beneficial effect in reducing the tendency to foam.

Close observation of this new tank has tended to strengthen the writer's views which he has before ex-

TANKS.

pressed, viz.: that the gas vents should be of ample size and easily accessible; that the under sides of slopes should be made smooth and without any projecting ledges or pockets; that the chimney form of vent should be discarded and the vent opened up for the whole length; that wherever possible a supply of clean water should be furnished, and that in designing tanks the character of the sewage should be considered more carefully than now is usually the case. A tank that will work excellently with one sewage may become almost a failure when taking a sewage of a different character.

The second case was with a tank that had been running two and a half years and had never foamed. Just before the hot weather this tank was drawn down for some repairs and allowed to refill with raw sewage during a dry time, after which violent foaming occurred. The writer happened to make the plant a visit just at this time, and after trying several things, advised the use of a stream of settled sewage from a portable gasoline-engine pump which is kept at the plant. By this means the foam was quickly settled and kept down until the tank had "worked" itself off. In this case the writer believes it would have been better to have refilled the tank with settled sewage from one of the other tanks, or, better still, with the supernatant liquid from an adjoining tank which had been standing idle for some time.

The other tanks at this plant, which had not been disturbed, worked right along without showing the slightest indication of foaming.

DISTRIBUTING CHANNELS.

Recently the writer, in observing the operation of a new Imhoff tank, was struck by the dissimilarity between conditions in the terra cotta sewers and in the concrete conducting and distributing channels at the tank. It is now well recognized that sewers should be smooth and with as small a wetted perimeter as practicable, yet little if any attention is paid to those requirements at the tank. In this case the concrete was very rough, the conduit was rectangular, and the fastest particle moving in the flow was traveling at the rate of but four inches a second. It is needless to say that an enormous amount of sedimenta-

OPERATION OF SEWAGE DISPOSAL PLANTS.

tion was occurring in the channel, which no amount of stirring could prevent in this eighteen-inch depth of sewage. It occurred to the writer to wonder why it is that such channels are not made very smooth and semi-circular or egg-shaped, instead of rectangular.

It is recognized that the lack of head necessitates certain constructions which would not otherwise be permitted, but, other things being equal, sewage should be transmitted and distributed with a cleansing velocity until the settling chamber of the tank is reached. While the writer has usually advocated the use of pipes for distributing purposes, it seems that some such conduit as suggested might be made more satisfactory than those of the present practice.

It might be interesting to mention that shortly after making the above observation the writer happened to drop in on an engineer and noticed that this engineer was at work on a set of plans for a new sewage plant which was to have semi-circular distribution channels.

The large rectangular channels across the ends of Imhoff tanks, separated from the settling compartment by a weir, cause no end of trouble, and while the writer has usually advocated a pipe for inlet and a weir for outlet, it has occurred to him that a semi-circular channel with a long slot in the bottom, might be a good combination for inlet and outlet for reversible tanks. The slot could be formed in glazed terra cotta or moulded in smooth concrete.

Sewage and solids would pass through the slot and a sweep of a broom now and then would dislodge and push through anything caught. Rectangular channels with holes and plug valves have been used, but it seems that these long slots would be an improvement over the holes.

The effluent would also travel up through the slot and the flow line could easily be controlled by a short weir across the end of the outlet channel.

SLUDGE BEDS AND SLUDGE DISPOSAL

While the sludge bed is a very important adjunct to a sewage tank, its management should not be a difficult matter. It should be quite porous, well underdrained

TANKS.

and not too deep. Distributing troughs are of no practical use and are only in the way.

Beds containing freshly settled or only partially digested material are likely to cause offense from odors, and it often becomes necessary to cover such deposits with lime or earth to prevent nuisance. On the other hand, well-digested or good Imhoff tank sludge has very little odor.

Sludge can be handled faster by letting out a comparatively small quantity at a time, allowing it to dry, and then removing it from the bed before the next portion is drawn off.

Sedimentation tank sludge will probably require considerable time before it will be in a condition to remove from the bed, while well-digested and especially Imhoff tank sludge dries so rapidly that it may be removed in a few days. In cold weather, sludge is often advantageously removed in a partly frozen condition. In the same manner shallow open settling tanks may be cleaned out. The liquids are drawn off and when the solids are partly frozen they are shoveled out.

The disposal of sludge will depend upon local conditions. It may be put on land, dumped into some low place or disposed of in other ways, according to circumstances. But care must always be exercised in handling or disposing of freshly settled or partly decomposed materials or else a nuisance is likely to occur. Good judgment on the part of the attendant, however, will usually take care of this part of the sewage disposal problem.

TAKING SAMPLES IN TANKS.

It is often desirable to take samples at various depths in sewage tanks, for the purpose of ascertaining the exact condition of the tank contents at different elevations, and to determine the position of the sludge line. Several methods for doing this have been employed, notably at those plants where laboratories were near at hand. But the writer often has use for a simple portable apparatus which can be easily rigged up and used anywhere, and after use discarded, except those parts which can be easily cleaned and carried.

OPERATION OF SEWAGE DISPOSAL PLANTS.

In thinking the matter over the idea occurred of attaching bottles at known intervals to a rod or pole; by standing such an arrangement upright in the tank, samples could be taken almost simultaneously in a vertical line at known distances from the bottom. The next step was to devise the simplest possible opening and closing device for the bottles, and in consultation with R. B. Fitz-Randolph, chief of our bureau, he suggested the use of a brass plug with a central rod and toggle. This suggestion was immediately acted upon, and the writer made up sixteen plugs to fit our regulation putrescibility sample bottles, as shown in Fig. 1. The bottles are what are known as 4-ounce Philadelphia ovals, with glass stoppers. The brass plug can be made in a few minutes, as follows: A piece of $\frac{3}{4}$ -inch brass rod is sawed off one inch long, and through the center rod is bored a $\frac{1}{4}$ -inch hole. A piece of $\frac{1}{4}$ -inch brass rod is cut off four inches long, and driven through the hole in the $\frac{3}{4}$ -inch piece. This is then put in the lathe chuck and the stopper portion turned to fit the taper of the bottles, which is sufficiently exact to make the plugs interchangeable. An increased taper is given the bottom

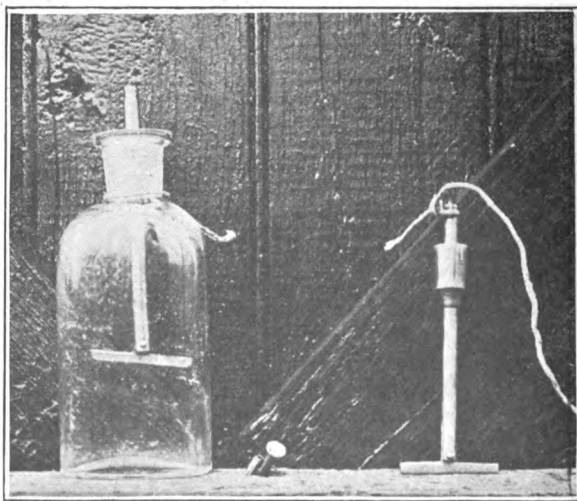

BOTTLE AND BRASS STOPPER, ROD AND TOGGLE.

TANKS.



ROD WITH BOTTLES ATTACHED.

end, so it cannot catch upon the top of the bottle when it drops into position. A hole is bored through the top of the center rod and the bottom end is slotted to receive

OPERATION OF SEWAGE DISPOSAL PLANTS.

the toggle. The toggle is sawed from a strip of brass with a side tongue, through which it is pinned in the slot of the center rod, as shown.

A convenient number of bottles so fitted up can be attached to a strip of board, say $\frac{7}{8}$ inch by 3 inches by any convenient length. The attachment is made by driving into the board a wire 10-penny finishing nail, and bending the end upward, under which bent end the bottle is pushed, and rests upon the body of the nail with the flat side of the bottle against the pole. The nail and a string tied around the neck of the bottle and the pole hold the bottles quite securely. The bottles are spaced at desired intervals, and cords are led from each stopper to the top of the pole and fastened to tacks in positions corresponding to the position of the bottles.

After affixing the bottles to the pole, with the brass stoppers inserted and the cords arranged, the whole apparatus is put down into the tank and allowed to remain some minutes, until the tank becomes quiet again. Then the top cord is pulled, which releases the air in the top bottle. When the bottle is full the cord is let go, and the brass stopper falls into place by means of its own weight, the toggle having prevented it from being withdrawn from the bottle. The other bottles are filled in rotation from the top down (to prevent agitation around a bottle, due to the escapement of the air from the bottle below), after which the whole apparatus is taken up and washed off, if necessary. The bottles are cut loose and the brass stoppers removed by turning the toggles against the flat side of the bottles, which causes them to remain upright and slip out. If desirable, a preservative may be added and the glass stopper replaced when the samples are ready for transportation.

The brass plugs are washed and taken along, but the rest of the outfit may be left at the plant for future use, or thrown away. It is well to use rather large-mouth bottles below the sludge line, and if samples for dissolved oxygen are required, the bottles may be filled with an inert gas or with some light oil in place of air.

To get a series of samples in intermediate positions

TANKS.

the bottles need not be rearranged upon the pole, but a series of stops can be attached to its lower end.

The apparatus has been found to work well in practice, and already other workers have stated their intentions of having some made for use.

III

FILTERS.

Contact, Sprinkling and Sand Filters, Land Treatment and Sub-surface Irrigation.

In many localities the mere straining or clarification of sewage is insufficient for the prevention of nuisance or pollution of watercourses. It has been stated that the removal of only the suspended matters from a well mixed sewage eliminates but one-seventh of the organic impurities, while six-sevenths remain in solution.

CONTACT FILTERS.

During the past twelve or fourteen years contact filters have been used for the purpose of treating sewage liquids in America, and although they are now giving way to the more rapid sprinkling filters, over two dozen sewage treatment plants equipped with contact beds have been installed in the state of New Jersey alone. The disadvantages, such as area required, cost of maintenance, etc., and the advantages, such as low operating head, less danger of nuisance from odors and flies, are fully discussed in books on sewage disposal, and the advisability of building contact beds is always considered except in the cases of large installations.

The contact bed consists of an uncovered water-tight tank, or compartment, filled with broken stone, coke, slag, or coarse gravel, to which clarified sewage may be applied until the interstices are filled. After the sewage has stood in "contact" for a time it is withdrawn.

The process, therefore, has four phases, namely, rate of filling, time of contact, rate of emptying, and period of rest. For a long time the action of a contact bed was not properly understood, and no doubt many failures can be directly attributed to the fact that the relative importance of the phases mentioned have not always been recognized. The process is aerobic, and shutting off air by keeping the voids of the stone filled too long sets up anaerobic action, and defeats the purpose of the

FILTERS.

filter. After a bed has been in service for a time jelly-like films form upon the surfaces of the stones, and while the sewage is in contact with these films important changes in the liquids occur by a process known as adsorption. As this process is comparatively rapid, the bed is soon drained to allow the entrance of a plentiful supply of air to enable the organisms in the filter to continue the process of oxidation, and to regenerate their bio-chemical activities. This empty or resting phase is of prime importance, and sufficient time should always be allowed between fillings to enable the filter to become fully prepared for the next dose.

Although little is known of the actual bacterial types in a contact bed, there seem to be at least three reactions involved—hydrolysis and denitrification during the full period, and nitrification during the empty period.

In addition to the bio-chemical processes touched upon, there is also more or less sedimentation in a contact filter. This part of the work, however, is purely physical.

The effluent from a contact bed in good working order is fairly clear, and often non-putrescible. It is quite different from the liquids which entered the bed, although it is often passed through secondary contact filters or sand beds for further treatment. In this way sewage may be successfully handled at rates in the neighborhood of half a million gallons per acre per day.

It should hardly be necessary to mention that walls and foundations should be designed to withstand all pressures encountered; but the writer has at present under observation a filter which has to be emptied and repaired on account of a failure of its foundation. The walls should also be tested for leaks, and if there are any they should be repaired before the filter is put in commission. An apparently insignificant leak in a contact bed so interfered with the automatic control apparatus of one of our plants that it went practically out of business.

Good results have been obtained from using crushed stone, hard coke, furnace slag, or good hard clinker for a filtering medium. Stone is perhaps more durable and

OPERATION OF SEWAGE DISPOSAL PLANTS.

not so likely to disintegrate. Coke and clinker often give better results at first, but as such substances choke up more quickly, they have to be removed and cleaned sooner than stone.

On account of the greater surface area of the particles, fine filtering material gives better results than coarse; but as fine filters clog up much more quickly than coarse ones, the tendency now is toward the coarser material. A rather homogeneous mass consisting of particles about an inch and a half in diameter gives good results, although for secondary beds the material may be somewhat finer.

While four or five feet are considered good depths for the stone, beds are often made much shallower than these depths on account of lack of the necessary fall. Some of these shallow beds are doing good work.

The total volume of the interstices or voids in a new filter usually ranges between 40 and 50 per cent of the whole. This is reduced more or less quickly by one or more factors, such as settling together of the material, disintegration, growth of organic films, deposition of insoluble sewage substances, and impairment of drainage. As the percentage of voids during operation may be decreased to 20 or even 10 per cent, it is evident that good hard material of proper sizes should be selected to start with.

Since a bed should be emptied quickly after its period of contact, rapid drainage should be provided for. The best filters are now built with a false bottom of drain tile, supporting a layer of coarse stones, above which is the filtering material proper. This allows quick and complete drainage, prevents the formation of objectionable deposits of suspended matter, and aids in aeration. The sewage in the false bottom does not get much purification, especially in underfed beds, as it does not come in contact with the filtering media, but this objection is insignificant compared to the benefits derived from the better drainage and aeration.

The size of the outlet should be ample and so located that the bed drains clean after every dose.

FILTERS

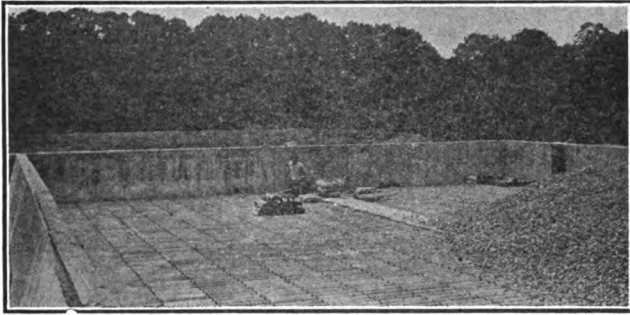

FALSE FLOOR OF DRAIN TILE FOR CONTACT BED.

The number and sizes of the units are important also. This is too often overlooked by designing engineers. The flow of sewage should be carefully measured or estimated, and the plant so designed that fluctuations or increases in flow can be properly taken care of. The beds should be so proportioned that the time of filling will not be excessive, and enough units provided so that each will receive at least two, but not more than four, fillings per day.

The successful management of a set of sewage contact filters is not so simple as many persons would have one believe. John D. Watson, who is in charge of the works at Birmingham, England, in a recent paper said:

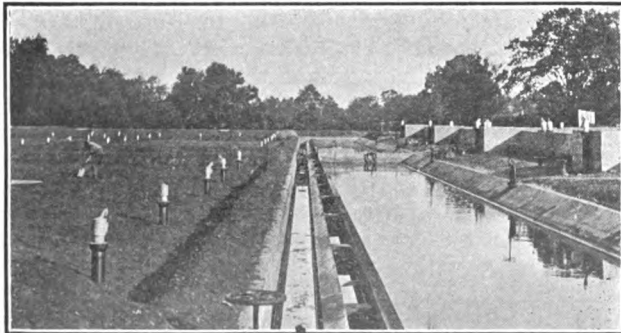

SETTLING BASINS FOR CONTACT EFFLUENT.

OPERATION OF SEWAGE DISPOSAL PLANTS.

"However well a plant may be designed, if it is not well and skilfully managed it will become a nuisance and bring discredit on the engineer who designed it. The disposal of the liquid filth of a great community has an enormous potentiality for evil, and if town authorities believe it necessary to avert this by expending large sums of money on constructional work, it is their bonden duty to see that the plant is placed in the most competent hands. Local authorities are by no means sufficiently alive to this aspect of the question, with the result that too many works are left to the management of untrained men. Hitherto anybody has been deemed good enough to look after a sewage work, but the day has now come when the manager should be a highly trained technical expert if local authorities hope to get full value out of the sensitive entity which we call a bacteria bed."

While the above is quoted to emphasize one of the fundamentals of sewage disposal, it is by no means intended to discourage any conscientious person in charge of a sewage treatment plant. Let the plant attendant study the principles of his filters, all the local conditions involved, and the desired end to be obtained. He should work according to standard methods of procedure, but should always be on the lookout to make changes therefrom whenever results justify. His records should be so kept that they will demonstrate the advisability of any departure from the usual practice.

New contact beds require a certain time in which to ripen or become efficient. This may take days or even several weeks, depending upon the temperature or whatever else affects the growth of the bacterial films on the surface of the substances which are used to make up the filters. Until these growths are established there will be little or no purification, and during the ripening period it is well to throttle the outlet valves and empty slowly because a very rapid or violent draining tends to retard the formation of the films.

The time of filling a contact bed will of course depend upon the relation of its capacity to the rate of flow of the incoming sewage. The actual filling time, however, should be reasonably short, say about an hour, but in

FILTERS.

many plants this time is often exceeded without serious consequences. Since the process of adsorption requires only a relatively short time, holding sewage in contact beds beyond this period tends to set up undesirable anaerobic conditions, which are detrimental to both the beds and the effluent.

When the bed is too large, partial filling may be adopted. This is either regulated by hand, or the automatic control apparatus is adjusted to change over the feed when the proper depth of fill has reached that determined upon. Some beds have partition walls, the gates in which can be opened or closed to adjust the capacity of bed to sewage flow. One or more beds are sometimes cut out, using only enough to give the proper rotation.

It must be borne in mind, however, that the main process of oxidation is done during the empty or resting period, so that the time of filling should not be cut down in order to cause too rapid rotation of beds, for this would interfere with proper aeration on account of shortening the periods of rest.

Formerly it was thought that at least two hours standing in contact were quite necessary. This time has now been considerably reduced. Some authorities recommend a holding for only fifteen or twenty minutes, while a few start to empty the beds as soon as full. In general, the writer prefers a standing-full period of about a half-hour, but there are many circumstances that may arise which will justify a slight change in this period.

The time of emptying should be short and the draining should be complete. This is important, as by so doing aeration is aided and the accumulation of sediment is retarded, thereby maintaining the efficiency and prolonging the life of the bed.

At one of our plants the attendant changed the point of cut-off of the outlet siphons, which retained about seven inches of sewage in the contact beds. When this was discovered and the siphons repaired so that the beds drained completely, a large amount of collected sediment came out of the beds at the first discharge.

The importance of the period of rest is not always

OPERATION OF SEWAGE DISPOSAL PLANTS.

recognized. It is during this period that the bulk of the oxidation process is carried on, and the regeneration of the bio-chemical activities brought about. About two or three fillings per day is considered good practice, although sometimes this rule cannot be adhered to.

The regular rotation of the beds is important, and when the best routine is determined upon it should be carefully followed. The writer does not approve of the practice employed at some places, of storing sewage in one or more beds over night. It is difficult for beds so treated to recuperate.

Notwithstanding the foregoing, it may be interesting to call attention to the performance of one of our contact bed plants. The four beds received the effluent from a septic tank through a pair of alternating siphons. The hand gates were changed at 6 A. M. and at 6 P. M., so that for twelve hours the discharge emptied into two beds and for the next twelve hours the discharge went into the other two beds. The outlet valves were partly closed so that the intermittent discharges of the siphons would fill up the beds considerably, but would not cause them to overflow. The beds were composed of comparatively fine slag and cinder, and for years gave an effluent which was clear and non-putrescible. As time went on the sewage flow so increased that the siphons would not break, so that a continuous flow entered the beds for a period of twelve hours. Even then the plant turned out a non-putrescible effluent for about eight hours after each changing of gates at the enormous mid-day rate of six million gallons per acre per day. For a single contact plant this seems somewhat remarkable.

Although the underfeeding of contact filters has advantages, the writer prefers, when possible, to have the beds top fed, especially if the effluent is not discharged into settling basins. He does not attach much importance to the distribution of the dose over the top of the bed, nor does he approve of a layer of fine stone over the coarser material. On the other hand, if there is much suspended matter in the influent the attendant can arrange a small crib or barrier of cinder or stone, which will strain out a very large proportion of the suspended

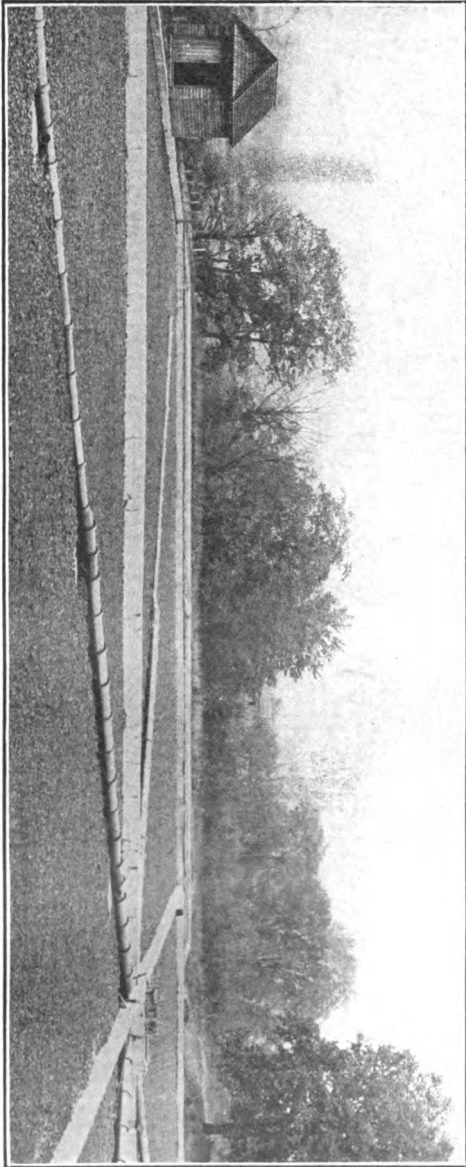

• CONTACT BEDS WITH HAND GATES AND TILE PIPE DISTRIBUTORS.

OPERATION OF SEWAGE DISPOSAL PLANTS.

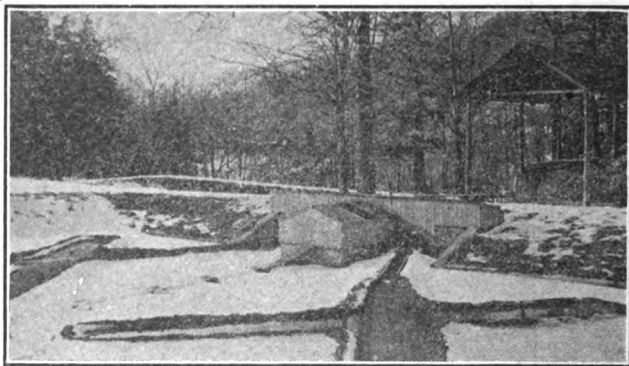

CINDER BARRIERS ON CONTACT BEDS IN WINTER.

matters. This arrangement, if given frequent attention, is easily cared for, and at some of our plants is producing good results. Elaborate systems of trough and tile distributors are unnecessary, and in the end do more harm than good.

It is often the misfortune of a conscientious street superintendent to be put in charge of a set of contact beds equipped with some form of automatic control apparatus. When he examines the outfit he sees a mass of pipes, valves, and what not. What he does not see is under water, stone or concrete. He should have an ac-

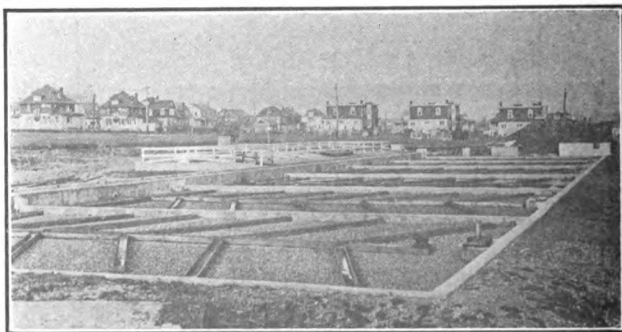

CONTACT BEDS WITH WOODEN TROUGH DISTRIBUTION.

FILTERS.

curate drawing in a frame behind glass, hanging in the control house, but he hasn't; and there is probably no such drawing in existence. These forms of apparatus are often so changed in the setting that it is difficult for even an expert to explain the purpose of every part off-hand. In addition to this drawing, the attendant should have posted a brief set of instructions in regard to the apparatus. This also applies more or less to the whole sewage plant. In an emergency it is often difficult to locate the right valve without a correct diagram. Many times the approved plans on file in the office of the central state authority are utterly worthless in this regard.

A discussion of the good and bad points of sewage control apparatus and of the many difficulties experienced with them would fill the pages of a book. The writer does not condemn them, but wants it clearly understood that they must be watched, and carefully adjusted if they get out of order. They cannot be trusted to run themselves. Worn parts must be replaced, air

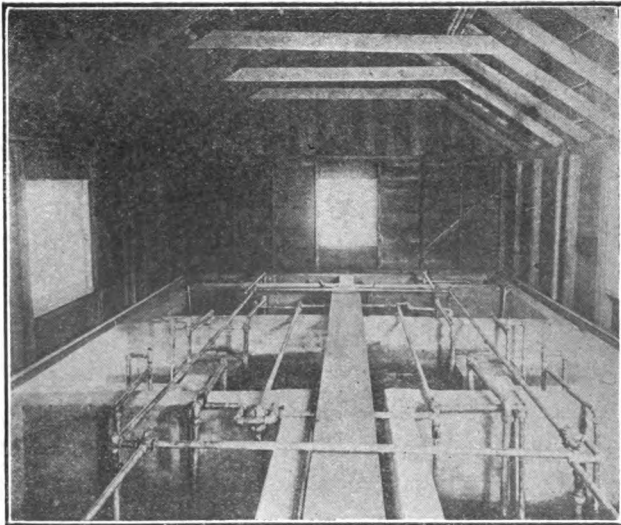

AIR LOCK AUTOMATIC CONTROL APPARATUS FOR CONTACT BEDS.

OPERATION OF SEWAGE DISPOSAL PLANTS.

leaks stopped, stoppages removed, metal parts painted, etc. These things are self-evident. But every little while the flow fails to change over, a siphon fails to hold, a feed fails to lock off, and many times it seems impossible to locate the cause. The best the attendant can then do is to adjust matters and trust to luck to find out the cause next time. Sometimes the apparatus is affected by circumstances over which the attendant has no control, such as storm, high tides, etc. At such times his personal attention is again demanded. The attendant must, therefore, find out in any way possible the purpose of every bell, pipe, valve, lever, float or bucket making up the control apparatus, and what to do in case of failure of operation. He must not wait until something happens to do this, but must be prepared to do the right thing in case of emergency. It is difficult to trace out pipes after everything is overflowing. But whenever possible he should determine and remove the cause of failure to operate. He should also study the limitations and possibilities of the control apparatus so as to be able to make adjustment in order to work the beds to the best possible advantage. A properly installed and looked after control apparatus will work quite satisfactorily; but unless it is in competent hands a plant is better off without it.

The surfaces of contact filters should be kept free

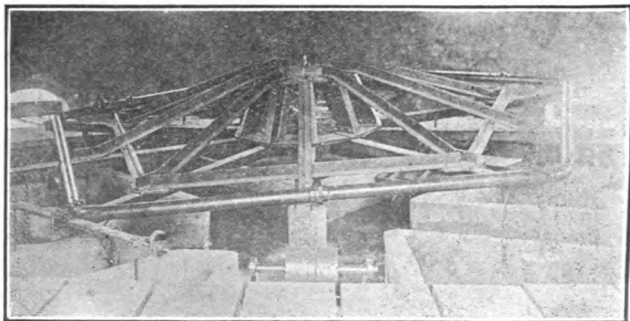

MECHANICAL AUTOMATIC CONTROL APPARATUS FOR CONTACT BEDS.

FILTERS.

from weeds and soil formation. Everything which closes up the spaces between the stones cuts off the free access of air by so much. The same is true of fungous growths. Surfaces which remain wet soon become coated with fungus and blue-green algae. Whenever possible these should not be allowed to form, and if the surfaces are kept clean so that they will dry between doses these growths will be largely prevented. The writer has in some cases advised the cautious application of chloride of lime to keep down these objectionable formations.

When a bed becomes much overworked it is advantageous to cut it out and let it rest for a few weeks. This will give it a chance to recuperate and allow a good deal of the accumulated matter to dry up and unload.

Sooner or later, usually in about five or six years, depending upon local conditions, the filtering material of contact beds has to be removed and cleaned either by washing or by drying and screening. This is an expensive operation, and every effort should be made to keep the beds in good condition as long as possible. Every bit of suspended matter kept out of the beds means something towards increasing their life.

No sewage works is complete unless there is provision for reading the flow of its incoming sewage accurately and conveniently. Among other things, the attendant should keep daily records of the sewage flow and times required to fill the beds. By this means he can watch the decrease in capacity of each bed. These data will be useful as the beds begin to age. He should also note any unusual appearance of the effluent so that it can be correlated with other results. More will be said later concerning tests and records, but it may be mentioned that every plant attendant should at least keep daily records of putrescibility tests. This test is easily performed by almost anyone. A sample of the effluent is taken in a glass-stoppered half pint bottle filled to overflowing. One or two drops of a one per cent solution of methylene blue are added and the stopper inserted by a twisting motion to avoid breaking the bottle and without allowing a bubble of air to remain. The bottle is then kept tightly stoppered at the

OPERATION OF SEWAGE DISPOSAL PLANTS.

ordinary temperature and observed every day. The blue color should remain fourteen days or more, but a color remaining five or six days indicates that considerable purification has been accomplished while the disappearance of the color in a day or two shows that something is decidedly wrong.

Two forms of methylene blue have been used and recommended. One is the usual laboratory stain, while the other is the zinc double salt used in dyeing. The latter is much stronger in color. Avoid using too much blue for fear of interfering with the test. Add only enough to give a good color, and record the first disappearance, as the color sometimes returns.

We have in New Jersey a plant which has filters that have been called both contact beds and trickling filters. They are composed of rather fine gravel, and receive doses from siphons which discharge into a system of distributing troughs. The effluent from the primary beds passes through similar secondary beds, and its detention in the beds is very slight. When operated within its capacity, this plant gives good results. Such a plant forms a connecting link between contact beds and sprinkling filters, and, as in the case of sprinkling filters, even distribution of the dose is of prime importance.

SPRINKLING FILTERS.

In many respects sprinkling filters are very similar to contact beds; in fact, the Columbus filters are built so that they can be operated as contact beds if so desired. On account of the high rates of operation, they are considerably cheaper than other kinds of installations for secondary or oxidation treatments of sewage, and they are now always considered in the designing of works for the larger cities.

Briefly, sprinkling filters consist of a pile of moderately coarse stone or similar material upon which is sprayed, or delivered in fine jets, the clarified sewage to be acted upon. The beds must be well underdrained and well ventilated so that a plentiful supply of air permeates the filters at all times.

Although this type of treatment had been established in England for a few years, the first recommendation

FILTERS.

of its adoption in this country was made in 1903. For lack of funds, however, the plant was not built for nearly ten years thereafter. In the meantime, sprinkling filters were built at a few other places, and at present there are in New Jersey three such plants in operation, with several others in the process of construction.

The filtering material generally used in this country is crushed rock, although several other materials are good, provided they are hard and not susceptible to disintegration. The writer has had experience with cheap salmon brick for this purpose, and while the purification of the sewage was fair the frost during the winter caused a very excessive crumbling of the bricks.

Although the size of the particles is important, this depends upon several factors. Fine material presents a greater total surface area, but there is greater tendency for the interstices to become clogged with sediment or growths. In sprinkling filters both processes of contact beds, adsorption and regeneration, take place simultaneously. Therefore there should be as great a surface as possible presented to the sewage and nothing should be allowed which will interfere with the proper aeration of all parts of the beds. In general, good hard crushed stone, from one to three inches in size, is considered good filtering material. About six feet is considered a good depth, although here again there may be a variation according to circumstances.

The underdraining is of very great importance, and the writer advises a false bottom construction so arranged as to permit the least obstruction to free drainage and ventilation.

In order that the filter shall work at its maximum efficiency, there must be even distribution over the surface so that all particles will receive their proper share of the dose. To accomplish this, several forms of distributors have been devised. Rectangular traveling distributors and revolving perforated arms have been extensively used in England and Germany, while American engineers have generally adopted some form of fixed spraying nozzle. These are so arranged that the area of the stone is quite evenly covered by the inverted

OPERATION OF SEWAGE DISPOSAL PLANTS.

conical sprays, especially when provision is made for varying the head during the dose. The variations in head are brought about by a butterfly valve worked by a cam, or by a tapering dosing tank emptied by means of an automatic siphon. The maximum head on the nozzle is from five to eight feet. This is reduced as the discharge goes on, so that the spray becomes contracted and wets the stone nearer the nozzle. Then the flow is suddenly cut off for a few minutes until the next dose. While this undulation may be of little advantage to the process of purification, as shown by constant discharge upon splash plates working beside the other process, it nevertheless permits of a better surface distribution, and allows the use of a nozzle with a larger opening. There are now several good nozzles on the market, and in selecting one for an installation its distribution, liability to clogging, chance of becoming detached from its riser, and how it is to be cleaned should be considered. The writer once, when visiting a plant to take a picture of the nozzle sprays, found some nozzles blown out; others held down, each with a stone upon the spreader, and 90 per cent. of the rest partially or completely stopped up.

At one of our factory installations the distributing pipes are above the stone, and the nozzles are inverted with the rims of the spreaders upturned. These give

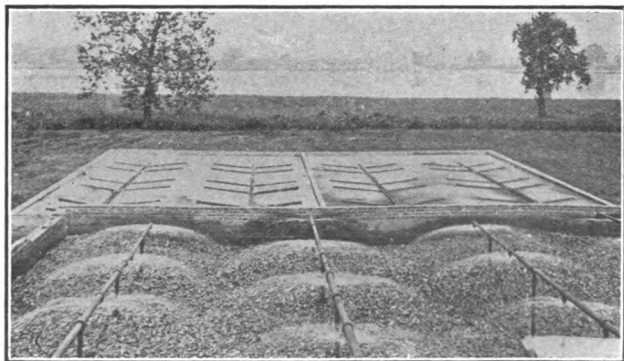

SPRINKLING FILTER WITH INVERTED NOZZLES.

FILTERS.

good sprays, and whenever the discharge ceases the whole system drains, which not only prevents freezing at night but also retards the formation of fungous growths in the nozzles. Although the character of the sewage may partly account for it, these nozzles do not require any attention oftener than once or twice a year.

In order to reduce the clogging of nozzles and surface of the bed, the sewage delivered should be well clarified, and rags, lint, hair, leaves, match sticks and the like should be especially guarded against.

As the final effluent always contains more or less suspended matters unloaded from the stones, a final settling tank is often advisable, especially if the effluent is to receive further treatment. This suspended matter is highly putrefactive when collected together, although a sample of the effluent, as it leaves the filters, may be entirely non-putrescible.

The writer does not believe that covers to sprinkling filters are necessary or even advisable in this latitude. He knows of an uncovered sprinkling filter working successfully at a temperature of 16 degrees below zero.

From the foregoing it can be seen that it is the duty of the plant attendant to keep every nozzle doing its work; to keep the surfaces of the beds free from any growth, ponding, or other accumulation which will tend to obstruct either even flow down through the stones or free ventilation; to watch the condition of the effluent as to both its putrescibility and amount of suspended matter; to keep valves and other appliances in good order, and to be on the lookout to prevent troubles of any kind. The process, being continual, needs daily attention. The nozzles should be examined every day; growths may be corrected by the judicious application of a disinfectant, such as chloride of lime; the flow of sewage should be read and recorded daily, as also the results of putrescibility and sediment tests. The putrescibility test is performed by means of methylene blue as described under contact beds, and the sediment test as described under tanks. Ponding is often the result of a partially clogged or a blown-out nozzle, and when this occurs repairs should be made at once.

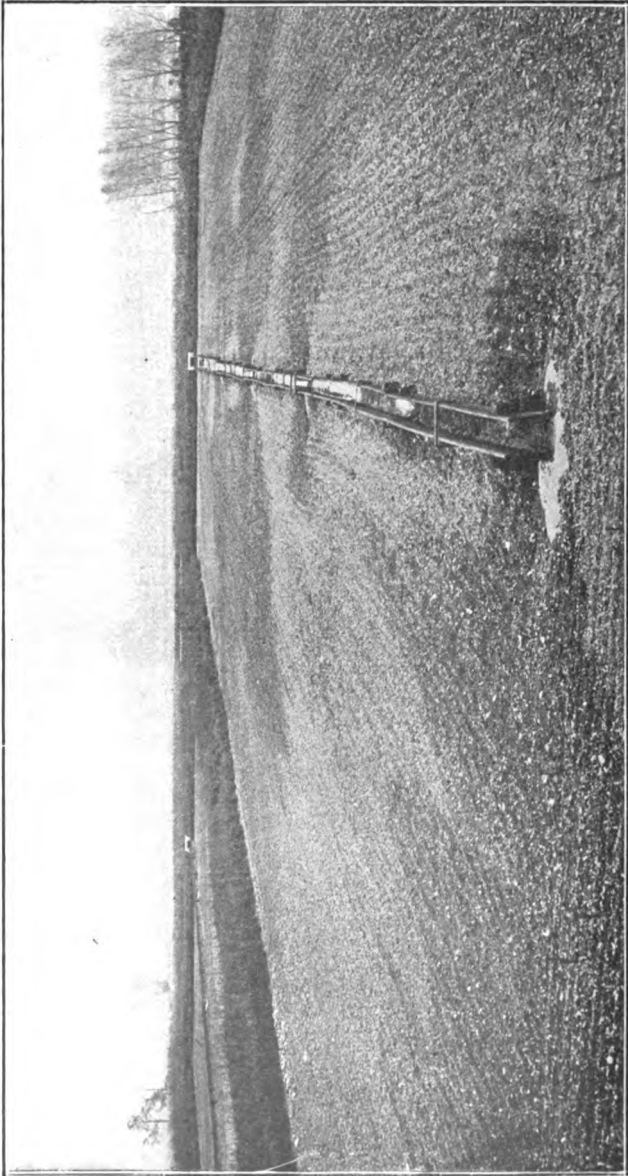

ARTIFICIAL SAND BED WITH WOODEN DISTRIBUTOR.

FILTERS.

There are other systematic analyses which should be made by the trained attendant with a laboratory, but these will be taken up later.

In putting a new filter in service the attendant should keep a record of its work, for some mature rapidly while others take a longer time. The writer has now a non-putrescible sample from a sprinkling filter which has been in operation only four weeks, during which time there had been several days of zero weather.

FINAL SETTLING BASINS.

As intimated above, these are generally installed to receive the effluent from sprinkling filters, and often to receive the effluent from contact beds. For this purpose the writer prefers the Imhoff type, if possible, although plain settling tanks answer very well, provided they are cleaned out frequently. If they are operated continuously for a long time, putrefaction sets up, resulting in a scum formation and a deleterious effect upon the effluent. The sediment should be drawn off, drained and disposed of as sludge.

SAND FILTERS.

Sand filters are often used for the treatment of the liquid effluent from other processes of sewage disposal as well as for the treatment of raw sewage. Such a treatment, if properly managed, gives an excellent effluent which is highly oxidized, free from suspended matter, perfectly stable, and with a very low bacterial count. One of our sand filter plants which receives sewage from settling tanks gives at times a perfectly clear and stable effluent, with a total count of less than 200 bacteria to the cubic centimeter. Effluents of that character have often been drunk directly from the discharge of the underdrains, but the writer does not recommend or advocate, under any circumstances, the drinking of the effluent from any of the present systems of sewage disposal.

Sand filters originated in England over forty years ago, and since that time they have been extensively employed in that and other countries. It was largely due to the work of the Massachusetts State Board of Health that the process of intermittent sand filtration was brought to a high degree of development, and for years

OPERATION OF SEWAGE DISPOSAL PLANTS.

the annual reports of that body have contained valuable information and data concerning sand filters and the results of their use.

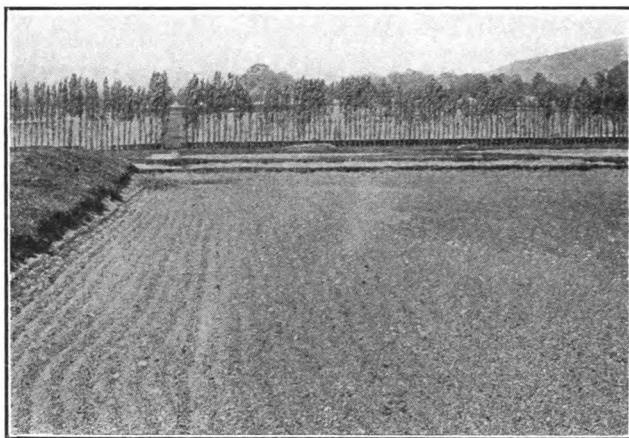

SEWAGE BED OF NATURAL SOIL WITHOUT UNDER-DRAIN.

Wherever cheap sandy areas have been available, intermittent sand filtration has been considered a very acceptable method of sewage purification, and until recent years it was practically required that the output of a sewage treatment plant, if discharging into a small stream or into one used for a water supply, be an effluent from a sand filter or its equivalent. This often necessitated the transportation of sand, screened or natural, for considerable distances. In the state of New Jersey alone there are about three dozen plants equipped with sand filters of one kind or another, ranging from natural soil areas to artificial beds composed of carefully selected screened filtering sand.

Notwithstanding the fact that this process gives an effluent the characteristics of which are almost ideal, the cost of such treatment is prohibitive for large quantities of sewage because of the expense of the area of ground necessary and of the sand required for the fil-

FILTERS.

ters. Often in the neighborhood of cities a suitable site of sufficient area is not to be had at any price. Under those conditions other methods of treatment, some of which require one-tenth or less space, must be adopted.

The filtering material for intermittent beds may be, as before intimated, almost any porous soil, or other fine grain material. For instance, we have in this state beds of natural sandy loam with a few underdrains, beds of natural sand and gravel with no artificial underdrains whatever, beds with underdrains over which has been placed sand carted in from the pits just as it was excavated, and beds composed of sand carefully screened according to specifications.

While any of these types of beds will work, good results depend largely upon the operation, which is somewhat different for each kind. If a natural area has to be used, then the only thing to do is to adjust the operation to the local conditions; but whenever artificial beds are constructed, several factors should be carefully considered. The size of the sand is important, as it has a direct bearing upon rates of application, free drainage and aeration. Fine sand gives an effluent with a low bacterial count, but unless very small doses are applied, with long periods of rest between, the substances in solution will not be oxidized, and a putrescible effluent will result. On the other hand, coarser sand will give non-putrescible effluents at higher rates, but at the expense of the bacterial reduction. An effective size of 0.25, 0.3, or 0.4 millimeters, therefore, becomes a matter of choice. The sand should, however, be as homogeneous as possible, with a low uniformity coefficient and not stratified in layers, except, perhaps, around the underdrains where gravel or fine stone may be placed. Stratification interferes with the proper aeration of the bed, and a coarse layer overlying a fine one results in a clogging which is difficult of removal. For this reason new or cleaned sand should never be put on a dirty bed. The bed should be first scraped down to clean material and then clean sand applied. Care should be used to exclude, if possible, all fine dirt or clay material, as such substances by holding water very seriously obstruct free drainage and aeration.

OPERATION OF SEWAGE DISPOSAL PLANTS.

As the bulk of the purification is done in the upper layers of the bed, a depth beyond two or three feet is hardly justifiable. Still, a deeper bed can be cleaned more times before it becomes necessary to replace the sand than can a shallow one.

The underdrainage of sand filters is very important, and if the natural drainage is insufficient, then artificial drains must be provided. No set rule can be given for spacing underdrains, but enough must be provided to insure a complete and rapid removal of the water as fast as it can get through the sand. The drains should be so laid that the water has free access to the pipes. The writer has already had the experience of having to have removed from underdrains obstructions of muslin and tar paper, which were wrapped about the underdrain joints when laid.

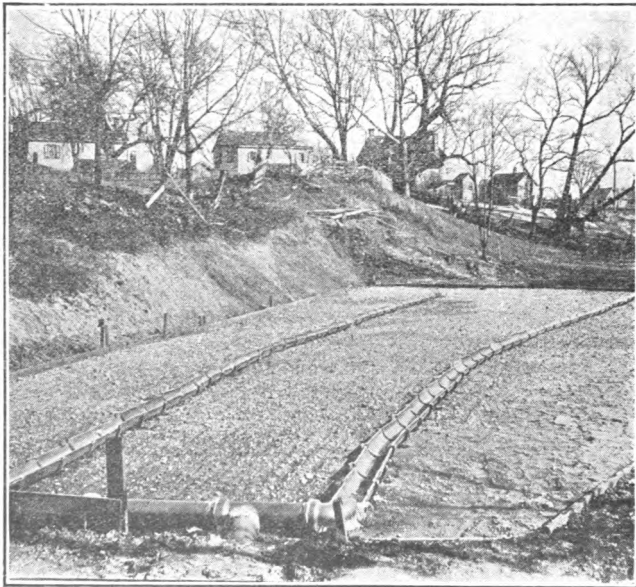

ARTIFICIAL SEWAGE BED.
Receives Septic Tank Effluent.

FILTERS.

Unless it is impossible to do otherwise, sand filters should never be located in wet or marshy ground so that the bottoms of the beds are soaked and water-logged. Under such conditions the lower portions of the beds become black and filled with muck, and a good effluent is not produced. The writer also prefers not to have the underdrains discharge under water, or so located that high water in the stream backs up into drains or beds.

It certainly should be evident that if parts of the bed do not receive any sewage those parts are not doing any work, and consequently the capacity of the bed is reduced by just so much. This, however, does not seem to be always realized, for the writer frequently finds sand beds with 30, 50 or even 80 per cent. of the sand not receiving any of the dose, while the wetted areas are very much overworked. In many cases there had been no provision made for even distribution. Even distribution over the surface of the bed is of great importance and if the flush of sewage is insufficient to cause the bed to be covered, then some form of distributing system must be provided, which may be composed of tiles, wooden troughs, furrows, or multiple inlets.

All gates or valves controlling the flow onto the beds should be of a type which will close easily and be tight. A slight leak or dribble upon a portion of the bed keeps that part wet, induces growths of troublesome organisms, and effectually puts that much of the bed out of commission. Hand gates consisting of stop planks against which the attendant has to pile dirt are only make-shifts and are to be deplored.

In many cases automatic appliances for dosing the sand beds are employed and when supervised by a competent person are quite satisfactory and effective. What was said concerning dosing apparatus for contact filters will apply to the apparatus for sand beds, as in many cases the types are identical.

Sand filters are by no means "fool proof" and unless operated in a careful and intelligent manner they may become a source of nuisance and a total failure.

The successful management of sewage sand filters de-

OPERATION OF SEWAGE DISPOSAL PLANTS.

depends upon the fact that they must be operated strictly in accordance with the natural laws which underlie the process. In every case failure is traceable directly to the violation of one or more of the fundamental principles, and the plant attendants have almost invariably believed that the beds were for the sole purpose of straining out the suspended matter. Too often the term "intermittent" in its proper sense is entirely lost sight of. Since the process is one of oxidation it necessarily follows that the doses must be applied in small quantities for short periods of time, and the beds allowed to drain and air between applications. The continuous application of sewage to sand beds for over 24 hours at a time will have serious effects upon the effluent, and will so injure the beds that a very abnormal length of time will be required for the beds to recuperate. No bed should be used longer than a day at a time and it would be much better in many cases to change the flow twice a day, especially in warm weather. When automatic dosing apparatus are used the successive charges should go upon separate beds in rotation, except perhaps in the case of small plants in which the bed will have time to drain and air before the next dose has accumulated. Even under such conditions it would, perhaps, be better to have a greater number of smaller units so that the dose would not be held so long as to get foul before being applied to the sand.

It will not be necessary to go into a discussion of the chemistry and bacteriology of sand filters, as these subjects are taken up more or less in treatises upon sewage disposal. The attendant should, however, realize that important chemical changes must be produced in the organic substances passing through the beds. These changes will not occur in sterile beds nor in those in which the proper kinds of organisms have not been allowed to develop or thrive.

The organic substances are oxidized, nitrogen appearing in the form of nitrites and nitrates, and carbon and hydrogen as carbon dioxide and water.

The organisms responsible for these changes are aerobic and belong to two groups; viz., *Nitrosomonas*, the nitrite formers, and *Nitrobacter*, the nitrate formers.

FILTERS.

They are sensitive to their environment and if deprived of air or interfered with by anaerobic conditions their activities cease. It, therefore, becomes necessary for the attendant to see that the sand bed gets an even dose of sewage of short duration, and a sufficient period of rest before the next application, for the process is not merely one of straining out the suspended matter.

The writer once visited a sand filter plant, the beds of which received the effluent from a septic tank. The sewage was about a foot deep upon the beds, and in it

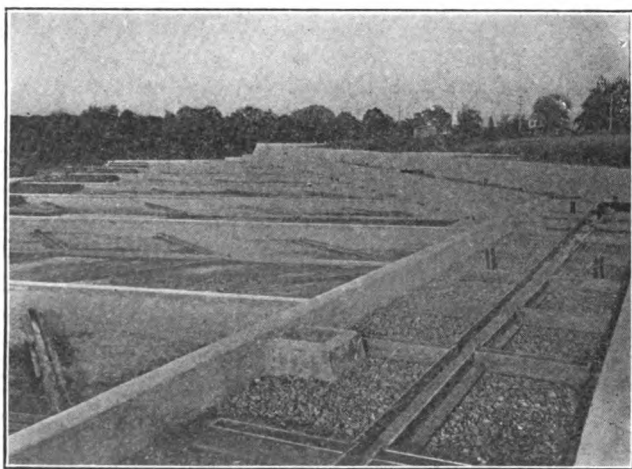

SECONDARY SAND BEDS.

was a considerable growth of algae and large numbers of mosquitoes in all stages of development. The effluent from the beds was perfectly clear and with almost no odor, yet the substances in solution had undergone no purification whatever. The liquids were highly putrescible, and when incubated over night they developed an odor which was extremely offensive.

Considerable skill is necessary in managing beds having sluggish drainage. Under such circumstances the

OPERATION OF SEWAGE DISPOSAL PLANTS.

attendant must make the best of a bad bargain. He must arrange to give each bed the shortest dose consistent with the longest period of rest, bearing in mind that it will not do to dose the bed for several days, although a longer rest is to be provided. Neither is it proper to rotate so often that all of the beds are wet practically all of the time.

The bed must dry, especially on the surface, at frequent intervals, and preferably between applications. Unless this is done very objectionable growths of fungi, blue-green algae, or green algae are bound to occur. These growths cause undue clogging of the surface of the sand, hinder the drying of the bed, and add considerably to the cost of cleaning. Preventative measures are by far more advisable than curative. Although these growths cannot exist on dry surfaces, it sometimes becomes advisable to kill them out as they begin to form. Chloride of lime is useful in destroying fungi, and copper sulphate has been used to keep down growths of algae on some of our sewage beds.

From the foregoing will be seen the necessity for tight valves and gates, and the attendant should be sure that the flow is completely cut off when a valve or gate admitting the dose is closed.

Sand beds should be kept continually free from weeds and vegetation, as such things "constitute a perpetual plague." It is not unusual to see a neglected bed covered with a crop of tomato plants grown from seeds deposited by the sewage.

No set rule for cleaning sewage beds can be laid down, but the accumulations must be scraped up and removed as soon as they become sufficient to interfere in any way with the proper working of the beds. Nothing should be allowed to retard the entrance of the water into the sand. Under normal conditions the layer of deposits cracks and curls as it dries, so that it can be removed easily without taking up much sand. When large areas of natural soil are employed it is usually only necessary to plow and harrow the ground at frequent intervals. In these cases it is often well to have a flat clean area, over which the sewage may flow before reaching the

FILTERS.

beds, and upon which the solids may be deposited to be scraped up and removed, unless the sewage has previously passed through a settling tank.

Some soils are improved by plowing in sewage humus, but in most cases precautions should always be taken to prevent as far as possible the working of sewage humus down into sand beds.

It is necessary that the sand or soil be kept in a loosened up condition to enable the sewage to pass through rapidly and a sufficient quantity of air to penetrate as deeply as possible. This is an important point and one which is often overlooked. A plow, harrow, or cultivator may be used, depending on the nature of the bed; but if the bed is to be cleaned before the next plowing, the surface should be left as smooth as possible to facilitate cleaning without removing much sand.

The winter management of sand beds in cold climates requires judgment and forethought on the part of the attendant. In New Jersey the winters are usually not severe enough to be troublesome. For one or two years some of our northern beds were operated by the Brockton method of furrowing them so as to have ridges to support the ice which formed. The beds could then be worked in the furrows under the ice. At the beginning of a cold snap the bed is flooded so that the sand does not freeze, and after the ice has formed it affords protection. For the last three or four winters the furrowing has been dispensed with, the temperature of the sewage and proper management being sufficient to keep the beds open. When the beds are not ridged in cold weather, care must be taken to prevent the sand from freezing to such a depth that the next dose of sewage will not thaw it out; and also, should a layer of ice form, this must not be let down upon the surface of a flat bed and allowed to freeze fast, or else the bed will go out of business until warm weather. One of our plant attendants let his filters freeze up this winter, which put them out of commission for some time. This would have been prevented by the application of sewage at the proper time.

The Worcester method of scraping the surface into little piles on the beds when cleaning in the autumn has

OPERATION OF SEWAGE DISPOSAL PLANTS.

merit in that the top of the bed is left flat while the piles form a support for the ice, and the cost for the subsequent cleaning is less than that of furrowed beds.

The winter operation must be somewhat different from that in summer. Higher rates often have to be employed and longer rests given to the beds. Consequently, under those conditions the effluents are not likely to be as good as in summer; yet with sufficient area and proper management very good results can be obtained in cold weather. During cold weather large doses should be applied suddenly in order to thaw out the frost, for a slow discharge is likely to freeze as soon as it spreads itself. In some cases it will be well to cut off the distribution system, and direct the flow under the ice in a sufficiently large stream to prevent freezing. In very cold weather it is well to use only a few beds, adding others whenever a sufficiently warm spell occurs, and resting some which have been hard worked. In regard to these points much will depend upon the attendant's knowledge of the local weather conditions, his foresight, and good judgment.

The writer has had several opportunities of demonstrating the advisability of plowing up and removing vegetation from areas set off for sewage disposal purposes. In one instance the beds were composed of stiff soil and clay. In order to increase the drainage, large ditches had

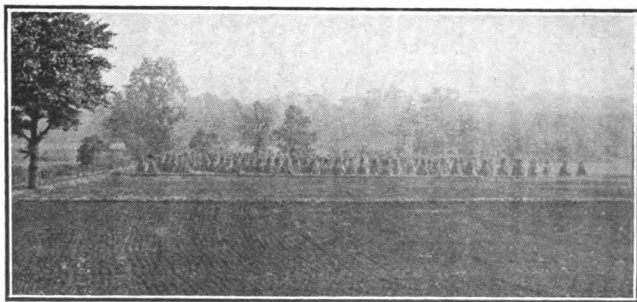

LAND FILTRATION AREA, RECEIVING RAW SEWAGE.
Kept plowed and free from vegetation—corn is sometimes raised on the idle beds.

FILTERS.

been opened up over the underdrains, and filled with cinders and porous material. The plant was then allowed to take its course, with the result that the beds became flooded, and overflowed. What went through the underdrains was clear but highly putrescible. A considerable amount of grass and weeds had grown on the beds, and mosquitoes were abundant. The effluent ditch was in a very bad condition, and showed evidences of serious pollution. This is the condition the writer found at his first visit. It was very difficult to get the attendant to plow up the beds because he said it would make matters worse. The authorities were finally induced to plow and harrow the beds frequently, to alternate the doses, and to provide for better distribution. Good results were immediately produced. The ditch cleared up, the effluent became non-putrescible, and the mosquito-breeding place disappeared.

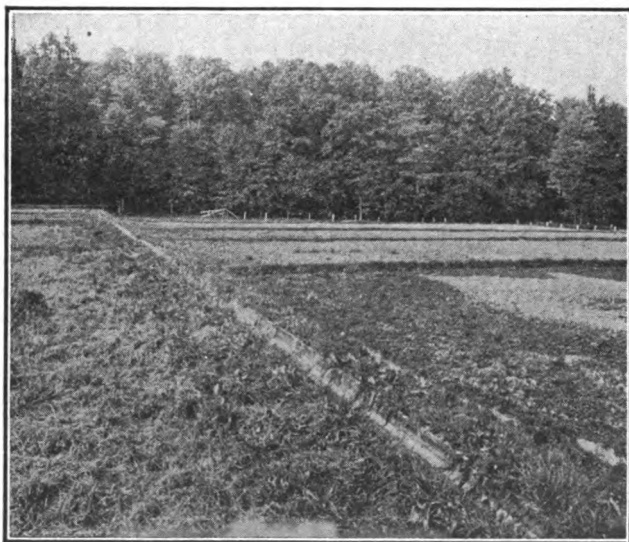

A NEGLECTED SEWAGE PLANT.

After plowing up the beds and removing the vegetation the effluent improved in a few days.

OPERATION OF SEWAGE DISPOSAL PLANTS.

At another place, after much effort, the attendant was induced to plow up his sewage beds, which consisted of soil and more or less disintegrated red shale rock. The first plowing was quite difficult and was not completely done, but improvements were so apparent that the attendant volunteered to repeat the plowing later on. Now the beds are plowed and harrowed regularly, and are producing an excellent effluent.

Another plant is now under observation, where for years sewage has flowed over the vegetation upon the upper portions, and has formed ponds upon the lower parts. The removal of grass and a thorough plowing was advised. Tests of the scheme were made last summer by the owners of the plant, and as a result the plan is to be adopted for the whole plant this year.

LAND TREATMENT.

The disposal of sewage on land, sometimes known as Broad Irrigation or Sewage Farming, is, perhaps, the oldest method of sewage treatment. It is probable that in China and Japan human excreta have been utilized on land for thousands of years, while as early as 1559 a sewage irrigation area was established in Prussia. Later on considerable attention was given to sewage farming in England, and afterwards irrigation areas were established in many places on the Continent. In 1876 the first area for the city of Berlin was put in operation, to which other areas have been added, until the farms now are the largest in the world and cover nearly 50,000 acres of ground.

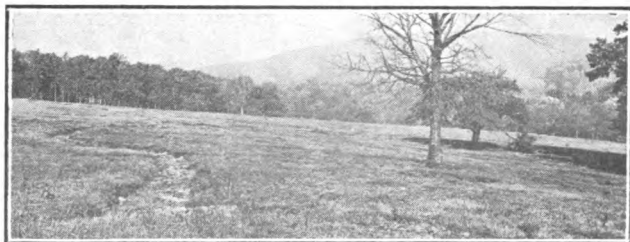

BROAD IRRIGATION.

FILTERS.

The objections in regard to area required for the process of intermittent sand filtration apply with more force in the case of broad irrigation, for the reason that a much larger area is required for the treatment of a given quantity of sewage by the latter method than by the former. Usually only about 10,000 gallons per acre per day can be successfully treated upon a broad irrigation area, while ten times that amount can be taken care of upon a good sand bed. Unless carefully managed, the process is likely to be objectionable if near built-up communities on account of odors, flies and unsightliness. However, 4,000 people actually reside on and take care of the sewage farms of Berlin, and considerable quantities of forage, cereals, and vegetables are raised. Even fish are raised in some of the ponds and drains, and are made to yield a revenue. In some other localities good crops have been raised, notably in California, but take it all in all, sewage farming is not a paying operation, and it is rapidly going out of favor, except, perhaps, in very dry regions.

There are only two sewage plants in the state of New Jersey which may be called broad irrigation plants, and upon these only a limited amount of hay is cut. The sewage is run out into furrows or ditches and very little systematic attention is given to the areas.

A low or marshy area should never be selected to receive sewage, because under such conditions there is danger of a nuisance without a purification of the sewage. Light, sandy or loamy soils with free drainage are the most suitable, while stiff clay is almost worthless.

The areas should be laid out with some system, so as to dispose of the water to the best advantage. If crops are raised, good judgment must be used in the selection of the kinds which will be the most suitable under each particular local condition. The attendant must know just how much water each crop can stand, and to preserve the proper balance between the raising of crops and the disposal of the water often requires considerable skill and experience. Usually in wet weather, when the crops need the least added water, the sewage flow is the greatest; hence its disposal at such seasons is more difficult.

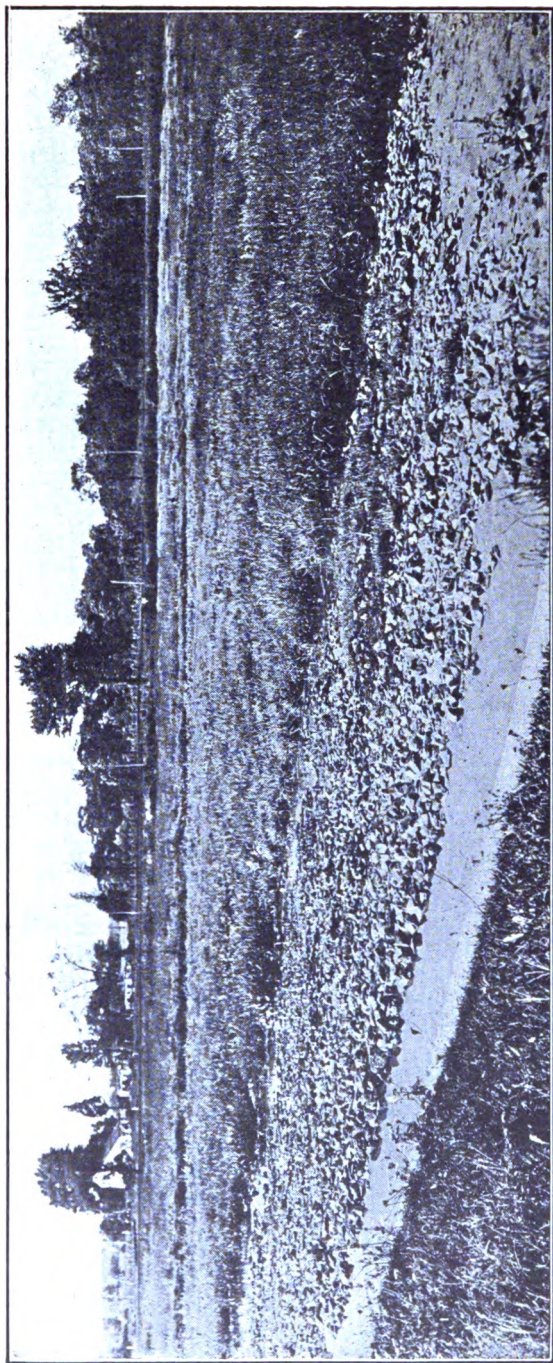

LAND FILTRATION AREA.

Much overgrown with vegetation, which is now being removed.

FILTERS.

Grease and the larger suspended matters should be excluded, as these often seriously interfere with the growth of certain crops. The furrows or ditches should be laid so that the sewage is distributed evenly over the area, and in such directions that the ground is not washed in gullies in time of showers. The flow should be frequently changed from one area to another to prevent any part of the field from getting "sewage sick."

Corn and forage crops are raised and sometimes fruits and vegetables, but there is quite a sentiment against the growing of crops for human consumption upon sewage farms. Certainly berries, salad greens, celery, and low growing fruits and vegetables, which are eaten raw, should not be raised.

Although somewhat apart from the subject, it may be well to mention that extended sewage areas often have a direct effect upon neighboring wells. Such wells should be frequently examined, and in the location of new works the wells in the vicinity should be considered. English researches "have shown that specific bacteria may pass for a distance of two miles in less than three days through chalky soil of a porous nature."

SUB-SURFACE IRRIGATION.

For small estates and institutions a system of ramifying lines of open-jointed tile pipes, laid from one to two feet under the surface of a porous soil, provide a very suitable method of disposal of the liquid wastes. As much grease and suspended solids as possible should be retained in cesspools or tanks. The overflowing liquids should be discharged into the pipes and allowed to soak away. The discharge should be intermittent, preferably by means of a dosing tank and siphon. The total area should be laid out in units so that the doses can be diverted from one to another in rotation at intervals of a few days. When an automatic dosing apparatus has not been installed, the attendant must change the flow by hand at frequent intervals.

Such a system should never be placed in a low or marshy piece of ground. The writer once visited such a plant, taking sewage from an institution. The sewage and ground water had completely saturated the land and

OPERATION OF SEWAGE DISPOSAL PLANTS.

had risen above the ground in a pond of stagnant filthy mass of sewage. The plant had to be abandoned. A dry, free draining location, with porous soil, should be selected and great care should be used in laying the laterals, or else there will not be even distribution. Some ingenious terra cotta connections have been made for joining laterals to main distributors so as to enable equal portions of the dose to flow into each lateral. There should not be any trees nearby, as the tiles will become completely stopped up with roots. As bacterial action is best near the surface of the soil, it follows that the pipes should not be deeper than necessary to place them beyond disturbance and severe frost.

There is one comparatively large installation of this type in the state of New Jersey which takes care of the entire sewage from a county institution. In addition, there are quite a number of smaller sub-soil irrigation plants for private estates and residences, and those located in suitable ground are giving satisfaction, with comparatively little attention.

IV

DISINFECTION.

Purpose and Principles—Condition of Liquid Necessary for Success—Applying Hypochlorite—Liquid Chlorine. . .

The methods and processes previously described have had to do mainly with the primary object of sewage purification—its conversion into a stable form, so that it will not putrefy and create a nuisance, brought about by the oxidation of the organic matter. True it is that the older and slower processes, such as slow sand filtration, combined with the oxidation of the organic matter a very substantial bacterial reduction. But the more rapid methods, such as the contact or sprinkling filter processes, have comparatively little effect in reducing the numbers of bacteria, although the organic oxidation may be quite complete.

On the other hand, the process of sewage disinfection has for its sole purpose the destruction or elimination of bacteria, particularly the objectionable bacteria and the germs of diseases likely to be found in sewages or disposal plant effluents.

The pathogenic organisms are, after all, the direct sources of danger in the use of sewage-polluted waters, although an excessive amount of unoxidized sewage is fatal to fish life on account of its elimination of the necessary dissolved oxygen. Furthermore, shellfish are often so seriously contaminated by pathogenic organisms in sewage-polluted waters that disease results when these contaminated shellfish are eaten in the raw state. While long storage or other treatment of a moderately polluted water practically renders it safe for potable purposes, there has not yet been found a very practical and reliable method of disinfecting shellfish. And although the transfer of shellfish from polluted to pure water has a marked benefit upon their sanitary quality, yet the destruction of all pathogenic organisms at the mouth of

OPERATION OF SEWAGE DISPOSAL PLANTS.

the sewer would certainly aid in safeguarding the sanitary quality of the shellfish within the adjacent waters.

A great variety of processes for the disinfection of sewage and sewage effluents have been proposed from time to time. Obviously the ones most desirable are those which are efficient at a reasonable cost. Among the agents proposed may be mentioned, heat, lime, acids, ozone, permanganates, salts of the heavy metals, and chlorine and its compounds. The actions, comparative results and costs of these agents have been discussed more or less at length by Rideal, Dunbar, Phelps, Kinnicut, Winslow, Pratt, and others.

In New Jersey only three of the above agents have been used, namely, compounds of chlorine, sulphate of copper, and ozone. One ozone plant was established but later condemned and discarded. At another plant copper sulphate was used as a disinfectant for a contact bed effluent. It was found impractical and too costly to apply a sufficient quantity of copper sulphate to do effective work, and now plans are being made to substitute liquid chlorine. It is, of course, well known that copper sulphate is very efficient in the treatment of water supplies for the removal of algae, and it is also extensively used at one of our sewage plants to keep down excessive growths of the blue-greens.

The methods of sewage disinfection have for one or more reasons been limited to the application of chlorine or some of its compounds, notably calcium hypochlorite, or bleaching powder. The action of this substance upon bacteria has been known for a long time, although the first large scale experiments were conducted by the writer at Red Bank, New Jersey, in 1907, under the direction of Prof. E. B. Phelps. In that run the sewage from the whole town was treated for ten weeks, full accounts of which have already been published. In 1907-1908 the writer also carried on with Professor Phelps, in Boston, extensive disinfection experiments on crude sewage and sprinkling filter effluents with both chloride of lime and other compounds of chlorine.

It was during a series of these comparative experiments in the autumn of 1907 that the writer needed a

DISINFECTION.

quick and sensitive indicator for available chlorine, in order to determine the rate of decrease in available chlorine after the addition of bleach to sewage. He and Professor Phelps, in trying the contents of various bottles and test tubes from a dusty closet, found a substance in a tube, which gave a strong color with bleach. Upon deciphering the label it proved to be Ortho-Tolidin. The writer believes that this was the first time Ortho-Tolidin was used as an indicator for bleach, and although Professor Phelps told several investigators about the test, an account of the "discovery" was never published. The substance dissolved in hydrochloric acid makes a very

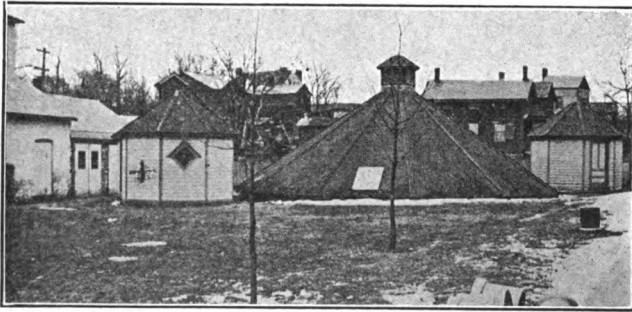

SEWAGE TREATMENT PLANT AT RED BANK.

In the house marked + the first large scale disinfection experiments on sewage were carried on in 1907.

convenient quantitative as well as qualitative test for chlorine.

In 1909 the first chloride-of-lime sewage disinfection plant was built at Stone Harbor, New Jersey, accounts of which have been published in the annual report of the State Board of Health. Since that time disinfection has been established at two dozen or more sewage disposal plants in that state, treating raw sewage, tank effluents, contact bed effluents or final sand effluents, as the cases may require.

Unfortunately, in many cases, the nature and limitations of the process of disinfection are not well understood, and too much is expected from the treatment.

OPERATION OF SEWAGE DISPOSAL PLANTS.

Disinfecting chemicals are added for the purpose of destroying bacteria or germs, nothing else. In some cases odors are lessened, but the elimination of odors by means of chemicals is an expensive and impractical process, and it is far better to prevent the formation of the odors than to correct them with chemicals after they appear. One often finds persons and even town officials who suppose that the "chemicals" are for the purpose of "eating up" or consuming all the sewage matters, and when this is not done the plant is declared a rank failure. We recently found a plant attendant who had developed the practice of lifting a lid of one of the sewer manholes

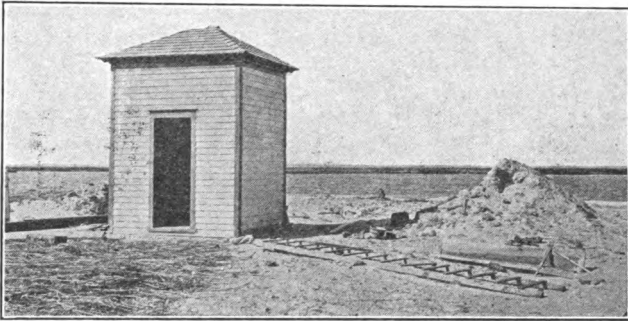

FIRST CHLORIDE OF LIME SEWAGE DISINFECTION PLANT IN NEW JERSEY, BUILT IN 1909.

and dumping in a pail of chloride of lime once a day. Such a practice is not proper disinfection because for a short time more chemical than is needed is used up while for the rest of the day there is none at all. As a chain is no stronger than its weakest link, so a disinfecting plant must be kept running properly at all times. Every result should be good, regardless of averages over stated intervals of time.

CONDITION OF LIQUID TO BE DISINFECTED.

For good results two conditions of the utmost importance must be fulfilled. First, the material to be disinfected must be in proper condition to receive the treat-

DISINFECTION.

ment, and second, the dose must be constantly applied. In regard to the first condition, little difficulty will be encountered with good tank or bed effluents, but with crude or raw sewage the suspended matters must be removed or else thoroughly broken up or disintegrated into very fine particles, as there is no penetration of the disinfectant into masses of organic matter. Failure to recognize this has been the cause of failure in more than one of our disinfection plants. Coarse screens or improperly designed tanks have allowed fresh feces and masses of other organic matter to pass out of the range of the chemicals before there was any action upon the bacteria within.

It has been very unfortunate in several cases that in Professor Phelps' account of the Boston experiments the term "crude sewage" has been taken to mean sewage just as delivered from any sewer whatsoever. The Boston "crude sewage" and the crude sewage from the outfall sewer of a small town are two entirely different things from a disinfection point of view. While we obtained good results on the Boston sewage with eight parts per million available chlorine, a like disinfection of the sewage at some of our small towns cannot be obtained with one hundred parts, simply because of the condition of the suspended matter.

In the Boston experiments we pumped the sewage from the large Massachusetts avenue outfall sewer through a suction hose with a strainer on the end, which nearly always was more or less completely clogged with rags and paper. The sewage as delivered into the tanks was only slightly turbid on account of the removal and disintegration of the suspended matter. After the addition of the bleach the sewage was repumped for two hours through a circulating pump. Samples were taken and tested at the end of one hour and two hours respectively. Note how different such conditions are from those obtained in the gravity outfall sewer of a small town.

And right here let it be emphasized that the results obtained at experiment stations must be carefully considered with regard to all of the conditions under which

OPERATION OF SEWAGE DISPOSAL PLANTS.

such results were obtained. It is very common to set up an experiment station for the purpose of determining the action of screens, tanks, beds, filters and what not upon the local sewage, and then deliver to the station for the experiments a little sewage pumped from the outfall main. The results obtained in this way are likely to differ in many respects from those obtained in a full-sized plant taking the whole gravity flow. An experiment station, to be of the most value to any particular case, should be of fair size and work under precisely similar conditions to those under which the big plant will have to operate. From the results of such a plant reasonably safe conclusions can be drawn. Further discussion of experiment stations will be given in a subsequent chapter.

In the management of a sewage disinfection plant, therefore, the attendant must see that the liquids are properly screened, settled, filtered, or otherwise clarified so that the chemicals are able to reach the bacteria in accordance with the foregoing principles. In one of our plants the sewage is passed successively through screens of graded sizes, from coarse bar screens to woven-wire cloth of forty meshes to the inch. These screens are kept clean by an attendant who is in constant daily attendance, and the screenings are removed in tight receptacles and carted away. The accompanying illustrations show the appearance of the plant. The screens are reached through trap-doors. The chloride-of-lime is mixed and regulated in the rear room. The dosing is controlled by means of a variable head orifice which is raised or lowered in a constant level box, so that the dose of chemical is delivered into the last screen compartment proportional to the flow of sewage passing.

There is no odor or nuisance about this plant and everything is especially neat and tidy.

SIZE OF DOSE.

It is the care and management of the application of the hypochlorite that demands skilled supervision and attention. Several factors must be taken into account. First, the size of the dose. This is determined by the character of the sewage or effluent to be disinfected, and the degree of bacterial elimination desired. Stale septic sew-

DISINFECTION.

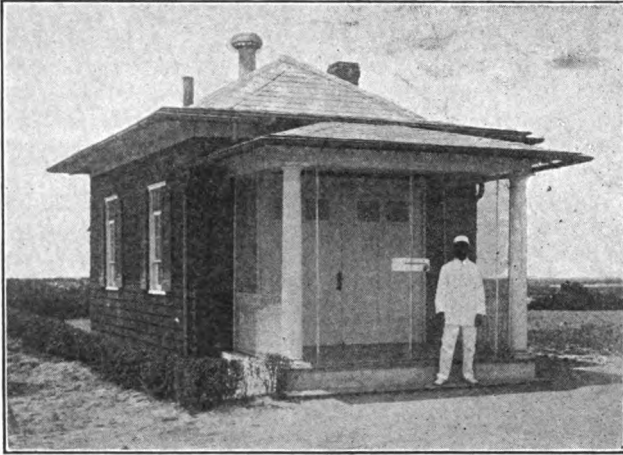

SCREENING AND DISINFECTING PLANT.
Attendant in Uniform.

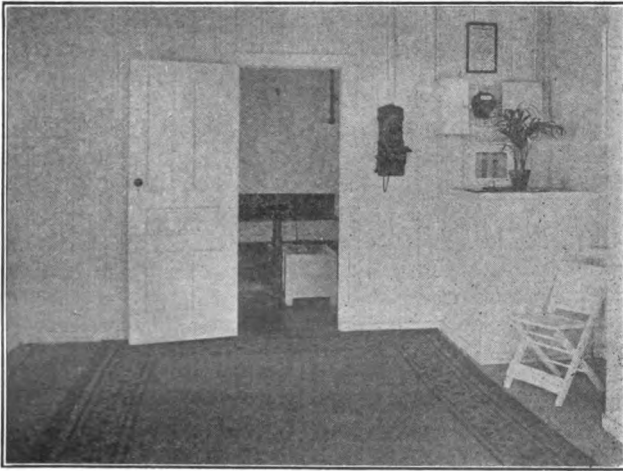

INTERIOR OF SCREENING AND DISINFECTION PLANT.
Trap doors at the left of rug. Bleach is stored in the cabinet under the potted plant. Mixing and dosing are done in the rear room, where the dosing device can be seen.

OPERATION OF SEWAGE DISPOSAL PLANTS.

age requires a much greater dosage than good effluents to obtain the same bacterial reduction.

In order to determine whether or not the dose is accomplishing its purpose, frequent careful bacterial tests must be made. These are the usual plating and presumptive fermentation tests, concerning which more will be said later, as they are laboratory tests and require certain laboratory facilities. The plating tests give the numbers of bacteria per cubic centimeter in the liquid before and after treatment, and the fermentation tests indicate the number of *B. coli*-like organisms before and after treatment. Thus the reduction in organisms by the treatment can readily be determined. It must be borne in mind, however, that the results are more or less relative and not absolute, because many other organisms are present in the sewage which are not shown by the above methods. Biological studies have shown that the pathogenic organisms are so susceptible to the action of the disinfectants that long before complete sterilization has been reached the disease-producing germs have been killed. This is most fortunate because in most cases a bacterial percentage reduction well up in the nineties may be obtained at a reasonable expense, while the complete elimination of the remaining few is practically impossible on account of the excessive cost of the required treatment.

It might be well to add a word of caution in regard to the use of the term "percentage reduction." A ninety-nine per cent. reduction in a sewage carrying ten million bacteria per cubic centimeter will still leave one hundred thousand per cubic centimeter or five thousand bacteria in each and every drop—quite a number. Again, if in the treated liquid there are suspended particles of human excreta, into which the disinfectant has not penetrated, it is fair to assume that there is a chance of dangerous organisms escaping unharmed. Proper conclusions cannot be drawn from bacterial figures unless they are reliable and the true conditions are represented.

It is customary to speak of the dose as so many parts per million of available chlorine. This means that enough pounds of the hypochlorite are added to a million pounds

DISINFECTION.

of sewage to give the stated number of pounds of chlorine. For instance, in the analysis of the hypochlorite, which consists of calcium, oxygen and chlorine, the chlorine is liberated and its amount determined; and as the total quantity of the hypochlorite is proportional to the chlorine it contains this is a convenient way of designating the strength of the material. Thus, if the chloride-of-lime contains about one-third chlorine then twenty-five pounds in a million gallons of sewage will give a dose of about one part per million of available chlorine.

APPLYING HYPOCHLORITE.

Having determined upon the size of the dose, the next thing is to apply it to the sewage or effluent at a uniform rate. The best practice is to dissolve the required number of pounds in a given amount of water and feed the solution at a definite rate proportional to the flow of liquid to be disinfected. This is not so simple as one might at first suspect. Several things have to be looked out for. The commercial dry powder varies in strength and loses strength considerably when exposed to the air. There must be sufficient water to dissolve out the hypochlorite, and care must be used in mixing the solution. The solution is corrosive and acts on tanks, piping, valves, etc., and it also forms incrustations which cause frequent stoppages in pipes, valves and feeding devices.

Unless it is feasible to analyze each lot of bleach, it should be bought with the available chlorine specified by the dealer. As the material deteriorates upon opening, the contents of a whole container should be mixed at once if possible. In many plants, however, this cannot be done; in such cases the unused material must be kept tightly covered in a cool dry place. While the larger sized containers hold about 700 pounds, at a slight increase in price hypochlorite can be obtained in 350-pound or 100-pound drums, and in many cases the smaller sizes are to be preferred, both because of convenience in handling and to avoid the keeping of large quantities exposed to the atmosphere.

OPERATION OF SEWAGE DISPOSAL PLANTS

In the mixing of the bleach, the active hypochlorite is dissolved while the inert lime and other insoluble impurities remain. Usually the bleach is thoroughly mixed with a small amount of water into a paste or cream so as to break up the lumps, then more water is added and the whole transferred to the solution tank, and agitated until a thoroughly homogeneous solution is obtained. As it is very important that the solution be of the same strength throughout, and as this mixing is a laborious process, a power mixer should always be installed except, perhaps, for very small quantities. After all the hypochlorite has been dissolved and the solution once properly stirred up, the strength remains the same throughout the tank.

In some plants the contents of a whole container of bleach are washed out into the solution tank by means of a stream of water from a hose, and the whole agitated until a thorough solution is obtained. In the mixing, care must be used to get the material thoroughly broken up and agitated so that all the hypochlorite will be dissolved or else a considerable amount of material will be wasted. The writer has known of over fifty per cent waste, due to improper methods of mixing. He has suggested a mixer in the form of a mill or grinder, so that the bleach could be fed through and ground with a stream of water. This he believes would break up lumps and hasten the process.

One should not attempt to dissolve too much hypochlorite in a given amount of water. The solubility of bleach is only about five per cent, and a five per cent solution is difficult to obtain and difficult to handle. It is much better, when possible, to use a weaker solution, say two or three per cent.

It is usually better to keep the solution the same strength by mixing the required number of pounds according to the strength of the dry powder, and to vary the dose by changing the feeding device. A rod should be laid off, showing the number of pounds to be used for different depths of water in the tank, from the top down, so that if all of the solution is not run out the rod will show immediately the number of pounds to be used for the amount of water necessary to fill up the tank.

DISINFECTION.

Whatever may be the claim of the manufacturers of the bleach, the attendant should know the value of the solution he is using. This he can easily determine in a few minutes by simple chemical tests with inexpensive apparatus. The standard solutions for the test can be obtained from chemical supply houses or made up by a chemist, and the methods of using them are described in standard books on volumetric chemical analysis.

The State Board of Health is always ready to instruct attendants how to make the determinations referred to.

The writer has met with many unscientific methods of managing solutions of chloride of lime and faulty ways of applying the disinfectant to the sewage flow. The principles and limitations of sewage disinfection are so little understood and the plants are so frequently out of order that the writer has almost come to regard a hypochlorite plant for the treatment of sewage as a necessary evil. At one installation a quantity of chloride of lime was mixed and the clear supernatant liquor fed out the first day. On succeeding days water alone was added to the settled sludge which was only inert lime and impurities. The solution was allowed to settle and the clear liquor again fed to the sewage. This was repeated for about four weeks without the slightest suspicion but that everything was done properly although all of the hypochlorite ran out the first day, leaving nothing but a little lime water for the rest of the month. At another plant a solution was made up and about one-third of the tankful used the first day. Instead of using the remainder in two portions the next two days, the tank was filled with water, thus diluting the solution. This trick was repeated for a few weeks until the writer explained to the man in charge the fallacy of such a procedure. These two instances are cited not so much for criticism as to show how easy it is to go wrong in these matters if the principles are not well understood. The first plant was run by the chief engineer of one of our large state institutions, and the second was under the direct supervision of a prominent city official. At another plant the disinfecting solution was found running into a "dead"

OPERATION OF SEWAGE DISPOSAL PLANTS.

compartment of the storage tank so that practically none whatever was getting into the flowing sewage.

Mention has already been made of the practice developed by one plant attendant, of applying the chemical by dumping a shovelful of it once a day into a manhole in the outfall sewer. A similar scheme for the disinfection of the sewage of an entire town has been proposed; namely, to haul around the bleach solution in a cart or tank wagon, and apply a little periodically to one or more of the manholes in the sewer system. The reasons why these schemes are bad have been explained above.

Although sewage disinfecting plants have been in operation in New Jersey for several years, it has been only in very recent time that an inspector from the State Board of Health could make a chance visit and find a plant working as it should. Invariably something would be found wrong and the excuse would be that it "just happened." A valve would be corroded, the flow cut off by stoppages, supply of bleach exhausted, ejector or pump out of order, or one or more of a dozen other things which put the plant out of commission. In addition to skilled supervision, disinfection plants need almost constant attention day and night. Recently, however, the owners of some of our disinfection plants have taken hold of the process in earnest, and keep an attendant almost constantly on the premises. Such plants are giving good results.

Tanks for hypochlorite solutions should be made of concrete or iron. Wooden tanks, if lined with cement mortar, are fairly satisfactory. There are on the market paints and coating materials for wooden tanks, which are said to withstand the action of bleach, but the writer has not used them personally.

Whenever the slightest leak develops in a wooden tank it should be stopped immediately, as the flow of bleach through the leak cuts away the wood very rapidly. Some of our tanks are made out of sections of terra cotta sewer pipe, with a cement bottom. As stated above, solution tanks should be of ample size, and if possible equipped

DISINFECTION.

with power agitators, as the proper mixing by hand of a large batch of hypochlorite is a laborious process, and the entire contents of the tanks should be thoroughly agitated to insure a homogeneous solution. To facilitate dosing through small orifices, the lime sludge is allowed to settle out and only the clear supernatant liquid used. The clear liquor is either drawn off into another tank, from which it is fed out while another batch is being prepared, or the two tanks are placed side by side and used alternately. The unused lime sludge is drawn off as often as necessary and run into the sewage tank to be disposed of along with the sewage sludge.

To control the flow of the clear liquor several forms of apparatus have been used. Some are good and some are bad. Valves and spigots attached to tanks so that the head of solution on the valve decreases as the tank empties, are unreliable. A constant head feed box should always be provided. The level in this box can easily be maintained by means of a bronze float valve, after the pattern of those used in water-closet flush tanks. When such a valve was not available the writer has used a rubber tube, one end of which was slipped over the down-turned end of the inlet pipe, and at the other end a float attached. The float upon rising kinked the tube and cut off the inflow. When the liquid ran out and the float dropped, the tube allowed an inflow which was discharged into the box through a hole cut in the side of the tube. Another good arrangement is to feed the solution into the orifice box from an air-tight tank, arranged so that an air pipe leading from the top of the tank just touches the liquid in the orifice box. When the liquid lowers and frees the end of this pipe, air is admitted and enough solution is emptied into the box to cut off the air and stop the flow. This principle is illustrated by the well-known drinking fountains for chickens, and in emergencies can be quickly rigged up with tight barrels. The discharging device may be a conical plug valve with a scale and pointer for regulating or, better yet, an orifice. Valves are objectionable because the flow through them cannot be seen; hence slight stoppages are not readily detected. They have

OPERATION OF SEWAGE DISPOSAL PLANTS.

to be cleaned frequently, and at such times the flow has to be stopped and the valve taken apart. Globe valves are especially bad and are difficult to regulate on small flows.

The better types of orifice boxes are made of iron, and lined with porcelain enamel. They are equipped with float valves made of special bronze, and so operated by a glass or hard rubber float that the solution is maintained at a constant depth. In some the orifice is situated in the bottom and is capable of being readily adjusted and set by means of a calibrated dial or drum. In another style the orifice is near the free end of a pivoted hard rubber tube which is raised and lowered automatically, by means of a float or pressure tubes from

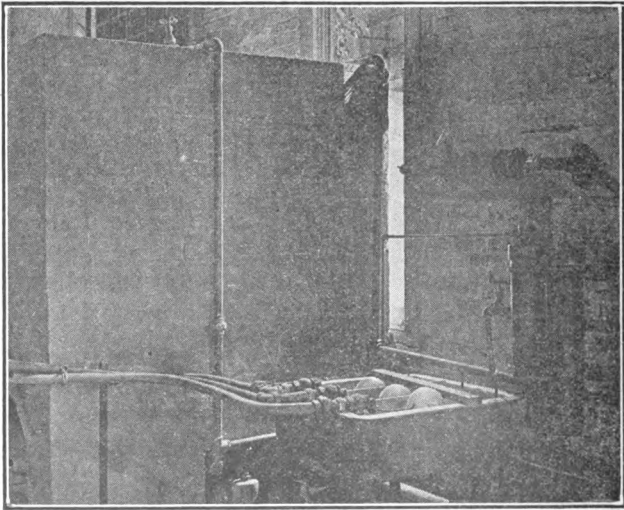

ONE TYPE OF HYPOCHLORITE FEED BOX.

Orifice is raised or lowered automatically by wires regulated by pressure tubes from Venturi meter.

DISINFECTION.

a Venturi Meter, to vary the depth of solution above the opening so as to compensate for variations in flow of the sewage. The size of the orifice may be adjusted by moving a lock-nut which travels on a thread over the slit in the pipe, which forms the orifice. In this type the slit should be of such a width that the opening is somewhat square and not long and narrow. This lessens the danger of stoppages from scales of carbonate, etc. Scales and incrustations by calcium carbonate form rapidly when bleach solution is exposed to the air, especially if the solution be strong; thus all surfaces wet with the liquid and exposed to the air quickly become incrustated. Pipes flowing partly full sooner or later become filled up with the coating. An automatic dipping cup at one of our water plants accumulated an incrustation over an inch thick in a short time. A little muriatic acid dropped on the orifice now and then quickly dissolves off the coatings which form and diminish the size of the openings, and a little kerosene or paraffine

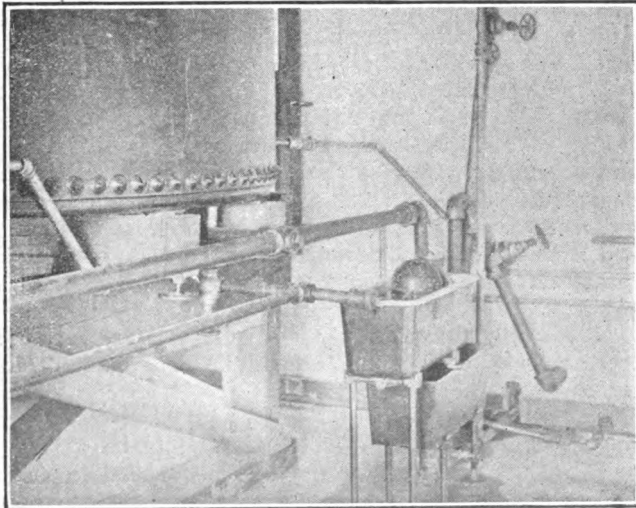

ONE OF THE TYPES OF ORIFICE BOXES IN USE FOR FEEDING CHLORIDE OF LIME SOLUTION.

OPERATION OF SEWAGE DISPOSAL PLANTS.

oil on the solution in the orifice box helps to prevent the formation of the troublesome scales of calcium carbonate. These scales get into the orifice and cut off the flow, especially if the orifice is small. This is not so frequent when dilute solutions and large orifices are used, but small orifices with strong solutions are exceedingly difficult to keep in order. Dilute muriatic acid may be used to flush out feed pipes now and then to reduce the incrustations.

One thing the makers of orifice boxes have not yet done—they have not provided for easy cleaning out. There should be a slope or sump in the bottom and an opening so that all sediment could be emptied and washed out in an instant. As these tanks have to be washed out every few days, under the present arrangement much time is unnecessarily consumed during which the flow of the solution must be stopped.

As is generally known, the flow through the orifice depends upon its size and the depth of liquid over it. Therefore, the attendant must know how to regulate the flow to deliver the required amount of solution in a given time. This is best done by referring to a table or chart calculated beforehand for the particular apparatus. A check upon the discharge apparatus should always be kept by calculating the capacity of the tank and noting the rate of drop of the liquid in the tank by means of a pointer on a scale. For this purpose the writer has used a scale laid off in hours and minutes, and whenever the tank was started the scale was set by the clock. Thus variations in flow could be detected at a glance.

As the hypochlorite fumes and solutions are very corrosive, all exposed metals should be kept painted, and moving parts should be watched and renewed as often as necessary.

The piping conducting solutions should be of ample size, and should always be run in easily accessible places. Unless made of hard rubber or other non-corrosive material they are liable to give out with little warning. Stoppages are also liable to occur and for that reason the pipes should be frequently washed out. Lead is more

DISINFECTION.

durable than either iron or brass, but as all pipes carrying small flows are subject to incrustation, and consequent stoppage, it may be as well to use a cheaper material and renew it when necessary. The conducting of the solutions through long lines of piping should be avoided whenever possible, and if renewals cannot be made in a very short time the pipe lines should be run in duplicate so as to keep one line always in reserve. Duplicates of all parts liable to have to be replaced, such as valves, pipes, nipples, fittings, etc., should be kept on hand nearby.

While it would not be objectionable to use lead piping in sewage plants, the writer has always hesitated to advise the use of lead pipes at water plants to conduct hypochlorite solutions into potable water. There may be no danger of lead poisoning from this source, but it is always well to be cautious where lead is concerned.

Whenever possible, the hypochlorite solutions should be diluted with a flow of water or clarified sewage immediately upon leaving the orifice box. This will lessen the corrosion of pipes, enable the pipes to flow full, thereby lessening incrustations, and aid in distribution.

No pumps, compressors, engines, motors, switchboards, or any machinery having exposed metal parts or belts should be located in the same room or near where hypochlorite is mixed, handled or stored in open containers.

LIQUID CHLORINE.

At one of our sewage disinfection plants liquid chlorine apparatus has just been installed as a substitute for bleach, for the disinfection of a tank effluent, and if the change proves advantageous another plant in the same town will be changed. At another installation the apparatus is ready to go in but on account of some delay it has not been set. A fourth installation for sewage has already been decided upon. In addition to these, two plants have been installed upon one of our large watersheds, each of which treats the entire flow of a small stream into which more or less pollution enters. From all accounts these have been quite successful.

OPERATION OF SEWAGE DISPOSAL PLANTS.

Measured in terms of available chlorine, the relative efficiency of liquid chlorine and bleach seems to be about equal when comparatively large doses are used, as for sewage work; but with very small doses the liquid chlorine seems to be more efficient. More experimental data on these points are needed.

The principal advantages of liquid chlorine over bleach are less cost of operation and less space required for both apparatus and storage of material. There is no loss of strength, no mixing tanks are required, no lime sludge to bother with, and no empty drums to get rid of. Some of the types of control apparatus are comparatively expensive and all these things, together with the cost of chlorine at about 10 cents per pound as compared to bleach at twenty-five dollars per ton, should be considered in making a choice for a sewage plant. For water disinfection the writer prefers liquid chlorine in most cases.

Liquid chlorine comes in steel tubes, or cylinders, holding about one hundred pounds, and under a pressure of something less than one hundred pounds per square inch. As soon as the pressure is released the chlorine immediately volatilizes, and issues in the form of a greenish, pungent, and highly corrosive gas. The gas is not explosive but is very suffocating and attacks most everything, especially if there is present the slightest trace of moisture. Great care should be taken to prevent even the slightest leak in the storage or handling of the material. Not long ago one of the cylinders of chlorine developed a leak in the storage room of a water plant, which caused considerable trouble for a while. Although every precaution should be taken to avoid the possibility of a leak, it is well not to have other apparatus or machinery in the same room, on account of some unavoidable accident.

The main problem in the application of chlorine has been in developing an apparatus which will accurately control the dose and at the same time withstand the corrosive effects of the gas. Several types of successful apparatus are now on the market, some of which dissolve

DISINFECTION.

the gas in water and feed the solution, while others feed the gas directly to the solution to be disinfected, distributing by means of porous earthenware, carborundum or other non-corrosive material. It might be mentioned that solutions of chlorine should be kept in the dark, as strong sunlight causes a reaction. The same applies to hypochlorite, and strong sunlight should never be allowed to shine on solutions of bleach.

The duties of the plant attendant in regard to chlorine apparatus are not very exacting. He must know how to set and regulate the apparatus; see that all parts are kept in good working order, and be on the lookout for leaks. Valves should be tested now and then, and not allowed to become corroded and stuck, and exposed metal parts kept painted. The presence of a leak can be located by holding a little strong ammonia near, as the ammonia and chlorine form dense white clouds. Except for the substituting of full cylinders for empty ones, the attendant has little to do. With those types of apparatus which regulate by means of the pressure of the gas, a check on the regulation should be kept by keeping the cylinder on scales, and making a record of the periodic loss in weight.

It might be of interest to mention an incident which

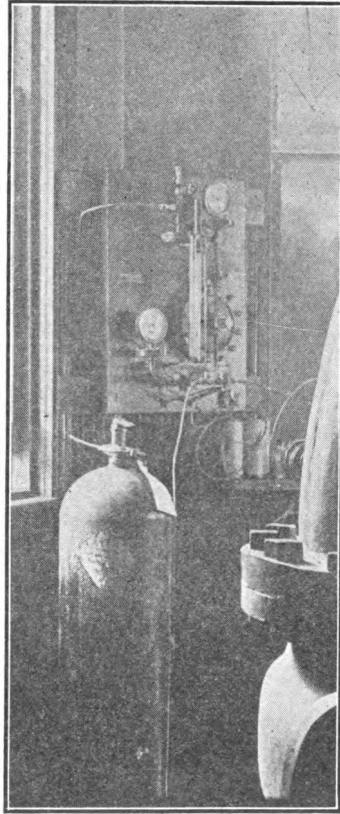

LIQUID CHLORINE DISINFECTION APPARATUS.

OPERATION OF SEWAGE DISPOSAL PLANTS.

is somewhat akin to the subject of disinfection. The writer noticed at one of the sewage disposal plants, the effluent of which goes into a potable water supply, that at the outlet of the underdrains sewage red worms had begun to appear. Quick lime and even chloride-of-lime was tried, but, according to the attendant, with little success. He then procured a barrel of crude carbolic acid, and sprinkled a dilute solution of this over the filtering areas, with a watering pot. The worms were turned black and effectively destroyed by the process.

At other plants organic growths in underdrains are cleaned out and prevented by the application of a handful of copper sulphate now and then. At still others troublesome growths of the blue-green algae are kept down by means of copper sulphate.

V

CHEMICAL PRECIPITATION AND ELECTROLYTIC TREATMENT.

Precipitation Produces Considerable Sludge with No Commercial Value—Useful for Certain Trade Wastes.

The principle of chemical precipitation is the bringing together in solution of two or more soluble substances which combine with each other to form an insoluble compound that settles out. During this process suspended matters are caught and carried down with the precipitate. The process is, therefore, preliminary only and has its limitations. It does not remove many of the substances that are in solution, and in consequence of which the effluent is left in a state capable of putrefaction which may result in objectionable deposits and local nuisance. Such a treatment, then, comes within the same category as fine screens, septic, sedimentation, or Imhoff tanks. In some cases, however, when larger quantities of chemicals are used, sufficient disinfection may occur to delay putrefaction until some large body of water is reached so that the risk of local nuisance is lessened. This is usually more apparent in the treatment of certain trade wastes.

Proposals to use such a process on sewage date back over a hundred years. As early as 1762 a patent was taken out "for the purification of dirty water by a chemical process." It was not, however, until the necessity for the treatment of town sewages and trade wastes in England arose that chemical precipitations became of much practical value. Even then an impetus was given by the attempts toward utilizing the manurial value of domestic sewage. Hundreds of chemical precipitation processes were patented and the number of chemical agents proposed was enormous. The hopes of financial gain, however, were not realized. "Of 234 towns which had adopted the chemical process, 204 had incurred expenditures without realizing any income whatever; the remaining 30 had indeed obtained an income, but this was often only a few shillings which had been received

OPERATION OF SEWAGE DISPOSAL PLANTS.

for a few cart loads of sludge. In no case had a profit been realized."

However, the splendid results obtained in laboratory experiments and specially constructed experimental works led the authorities of English towns to persevere with experiments. Salford has at different times tried 13 different methods, Birmingham 7, and almost every large English town can boast of a similar experience.

A few German towns tried chemical precipitation with the same results as those obtained in England. There was effected a satisfactory removal of the suspended matters, but the effluent was putrescible and deposited solid matters in the bed of the stream. The process was very expensive and produced much larger quantities of sludge than did simple sedimentation. The sludge was unsaleable and owing to its putrescent character created local nuisance. Sludge presses were installed in the early '80's and are still in use. The presses convert the sludge into solid cakes, which are at least transportable.

Notwithstanding the failure of the biological methods to do everything claimed for them, chemical precipitation has been gradually given up until now it is only found in exceptional cases. In Europe it is still used as a preliminary to biological purification, while in this country it is occasionally used in the treatment of a trade waste or of a town sewage containing a large percentage of some particular factory pollution.

The first chemical precipitation plant for sewage in America was established at East Orange, New Jersey. The operation was considered too expensive, however, and some years ago the plant was abandoned, so that at the present time the only sewage plants using chemical precipitation in this state are a few small installations taking care of special trade wastes. In fact, about the only plants of this description in the United States mentioned in the treatises on sewage disposal are those of Worcester, Massachusetts, and Providence, Rhode Island. The Worcester plant was put in operation in 1890 and the Providence plant in 1901.

As it is not the present purpose to discuss in detail the process of chemical precipitation, the reader is referred

CHEMICAL AND ELECTROLYTIC TREATMENT.

to the many books on sewage disposal, each of which takes up this subject more or less at length. In 1890 the Massachusetts State Board of Health published an extensive report on the chemical precipitation of sewage based upon a very large and comprehensive series of experiments and investigations. To this work the reader is also referred.

As stated above, almost innumerable substances and combinations have been tried for the chemical precipitation processes, some of which work better than others under different conditions; and because of the difference in the various local conditions and compositions of different sewages, no one substance can be selected as best for all cases. In the Alumino-Ferric process a mixture of ferric and ferrous salts with aluminum sulphate, alone or with lime, is used. The International process consists in adding a compound called "ferrozone" to the sewage, and filtering the effluent through "polarite." These two substances are obtained by patented processes from iron deposits in South Wales. The A. B. C. process originally included (among a number of substances) alum, blood and clay, but later alum, clay and carbon were used.

Taking everything into consideration it seems that the chemicals best adapted to the treatment of sewage are ferric sulphate and lime. Aluminum sulphate is better than ferrous sulphate; but as ferrous sulphate is more easily and cheaply obtained it is generally used instead of either ferric or aluminum sulphate. In many cases copperas (ferrous sulphate) and lime together give nearly as good results as ferric sulphate, while lime or alum used alone is not quite so satisfactory.

When ferric sulphate or aluminum sulphate is used the addition of lime is unnecessary and the application of the chemicals is by means of proper regulation of concentrated solutions. Within certain limits, the greater amount of the chemicals used the better clarification will result, the alkalinity in the sewage being sufficient to cause the precipitation.

With lime, however, considerable care must be used to apply just the right amount to secure the best results.

OPERATION OF SEWAGE DISPOSAL PLANTS.

When too little is used the process is inefficient and when an excess is added it is wasted. With a large excess of lime the clarification is accomplished by the settling of the undissolved calcium hydrate. When smaller quantities are used the carbonic acid of the sewage combines with the lime to form calcium carbonate, which in settling causes the clarification. As calcium carbonate is somewhat soluble in sewage containing carbonic acid, enough lime must be added to combine with all of the carbonic acid to get the full effect of the calcium carbonate. Except, perhaps, in the cases of certain acid sewages "the lime process has little to recommend it." A large amount of lime water is needed, a very accurate adjustment of lime to the sewage is necessary, and a very close supervision of the operation is required to obtain good results. If, however, the sewage contains a goodly proportion of iron pickling liquors, as at Worcester, the addition of lime alone produces good results. The lime is ground up with water and fed to the sewage in a milky consistency. In general better results are obtained with fresh sewage than with stale.

The precipitation with copperas also requires skill and close supervision. The chemical is not precipitated by the alkalinity of ordinary sewage and a small amount of lime must be mixed with the sewage before the copperas is applied. "The quantity of lime required depends upon the composition of the sewage and the amount of copperas used, and can be calculated from a titration of the sewage. When copperas is added to the sewage alone, no precipitation takes place, and the result is no better than when sewage settles alone. The addition of enough lime to combine with the excess of carbonic acid over the amount required to form bicarbonate, and to combine with the sulphuric acid of the copperas, is necessary for precipitation; for, while sewage is alkaline, its alkali is all in the form of bicarbonate, and alkali as normal carbonate or hydrate is required to precipitate the iron. When this amount is added, the acid number with phenolphthalein will be zero. To insure a rapid action, a little more than this should be added. No better result is obtained when more lime is used. If much less is

CHEMICAL AND ELECTROLYTIC TREATMENT.

used, the iron will not be precipitated. If enough or too much lime has been used the mixture will color phenolphthalein red, while if too little has been used no color will be produced. This test affords an easy and accurate method of applying enough lime and of avoiding an excess. Very imperfect results are obtained with too little lime, and an excess is wasted when too much is used. With a suitable amount of lime the more copperas used the better the results; but with more than one-half a ton per million gallons the improvement does not compare with the increased cost. The amount of iron left in the effluent is much greater than with ferric sulphate, owing to the greater solubility of ferrous hydroxide."

The sludge resulting from the precipitation with lime and copperas is more easily handled in sludge presses than that from alum, although an excess of lime with considerable water causes some of the sludge to become emulsified, which makes the pressing of it well nigh impossible. The addition of lime to the drained sludge, however, makes it more easily pressed.

The efficient and economical management of a chemical precipitation works requires in constant attendance a trained man who must detect the changes in the sewage and accurately adjust the application of the chemicals to meet each change as soon as it occurs. The frequency of such occurrences will depend upon local conditions; and as these vary so widely the attendant must make a careful study of his plant, the processes involved, and the results to be accomplished. In general, the attendant should know just how much chemical is required and the exact strength of his solutions. Excesses of precipitants should be avoided, both on account of the waste of the material and for fear of injuring fish life in the stream. Most fish are extremely sensitive to chemicals and an overdose is likely to cause the death of the fish in the adjacent parts of the stream.

After the sludge has settled, the clear liquids are drawn off and the sludge removed and disposed of as any ordinary sludge. Frequently it is forced into specially constructed sludge presses and pressed between layers of canvas or sack cloth. The pressed cake is more

OPERATION OF SEWAGE DISPOSAL PLANTS.

easily handled. In some instances it is used for land filling and in others it is dumped into deep water.

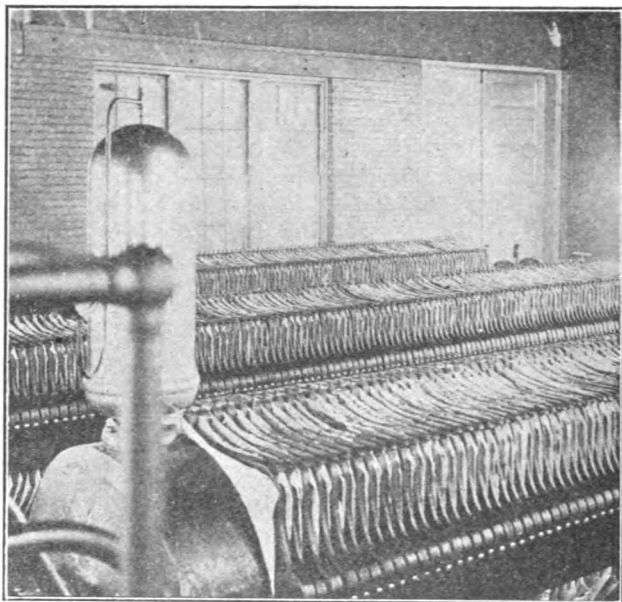

SLUDGE PRESSES AT WORCESTER, MASS.

In order to make the status of chemical precipitation more plain it may be well to quote the following resume from George W. Fuller's excellent book on "Sewage Disposal":

"Chemical precipitation affords efficient clarification, but the removal of finely suspended matter, due to coagulation, does not permit a stable effluent to be obtained from ordinary city sewage. The effluent is freer from organic matter than that obtained by plain sedimentation, and this allows a smaller degree of dilution when dispersed in water, and of a higher rate of filtration, other things being equal. But present evidence shows strongly that the improvement in the quality of the effluent over that obtained by plain sedimentation is not commensurate with the cost involved."

For ordinary sewages the day of chemical precipitation

CHEMICAL AND ELECTROLYTIC TREATMENT.

plants is rapidly passing. In the case of certain trade wastes there may be a field of usefulness for this method of clarification. With good management this method of treatment has not given much trouble as to odors, but it has developed complications as to the clogging of fine grained filters, as will be mentioned in connection with intermittent sand filters.

Comparing it with plain sedimentation in two-story tanks, chemical precipitation does not now give promise of being a serious competitor in the treatment of fairly normal sewages.

ELECTROLYTIC TREATMENT.

In some respects electrolytic treatment of sewage is closely allied to chemical precipitation, while in others it resembles disinfection.

Briefly, the process consists in passing the sewage between a system of electrodes, arranged in a channel conducting the flow. When the electrodes are active, such as iron or aluminum, they are gradually dissolved and quite a precipitate is formed therefrom. This aids in clarification. With passive electrodes, such as carbon, disinfecting substances, such as hypochlorites, are formed from the salts found in the sewage.

The underlying principles of the process are the fundamental laws of electrolysis and electro-chemistry, and the plants must be constructed and operated in accordance with those laws.

Twenty-five years ago the Webster process of treating sewages by electrolysis attracted some attention in England. More recently the Santa Monica and Oklahoma City plants have been more or less exploited and since then the new process of W. B. Bull has been made the subject of experimentation.

In New Jersey several attempts have been made to induce sewage companies and municipalities to install plants for the treatment of sewage by electricity, but up to the present time little has been accomplished. Both the process of precipitation by the use of active electrodes (iron or aluminum) and the application of ozone have been

OPERATION OF SEWAGE DISPOSAL PLANTS.

proposed. A plant using aluminum electrodes has been installed in Maryland for the treatment of creamery wastes, and the writer has been informed recently that the results are very satisfactory and at a very small cost. The ozone installations have not been so successful although at present extensive experiments with ozone are still being carried on in New Jersey.

In regard to the practical management of electrolytic plants for sewage treatment little can be said other than to urge the man in charge to familiarize himself thoroughly with all the fundamental principles regarding the process of treatment. Unless every stage is operated with care and intelligence, unsatisfactory results will be obtained and the cost will be excessive. The writer has upon several occasions come in contact with men who were straightforward and conscientious, but who were almost entirely prevented from making their experiments succeed because of ignorance of the fundamentals.

In regard to electrolytic treatment also the writer would quote from Fuller's "Sewage Disposal":

"Electrolytic treatment does not seem to afford a practical means of direct oxidation of organic matter in sewage so that the latter will be stable or non-putrescible. In fact, a substantial removal of organic matter is not a function of this process as applied up to this time.

"To some extent, however, oxygen is given off and this may aid in deodorizing sewage and reducing the quantity of unstable organic matter.

"As an aid to sedimentation, electrolytic treatment with iron electrodes is capable of practical use. There is no economy in this over the use of salts of iron now on the market. Aluminum electrodes are prohibitively expensive.

"The Bull process of using electricity to separate the acid ions of salt solution for use in making perchloride of iron, with a recovery of caustic soda as a by-product, seems to offer some hope of practical merit. It is not beyond the experimental stage.

"With any form of electrolytic treatment, sedimentation with or without filtration should be employed.

"Direct oxidation of the fairly unstable organic mat-

CHEMICAL AND ELECTROLYTIC TREATMENT.

ters of sewage may be secured with the aid of electrolytic treatment through the preparation of hypochlorites, as described later. This is essentially a sterilizing procedure and not aimed at the production of a stable effluent.

“Electricity may also be used in sewage treatment through the preparation of ozone. This has received considerable discussion at intervals, but it is not on a working practical basis at the present time.”

VI

TRADE WASTES.

The waste waters from the various trades and manufacturing processes are so complex and diversified in character that in order to secure the best results in the purification treatment, each waste is often made the subject of experiment.

When the waste is of a relatively small amount and of a character which will permit of its being discharged into the sanitary sewerage system, it usually has little appreciable effect upon the regular treatment at the disposal works. At one of our factories in which pipe fittings are made, all the iron pickling liquors, oils and soap waters from the tapping machines are discharged into the sewer along with the toilet wastes from the employees. The resulting sewage is very satisfactorily taken care of in a disposal plant of the ordinary style, consisting of pumps, sedimentation tank, dosing tank, sprinkling filters, secondary settling tank and sand beds. In fact, almost every city sewerage system carries objectionable trade wastes from manufacturing establishments. These wastes when in large quantities often have to be considered in the choice of the type of disposal works, and they often modify the operation, but usually little difficulty is experienced.

On the other hand, when the wastes are of such a character as to exclude them from the sanitary sewer or when the factory is in an isolated location, special works for their treatment must be established. These works must of necessity be designed and modified to meet the needs of each particular case, and it will be impossible at this time to lay down definite rules or instructions to be followed, because, as intimated above, each installation must be the result of special consideration, study and perhaps experimentation.

TRADE WASTES.

When the ordinary biological processes are not sufficient, applications of chemicals or electricity are often resorted to as an aid in the preliminary treatment. In order that such treatment may be effective with the least possible expense, each case must be considered, both as to the character of the wastes and to the quality of effluent required. Care must be exercised in the selection of the proper chemicals and also in the intelligent and scientific application of them to the solutions to be treated.

At some plants which take care of wastes from milk bottling establishments, chemical precipitation with water-slaked lime works fairly satisfactorily if the attendant carries out the instructions faithfully. In these cases the waste waters are heavily charged with some of the common washing compounds, consisting for the most part of alkaline carbonates. The carbonates unite with the lime, forming a precipitate of calcium carbonate, which in settling clarifies the solutions. The resulting liquid is then treated on a filter or run directly into some body of water. If, however, insufficient soda or washing powder has been used or if the lime has become air-slaked or if the lime is just thrown in without slaking it properly in water, little if any good is accomplished. The writer has met with all these faults because the attendant did not realize the importance of carrying out his instructions to the letter.

For the treatment of milk wastes, a combination of alum and lime works better than lime alone, but additional precautions in the operation are necessary. The alkalies should be added and well mixed with the wastes, before the addition of the alum, in order to secure the best effect of the reaction.

For milk wastes in moderately small quantities, the writer prefers as a preliminary process a long septic tank treatment of a week or more in duration. By this means the organic matters are given an opportunity to be broken down and the objectionable intermediate products of decomposition are allowed to go over into more stable and less offensive compounds.

This is in accordance with the manner in which the

OPERATION OF SEWAGE DISPOSAL PLANTS.

decomposition of many organic substances takes place. In order to prevent nuisances, either the intermediate decomposition products must not be allowed to form or they must be undisturbed until they have been broken down into their final compounds.

The effluents from such a process may be treated on land or on filters, or under some circumstances may be discharged into bodies of water.

The wastes from dye works, paper mills, tanneries and such establishments are often precipitated with chemicals as a preliminary treatment, while the grease from wool scouring processes is recovered by the application of sulphuric acid.

As it will be impossible to go into details as to the management of trade waste plants, on account of their diversity in character, it will be sufficient to urge that the man in charge thoroughly acquaint himself with his plant and with the principles underlying all the processes involved, and that he carry out the operation strictly in accord with the principles in every detail.

VII

TESTING STATIONS.

Sewage testing stations are often called experiment stations. In fact, they are both. Reference has already been made to these works in regard to having them operate under precisely the same conditions under which the final plant will have to work and also it was pointed out that data and results obtained at such stations must always be considered in conjunction with the conditions under which such results were derived. There are still other important features connected with testing stations.

It would seem that the mere establishment of a sewage testing station presupposed maintenance funds; but the writer has seen much valuable time and many important data lost on account of the lack of some simple and comparatively inexpensive facilities for grasping the opportunities. The writer knows of a testing station with almost unlimited funds back of it, but the manager is so handicapped with red tape that should something happen to a pipe and his one wrench, it would take about six months to get through a requisition for the purchase of a new wrench to fix the pipe, so that the station could continue to operate. At this plant experiments are often delayed for weeks because some little carpenter work is needed and the only available man, although quite capable of doing the work well, is prevented from doing it because he is rated on the Civil Service list as a painter, or some other knight of the trade. In experimental work emergencies cannot be foreseen, therefore supplies and facilities should be provided to take care of break-downs and things likely to happen, while a sufficiently large petty cash fund should always be set aside and the manager given full power to expend as much of the funds as may be necessary in emergencies. If the manager cannot be trusted to do this, then get another manager; for if he does not have sufficient leeway, his data and

OPERATION OF SEWAGE DISPOSAL PLANTS.

results are likely to be very incomplete and oftentimes worthless. The purpose of a testing station is to find out data bearing on the subject in hand. If this is not done fully and properly, time and money will surely be wasted.

The man in charge of a sewage testing station should be a good all-round man in his line. He should have had training along all the lines of sewage disposal and should have a fair knowledge of chemistry, bacteriology, biology, microscopy and allied sciences, not to mention the different branches of sanitary engineering. He should be wide-awake, resourceful and always ready to grasp the opportunities and meet the emergencies as they come

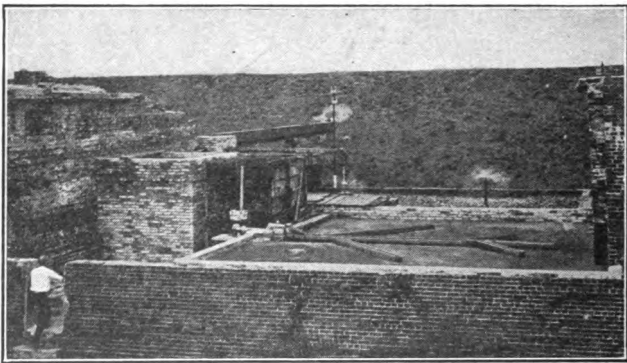

EXPERIMENTAL FILTERS AT THE M. I. T. EXPERIMENT STATION.

along. Some good managers can hardly drive a nail, and when this is the case a good "handy man" should always be around. Things need fixing at experiment stations mighty often and many times work must be done quickly and at the same time well. Structures, although temporary, must be made so as to be safe and not endanger life or limb.

Good and reliable chemical, bacteriological and engineering work must be done and likewise the work of taking samples must be faithfully and conscientiously performed. Inclement weather often seriously interferes with experiment station work, and it is usually at

TESTING STATIONS.

such times that results are most needed. Every effort should be made to have the station run properly under those conditions.

At isolated experiment stations it is often difficult to obtain supplies or have made up special pieces of apparatus. It is upon these occasions that the resourcefulness of the laboratory man is called upon. While, of course, every laboratory should possess a blast lamp, such is not always the case. At one time the writer was called upon to construct a complicated piece of glass apparatus involving the sealing and bending of large tubes, capillary tubes and stop-cocks. He constructed a blast lamp out of an ordinary glass test tube and a small piece of glass tubing, and furnished the blast by pumping the air and water from a small faucet suction pump into a bottle, using the air for the blast and allowing the water to flow off into the sink. With this apparatus quite considerable glass blowing was successfully done. This is mentioned to show how things at hand may be utilized, when necessary, in place of more elaborate and costly apparatus.

VIII.

MAKING TESTS.

Standard Methods of Making Physical, Chemical and Bacterial Tests of Sewage and Effluents.

A man in charge of a sewage disposal plant should know what each unit of his works is doing every day. A skilled observer may detect faults and short-comings with some degree of certainty by mere inspection; and if the output is bad and a heavy pollution is occurring or a local nuisance is resulting, it is not at all difficult to recognize the trouble. If the break-down has been sudden and due to a wash-out, a broken bed or wall or some other equally obvious cause, an expert is not needed to diagnose the case. But suppose the output of a plant or of some of its units is gradually falling below the requirements. In that case the gradual decline cannot be detected by observation and in order that one may know what is actually happening, tests are made. If frequently performed and recorded in a convenient scheme for comparison, much valuable information is obtained and a close check can be kept upon each and every unit of the plant, in order to head off or delay the necessity of extensive and costly renovation, which is bound to occur unless proper attention is given in time. Careful attention paid to tank effluents will delay for years the expenditure of thousands of dollars for the removal, washing and replacing of the stone in contact beds. Poor effluents discharged upon sand beds cause clogging quickly, which results in undue expense for frequent cleaning and often the sand filter effluent is seriously impaired.

To the trained man in charge of a plant equipped with a laboratory, little advice is necessary. His training and facilities enable him to keep close check upon his charge; but for the good of the cause he is especially urged to do routine work along the standard lines and so record it that his results can be of use to others besides himself. His tests should conform to the require-

MAKING TESTS.

ments laid down in the "Standard Methods of Water Analysis", published by the American Public Health Association. At the present writing a committee of that association is at work upon a report setting forth a uniform and comprehensive scheme of tests and records for sewage treatment works, so that results and data obtained by one observer may be compared with those derived by another. The publication of this forthcoming report is awaited with eager interest. It is hoped that it will develop a systematic and more widely spread corps of observers, while at the same time tend to check much comparatively useless routine, energies upon which might be more profitably spent in other directions.

To the untrained or partly experienced plant attendant who is anxious to learn, a few simple tests may be explained, which if carefully performed and recorded will not only become of great use in connection with the works at hand, but will also be of considerable benefit to the general cause of sewage treatment.

Reference to some of these have already been made in the foregoing pages under the several topics concerned, but for the sake of easy reference these will be repeated briefly in this chapter, and the attendant is urged to perform such as will enable him to run his plant in the most intelligent and efficient manner possible.

One of the prime requisites for all classes of plant attendants is a keen eyesight, coupled with a well-developed sense of perception. Close observation will teach him from what, where and when to take samples for his tests. Unless this is properly done and recorded with sufficient explanation to describe the sample accurately, the results mean nothing; and in addition, are dangerously misleading in the hands of the inexperienced or unsuspecting.

The tests given below have for the most part been taken bodily from the pages of the "Standard Methods" (to which the reader is referred), although in some cases slight modifications have been made.

TOTAL SOLIDS.

Procedure.—Ignite and weigh a clean platinum dish and into it measure 100 c.c. of the liquid. Evaporate to dryness on a water bath, dry in an oven, cool in a desiccator and weigh. The increase in weight gives the total solids.

OPERATION OF SEWAGE DISPOSAL PLANTS.

LOSS ON IGNITION.

Heat the platinum dish containing the residue in a "radiator" which consists of another platinum dish large enough to allow an air space of about half an inch between the inner and outer dishes, the inner dish being supported by a triangle of platinum wire laid on the bottom of the outer dish. Over the inner dish is suspended a disc of platinum foil large enough to cover the outer dish, to radiate the heat into it. The larger dish is heated to bright redness, until the residue is white or nearly so. Allow the dish to cool in a desiccator and weigh. This weight gives the fixed solids and the difference between it and the total solids gives the loss on ignition. An electric muffle furnace may be used for the ignition. Care must be used and the temperature not allowed to get too high or else some of the mineral salts will be volatilized.

TOTAL SUSPENDED MATTER.

Procedure.—Filter a definite quantity of the liquid, depending upon the amount of suspended matter contained, through a tared gooch crucible by means of a suction apparatus. Dry in an oven and cool in a desiccator and weigh. This gives the total suspended solids.

Carefully ignite, cool in desiccator and weigh. This weight gives the fixed solids and the difference between it and that of the total suspended solids gives the volatile suspended solids.

SUSPENDED MATTER WHICH WILL SETTLE. BY VOLUME.

Apparatus.—Tall straight-sided or conical glass vessels of 1 liter capacity, having a tapering interior at the bottom which is graduated in cubic centimeters.

Procedure.—Fill the glass to the liter mark with the sewage or effluent. After the specified time read the volume of the sediment by means of the c.c. graduations at the tapering bottom. During the settling carefully dislodge by means of a wire or glass rod any particles caught on the sides of the vessel.

For comparison of tank influent and effluent, take a representative sample of influent and, after the "flowing through" time has elapsed, a sample of the effluent should be taken. The results of the two samples may be compared to show the tank removal of suspended matter. The physical characteristics of the sediment should be observed as carefully as possible and recorded so that there may be less chance for errors in drawing conclusions.

CHLORINE.

Reagents.—1. Standard salt solution. Dissolve 16.48 grams of fuzed sodium chloride in distilled water and make up to one liter. Dilute 100 c.c. of this stock solution to one litre in order to obtain a standard solution, each c.c. of which will contain .001 gram of chlorine.

2. Silver nitrate Standard. Dissolve about 2.40 grams of silver nitrate crystals in one litre of distilled water. One

MAKING TESTS.

c.c. of this will contain approximately .0005 gram of chlorine. Standardize this against the standard salt solution.

3. Potassium chromate. Dissolve 50 grams of neutral potassium chromate in a little distilled water. Add enough silver nitrate to produce a slight red precipitate. Filter and make up the filtrate to one litre with distilled water.

Procedure.—Use 10 c.c. of the sample in a white six-inch porcelain evaporating dish when the chlorine content is not excessively high or low. Dilute to 50 c.c. with distilled water and add a definite quantity of the potassium chromate solution as indicator. Titrate with the silver nitrate solution, under similar conditions as to light, volume, temperature and indicator as were used in standardizing the silver nitrate solution.

TOTAL ORGANIC NITROGEN.

Reagents.—1. A 30 per cent solution of copper sulphate.

2. A 5 per cent solution of potassium hydrate.

3. Concentrated C. P. sulphuric acid.

Procedure.—Take 50 c.c. of the sample and add 5 c.c. concentrated C. P. sulphuric acid and 3 or 4 drops of a 30 per cent solution of copper sulphate. Digest in a Kjeldahl flask over a flame under a hood until colorless. While hot add a few crystals of potassium permanganate until a heavy green precipitate persists in the liquid. Cool, Dilute to 250 c.c. and mix. Allow to stand until the manganese compounds have well settled out, otherwise a greenish solution will result upon the addition of potassium hydrate. Pipette out 20 c.c. of the diluted mixture and add an equal amount of 5 per cent potassium hydrate. Filter and pipette out an aliquot portion into a Nessler tube. Make up to the mark, mix and nesslerize in ten minutes. Read by comparison with Nessler standards and calculate in parts per million (see "Standard Methods"). Should the solution be turbid upon the addition of the 5 per cent potassium hydrate, use an 8 or 10 per cent solution. The 5 per cent solution is not strong enough for some sewages.

It is advisable to run a blank and apply the proper corrections if necessary.

NITROGEN AS FREE AMMONIA.

Reagents.—1. A 10 per cent solution of copper sulphate.

2. A 10 per cent solution of lead acetate.

3. A 50 per cent solution of potassium hydrate.

Procedure.—Fifty c.c. of the sample are mixed with an equal volume of water, and a few drops of the copper sulphate solution are added. After a thorough mixing, one c.c. of the potassium hydrate solution is added and the contents are again thoroughly mixed by shaking. The solution is then allowed to stand for a few minutes, when a heavy precipitate should fall to the bottom, leaving a colorless supernatant liquid. Nesslerize an aliquot portion of

OPERATION OF SEWAGE DISPOSAL PLANTS.

this clear liquid. Usually 4 c.c. of the mixture will be sufficient to fall within the range of the Nessler standards.

Many samples containing hydrogen sulphide require the use of lead acetate in addition to the copper and with others a little magnesium chloride is said to be of service.

NITROGEN AS NITRATES.

Reagents.—1. Sulphanilic acid solution. Dissolve 3.3 grams of sulphanilic acid in 750 c.c. of water by the aid of heat. Add 250 c.c. of glacial acetic acid and make up to 1 liter.

2. A-naphthylamine acetate solution. Boil 0.5 gram of solid a-naphthylamine in 100 c.c. of water for 5 minutes. Filter through a plug of washed absorbent cotton. Add 250 c. c. of glacial acetic acid and dilute to 1 liter.

3. Sodium nitrite stock solution. Dissolve 1.1 gram silver nitrite in nitrite-free water; precipitate the silver with sodium chloride solution and dilute the whole to 1 liter.

4. Standard sodium nitrite solution. Dilute 100 c.c. or solution (3) to one liter, then dilute 10 c. c. of this solution to one liter with sterilized nitrate-free water, add one c.c. of chloroform and preserve in a sterilized bottle. One c.c. = 0.0001 mg. nitrogen.

Procedure.—Take 10 c.c. of the sample and 90 c.c. of water in a low form 100 c.c. Nessler tube and add 2 c.c. of each of reagents Nos. 1 and 2 and mix. Let stand and read in 10 or 15 minutes by comparing with temporary standards made from reagent No. 4 or permanent standards made as follows:

Cobalt Solution.—Weigh out 24 grams of cobaltous chloride ($\text{CoCl}_2 \cdot 6\text{H}_2\text{O}$) and dissolve it in distilled water. Add 100 c.c. strong HCl and make up to one litre with distilled water.

Copper Solution.—Weigh out 12 grams of dry cupric chloride ($\text{CuCl}_2 \cdot 2\text{H}_2\text{O}$) and dissolve it in distilled water. Add 100 c.c. of strong HCl and make up to one liter with distilled water.

Make up standards in 100 c.c. tubes by running in the amounts of cobalt and copper solutions given in the table and filling up to the mark with water. Label each tube with its corresponding nitrate number.

C.C. Cobalt Sol.	C.C. Copper Sol.	Standard Nitrate Number.
1.1	1.1	1
3.5	3.0	3
6.0	5.0	5
8.7	6.9	7
12.5	8.0	10
20.0	8.0	15

MAKING TESTS.

Phenolsulphonic Acid Method.

Reagents.—1. Phenolsulphonic acid. Mix 30 grams of synthetic phenol with 370 grams of C.P. concentrated sulphuric acid in a round bottom flask. Put this flask in a water bath and support it in such a way that it shall be completely immersed in the water. Heat for six hours.

2. A 25 per cent solution of potassium hydrate.

3. Standard nitrate solution. Dissolve 0.72 gram of pure recrystallized potassium nitrate in one liter of distilled water. Evaporate cautiously 10 c.c. of this strong solution on the water bath. Moisten quickly and thoroughly with two c.c. of phenolsulphonic acid and dilute to one liter for the standard solution, one c.c. of which will equal 0.001 mg. of nitrogen.

Procedure.—Evaporate 10 c.c. of the sample in a small porcelain evaporating dish on the water bath; removing it from the bath just before it has come to dryness. Let the last few drops evaporate at room temperature in a place protected from dust. Add one c.c. of phenolsulphonic acid and rub this quickly and thoroughly over the residue with a glass rod. Add about 10 c.c. of distilled water and stir with a glass rod until mixed. Add enough of the potassium hydrate solution to render the liquid alkaline. Transfer the liquid to a 100 c.c. Nessler tube and fill to the mark with distilled water.

If nitrates are present there will be formed a yellow color. This may be compared with permanent standards made for the purpose, by putting the following quantities of the standard nitrate solution into 100 c.c. tubes and making up to the 100 c.c. mark with distilled water adding 5 c.c. of strong ammonia or potassium hydrate to each tube; namely, 0, 1, 2, 4, 7, 10, 15, 20, 25, 30 35 and 40 c.c. These standards may be kept for several weeks.

Compare the sample treated as above described with these standards by looking down vertically through the tubes at a white surface so placed in front of a window that it will reflect the light upward through them. If the figures obtained by this comparison be divided by the number of c.c. of the samples which were evaporated, the quotient gives the number of parts per million of nitrogen in the form of nitrate.

If the color is too high to fit the standards, take an aliquot portion, dilute to 100 c.c. and compare.

Note.—As all permanent standards in tubes should be protected against dust and evaporation, covers made of discs of clear glass cemented on the tops of the tubes with a mixture of paraffin and bee's-wax are a great convenience. If desired, the tubes may be made with a small flat flange at the top to permit of a stronger seal.

When the chlorine content is above 30 the reduction method is recommended.

MAKING TESTS.

REDUCTION METHOD FOR NITRATES.

Reagents.—1. Potassium hydrate solution. Dissolve 250 grams of the hydrate in 1.25 liters of distilled water. Add several strips of aluminum foil and allow the action to proceed over night. Boil down to one liter.

2. Aluminum foil. Use strips of pure aluminum about 10 c.m. long, 6 m.m. wide and .33 m.m. thick, and weighing about 0.5 g.

Procedure.—Put 100 c.c. of the sample of water in a 300 c.c. casserole. Add 2 c.c. of the hydrate solution and boil down to about 20 c.c. Pour the contents of the casserole into a test tube about 6 c.m. long and 3 c.m. in diameter and of approximately 100 c.c. capacity. Rinse the casserole several times with nitrogen-free water and add the rinse water to that already in the tube, thus making the contents of the tube approximately 75 c.c. Add a strip of aluminum foil. Close the tube by means of a rubber stopper through which passes a "V" shaped glass tube about 5 m.m. in diameter. Make the short end of the tube flush with the lower side of the rubber stopper, while the other end extends below the surface of distilled water contained in another test tube. This apparatus serves as a trap through which the evolved hydrogen escapes freely. The amount of ammonia escaping into the trap is slight and may be neglected. Allow the action to proceed for a minimum period of four hours, or over night. Pour the contents of the tube into a distilling flask, dilute with 250 c.c. of ammonia-free water, distill and collect in Nessler tubes and nesslerize. When the nitrate content is high, collect the distillate in a 200 c.c. flask and nesslerize an aliquot portion. If the supernatant liquid in the reduction tube is clear and colorless, the solution may be diluted to a definite volume and an aliquot part nesslerized without distillation.

OXYGEN CONSUMED.

Reagents.—1. Concentrated C. P. sulphuric acid.

2. Standard potassium permanganate solution. Dissolve 0.3952 gram of the crystallized chemical in freshly boiled distilled water, and make up to one liter. Check against an ammonium oxalate solution. One c.c. is equivalent to 0.1 mg. of available oxygen.

3. Ammonium oxalate solution. Dissolve 0.888 gram of the substance in distilled water and make up to one liter. One c.c. is equivalent to 0.1 mg. of oxygen. Preserve with chloroform.

Procedure.—Measure into a flask 10 c.c. of the sewage and 90 c.c. of distilled water. Add 2 c.c. of the sulphuric acid and 10 c.c. of the permanganate solution. Place immediately in a bath of boiling water and digest for 30 minutes to the exact second. A few seconds before the expiration of the time remove the flask from the bath and exactly on the expiration of the 30 minutes run in 10 c.c.

MAKING TESTS.

of the oxalate solution. Then titrate back with the permanganate solution to a faint but permanent pink color.

Run a blank on 90 c.c. of distilled water under precisely the same conditions and make the necessary corrections.

The amount of the permanganate used in the determination minus the blank, is the amount actually consumed by the organic matter.

If the volume of the permanganate is insufficient for complete oxidation, use a larger quantity, as it should always be in excess.

DISSOLVED OXYGEN.

Winkler Method.

Reagents.—1. Manganous sulphate solution. Dissolve 48 grams of manganous sulphate in 100 c.c. of distilled water.

2. Sodium hydrate and potassium iodide solution. Dissolve 36 grams of sodium hydrate and 10 grams of potassium iodide in 100 c.c. of water.

3. Sulphuric acid. Specific gravity 1.4 (dilution 1:1).

4. Sodium thiosulphate solution. Dissolve 6.2 grams of chemically pure recrystallized sodium thiosulphate in dis-

tilled water and make up to one liter. This gives a $\frac{N}{40}$

solution, each c.c. of which is equivalent to 0.2 mg. of oxygen or 0.1395 c.c. of oxygen at 0°C. 760 mm. pressure. Inasmuch as this solution is not permanent, it should be

standardized occasionally against an $\frac{N}{40}$ solution of

potassium bichromate as described in almost any work on volumetric analysis. The keeping qualities of the thiosulphate solution are improved by adding to each liter 5 c.c. of chloroform and 1.5 grams of ammonium carbonate before making up to the prescribed volume.

5. Starch solution. Mix a small amount of corn starch with cold water until it becomes a thin paste. Stir this into 150 to 200 times its weight of boiling water. Boil for a few minutes and preserve by adding a few drops of chloroform.

The product known as soluble starch is more convenient to use, being more easily dissolved and made up into a clear solution.

Collection of the sample.—The sample should be collected with the usual precaution against the entrainment or absorption of any oxygen from the atmosphere. Aspirator bottle apparatus are sometimes used, although the sample bottle may be filled with a light mineral oil and lowered beneath the surface with the stopper in place. The stopper is then removed and the sewage allowed to fill the bottle by displacing the oil. From a running effluent a satisfactory sample may be obtained by allowing

OPERATION OF SEWAGE DISPOSAL PLANTS.

the bottle to be filled by means of a rubber tube. One end of the tube is held in the stream and the other inserted into the bottle to the bottom. The flow of liquid through the tube quickly fills the bottle and after the bottle has been allowed to overflow a few minutes the tube is slowly withdrawn, care being used to prevent any bubbles of air being caught and passed into the bottle during the filling. The bottles should hold about 250 c.c. and should have solid glass stoppers.

Procedure.—Remove the stopper from the bottle and add 2 c.c. or less of the manganous sulphate and an equal amount of the sodium hydrate-potassium iodide solution, delivering both of these solutions beneath the surface of the liquid by means of pipettes. Replace the stopper and mix the contents of the bottle by rapidly turning the bottle upside down several times. Allow the precipitate to settle. Remove the stopper and add about 2 c.c. of the sulphuric acid and mix thoroughly. After the precipitate is completely dissolved pipette out 200 c.c. into a flask and titrate with the N/40 sodium thiosulphate solution using a few c.c. of the starch solution toward the end of the titration. Titrate until the first disappearance of the blue color. Some analysts titrate 100 c.c. in which case an N/80 solution of sodium thiosulphate is used.

In each case the number of c.c. used gives directly the dissolved oxygen in parts per million. For accurate work, however, there are a number of corrections to be applied. (See Standard Methods.)

It is usually best to make the complete determination in the field unless the laboratory is nearby, because the titration on some sewages will not permit of being delayed even after the addition of the sulphuric acid.

TURBIDITY.

The simplest form of apparatus for this work is the candle turbidimeter (see Standard Methods, page 7). An incandescent electric lamp may be compared with and substituted for the candle. This is more convenient and does not heat the turbidimeter tube.

The sewage is poured into the tube until the outline of the light is indistinct. The turbidity is read directly from the graduation at the top of the liquid.

SEDIMENT.

A figure for sediment may be obtained by taking the difference between the turbidimeter reading of a settled sample and the reading of the same sample after shaking.

PUTRESCIBILITY.

Samples should be collected in well fitting glass-stoppered bottles of about 4 to 8 oz. capacity. No special precautions are necessary in collecting samples of ordinarily good effluents that are fairly high in dissolved oxygen. If the dissolved oxygen be low, precautions similar to those

MAKING TESTS.

used in collecting dissolved oxygen samples should be observed.

A one-tenth per cent solution of methylene blue, Merck's double zinc salt, BX, is used as an indicator. One-half cubic centimeter of this solution is added to the sample and the stopper is inserted by means of a twisting motion, so as to make it tight without any bubble of air remaining in the bottle. The sample is incubated at 20° C. for fourteen days, and observations made at least once a day. As soon as the sample has become decolorized the number of days standing blue are recorded and the sample discarded. For relative stability table see "Standard Methods."

For convenience a one per cent solution of the blue may be used, in which case only one or two drops, depending on the size of the bottle, are necessary.

The medicinal form of blue may be employed, although it is not so strong in color as the dye.

AVAILABLE CHLORINE IN BLEACHING POWDER.

Titration by Sodium Arsenite (Penot).

Reagents.—1. Sodium Arsenite Solution. Dissolve 4.948 grams of the purest sublimed arsenious oxide in a few c.c. of strong caustic soda, acidulate slightly with HCl and add 30 grams of sodium bi-carbonate and make up to a liter. This gives a tenth normal solution.

Note.—Sutton in his new edition on Volumetric Analysis, p. 139, gives the following new method to which the reader is referred: Dissolve 4.948 grams of the purest sublimed arsenious oxide in about 250 c.c. of distilled water in a flask with about 20 gm. of pure sodium carbonate. The mixture needs warming and shaking for some time in order to complete the solution; when this is accomplished the mixture is diluted somewhat, cooled, then made up to a liter.

This gives a tenth normal solution and may be checked with a tenth normal solution of iodine.

2. Iodized Starch Paper. This is made by moistening a piece of filter paper with a starch solution in which a few crystals of potassium iodide have been dissolved.

Procedure.—The sample is well and quickly mixed, and 7.09 grams weighed out from a stoppered test tube into a porcelain mortar, and the powder ground with successive portions of water until it is well triturated and washed into a liter flask without loss, and the mortar washed quite clean. The flask is then filled to the mark with water, well shaken and 50 c.c. of the milky liquid (= 0.3456 gm. bleaching powder), are taken out with a pipette, observing the precaution that it shall contain its proportion of the suspended matter.

This is titrated in a beaker with the tenth normal arsenious solution, until a drop of the mixture, taken out with

OPERATION OF SEWAGE DISPOSAL PLANTS.

a glass rod and brought in contact with the iodized starch paper, gives no blue stain.

Each c.c. of the arsenite used gives the percentage of available chlorine in the bleaching powder.

Bunsen's Method.

The chloride of lime solution prepared as above is measured into a beaker and an excess of a solution of potassium iodide added. The mixture is then diluted somewhat, acidified with acetic acid and the liberated iodine titrated with N/10 thiosulphate and starch; 1 eq. iodine so formed represents 1 eq. chlorine.

Solutions for Field Work.

For titrating solutions of bleach at disinfecting plants, it is more convenient to have the solutions of arsenite or thiosulphate of such a strength that 1 c.c. will be exactly equivalent to a definite number of milligrams of chlorine. For example: if 1.3944 gm. of As_2O_3 per liter are made up according to the method given above, one c.c. of the solution will be equal to one milligram of chlorine. With such a solution the calculations are simpler and more quickly made.

In place of the iodized starch paper, large drops of the iodized starch solution may be placed separately upon a piece of clean porcelain or white glass. These are touched in succession with the stirring rod as the titration proceeds. As soon as a spot fails to turn blue the end-point has been reached.

If preferred, toward the end of the titration, which may be done in a porcelain dish, a drop or two of the iodized starch solution may be added to the contents, causing a pale blue color, which disappears as soon as the end point is reached.

Bacterial Tests.

Bacterial tests on sewage and effluents are not of great importance except at those plants where disinfection is carried on. In some cases, however, it is very useful to know how the effluents are running and what the several units are doing in the bacterial reduction.

Of the tests usually performed, the total count on agar at 20° C., the total count on litmus-lactose-agar at 37° C., the number of red colonies on the same plate, and the presumptive test for *B. coli* are the ones most generally made.

The details in regard to the apparatus, collection and care of samples, the preparation, handling and storage of various culture media, conditions of incubation and expression of results, are all carefully laid down in the

MAKING TESTS.

"Standard Methods of Water Analysis" to which the reader is referred because all details of standard technique must be closely followed if results for comparison are to be obtained.

In general the technique for making plates is as follows:

The sample collected in a sterilized bottle is thoroughly shaken and one c. c. is withdrawn with a sterilized pipette and delivered into a sterilized Petri dish. If there be reason to suspect that the number of bacteria is more than 200 per c. c., mix one c. c. of the sample with 9 c. c. of sterilized tap or distilled water. Shake thoroughly, and with another sterilized pipette transfer one c. c. of this mixture to another 9 c. c. of sterile water and so on until the proper dilution has been obtained. The first dilution will be 1:10, the second 1:100 and so on. In case of an unknown sewage or effluent it is advisable to use several different dilutions of the same sample. To the liquid in the Petri dish add 10 c. c. of standard agar at a temperature of about 40° C. Mix the medium and water by tipping the dish back and forth, and spread the contents uniformly over the bottom of the dish. Allow the agar to cool rapidly on a horizontal surface and transfer to the 20° C. incubator. Incubate the culture for 48 hours at a temperature of 20° C. in a dark well-ventilated incubator where the atmosphere is practically saturated with moisture. After the period of incubation place the Petri dish on a glass plate suitably ruled, and count the colonies with the aid of a lens which magnifies at least five diameters. So far as practical the number of colonies on a plate shall not be allowed to exceed 200.

As sewages and tank effluents usually have to be plated at a dilution of one to one hundred thousand and other effluents at one to a thousand or ten thousand, it is convenient to indicate the dilution by a sub-figure instead of a fraction or sign of ratio. Thus S_5 would indicate that a sewage sample was plated at a hundred thousand dilution, and if 75 colonies were found, the addition of five ciphers to the 75 would give 7,500,000, the number of bacteria per c. c. Likewise E_3 would indicate an effluent at one thousand dilution and three ciphers are to be added to the count obtained on the plate.

OPERATION OF SEWAGE DISPOSAL PLANTS.

For the 37° count the same procedure is followed except that the medium is litmus-lactose-agar, the temperature is 37° C, and the time of incubation is 24 hours. In addition to the total count on this plate, the number of red colonies also is recorded.

For the presumptive test for *B. coli*, standard lactose-peptone bile is used in test tubes containing a small inverted test tube about three inches long. This tube is dropped in on the bile before being plugged with cotton and in the process of sterilizing becomes filled with the bile in its inverted position. One tube is inoculated with one c. c. of each of three or more dilutions, so selected that at least the highest dilution will be negative. The tubes are incubated at 37° C for 48 hours and all tubes showing 20% or more gas in the small inverted tube are called positive.

If desired the number per c. c. may be estimated by taking as the number the factor of the highest dilution which is positive. Thus of three tubes, if E_2 and E_3 are positive while E_4 is negative, then the *B. coli* figure per c. c. would be 1,000.

In inoculating the tubes care should be used to see that the inner tube is not stuck and that the bile under it is inoculated also.

If desired, after fermentation begins in an enrichment medium such as lactose broth or lactose-bile, some of the liquid may be tested out on Endo medium plates. The Endo plates confirm the gas formation in the tubes and the *B. coli* can be estimated as above.

IX

RECORDS OF PLANT OPERATION.

What Should Be Recorded and How—Charts and Tables —General Remarks.

Every plant attendant should be capable of keeping in an orderly manner some systematic form of record and every plant should have its daily "log." This is of infinitely more value to all concerned than the visitors' book so often found. At most of the smaller plants no record of anything is kept, and for this reason much valuable information is lost. Furthermore, the lack of such information is a serious drawback in many cases where advice is needed. As already stated before, many complaints, fancied or exaggerated, lose much of their force when brought face to face with a well kept daily record of the works.

Every effort should be made to have things handy, so that the least possible work is necessary to obtain data. The records, whenever possible, should be put down on ruled pages, in the form of charts or tables, so that the entries require the minimum amount of writing. The charts should also be arranged as graphically as possible, so that one can interpret the results at a glance. As far as possible all headings should be printed, even days of the week and month and perhaps time of day.

The use of solid lines of appropriate colors prolonged from day to day across the page, in many cases form effective entries.

As every plant has individual characteristics it will be impossible to design a simple form of record to fit all cases. Each case must be studied carefully and the charts must be prepared in a logical manner to fit the case while at the same time conforming to the standard requirements, so that comparisons can be made.

In order to furnish suggestions, a few of the matters which should be observed and recorded are named, as follows:

Sewage.—Volume, character, condition of suspended matter, collection of samples, record of analysis.

Screens.—When cleaned, amount and character of screenings removed, condition of screen-pit.

OPERATION OF SEWAGE DISPOSAL PLANTS.

Tanks.—Tank in service, time of flow through tank, c. c. of settling solids in influent and effluent, per cent removed, sludge and scum in tank in feet and cubic yards, cubic yards of sludge and scum removed, condition of gas vents and settling chambers, collection of samples and records of analysis.

Contact beds.—Rate of dosing, cycle of operation, condition of stone, percentage of voids, rate of decrease of voids, cleaning stone, character of effluent, collection of samples and record of tests.

Sprinkling filters.—Rate of filtration, dosing cycle, collection of samples and record of tests, removal of growths.

Sand filters.—Rate of filtration, dosing cycle, distribution, care of beds, material removed, material replaced, character of effluent, collection of samples and records of tests.

Settling basins.—Hours of retention, ebullition of gas, cubic yards of sludge removed, collection of samples and records of tests.

Disinfection.—Number of pounds of disinfectant, strength of disinfectant, strength of solution, rate of flow of solution, dose in parts per million of available chlorine, pounds of bleach per million gallons of sewage, collection of samples and records of tests.

Miscellaneous.—Rainfall, temperature of atmosphere and of sewage, odors, pumping records, and a full account of all costs, including machinery, apparatus, chemicals, tools, raw materials, labor, routine expenses, repairs and improvements. Notes should be kept of all unusual occurrences and troubles. It is often impossible to diagnose a case if depending solely upon the uncertain memory of the man in charge.

GENERAL REMARKS.

It is hoped that it will not be out of place to endeavor again to impress upon all concerned the importance of the proper care and management of sewage treatment plants. Successful sewage disposal plants must conform to fundamental laws of gravity, chemistry and biology. The myriads of living organisms which are constantly at work upon the organic matter are of many kinds, each susceptible to the slightest changes in environment. Fre-

GENERAL REMARKS.

quently very different results are obtained upon what appears to be an insignificant change in daily routine. As all of these things become more fully understood, the reasons for proper operation will become more apparent and works will not be operated in such a manner that conditions will be produced under which it will be impossible to obtain the desired results.

"The old adage as to the impossibility of putting a quart into a pint pot applies with equal force in sewage works." Outgrown plants cannot thrive. When a plant becomes so overloaded that one unit has to be rested at the expense of more serious overwork upon the remainder, little if any good is accomplished. There is nothing to do but enlarge the works.

Continuous attention to small things, as pointed out in the chapters on screens, tanks, beds, etc., distributes the care into a systematic routine which tends to maintain the plant in a good condition at all times. This does not mean that certain performances need be overdone. A process of putrefaction and decomposition, depending upon an element of time, is not hastened beyond a certain point by agitation. The breaking up of sewage scum is of practical benefit only up to a certain point, beyond which further agitation produces little good until time has been allowed for further decomposition.

The attendant should always be on the lookout for improvements, both in operation and design. By so doing he may be able to lighten his burdens and improve the results. But he should be extremely careful of any changes which may in any way become detrimental and unless he knows thoroughly what is likely to happen he should always consult a competent adviser before going ahead. Some seemingly minor changes often have far-reaching effects, on process both preliminary as well as subsequent to the point of change. This is well illustrated by the case of the raising of a weir wall of a settling basin to give greater head on the sand beds, which raised the flow line in the settling basins, thereby putting out of commission the contact beds by rendering the outlet siphons inoperative. The cut-off line of the siphons was then raised, which prevented the contact beds from

OPERATION OF SEWAGE DISPOSAL PLANTS.

draining, thereby causing stagnation and an accumulation of filth in the contact beds. When a mistake is made, go back and rectify it. Never attempt to offset one mistake by making another.

The ideas of the attendant, however, should be considered by his superiors, and he should be encouraged in his attempts to produce better results. One of our plant superintendents has found that, in pumping sludge, the placing of the "foot valve" on the platform beside the pump is a great convenience. A flexible suction hose is then attached and by moving it around in the tank the sludge is removed without any difficulty. He has also found that when he pumps sludge out into his lagoon the whole layer of soil, supporting a dense growth of grass and weeds, is lifted and floats upon the sludge. This forms a complete covering and no nuisance whatever is produced.

The design, construction, care and maintenance of the sewerage system have also a direct bearing upon the disposal works. The sewers should have smooth interiors, should maintain a cleansing velocity and should be kept flushed clean and well ventilated. The manhole heads should be high enough to exclude surface wash and grit. The sewer joints should be tight to exclude ground water and tree roots. It is believed that the enormous growths of *Leptomitrus* occurring in some sewers is in some way connected with the excessive infiltration of ground water.

The admission of certain trade wastes, steam, inflammable oils and vapors, excessive amounts of grease, wastes containing lint, wool fibres or other things liable to cause stoppages or injury to the sewers, should be carefully regulated.

The house connections should be carefully laid with no trap or obstruction between the street sewer and the top of the vent stack of the building. At seashore resorts, where the grades of the sewers are usually very flat, small sand traps may be installed on the premises, as a great deal of beach sand, tracked in by the bathers, finds its way into the sewers. Such traps should not run full, thereby cutting off ventilation; and they should be cleaned out with frequent regularity.

GENERAL REMARKS.

Many phases of the sewage treatment problem are still unsolved and unexplained. Considerable scientific research and investigation are needed. In the tank as well as in the oxidation processes, careful study is needed to determine what goes on and the exact characteristics of the environment which influences the various changes of the matter undergoing treatment. Just what part is played by the bacteria, just what by enzymes, just what by the higher organisms, has not yet been determined. We would like to know how to control to a better degree the different species of effective bacteria. Every little while a new form of tank or similar structure is brought out, based solely on some theory or belief. If it gives the desired result the theory is taken as proved, regardless of the fact that an entirely different design may give the same result.

The question to what degree it is necessary or even desirable to remove the products of decomposition in a sludge digestion chamber, needs further scientific investigation.

These and many other problems are not engineering problems but bio-chemical problems, and the scientific laboratory man is needed to work them out. Too often the engineer attempts to diagnose a case which more properly belongs to a brother specialist. It used to be that every sanitary question was submitted to the doctor; the chemist also was often called upon to decide the whys and wherefores of things entirely foreign to his profession. Now it is the engineer who is being consulted on every hand. When he makes a test on a piece of steel or a structure of concrete of known dimensions and composition, he gets a definite result. From such tests he is able to calculate the requirements of a complicated structure with considerable accuracy. When he designs a sewage disposal plant, he too often begins to theorize and guess when considering some of the chemical and biological problems involved. He often experiments by doing several things at the same time, and if the desired result is accomplished, he assumes that everything done was necessary to success. By cutting out superfluous attachments, apparatus, or processes, many designs have been simplified and the same results obtained.

OPERATION OF SEWAGE DISPOSAL PLANTS.

Scientific research is needed on many of the processes of sewage disposal in order to learn the causes and environment of the bio-chemical reactions, so that more intelligent designing may be done and our works simplified both in structure and in operation, instead of being made more costly and troublesome by useless complications.

It must not be taken that the engineering profession is blamed for the present status of the sewage disposal problems. Far from it. Since someone else has not gathered the data for him, the engineer must work out for himself what he can, and get along without the rest as best he may. He has no time to dwell on too many little details when the big things are waiting.

All praise to the engineers, who have saved thousands of human lives by preventing diseases while other specialists were investigating causes, characteristics and remedies. As a result, from the two points of view, we now have water purification to remove the cause and inoculation to protect the individual from attack.

Many engineers follow closely for some time the working of the plants they design. It would be well if this were more generally the custom. In this way defects are realized and corrected and the attendant can be instructed to bring out the best results from some special feature or innovation. Experience so gained will greatly assist in making the modifications necessary to adapt some standard process to a peculiar set of local conditions.

The above suggestions have been given solely for the purpose of reminding the designing engineer that the nearer he can get his design to fulfill the correct requirements, the better it can be operated and the better will be the results. And every detail worked out to lighten the burden of the operator will be appreciated and will be an incentive to faithful care.

Lastly, it is urged that the plant attendants keep full and complete records of their works, so that the designer may be kept posted as to the exact outcome of his efforts and that reliable operative data may be available for the good of all concerned.

INDEX.

	Page
Accidents, protection against.....	23
Absorption in contact beds.....	51
Absorption in sprinkling filters.....	59
Bacterial tests	124
Baffles in Imhoff tanks.....	30
Blue, Methylene, test.....	57, 122
Boston experiments	83
Chemical precipitation	99
Chlorine in bleaching powder, test for.....	123
Chlorine, test for.....	116
Cinder barriers on contact beds.....	52
Collecting bacterial samples.....	125
Contact beds, records of.....	128
Contact filters	46
Continuous attention needed.....	129
Control apparatus for hypochlorite.....	91
Copper sulphate	80, 98
Covers to sprinkling filters.....	61
Crops on sewage areas.....	77
Crude sewage	83
Digestion of septic sludge.....	25
Diluting samples	126
Disinfection	79
Dissolved oxygen, test for.....	121
Distributing troughs on sludge beds.....	41
Distribution on contact beds.....	52
Drawing sludge	40
Drowning in tanks.....	23
Drying sand beds.....	70
Electrolytic treatment	105
Entries in records.....	127

	Page
Feeding contact beds.....	52
Filling Imhoff tanks with water.....	42
Filter materials	47
Filters	46
Final settling basins.....	62
Fine screens	11
Foaming in Imhoff tanks.....	41
Footways on Imhoff tanks.....	28
Free ammonia, test for.....	117
Gates and valves.....	67
General records	128
General remarks	128
Grit chambers	7
Growths	99
Growths of vegetation on sand beds.....	70
Growths on contact beds.....	57
House connections	130
Imhoff tanks	26
Improvements and changes.....	129
Intermittent application on sand beds.....	68
Land treatment	74
Leptomitius	130
Liquid chlorine	95
Machinery and hypochlorite.....	91
Materials for sprinkling filters.....	59
Measuring rod for solutions.....	88
Methylene blue test.....	57, 122
Nitrates, test for.....	119
Nitrification in contact beds.....	47
Nitrites, test for.....	118
Nitrogen, test for organic.....	117
Ortho-tolidin	80
Oxidation on sand beds.....	68
Oxygen consumed, test for.....	120
Perforated metal	11
Pipes for hypochlorite.....	95
Plans and instructions at the works.....	56
Plating	125
Presumptive tests for B. coli.....	126

	Page
Raikes, Hugh	4
Records	127
Records of contact beds.....	128
Records of sand filters.....	128
Records of screens.....	127
Records of settling basins.....	128
Records of sprinkling filters.....	128
Records of tanks.....	128
Reserve compartments	22
Rest in contact beds.....	52
Sampling apparatus	41
Sand filters	62
Sand filters, records of.....	128
Sand traps	130
Scientific research needed.....	132
Screen records	127
Screens	9
Screens over tanks.....	16
Scum in Imhoff tanks.....	31
Sea water in septic tanks.....	24
Sediment, test for.....	122
Sedimentation tanks	18
Semi-circular channels	42
Settling basins, records of.....	128
Settling glasses	19
Septic tanks	23
Sewerage systems	130
Skimming tanks	17
Sludge beds	40
Solids, test for.....	115
Solutions for field work.....	124
Sprinkling filters	58
Sprinkling filters, records of.....	128
Straw screens	12
Sub-surface irrigation	77
Suspended matter, tests for.....	116
Tank records	128
Tanks	17
Tanks for hypochlorite.....	90
Testing stations	111
Tests	114

	Page
Thresh, Dr.	1
Trade wastes	108
Traveling expert	5
Turbidity, test for.....	122
Upward flow screens.....	12
Valve on sludge pump.....	130
Watson, John D.....	49
Winter treatment of sand beds.....	71
Worcester method of scraping.....	71
Worms	98

NOV 29 1915

