



## WORKS OF DR. H. B. BASHORE

PUBLISHED BY

JOHN WILEY & SONS.

---

### **The Sanitation of a Country House.**

12mo, vii + 102 pages, 16 full-page half-tone illustrations. Cloth, \$1.00.

### **Outlines of Practical Sanitation.**

For Students, Physicians, and Sanitarians. 12mo, vi + 208 pages, 42 illustrations, many half-tones. Cloth, \$1.25 net.

---

PUBLISHED BY THE F. A. DAVIS CO.

117 WEST 42D STREET, NEW YORK.

### **Outlines of Rural Hygiene.**

For Physicians, Students, and Sanitarians. Illustrated with 20 engravings, mostly original. 5 $\frac{1}{2}$  x 7 $\frac{3}{4}$  inches. 84 pages. Bound in extra cloth, 75 cents net.

D

# Outlines of Practical Sanitation

For Students, Physicians  
and Sanitarians

By

Dr. Harvey B. Bashore

Inspector for Pennsylvania Department of Health  
Author of "Outlines of Rural Hygiene" and "The Sanitation of a  
Country House"

"Through the Ages one increasing purpose runs,  
And the thoughts of men are widened with the  
process of the Suns."—*Tennyson*.

*With Forty-two Illustrations*

First Edition

First Thousand

New York

John Wiley & Sons

London: Chapman & Hall, Limited

1906

Eng 1109.06.9

HARVARD COLLEGE LIBRARY  
GIFT OF THE  
GRADUATE SCHOOL OF EDUCATION  
May 7. 1930

B

Copyright, 1906  
BY  
HARVEY B. BASHORE

ROBERT DRUMMOND, PRINTER, NEW YORK

TO

**Dr. Benjamin Lee of Pennsylvania,**

WHO FOR TWENTY YEARS, HAMPERED BY LACK OF MEANS  
AND UNWISE LAWS, GUARDED WITH UNTIRING ZEAL  
THE HEALTH OF A GREAT STATE,  
THIS BOOK IS MOST AFFECTIONATELY  
DEDICATED

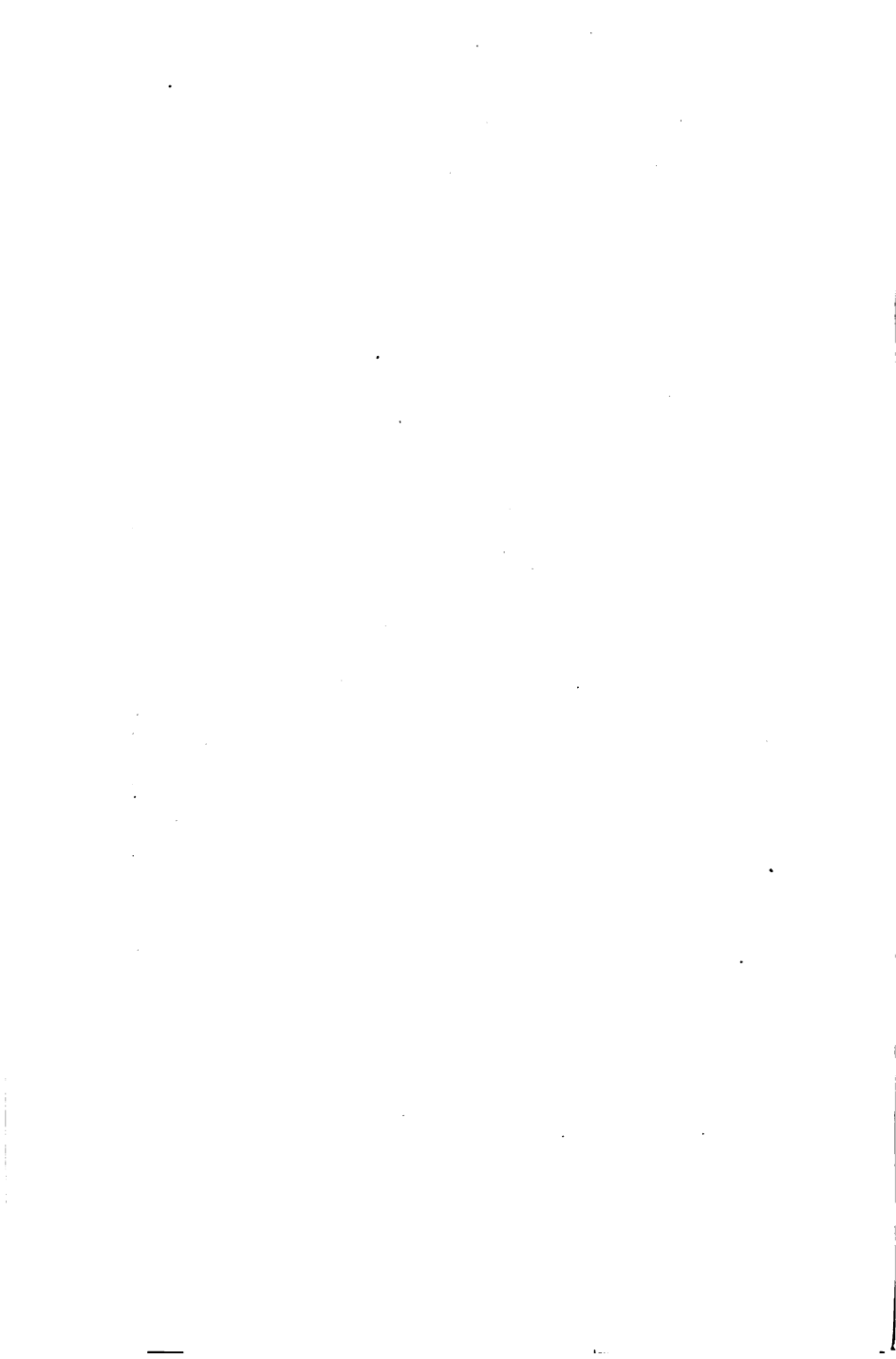

## PREFACE

---

No excuse need be offered for a new work on Sanitation, for the rapid progress that is being made in this science warrants a new book or a revision almost every year.

In the following work the author has departed from the beaten track of the usual sanitary text-book, and subjects are introduced which are of interest not only to health officials but to the taxpayer and the citizen; for example, the topics of milk- and food-supplies, car sanitation, etc., are subjects which are beginning to excite unusual interest everywhere and anywhere.

The work has been drawn from many sources and the author has tried to give credit where credit is due, but special reference should be made to the reports of the American Public Health Association. Much obligation does the author owe to his father, Dr. D. W. Bashore, for careful revision of the manuscript and proof, and assistance in many other ways.

WEST FAIRVIEW, PA.

July 23, 1906.





# CONTENTS

---

	PAGE
CHAPTER I	
HABITATIONS. . . . .	1
Construction. Plumbing. Ventilation and Heating. Artificial Illumination. The Back Yard. Hospitals, Prisons, and Asylums. Theatres.	
CHAPTER II	
WATER-SUPPLY. . . . .	30
Sources of Supply. Quality and Quantity. Storage and Distribution. Purification. The Examination of Water and Water-supplies.	
CHAPTER III	
THE COLLECTION AND DISPOSAL OF WASTE. . . . .	56
Liquid Waste or Sewage—Sewerage Systems. The Ul- timate Disposal of Sewage. Solid Waste and its Collec- tion. Disposal of Garbage. Disposal of Ashes and Street-sweepings. Disposal of Rubbish. Question as to Best Method of Disposal of Solid Waste.	
CHAPTER IV	
MILK-SUPPLY. . . . .	74
The Cows. The Stable. The Milker and Milking Utensils. The Milk. Transportation and Distribution. The Adulteration of Milk. Bacteriological Examination.	
CHAPTER V	
FOOD-SUPPLIES. . . . .	85
Bread. Fruits and Vegetables. Oysters, Fish, and Meat. The Adulteration of Foods.	

	PAGE
CHAPTER VI	
SCHOOL SANITATION. . . . .	95
The Building. Seating. Heating and Ventilation.	
Lighting. Water-supply. Toilet-room and Privy.	
Work and Play. Medical Inspection.	
CHAPTER VII	
CAR SANITATION. . . . .	109
Furnishing and Cleaning. Ventilation and Heating.	
Disposal of Excreta. Drinking-water. Street-cars.	
CHAPTER VIII	
THE CAUSE AND PREVENTION OF CONTAGIOUS AND INFEC- TIOUS DISEASES. . . . .	119
Smallpox. Measles. Scarlet Fever. Whooping- cough. Diphtheria. Typhus Fever. Cerebrospinal Fever.	
Tuberculosis. Typhoid Fever. Cholera. Malarial Fevers.	
Yellow Fever. The Plague. Hydrophobia. Anthrax.	
Glanders. Tetanus.	
CHAPTER IX	
VITAL STATISTICS. . . . .	140
Registration of Births. Registration of Disease.	
Registration of Deaths.	
CHAPTER X	
MUNICIPAL SANITATION. . . . .	147
History. Overcrowding. Street Cleaning. Public Baths. Public Parks and Playgrounds. The Smoke Nuisance. The Spitting Nuisance.	
CHAPTER XI	
RURAL AND SUBURBAN SANITATION. . . . .	166
General Considerations. Dwellings. Water-supply.	
Waste Disposal.	
CHAPTER XII	
PERSONAL HYGIENE. . . . .	187
Heredity. Food. Exercise. Clothing. Bathing.	
The Simple Life.	

# Outlines of Practical Sanitation

---

## CHAPTER I

### Habitations



**C**ONSTRUCTION. The first thing of sanitary importance about any building is to have a proper foundation: a foundation that is impervious to the ground air and ground moisture, or, more popularly speaking, the soil dampness; for a damp soil is always cold and a person living in a damp house lacks free evaporation from the skin and consequently is more liable to "take cold." Phthisis is one of the diseases, too, which especially bears a certain relation to soil dampness. We now know that this disease is caused by a specific germ, yet there is no doubt but that soil dampness is one of the several predisposing factors. Of rheumatism, although we are in doubt as to its exact ætiology, we also feel certain that one of the great causes, likely only a predisposing one, is exposure to cold and dampness. The complaint known as muscular rheumatism

## 2            Outlines of Practical Sanitation

is excessively prevalent in localities having damp and illy drained cellars and foundations. Diphtheria is a common disease in houses with wet foundations; easily explained by the experimental fact that diphtheria germs live for a long time on the walls of a damp cellar.

With these facts in view it is of the first importance that we construct foundations impervious to moisture and the ground air, for the air in the soil differs in composition from the atmosphere and is not suitable for breathing purposes. So the cardinal point in foundation building is not a support for the superstructure, but a means to keep soil air and moisture out of the house.

There are several ways of constructing a foundation so that it fills these requirements: one of the best, perhaps the best plan, is that adopted in New York City. After the cellar has been excavated to the required size and depth a solid bed of concrete a foot or two thick is put down on the bottom, and over this a damp-proof course of tarred felt and burlap is laid in hot pitch. On this as a base the walls are built, and on the outside of the walls a layer of tarred felt is laid in hot pitch, as is shown in Fig. 1. A foundation constructed in this way is absolutely proof against any trouble from the soil.

The material of which a house is built is an economic question rather than a sanitary one. A brick house, especially an unpainted one, allows natural ventilation through the walls; on account of the porosity

of the bricks it is a poor conductor of heat, and is consequently warmer in winter and cooler in summer than a wooden one. The construction, whatever the material, and this is really more important than

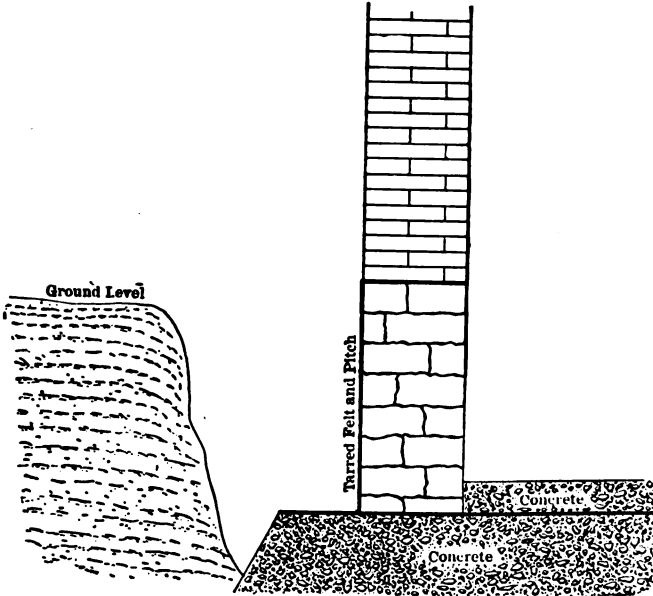

FIG. 1.—A Method of Constructing a Foundation.

the question of material, should be such as to admit of the greatest amount of sunshine and light in the greatest number of rooms, though on a city lot one is sometimes much hampered by adjoining buildings.

## PLUMBING

With the house properly constructed, the most important point yet remaining is the arrangement for the removal of household waste—and this, in the city, is by means of water service, necessitating a system of pipes, closets, baths, and sinks, known as plumbing—sanitary plumbing when properly arranged. The principal requirement about plumbing is that it does the work intended—the speedy removal of waste and the exclusion of sewer air from the house. In Fig. 2 is shown a diagrammatic section of a house with pipes and fixtures arranged in the proper manner.

All plumbing work should be thorough—smooth, perfect joints and no sharp angles—above all else it should be open so that all parts may be freely inspected if necessary. The vertical pipe, known as the soil-pipe, should always extend and open beyond the roof and the house-drain should always be trapped before its entrance into the sewer; this main intercepting or house-trap is generally placed immediately inside the foundation wall, and, although customarily used in cities with the combined system of sewerage, its omission is advised by many when the separate system (see Chapter III) is used, on account of the fact that it obstructs the flow of air into the sewers, which is so necessary for sewage purification. In most cities a fresh-air inlet, extending from the edge of the pavement, opens into the house-drain on the

house side of the main trap, thus allowing a free circulation of air through the pipes; this plan of having a fresh-air inlet, though theoretically perfect, is rather defective practically, for the opening of the pipe is quite often stopped up with dirt.

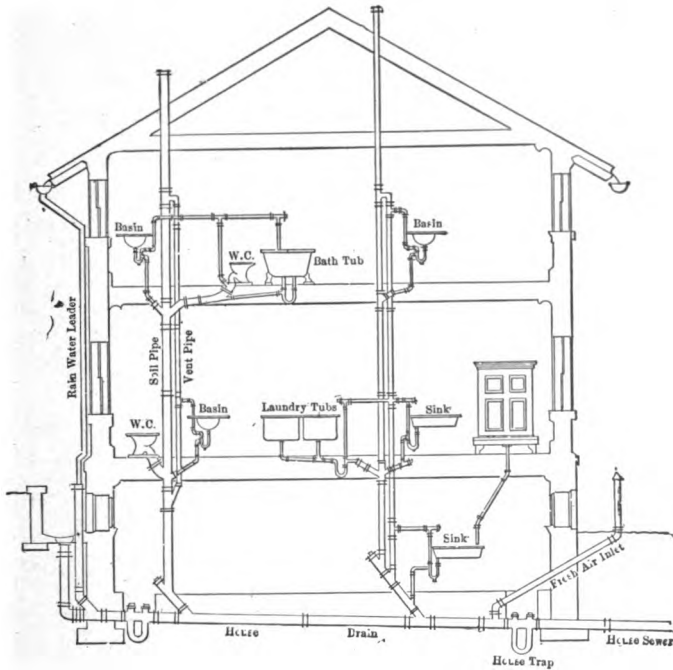

FIG. 2.—Section of a House, showing Plumbing System.

In order to prevent sewer air from getting into the house from failure of the main trap to work, or in absence of the main trap, every basin, closet, or bath has its individual trap; and right here it may be well to state that a trap is simply a bend in the pipe

## 6 Outlines of Practical Sanitation

which holds water enough to prevent the gases from passing into the house. There are many forms of traps, the simplest and one of the best being the S-trap shown in the drawing (Fig. 3).

If a fixture is not much used, sometimes the water evaporates and the seal is broken; this is avoided by

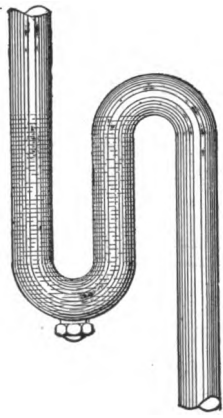

FIG. 3.—S-trap.

having a trap with considerable depth of water-seal; again, the seal is sometimes broken by “syphonage” from a rush of water down a near-by soil-pipe from a higher fixture; to prevent this vent-pipes are sometimes used, which are nothing more than ventilating-pipes which open into the top of the traps; the vent-pipe adds additional expense and also favors evaporation of the water-seal, but its good

points probably outweigh its defects.

The house fixtures, water-closets, wash-stands, baths, etc., should be all made with exposed plumbing. Formerly any dark corner or closet was used for such purposes, but modern sanitation demands that everything be open for inspection and cleaning. Fig. 4, which shows a picture of a modern bathroom, gives an idea of what up-to-date plumbing is able to do. Water-closets should combine simplicity with thorough flushing after use and proper refilling. The simplest form is the hopper closet, which con-



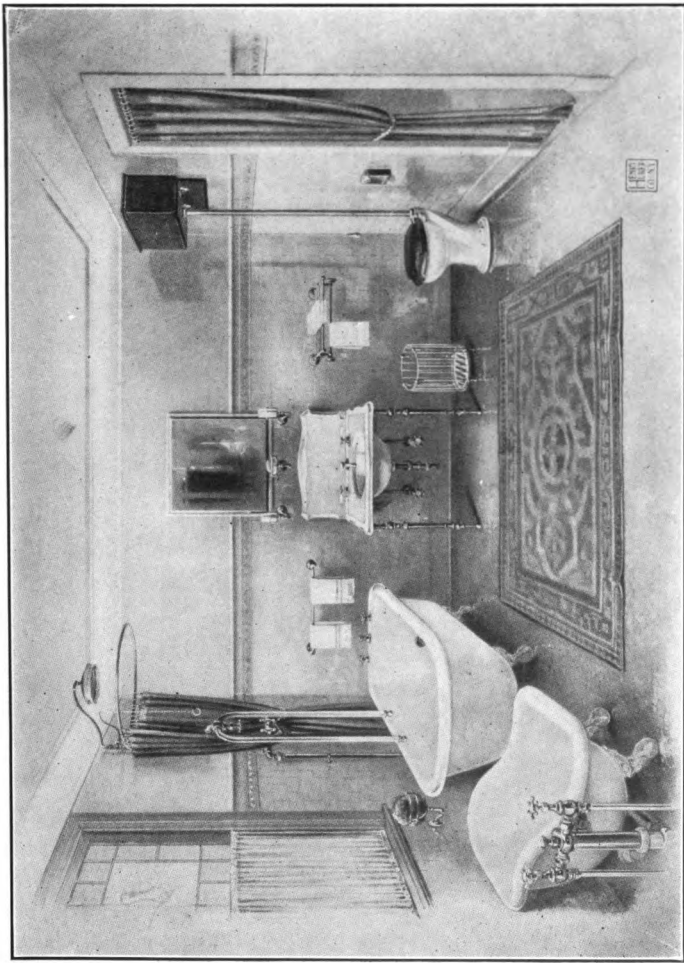
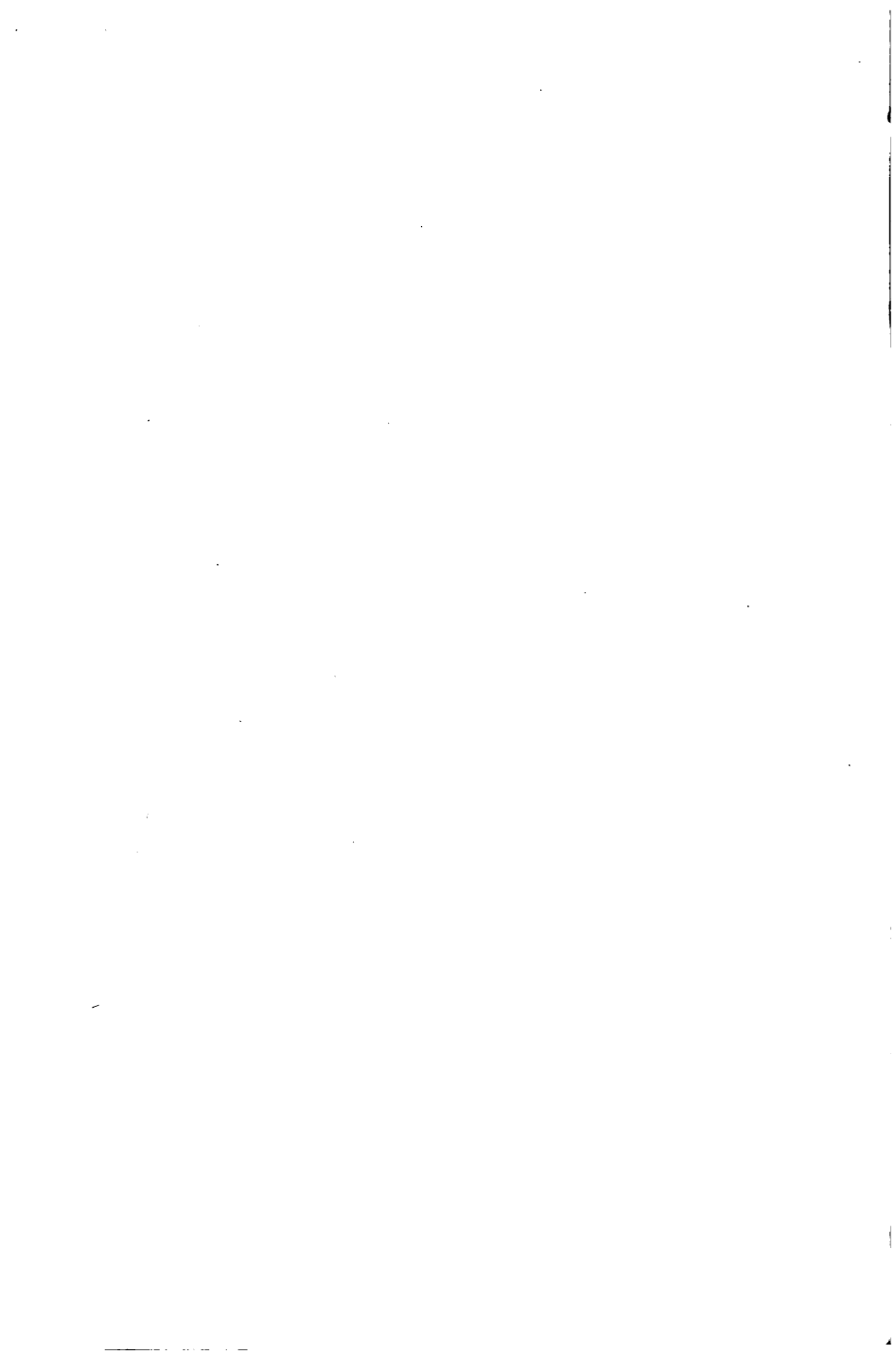

FIG. 4.—A Modern Bathroom. (From a copyrighted photograph by the Herry Huber Co.)



sists of a bowl and an ordinary trap. Modifications of this, which are generally used at present, are the wash-down and wash-out closets, both of which

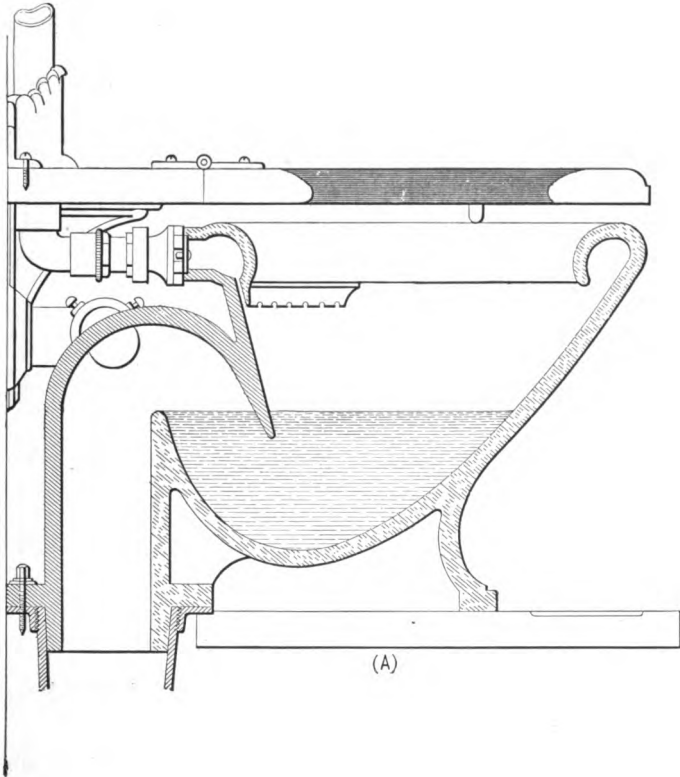

FIG. 5a.—Wash-down Closet.

have the water-seal in the bowl instead of underneath it. Pictures of these two forms are shown in Figs. 5a and 5b. The old-fashioned pan, valve, and

plunger closets are only of historic interest and have no place in modern plumbing. It is almost needless to state that all water-closets should be flushed by a separate cistern. Wash-stands and baths should, of course, all be trapped, but it is a good rule to

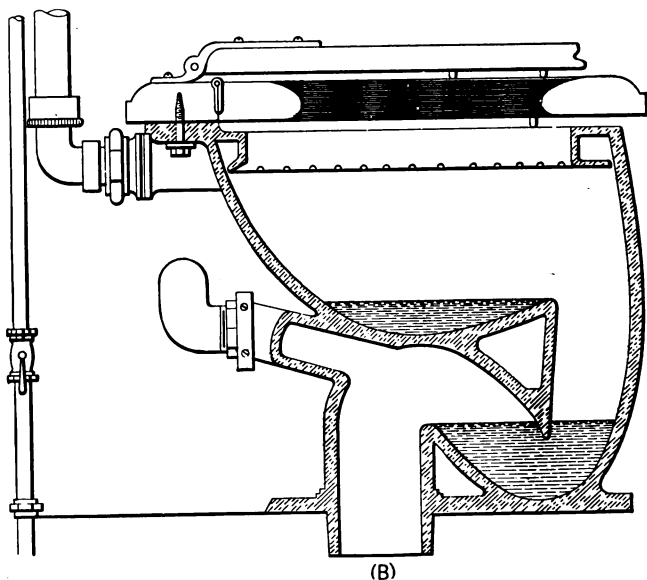

FIG. 5*b*.—Wash-out Closet.

have as few sewerage fixtures as possible in the house—simplicity is the watchword in plumbing.

**The Peppermint Test.**—The tests for plumbing work consists in putting into the pipes some volatile substance, the odor of which, escaping from any defect in the pipes, is readily detected; oil of peppermint is the substance generally used. Two to four ounces of peppermint oil are poured into the main

soil-pipe on the roof—the other pipe openings, if there are any, being closed—and is followed by a bucket of hot water and the opening of the pipe then plugged up. This work should be done by some person (other than the inspector) who should not come inside the house until the inspection is finished; if the test is carefully made any leak will be detected without difficulty.

The smoke test is also used to discover plumbing defects. It consists in forcing smoke into the system of pipes, the ends, of course, being plugged, and the smoke appearing wherever a leak exists.

#### VENTILATION AND HEATING

Ventilation consists in the means of furnishing sufficient pure air for breathing purposes. It has been found that we need about 3000 cubic feet of fresh air every hour, in order to prevent an undue diminution of oxygen and an increase of carbon dioxide, and when we do not get sufficient amount we suffer in various ways—in lowered vitality and in death, as has been proved by the crowding of a number of people into a small closed room. This lowered vitality, brought about by continued bad ventilation, leads to tuberculosis—the one great disease of defective ventilation. People who have been accustomed to live in the open air are especially prone to this disease when cooped up in houses. Dr. A. N. Bell tells the story of an Indian agent who many years ago built a number

of houses for his wards and persuaded them to occupy them. Not long after he left on a two years' leave of absence; on his return he found the Indians again living in their teepees and his houses used for store-rooms. On inquiry the Indian reply was "Too much house; spit blood." Only a story, but a story with scientific truth behind it.

This poor physical condition, due to defective ventilation, is seen not only in city tenements, but I have noticed it, and others have called attention to the same thing, in the mountain districts of Pennsylvania, and I suppose the same condition exists in other places. This class of people, breathing naturally the purest air in God's country, show the fallow, sickly appearance of defective light and oxygen. The reason seems to be that during the long winter months they are almost continually cooped up in small houses lounging behind the stove, and at night sleeping in small, low rooms, closed and unventilated, in order to keep out the cold.

The trouble caused by deficient ventilation is brought about mostly by lack of oxygen and increase of carbon dioxide, although other factors, for example, the organic materials of the expired air, are probably at work to bring about the result. The amount of carbon dioxide in the atmosphere is about .04 per cent and when this gets to .08 per cent the air is totally unfit for breathing, so by this we have a ready means of determining the purity of the air.

As has been said, an adult needs about 3000 cubic

feet of fresh air every hour, and to get this and remove the foul air is the aim of ventilation. Inasmuch as the air in a room can be changed about three times an hour, a room of 1000 cubic feet is the amount of air-space needed for one individual. This air-space can, of course, be diminished or increased according to the permanency of occupancy, labor, etc. In an ordinary dwelling 600 to 800 cubic feet of space should be allowed for each occupant, and in public buildings used only for a short time 300 cubic feet or even less is sufficient, considering that the air can be changed very often.

While in the warmer climate of the South ventilation is a factor to be considered alone, in the colder climate of the North ventilation and heating go hand-in-hand, and this brings us to the methods of heating which are considered with their ventilating effects. In house-warming we endeavor to bring the temperature to about 68° F., which seems to be the normal for most healthy people. There is a great tendency to keep houses entirely too warm, the result of which is the undue prevalence of chronic catarrhal inflammations of the mucous membranes of the throat and nose. If the heat is moist a much lower temperature will suffice, and for this reason English houses seem cold, and are cold, to Americans coming from a dry climate, where they are accustomed to, and where a higher temperature is actually necessary. The various methods of heating are open fireplaces, stoves, hot-air furnaces, hot water, and steam.

## 14      Outlines of Practical Sanitation

**The Open Fireplace.**—The open fireplace, which was the primitive mode of heating, has the objection of yielding only a small part of the fuel value as heat, only about ten per cent. As they give out practically only radiant heat they warm only the surface of objects facing the fire; if, however, the fireplaces are faced with iron or steel, or a Franklin stove used, we get some convected heat from the heated iron; or, better still, if the back of the grate is so arranged that a current of air passes behind the fire we may get even twenty-five per cent of the fuel value; this is accomplished by what is known as a ventilating-grate. Open grates are not much used for general heating, but only as an adjunct to other methods; they are, however, of exceeding value as ventilators and should occupy a place in every house. A room which has an open fireplace does not get that peculiar “stuffy” condition during occupancy which it is likely to get without one.

**Stoves.**—Stoves were the next step in the method of heating and a great step it was too, for stoves furnish about seventy-five per cent of the fuel energy as heat, but they do not allow for ventilation, so fresh air has to be supplied in some other way—very often it is a neglected way; the air of stove-heated rooms is likely to become superheated and too dry. In a good many of the older houses in some parts of the country there are open fireplaces—boarded up since wood has become scarce, and stoves used for heating. Now, in a case of this kind, if the fire-



place is left open entirely or partially ventilation takes place, and stove-heating becomes fairly effective.

**Oil- and Gas-stoves.**—Oil- and gas-stoves are considerably used at present and yield a great quantity of heat quickly and at moderate cost. It must not be forgotten, however, that these stoves use the oxygen of a room and give off carbonic-oxide gas; so that when used in closed apartments, there must be means for the introduction of plenty of fresh air.

**Hot-air Heating.** — The next improvement in house-heating was to put the stove in the cellar, surround it with an envelope of galvanized iron into which fresh air could enter, and run a number of pipes from the top of the hood to the rooms above; this, then, was the hot-air furnace, which is a very effective method of heating and ventilating if properly arranged. The furnace, of course, must be gas-tight and the cold-air must be taken from the outside of the house. I heard of a man who had the cold-air shaft open directly into the cellar, for the reason that it would take less coal to heat the already partially heated air of the cellar; he forgot, probably didn't know, that cellar air, or rather ground air, was unfit for breathing. The cold-air pipe should be thoroughly air-tight for its whole length, and the outside opening should be protected with wire netting. With proper construction and care, and with a good furnace placed on the proper side, from which the cold winds generally come—and with pipes having

## 16 Outlines of Practical Sanitation

sufficient elevation—a hot-air furnace will yield a splendid system for furnishing pure, heated air.

**Hot-water Heating.**—Hot-water heating consists in circulating hot water in a series of pipes and radiators, and depends for its action on the expansive force of heated water. We have both high- and low-pressure systems—low where the top of the system is open to the air; in this the temperature of the water reaches only  $212^{\circ}$  F. In the high-pressure system the top is closed and the water is heated up to about  $300^{\circ}$  F. Hot-water systems when well put up are very economical, but present the disadvantage of the water freezing in the pipes if the fire should go out; and with the radiators placed directly in the room there is no means of ventilation except from the door, windows, or open fireplaces. The proper method of using hot-water coils will be described under the next subject.

**Steam-heating.**—Steam-heating consists in circulating steam through pipes and radiators placed in the various rooms. In this, as in hot water, there are two systems, high and low pressure. The low pressure—only three or four pounds—is the one used in private dwellings. When a steam apparatus is put in properly, there is freedom from the noise of the condensing steam, and it is very economical; but with the radiators placed directly in the room, there is no provision for ventilation. Although hot-water and steam systems as commonly used in private houses do not make allowance for ventilation,

there are two methods by which the introduction of pure air may be accomplished—the direct-indirect and the indirect method.

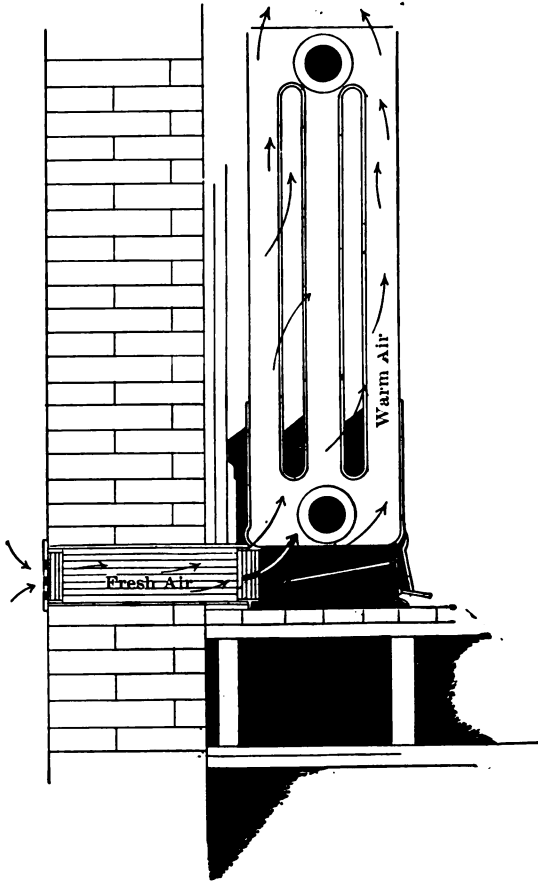

FIG. 6.—Heating by Direct-indirect Radiation.

*Heating by Indirect or Direct-indirect Radiation.*—  
In the latter method (Fig. 6) outside air enters

## 18 Outlines of Practical Sanitation

through a wall opening and passes over the radiator and thence into the room; the room being heated by convection and partially by direct radi-

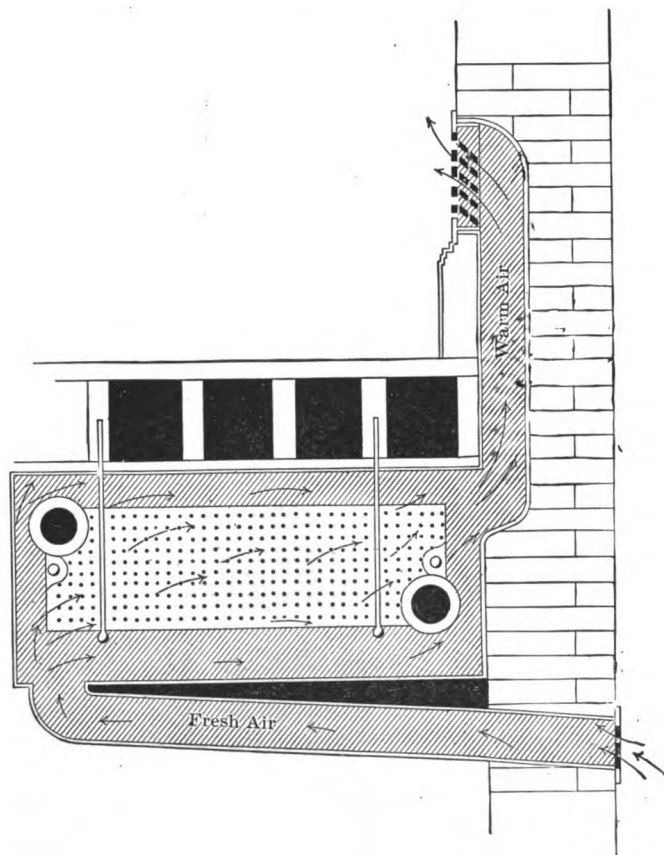

FIG. 7.—Heating by Indirect Radiation.

ation. In the indirect method (Fig. 7) the coils are placed in the cellar and enclosed in an air-tight box, which communicates with the outside air by a

flue; flues then lead from the coils to the rooms above just as in a hot-air system. In either of these methods we may use either hot-water, steam-coils or electrical heaters, but the latter are yet too expensive for general use.

In large buildings one or the other or both of these methods of heating are used in conjunction with an electric fan to force heated air through the building. In all of these systems of heating the foul air is removed by specially constructed air-shafts, by open fireplaces, or by windows or doors. Smead has devised a system which generally gives excellent results; in this method the heated air is admitted at the floor level, and after circulating around the room escapes by vents, likewise at the floor level; it then passes under the floor and finally escapes by the chimney.

There is yet some question as to where the foul-air shafts of a room should be located. If heated air is introduced at the floor level—and this is the proper place—it is certain that a more equable distribution of heat is obtained and more economically by having the foul-air vents also at the floor level, as has been demonstrated over and over again by the great efficiency of the open fireplace as a means of ventilation; this for ordinary rooms and houses. When it comes to the heating and ventilation of large buildings, using either the forced or exhaust systems, this rule is not so applicable, and the direct, opposite, hot air from above and extraction shafts

below, may give better results; in order to get the best results an expert should be employed to study the individual case.

**Examination of Air.**—In examining the air of a place we want to find out the proportion of carbonic-acid gas; if this is normal we may put it down that the air is fit for breathing purposes. Sometimes it is desirable to have a bacteriological examination, and this is made by drawing the air through sterile glass tubes coated with gelatin, or sterilized gelatin may be exposed in Petri dishes for a short time, then covered and set aside for colonies to develop.

*Test for Carbonic-acid Gas.*—The simplest test for this gas is Boom's modification of Wolpert's method, the description here given is taken from Egbert's Hygiene. "Make a mark on any test-tube, say one inch from the bottom. Fix the bulb of an atomizer to a small glass capillary tube, sufficiently long to reach to the bottom of the test-tube, and in such a manner that a definite quantity of air is forced from the bulb through the tube at each compression. To use: Fill the test-tube exactly to the mark with a saturated solution of lime-water, take the apparatus into the outside air and find out how many compressions of the bulb are needed, driving the air slowly through the lime-water each time to make the lime-water just turbid enough to obscure a pencil mark on white paper placed beneath the test-tube and viewed from above.

"Then rinse out the test-tube, fill exactly to the

mark again with lime-water, and repeat the process in the room the air of which is to be examined. We then assume that the outdoor air contains the normal amount of  $\text{CO}_2$ , 0.04 per cent (unless we happen to know the actual amount in the atmosphere at the time), and estimate the percentage of  $\text{CO}_2$  in the air of the room by the following proportion:

“The number of compressions of the bulb required in the outer air : the number of compressions required in the room ::  $x$  : 0.04;  $x$  = the percentage of  $\text{CO}_2$  in the air of the room. If the actual percentage of  $\text{CO}_2$  in the outer air is known, substitute this for the 0.04 per cent in the formula. Care must be taken in using this device not to draw any of the lime-water up into the bulb.”

#### ARTIFICIAL ILLUMINATION

There are three principal methods of lighting used at present, namely, by oil-lamps, gas, and electricity.

**Oil (kerosene) lamps**, when properly made and good oil used, give a serviceable light, but they have the great defect of using up a large quantity of oxygen, and, of course, giving off  $\text{CO}_2$ . An ordinary oil-lamp of 16-candle-power vitiates the air of a room equal to that of six or seven adults; consequently the custom of burning a lamp in a bedroom at night is bad, very bad, and sure to be followed by the deleterious effects of deficient ventilation.

## 22 Outlines of Practical Sanitation

**Gas Lighting.**—Gas furnishes much light and uses about one-half as much air as an equal power oil-lamp. When gas is used with the Welsbach burner, which contains an incandescent mantle of non-combustible salts, it uses up the atmosphere only about one-seventh as much as an oil-lamp and gives a pure white light.

There are certain dangers connected with illuminating-gas, the principal one being due to the carbon-monoxide gas contained in it; in coal-gas this is present to the extent of about eight per cent and in water-gas to the extent of thirty per cent. The inhalation of carbon-monoxide (CO) gas is a very serious matter; its toxic effects being due to its combination with the hæmoglobin of the blood, thereby causing a very persistent and fatal asphyxia. In small amounts it causes the languor, nausea, headache, and debility frequently seen in those subjected to escaping gas from stoves, furnaces, and leaking gas-burners.

Purified acetylene gas is being much used and gives a very satisfactory light; it is not as dangerous as either coal- or water-gas, takes less oxygen, and evolves less CO<sub>2</sub>; the odor is so peculiar that a small leak is readily detected—and this is a decided advantage.

**Electric Lighting.**—Electricity furnishes the ideal light, especially the incandescent-lamp which, evolving no heat, using no oxygen, and eliminating no CO<sub>2</sub>, has no effect whatsoever on the atmosphere of a



room. The globes should always be of ground glass, which, although absorbing considerable light, is much easier on the eyes.

The Cooper-Hewit lamp—a vacuum-lamp on the principle of the Crookes tube—is beginning to be somewhat used; it is cheap, but it has the disadvantage of giving everything under its influence a peculiar ghastly hue; it is easy on the eyes and does not impoverish the atmosphere.

### THE BACK YARD

The back yard is the one remaining point about the house which calls for some attention, for quite often its condition is anything but sanitary; often it is a litter of rubbish, ashes, tin cans, etc., with perhaps a bucket or a barrel partially filled with water, which in a suitable season breeds a million or two of mosquitoes. That the back yard should be clean goes without saying, and sanitation is only cleanliness. There can be no excuse for making a rubbish-dump of a city back yard, at least, for most cities speedily remove all such material.

The best condition in which to keep a back yard, especially a city back yard, is to have a closely cropped lawn; it looks clean, is clean, and grass will grow almost anywhere. In streets with high buildings, where the back yards are small and shady, a bed of ferns adds pleasure and purity to such a yard, for ferns will grow where sunlight is scarce and the grow-

ing plants will keep the soil sweet and fresh where it might otherwise be wet and sodden with filth.

### HOSPITALS

The construction of hospital buildings does not differ materially from any other, except, in that as we are dealing with the sick, all sanitary rules must be carefully observed, perhaps more carefully than when constructing buildings intended to be inhabited only by the well; one point needs special attention and that is the provision for sufficient air-space for the number of intended patients; it is generally conceded that we should allow 2000 cubic feet per patient and 150 square feet of floor-space; in contagious-disease wards even more is desirable.

The plan of hospital building at present advocated is that of detached buildings rather than one large building (Fig. 8). Probably one- or two-storied pavilions would be better, but this is hardly admissible where land is so valuable as it is in some of the great cities; modern sanitary building, too, has so improved that a four- or five-storied building may be made to meet all requirements. In the plan shown, which is that of a modern city hospital, some of the pavilions have five stories, with the operating-rooms on the top floor, which is perhaps a distinct advantage. Ventilating and heating is best accomplished by admitting outside air over steam-coils—indirect radiation. The modern hospital with

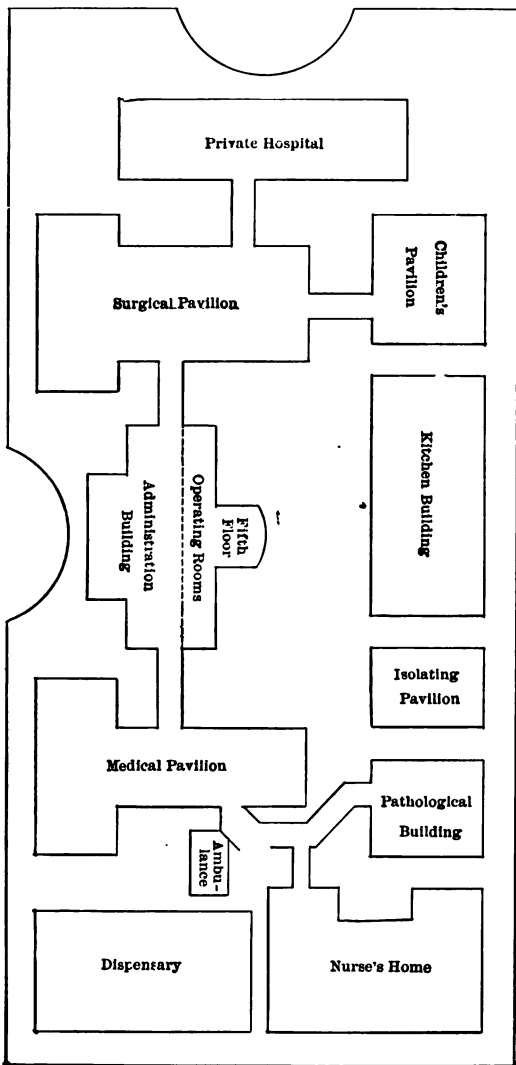

FIG. 8.—Plan of a General Hospital.

## 26      Outlines of Practical Sanitation

its hard-wood floors, smooth walls, large windows devoid of hangings, present a very different picture from the old-time ward. In hospital furnishings the greatest progress has been made; enamelled iron, porcelain, and glass are used for almost everything. For emergency hospitals portable houses are now available which are easily and quickly put up; in warm weather tents, of course, are all that are needed.

### PRISONS AND ASYLUMS

Before the days of John Howard any building was considered good enough for a prison. Since then humanity has directed some effort to ameliorate the condition of the criminal and the insane, and we now feel that although the State has a right to inflict even the death penalty in the manner prescribed by law upon the properly convicted prisoner, it has no right to kill him with typhoid fever, or tuberculosis, or some other disease of defective sanitation. A prison should be built with just as much care to sanitary details as any other building; not only should there be proper water-supply and means of waste disposal, but a proper amount of exercise and proper food should also be considered in the effort to support the health of the prisoner.

Modern asylum treatment is a vast improvement over even fifty years ago, but the unfortunate insane are still quite often herded into buildings more like cattle than human beings; overcrowding is the

great bane of the asylum, and I doubt if there are many public asylums which are not in a chronic condition of overcrowding. Another point is the food, which should be given careful attention. I have myself seen patients suffering with scurvy in one of our great city asylums. This institution had a splendid set of diet tables gotten up by a man with an international reputation, but the poor condition of the food, the poor and filthy cooking, and the poor service made it so repulsive that it did not meet the ends intended.

#### THEATRES

The two great sanitary requirements of the theatre is that the building be made as fire-proof as possible, and that it has an efficient system of ventilation. Improved building methods and the introduction of the electric light have greatly lessened the fire danger and have also made possible better means of ventilation. There should be, according to Gerhardt, who has made special study of theatre sanitation, about 1800 cubic feet of fresh air per hour for each individual. In a moderate-sized theatre with a full house this means an enormous quantity of fresh air, which can only be obtained by forced ventilation by means of fans. There are two methods of introducing fresh air: either from the top with foul-air shafts at the bottom, or fresh air at the bottom and foul air at the top; either of the systems are good,

## 28      Outlines of Practical Sanitation

the selection depending on the details of the building, subdivisions, etc.

The water-supply should be ample, consisting of two systems, one for plumbing fixtures and a separate

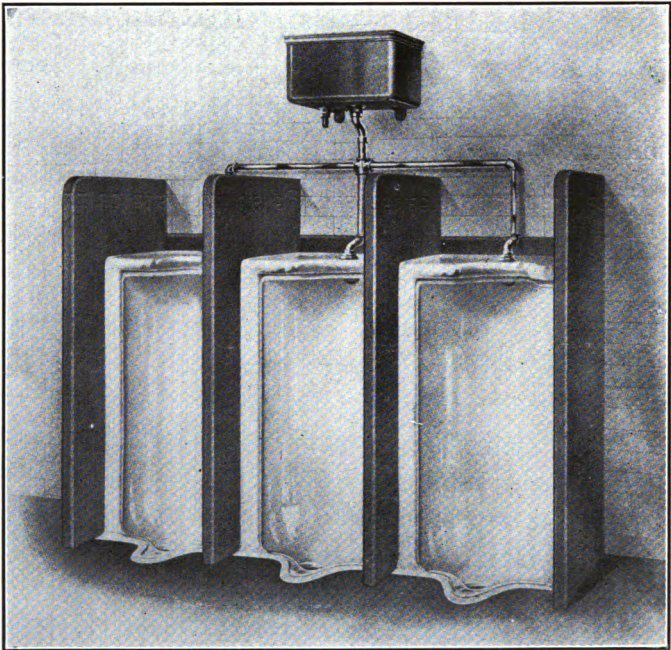

FIG. 9.—A Sanitary Urinal. (From a copyrighted photograph by the J. L. Mott Co.)

one for fire protection. Above all, it is of primary importance that the city should detail sufficient policemen, thoroughly conversant with the house and its exits, to preserve order and prevent panic in case of an alarm of fire.

There is one other point in which a good many public buildings, railway stations, and the like are especially defective, and that is the public urinal; to keep these appliances clean and non-odorous is one of the most difficult problems in sanitation. Slate and marble are unsatisfactory on account of their absorbent properties; what is needed is an absolutely non-absorbent material, made in one piece without joints, and this seems to be met by glazed porcelain such as is shown in Fig. 9. With proper flushing a urinal like this has given marked success, and I believe will tend to revolutionize this hitherto defective point in our sanitary methods.

## CHAPTER II

### Water-supply



THE necessity of every person using a pure water-supply is no longer a matter of theory, but a fact of the gravest importance; for not only are diarrhœal and digestive troubles caused by impure water, but the two great diseases, cholera and typhoid fever, are generally transmitted by this means. We in this country are paying the price of impure water-supplies by the sacrifice, through typhoid fever alone, of 40,000 lives every year—precious lives; young men and women stricken in their prime and before their time; sacrificed in many instances to an ignorance and a carelessness born of graft and greed. There is no longer any excuse for the existence of typhoid fever; every case means some one's ignorance or carelessness, and the day is fast coming when every case will become the subject for rigorous inquiry. Only the other day a town in Pennsylvania, scourged by typhoid, had the audacity to convene a public prayer-meeting for the purpose of calling on the Lord to stay the pestilence, while the town council



sat idly by with folded hands. Is it any wonder we have typhoid?

Considering the grave dangers of polluted water the supply of every community of any size should come under municipal oversight, and all communities should see to it that they obtain a supply which meets all the sanitary standards of purity; it is a duty that the citizens owe to one another.

#### SOURCES OF SUPPLY

The various sources from which a water-supply may be obtained depends on local conditions and circumstances; either wells, springs, lakes, and streams or rain-water.

Wells, although a common source of water in the country, to which reference is made in Chapter XI, are not very much used for a public supply, but in some instances they may furnish the most available source. When desired for a town supply a series of wells are drilled in the place selected, the water pumped to a reservoir, and then distributed. The points in considering the availability of wells as a source of supply are the amount of water needed, and the pollution or likelihood of pollution of the surrounding soil, for the ordinary well-water is simply drawn from the adjacent ground-water, which is good or bad according as the soil is polluted or not. The ground-water, by the way, is that underground sheet of water which fills all the interstices of the

soil to a certain depth; it has a periodic rise and fall, and is in lateral motion towards the nearest watercourse; such being the case it is evident that pollution may travel for a considerable distance. This is amply proved by the history of well-waters, which are so often contaminated and have caused so many epidemics of typhoid.

The character of a water depends, therefore, in a great measure on the character of the soil from which it drains. In heavy clay soils there is very slow percolation of the water and what does get through is quite often fairly pure. In gravel beds and loose sand the filtering properties of the soil are soon impaired, and in a region of upturned, broken, and crumpled strata, infection may travel a great distance, readily following the lines of fracture. In Fig. 10 is shown the section of a region where a small public supply is obtained from drilled wells; although this water is fairly pure at present, the probability of future trouble, due to increased building on the hillside and the inclination of the strata from this point to the wells, is very great; in addition a farmhouse and its accompanying outbuildings lay directly in the trough of the drainage scarcely a quarter of a mile away.

In places where they are available, Artesian wells sometimes furnish water of exceptional purity. In order to have a true Artesian well we must have a porous strata underlying an impervious one; this only occurs in regions where the strata are more or

less horizontal, places which are, in fact, parts of geological basins. Such places are found on the coast regions of the United States, the Upper Mississippi Valley, and a small region in Dakota; and in these localities Artesian wells may always be considered as one of the possibly available means of supply.

Another source of water-supply, frequently used by small towns especially, are springs and small

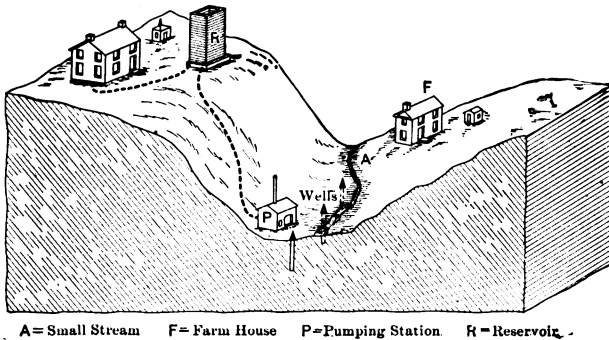

FIG. 10.—Section representing a Public Water-supply drawn from Wells, and Danger from Contamination.

streams. A good many people have the idea that any spring-water is good, but the truth is that spring-water, being simply an overflow of the ground-water, is just as good, and no better than its surroundings. If the gathering-grounds of the spring are uncultivated and uninhabited uplands, it will likely be good, but to trust a spring because it is a spring is folly. On the other hand, springs and high upland brooks far from contamination some-

## 34      Outlines of Practical Sanitation

times yield the purest waters obtainable. John Muir, the great naturalist, tells of the wonderful purity of the springs in the high Sierras. One of them he mentions as "sparkling, exhilarating, and so positively delicious to the taste, that a party of friends I led to it twenty-five years ago still praise it and refer to it as 'that wonderful champagne water.'" Of course the deliciousness of water generally depends on the thirst of the drinker, but no one can doubt the purity of these glacial-fed springs.

Small upland streams are sometimes used as a source of supply with the same idea of their intrinsic purity; but this is all fallacy; if they come from uninhabited highlands they are unquestionably safe; if their drainage area is inhabited, sooner or later they will show pollution. In Fig. 11 is shown the photograph of one of these mountain streams, with its gathering-grounds enclosed in a narrow valley; streams like this are frequently used as a public water-supply, though the gathering-grounds are thickly populated; to expect to get good, pure water from such a stream is unreasonable and a company that does furnish such water should be amenable to the law, if typhoid should develop among the consumers of the water.

Another of these upland brooks is shown in Fig. 12, although wild and uninhabited on its lower reaches, as indicated in the photograph, over the drainage of its head waters, a mile away, are five dwellings, in three of which typhoid fever has been a scourge.

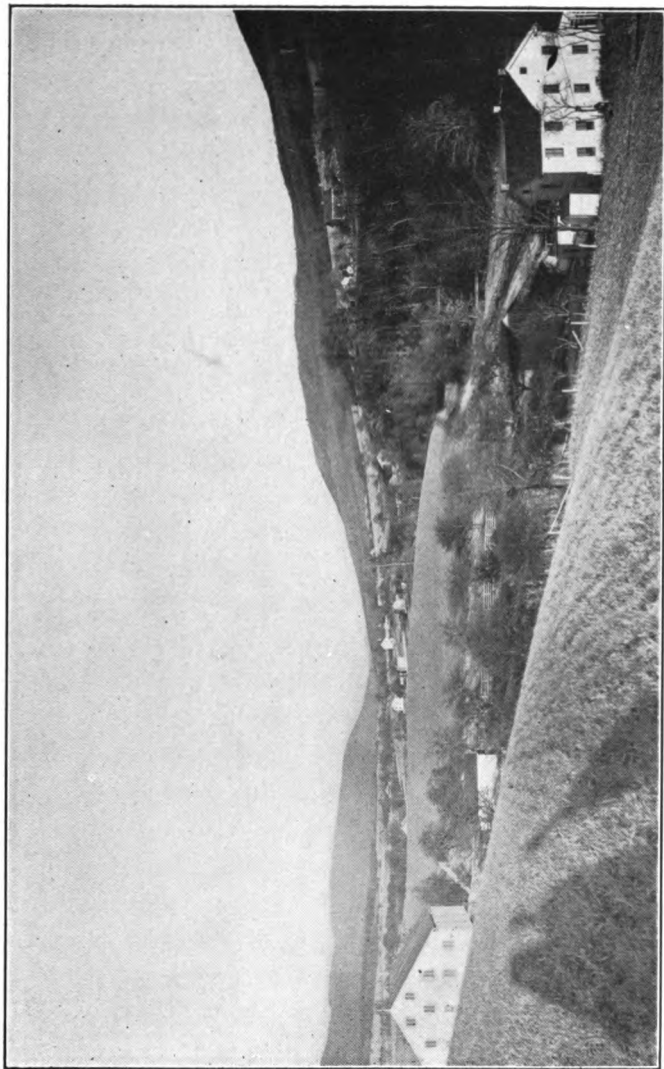
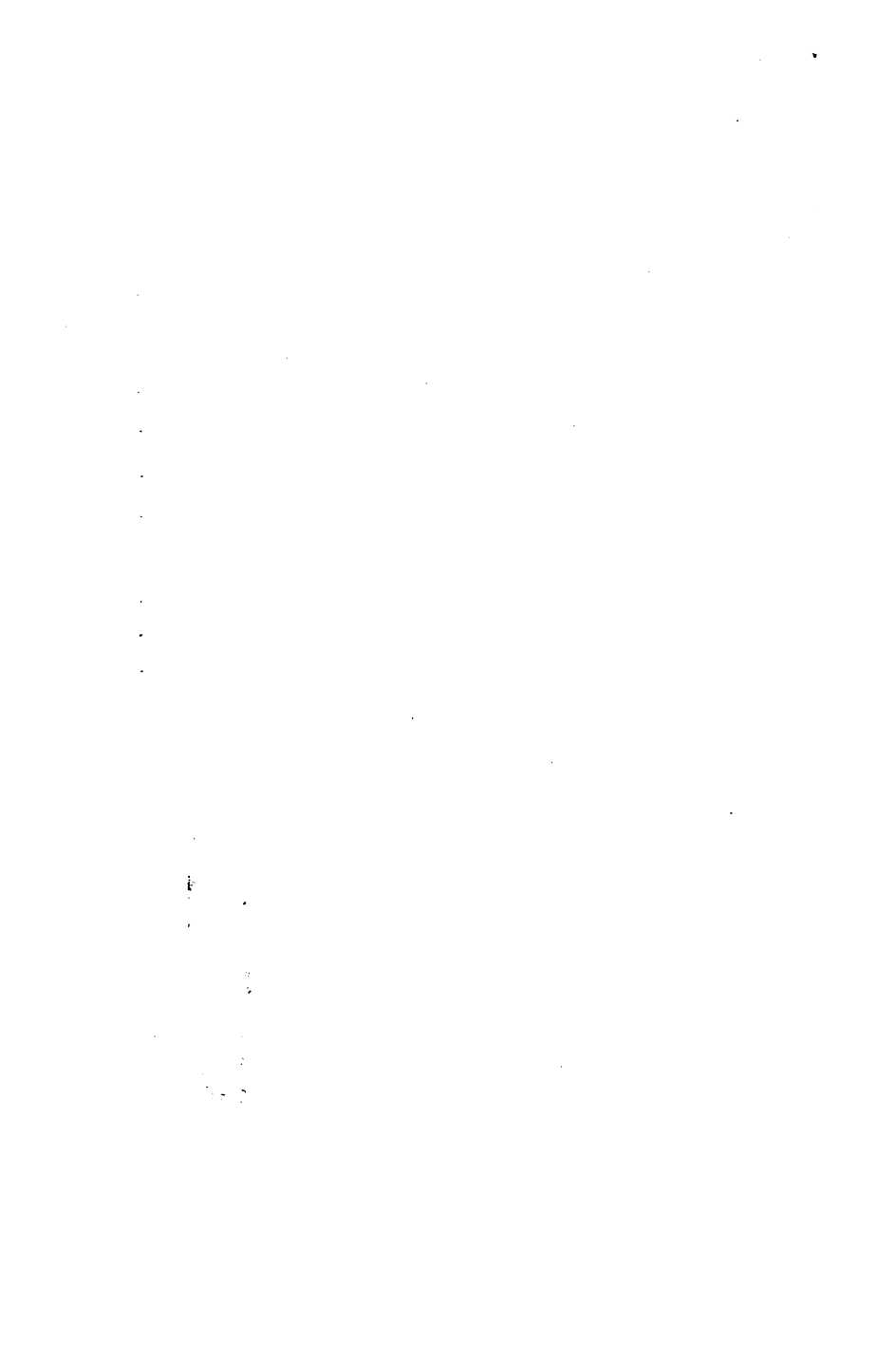

FIG. 11.—A Place like this sometimes furnishes the Gathering-ground for a Public Water-supply.  
(Photograph by Mr. James McCormick, Jr.)



No spring, no small stream, can be considered safe as a source of water-supply until its whole drainage area is known. Always be sure to see the other end of any such stream before you judge it suitable for drinking.

Rivers and lakes are generally used as a source of supply for the larger cities, but the country, east of the Mississippi at least, has become so thickly inhabited, and all the large rivers so polluted (Fig. 13), that to use such a water raw, i.e., without filtration or some other means of purification, is sure to invite disease sooner or later. We used to hear a good deal about the self-purification of running water, and it is a fact that flowing streams do purify themselves—due to the process of dilution and sedimentation, aeration and sunlight—but Turneure and Russell in their splendid work on “Public Water-supplies” claim “that it is unsafe to use for a water-supply a stream once polluted, so long as any tract of pollution remains; to set a distance limit is impossible.”

The same points apply to lakes and ponds as to streams; the larger, however, the body of water the greater the dilution and the less danger, other things being equal. More or less purification goes on in standing water through the action of sunlight and vertical circulation, and the pollution, of course, diminishes as we leave the shore-line, but the point at which it is safe to obtain a supply has to be determined for each and every individual case.

QUALITY AND QUANTITY

Drinking water should be colorless, odorless, soft, and, more important than all these, should be free from animal pollution. In judging the quality of a



FIG. 12.—The Wilderness Brook. (Photograph by the Author.)

water one must bear in mind that “things are not always what they seem.” I have known a well-water that was almost, I suppose, as clear and sparkling as the spring-water of the high Sierras, yet it was grossly polluted and filled with the death-dealing germs of typhoid; indeed, we find that quite often



polluted well-water is peculiarly clear and sparkling.

The hardness of water, that is, the presence of undue amounts of the carbonates, chlorides, sulphates of lime, and magnesia, is undesirable on account of the great waste of soap and the deposit of the salts in boiler-tubes when the water is used in that capacity. In using a hard water, it takes about eight parts of soap to neutralize one part of carbonate of lime; hence the economy in using a soft water. The hardness may be either temporary or permanent. When the lime is present as a bicarbonate, the  $\text{CO}_2$  is set free by boiling, the lime is deposited as a white precipitate and the water is softened; this is temporary hardness. If sulphates and chlorides are present, boiling does not affect it, and the condition is then known as permanent hardness. There are various chemical processes for softening waters on a large scale. The Clark process for temporary hardness consists in the addition of a suitable amount of lime  $\text{Ca}(\text{HO})_2$ , which forms an insoluble precipitate of calcium carbonate, which is removed by subsidence. To remove the hardness caused by sulphates and chlorides, sodium carbonate ( $\text{Na}_2\text{CO}_3$ ) is used, which also throws down insoluble precipitates.

The quantity of water necessary for an individual or a community depends considerably on local conditions, as the size of the city, character of the industries, etc. The amount is very variable as reference to the following table, which I have taken from Turneaure and Russell, will show:

	Gallons per Capita Daily.		
	Minimum.	Maximum.	Average.
Domestic.....	15	40	25
Commercial.....	5	35	20
Public.....	3	10	5
Loss.....	15	30	25
Total.....	38	115	75

The loss of water from a public supply is a growing factor, a grave condition, and one that calls for more attention than it has been receiving.

#### STORAGE AND DISTRIBUTION

The storage and distribution of water present some features for the sanitary student. Surface and very filthy waters improve very much by storage, due to sedimentation, which, by the way, carries down many of the bacteria. Filtered water and deep well-waters deteriorate much by exposure in open reservoirs, due to the growth of algæ and various water bacteria, which, while not dangerous to health, give the water a peculiar and disagreeable odor. The proper storage of such waters demands covered reservoirs, although a method of destroying algæ has lately been discovered.

In the distribution of a water-supply, it is desirable that the pipes have no "dead ends," that is, an end projecting beyond a connection, for this is likely to

cause stagnation of the water; neither should the pipes leak, not only on account of the loss of water, but from the fact, that on the occurrence of a "break-down," causing a diminished pressure in the pipes, there would be an inflow of soil water, which might contaminate the whole system and spread disease far and wide.

#### PURIFICATION

The purification of water, or rather a water-supply, is an absorbing topic at present, for though pure water is better and cheaper than purified water, most of our large cities, indeed even most of the large towns, are unable to obtain a supply of raw water sufficiently pure. Again, municipal filtration has passed the experimental stage and sanitary engineers are able to construct works which will furnish a pure, wholesome, and almost germ-free water; 99.5 per cent of bacteria removed is the record of some filters. Better yet, the efficiency of filtration shows up in the desired reduction of typhoid fever in the districts using the water. At Albany, N. Y., for example, in the ten years' preceding filtration the typhoid death-rate averaged 8.9 per 10,000; in the several years following the introduction of filtered water the typhoid death-rate averaged only 1.8 to 2.0 per 10,000.

It was my good fortune to inspect this plant shortly after its completion and I remarked to the superin-

## 42 Outlines of Practical Sanitation

tendent that I had understood that typhoid had greatly diminished in Albany. "Yes," said he, "we don't have as many cases now as we had deaths before"; and this, while perhaps slightly exaggerated, is about what one can expect with good municipal

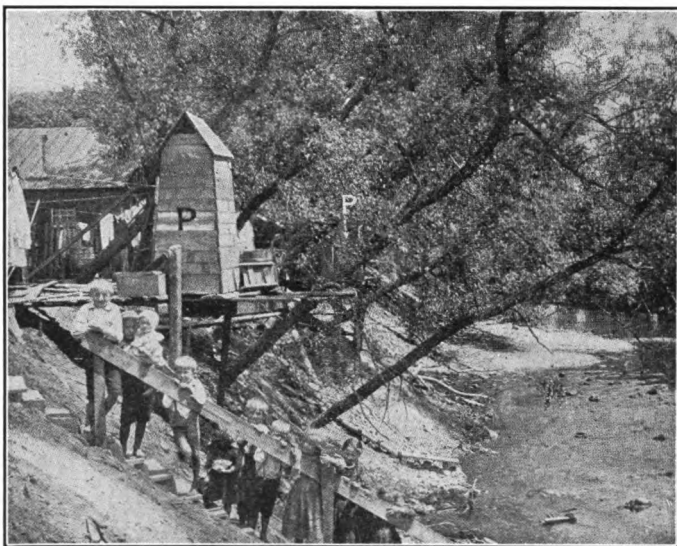

FIG. 13.—How our Streams are Polluted. (Photograph by Penna. State Board of Health.)

filters. If water was the only factor in the transmission of typhoid, and if every one used only the filtered water, much better results could be expected; but some other factors are at work, such as the introduction of extraneous cases from the country, the transmission by means of flies, contaminated milk, and oysters.

There are three principal methods of municipal filtration used at present: Continuous Sand-filtration, the somewhat modified form of Intermittent Sand-filtration, and Rapid Sand-filtration.

**Continuous Sand-filtration** consists in passing the water slowly through large beds of sand, the filtration removing most of the bacteria and suspended matter. The action of these filters depends not only on the straining properties of the layers of sand, but mostly on biological changes in the sand-bed, which coat the surface of the filter with a gelatinous film composed of numerous bacteria, which not only acts as a strainer, but destroys bacteria and organic matter by their growth.

Filtration in slow filters should proceed at about the rate of 3,000,000 gallons per acre per day. The filter-beds, planed to the size needed, are made of concrete; on the bottom are the collecting-pipes to carry off the filtered water; the filter-bed itself consists of four feet of sand, resting on a bed of gravel (Fig. 14). The raw water is first admitted to a

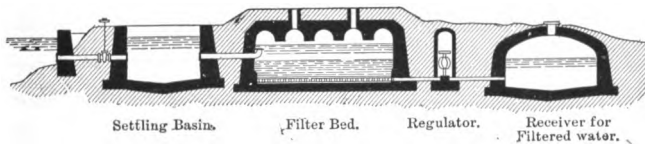

FIG. 14.—Sketch showing the Relation of the Parts of a Filtration System.

settling-basin where a large amount of sediment is removed; it is then slowly turned on to the filter.

## 44      Outlines of Practical Sanitation

After use of several weeks or months, depending on various local conditions, the surface of the filter becomes so clogged that the water fails to pass through; then it becomes necessary to remove the top layer of sand to the depth of about half an inch by scraping; the bed is then refilled with filtered water from below, and is again ready for operation. The sand removed by scraping is piled up, cleaned, and used again.

Filter-beds should be covered, according to Allen Hazen, when the average January temperature falls to 32° F., this includes the country north of a line passing through Philadelphia, Pittsburg, Cincinnati, and St. Louis.

The cost of slow sand-filtration beds is from \$50,000 to \$70,000 per acre for covered beds and a little more than half as much for open beds. The total cost of filtration, including maintenance, interest on the money invested, etc., may be estimated at from \$7.00 to \$9.00 per million gallons filtered. (Turneaure and Russell.)

**Intermittent Filtration** is a modification of the above, the action of the filter being periodically suspended, and permitting the filter-beds to be exposed to the action of the air. Nitrification is greatly increased by this method, which has been wonderfully satisfactory at Lawrence, Mass., where the first plant of this kind was installed. The operation of an intermittent plant entails considerable care and attention, but when a water-supply contains much organic matter it might give better results than

continuous filtration. A plant of this kind costs somewhat less than a continuous-filtration plant.

In the **American** or **Rapid-filtration method**, the water leaving the sediment-basin is treated with a coagulent, generally alumina sulphate, and then passed rapidly through small sand-beds. The alum throws down considerable sediment, forms a gelatinous film over and amid the sand-grains much like that which forms in the slow filter-beds. The filters in this method are built of concrete or steel with a system of pipes in the bottom, over which is placed a layer of gravel and sand. After being used for a day or two the filters become clogged; the flow is then reversed, and air and water blown through until the filters are clean; they are then again put into service.

Rapid sand-filters are able to purify about one hundred million gallons per acre per day and cost only about one-half as much as slow filters. The amount of alum used—one-half to one grain per gallon—is so small that there need be no fear of any deleterious results. At Harrisburg, Pa., where a large rapid sand-filter has just been installed, they tell a story on one of the prominent citizens, who, shortly after the plant had been put in operation, made the remark that the filtered water was splendid, except that there was a slight taste of alum; the man was rather chagrined when the director assured him that the alum had not yet been used.

In regard to the efficiency of the slow or rapid

## 46 Outlines of Practical Sanitation

method, it may be said that both are effective. The slow method has been longer in use and, consequently, we have more extended records, all of which point to the great value of the method in removing bacteria and staying typhoid fever. Rapid filtration is valuable for waters that contain much sediment, and perhaps gives a clearer water than the slow method. Both need very efficient supervision; without this any filter-plant will be useless, yes, even worse than useless. It is well to bear in mind that the cost of pure water is everlasting, unceasing, and unremitting vigilance.

The interruption of a filtration service and the flooding of the pipes with raw water is a very serious thing; if a plant should for any reason break down or the filter-beds be put out of service, the public should be immediately notified and directed to boil all water used for drinking. The neglect of such a precaution cost the town of Butler, Pa., 1348 cases of typhoid fever in four months and 111 deaths.

The purification of water by **domestic filtration**, though many so-called filters are on the market, is wholly unreliable, for the efficiency of a filter can only be determined by a biological analysis from day to day, and this, of course, is not practicable in household filtration. If one must use a suspicious water, the only safe and reliable methods of domestic purification are *boiling* or *distilling*.

The purification of water by copper sulphate has lately come into prominence and has elicited con-



siderable attention. Its legitimate line of action, however, seems limited to the destruction of algæ. A committee of the American Public Health Association last year contended against any use of copper in filtered water, and this same committee refused to recommend its use for the destruction of pathogenic germs in raw water. As an insecticide it has no advantage over kerosene. Its one real value seems to be the destruction of algæ in unfiltered water.

#### THE EXAMINATION OF WATER AND WATER-SUPPLIES

The principal ways of examining water or a water-supply are by means of a sanitary survey and by chemical and bacteriological analysis.

**The Sanitary Survey.**—This consists in obtaining a thorough knowledge of the source whence a water comes, and of the opportunities for pollution to which it may be exposed. (Mason.) The sanitary survey is a very necessary part of a water analysis, for although the chemist may find no pollution, the biologist no germ, there may yet be a source of danger, especially in winter when everything is frozen up. Take as an example the little stream shown in Fig. 12, which looks as though it might have wandered through the “forest primeval”; this stream has yielded pure water to a chemical analysis; a biological examination would likely also give negative results, yet not a mile away over its drainage area there have been real and recent cases of typhoid fever, with, of course, a very possible danger of future pollution.

## 48 Outlines of Practical Sanitation

**Chemical Analysis.**—Chemistry does not presume to indicate the direct presence of germs, or the real cause of disease, but simply to discover the organic compounds in the water; if these come from fecal pollution there is then the possible or probable danger of the water containing disease germs. To make this analysis we examine the water for chlorine, nitrites, and nitrates, albuminoid and free ammonia.

*Chlorine.*—All natural waters contain chlorine as sodium chloride, which is either due to salt-bearing strata or to proximity to the ocean. But chlorine is also constantly present in urine and household waste, so that the presence of more than the normal amount of chlorine is indication of such contamination. The normal amount of chlorine has been found for many localities and maps have been constructed showing the isochlors for such regions; in Fig. 15 is shown the chlorine map for New England and New York. In any given locality a water which shows an excess of the normal chlorine should merit attention, although the chlorine may represent only past pollution.

In the usual method of testing for chlorine we need the following solutions:

(1) Standard Solution of Silver Nitrate: To 1 litre of pure distilled water add 4.79 gm. pure silver nitrate: 1 c.c. = 1 mg. of chlorine.

(2) Potassium chromate in crystals or a 10-per-cent solution.

*Process.*—To 100 c.c. of water to be examined add a few drops of potassium-chromate solution or

FIG. 15.—Normal Chlorine Map of New England and New York. (U. S. Geological Survey.)

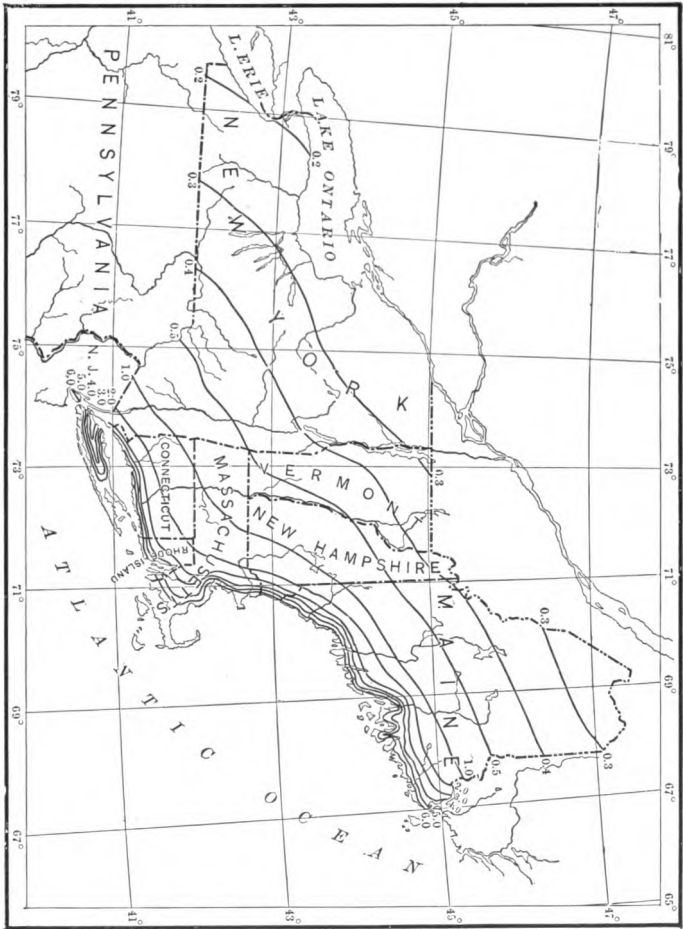

a few crystals of the chromate, and then run in with a graduated pipette the silver solution, drop by

drop, until a permanent orange-red tint is produced and remains on stirring. The potassium chromate is only used as an indicator; after all the chlorine has combined with the silver, chromate of silver is formed, which gives the orange-red color—more readily and distinctly seen than the white precipitate of silver chloride. The number of cubic centimetres of silver solution used indicates the parts of chlorine per 100,000.

*Nitrites*.—Nitrites represent one of the earlier stages of nitrogenous decomposition and therefore its presence in a water means present pollution; sometimes it is formed by reduction of nitrates by the denitrifying bacteria, and in such instances would have little significance; practically, however, the presence of an excess of chlorine and presence of nitrites would indicate a very suspicious water and one that had recently been contaminated with animal waste.

Solutions required:

(1) Solution of sulphanilic acid: Dissolve 0.5 gm. of sulphanilic acid in 150 c.c. of dilute acetic acid.

(2) Solution of naphthylamine acetate: Boil 0.1 gm. of solid naphthylamine in 20 c.c. of distilled water; filter through a plug of washed absorbent cotton and mix the filtrate with 180 c.c. of dilute acetic acid.

*Process*.—To 25 c.c. of the water to be examined add 2 c.c. each of sulphanilic acid and naphthylamine-acetate solutions, using a separate pipette for each; if any color arises in three or four minutes nitrites

are present. A quantitative test is hardly necessary, as the mere presence of nitrites indicates nitrogenous decomposition as mentioned above; in some instances a water shows the presence of nitrites and entire absence of chlorine; this, of course, would be interpreted to mean that the organic matter was of vegetable origin.

The tests for chlorine and nitrites are so easily and readily performed that they are available for the speedy examination of suspicious waters, and although a positive test might not be sufficient to absolutely condemn a water, without more complete analysis, the negative test, that is, water free from nitrites and containing only the normal chlorine of the locality, could be likely passed as safe, for the time being at least, until a more extended examination had been made. In Fig. 16 is shown a small stand which I have constructed for conducting these examinations. On one side are the materials for a chlorine test and on the other the materials for a nitrite test; the stand is painted with white enamel and thus very readily enables one to note the color-changes. With an arrangement like this a series of examinations can be made with great rapidity.

*Albuminoid and Free Ammonia.*—These represent nitrogen in the earlier transition stages and, as they always accompany fecal matter, their prevalence is of much sanitary importance; free ammonia, however, occurs under normal conditions, in certain peat-waters and in rain-water at times. A water

## 52 Outlines of Practical Sanitation

which yields no albuminoid ammonia is organically pure, even if it contains free ammonia and chlorine; if the albuminoid ammonia reaches 0.15 mg. per litre the water should be condemned.

*Nitrates* represent the final stage into which nitrogen is changed; as it is very stable, it remains in the

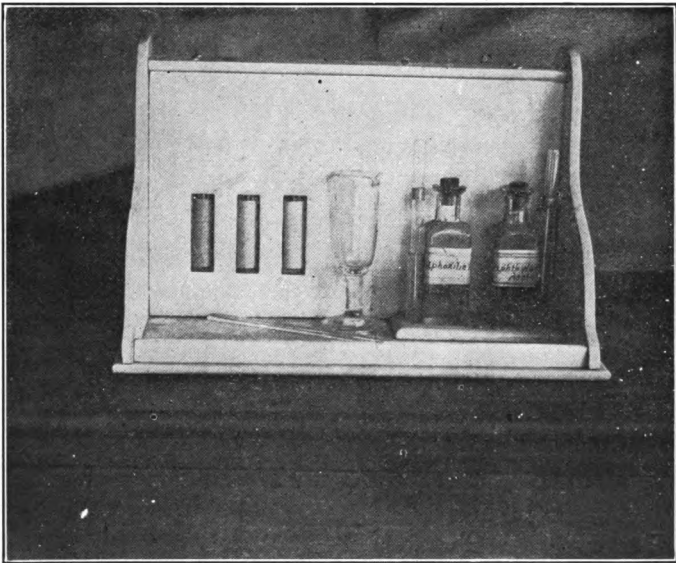

FIG. 16.—Apparatus for Water Analysis. (Photograph by the Author.)

soil for a long time and may represent only past pollution. For methods of testing water for albuminoid and free ammonia, nitrates, and hardness, the reader is referred to the larger works on sanitary science or chemistry; a complete chemical analysis is a rather complex affair, and it was hardly thought necessary

to introduce it in a work like this, for it can only be undertaken by a competent chemist. It is well to remember that at the best a chemical analysis can only prove the presence of organic matter, which may or may not be a source of disease-producing pollution.

**The Bacteriological Examination** of water is mostly centred in the examination for *Bacillus coli*, because this bacillus has been considered an index of pollution; it occurs as a short rod with rounded ends, in many respects similar to the typhoid bacillus, is a normal inhabitant of the intestine of man and most animals, and lives for several months in ordinary well-water. Although its presence in a water may only denote pollution from the discharges of some passing animal, its persistent presence in large numbers indicate sewage contamination; for some time it was thought the presence of *B. coli* in water might possibly be attributed to fish, but Mr. George Johnson, who has studied this subject, has conclusively shown that fish could only transmit this bacillus when first taken up from polluted water, i.e., that *B. coli* was not a natural inhabitant of the fishes' intestine. It is now generally conceded that the detection of *B. coli* in a large proportion of small samples—1 c.c. or less—of a water-supply is an imperative indication of comparatively recent sewage pollution.

## ICE-SUPPLIES

The sanitary importance of ice-supplies arises from the fact that it has been proved experimentally that *B. typhosus* can live with vitality unimpaired for at least three months in a cake of ice, and we know

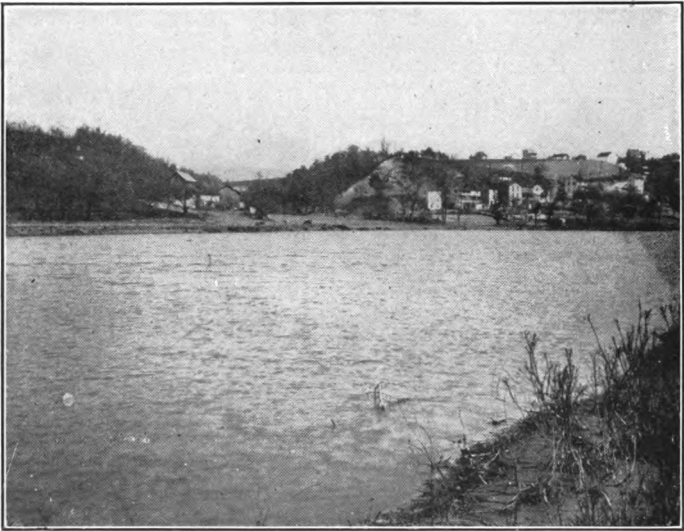

FIG. 17.—A Pond bordered by Houses often furnishes the Public Ice-supply. (Photograph by the Author.)

that ice-supplies are often taken from polluted streams and ponds much like that shown in the photograph (Fig. 17).

Practically, however, freezing is a great water purifier, for almost all the bacteria are removed by this means. On the other hand, when polluted



water is allowed to flow over the top of ice and then again frozen, the danger would, of course, be increased. Another item to consider is that almost all the natural ice used is over three months old, and after that time the vitality of the typhoid bacillus is so much impaired that it is likely of little danger. There have been recorded only one or two cases of typhoid fever which were directly traced to ice, yet the possibility is so likely that the public should demand ice from a source of known purity, or, better, artificial ice frozen from filtered or distilled water. In this connection it is also worth remembering that the fearful epidemic of typhoid fever at Plymouth, Pa., was caused by typhoid dejecta thrown out into the snow bordering a mountain stream, which furnished water to a town miles away.

## CHAPTER III

### The Collection and Disposal of Waste



IF there is any one point in which the highly organized civilization of the present is especially defective it is in the matter of waste collection and disposal; in fact, there are nowhere any scientific methods used except in the larger cities. To most people and to most cities "out of sight, out of mind" is the only available method with which they are acquainted; consequently, contaminated soil and polluted water is of very common occurrence.

#### LIQUID WASTE OR SEWAGE—SEWERAGE SYSTEMS

The most dangerous waste is that composed of the discharges from the human body, and modern sanitation demands that this be removed and rendered harmless as speedily as possible, for it always bears with it the possibility of producing disease. In cities and large houses this removal is best effected by water carriage through a series of pipes known as sewers;

## The Collection and Disposal of Waste 57

and the waste known as sewage is composed not only of excreta and urine but of all liquid from the houses, factories, stables, etc.

The consideration of a sewage system belongs rather to the domain of the engineer than the sanitarian, although there are several points which are of sanitary importance; namely, that the flow of sewage should be unobstructed, that the sewers be water-tight and that they have sufficient ventilation. The system should be periodically flushed, preferably through the inlets for street water located at the street corners.

There are two general sewerage systems: the separate and the combined. In the *separate system* only the sewage proper from the dwellings is received into the sewers, the rain- and surface-waters being taken off by a different set of pipes; this system requires only small sewers, as the volume of sewage is comparatively scant and constant; with this system, too, the ultimate disposal is greatly facilitated. On the other hand, it is more expensive, as it necessitates two systems of conduits. The *combined method* requires one system of large conduits; it is cheaper and when the sewage is discharged into the sea, as at New York, it is certainly an ideal method from the point of the economist or the sanitarian.

## THE ULTIMATE DISPOSAL OF SEWAGE

The ultimate disposal of sewage is one of the great problems of sanitation, for, as mentioned before, sewage is a constant menace to health until it is properly destroyed or broken up into its component parts. It is a problem, the solution of which is in a rather unsatisfactory state at present, especially in this country, and as yet sanitarians have fixed on no one method as perfect for all places; it is probable that different solutions of the question must be devised to meet the conditions of different localities.

**Dilution.**—The method of dilution, that is, disposal into the sea, or a large tidal river, is, of course, allowable. This method, which is the cheapest, simplest, and most primitive, reaches its ideal at Manhattan Island, both sides of which are flushed twice daily by strong and swiftly flowing tides. This same plan used in streams above tide level, like the upper Hudson, the Delaware, and the Susquehanna is to be deplored, for if the growth of population continues at the same rate that it has been doing in recent years, there will surely come a time when these streams will become only great open sewers, inimical to the life of fish and destructive to all the smaller animal and vegetable life on their banks.

**Sewage Farming or Broad Irrigation.**—This is a method which consists in flowing the sewage over

## The Collection and Disposal of Waste 59

cultivated land. The idea being that growing plants will break up and utilize the sewage. This is really done to a limited extent, but plant life is not well adapted for assimilating the organic matter of the sewage until it is first decomposed by bacteria. However, under certain conditions, and for small communities, this method seems to do very well.

The following is a plain description of a plant of this kind which was erected for an institution consisting of 1200 population and making about 75,000 gallons of sewage daily: "A piece of sandy land, four acres in extent, was selected for the purpose. This was graded perfectly flat and laid out in alternate beds and trenches; the beds being ten feet and the trenches eight feet wide. The whole plot was underdrained, but this was later found unnecessary. The sewage from all parts of the institution is run to an underground tank 80 feet long, 40 feet wide, and 15 feet deep. From this tank it is thrown once a day by a centrifugal pump through a six-inch duct into a small well at the northeast angle of the sewage field. This well, after being filled, overflows into a long trough made of two-inch planks spiked together. Opposite each trench there is a short spout made with a similar two-inch planking. Each spout is fitted with a sliding gate, and just beyond each spout the trough is fitted with a similar gate. By means of these gates the sewage is turned into any trench desired. The whole arrangement is exceedingly simple, cheap, and efficient.

“The centrifugal steam-pump churns up the sewage, so that when it comes to the field it resembles dish-water in appearance, and is so diluted that there is very little odor; within one-half to six hours (according to season and dryness), after the sewage is turned into the trenches, it has been absorbed by the soil. It is never seen again by us; doubtless it reappears at the surface somewhere as pure spring-water. Only two or four trenches are used each day, so that the soil as used is always ready to absorb the sewage. There is no pollution of the soil; it is as sweet to-day as before it was used at all for the purpose in question. Neither, when the ground is soaked with rain, nor frozen hard, is there any trouble. The sewage always disappears in the soil, the process only somewhat checked by previous soaking, and only slightly checked by frost; for the sewage is always many degrees above the freezing-point, and it thaws the soil sufficiently to make way for itself. For six years now we have cultivated this field to its full capacity, with the result that we grow upon it year by year crops of fruits and vegetables to the value of over \$200 per acre.”—  
R. M. Bucke.

From the above it is evident that when much suitable land is available at a very low price this is a method to be thought of, but generally only for small communities, since it requires about one acre to dispose the sewage of 200 people. The sewage farms at Paris, although promising well at first, are not turning out to be the success expected.

## The Collection and Disposal of Waste 61

**Chemical Precipitation.**—This plan is not much in vogue at present—a plan, too, which is not founded on any scientific principle, for the precipitate is only concentrated filth, which is hard to dispose of. Precipitation could hardly be recommended as a means of disposal.

**Intermittent Filtration.**—Intermittent filtration is one of the promising methods at present: it depends for its value upon the fact that sewage contains two great groups of bacteria which are necessary for its destruction—the anaerobic, which, growing in the absence of air, break up and liquefy the organic matter, and the aerobic, which, only growing in the presence of air, split up the nitrogenous compounds into harmless elements. In order to bring the sewage into proper condition, so that these different classes of bacteria can do the work allotted them, we pass the sewage, with intermissions, through beds of sand. While the liquid sewage covers the sand-bed, air is cut off and the anaerobic bacteria attack the organic matter: as the sewage is drawn off air enters the filter from above, and the aerobes do their portion of the work.

In Fig. 18 is shown the plan of a plant of this kind. The sewage is first run through a screen to remove extraneous substances, and is then discharged automatically by a siphon into the various beds. The sewage is applied to each bed only about six hours out of the twenty-four, thus giving a period of rest. By means of intermittent filters of this kind 60,000

## 62 Outlines of Practical Sanitation

gallons of sewage per acre per day may be purified.

At Reading, Pa., a sewage-disposal plant has been erected, consisting of coke strainers and aerated filtration-beds, which is a modification of the above principles, the sewage being first passed through coke strainers where something like forty per cent of the nitrogenous matter is removed, and the resultant liquid is then passed through sand-filters or aerator-beds. The crude

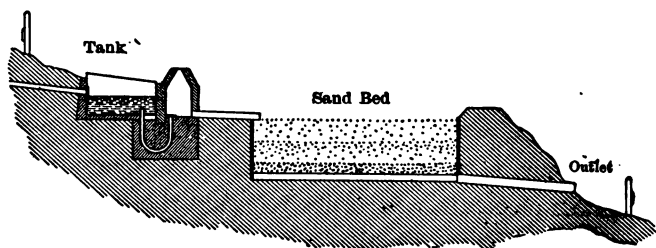

FIG. 18.—Section of Tank, Siphon, and One Bed of an Intermittent Sewage-filtration Plant.

sewage, after reaching the tanks at the end of the main sewer, is run over two suspended layers of coke twelve inches thick; every week the sewage is shunted from one receiving-tank to another, and the clogged coke is taken out and burned. The strained sewage then passes to the filter-beds, which, in this case, comprise about half an acre. One-half of this (Fig. 19) is supported by an iron structure, and is about eight feet above the lower bed; the upper one consists of three layers of broken stone and fine sand two feet thick.



## The Collection and Disposal of Waste 63

When the upper filter is flooded with sewage, air is shut off from the upper part of the filter and anaerobic action is exerted; during the drop of the liquid to the second filter and while passing through the second one, which is of much coarser material, there is ample

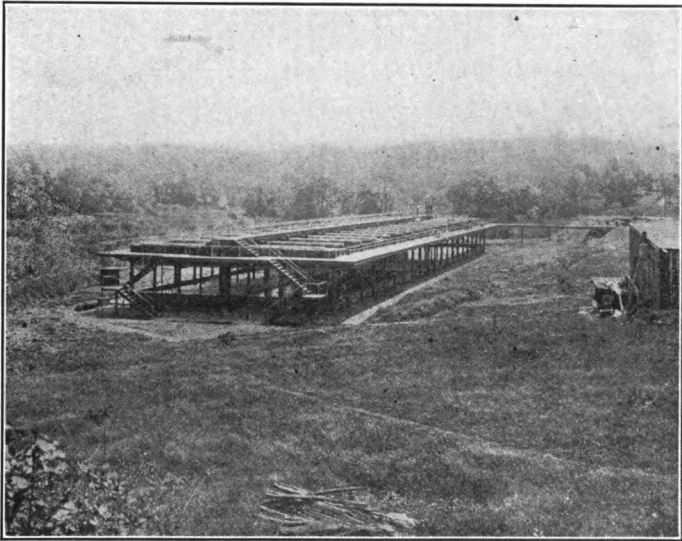

FIG. 19.—Sewage-filtration Plant, Reading.

aeration for the action of the aerobic bacteria: the effluent finally emerges purer, it is said, than the stream into which it flows. One-half of the filter only is generally in operation at a time, the other half being rested and cleaned.

This plant has treated sewage at the rate of 11,000,000 gallons per acre and cost about \$160,000. Although

## 64      Outlines of Practical Sanitation

it gave much promise at first, the cost has been considerable, and it is questionable if this method would be entirely satisfactory for very large cities.

**The Septic Tank and Contact-filters.**—By this plan the anaerobic bacteria are brought to act separately in a tank; after which the liquid sewage is filtered through sand-filters or contact-beds composed of coke, crushed stone, or the like, for action with the aerobic bacteria; by this plan a still much larger amount of sewage may be treated, even five or ten times more, than when disposed of by intermittent filtration-beds.

The septic tank, as it is called, need not of necessity be covered, for it is found that, if sewage is admitted at the bottom, the anaerobic action goes on uninterruptedly, sufficiently protected by the thick scum over the surface from the light and air, the presence of which would interfere with the action of the anaerobic bacteria. The septic tank is simply a “workhouse for the anaerobes,” as one writer has put it, and its great value depends on the fact that it removes just about one-half of the putrescible substances in the sewage, thereby reducing the area of filter-beds required for further purification. The sewage after “working” for from six to twelve hours in the tank is then turned on the beds, which are composed of any material allowing more or less rapid filtration, the same bed being used only once in the twenty-four hours. The contact-bed is the “workshop of the aerobes.”

## The Collection and Disposal of Waste 65

To sum up the question of sewage disposal we may say that intermittent filtration through beds of sand is probably the best method yet devised, when one can obtain sand cheaply; in other places the septic tank with contact-filters of sand, coke, or cinders—which is only a modification of intermittent filtration—may be more available. Broad irrigation, as mentioned before, can only be used for small communities and where land is very cheap.

### SOLID WASTE AND ITS COLLECTION

After a city or community has disposed of its sewage there yet remains a great deal of solid waste, such as garbage, rubbish, ashes, etc., which should rightly be taken care of by the municipality; however, in some pretty large cities this is left to the individual householder, but individual action, when it comes to the removal of waste, is very defective. Although all this kind of waste is not directly dangerous to health, it does create a nuisance which tends indirectly to affect the public health, unless removal and disposal are effected in a sanitary way; for this reason the problem belongs to the domain of the sanitarian.

The first requisite in the disposal of a city's waste is effectual collection and separation of the waste into its component parts, as was inaugurated by Col. Waring in New York City; of course if the refuse is all destroyed by fire, as in some of the English cities, separation is unimportant; otherwise this

## 66      Outlines of Practical Sanitation

should be carefully attended to and collected as garbage—that is, household waste from the kitchen—ashes, street-sweepings, and rubbish, the last comprising everything not included in the other classes.

The collection of waste has some objectionable features which are readily remedied; for example, in the collection of ashes, which is nearly always associated with a whirlwind of dust, there should be more care exercised; ashes should always be kept in covered cans, emptied carefully, and removed in covered wagons. Garbage presents a decidedly annoying character unless it is kept in water-tight cans and removed daily in covered metal carts. Street-sweepings should be kept in cans or bags as described in the chapter on Municipal Hygiene, and removed in covered carts the same as the ashes. The collection of rubbish may be made at the intervals judged necessary, but should be done likewise with covered wagons. The ultimate disposal of refuse material is best considered by taking up each subject separately.

### DISPOSAL OF GARBAGE

The subject of garbage disposal is in a more unsatisfactory state than is sewage disposal; some of the methods in use, though economical, create a nuisance; some others although sanitary are expensive, and so it stands. The various methods worth considering are as follows:

## The Collection and Disposal of Waste 67

**Feeding to Swine.**—This, although not a very scientific procedure, is the method adopted in a good many small cities, and if care is used there is probably no sanitary objection; it is important that it be collected promptly and used before putrefaction begins.

**Dumping as Filling.**—The public “dump” is one of the objectionable features of so many American cities. Although it may not have very much relation to ill-health, it is certainly a nuisance unless great care is taken; then, again, dumping can hardly be considered a final solution of the problem, for there will always come a time to every city when there will be no land available for a “dump.”

“Sea-dumping,” which is in vogue in some of the coast cities, is very objectionable; several years ago when this was practiced at New York the shores of Long Island and New Jersey were strewn with garbage of every description, and the practice called forth much protest from those inhabiting these shores; in fact, dumping garbage into the sea is not at all a method of disposal but rather of transference—of carting the waste from your own door to somebody else’s,—the waves doing the carting cheaply, “without money and without price.”

**Burying.**—Burying into the soil is a thoroughly scientific method for the disposal of garbage, for the organic matter is quickly broken up by nitrification; indeed it is the method recommended for small suburban and village houses and is discussed in this

connection in Chapter XI, but it cannot be recommended for towns or cities of any size on account of the enormous expense entailed.

**Reduction and Utilization.**—This process consists in trying to recover as much as possible of the contained grease and to turn the residue into fertilizer; it consists, in a general way, in cooking the garbage in suitable tanks and then extracting the fat by means of benzine or naphtha.

The Arnold process, used in New York and Boston, is the simplest, most successful, and least costly. The description of this process as described by Rudolph Hering, to whom I am much indebted, is as follows: "The garbage, after picking out metals, glass, and other undesirable stuff, is dumped into digestors, holding each about eight tons. In them the garbage is cooked several hours under pressure with live steam. It is then allowed to fall through a valve at the bottom into a continually rolling press which separates the fluid from the tankage. The fluid consists of grease and water, which are subsequently separated by gravity, the water flowing off into a sewer, and the grease into a tank, to be barreled and sold. The remaining solid matter, or tankage, is dried, and then either ground and sold as a filler for fertilizer, burned, or wasted." Great care must be used in all reduction plants or they are likely to become a nuisance. About twenty of our largest cities are using more or less successfully some form of the reduction process, which can only be considered available when a large amount

## The Collection and Disposal of Waste 69

of garbage is to be treated; in Europe, where the people are not so wasteful, the garbage contains so little grease that reduction would not be thought of.

**Cremation.**—This is the method used so successfully in Europe and with considerable success in some of our own cities. A good many of the American failures being probably due to the fact that we have been trying to burn the garbage alone without other refuse, thereby increasing the cost; and also by our lack of expert supervision. There are a number of different types of furnaces, one of which, the Thackeray Incinerator, has given fair satisfaction. This furnace consists simply of a number of small furnaces built along a horizontal shaft, which is only a prolongation of the chimney; these furnaces are fed by a hopper above, into which the garbage is dumped. A diagrammatic section of one of these furnaces is shown in Fig. 20.

The Engle Cremator is another available type of furnace that has been more or less successful. It has two fires: the first attacks the garbage directly; the smoke and gases pass through the second and are destroyed. This furnace has been very efficient in many places, but the expense of operating has been considerable.

While garbage cremation has been a success in Europe, the results in this country have not been what we have had the right to expect. One reason for this, it is claimed, as mentioned above, is that we try to burn only the garbage, and throw away the ashes, which in some cities contain 20 per cent of coal—an

## 70 Ourlines of Practical Sanitation

amount of combustible material which should certainly be utilized. The design of the furnace is another factor. The English furnaces always have sloping grates, which admit of more automatic combustion than is possible with the horizontal grate characterizing the American models. Then, again, skilled

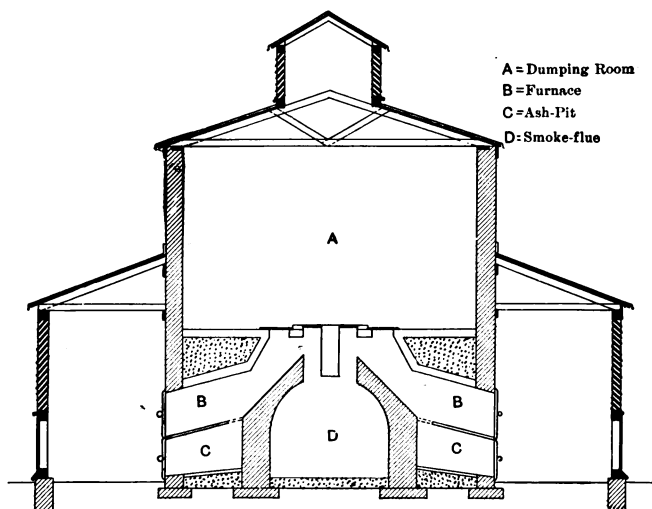

FIG. 20.—Section of Thackery Garbage-furnace.

supervision and the expert garbage fireman, factors of the first importance, are generally unknown quantities in this country.

The respective cost of reduction and cremation is interesting. In reduction works the cost to the city per ton has been from eighty cents to one dollar and seventy-one cents, but in the largest cities the amount of fats and oils has paid for the cost of extraction.



## The Collection and Disposal of Waste 71

Cremation costs from less than fifty cents to seventy-five cents per ton, the greatest success economically being when ashes, garbage, and rubbish are burned together, as at Montreal and San Francisco, where the cost has been respectively thirty-seven cents and seventy-five cents. Unless there is combined combustion of all the waste, there yet remain ashes, street-sweepings, and rubbish to dispose of.

### DISPOSAL OF ASHES AND STREET-SWEEPINGS

The usual disposal of ashes is for filling in low lands, for road-making, and as a substitute for sand in making mortar. Ashes are also used for making foundations under pavements, than which there is nothing better.

The proper method for disposing street-sweepings is by cremation, on account of the fact that this dust very often contains many pathogenic germs. Other means of disposal, practiced in many places, but not to be recommended, are its use as fertilizer on adjoining fields and dumping in low places for filling.

### DISPOSAL OF RUBBISH

The rubbish of a large city generally contains much valuable waste which can be utilized in various ways, and consequently all rubbish should be "picked over," and the salable products removed as a source of revenue. In New York the following articles are collected and sold: paper, rags,

## 72      Outlines of Practical Sanitation

carpet, bagging, twine, shoes, hats, bottles, tin cans, copper, brass, zinc, iron, rubber, hair cloth, and curled hair; the remainder of the rubbish, which contains about 80 per cent of combustible material, is best destroyed by fire. The cost of cremating rubbish alone in New York has been about one dollar per ton, while in San Francisco, where they cremate all the waste together, the cost has been less than fifty cents per ton.

### QUESTION AS TO BEST METHOD OF DISPOSAL OF SOLID WASTE

When the question arises as to what is the best method of disposal of solid waste each community will have to be studied separately; the solution depending on individual conditions, location, and circumstances. The methods available for garbage disposal will likely be restricted to reduction and cremation; suffice it to state that there is little hope of the reduction methods offering much of a solution, except in a few of the largest cities; and even there, as the years go by and we become more crowded, consequently more economical, the fat in the garbage will hardly pay the cost of extraction, and reduction will become a method unthought of, as is the case in Europe. If cremation is the method selected, it will have to be decided for this individual city whether it is better to burn everything or only the garbage and sweepings. In certain places near the great centers of trade the large revenue to be

## The Collection and Disposal of Waste 73

derived from the salable rubbish is a factor to be considered. In every community where the ashes contain much unconsumed coal the question will arise as to the value of utilizing this part for fuel; in other places where little coal is wasted it may be better to use the ashes for other purposes. To sum up, a plan of disposal which can be conducted without creating a nuisance, meeting all sanitary requirements and performing its work as cheaply as possible, is the goal to be sought.

## CHAPTER IV

### Milk-supply



every one belongs the right to obtain pure and wholesome milk; and although the complaint of the individual may be met with the rebuff, "If you don't like my milk, you needn't buy it," united effort, however, can do much to bring about a reform, which is badly needed. I doubt if many of us would continue to use milk if we could see the whole procedure of furnishing it from beginning to end.

Not only are the special poisons of typhoid fever, diphtheria, and scarlet fever thus carried, but it is pretty well settled that bovine tuberculosis may be transmitted in this way to human beings, especially to children; and its use under improper sanitary conditions is also responsible for the terrible infant mortality occurring in our great cities every summer. Talk of war! War is nothing, when it comes to increasing the death-rate, compared to filthy milk. A gallon of milk properly doctored with filth and improperly chilled, carted around by a filthy milk-dealer in filthy bottles, and properly distributed to an East Side

tenement, can do more real harm than a Gatling gun let loose on a Broadway crowd. Yet only a few of the larger cities exercise any control in the matter; to be sure, in many places pure-food laws are active in preventing adulteration, but that is comparatively trifling in a sanitary way.

A municipality has just as much right to exercise absolute control over its milk-supply as over its water-supply, and it is a question that will have to be taken up before long by all up-to-date cities. To produce pure milk it is necessary to use scrupulous care about the cows, the stable, the milker and his utensils, and lastly the milk itself.

#### THE COWS

In the first place, to run a dairy it is necessary to have cows; this may sound like redundancy, but the fact is that a good many dairymen do buy much of their milk, and although their own supply may be of the right sort, the bought milk may not be. A case illustrating this came to my notice lately. A certain Pennsylvania dairyman who keeps an establishment advertised as a model, with pictures of his workmen in white duck, etc., was found to be selling adulterated milk. Criminal proceedings were instituted by the State and the dairyman promptly paid his fine, alleging that the milk had been procured from a neighbor: if water could get into his neighbor's milk, it might be pol-

luted water or perhaps something worse. Consequently if a dairyman pretends to sell sanitary milk, it is absolutely necessary for him to produce the milk under his own supervision.

The cows must be healthy and show no evidence of tuberculosis. Those which do show decided evidence of pulmonary tuberculosis and those which show any evidence of tubercular lesion of the udders should be excluded. The animals must be kept thoroughly clean—groomed as carefully as a horse—and the udders washed and wiped dry with clean towels before milking.

#### THE STABLE

The stable should be made of concrete if possible; at least the floor should be of this material; the ceiling must be dust-proof, especially if the space above is occupied. There should be plenty of sunlight and ample air-space for each animal—something like 900 or 1000 cubic feet is probably sufficient; in a good many so-called model stables only 600 or 700 cubic feet are allowed, which is far too little, considering the great predisposition of cattle to tuberculosis. The best way to ventilate a cow-stable is by what is known as the King system, which consists in taking the air from openings on the outside near the ground. It enters the room near the ceiling and passes out near the floor, being taken up and carried away through ducts which con-

nect with ventilators in the cupolas. The windows are securely fastened, being used to let light in and keep dust out.

The stable should be kept thoroughly clean by removal of the manure at least twice daily, and the use of some absorbent to prevent odor; the floor, walls, and ceiling should be frequently washed down with a hose, and once a month the stalls should be cleaned

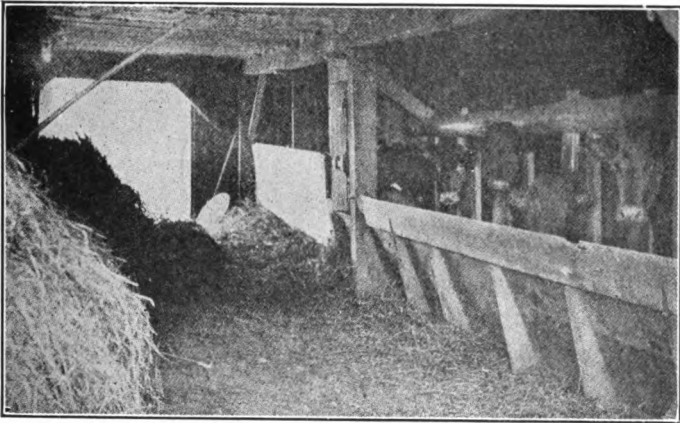

FIG. 21.—The Old-style Cow-stable. Damp, dark, and full of dirt.  
(From photograph by L. H. Baily in "Country Life.")

with some antiseptic solution. Sunlight, fresh air, and cleanliness are the sanitary factors needed for the cow-stable.

On a good many of the older farms, where bank-barns are the fashion, the basement is used for the cow-stable. These barn basements, even in summer, with all the windows and doors open, are damp, dark, and sunless; when cold weather comes, the windows

## 78      Outlines of Practical Sanitation

are closed with straw, or even boards, and sunlight and oxygen become rare articles during the long and dreary winter (Fig. 21).

Only a short time ago I visited one of these basement stables where five cows were kept; the ventilation in this instance was not so bad, but there was no

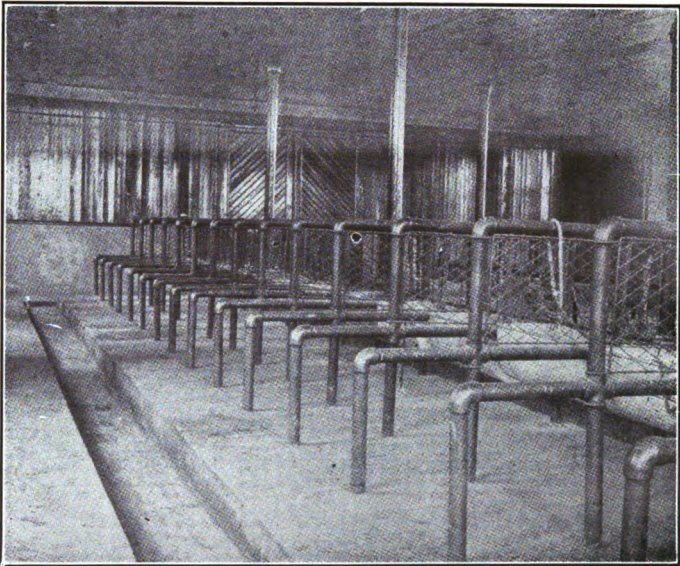

FIG. 22.—A Modern Cow-stable. (From Report, U. S. Dept. of Agriculture.)

attempt at cleanliness. There was plenty of fresh straw lying around, but I was suspicious of what it covered. On questioning the proprietor, who is a fair example of the successful farmer, I learned that the stable was “cleaned” twice a week, but that fresh straw was thrown over the filth every evening; so it



was nice and dry on top, but wet and polluted underneath. Yet this is the kind of a stable—this Augean-like stable—from which most of us, whether we live in town or country, get our milk-supply.

In Fig. 22 is shown the picture of a model cow-stable, which gives some idea of the lines upon which such a stable should be built. Although iron stalls and concrete floors are all very fine, ordinary pine stalls, which may be whitewashed every month or two, may be made to answer very well, even with only the hard clay floor of the ordinary barn; the cardinal point is cleanliness.

#### THE MILKER AND MILKING UTENSILS

The milkers should pay much attention to personal cleanliness. In some dairies the milkers are clad in duck suits which are worn only once before being laundered; this, of course, approaches the ideal, but much can be done by simple cleanliness, even in the absence of white duck; the milker's hands should, above everything else, be clean, almost surgically clean. The homes and families of the milkers or other workmen about the dairy should be inspected from time to time, excluding every one, of course, in whose family infectious disease exists.

The utensils should be thoroughly cleansed with hot water and soda, and then sterilized by boiling water or steam. The custom of rinsing the cans at the farm pump has cost us more than one epidemic of typhoid fever (Fig. 23).

## THE MILK

Having performed all the details mentioned above we may still furnish an impure milk due to carelessness in the treatment of the milk itself; this should be strained through new cheese-cloth, which can be discarded after once using. The next step—and a very important step it is—is chilling, the whole future of the milk depending on this process. The usual method on the ordinary dairy-farm is to place the milk in the spring which adorns almost every farm; but unfortunately most springs do not have a temperature below 55 deg. F., while to chill milk properly requires a temperature at least as low as 45 deg. F., which cannot be obtained usually without ice. The aeration of milk, of which we hear so much—quite often painted on the milk-wagon—is held to be unnecessary. In addition to cleanliness, chilling is the one principal thing in the treatment of the milk itself.

The bacteriological content of properly chilled milk is vastly different from that of ordinary milk; the rapid bacteriological growth of insufficiently chilled milk on a hot summer's day causes what is commonly known as "turning."

## TRANSPORTATION AND DISTRIBUTION

During transportation milk should be kept between 40° and 45° F., preferably in bottles which are sealed at the dairy. When milk is carted around from house

to house another factor enters in, namely, the cleanliness of the milkman and his wagon; for example, I have seen a milkman, when he served a measured quantity



FIG. 23.—Why Milk sometimes transmits Typhoid Fever.  
(From "Country Life in America.")

of milk, invariably keep his thumb over the edge of the measure, so that every quart of milk he sold included a number of bacteria from his thumb, which was never very clean.

## 82      Outlines of Practical Sanitation

### BACTERIOLOGICAL EXAMINATION

In the management of a scientific dairy there should be provision made for a bacteriological examination of the milk from time to time, for by this means we have a ready check on the efficiency of the methods carried out. Milk prepared according to the directions given above—from good cows, in a clean stable, by clean milkmen and utensils, and properly chilled—yields comparatively few bacterial colonies to the cubic centimeter examined; in some cases milk has been so carefully prepared that it was absolutely free of bacterial growth. This, of course, was in rare instances; more often it yields several thousand; and 30,000 per cubic centimeter has been adopted as a sort of standard for pure milk. In contrast to this it has been found that when cows are milked in ordinary barns in the usual insanitary condition the milk yields something like 100,000 to 200,000 bacteria per cubic centimeter, or even two or three times more. Thus it happens that a bacteriologist can tell by examination whether or not milk had been prepared under sanitary conditions. A bacteriologist is a necessary adjunct to a successful dairy.

New York City has made decided progress—perhaps it was more needed there than any other place—in the pure-milk question; its milk commission has issued rules and regulations for preparing milk, and furnishes certificates to such as comply with its directions. Certificates are issued for two grades

of milk, known as inspected and certified; the latter is produced under all the care suggested by the commission and comes up to the standard of purity required; it sells for about twice as much as ordinary milk.

Another factor enters into the pure-milk question, and that is the education of the people to the point of knowing the value of pure milk and their willingness to pay the increased price necessary in the production. Much has been done lately in this direction, and the sentiment for pure milk is rapidly spreading, so that the time is likely not far distant when the public will demand such milk just as they now demand pure water.

#### THE ADULTERATION OF MILK

The adulteration of milk by the addition of water, extraction of cream, the addition of preservatives, as boracic acid or formaldehyde, does not affect the public health at all in proportion to what is done by insanitary milk; the whole question of adulteration is not so much a matter of public hygiene as of public honesty.

Most States have laws requiring that milk should contain 3 per cent of fat, 12 or 12.5 per cent of total solids, with a specific gravity of 10.29. The 3 per cent of fat is certainly too low, for milk has been produced, by proper feeding of the cows, which con-

## 84      Outlines of Practical Sanitation

tains 5 per cent, and it is claimed by some dairymen that even 6 per cent can be reached.

The addition of preservatives should be prohibited by law, for they tend to impair the nutritive value of the milk, and also interfere with its digestive properties; some of the chemicals which are used as preservatives, when taken into the system for a long time, tend to produce renal changes which are likely to lead to serious results.

## CHAPTER V

### Food-supplies



THIS chapter deals with the insanitary and filthy methods used in marketing certain food-supplies. We are not certain but that disease may be transmitted in this way; whether it is or not, lack of cleanliness in food is certainly not conducive to perfect digestion and perfect health.

#### BREAD

The exposure of food to the dust and dirt of city streets—a common condition—is certainly undesirable. Take, for example, bread, which is quite often carted around in a wagon more or less exposed to the dust of the street; street-dust is filled with bacteria innumerable, as has been demonstrated practically over and over again. The purchaser of the bread is handed a loaf by the unwashed and ungloved hand of the driver and dangerous filth can very readily be transmitted in this way.

Bread is also frequently transported into the country

## 86      Outlines of Practical Sanitation

from the great cities by railroad and trolley lines; the loaves are generally placed in open crates, exposed on all sides. Not long since I saw a crate of such bread awaiting shipment on a suburban trolley; this crate stood on the public street of a certain inland city, while passengers waiting for the cars were going to and fro, and the street all around was spotted with expectoration; indeed I saw one man expectorate who barely missed the bread; dust was blowing too—foul city dust—and yet that bread was, by and by, placed on some one's table and eaten. It would be interesting to know just how many bacteria were living on a given inch of the crust of that bread. Bread should invariably be wrapped in paper by some one with clean hands before it leaves the bakery.

### FRUITS AND VEGETABLES

Fruits and vegetables in their season are continually exposed to street-dust in front of groceries or in open markets; not only are they open to dust but also to flies, which are known to carry actual disease-germs on their feet. Professor Ehrlich made some experiments relative to this question and found that a half-pound of huckleberries, as usually handled, yielded 400,000 bacteria; the same amount of peas 800,000; strawberries 2,000,000; raspberries 4,000,000; grapes 8,000,000; cherries 12,000,000. While these numbers probably vary much with local conditions, it shows that





FIG. 24.—The Insanitary Method of exposing Fruits and Vegetables to Street-cust.  
(Photograph by Mr. E. C. Kipel.)



exposed fruits are fairly loaded with bacteria. As these fruits are usually eaten uncooked, it is evident that there is considerable danger. Such fruits, unless they have been properly protected, should be thoroughly washed. The claim is sometimes put forward that they get plenty of dust where they are grown; so they do, but country dust is more or less sterile and is totally different from the dust of a crowded city street.

All fruits and vegetables which are eaten without cooking should not be exposed on the street except under glass-covered, dust-proof boxes. Sometimes these fruits are covered with mosquito-netting, to give the passer-by the idea of protection from flies; this is all a delusion, for the little fruit flies—the very ones which linger around and feed at such a place—can get through the finest mesh of the ordinary screen, so that nothing but complete covering under glass is sufficient protection for fruit. The California fruit which the “push-cart” men sell on the street-corners of our large cities looks tempting, but would any thoughtful person eat of it after such daily dust exposure? Dr. Bell of Brooklyn, late editor of “The Sanitarian,” has called attention to the fact that the intestinal diseases frequently attributed to fresh and presumably wholesome fruit and vegetables may be due to this dust exposure; and it is generally conceded, I believe, that he is right.

## OYSTERS, FISH, AND MEAT

The marketing of oysters calls for radical changes, for oysters are often eaten raw. In the first place more than one epidemic of typhoid fever has been caused by the eating of oysters "fattened" in sewage-polluted waters; and Massachusetts and New Jersey both have laws prohibiting the placing of oysters in waters at all contaminated with sewage.

In the next place, and probably almost as important, is the filthy method used in opening them; the outside of the shell should certainly be cleaned before opening, for although the mud and dirt clinging to a shell may not contain many germs, we do not care to have it served on the table. More important still is it that the hands of the opener be clean: nobody wishes to have the liquor from the opened oyster drip over the dirty hands of the opener; and this is more than mere fancy, for filthy hands are likely to carry myriads of disease-germs. I had once been buying oysters of a certain dealer whom I missed on my next visit; on inquiry I found he had typhoid fever, yet he had been opening oysters on the very day he took to his bed. A serious risk it was for the one who ate those oysters!

If the man who opened oysters wore rubber gloves and had a clean white apron, I believe the oysters would taste better; they would certainly be cleaner, and I believe a fortune awaits the man who can

open oysters and still look clean and be clean. Oysters should always be opened only immediately before use, for stale oysters are liable to cause ptomaine



FIG. 25.—The "Push-cart" and its Germ-laden Fruit. (Photograph by A. R. Dugmore in "Country Life.")

poisoning with quite serious results. In a good many cities the public are beginning to insist on having the oysters opened "while you wait"—and that is the only proper way to buy this article of food.

And now a word about fish and meat. Although the marketing of these foods is not performed in the best sanitary manner, it probably carries with it little danger to health, on account of the thorough cooking they undergo before eating. We all admire fish in the water, but somehow the fish at the market does not seem the same you saw in the water. White porcelain-lined trays with water connection, so that they may be flushed frequently—with the addition of ice in hot weather,—would add greatly in solving the fish-market question. For meat we should have white-enameled racks, porcelain trays, glass cases, and bright tools: perhaps not strictly necessary, they would at least seem clean and make the place more attractive to the consumer. Attention must be called to the custom of storing on ice undrawn poultry, fish, and game; that is, such as contain entrails and other viscera. The retention of these organs favors putrefaction and infection of the surrounding flesh. Cold-storage foods should, on the whole, be used with caution, for freezing only limits putrefaction and does not stop it, and when such food is removed to a higher temperature decomposition and the production of poisonous ptomaines go on with increased vigor.

#### THE ADULTERATION OF FOODS

The adulteration of foods, like that of milk, is scarcely to be credited to the side of the sanitarian but rather to the economist, for much of the adul-

teration is harmless; it is simply a matter of not getting what you pay for. One of the most flagrant adulterations is that of selling oleomargarine, artificially colored, for butter. Oleomargarine is composed of butter mixed with a certain amount of animal fats, and is probably as nutritious as butter, and probably almost as easily digested. Oleomargarine should simply be sold as such, and of course should not be artificially colored. Lard and olive-oil are frequently adulterated with cottonseed-oil, and olive-oil is quite often composed almost entirely of peanut-oil. It is said that cottonseed oil has been shipped to Europe in bulk and then returned to us labeled as pure olive-oil. Coffee, that is the low-priced ground coffee, is often adulterated with ground chickory, peas, beans, and various grains, and even sawdust. Coffee-seeds have also been so successfully imitated as to be difficult of detection by the eye. Tea is often adulterated by the use of exhausted leaves, the introduction of foreign leaves, or the addition of coloring material. Cocoa and chocolate often suffer the extraction of fat and the addition of starch. Jellies and preserves are very often only refuse materials made up with glucose, flavored with essential oils, colored and preserved with salicylic acid.

The addition of copper salts for greening vegetables, especially the French products, is probably not as deleterious as generally supposed, because of the small amount used; it has been found "that although

the last forty years, hundreds of millions of cans of such vegetables have been eaten, there never has been a single well-authenticated instance of poisoning that could be definitely traced to the copper." Alum in bread is a question often considered; it is added to bad flour in order to restrain the conversion of the starch into sugar, which occurs in flour that is old and damp. Although there has been a widespread opinion that alum used in this way is harmful, the injurious effects are likely much overestimated and are probably limited to slight disorders of digestion. The use of salicylic acid—a common occurrence—as a preservative is to be condemned, for in the quantity used it is a powerful arrestor of digestion, and also a decided gastric irritant. Worse than all or any of the adulterants yet mentioned is that of the addition of sodium sulphite for the preservation of Hamburg steak, bologna, canned asparagus, etc., for this drug, above any other used in either milk or foods, is believed to cause serious degeneration of the kidneys when taken in small and repeated doses.

That much still remains to be done by laws, properly enforced, in the line of pure-food products, it is only necessary to refer to the report of the Dairy and Food Commissioner of Pennsylvania. During the year 1904 the Commissioner, Dr. Warren, collected over \$53,000 in fines from those who were violating the law by selling adulterated food and milk: the millennium is not yet very near in the Keystone State,



## CHAPTER VI

### School Sanitation



It is well for every one who is interested in the welfare of his country to remember that the health of the school children is of paramount importance, for they are the men and women of the next generation, and a race of strong men and women, vigorous and capable to endure a life of work, cannot come from a race of puny, sickly, and badly nourished children.

#### THE BUILDING

First in order of importance in school sanitation is the construction of the building, which should conform to all the sanitary rules so necessary for other buildings—a good dry foundation, supporting a building of the proper dimensions, and so placed that there shall be an abundance of fresh air and sunshine. We should calculate about 300 cubic feet of air-space for each pupil and 25 square feet of floor-space, considering that the air may be changed about

## 96      Outlines of Practical Sanitation

six times an hour. This would allow 1800 cubic feet of fresh air per hour, which is little enough.

The floor should be of hard wood with no carpets or rugs; the walls and ceiling should be painted some neutral tint, which is much easier on the eyes than white. No room should be more than forty feet long, for beyond this the distance to the blackboard becomes too great for perfect vision. In regard to the number of pupils to one room, all educators and sanitarians are agreed that something like thirty is sufficient, and any increase above this is detrimental to the efficiency of the school and to the health of the children.

The cleaning of schoolrooms should be done with care; the rooms should be thoroughly swept daily, and mopped once a week with soap and soda-water; the walls, furniture, desks, etc., should be wiped with a damp cloth instead of dusting.

### SEATING

A point to which much attention is being directed of late is the seating of school children. It is often said that faulty seats furnish one of the factors in bringing about lateral curvature of the spine; while this may not be exactly true, there is no doubt but that faulty seats would certainly aid in producing this disease in a child already overburdened with a weak and undeveloped body.

We all are familiar with the picture of the old-time

country schoolroom, with the feet of the smaller children dangling eight or ten inches above the floor. There is no longer any excuse for this condition of things, for adjustable seats are now manufactured at a moderate cost and should be used everywhere. The seat should be regulated to the size of the pupil, and attention paid to the often neglected point of having the distance between the back of the seat and the edge of the desk too great. The desk should be so arranged that the pupil can sit erect on the seat and at the same time read a book leaning on the desk: when the desk is too far away the child slips forward to the edge of the seat, and sits in a stooped and uncomfortable position. Error in seating has also probably much to do with the defects in vision so common in school children.

#### HEATING AND VENTILATION

The heating and ventilation of schoolrooms are important items in the children's health; especially is this true of ventilation. In the city, steam and hot water are generally used for heating; and ventilation should be effected by some method other than opening the windows and doors. The indirect method of heating with steam-coils and the extraction of foul air by vents at the floor-level, using a rotary fan either in the foul-air shaft or in the fresh-air inlet, is an effective plan both for ventilation and for heating.

In the small country school the best method is

## 98 Outlines of Practical Sanitation

by the ventilating-stove, which consists of an ordinary stove surrounded by a galvanized iron hood, with a fresh-air inlet underneath the floor as shown in Fig. 26; while a foul-air shaft near the floor would

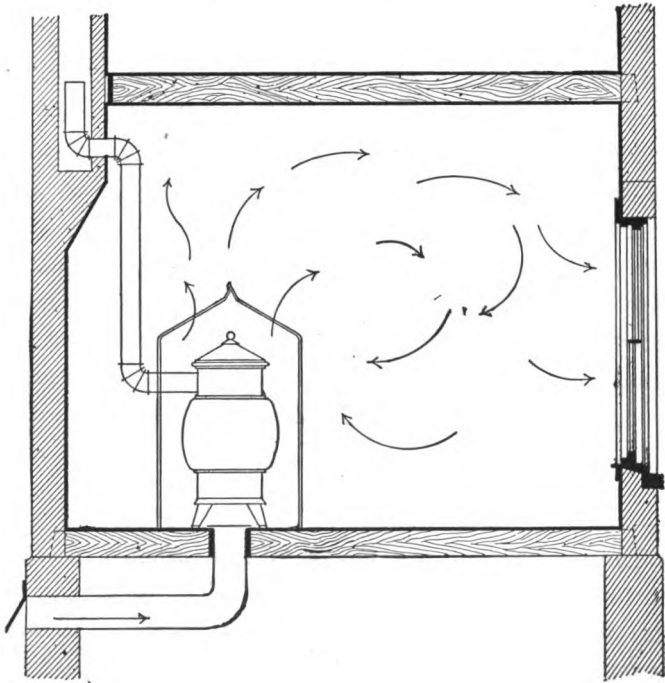

FIG. 26.—Diagram showing Circulation of Air in a Room heated by a Ventilating-stove.

aid in keeping the air in better circulation, the windows and doors are generally sufficient for this purpose in the small one- or two-room building.

Of course a thermometer—a reliable one—should have a place in every room, for only by this way

can an equable temperature be maintained. To make a thermometer out of one's own body is folly; the temperature-sense of the body is more fluctuating and unreliable than anything else.

Fresh air is absolutely necessary for the health and good work of the child. One investigator declares that in a certain school under his observation, where ventilation was defective, the work of the pupils fell off by forty per cent. I can myself recall a certain classroom in a grand old college—hoary with age and last-century buildings—where almost every student was often half asleep in less than an hour, due to the vitiated air from defective ventilation.

#### LIGHTING

Lighting of the schoolroom is a very necessary factor; quite often it is bad, and is one of the items responsible for many of the ocular troubles which afflict children. The light should always enter on the left side or back of the pupil, if possible. The windows should have an amount of glass equal to one-fourth of the floor-space, and the shades, if there are any, should roll from the centre both up and down, so that the light may be as little obstructed as possible, and be readily diffused by first striking the ceiling.

## WATER-SUPPLY

Plenty of fresh water should be one of the requisites of every school, but drinking-cups are wholly insanitary and have been the means of transmitting and spreading disease. This antique method of furnishing drinking-water should be replaced by the drinking-fountain, which should take the place of cups and other drinking-vessels in all public places. "It consists," to quote a writer in "The Sanitarian," "of a marble, porcelain, or iron pedestal (Fig. 27), about three and a half feet high, capped with a funnel-shaped basin, twelve inches in diameter, connected with the water-supply; upon pressure of a lever at the base of the basin, a jet of water shoots up from the centre of the basin and into the mouth when held over it and from this—the jet being small and without spatter—with very little tact thirst may be abundantly satisfied without the intervention of a drinking-vessel of any kind. It admits of no contact of the lips with the jet-pipe or any other portion of the apparatus—the water flows from the supply-pipe through the jet directly into the mouth, and all waste into the bowl immediately flows off by an escape pipe—none is allowed to accumulate." The drinking-fountain is the most sanitary drinking appliance yet devised, since the time when our ancestors quenched their thirst in primitive style at the wayside spring. It should by all means be adopted in every school and public hall.



FIG. 27.—Drinking-fountain. (From copyrighted photograph by the J. L. Mott Co.)

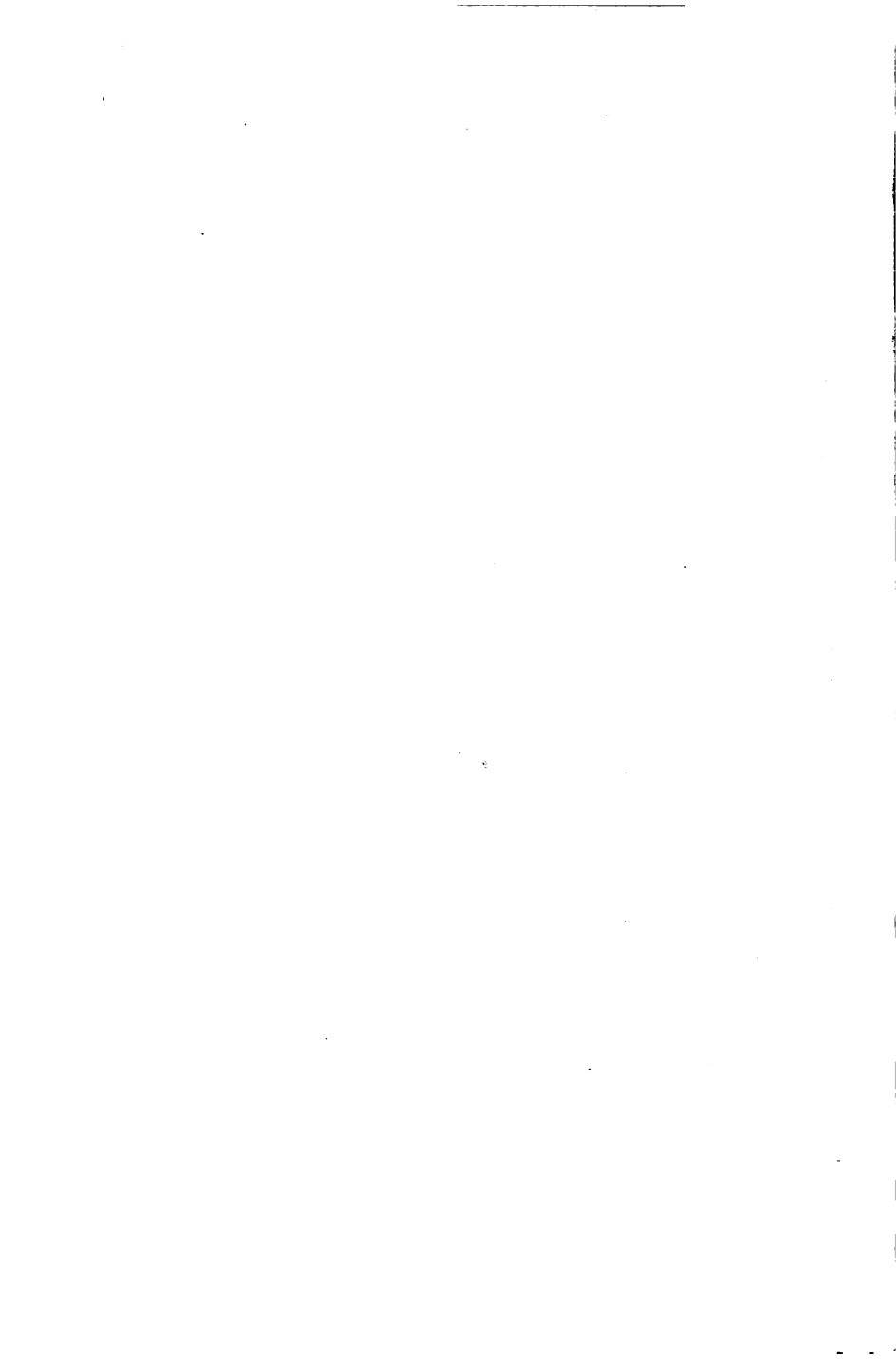



In country schools where water under pressure is unavailable, the drinking fountain cannot be used; in such cases, the only sanitary way is for each child to have an individual drinking-cup. The origin of water available for country schools—the nearest well or spring—should be a matter of inquiry to the patrons; the water should only come, of course, from an unpolluted source, and should meet all the requirements mentioned in Chapter II.

#### TOILET-ROOM AND PRIVY

The toilet- and cloak-rooms should be light and airy, and in the city where water-closets are used there should be up-to-date sanitary plumbing. Towels hung up and used for a week or two are not likely to give children a good idea of cleanliness—towels should, of course, be replaced every day. Such things may seem trivial, but the lesson they teach may be of vast importance to the after-life of the child.

In country schools the privy should be attached to the school building by a covered passageway and there should be privacy. In place of the old-fashioned privy the dry-earth system should be used, made somewhat after the model shown in Fig. 28. A pit is dug about three feet deep, which has its two sides, front, and back lined with brick and cemented, resting on a cemented base; or the entire structure, floor, and sides may be made of concrete.

In the back an open space is left for a door, and

## 104 Outlines of Practical Sanitation

an inclined pathway is made from the bottom of the closet to the surface, in order to facilitate removal of contents; the entire foundation should be, must be, absolutely water-tight. The part under the seat is made of galvanized iron, and a flap is attached

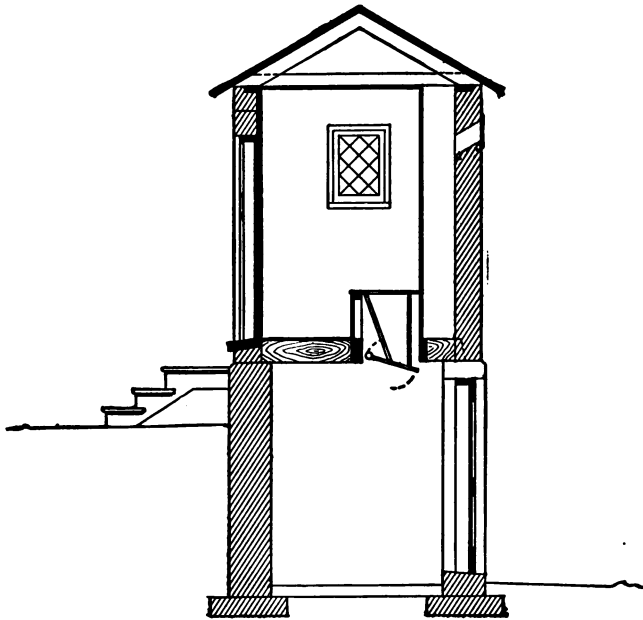

FIG. 28.—Dry Closet for Schools.

to the lower end to prevent an upward draft; this flap may be balanced so as to work automatically. Every few days some sifted-coal ashes or dry earth should be thrown into the closet by the janitor, and when necessary the contents removed and put on

an adjoining field for manure. An arrangement like this requires very little care and is perfectly sanitary.

### WORK AND PLAY

The hours of study should be arranged according to the age of the child, for children's power of undivided attention is something very limited. According to Edwin Chadwick—an authority on the subject—a child from five to seven years can only give attention to one subject for about fifteen minutes; from seven to ten about twenty minutes; from ten to twelve, twenty-five minutes, and so on.

Overwork in school is a common complaint and leads very often to nervous troubles, neurasthenia, headaches, dyspepsia, etc., which interferes greatly with the progress of the child; better go slowly and have good health than to go fast and have a broken-down constitution to take up life's battle when school is over. The precocious child who knows Hadley's Greek grammar by heart at fifteen, or something similar, never takes the lead in after-life. Cramming for examination is to be depreciated, and keeping children in after school-hours as a means of making up neglected work is a poor method; some other means of discipline should be devised.

While I do not depreciate scholarship, I must say that the successful man or woman is rarely the one who stood at the head of his class, for the simple reason that the mental energy necessary to gain

preëminence at school means often a sacrifice of physical energy which should be reserved for later years. My old teacher, the great gynæcologist Goodell (and I believe Egbert quotes the same), used to say in one of his lectures: "So commonly do I find ill-health associated with brilliant scholarship, that one of the first questions I put to a young lady seeking my advice is, 'Did you stand high at school?'"

Play is just as necessary as work, and the subject of school playgrounds is beginning to attract a good deal of attention in the cities where, in most places, the only playground is the street. If school lots were always purchased of such a size as to protect the school building from loss of light, air, and sunshine by adjoining buildings there would always be land available for playgrounds. The bare walls and bare grounds of the ordinary city or town school may be also much improved by judicious planting of grass, vines, and shrubs, which besides improving the appearance of the place give the children much pleasure and education on the line of civic improvement. Above all, school playgrounds, even if covered with a lawn, must not be disfigured with the "Keep-off-the-Grass" sign.

#### MEDICAL INSPECTION

Medical inspection of schools is an innovation that has proved to be of much value, and in a good many of the larger cities daily inspection is now

practiced somewhat on the following plan: The inspector makes the rounds every morning, and the teacher fills out printed slips with the name of the pupil and the symptoms or conditions to which it is desired to call his attention. On the arrival of the inspector such children are sent to him, and his advice regarding the child is written on the slip and returned to the teacher, who, of course, acts upon the suggestion of the inspector.

By this means not only are contagious diseases more quickly discovered and their spread controlled, but minor ailments and defects, which ordinarily pass unnoticed until much damage is done, are corrected and the child better fitted to continue school-life. Defects of sight and hearing are noted and remedies suggested; measures are also taken to avoid hysteria, chorea, and other school diseases. On the appearance of certain diseases the children are sent home by the inspector with proper advice to the parents.

In New York City, in addition to diphtheria, mumps, and the exanthemata, children are excluded for the following diseases—a plan which may well be adopted by all cities practicing school inspection: Trachoma, scabies, impetigo, favus, pediculosis, acute conjunctivitis, ringworm, and tonsillitis.

Of these diseases trachoma needs special mention, for it has begun to be quite prevalent in certain seaboard towns, and, in consequence of our great facilities for transportation, it is likely to appear at any place.

This disease was imported some years ago by south- and east-Europe emigrants to New York; it is a contagious granulation of the eyelid which often leads to loss of sight; it is often overlooked and mistaken for simple granulation which is non-contagious. Trachoma is transmitted by soiled towels, the hands, etc., and it is well to caution children, and every one else in fact, against using public towels on the face.

From time to time school inspection should also include measurements of height, weight, and other necessary physical data, and accurate records kept for future use. Inspectors should likewise be given authority and held responsible for the entire sanitary condition of the buildings. School inspection has not only limited the spread of disease in the locality where it has been practiced, but it has abolished the necessity for closing schools even in the face of an approaching epidemic.

## CHAPTER VII

### Car Sanitation



AR sanitation is a new subject for a work on hygiene, yet it is attracting considerable attention, for the use of cars as a means of travel is getting to be such a necessary factor in our daily lives that the public feel that those corporations having public franchises owe it as a duty to provide for the convenience and health of their patrons. Car sanitation—of railway-cars we shall first speak—is almost everywhere neglected and no provision, or scarcely any, has been made for the health of the travellers. Water turned into a tank from a hose in the station and ice handled by a dirty workman are every-day occurrences. Ventilation and heating are things unknown, as is shown by the miserable overheating of nearly all railway-cars—indeed these overheated cars are the great trials of an ordinary journey. Excreta are disposed of by a method as crude as that of the American Indian, even the “method of Moses” is neglected.

## FURNISHING AND CLEANING

Although the defects are glaring there is no complicated system necessary for getting cars up to a sanitary standard, for car sanitation, as the Committee of the American Public Health Association has put it, is "simply car cleanliness; cleanliness of the car itself and its contents, including the furnishings, its air, and its supply of water and food."

In regard to the construction of the cars a good deal might be said: the principal thing, from the sanitary viewpoint, is that the interior finish should be of hard and polished wood, as this affords less chance for the collection of dust and dirt. The furnishings should be, if possible, of some non-absorbent material which is readily removed so as to be more easily cleaned.

In sleeping-cars the utmost cleanliness should be observed with the bedding. The use of blankets which are washed only once in six months, a fact admitted by a certain railroad official, is most insanitary. Blankets should be discarded for some more washable material.

Cleaning of the cars is an important factor; this should be done frequently and thoroughly with plenty of soap and water, and the whole car should be disinfected at intervals with formaldehyde gas or some other standard sterilizing agent. Much of the present-day car disinfection is about as efficient in preventing



disease as the protection afforded by wearing amulets around the neck.

Fouling the cars by expectoration should, of course, be absolutely prohibited. It is hardly necessary to have cuspidors in the ordinary coaches. The smoker and the spitter perhaps have a right to defile their own houses, but they have no right to force their filthy habits on the public; this should, at least, be confined to the smoking-car.

#### VENTILATION AND HEATING

Ventilation and heating are probably the most defective sanitary arrangements met with in car travel; it is claimed, perhaps justly, that there has been much difficulty in getting a system which will meet the necessary requirements; but Dr. Dudley, chemist to the Pennsylvania Railroad at Altoona, has devised a method which bids fair to be a great improvement over the old-time cars. Each passenger-coach is made to seat sixty people, and the method devised by Dr. Dudley undertakes to furnish 60,000 cubic feet per hour of fresh-heated air, that is 1000 cubic feet per hour for each passenger.

The method is very simple, and is described by the originator as follows: "It consists in taking air from the outside in through two hoods *A* (Fig. 29) at diagonally opposite corners of the car, thence through down-takes *B* underneath the hoods to the spaces *C*, one on each side underneath the car floor,

bounded by the floor, the false bottom, the outside sill, and nearest intermediate sill. These spaces, which are in section about  $14 \times 7\frac{1}{2}$  inches, extend

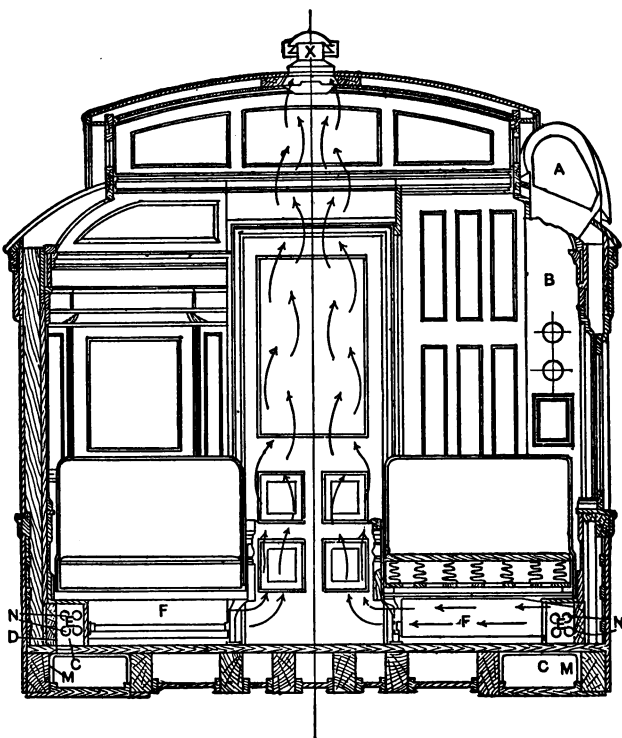

FIG. 29.—Cross-section of a Car, showing Method of Heating and Ventilation. (From a drawing by Dr. Dudley.)

the whole length of the car. From these spaces the air passes up through the floor by means of proper apparatus over the heating system *E*, thence out into the car, and finally escapes from the car through

ventilators *X* situated on the centre line of the upper deck.

“The heating system consists of pipe-radiators *N*. The pipes extend nearly the whole length of the car, and are enclosed in a continuous boxing. The heating substance is steam from the locomotive, and is supplied to the radiators at the middle of the car; the condensed water is returned to the middle of the car and from there allowed to flow through proper traps to the track. It will thus be seen that the cold air coming up through the floor into the heater boxes *E* divides and passes in contact with the heater pipes each way to the tubes under the seats *F*, which carry it to the aisle. The tubes under the seats serve in some measure as a foot-warmer.”

The whole system of ventilation is controlled by opening or closing the ventilators on the roof. The system has been a success experimentally and practically, in regard to both the heating and the amount of fresh air introduced; and is now applied to all new cars being built for the Pennsylvania lines.

#### DISPOSAL OF EXCRETA

The prevalent method of disposing of excreta—the most primitive to be imagined—in scattering it over the road-bed is dangerous to a high degree, and there seems to be no reason why disease should

## 114 Outlines of Practical Sanitation

not be (perhaps it has been) transmitted in this way; there is no doubt but that many people travel

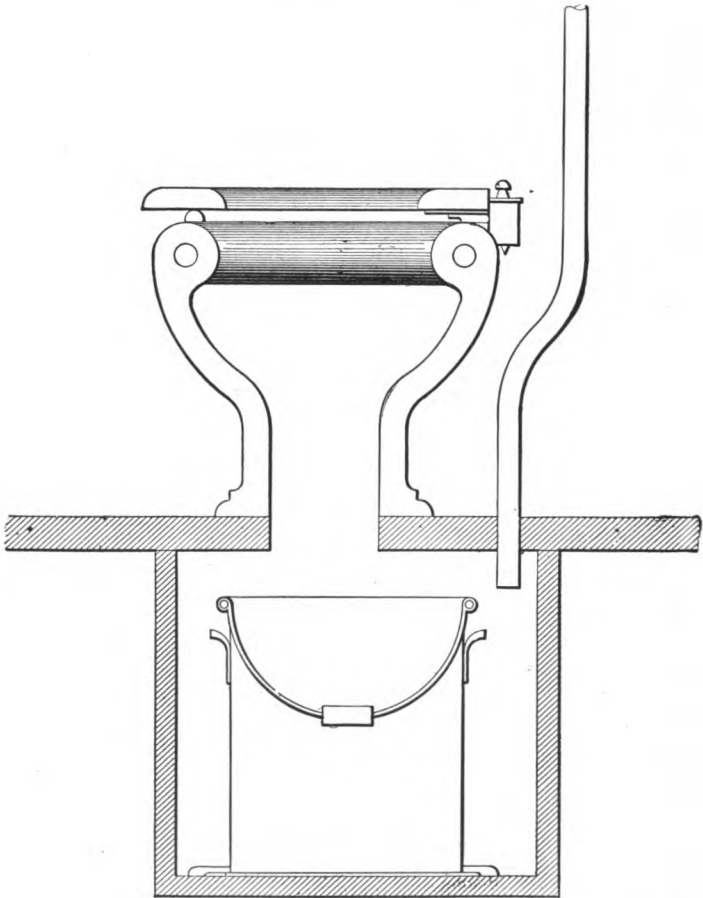

FIG. 30.—Section of Dry Closet to be used in Railway-cars.

who are in the incipient stages of typhoid fever, and the discharges from such, falling into the drain-

age area of small streams, which may be some one's water-supply, would be a positive source of danger.

Some form of dry closet seems to me to furnish the best method of disposal. Fig. 30 shows a device of this kind, which the author offers as meeting all sanitary requirements and as being readily available. The seat and fixtures in the car are the same as used at present, but underneath the floor of the car is attached a box containing a galvanized pail; in this is put sifted-coal ashes or some fine dry earth to the depth of four or five inches; this would be sufficient deodorant and absorbent without any additional treatment until the end of the run, when the pail should be removed through a door on the outside of the box, emptied, aired, and perhaps repainted. The contents removed could be stored in covered bins and sold for fertilizer.

#### DRINKING WATER

The drinking water furnished in railway-cars is, of course, taken from the tap in the various cities from which they start or through which they pass; unfortunately in some cities the water-supply is very bad, and it hardly seems right to subject the travelling public to dangers so easily avoided. It is probable, too, that transportation companies, owning privileges granted by the general public,

## 116 Outlines of Practical Sanitation

owe more to their patrons than a city owes to its citizens.

In regard to ice much more care should be used than is commonly done; although the ice itself may be pure, the contact with soiled hands is a possible source of danger. I have learned that recently the Pennsylvania Railroad Company has issued orders for the men who handle ice to wear white cotton gloves; such sanitation seems unworthy the usual progressiveness of a great railroad. The only way, only sanitary way, to handle ice is with tongs and with these alone. The drinking-fountain is hardly available for cars, but the public should be advised to bring their own drinking-cups.

### STREET-CARS

Trolley- and street-cars require a word in sanitary affairs. Most lines, especially suburban lines, are poorly equipped with rolling stock, and as a result the open summer car is used more often and longer than it should be; it is undoubtedly the source of the many colds which affect the patrons of such lines in late summer. In most places these cars should probably not be used more than two months in the whole year, and in a great many places in the northern parts of the country they are undesirable at any season. The only good word that can be said for the open car is that the ventilation is good, but

often it is too good. In wet weather, open cars should always be replaced by closed ones.

The closed car presents the usual defects of insufficient ventilation and with it insufficient heating in cold weather. While the railway-car is almost invariably overheated, the street-car is almost always underheated, and to these cold cars have been attributed the undue prevalence of pneumonia occurring in some of the larger cities during certain periods of the year; of course it must not be forgotten that street-cars need not be kept as warm as railway-cars, for passengers in street-cars are always clad for outdoor weather—a temperature of 60° F. would probably be sufficient.

A good many street-cars are heated with stoves, yet nothing more defective could be imagined, for the upper part of the car gets fairly warm, while a stratum of cold air settles down around one's feet. Electric heaters placed under the seats appear to give better results, but in very cold weather they seem to be of inadequate size; the proper way would be to have electric heaters of sufficient capacity with a fresh-air inlet on the outside of the car, so that fresh-heated air could be furnished at the same time; and fresh air is sometimes sadly needed.

With the great overcrowding of street-cars, which is a daily occurrence on many suburban lines, proper ventilation is almost impossible by any method or system. Street-car companies should be forbidden by law to carry more than the seating capacity of

## 118 Outlines of Practical Sanitation

the car, as is done in many European cities; to be sure, this belongs to the domain of the legislator, but it is one of the first steps in the sanitation of street-cars.

Another important point in the heating and ventilation is that the ends of the cars should be closed by glass windows and doors; by this means a draft of cold air does not rush through the car every time the door is opened. Then, too, the open-end car is cruel and unjust to the employees, in that they are exposed to all states of weather; indeed, it is even dangerous, for a man facing a cold wind at zero temperature is likely to get so benumbed that he has not proper control of the car, and accidents may result—not from the carelessness of the motorman, but from the negligence and penuriousness of the company.

The cleaning and disinfection of street-cars should be attended to thoroughly and carefully, for with the increase of travel, following the advent of electrical power, there is increased danger from the spreading of contagious diseases. Expectoration in street-cars should, of course, be absolutely forbidden; it is illegal in most places and its abolishment rests simply with the transportation companies. It is strange that with our enlightened and progressive civilization we have to have anti-spitting signs defacing our streets, our public halls, and our public conveyances.



## CHAPTER VIII

### The Cause and Prevention of Contagious and Infectious Diseases



THIS is a class of diseases generally known as preventable, in contrast to those diseases caused by the wear and tear of the machinery of the human body which are inevitable, sooner or later. There is no real reason why any one should ever have smallpox, typhoid fever, and the like, for we know exactly how to prevent these and certain other diseases, but when it comes to do it we often fail and have to admit that our theories are away ahead of our practice; very often this failure is due to the lack of understanding and education of the public about the subject. Some of these diseases are transmitted directly from the person having the disease, others by food and drink contaminated with the discharges of the sick, and still others by inoculation through wounds or by the bite of certain animals and insects.

## SMALLPOX

The cause of smallpox is not definitely known, except that it is likely a bacterium residing in the skin of the person having the disease. The method of preventing smallpox is by vaccination and revaccination, isolation of the sick, quarantine of the exposed, and disinfection of the surroundings and belongings of the patient after recovery or death.

As to the value of vaccination there can no longer be any question; although one or two vaccinations protect most persons more or less through life, it is well to remember that a person has contracted smallpox who has been recently and successfully vaccinated. The fact is that as long as a person is susceptible to vaccination, just so long is he susceptible to smallpox, and such a person should be revaccinated as often as vaccination "takes." We may put it down as an undeniable fact—and I here quote Dr. Lee—that, "next to the rising of the sun, nothing is more absolutely certain than the fact that successful vaccination with reliable lymph, repeated with sufficient frequency, is a sure preventive against smallpox."

Any one who wishes to know what smallpox was in the years gone by, especially when introduced into virgin soil, should read George Catlin's account of the extinction of the Mandan Indians in the summer of 1838. The disease was so virulent that many died in a few hours after becoming infected, and in a few

weeks the whole tribe was extinct; the disease then spread to the surrounding tribes, and within four or five months it is supposed that at least 25,000 Indians perished.

As the period of infection in smallpox extends from the beginning of the disease until all scabs have become detached and desquamation has ceased, the sick should be isolated for that length of time. All communities should have sanitary hospitals for the isolation of such cases, for domiciliary quarantine—quarantining the sick with the well—is a very unsatisfactory procedure. After the removal of the sick, the persons exposed should be quarantined fourteen days, and if no case then develops they are likely safe.

The disinfection of a room occupied by a person sick with smallpox should be carried out as follows: The ceiling, walls, and floor should be washed with a solution of corrosive sublimate (1 to 1000), and the paper or paint scraped off. All the furniture should likewise be washed and all bed-linen soaked in corrosive-sublimate solution, and then boiled or carried to a steam-disinfecting plant. Woollen goods and books must be opened up as much as possible and exposed to formalin gas. Mattresses should be moistened with a solution of formalin or bichloride, and then exposed to gaseous disinfection or removed to a steam disinfector, if one is available. If a mattress is badly soiled and no steam disinfection possible, it should be destroyed by fire.

The gaseous disinfection of a room is now generally done by formaldehyde gas; the room is closed and all cracks and openings sealed with gummed-paper strips, and the formaldehyde then set free, in the proportion of 20 ounces of a reliable preparation to 1000 cubic feet of air-space. There are many different methods and appliances for liberating this gas and many of them are inefficient. The simplest method, and one which has given very effective results, is the method of Breslau. The apparatus consists of a kettle, a tripod, and a vessel for alcohol; the kettle is partially filled with hot water and the alcohol in the vessel underneath ignited. As soon as the water boils formaldehyde is poured into the kettle in sufficient quantity, and the room left closed for twenty-four hours; it is then thrown open and thoroughly aired. The formaldehyde candles offered for sale and for which much is claimed are wholly unreliable.

#### MEASLES.

The exact cause of measles is unknown; the contagious principle is probably contained in the skin and discharges from the mouth and nose. The infectious period extends from the beginning of the earliest symptoms to the end of the catarrhal and desquamative stages. The only preventive is isolation of the sick, and disinfection of the infected places and things.

### SCARLET FEVER

Scarlet fever is an acute contagious disease, the contagion of which has great tenacity of life, although limited in range; it is probably spread by exhalations from the skin and discharges from the nose and throat. It has been spread by contaminated milk and by exposed clothing a year old. The only preventive is isolation of the sick,—for at least a week after complete recovery,—and disinfection.

### WHOOPIING-COUGH

Whooping-cough is a contagious disease caused by the bacillus of Afanassieff, which, in spite of its name, has no great resisting power. The infectious period lasts at least until the end of the spasmodic cough; and the only means of prophylaxis is isolation—slight isolation is sufficient for exemption—and disinfection.

### DIPHTHERIA

Diphtheria is caused by the bacillus of Loeffler, which is supposed to live in polluted soil; the bacteria find lodgment in the upper air-passages of those exposed, and cause not only a local inflammation but a general infection. While the contagion is limited to a few feet it has great strength of life. Diphtheria

affects domestic animals, especially cats, and this may be one of the ways of transmitting the disease. The writer has seen at least one case in which the disease apparently followed sore throat in the family cat. The disease has also been transmitted by infected food-supplies such as milk.

The period of infection extends from the onset of the symptoms until virulent bacteria have disappeared from the throat. In cases where bacterial examination is not available, the patient should be isolated until all the symptoms of the disease have disappeared. The prophylaxis of diphtheria consists in the sanitary measures relative to household hygiene: clean, dry houses and cellars and clean back yards, for it has been found that this disease quite often appears in dark, damp houses with filthy surroundings. The other means of prevention are isolation of the sick, the use of antitoxin, quarantine of exposed persons, and disinfection.

Of the value of antitoxin as a preventive and curative agent it is hardly necessary to say a word. The author has personally seen the most astonishing results following sufficient dosage of this remedy; it seems, as manufactured at present, to be absolutely devoid of danger. The only danger consists, if I may quote a certain chemist, "in not giving enough of the remedy." In some persons an exanthematous rash simulating scarlet fever follows its use, but this is of trifling import.

### TYPHUS FEVER

Typhus fever is an exceedingly contagious disease which infects the area surrounding the sick with great intensity, and spreads with great rapidity. The cause is likely some specific germ not yet isolated. The sole measures of prevention are those which relate to overcrowding and filth, prompt isolation of the sick with plenty of fresh air, quarantine of exposed persons for fourteen days, and disinfection. The author happened to be resident physician on Blackwell's Island during the last appearance of this disease in New York harbor. The cases which occurred on the Island were quickly isolated in tents and rigid quarantine maintained, with the result of the speedy disappearance of the diseases.

### CEREBROSPINAL FEVER

Cerebrospinal fever is an infectious and communicable disease caused by the *diplococcus intercellularis meningitidis*. The germ is of feeble growth, but resists considerable drying; it has been isolated from the nasal discharges, the cerebrospinal fluid, and from soiled handkerchiefs weeks after infection.

In order to limit the spread of this disease it is necessary to exercise general cleanliness about the premises, and, above all, cleanliness in the sick-room, the destruction of clothing soiled by discharges from

the nose, and the careful disinfection of all towels, clothing, and bedding used by the sick; isolation, and finally the disinfection of the room occupied by the patient.

### TUBERCULOSIS

Tuberculosis, the dread disease which kills one-seventh of the human race—which kills 100,000 every



FIG. 31.—Mt. Alto Tuberculosis Camp. (From photograph by Dr. J. W. Rothrock.)

year in the United States—is the price that humanity has paid for civilization, for the savage in his natural state is exempt from the ravages of what has aptly been called the Great White Plague. Tuberculosis



## Contagious and Infectious Diseases 127

is caused by that resisting germ—the *bacillus tuberculosis*—which, although dried, still lives and floats in the atmosphere everywhere and anywhere until a fertile spot is reached upon some devitalized or overcivilized mortal.

The disease is generally spread by the expectoration



FIG. 32.—A Tuberculosis Camp in the Adirondacks. (From photograph by Review of Reviews Co.)

of those having pulmonary tuberculosis; diseased meat and milk of animals are also factors in causing the disease, which is more prone to develop in those who have a certain predisposing weakness, in which heredity seems to play an important part.

The method of prevention, as outlined by the Committee on Tuberculosis of the American Public

## 128 Outlines of Practical Sanitation

Health Association, which represents the prevailing opinion at present, is as follows:

(1) Notification and registration by health authorities of all cases. (2) The thorough disinfection of all houses in which tuberculosis has occurred. (3) The establishment of special hospitals for the treatment of the disease. (4) Inspection of dairies and slaughterhouses and the destruction of tuberculosis dairy-cattle. (5) Enforcement of laws against public spitting. (6) Compulsory disinfection of hotel rooms, sleeping-car berths, and steamboat cabins which have been occupied by consumptives.

Of the open-air treatment of the early stages of consumption too much cannot be said; there are various camps and sanatoria in many places in this country and they are doing a good work. This treatment is simply a return of humanity to its primal condition, and while one's back yard may be sufficient, most patients will do better with the air and invigorating influences of mountain woodland. The accompanying photograph (Fig. 31) shows a tuberculosis camp on the State Forestry reservation at Mt. Alto, Pa. This camp, under the able management of Dr. Rothrock, has simply done wonders.

Out on the banks of the Missouri the converse of this picture is presented. The predatory Sioux—the descendants of the wild raiders of the past—have passed from the teepee to the house, from aboriginal life to civilization without the sanitary influences of the latter. Most of their houses (?) 18×24 feet are pro-

vided with but one-half of a window and a door; here the family—from five to twenty—sleep nightly, and the result? From 50 to 75 per cent die of “the sickness,” as an old chieftain, John Grass, who had lost his seven sons, called it.

### TYPHOID FEVER

The cause of typhoid fever is the *bacillus typhosus*, which unfortuna'ely possesses unusual strength of life; living for some years in polluted soil, growing and thriving in filthy water and milk, finally frozen up in a cake of ice for two or three months, and in the end thawing out and still possessing energy enough, perhaps, to make trouble for some one—such is the vitality of the *bacillus typhosus*.

The poison of typhoid leaves the body by way of the feces and urine; the bacilli are more prevalent in the feces during the height of the disease, but the reverse is true of the urine which contains the greater number during convalescence and this continues for some weeks after recovery.

The poison is usually transmitted by infected water or milk. It has also been found that flies are disseminators of the disease, on account of their breeding on fecal matter and feeding in neighboring kitchens; this was especially observed in the camps of the Spanish War, where the terrible epidemics of typhoid were directly traceable to this source. Experiments also have demonstrated that typhoid bacilli will

## 130 Outlines of Practical Sanitation

develop in the tracks of flies which have been allowed to settle on typhoid discharges and then made to walk over suitable culture medium (Fig. 33). Not

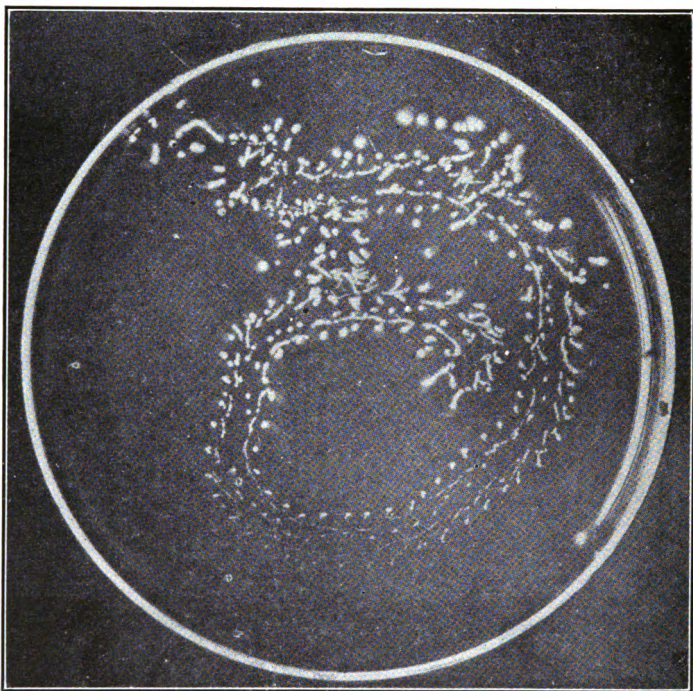

FIG. 33.—Foot-prints of a House-fly. Every white spot means thousands of bacteria. (From photograph by N. Y. Underwood in "Country Life.")

only are typhoid bacilli carried on the feet of flies, but Celli has recovered virulent germs from their feces, and a number of other observers have shown that the cholera vibrio, the anthrax bacillus, styphylococci,

## Contagious and Infectious Diseases 131

and streptococci can also pass uninjured through the bodies of flies.

Of all the numerous flies which breed in or frequent human feces only certain ones are frequenters of houses and kitchens. After extended investigation L. O. Howard, U. S. entomologist, found that the following are the ones most likely to transmit the disease: the house-fly, the little house-fly, the fruit-fly, the stable-fly, the green-bottle fly, the blue-bottle fly, and the *Sarcophagæ*. All these are rather distinct species and can readily be recognized by a little study.

The means of preventing typhoid fever consists in obtaining uncontaminated water and food, especially in the way of milk and raw oysters; the screening of the house to keep flies out and the thorough disinfection of all typhoid discharges (feces and urine) by a 5 per cent solution of carbolic acid, a 10 per cent solution of chloride of zinc, a solution of bichloride of mercury (1 to 1000), or a solution of chloride of lime made in the proportion of 4 ounces to 1 gallon of water. As a corollary cleanliness of one's habitation by means of the rapid disposal of manure and putrescible material, and the keeping of all such material out of the reach of flies, is desirable.

## CHOLERA

Cholera is caused by a specific organism—the *comma bacillus*—which gets into the body by way of the gastro-intestinal tract from infected water or food. It is readily destroyed by drying and by heat, and fails to thrive in an acid medium, but is not destroyed by freezing. Cholera, like typhoid, has also been transmitted by flies. The infectious period lasts until complete recovery. The method of prevention consists in the use of pure water and uncontaminated food, the isolation of the patient, and the thorough disinfection of all discharges.

## MALARIAL FEVERS

The malarial germ is a protozoan which inhabits the red blood-cells of those affected and is transmitted to man by the bite of the various species of *Anopheles*. The mosquito only acts as a carrier of the poison, and can only infect a person after having bitten one having the disease or at least having the protozoan in the blood; the time required for the parasite to develop in the cells until ready to be discharged into another subject is ten days (according to Theobald Smith), and, as the incubation period is ten days, about twenty days would elapse before another case could develop. The infectious period lasts for many years, and it is said that the mosquito may become infected from those old cases, even when

the parasite cannot be found in the blood. It is interesting to note that Dr. Koch has recently made the brilliant discovery that "apparently healthy negro children in the pestilential districts of Africa constantly carry large numbers of malarial parasites in their blood."

The means of preventing the spread of malarial fevers consist in the elimination of the mosquito by drainage of the breeding-places, or treatment with kerosene, screening of the house and patients, and the use of quinine, which is, of course, an antidote for the disease.

Mosquito warfare has developed into a science of late, and much is being done in this respect to render certain places habitable which have hitherto been unfit for dwellings. The family of *Anopheles* is represented in the United States by three species—*A. quadrimaculatus*, *A. punctipennis*, and *A. crucians*. I have found the two former species rather abundant in certain places and at certain times, in my own locality in Southeastern Pennsylvania, but only once have I found the third species, which seems to be rare.

The malarial mosquito frequents ponds and rock-pools in wayside brooks (Fig. 34); it is in fact a country species compared with the culex—the ordinary mosquito—which breeds in rain-barrels, cess-pools, or any stagnant water about the house. The entire life-history of the mosquito covers a period of from one to three weeks, depending on the state of

## 134      Outlines of Practical Sanitation

the weather, a fact which must be taken into account in the kerosene treatment of pools.

It must not be forgotten that small fish, almost all varieties, are great destroyers of mosquito larva. The



FIG. 34.—Where the Malarial Mosquito Breeds.  
(Photograph by the Author.)

author made an experiment on this line last summer, by introducing several small catfish into a bucket swarming with mosquito larva; the next morning the water was perfectly free of larva. As the malarial mosquito does not stray very far from home, local action counts for much.



### YELLOW FEVER

Yellow fever is an acute disease transmitted to man by the bite of a certain mosquito—the *Stegomyia fasciata*—which has become infected by biting a former case, and is caused by this means alone. The discovery of the method of the transmission of yellow fever, and the adoption of preventive methods based on this discovery, is the grandest achievement in sanitary science since the days of the immortal Jenner. This mosquito is a Southern variety and does not often occur north of Philadelphia; it is also a domestic variety and rarely strays far from home.

The period during which the mosquito can take up the infection lasts only for the first three days of the disease; it then takes about twelve days for the mosquito to become capable of transmitting the disease which lasts during her (only the female can bite) lifetime, or at least for several months. The period of observation should be five days, and the means recommended for preventing the spread of the disease are those which were so successfully adopted during the American occupation of Cuba:

(1) The immediate screening of the patient to keep him from the mosquito.

(2) Destruction of all mosquitoes and their breeding-places; and, as the *Stegomyia* breeds about houses in rain-barrels, etc., much may be done to eliminate

## 136 Outlines of Practical Sanitation

it by the proper screening of all household receptacles holding water.

(3) The destruction by fumigation of all possibly infected mosquitoes on the premises of the sick, by pyrethrum powder or by sulphur. Last year another culicide was used in New Orleans which approaches more the ideal, in that it injures nothing but the insects. This culicide is composed of equal quantities by weight of carbolic acid and gum camphor, and the resultant liquid is evaporated slowly in the room—about three ounces being used for a thousand cubic feet of air-space.

By the three measures mentioned above, and by these alone, the pest-ridden city of Havana was freed from yellow fever for the first time in 140 years; patients were even treated in the wards of an ordinary hospital—only they were thoroughly screened.

The old method of shot-gun quarantine—in the light of these discoveries—partakes of the methods of the Middle Ages, and should not be used. In Panama the officials have recently taken up the plan of offering a prize of \$100 for every case of yellow fever reported to them, hoping by this means to prevent the secreting of cases, which always leads to such bad results.

### THE PLAGUE

The plague is caused by the bacillus pestis (*Kitasito*), a rather frail germ which, although it dies speedily when dried, can live for months in water or milk, and can endure a great amount of cold. Infection takes place through the lungs, from clothing and bedding which may harbor the poison for a long time; it also takes place through the digestive tract by food and drink, and in some instances the poison is transmitted by inoculation. The period of observation should be fifteen days, and the patient is a source of infection as long as bacilli may be found in the buboes, the blood, and urine.

The methods of prevention are isolation of the sick, quarantine of the exposed for fifteen days, the use of Haffkine's or Yersin's serum, general sanitary cleanliness, including the destruction of rats, which seem somehow or other to be a factor in transmitting the poison, and thorough fumigation with sulphur.

Some interesting experiments have been made which tend to show that the plague may possibly be transmitted by fleas from infected rats, but the great difficulty in the chain of evidence is that the flea inhabiting plague-infected rodents has not yet been made to bite human beings.

Every one interested in sanitary science should read De Foe's "History of the Plague in London"; although not exactly history, for De Foe was only

## 138 Outlines of Practical Sanitation

four years old at the time, it nevertheless gives a most interesting, and likely a faithful, portrayal of the sanitary affairs in England at the time.

### HYDROPHOBIA

Hydrophobia is a virulent infection of the nervous system, produced by inoculation from one of the lower animals having the disease: the dog, fox, wolf, or cat. It is principally contracted by the bite of a rabid dog, and may be communicated any time during the illness or incubation period, which sometimes extends to 240 days.

The method of prevention is the enforced use of the muzzle and the extermination of the army of worthless curs which crowd every community, the thorough cauterization of suspected wounds with silver nitrate, and the institution of the Pasteur treatment; this consists, in a general way, of the injection of a solution of progressive strengths, made from the dried medulla of an infected animal.

### ANTHRAX

Anthrax is an acute infectious disease of the lower animals, chiefly sheep and cattle, and is transmitted to man by contact, by the inhalation of dust from diseased hides, or by the ingestion of infected flesh. The preventive measures consist in isolation of the sick, inoculation with protective serum, the thorough destruction by cremation of animals dead of anthrax,

## Contagious and Infectious Diseases 139

and the distribution of quicklime in large quantities over the infected land.

### GLANDERS

Glanders is an infectious disease of the horse, and generally transmitted to man through the nasal mucous membrane during contact with a horse sick with the disease; inhalation through the nose or mouth of the secretions from the nose of another case seems sufficient to cause the disease. Prevention consists in isolation, destruction by fire of dead animals, and the disinfection of stables which contained those sick of the disease.

### TETANUS

Tetanus is a specific disease caused by the tetanus bacillus, which is, fortunately, an anaerobic germ; that is, it is likely only to grow in deep punctured wounds shut off from free oxygen. The germ is widely distributed in the soil, although seemingly more prevalent in some places than others. Prevention consists in the scrupulous cleaning and disinfection of all wounds, however trifling they may seem, even to the point of an operation if necessary, the destruction of all dressings used on tetanus wounds, and the isolation of the patient from the surgical cases.

## CHAPTER IX

### Vital Statistics



VITAL statistics are the life-records of a community—the records of birth, marriage, disease, and death; they are valuable as an index of the prevalence of certain diseases, an indicator of the general health, and a criterion of the sanitary progress that is being made from time to time. The value of knowing these facts is illustrated by the following: Some years ago, in order to compare the health of a certain rural district with a given urban district, statistics were carefully collected for a stated period, and among other facts discovered was the surprising one that this rural district—one of the garden-spots of Pennsylvania, a region of fine farms and picturesque villages, of picnic groves and summer residences—had an alarming amount of typhoid fever, just as much as the great city district with which it was compared. As is often the case in rural localities—the disease being scattered here and there—no one suspected the real state of affairs until perception was sharpened by actual figures.

Statistical records to be of any value must be exact, the diagnosis of disease must be correct, and, in estimating the health condition of a place from the death-records, due allowance must be made for cases which really belong elsewhere, if such is the fact. Some time since in a lecture on hygiene at a Farmers' Institute, I was calling attention to the poor sanitary condition of a certain place, as shown by its great number of deaths, when I was interrupted with the retort that the locality in question was so popular that people went there to die; which, of course, was not quite true. It is a fact, however, that certain places containing health resorts and sanitariums aid in distorting the vital statistics unless due account is taken of them.

In regard to careful diagnosis the following is worth repeating: I had inquired for the typhoid death-rates of a certain third-class city; it was promptly and kindly forwarded by the health department with the added note that "seven of the deaths reported were not due to typhoid fever but to other complications, such as cardiac asthenia, general peritonitis, intestinal perforation, etc." Any one can readily see that the vital statistics of that city would hardly have much real value, and the worst part of it is that the physicians who made out the death-certificates were really the ones who were negligent.

## REGISTRATION OF BIRTHS

The registration of births is of great value, if correctly kept, for comparison with the death-rate of a country in indicating the amount of "race suicide." A great many irrelevant questions are sometimes asked on birth-certificates; for sanitary purposes all that is required is the date and place of birth, sex, color, legitimacy, and perhaps age, nativity, and occupation of both parents.

## REGISTRATION OF DISEASE

The registration of diseases by the health authorities is of vast importance, especially diseases of an infectious or contagious nature, which are more or less preventible. The record of a disease like typhoid, as pointed out above, is a most valuable index of the sanitary condition of the water- and milk-supply of a place, and the utmost attention should be paid to these statistics.

The registration returns should indicate if possible the location from which infection was derived, for the first question the sanitary executive wants to ask about any of these diseases is "Where did it come from?" The recently organized Pennsylvania Department of Health require the reporting of the following diseases: Actinomycosis, anthrax, plague, cerebrospinal meningitis, chicken-pox, cholera, diph-



theria, dysentery, erysipelas, German measles, glanders, hydrophobia, leprosy, malarial fever, measles, mumps, pneumonia, puerperal fever, relapsing fever, scarlet fever, smallpox, tetanus, trachoma, trichiniasis, tuberculosis, typhoid fever, typhus fever, whooping-cough, and yellow fever.

City health boards should also require the registration of summer diarrhœas of children and the parasitic skin diseases. It is needless to state that the reporting of disease should be made promptly, at least within twenty-four hours after discovery by the physician. Such diseases as smallpox, typhus fever, yellow fever, and the plague should be reported immediately, as every minute is of value in staying an epidemic.

#### REGISTRATION OF DEATHS

A death-record should comprise the cause, date, place, sex, color, occupation, and age of the decedent. The annual death-rate, which varies from 13 to 15 per 1000 in the rural districts to 21 to 23 per 1000 in the larger cities, is found by dividing the number of deaths per year by the number of population and multiplying by 1000.

The value of death-records as an aid to sanitary science was made apparent recently in a study of rural and municipal death-rates in several States where records happen to be fairly well kept. As is

## 144 Outlines of Practical Sanitation

well known, the general death-rate in all civilized communities has been steadily decreasing during the last century, but in the States where the observations were made it was shown that the decline had been most marked in the city districts. In Connecticut, in the city districts (that is, towns of 5000 population and over) the death-rates had dropped during the last ten years from 20 to 17 per 1000, but in the rural districts from 17 to 16. In Massachusetts the urban rate had dropped from 19 to 17, but the rural only from 17.2 to 17.1. In New York the urban dropped from 23 to 21, but the rural had actually increased from 13 to 15 per 1000.

From these records it is apparent that there is something wrong in some of the country districts, either in the means of preventing or in the methods of treating diseases. If we had a complete record of the diseases we could likely tell at a glance where the trouble lay.

It has happened that in the final summing up of statistics the death-rate of particular diseases, notably typhoid fever, has been accepted as the criterion of the sanitary improvement that is being made. This seems to the author to be a serious mistake, for the death-rate of any disease is a very changeable factor, due rather to better treatment than to better sanitation; especially has this been true in regard to typhoid fever, consequently, while the amount of typhoid fever in a place might be as great as ever, the death-rate might be, as it is, gradually lessening,

and this improvement should certainly not be credited to the side of sanitary progress.

I have arranged the following tables in order to show the great variation that may sometimes occur between the typhoid sick-rate and death-rate.

RATE PER 10,000

Table I

Death-rate	Sick-rate
1.4	18
1.4	3
1.4	7

Table II

Death-rate	Sick-rate
3.0	10
3.0	20
3.0	35
3.0	7

Table III

Death-rate	Sick-rate
5.0	5
5.0	45

Table IV

Death-rate	Sick-rate
10	50
10	100

Table V

Death-rate	Sick-rate
18.0	200
18.0	42

Take, for example, a city which has a death-rate of only 1.4 per 10,000; all sanitarians would judge this to be a place supplied with fair drinking water, yet one of these cities, as is shown by Table I, might have just six times as much typhoid fever as the other. Now take a city where the death-rate is 5: this would be considered to be in poor sanitary condition, yet if its sick-rate is only 5 it is in vastly better condition than the city with the lower death-rate of 1.4 and a sick-rate of 18. By referring to

## 146 Outlines of Practical Sanitation

the tables many such discrepancies will be seen; for instance in Table III, although the death-rates are the same, the real difference in the amount of typhoid is 40 cases per 10,000, and in Table V, with the death-rate of 18, one city had five times as much typhoid as the other, and one of them had even less than a city with the much lower death-rate of 5.

With such and even greater differences occurring in actual records, it must be evident that the death-rate cannot have the same relative sanitary importance as the sick-rate; the death-rate stands for the treatment and the character of the disease, while the number sick is the real point with the sanitarian. Of what value as an indicator of sanitary gain would be the death-rate of diphtheria to-day compared with what it was twenty years ago? As an indicator of improved treatment it would be, however, of immense value.

## CHAPTER X

### Municipal Sanitation

#### HISTORY



MUNICIPAL sanitation is not of very ancient origin; although as soon as men banded together into towns, they discovered that certain precautions had to be taken for the preservation of their health; these means did not come under communal direction but were generally limited to each man taking care of himself, as is done to-day in the small village. By and by the first steps in municipal organization were instituted, which consisted only in getting a public water-supply and some method of waste disposal—crude, although very crude were the methods in use.

While Greek and Roman cities were being adorned with those magnificent palaces and temples of marble, the ruins of which still excite our admiration, the very streets by the side of these buildings were so filthy that on a hot day the stench was almost unbearable, so a contemporary writer states. Later, in the Middle Ages, the little progress that had been made

## 148      Outlines of Practical Sanitation

was forgotten, and sanitation, like everything else good and wise, was hidden away in the monkish cloisters of Europe. Stables and houses were close together and human filth was simply thrown into the street, presumably to be removed by a scavenger. Pestilence after pestilence swept over the land, and in 1348 Venice appointed three public health officers and attempted municipal direction of public health, for the first time in the world's history.

Henceforth, a better condition of affairs began to exist, although improvement was slow, very slow. Here is a little note which has come down to us about Stratford-on-Avon in the sixteenth century: "The streets were full of evil-smelling pools, in which pigs and geese freely disported themselves, and dung-hills skirted the highway. The first thing we learn about Shakespeare's father is that in April, 1552, he was fined twelvecence for having formed a great midden outside his house in Henley Street—a circumstance which, on the one hand, proves that he kept sheep and cattle, and, on the other, indicates his scant care for cleanliness, since the common dung-hill lay only a stone's throw from his house. Again, in 1558, he, along with some other citizens, is fined fourpence for the same misdemeanor."

In London a hundred years later much the same condition existed. Macaulay says: "Saint James's Square was a receptacle for all the offal and cinders, for all dead cats and dead dogs of Westminster. At one time an impudent squatter settled himself there,

and built a shed for rubbish under the windows of the gilded saloons in which the first magnates of the realm—Norfolk, Ormond, Kent, and Pembroke—gave banquets and balls. It was not till these nuisances had lasted through a whole generation, and till much had been written about them, that the inhabitants applied to Parliament for permission to plant trees.

“When such was the state of the region inhabited by the most luxurious portion of society, we may easily believe that the great body of the population suffered what would now be considered insupportable grievances. The pavement was detestable, and the drainage was so bad that in rainy weather the gutters soon became torrents. Several facetious poets have commemorated the fury with which these black rivulets roared down Snow Hill and Ludgate Hill, bearing to Fleet Ditch a vast tribute of animal and vegetable filth from the stalls of butchers and green-grocers.”

Gradually, as the knowledge of better means of preventing disease spread abroad, greater demands were made on municipalities, and municipal sanitation developed and enlarged into the position it holds to-day. Filthy water, dirty streets, crime-lurking and pest-breeding tenements are no longer tolerated; food- and milk-supply, supervision of schools and transportation lines, the proper construction of buildings and the collection of vital statistics also come, or should come, under municipal supervision; in fact, in the larger cities, the sanitary authorities generally are,

and rightly should be, clothed with the power to use almost any means to preserve the public health. All of these subjects have been discussed in the foregoing chapters, and a few remaining, perhaps minor ones, are treated in the following:

#### OVERCROWDING

Crowding, that is, overcrowding, is one of the sanitary defects which seems inevitable in the rapidly growing cities of the present—although it is not a thing alone of the present. As far back as the times of Charles I. we find a law prohibiting “the subdivision of any building into tenements . . . and the receiving of more families than one into a single building.” The scarcer and dearer the land the higher go the buildings, until some city streets are practically tunnels with the roof left off. Such a condition, when the streets are narrow, keeps out sunlight from many rooms the greater part of the day and favors dampness.

Of course, high buildings, in a business section like lower Broadway, where the rooms are only occupied for office purposes, probably do not have any far-reaching effect; at least nothing in proportion to the harm done when such buildings are used for continual residence. This crowding has reached its pinnacle on Manhattan Island, where in one section on the East Side nearly 2000 persons dwell on a single acre—the thickest, blackest mass of humanity in the



whole world; and the death-rate is simply appalling, especially among the infants during a hot summer; even if the tenement child does survive his infant days, he has still a battle to fight for life, for tuberculosis is the dread monster that saps the strength of the overcrowded. Other diseases fall into insignificance when compared to the Great White Plague; indeed it is claimed by some authorities that fully one-half of the whole tenement population of New York is more or less tubercular, and every other city where similar conditions exist may expect similar results.

Here is a little record taken from "The Battle with the Slum," by Jacob A. Riis, which shows the terrible conditions brought on by overcrowding, and is well worth the reading to every sanitarian and public-spirited citizen. "Twenty cases of typhoid fever from a single house in one year was the record that had gone unconsidered. Bedrooms in tenements were dark closets, literally without ventilation. There couldn't be any. The houses were built like huge, square boxes, covering nearly the whole of the lot. Some light came in at the ends, but the middle was always black.

"Forty thousand windows, cut by order of the Health Board that first year, gave us a daylight view of the slum—'damp and rotten and dark, walls and banisters sticky with constant moisture.' Think of living babies in such hell-holes and make a note of it, you in the young cities who can still

head off the slums where we have to wrestle with it for our sins!

“Put a brand upon the murderer who would smother babies in dark holes and bedrooms! He is nothing else. Forbid the putting up of a house five stories high, or six, on a twenty-five-foot lot, unless at least thirty-five per cent of the lot be reserved for sunlight and air. Forbid it absolutely, if you can. It is the devil’s job, and you will have to pay his dues in the end, depend on it.”

All municipalities should carefully note the first symptom of the disease of overcrowding, for it creeps on gradually, very gradually, and prevention is vastly better than cure. The height of all buildings should be strictly limited, depending, of course, on the width of the street and the size of the lot. Some cities have regulations permitting the height to equal one and one-half times the width of the street; perhaps that is about right. Equally important is it that sufficient room be left on every lot for air-space. On a corner-lot something like twenty-five per cent should be reserved for this purpose, and on an inside lot probably forty per cent should be left unoccupied. The tendency to occupy the greater part of a lot with a building in a residence district is an early symptom of overcrowding; when the rear tenement goes up the disease is thoroughly developed and needs active treatment.

The plan and form of tenements are not within the scope of this work, yet suffice it to say that

every room should have plenty of light—sunlight—and the number of people per building should be limited. The question of baths in tenements is yet open. Tubs are not very satisfactory, it is likely that some form of shower-bath would be much better.

Tenements have been recently built in New York and Brooklyn especially, which conform to all sanitary requirements, and are models of their kind; six stories high and of brick, with hallways “airy and sunshiny,” and divided into two-, three-, and four-room apartments, the entire building being as fireproof as modern science can make it.

The apartments are heated by steam, and hot water is furnished all the year round from a central boiler-room. In all the kitchens there are gas-ranges, and the average fuel and light bill has been less than three dollars per month. In the basement there are free shower- and tub-baths and each suite of rooms has a private toilet. There are no rooms without windows and there is a dust-chute on every floor. The cleanliness of these buildings show a marked contrast to the old tenement and the cheapness of the rent put them in the way of the poorer class, the very class for which they were intended, and the strangest thing of all is that, although they were not built with the idea of profit, they are paying four per cent on the investment.

In all our work of municipal and sanitary reform we are apt to forget that the alleys and the tenements are more needful of attention for the public

## 154 Outlines of Practical Sanitation

health than the avenues and the brownstone fronts. The following lines, written by an unknown poet, have a meaning that is worthy some thought:

“From slums, where foul diseases hide,  
The free wind travels far and wide, .

“The rich man, living on the square,  
Throws wide his windows for the air,

“His petted child with every breath  
Drinks in the viewless seeds of death.

“The rich man loaded down with his woe  
Wonders why God should send the blow.

“The pastor wonders, too, and prays  
And talks of God’s mysterious ways.

“But know, O man of high estate,  
You’re bound up with the poor man’s fate,

“The winds that enter at your door  
Have crept across his attic floor.

“If you would have ‘all well’ with you  
Then you must seek his welfare too.

“If even selfishness were wise,  
It would no other life despise.”

### STREET CLEANING

Another factor in municipal sanitary housekeeping is street cleaning. In the Middle Ages and even later, as mentioned previously, the public streets were the receptacles for all sorts of filth and waste. For example, one of the city ordinances of Muhlberg, in 1367, ordered that manure deposited by householders

on the market-place must not be allowed to remain longer than fourteen days—a record, though small, which tells a pretty big tale.

In all the larger cities the public now demand clean streets as one of the requirements of health. The late Col. Waring, during his administration in New York, used to point to the improved health statistics as an evidence of the value of clean streets; such statistics are slightly misleading, for during this period there was likewise renewed activity on all lines of health administration; however, no one doubts but that clean streets are an important item in municipal health, for streets, dirty and filthy with dust, wafted hither and thither with every wind, cause various eye, throat, and bronchial diseases; and streets wet and slushy with snow and ice cause wet feet and the consequent colds and pneumonic troubles. Then, again, clean streets tend to make clean back yards, for each and every step in progress helps on to a next.

In street cleaning the principal points are the sweeping, scraping, and flushing of the streets, the removal of snow, and the prevention of the scattering of household rubbish and ashes. Col. Waring brought street cleaning in this country up to a standard hitherto unattained; his method, described by himself, was somewhat as follows: “Each sweeper, clad in white duck, is supplied with a little two-wheeled truck which supports an open bag or can to receive sweepings (Fig. 35). On this truck he transports his

## 156 Outlines of Practical Sanitation

tools: a broom with a scraper at the back, a watering-can, a short shovel (or a shovel-like arrangement fastened to the truck), and for asphalt, a broad, long-handled scraper. The sweepings are put in the bag (or can) as fast as collected. When full, the bag is tied and placed on the curb.

“Householders are allowed to put nothing on the sidewalk. All receptacles must stand within the

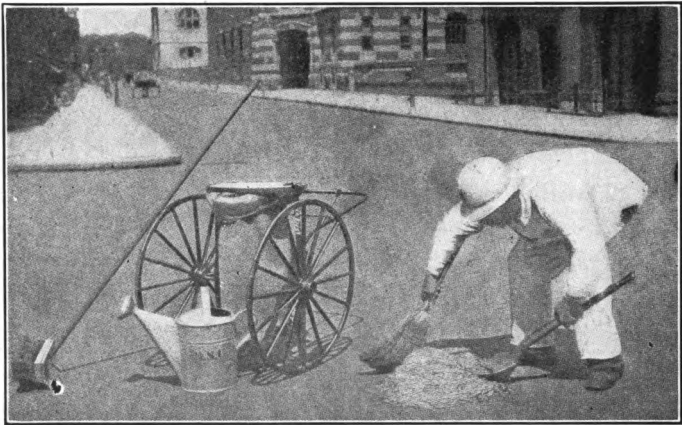

FIG. 35.—A Sweeper at Work. (From McClure's Magazine.)

‘stoop-line.’ Garbage is kept separate, and is set out in a proper vessel within half an hour of the scheduled arrival of the cart on its early-morning rounds. Ashes are kept within the house in cans, from which they are transferred to bags by a department man. These bags are tied and set on the curb to be taken away by the cart that collects the bags of sweepings.”

By this method Col. Waring cleaned the streets of New York better than they had ever been cleaned before, but this was not all; the greatest thing probably was, according to Col. Waring himself, that "a man instead of a voter had been put at the other end of the broom-handle."

For snow removal the only effective method is man, shovel, and cart; the cost depends on the price of local labor and is always expensive, but snow removal is very desirable, especially in climates where there is much thawing and freezing.

#### PUBLIC BATHS

The introduction of baths for public use is an old institution, and valuable from the point of sanitation and morality, for there can be no question but that "cleanliness is next to godliness." Municipalities are beginning to recognize these facts, and public baths are becoming more and more a popular institution. In the great cities where ninety to ninety-nine per cent of the poorer classes have no bathing facilities, the public bath becomes a real sanitary necessity.

We all know the story of the Roman baths—interesting and instructive it is—how, although instituted at first for the poor and the public, they soon degenerated into lounging-places for the luxurious and indolent nobility, who, with enervated and clouded brain, forgot that they lived in a work-day world.

## 158 Outlines of Practical Sanitation

In the "Last Days of Pompeii" Lord Lytton gives a splendid description of the bath during the period of Roman greatness. "By Hercules!" said Diomed, opening his eyes, "Why it would take a man's whole life to bathe." "At Rome, it often does," replied Galucus, gravely. "There are many who live only at the baths. They repair there the first hour in which the doors are opened, and remain until that in which the doors are closed. They seem as if they knew nothing of the rest of Rome, as if they despised all other existence."

"By Pollux! you amaze me. . . . Even those who bathe only thrice a day contrive to consume their lives in this occupation."

The "only" is the meaningful word in this sentence, for it is recorded that many bathed habitually seven times a day. Here is plainly a case of mistaking the means for the end, and the trouble was not with the bath but with the people; it will indeed be well for modern cities to study the story of this Roman mistake.

There is no need to have costly marble palaces for public baths; durability is the needful thing in the building, and a speedy method for bathing, a thorough and speedy removal of the soiled water, are the needful things in the bathing arrangements; and this seems to be accomplished more readily by the rain- or shower-bath than by any other means.

A rain-bath takes only about one-tenth of the water and is vastly more cleanly. In a space  $68 \times 25$



feet there have been placed facilities for bathing by rain-bath, 400 persons daily. To construct even a pool to bathe this many people would require one hundred times the space.

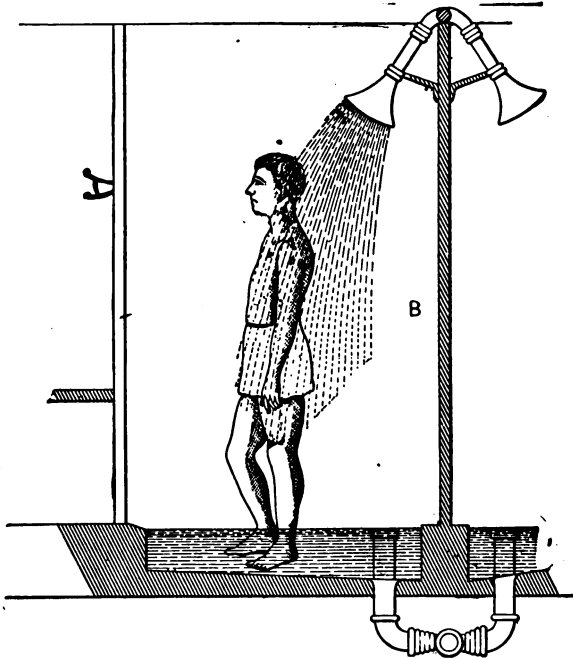

FIG. 36.—Section of a Rain-bath. (From the "Sanitarian.")

Fig. 36 shows the working of the rain-bath: the applicant first turns on the water, soaps himself thoroughly, then again turns on the shower, and in five or six minutes is as clean as soap and water can make him. By this method of bathing, cleanliness of the bathroom is more easily attained, and the

## 160 Outlines of Practical Sanitation

danger of transmitting contagious diseases reduced to a minimum or rather abolished—a real danger in public tub-bathing unless the utmost care is observed and a great amount of labor expended.

### PUBLIC PARKS AND PLAYGROUNDS

Public parks and playgrounds for the city is another sanitary benefit quite often overlooked by the city "fathers," especially in rapidly growing cities. Parks bring the freshness of the country, the fields and the woods, to the overcivilized denizens of the crowded districts, breathing-spots to the thousands who are cooped up amid endless walls of brick and mortar. Recreation and relaxation are just as necessary to a healthy life as food and drink; good, healthy outdoor life for children makes better men and women, better able to meet and to overcome the labor and exactions of adult life.

Any one who has seen Central Park on an afternoon when the green stretches are "common," when hundreds of children are romping and playing and picnicing with their parents and elders, must realize that the greatest good that a great city can do for its people has here been done.

William the Conquerer tearing down villages to make hunting-parks for Norman nobles is rightly maligned by his contemporaries. A thousand years later we tear down city blocks to make parks and playgrounds, not for a ruling class but rather for

the unprivileged mass; better still we should say for the good of all—so much has humanity progressed.

After considerable study experts have decided that about one-twentieth of a city's area should be reserved for parks and squares. That young cities should see to this in time and set apart sufficient space is only an evidence of economy. Mulberry Bend Park, and it doesn't seem much of a park to the rural visitor, nevertheless cost New York over \$2,000,000; neglected sanitation sometimes comes high.

In one of the larger towns of Central Pennsylvania this taking time by the forelock has been done. On the borders of this city there are 400 acres of waste land, of swamp and meadow and hillside, covered with trees and grass and flowers. A real natural park sculptured out and filled up by an ancient river—a park without the aid of the landscape-gardener. After considerable agitation this city has taken means to appropriate this as a public park—probably the wisest and most far-sighted policy ever displayed by any city.

#### THE SMOKE NUISANCE

The smoke question is beginning to be agitated in almost all cities, not perhaps so much on account of the sanitary as the æsthetic side. But it has a sanitary side, too, for the black, heavy smoke, especially resulting from soft-coal combustion, composed of

particles of carbon, hanging like a black cloud over many a city, blots out sunshine and light; not only this, but carbon particles in the atmosphere help to make fogs, and fog and smoke together is still worse. It has been calculated that some of the large cities lose about one-sixth of their sunshine from this cause and about an equal amount of light; this for summer. In winter the loss is estimated at fully one-half, and no one will deny but that the loss of sunlight—of so much sunlight—is an insanitary condition.

A great part of the smoke is due to domestic fires, that is when soft coal is burned exclusively; each house, it is estimated, pours out something like five tons of smoky air every day. In other places where soft coal is only used for factories the domestic fire does not enter into the calculation. In Fig. 37 is shown a photograph of a city of this kind: the heavy cloud of smoke from the factories in the east end of the city, forming a dark background for the building in white, helps to make a fine photograph, but a dirty city.

The atmosphere, by the way, does not annihilate or consume the smoke or render it harmless, as it does disease-germs; it simply carries it from one place to another and then drops it earthward. In some cities which happen to be great railroad centres the contributions from this source are enormous, and in most of our large cities the smoke problem has risen to such a point that it calls for repressive

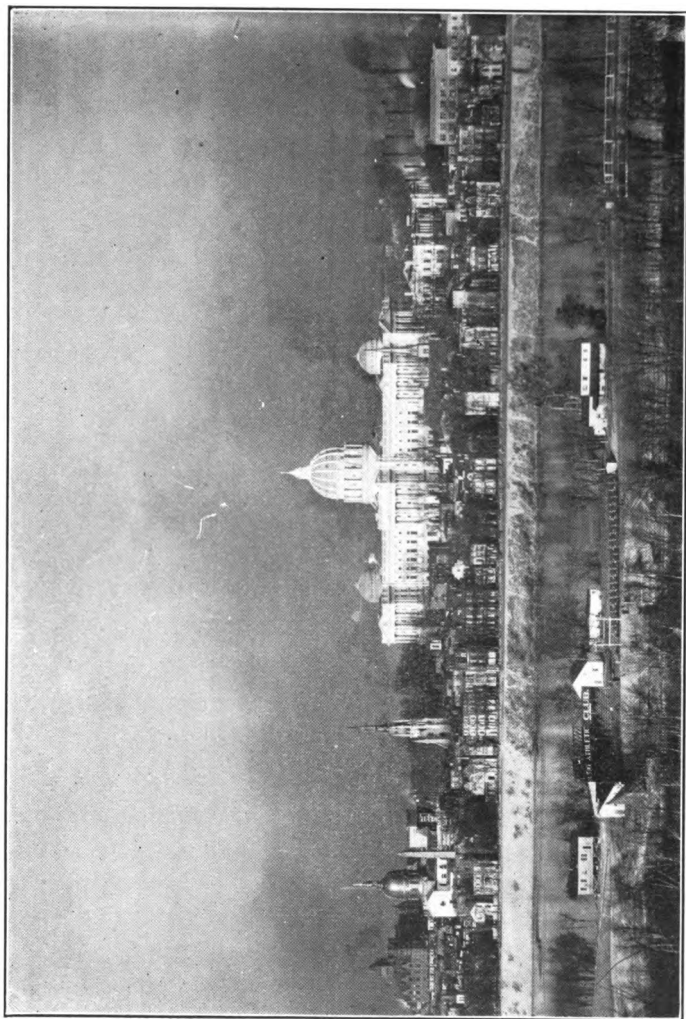

FIG. 37.—The Smoke Nuisance. The heavy cloud of smoke forming a dark background for the building in white helps to make a fine photograph but a dirty city.

(Copyrighted photograph by James McCormick, Jr.)



measures. The whole subject, however, is simply a matter of legislation, since smoke-consuming devices are able to give us a smokeless chimney.

The rapid advance of electrical power generated by water is beginning to be felt in certain favored places and the chimneyless factory is one of the hopes of the future.

#### THE SPITTING NUISANCE

The habit of public spitting on the sidewalks, street-cars, etc., has gotten to be not only a public nuisance, but a real menace to the public health, especially when it happens that a person with tuberculosis may be doing the spitting. Dried tuberculosis sputum retains its vitality for many months in favorable places and is not affected by cold, so that cold, damp, and dark rooms and unclean cars, once infected, may remain a source of danger to future occupants. Such sputum dried on the street, carried everywhere by the winds, becomes a menace to every one. A good many cities have laws against public spitting, and there seems to be no reason why anti-spitting laws should not be enforced, although it is likely that the education of the public to the dangers arising from this cause would have a greater and more far-reaching effect.

## CHAPTER XI

### Rural and Suburban Sanitation

#### GENERAL CONSIDERATIONS

URAL sanitation differs radically from municipal sanitation in that, in a city, the municipality assumes charge of, and responsibility for, almost all sanitary conditions, while in the country, for the most part, the individual is himself responsible for the sanitary or insanitary conditions surrounding his residence; it rests with him alone, very often, whether typhoid fever or some other preventable disease shall invade his home.

Rural hygiene never received very much attention, for the country was always considered a healthy place; in the years gone by, when cities were in the plight described in a former chapter, the country then was, in comparison, a very healthy place; thinly settled, watered by wholesome springs, and covered with a virgin soil which rapidly disposed of all organic waste, it was indeed pure and sanitary. With the increase of population—and it is the same in all



lands and all times—as generation after generation resided in the same place, the soil surrounding such habitations became polluted and overburdened with organic filth; springs and wells became polluted and finally infected, and the isolated country-place, originally healthy, became scourged with disease.

While the cities have been making wonderful sanitary progress in recent years, the country has still kept to its old-fashioned ways, trusting in Providence and the “Old Oaken Bucket”; the sanitary aspect of many a village to-day is the exact counterpart of many a town or city in the days of Shakespeare. Consequently, as a result of this rural neglect born of conservatism, the healthfulness of these localities is not what it should be. As was shown in a former chapter, the general death-rate has not been lowered in many rural districts in the same proportion that has taken place in the urban districts, and it is evident that much more attention should be paid to the sanitation of these outlying districts, not only for their own sake but also for the advantage reaped by the adjoining municipalities, and eventually by the whole state.

#### DWELLINGS

First in importance in the country as in the city is the question of dwelling; in the city the construction of buildings is under the rules and regulations of the city government, which make it possible for

## 168 Outlines of Practical Sanitation

all buildings to conform to a certain standard. The city dweller buys a lot and builds thereon his house, facing the street whether it is east or west, north or south; over the surrounding buildings he has no control—they may overtop his and keep out the sun, and they may prevent him from having a fine view across a neighboring river or lake, but for this there is no remedy; he must confine himself to his own narrow lot.

In the country and suburbs it is different, and the prospective builder may choose a site that conforms more to sanitary requirements and individual taste; he may have a lot large enough for the sun to shine into the house during the whole day. He may build on a hill or he may build in the valley. When it comes to the house-building proper one is not bound by any rules, but if he wishes a dwelling that is to be healthy it is necessary to follow sanitary principles; and there are three things: ground-moisture, ground-water, and ground-air which must be considered before a stone is laid.

The ground-moisture is that moisture in the upper layers of the soil, derived from the ground-water below by capillary attraction, and from the percolation of surface-waters from above. As the amount of moisture is directly proportional to the absorptive power of the soil, it is evident that by increasing the permeability of the soil, we can diminish this dampness; to do this in any given place we fill trenches with broken stone, or we lay drain-tiles; the water

percolating through the soil will collect in these drains and flow off, and the soil will become dry.

This dampness of the soil, especially when excessive, is no doubt a factor in certain diseases; the prevalence of rheumatic complaints in rural localities is a well-known fact, strikingly different from its occurrence in a well-drained city. There seems to be a relation, too, between dampness and phthisis; according to the English sanitarians there has been a great lowering of the mortality from this disease following sub-soil drainage in certain districts. The elimination of malaria, which always follows improved drainage, we now know to be due to the destruction of the breeding-places of the mosquito. Diphtheria, too, seems to spread much more rapidly in houses with dark, damp cellars.

Ground-water, another soil factor of considerable interest, is that underground sheet of water which completely fills all the interstices of the soil; its height is readily told by the height of the water in the neighboring wells. This sheet of ground-water is in constant motion to the nearest watercourse and cannot usually be lowered except by lowering the adjoining streams; but, unless the ground-water is very near the surface, it is not of very much consequence to the house-builder, except that it furnishes some moisture to the upper layers of the soil. I know of a town where the ground-water is generally twenty-five or thirty feet below the surface, yet almost every house is damp and unhealthy, because faulty construction

has permitted ground-moisture and surface-water to enter the foundations. The relationship between ground-water and typhoid fever, which has been shown to be present in many places, does not exist in the absence of wells or springs which are used for a supply of drinking water.

The ground-air is interesting to the sanitary house-builder in two phases, namely, its composition and movement. It is made up partly of gases arising from decomposition and putrefaction, processes which are continually going on in the soil, especially in that which is contaminated with organic waste; and the resultant gases diffuse rapidly through the surrounding locality. Carbon dioxide, which is one of the gases formed, is always greater in ground-air than in the atmosphere, while oxygen, on the other hand, is decreased, and nitrogen remains about the same. In addition to these gases there are certain amounts of ammonia, hydrogen, ammonium sulphide, and marsh-gas which go to make up ground-air; thus differing greatly in composition from the atmosphere it is surely not suitable for breathing purposes. In addition, too, it may contain at times certain disease-germs.

The second disturbing factor of the ground-air—its movement—is of considerable importance. It has been found that the wind blowing against the surface-soil sets this underground air in motion; likewise, too, any change in the ground-water level will occasion fluctuations in the air above. During a heavy

rain, for example, the surface-waters flowing downward upon the ground-air compress it. Underneath a dwelling, if the cellar is not properly protected, there is an area of diminished pressure, and, consequently, the ground-air pours into the cellar and then into the house above. In winter, during heavy frost, similar conditions exist, when the frozen ground is more or less impervious; and then the warm, unfrozen, and porous part underneath the house readily facilitates the ascent of the air below.

So with the understanding of these soil factors—ground-water, ground-air, and ground-moisture—we try to construct a foundation which will eliminate these dangers. In the first place, the surrounding area should be thoroughly drained, unless it happens to be very dry from natural drainage. A trench, filled with broken stones or laid with tiles, and having an outlet in some lower ground, should surround the foundation-wall; the trench being somewhat deeper than the bottom of the foundation. After the excavation has been made the required size, the bottom should be laid with concrete (Fig. 1), and this covered with a layer of hot pitch; the walls should then be built upon this, and the outside of the wall also coated with hot pitch. The cellar floor may then be finished with a coat of concrete or cement. A foundation made in this or some similar way insures the occupants against all trouble from the soil.

The direction to which a house should face will depend on circumstances, but it should be so arranged,

if possible, that sunlight can enter every room some time during the day. The common method of having the front of the house, with its most used and frequented rooms facing the road or street in whatever direction it may happen to be, is bad, for it sometimes gives the least possible amount of sunshine and light to the principal rooms in the house. A better way, and one that is generally feasible, is to put the house in such a position that the principal living-rooms will have a southerly exposure, irrespective of the street, and then by making a lawn of the back yard and planting shrubbery it will matter little if the front of the house does face the rear of the lot.

The material of which a house is built is generally, as indicated in Chapter I, an economic question; brick and stone, are, of course, preferable to wood, less exposed to currents of air and changes of temperature, and in some localities do not cost much more. Just at present, in most of the Eastern cities, brick is as cheap, if not cheaper, than wood, and, in the future, the increasing scarcity of wood will necessitate the use of these other materials, or perhaps the use of concrete, which is coming into favor. Brick and stone houses are likely to become damp, unless the walls are double; that is, the plaster must never be put directly on the wall, but an air-space must be left by "furring" (as the builders say) the lath away from the wall by strips of wood which leave a small interval between the lath and wall.

Shade-trees about a country or suburban house are important, but the great tendency in the country is to have the trees too thick and close; in villages and small towns this fault is almost universal, on account of the narrow pavement and streets. A tree should be no nearer the house than fifteen feet and should be trimmed "high"; cutting off the top, as is so often done, makes the evil worse by growing a denser shade, for every branch loped throws out two or three new ones. Nature always trims a tree from below.

### WATER-SUPPLY

Another important thing for the rural dweller, and probably the most important, is the question of water-supply; not only important to the permanent country dweller but even to the occasional city visitor, for since cities have improved their water-supplies, it has been found that the country districts are the remaining fountainheads of typhoid fever. New York City, last year, made the alarming discovery that twenty-five per cent of all its typhoid cases were directly traceable to the country—certainly alarming when we remember that this city has been spending millions for pure water to avert this very disease. The rural population is not so insignificant either, as we are accustomed to think, for just about seventy per cent of the nation, varying from twenty per cent in some of the New England States to ninety-five per cent in some of the Western States,

## 174      Outlines of Practical Sanitation

live in the country and smaller towns, where no scientific forethought is given to the subject of drinking water; in other words, something like 40,000,000 of people in the United States simply use the water most available in an economic way, ignoring completely the sanitary efficiency.

Although these rural water-supplies come from many different sources—individual wells, springs, and small streams scattered through the country—it has been found that they are very similar in one respect, namely, their utter unreliability for furnishing a suitable drinking water. Whether in Canada or in Florida, in Pennsylvania or in California, this unfitness of the rural drinking water is a striking feature.

Of the various sources of rural supply the well stands first and foremost; and too much cannot be said against the ordinary shallow well, especially when in town or village; the “town” pump is especially to be avoided (Fig. 38). The deep-drilled well in a good many districts is no better than the shallow one; in fact, I have known a deep well—the deepest in a small town—which was the most polluted in the whole locality, for the simple reason that it pierced a region of loose shale which facilitated drainage, and where, in consequence of this fact, the deeper the well the greater was the area of pollution.

In considering wells one should remember that the geological characters of the strata have much to do with the purity of the water. Some strata being exceedingly pervious, while others, for example,



the thick, heavy clay of some of our river-bottoms, are almost as impervious to water as concrete. In a region of upturned strata, like the Appalachian of Pennsylvania, and in a limestone region with its numerous caverns and underground passages, exceed-



FIG. 38.—The Town Pump—a thing to be avoided.  
(Photograph by the Author.)

ing care must be exercised, for in such localities infection may follow from some distant source. Only a careful study of a place will give positive results as to the reliability of a well-water. Better it is to study the locality thoroughly at first than to

## 176 Outlines of Practical Sanitation

carelessly sink money in the ground and perhaps harvest a crop of typhoid fever later.

Springs, which so often furnish drinking water, are just as good as their environment. If they are situated on an uncultivated and uninhabited upland they will very likely yield a pure water. Since springs are only overflows of the ground-water, their condition is dependent on the geological character of the strata through which the water passes. In a region of upturned rock-layers there may be, as in the case of wells, seepage of pollution from places little suspected, unless one is thoroughly conversant with the place. Lakes, rivers, and small streams are sources that must be carefully studied before resorting to them. The small brook especially must be carefully examined before use. It is only when such a brook comes from an uninhabited upland that it is safe and pure.

### WASTE DISPOSAL

Waste disposal is another item—it is *the* item in rural sanitation, for if all waste was properly disposed of there would be no water- nor air-pollution. In places where water-service is available, sewage and the disposal of sewage becomes a question. Unfortunately, however, water-service always precedes sewerage-service which is just the opposite of what it should be. It is the old story of the cart before the horse, and, as a consequence of this inverted arrangement, there

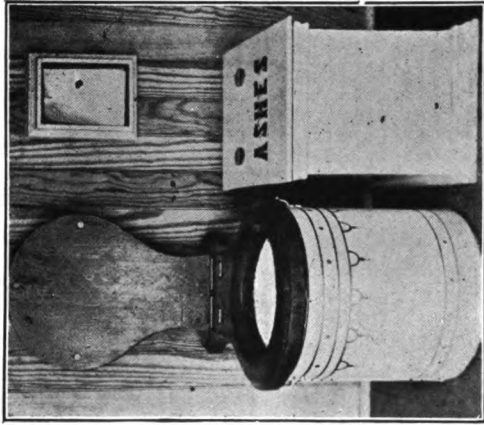
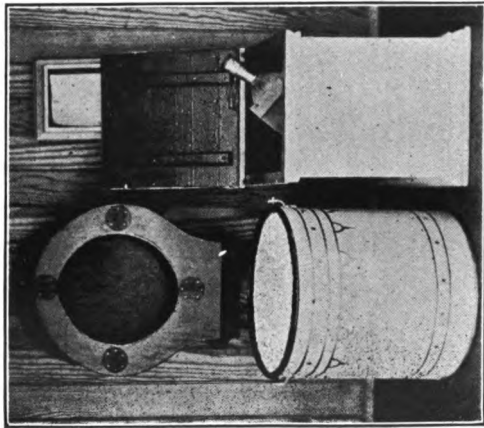

**FIG. 39.**—A Modern Dry Closet. (Photograph by the Author.)  
(From "Sanitation of a Country House.")

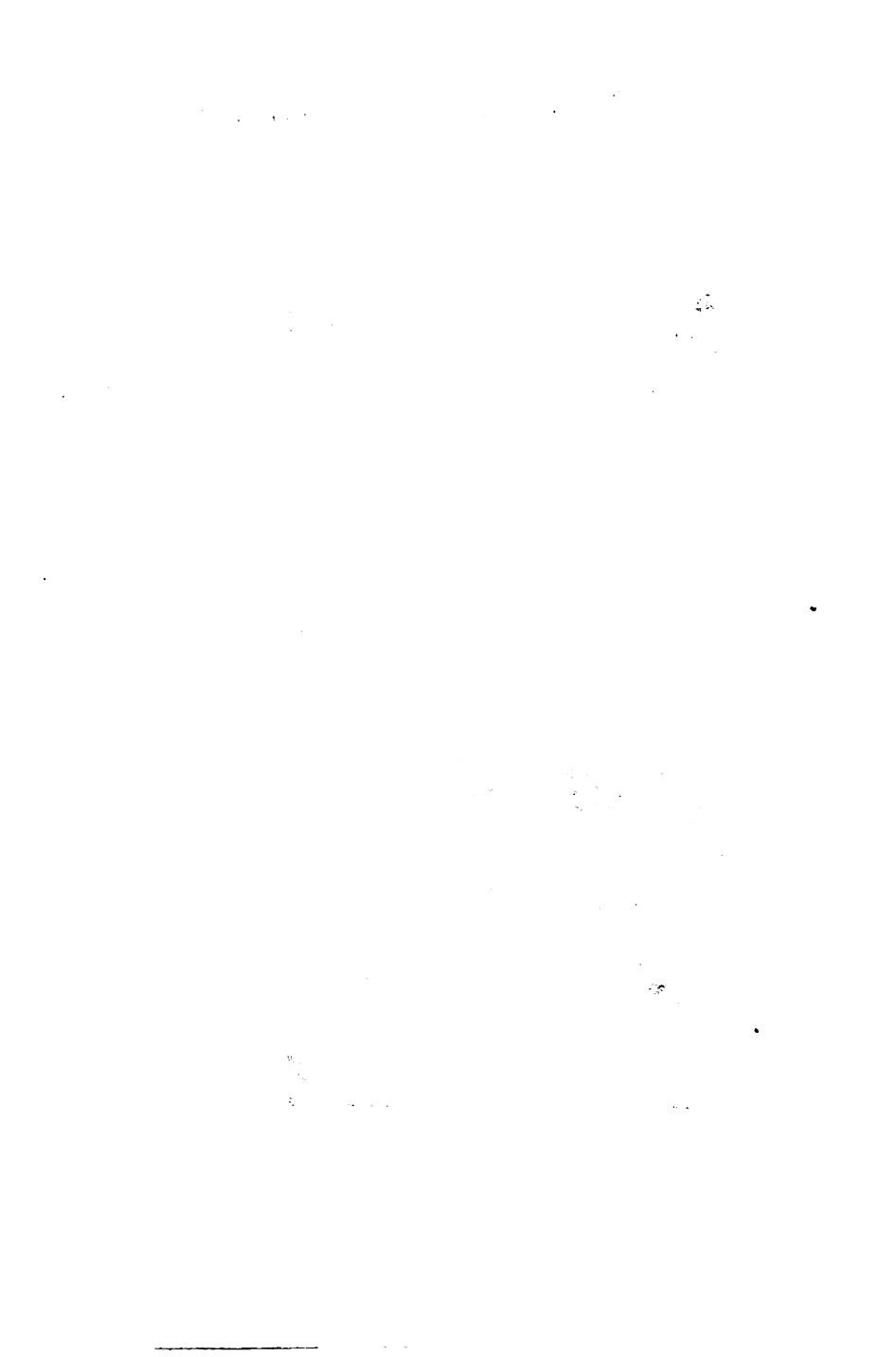

comes about the growth of the cesspool—the leaking, soil-poisoning cesspool—the growth and development of which is an interesting story. The prosperous rural dweller has been to the city and recognizes the convenience of the water-closet and bathtub and, deciding to have one of his own, engages the service of a plumber. The fixtures are put up, and then arises the question about the disposal of the sewage, for sewage it will be. The householder, perhaps, says that he will do as his city friends and run it into the sewer, forgetting that there are no sewers; but the wise plumber, who has been in such places before, helps him out of the difficulty by running the soil-pipe into the old privy, and tells him, if it gets filled, to have it emptied. In the majority of cases it will never get full, for the simple reason that most of the water will leak into the surrounding soil—incidentally perhaps into some one's well or water-pipes.

The only way to dispose of sewage from an isolated house is by some method of surface or subsoil drainage: First permitting the sewage to flow into a settling-tank where the solid particles are broken up and decomposed by bacterial action, and then discharging the resultant liquid by an automatic siphon over cultivated land or into the tiles of a subsoil-drainage system.

Where water-service is not available the right way to dispose of excreta is by means of what is known as the "dry" closet. This calls for the use of a

galvanized-iron pail and a seat exactly like that of an ordinary water-closet (Fig. 39). At the side of the seat is a box for holding the absorbent, which consists of sifted-coal ashes or dry earth. After use, a little of the absorbent is scattered in the pail, and



FIG. 40.—The Typhoid-breeder in the Country. “Man’s Back Yard and the Devil’s Cesspool (Privy).” Osler. (Photo. by the Author.)

when the pail is filled it is emptied on cultivated land—a field or a garden-bed. If the pail is emptied near the house, a little earth should be raked over the pile, and in a short time—a week or two in summer, with a corresponding increase in cold weather—all evidence of filth will have disappeared. Thus

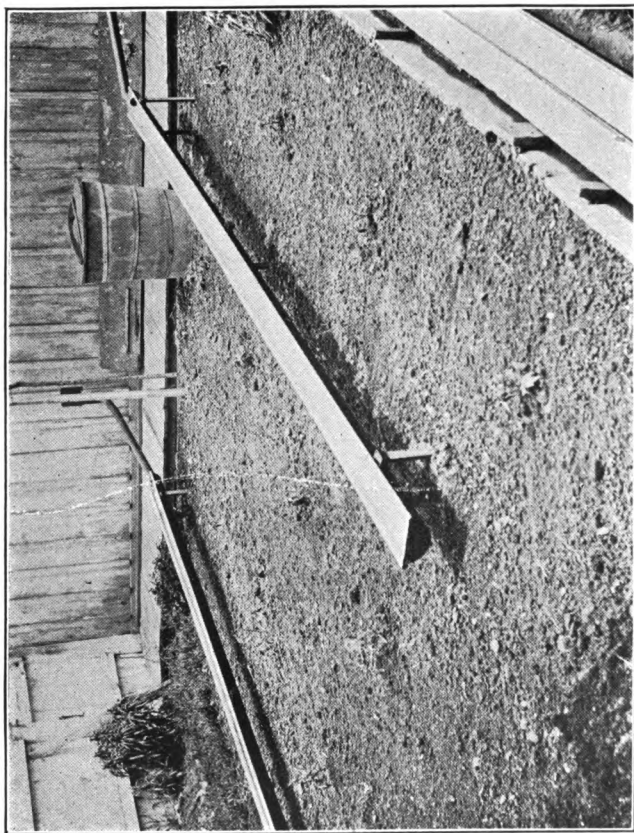
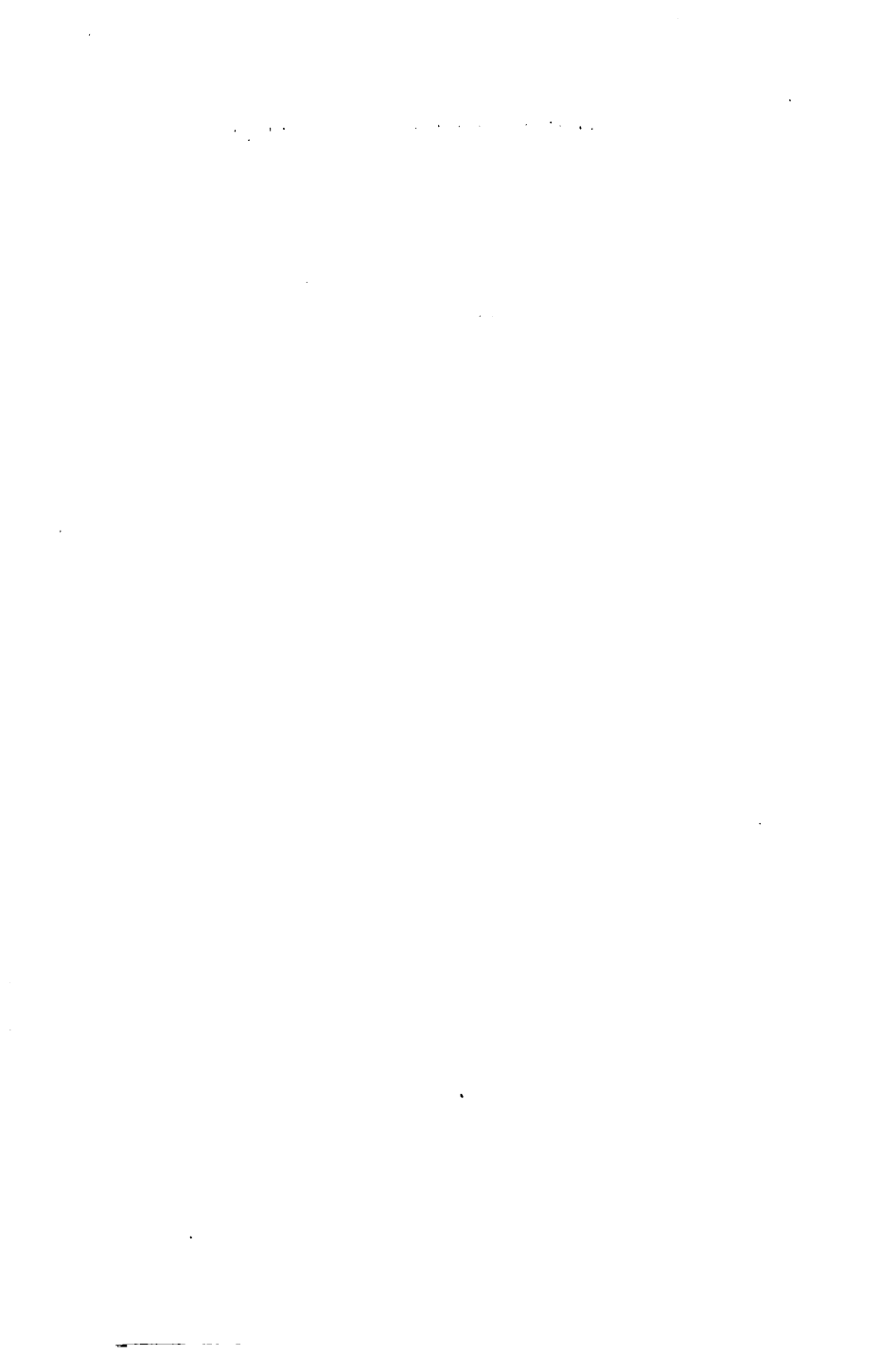

FIG. 41.—Method of suspending Surface-drains over Garden-bed.  
(Photo. by the Author from "Sanitation of a Country House.")





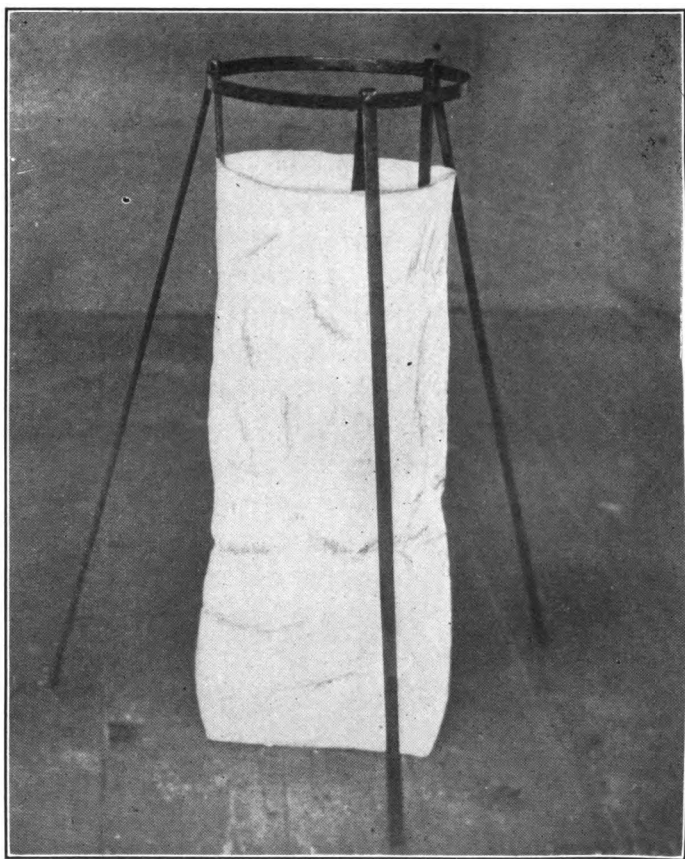

FIG. 42.—Showing Iron Rack supporting Flour-sack for Use as a Waste Receptacle. (Photograph by the Author.)



simple is the dry closet—an arrangement which, if taken proper care of, is perfectly cleanly, inodorous, and sanitary. The old country privy should not be used under any consideration. Dr. Osler is authority for saying that the cause of so much rural typhoid is “God’s country, man’s back yard, and the devil’s cess-pool (privy)” (Fig. 40). When the dry method is used we will have certain waste-waters from the bath and kitchen-sink to dispose of, and this is best done by some form of surface-drain suspended over the garden-bed. The one shown in the photograph (Fig. 41) is made of a six-inch galvanized-roof gutter, pierced every twelve inches by one-fourth-inch holes. This allows the filthy water to be distributed evenly over the ground without forming puddles and mud-holes. The solid refuse about country and village houses generally adorns the ash-pile or the alley. The disposal of these products becomes easy, if the various kinds are collected and kept separate. A good way is to have a series of receptacles for the different materials and a certain place for each one, or, perhaps, better have all these receptacles arranged together in a large box near the kitchen door. In one receptacle, which might be a flour-sack supported by an iron rack as shown in Fig. 42, we would collect the rags, paper, etc. In another, tin cans, bottles, and such rubbish; then in a suitable can the ashes, and in another the garbage—that is, the solid waste from the kitchen.

Now as to the ultimate disposal of this solid waste: the garbage is best disposed of by earth burial—

simply put into a shallow furrow in a field and covered with a little earth. If the garden-bed is near the kitchen a good way is to have a hole in the bed and practice daily disposal of the garbage. Every evening it should be covered with earth, and, in addition, a tight board-lid should cover the hole during the summer months, else the place may become a breeding-place for flies and degenerate into a nuisance. The non-combustible part of the rubbish, such as bottles, tin cans, scraps of metal, etc., can usually be sold to the junk-dealer, and the combustible part—rags and paper—if not salable, should be destroyed by fire. Ashes can be used in almost any place for filling, making paths, and for foundations under pavements.

## CHAPTER XII

### Personal Hygiene

#### HEREDITY



ONE might live under the best sanitary conditions described in the preceding pages, drinking pure water, eating pure food, and breathing pure air, yet he might be doomed to a life of sickness and an early death, for lack of knowledge of how to care for that delicately, although strongly, made machine known as the human body. Unfortunately, this machine, though “fresh from the hand of the Maker,” is often defective in many respects, and this brings up the important question of heredity; important, vastly important it is, for “blood” does tell. I do not mean the “blue blood” of a tainted and worn-out aristocracy, but the good red blood of health, derived from healthy ancestors who lived their days in sobriety and uprightness, and bequeathed to their descendants good strong hearts, elastic and healthy arteries and organs, and a constitution able to resist the inroads of disease; this is the kind of blood that does tell, and the

## 188      Outlines of Practical Sanitation

child that has this kind is highly favored among his fellows.

A certain young lady known to the author while out camping developed a catarrhal pneumonia; for a whole summer she was ill, but finally overcame the disease. To that young lady ancestry was of vital importance, for every doctor knows the course of such a disease when it attacks those who are born with a low-grade constitution, especially those prone to that terrible disease—tuberculosis.

Yet even if one is burdened with ancestral weakness much may be done to make life healthy and useful, by special care to the little details of right living. And a life begun with the best of hereditary factors may be embarrassed by ailments brought on by careless living.

### FOOD

In order to keep the body in effectual working order we need a certain amount of food. To understand properly this question we must have a clear knowledge of the composition of food, the nutrient parts of which are divided into four principal classes: protein, fats, carbohydrates, and mineral matter or salts; water, of course, while necessary for the human machinery, is simply a diluent and is not transposed into anything else.

The proteins, consisting of the albumin of eggs, the casein of milk, lean meat, gluten of wheat, etc., help to form tissue and are also broken up and used

as fuel. The fats, composed of various animal and vegetable fat, are stored up in the body as fat and are also burnt up as fuel. The carbohydrates include the various sugars and starches; they are transformed into fats and are stored up in the liver as glycogen. The mineral matters are made up of the various salts, chlorides, phosphates, etc. I have included below a table of a few of the more common foods, showing the proportions of the various nutrient ingredients.

COMPOSITION OF DIFFERENT FOODS

Food Materials.	Water.	Protein.	Fat.	Carbohy- drates.	Fuel Value, 1 Pound.
	Per Cent.	Per Cent.	Per Cent.	Per Cent.	Calories.
Sirloin. . . . .	48.3	15	16.4	.....	970
Ham. . . . .	36.8	14	36	.....	1735
Eggs. . . . .	44.6	15	1.2	.....	330
Chicken. . . . .	63.1	12.1	10.2	.....	655
Shad. . . . .	35	9.2	4.8	.....	375
Codfish. . . . .	40	16	0.4	.....	315
Oysters. . . . .	15.4	1.1	0.2	0.6	40
Milk. . . . .	87	3.6	4.0	4.7	325
Butter. . . . .	10.5	1.0	85	0.5	3615
Wheat flour. . . . .	12	11	1.1	75	1645
Oatmeal. . . . .	7.6	15.1	7.1	68.2	1850
Corn meal. . . . .	15	9.2	3.8	70	1645
Potatoes. . . . .	79	2.1	0.1	18	375

In the above table the fuel-value is the only other item that requires explanation. The food consumed in the body develops energy and this, in the form of heat, is measured by means of an apparatus called the calorimeter. "The unit used is called the caloric, and is the amount of heat which would raise the tem-

## 190 Outlines of Practical Sanitation

perature of a pound of water four degrees Fahrenheit.” (Atwater.) The amount of salts in the various foods has been omitted from the table as unnecessary to an elementary understanding of the subject.

Now in furnishing food—that is fuel—to the human body it has been found that these food-ingredients must be mixed in a certain proportion to bring about the best results; that is, one’s diet must contain a certain amount of proteid, fat, carbohydrate, and salts in the proper proportion, or else the body suffers in one way or another. It has been found, after numerous experiments, that a daily diet composed of 0.28 of a pound of proteid, 0.28 of a pound of fat, and 0.99 of a pound of carbohydrates, yielding a fuel-value of about 3500 calories, furnishes a suitable amount of daily nourishment for a man doing light muscular work; and to get this it is necessary to eat a certain quantity of meat and vegetables; for example, 12 ounces of sirloin steak, 3 ounces of butter, 28 ounces of milk, 12 ounces of potatoes, and 12 ounces of flour, (see table) yield just about the amount required and could be considered a standard

Food.	Amount.	Proteid.	Fat.	Carbo- hydrates.	Calories.
	Ounces.	Pounds.	Pounds.	Pounds.	
Sirloin.....	12	0.12	0.13	.....	725
Butter.....	3	.....	0.16	.....	680
Milk.....	28	0.06	0.08	0.08	570
Potatoes.....	12	0.01	.....	0.11	240
Flour.....	12	0.08	0.01	0.56	1235
	—	0.27	0.38	0.75	3450



daily diet for a person doing an average day's work. Thus, by knowing the amount of each food eaten and getting the nutrient values from the table, we can readily discover if any given diet is yielding sufficient nourishment.

There are other factors entering into such calculations which must be considered. I once, as noted on page 27, computed the diet tables of a certain municipal institution, with the result of showing (on paper) that the inmates were getting an ample amount of nourishment, but somewhere something was wrong, for the hospital wards held a number of cases of scurvy, and defective nutrition was marked on many a face. Investigation resulted in the discovery that the food was so badly prepared and carelessly served that it failed utterly in giving the nourishment intended.

A one-sided diet, for instance, one defective in proteids, does not sufficiently nourish the body; especially the diet of potatoes and cabbage which is so common among the poorer classes during a period of "hard times." Although such food does give a feeling of sufficiency, it does not yield nutriment enough, and the subject living on such a diet really suffers from chronic starvation, and is unable to withstand the violence of disease with anything like the power of a well-fed person. On the other hand, excessive eating is deleterious, especially excessive meat eating (which is one of our national vices), for proteid waste leaves the body by way of the kidneys and consequently an excessive meat diet tends to overtax

## 192 Outlines of Practical Sanitation

these organs, and leads, sooner or later, to degenerative changes.

The beverages, tea and coffee, while not exactly foods are valuable adjuncts which warm the stomach, produce local excitement, and consequently aid digestion; while the excessive use of either tea or coffee is to be deplored, the moderate use of either or both is without injury to most people. Children, to be sure, should not use either; the custom prevalent among certain classes of people of giving babies "coffee soup" is bad, very bad.

The use of alcohol, which is to a certain degree burnt up in the system as food, is not to be countenanced except on medical advice. Although the ordinary "drunk" makes a worse impression and gives a better moral lesson, the habitual daily drinker, the one who never gets drunk, is the one who suffers most and does his system vastly more harm, for it has been found that the daily use of even small doses of alcohol continued through the years is sure to bring on various degenerative changes which eventually lead to irreparable disease.

### EXERCISE

Exercise is necessary for the healthy action of the human body, and lack of exercise brings about lack of nutrition, wasting, and degeneration of the tissues. Exercise makes the muscles large and strong, increases the strength and power of the heart and

respiration; causes elimination of the waste carbon from the body;\* increases the appetite, because more food is needed by the muscles, and also brings about a more perfect digestion of food; it increases the amount of perspiration and causes a demand for more water.

How much exercise one should take daily is a very variable thing. A walk of 8 or 9 miles per day, or its equivalent, has been considered, from the laboratory point of view, to be sufficient. The exercise which goes with outdoor camping, tramping, hunting, and fishing is hardly likely to be overdone. Walking is probably the best routine exercise; it has the advantage of being the cheapest. Bicycle riding is splendid and exhilarating, but there is considerable likelihood of overtaxing the heart, especially in hill-climbing. Boating, swimming, skating, and horseback riding all yield healthy exercise. All exercise, however, should be indulged in with moderation; the object being to stop short of the point of fatigue; every one has experienced the restless night when he was "too tired to sleep," brought about by excessive physical exercise.

When we come to take up the study of athletics there is another tale to tell, for athletic exercise quite often means physical overexertion; this, with the muscular fatigue following it, interferes with the healthy nutrition of the various organs. With the increase of muscular development following exercise there follows also an increased development of the heart

muscle, known as cardiac hypertrophy, which is so common among those indulging in excessive exercise that it has been named "athlete's heart." Hypertrophied heart tissue, like any other, is prone to degenerate; consequently the college athlete, in fact any athlete, unless the exercise is continued in late life, is very liable to suffer from degenerative heart changes. About football there is also a word to say—football has had a bad record. Dr. Coughlin of Brooklyn recently kept a count of football casualties, and found that during one year there were 35 deaths, 500 severe injuries, and 16 cases of spinal injuries, followed by paralysis, to be attributed to this one sport. When we remember that the cardinal object in all athletics is improvement of the general health, it would seem that there should be some change in the method of playing a game which yields such a mortality rate.

#### CLOTHING

Our prehistoric ancestors invented clothing to protect the body from cold and heat and rain, and although it is a long way from the apron of fig-leaves to the present, modern garments are still made for the same purpose—the cut, shape, etc., being subsidiary points. In protecting the body from cold we have found that what is needed is not only something to keep the cold out but to keep the heat in, and for this reason we wear woollen garments, for wool, being

woven with a large mesh which contains great quantities of air is a splendid non-conductor of heat; it is also a good absorbent of moisture, hence prevents too rapid evaporation and consequent sudden chilling of the body. The only disadvantages of wool are its irritating properties and its shrinking in washing. A garment of 75 per cent wool, unless very carefully washed, will shrink to about one-half its original size; fame and fortune will surely be the lot of the man who can make an all-wool garment that does not shrink. Silk is about as good a non-conductor as wool, is soft and light, but has the disadvantage of being costly.

Cotton and linen, on the other hand, are good conductors of heat and lack the absorbent properties of wool and silk, hence they furnish the material for garments used in warm weather and in tropical climates. Linen is more durable but more expensive than cotton. When one is exposed to sudden changes of temperature or to much exercise cotton should not be worn next the skin, unless it is changed immediately after exercise, otherwise there is too rapid cooling of the body and danger of "taking cold"; cotton can take the place of wool in a certain degree if woven like wool with a very large mesh; such a garment, containing much air-space, acts more or less as a non-conductor of heat.

## BATHING

There was probably a time when humanity took no baths, as is said to be the fact to-day among the hairy Ainu—a savage tribe of Japan—“who never wash themselves from birth till death.” But for civilized man, or rather to be civilized, it is necessary to bathe at frequent intervals, not only for the sake of cleanliness, but in order to keep the pores of the skin open and their action unobstructed, for when the skin fails to do its work of elimination more work is thrown on the kidneys.

There are several rules to be observed by those who go in bathing or swimming, if they would do themselves no harm. For example, no one should remain in the water after he begins to feel chilly. This feeling of cold, of chattering teeth and blue lips is a sign of internal congestion, to continue which is a serious risk; nor should one jump into cold water feet first, for this brings on a sudden increase of blood pressure in the head, which may lead to partial unconsciousness and drowning; perhaps a good many cases of drowning caused by “cramp” may be due to this cause, or to the nausea and faintness caused by going in the water soon after eating.

The Turkish bath, which requires only brief mention, consists of a dry hot-air bath at the temperature of 120° to 170° F. for ten or fifteen minutes; after this a hot shower-bath, followed by a thorough

scrubbing with soap, and a warm shower gradually changing to a cold one. The Russian bath is much the same except that moist air (steam) at 150° F. is used for the first bath instead of dry air. Both of these baths cause excessive perspiration and thorough action of the skin, and are of much value as a means of cleanliness, but should not be indulged in too frequently nor too long at a time.

It is interesting to note in this connection that many of the wild Indian tribes of North America used the hot steam-bath as a remedial measure. Heckewelder says that "the sweat-lodge is the first thing an Indian has recourse to when he feels indisposed." Overburdened with rheumatic complaints, as we know they were, it is no wonder they had great faith in this bath. Though only consisting of a closed lodge, some hot stones, and a dish of water, with perhaps a hot decoction of some native roots, it answered well the needs of a primitive and exposed life.

#### THE SIMPLE LIFE

The essential part of a good deal of personal hygiene may be summed up in the "simple life," as depicted by Pastor Wagner, John Burroughs, John Muir, and a host of other writers and thinkers. The strenuous life of a frontier sheriff, the political turmoil of the giddy office-seeker, the wild scramble and greed for gold, all these exhaust and wear out an overtaxed

## 198      Outlines of Practical Sanitation

nervous system, react on digestion, and may finally shorten a useful life.

The rush and the hurry and the bustle of Broadway at noon I do love to see sometimes, but it is, nevertheless, the "pace that kills." We can keep it up for a time, but rest must come—rest and relaxation—if we expect the human machinery to continue. It is easier to do twelve months' work in eleven months than to do twelve months' work in twelve months, some one has aptly said. The overworked man or woman would do well to read, and ponder over, that delightful book "A Journey to Nature," by J. P. Mowbray.

The continual excitement and nervous strain of excessive social pleasures: late dinners, later to bed, luxurious ease, and a listless life; Colonial Dames and King's Daughters; living on the small talk of the world instead of good bread and butter; this, too, is the "pace that kills"—kills motherhood, the glory of woman.



# INDEX

---

	PAGE
Actinomycosis. . . . .	142
Air, examination of. . . . .	20
sewer. . . . .	5
Air-space. . . . .	13
Albany filter-plant. . . . .	41
Alcohol, use of. . . . .	192
Algæ, copper treatment of. . . . .	47
Alto, Mt. . . . .	128
Altoona, Pa. . . . .	111
American Public Health Association, quoted. . . . .	47, 127
Ammonia, albuminoid. . . . .	51
free. . . . .	51
Anthrax. . . . .	138, 142
Arnold process. . . . .	68
Artesian wells. . . . .	32
Ashes, disposal of. . . . .	71, 186
Asylums. . . . .	26
Athletics. . . . .	193
<i>Bacillus coli</i> . . . . .	53
<i>tuberculosis</i> . . . . .	127
<i>typhosus</i> . . . . .	54, 129
Back yard, the. . . . .	23
Bacteria, aerobic. . . . .	61, 64
anaerobic. . . . .	61, 64
Bath, Russian. . . . .	197
Turkish. . . . .	196
Bathing. . . . .	196

	PAGE
Bathroom, a model.....	6
Baths, public.....	157
Roman.....	157
Bell, Dr., quoted.....	11, 12, 89
Births, registration of.....	142
Boom's test.....	20
Boston.....	68
Bread.....	85
alum in.....	94
Breslau, method of.....	122
Brooklyn.....	153
Bucke, R. M., quoted.....	60
Burroughs, John, quoted.....	197
Butler, Pa.....	46
California.....	174
Canada.....	174
Car sanitation.....	109
Carbon dioxide.....	12, 20, 21
Cars, cleaning of.....	110
furnishing of.....	110
heating of.....	111
ventilation of.....	111, 112
Catlin, George, quoted.....	120
Celli, quoted.....	130
Cerebrospinal fever.....	125
Chadwick, Edwin, quoted.....	105
Chicken-pox.....	142
Chocolate.....	93
Cholera.....	132, 142
Cincinnati.....	44
Clark process.....	39
Clothing.....	194
Cocoa.....	93
Coffee, use of.....	192
Comma bacillus.....	132
Connecticut, death-rate in.....	144
Contact-filters.....	64
Cottonseed-oil.....	93
Coughlin, Dr., quoted.....	194
Cows, the.....	75, 76

# Index

201

	PAGE
Cow-stable, a model. . . . .	79
Cremator, Engle. . . . .	69
Dakota. . . . .	33
Death-rate . . . . .	144
typhoid. . . . .	145
Deaths, registration of. . . . .	143
De Fœe, quoted. . . . .	137
Delaware River. . . . .	58
Diet, a standard. . . . .	190
Diphtheria . . . . .	2, 74, 123, 142
antitoxin in. . . . .	124
Diseases, contagious and infectious. . . . .	119
registration of. . . . .	142
Disinfection, gaseous. . . . .	122
Drinking-fountain. . . . .	100
Drinking-water. . . . .	115
Dry closet, the. . . . .	179
construction of. . . . .	180
disposal of contents of. . . . .	180
for cars. . . . .	115
for schools. . . . .	103, 104
Dudley, Dr., quoted. . . . .	111
Dwellings, rural. . . . .	167
Dysentery. . . . .	143
Egbert, quoted. . . . .	20, 106
Ehrlich, Prof., quoted. . . . .	86
Erysipelas. . . . .	143
Excreta, disposal of. . . . .	113
Exercise . . . . .	192
amount of. . . . .	193
Expectoration, public. . . . .	118, 165
Filter-beds, covered. . . . .	44
Filters, contact. . . . .	64, 65
Filtration, American. . . . .	45
continuous. . . . .	43
domestic. . . . .	46
intermittent. . . . .	44, 61, 65
rapid. . . . .	45

	PAGE
Fish.....	90
Flies.....	131
Florida.....	174
Foods, adulteration of.....	92
cold-storage.....	92
composition of.....	188, 189
Food-supplies.....	85
Foundations.....	2
construction of.....	2, 171
Fruit, California.....	89
Fruits.....	86
Garbage, burying of.....	67
cremation of.....	69, 72
disposal of.....	66, 185
dumping of.....	67
feeding of.....	67
reduction of.....	68, 72
Glanders.....	139, 143
Goodell, quoted.....	106
Grass, John, quoted.....	129
Ground-air.....	170
composition of.....	170
movement of.....	170
Ground-moisture.....	168
and rheumatism.....	169
and phthisis.....	169
Ground-water.....	169
and typhoid fever.....	170
Habitations.....	1
construction of.....	1
Haffkine, serum of.....	137
Harrisburg.....	45
Havana.....	136
Hazen, Allen, quoted.....	44
Heating, by direct-indirect radiation.....	17
by indirect radiation.....	17
hot-air.....	15
hot-water.....	16
of large buildings.....	19
steam.....	16

	PAGE
Heckewelder, quoted.....	197
Heredity.....	187
Hering, Rudolph, quoted.....	68
Hospitals.....	24
House-drain.....	4
House-trap.....	4
Howard, John.....	26
Howard, L. O., quoted.....	131
Hydrophobia.....	138, 143
treatment of.....	138
Hygiene, personal.....	187
Ice, handling of.....	116
Ice-supplies.....	54
Illumination, artificial.....	21
Incinerator, Thackeray.....	69
Irrigation, broad.....	58, 65
Island, Manhattan.....	150
Lakes.....	37
Lard.....	93
Lawrence, Mass.....	44
Lee, Dr., quoted.....	120
Leprosy.....	143
Life, the simple.....	197
Loeffler, bacillus of.....	123
Lytton, Lord, quoted.....	158
Macaulay, quoted.....	148
Malarial fever.....	132, 143
Mason, quoted.....	47
Massachusetts, death-rate in.....	144
Measles.....	122, 143
German.....	143
Meat.....	90
Milk.....	80
adulteration of.....	83
aeration of.....	80
bacteriological examination of.....	82
chilling of.....	80
distribution of.....	80
transportation of.....	80

	PAGE
Milkers, the.....	79
Milk-supply.....	74
Mississippi River, the.....	37
Montreal.....	71
Mosquito warfare.....	133
Mosquitoes, malarial.....	134
Mowbray, J. P.....	198
Muir, John, quoted.....	34, 197
Mumps.....	143
New Jersey.....	67
New Orleans.....	136
New York City... 2, 67, 68, 71, 72, 82, 107, 153, 161, 173	173
New York, death-rate in.....	144
Nuisance, the smoke.....	161
the spitting.....	165
Oleomargarine.....	93
Olive-oil.....	93
Open fireplace.....	14
Osler, Dr., quoted.....	185
Overcrowding.....	150
Oysters.....	90
opening of.....	90, 91
Panama.....	136
Parks, public.....	160
Pasteur treatment.....	138
Pennsylvania.....	30, 75, 94, 140, 174
Department of Health, quoted.....	142
Philadelphia.....	44
Phthisis.....	1
Pittsburg.....	44
Plague, the.....	137, 142
the Great White.....	151
Playgrounds.....	160
Plumbing.....	4
peppermint test for.....	10
sanitary.....	4
Plymouth, Pa.....	55
Pneumonia.....	143

# Index

205.

	PAGE
Precipitation, chemical. . . . .	01
Preservative, salicylic acid as a. . . . .	94
sodium sulphite as a. . . . .	94
Prisons. . . . .	26
Privy, the country. . . . .	185
"Public Water-supplies," quoted. . . . .	37
Puerperal fever. . . . .	143
Pump, the "town" . . . . .	174
Push-cart, the. . . . .	89, 91
Rain-bath, the. . . . .	158
Reading, sewage filtration at. . . . .	62
Relapsing fever. . . . .	143
Rheumatism . . . . .	1
muscular. . . . .	1
Riis, Jacob A., quoted. . . . .	151
Rivers. . . . .	37
Room, disinfection of a. . . . .	121
Rothrock, Dr. . . . .	128
Rubbish, disposal of. . . . .	71, 185
Sand filtration. See Filtration.	
"Sanitarian," quoted. . . . .	89, 100
Sanitation, car. . . . .	109
municipal. . . . .	147
rural. . . . .	166
school. . . . .	95
suburban. . . . .	166
San Francisco. . . . .	71, 72
Scarlet fever. . . . .	74, 123, 143
School children, seating of. . . . .	96
Scholarship. . . . .	105
Schools, medical inspection of. . . . .	106
overwork in. . . . .	105
playgrounds for. . . . .	106
privy for. . . . .	103
water-supply for. . . . .	100
Schoolrooms, heating of. . . . .	97
lighting of. . . . .	99
ventilation of. . . . .	97, 98
Sewage . . . . .	56

	PAGE
Sewage, chemical precipitation of . . . . .	61
dilution of . . . . .	58
disposal of . . . . .	58
farming . . . . .	58
intermittent filtration of . . . . .	61
Sewerage systems . . . . .	56, 57
Shade-trees . . . . .	173
Shakespeare . . . . .	148, 167
Smallpox . . . . .	120, 143
among the Indians . . . . .	120
Smith, Theobald, quoted . . . . .	132
Soil-pipe . . . . .	4
Springs . . . . .	33, 176
Stable, the . . . . .	76
air-space of . . . . .	76
cleaning of . . . . .	77
ventilation of . . . . .	76
Stoves . . . . .	14
oil- and gas- . . . . .	15
Statistics, vital . . . . .	140
Steam-bath among Indians . . . . .	197
St. Louis . . . . .	44
Stratford-on-Avon . . . . .	148
Streams . . . . .	33, 34
Street-cars . . . . .	116
cleaning of . . . . .	118
disinfection of . . . . .	118
heating of . . . . .	117
overcrowding of . . . . .	117
ventilation of . . . . .	118
Street cleaning . . . . .	154
Street-sweepings, disposal of . . . . .	71
Susquehanna River . . . . .	58
Tank, septic . . . . .	64, 65
Tea . . . . .	93
use of . . . . .	192
Tetanus . . . . .	139, 143
Theatres . . . . .	27
Trachoma . . . . .	107, 143
Trichiniasis . . . . .	143



# Index

207

	PAGE
Tuberculosis .....	74, 126, 143
among Sioux Indians .....	128
camps .....	126, 127
Turneure and Russell, quoted .....	37, 39, 40, 44
Typhoid fever .....	30, 34, 47, 55, 74, 129
death-rate of .....	41, 145
flies as disseminators of .....	130
sick-rate of .....	145
Typhus fever .....	125
Urinal, a sanitary .....	28, 29
Utensils, milking .....	79
Vaccination .....	120
Vegetables .....	86
greening of .....	93
Venice .....	148
Ventilating pipe .....	6
Ventilation .....	11
King system of .....	76
Vents, foul-air .....	19
Wagner, Pastor .....	197
Waste, collection of .....	65, 66
disposal of .....	56
liquid .....	56
solid .....	65
Water, bacteriological analysis of .....	53
character of .....	32
chemical analysis of .....	48
hardness of .....	39
purification of .....	41
quality of .....	38
quantity of .....	38, 39, 40
storage of .....	40
Water-closets .....	10, 103
pan .....	9
plunger .....	10
valve .....	9
wash-down .....	9
wash-out .....	10

	PAGE
Wash-stand.....	6
Water-supplies .....	30
rural.....	174
sanitary survey of.....	47
source of.....	31
Waring, Col., quoted.....	65, 155, 157
Warren, Dr.....	94
Wells .....	31, 174
Artesian .....	32
drilled.....	32
Whooping-cough.....	123, 143
Wolpert's method.....	20
Yellow fever .....	135, 143
and mosquitoes.....	135
Yersin, serum of.....	137

