

WIRELESS TELEGRAPHY AND TELEPHONY

WILEY-INTERSCIENCE
A JOHN WILEY & SONS, INC. PUBLICATION

D. MAZZOTTO

Cornell University Library

BOUGHT WITH THE INCOME
FROM THE
SAGE ENDOWMENT FUND
THE GIFT OF
Henry W. Sage

1891

A. 20036.4

23/2/1906

Cornell University Library
arV18677

Wireless telegraphy and telephony.



3 1924 031 240 280
olin,anx

- Elliott's Gas and Petroleum Engines, 2s. 6d.
 — Industrial Electricity, 2s. 6d.
 Engineer Draughtsmen's Work, 1s. 6d.
 — Fitting, Horner, 5s.
 — Locomotive, McDonnell, 1s.
 Engines, Model, Alexander, 6s. net.
 English and American Lathes, Horner, 6s.
 Experiments with Vacuum Tubes, Salomons, 2s.
 — Electrical, Bonney, 2s. 6d.
 Explosives, Manufacture of, Guttman, 2 vols. 2l. 2s.
 Farley's Cellar Book, 1s. 6d.
 Farman's Auto Cars, 5s.
 Farrow's Specifications for Building Works, 3s. 6d. net.
 — Stresses and Strains, 5s. net.
 Field Work and Instruments, Walmisley, 6s. net.
 Findlay's Railway Working, 7s. 6d.
 Fitting, Engineer, Horner, 5s.
 — Electric, Maycock, 6s.
 — Electric Light, Allsop, 5s.
 Fletcher's Architectural Hygiene, 5s. net.
 — Carpentry and Joinery, 5s. net.
 — Steam-Jacket, 1s. 6d.
 Foden's Mechanical Tables, 1s. 6d.
 Friction and its Reduction, Wheeler, 3s. net.
 Galvanic Batteries, Bottone, 5s.
 Garratt's Modern Safety Bicycle, 3s.
 Gas and Gas Fittings, Hills, 5s. net.
 Gas and Petroleum Engines, 2s. 6d.
 Gaseous Fuel, Thwaite, 1s. 6d.
 Gay and Yeaman's C. S. Electricity Supply, 10s. 6d. net.
 Gearing, Helical, Horner, 5s.
 Geography, Bird, 2s. 6d.
 Geology, Jukes-Browne, 2s. 6d.
 Geometrical Optics, Blakesley, 2s. 6d. net.
 Gibbings' Electricity Supply, 6s.
 Gray's Electrical Influence Machines, 5s.
 Greene's Saints and their Symbols, 3s. 6d.
 Greenwell and Elsdon, Road Construction, 5s. net.
 Griffiths' Manures, 7s. 6d.
 Guttman's Manufacture of Explosives, 2 vols., 2l. 2s.
 Guttman's Percentage Tables for Analysis, 3s. net.
 Harris' Practical Chemistry, 3 vols. 4s.
 Hatch's Mineralogy, 2s. 6d.
 Hatton's Mathematics, 2s. 6d.
 Hawkins' and Wallis's Dynamo, 15s.
 Heat Engines, Anderson, 6s.
 Helical Gears, Horner, 5s.
 Herbert's Telegraphy, 6s. 6d. net.
 — Telephone System of the Post Office, 3s. 6d.
 Hering, Electric Railways, 4s. 6d. net.
 Hertzian Waves and Wireless Telegraphy, Bottone, 3s.
 Hewitt's Organic Chemical Manipulation, 4s. 6d.
 Hills' Gas and Gas Fittings, 5s. net.
 Hobart's Electric Motors, 12s. 6d. net.
 Hobart and Steven's Steam Turbine Engineering.
 Hobart and Turner's Insulation of Electric Machines, 10s. 6d. net.
 Hobbs' Electrical Arithmetic, 1s. net.
 Hoblyn's Medical Dictionary, 10s. 6d.
 Horner's Helical Gears, 5s.
 — Iron-founding, 3s. 6d.
 — Lathes, 6s.
 — Metal Turning, 3s. 6d.
 — Pattern Making, 3s. 6d.
 — Principles of Fitting, 5s.
 Houston's Electrical Measurements, 4s. 6d. net.
 — Electricity and Magnetism, 2s. 6d.
 — Transmission of Intelligence, 4s. 6d. net.
 Hurter's Alkali Makers' Handbook, 10s. 6d.
 Hutton's Mathematical Tables, 12s.
 Hydraulic Motors and Turbines, Bodmer, 15s.
 Hygiene, Architectural, Fletcher, 5s. net.
 Indicator Handbook, Pickworth, 2 vols. 3s. each, net.
 Induction Coils, Bonney, 3s.
 — Motors, Hobart, 12s. 6d. net.
 Industrial Electricity, 2s. 6d.
 Insulation of Electric Machines, Turner and Hobart, 10s. 6d. net.
 Iron and Steel Structures, Twelve-trees, 6s. net.
 Ironfounding, Horner, 3s. 6d.
 Italian Dictionary, Baretta, 21s.
 — Technical Dictionary, Webber, 4s. net.
 Jukes-Browne's Geology, 2s. 6d.
 Kapp's Electric Transmission of Energy, 10s. 6d.

WIRELESS TELEGRAPHY AND
TELEPHONY

.

WHITTAKER'S PRACTICAL HANDBOOKS.

- BONNEY, G. E. Induction Coils. 3s.
BOTTONE, S. R. Electrical Instrument Making. 3s. 6d.
 " Electric Bells. 3s.
 " Electro Motors. 3s.
 " Galvanic Batteries. 5s.
 " Radiography and X Rays.
 " Radium. 1s. net.
 " Wireless Telegraphy. 3s.
CHAMBER, G. F. Astronomy. 1s. net.
CRAPPER, E. H. Electrical Measurements. 2s. 6d.
GRAV, J. Electrical Influence Machines. 5s.
HERBERT, T. E. Telegraphy. 6s. 6d. net.
 " Telephone System of the British Post Office. 3s. 6d.
LODGE, SIR O. Lightning Conductors and Lightning Guards. 15s.
MAYCOCK, W. P. Alternating-Current Circuit and Motor. 4s. 6d. net.
 " Electric Wiring, Fittings, Switches and Lamps. 6s.
 " Electric Lighting and Power Distribution. Vol. I.
 6s. ; Vol. II. 7s. 6d.
 " Electric Wiring Tables. 3s. 6d.
OWEN, W. C. Telephone Lines and Methods of Constructing Them.
 5s.
POOLE, J. Practical Telephone Handbook. 6s. net.
WEBB, H. L. The Telephone Service. 1s. net.
WHITTAKER'S Electrical Engineers' Pocket Book. 3s. 6d. net.
-

WHITTAKER & CO., 2 White Hart Street, LONDON, E.C.

WIRELESS TELEGRAPHY AND TELEPHONY

BY PROF. DOMENICO MAZZOTTO

TRANSLATED FROM THE ORIGINAL ITALIAN BY
S. R. ^{selimov} ~~omnes~~ _T BOTTONÉ

WITH 253 ILLUSTRATIONS

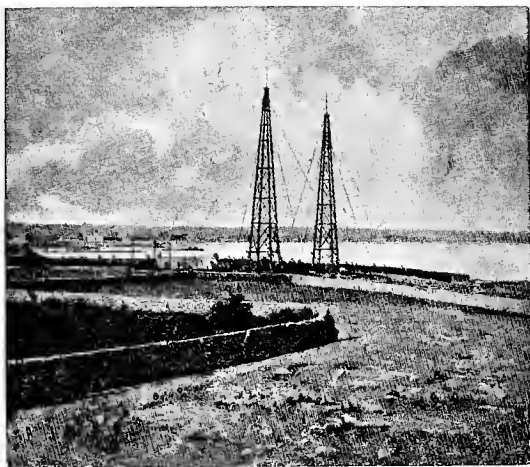

THE RADIOTELEGRAPHIC STATION OF ST. CATALDO (BARI)

WHITTAKER & CO.

2 WHITE HART STREET, PATERNOSTER SQUARE, LONDON, E.C.
AND 64 AND 66 FIFTH AVENUE, NEW YORK

1906

D

GLASGOW : PRINTED AT THE UNIVERSITY PRESS
BY ROBERT MACLEHOSE AND CO. LTD,

PREFACE

IT is with feelings of real pleasure that the translator presents this work, done into English, to the English reader. Prof. Mazzotto has executed his task so thoroughly as to leave no important facts or theories connected with Radiotelegraphy unnoticed; and has clothed his thoughts in language at once so simple, so clear, and so forcible, as to render the comprehension of the subject easy to the merest tyro. The writer feels that some of the beauty of the style must inevitably have been lost in translation; but he trusts that he has been able to keep as nearly to the original as the difference of idiom would allow.

S. BOTTONE.

WALLINGTON, 1906.

CONTENTS

	PAGE
INTRODUCTION,	x
CHAPTER I.	
GENERAL NOTIONS ON WIRELESS COMMUNICATIONS,	1-7
CHAPTER II.	
WIRELESS TELEGRAPHY BY CONDUCTION,	8-21
Transmission across Water—Morse and Lindsay's Experiments—Smith's, Highton's, Barbouse and Rathenau, and Rubens' Systems—Communications through Ground—Steinheil and Michel Systems—Strecker, Orling, and Armstrong's Experiments—Maiche's System.	
CHAPTER III.	
WIRELESS TELEGRAPHY BY INDUCTION,	22-42
Applications of Electro-static Induction—Applications of Electro-dynamic Induction—Electro-static and Smith and Edison's System—Dolbear's System—Other forms of Edison's System—Kitsee's, Tesla, Electro-dynamic, Trowbridge, Phelps and Woods-Adler and Eversted-Lennet Systems—Preece's Experiments—Syntonised System of Lodge.	
CHAPTER IV.	
RADIOPHONIC SYSTEM,	43-54
Experiments and Applications—Bell-Tainter Radiophone—Mercadier Radiophone—Simon and Reich's Radiotelephone—Ruhmer's Radiophotophone—Clausen and van Bronck's Radiophone.	

CONTENTS

vii

CHAPTER V.	PAGE
ULTRA-VIOLET AND INFRA-RED RADIATION SYSTEMS, Zickler's Apparatus—Sella's and Dussand's Systems.	55-64
CHAPTER VI.	
WIRELESS TELEGRAPHY BY ELECTRIC WAVES,	65-95
Production of Electric Waves—Herz, Marconi's and Lecher's Oscillators—Propagation of Electric Waves—The Recep- tion of Electric Waves—Syntony and Damping—The Influence of Daylight.	
CHAPTER VII.	
RADIO-TELEGRAPHIC APPARATUS,	96-215
Sources of Energy—Keyboards—Automatic Transmitters— Coils and Contact Breakers—Ruhmkorff Coil—Unipolar Transformer—Dry Contact Breaker—Foucault, Lodge- Muirhead, Rotary or Turbine, Wehnelt, and Cooper- Hewitt Breaks—Converters—Exciters and Oscillators— Righi-Marconi and Tissot's Oscillators—Ruhmkorff, Arm- strong-Orling, Slaby-Arco, and Fessenden Exciters— Antennae Radiators and Sky Rods—Popoff Antennae, Radiators, and Sky Rods—Popoff Antenna—Marconi Sky Rod—Multiple Sky Rods—Aerial Pavilions—Ultra- powerful Radiators—Antennae and Concentric Cylinders —Antennae for Directed Waves—Artom Radiator —Magni's System—Radiators without Antennae—Con- nections to Earth—Transformers—Marconi-Kennedy Receiving Transformers—Marconi's Transformer for Sending Apparatus—Braun's, Tesla, and Oudin and d'Arsonval Transformers—Braun Condensers—Slaby-Arco Condenser—Condenser at Poldhu—Syntonisers—Portable Syntonising Coil—Doenitz Wave Measurer—Wave De- tector—The Coherer—History of the Discovery—Theory —Practical Notions—Types—Ordinary Coherers with Filings—Lodge's, Marconi, Slaby, Blondel, Ferrié, Ducretet's, Rochefort's, Magnetic, Tissot's, Braun's, Simple Contact, Orling and Braunerhjelm's, Popoff-Ducretet's, and Branly Coherers—Mechanical and Magnetic Deco- herers—Coherers with Spontaneous Decoherers—Hughes', Tommasina Telephonic, Popoff, "Italian Navy," Lodge's	

Self, and Dorman Coherers—Anti-Coherers—Schaeffer's Plate—De Forest's and Smithe's Responder—Rutherford, Wilson, Marconi, Tissot's, Ewing-Walter, and Arno Detectors—Fessenden's Thermic Revealer—Walton, Armors, and Placher's Revealers—Sensibility of Revealers—Relays—Polarised Relays—Movable Coil Relay—Other Types—Hughes Printer—Other Printing Receivers—Lodge-Muirhead Recorder—Repeaters—Cole-Cohen, Guarini, Armors Systems.

CHAPTER VIII.

ON THE VARIOUS SYSTEMS OF RADIO-TELEGRAPHY, 216-307

Generalities—The Marconi Systems—Apparatus with Reflectors—With Radiating Laminae—Connected to Earth—With Antennae—Double Stations—Receivers in which the Antennae are Insulated from the Coherer—Syntonic Apparatus having Concentric Cylinders—Portable Stations—Ultra-powerful Apparatus—Arrangement of the Apparatus—Sending Station—Receiving Station—Syntonic Induction—Electric Wave Syntonic and Lodge-Muirhead New Apparatus—Apparatus for Military Use—Braun's Systems—Transmissions through Water—Principles of his Method—Apparatus Requisite—Practical Experiments—Aerial Transmission—Fundamental Innovations—Principal System—Other Modifications—Practical Arrangements—Radio-Telegraphic Apparatus for Field Work—Parabolic Radiator System—Slaby-Arco System—Principles of the System—Syntonised Systems—Transmitting and Receiving Apparatus—Popoff-Ducretet, Fessenden, De Forest's, and various Systems—Rochefort, Tissot, Popp-Pilsoudski, Guarini, Cervera, Armors, Preece, Schaeffer, Blochmann, Tesla-Stone, Artom, Duddell-Campos, Cooper-Hewitt, Valbreuze, and "Telefunken" Systems.

CHAPTER IX.

SYNTONY AND SELECTED INTER-COMMUNICATIONS, 308-330

Syntonisation, Blondel's, Stone's, Anders Bull's, Walter's, Hughes', Multi-communication, Slaby-Arco's, Marconi, Tommasi's, Jegou's, Magni, and Cohen-Cole Systems.

CONTENTS

ix

CHAPTER X.

PAGE

PRACTICAL EXPERIMENTS AND APPLICATIONS, 331-387

Marconi's, Lodge and Muirhead's, Slaby's, and Schaeffer's Experiments—First Experiments with Syntonised Apparatus—Braun's Trials—Slaby's and Marconi's Patents—Guarini and Poncelet's and First Transatlantic Experiments—Transatlantic Communications—Marconi's and other Radiographic Campaigns—Fresh Experiments—Wireless Telegraphy in the Italian Navy—Italian Radiographic Service—Bari-Antivari's Service—Ultra-powerful Station of Coltano.

CHAPTER XI.

WIRELESS TELEPHONY, 388-398

Gavey and Preece's, Ducretet and Maiche's, and Ruhmer's Experiments—Systems worked by Electric Waves—Placher's Receiver—Lonardi's, Collins', Russo d'Asar's, Capeder-Telesca's, Pansa, Campos, De Forest, and Majorana's Systems.

CHAPTER XII.

VARIOUS APPLICATIONS AND CONCLUSIONS, 399-409

Over-sea Communications—Application to Meteorology—Overland Communication—Messages between Trains in Motion—Communications in Mountainous Regions with Balloons—Military Telegraphy—Mechanical Applications—Physiological Applications—Concluding Remarks.

INDEX, 410

INTRODUCTION

TOWARDS the end of 1896 the Press spread the tidings that a young Italian had invented a system of telegraphy which did away with the use of conducting wires between the receiving and sending stations. This news immediately awakened great interest in the mind of the public, and in a lesser degree in that of the technical and scientific world. The first, with that credulity which distinguishes it, caused partly by imperfect knowledge of that which the actual state of science permits us to retain as possible, and partly by the so-called miracles which science and its applications have enabled us to accomplish under its eyes, without any further investigation received this news as the announcement of a result actually obtained and of unlimited applicability, by the aid of which the vast network of telegraphic lines which girdle our globe in every direction, passing over all the means of communication, surmounting the highest points, and penetrating the profound abysses of the ocean, could be done away with as useless incumbrances.

The scientific and technical world received this news with less enthusiasm. Accustomed to the almost daily announcement of extraordinary discoveries, which visionaries circulate in order to fill the columns of some papers and to satisfy the public in its morbid avidity for sensational news, which, if they had generally some slight foundation in a real scientific result, are enormously exaggerated, as to its

consequences, scientists and technical men err naturally in the direction of scepticism, and therefore received the announcement of the discoveries with much reserve, if not with diffidence, the more so, as the principles on which his invention is based were jealously guarded. However, the results obtained in London by the young Italian, who was afterwards known to be G. Marconi, were too strong to allow his discovery to be confused with any one of the many pseudo-scientific fantasticalities; so that, having recognised that they had to deal with a scientific fact, they immediately applied themselves to the task of ascertaining, notwithstanding the mystery which shrouded the discovery, the means by the aid of which Marconi had been able to obtain the results announced.

* Those who had gone more deeply into the question quickly came to the conclusion that they had to deal with an application of electric waves, which had entered into the domain of science a few years before; and which, from their nature being recognised as identical with that of light, were eminently adapted to communication at a distance. This was sufficient to put some of them, such as Lodge in England, Ascoli in Italy, etc., in a position to construct immediately apparatus which reproduced the experiments of Marconi, an apparatus which was then recognised as being identical in principle to the one of Marconi itself. However, if at that moment the scientific solution of the problem of wireless telegraphy with electric waves was already sufficiently matured that the bare announcement sufficed to enable others to grasp it without further experiments, it was not so as regards the practical problem, that is to say, of carrying such a communication to great distances, and that, which is much more difficult and important, of rendering the stations independent the one of the other, in such a way that any one of them could alone communicate to any determined

station without disturbing the communications which might pass between two other stations without being disturbed by them. Without this proviso wireless telegraphy could never have had extended applications.

We will describe the improvements which from time to time have been introduced in the primitive apparatus by Marconi and others, with the hope of obtaining these two last results. We shall see that if it was comparatively easy to resolve the problem of distance, having succeeded by dint of successive improvements and strengthening the apparatus to traverse the Atlantic Ocean by means of radio-telegraphic communications, success was only imperfect in the resolution of the other problem, viz., that of multiplex communications, notwithstanding that the ability and the energy of the experimenters, the almost inexhaustible resources furnished by scientific progress, and the abundant means provided by Governments and capitalists, have joined together all their forces in order to obtain its complete solution.

The object of this present little work is to lay before the reader as simply as possible the principles on which the new system of signalling is founded, and to make known the apparatus which are necessary in order to effect it, the disposition of these in the stations, and to follow step by step the progress realised by the different inventors who have devised special systems of radio-telegraphy, and farther to trace chronologically the progress which has been made in radio-telegraphic signalling from the first experiments of Marconi at Bologna down to the last results of trans-Atlantic radiophony.

In conclusion, we shall give a glance at the actual state of radio-telegraphy, discussing the services that it already renders, and the hopes that may be entertained of its larger applications in future.

CHAPTER I.

GENERAL NOTIONS ON WIRELESS COMMUNICATIONS.

ALL signalling at a distance necessitates the use of three distinct parts; the device which produces the signal, that which carries it, and that which receives it. These three essentials we may call respectively the sender, the line, and the receiver. If for example we *speak*, these three parts are represented respectively by the speaker's vocal organ, by the air which transmits the sonorous vibrations, and by the ear of the listener. Here we have an example in which the line is not constituted by an artificial means; but if we ring a bell at a distance, the wire which connects the bell pull to the bell itself represents an artificial line. Evidently the suppression of the artificial line simplifies transmission, so that at all times men exercised their minds to find means, more or less efficient, to transmit signals to a distance without the use of artificial lines. The means which for many centuries were employed in order to effect such a transmission, were either optical or acoustical, and to such they had recourse, as we at present have, more especially when we desire to obtain a great velocity in transmission. The bonfires, by which Alexander the Great announced the victory of the Macedonians over Persia, the bells in the towers which by their deep booming announced the approach of the enemy, the bursting out of the fire or the inrush of inundation, the thunder of the cannon which threw alarm into an entire encampment, are one and all examples of the means adopted for a long time of tele-

graphy without wires. Optical phenomena have, however, the advantage over acoustical of lending themselves to be transmitted to much greater distances, especially because of the extreme sensibility of the eye, which, besides being as a receiving apparatus incomparably superior to the ear, is capable of having its faculties of reception largely augmented by means of telescopes and other optical apparatus, which is not to any large extent obtainable in the case of the ear with any reinforcing acoustic apparatus.

Optical telegraphy has found therefore extended application, especially after Messrs. Chappe Brothers, in 1792, invented the system of signals by means of poles and arms differently inclined, and, notwithstanding the enormous development afterwards acquired by electric signalling, optical signalling has retained considerable importance, as is proved by the immense services which are rendered by flag-signalling as exchanged between ships at sea, or between ships and semaphore stations, and the great use which is still made of optical telegraphy in military operations.

There are many inconveniences, however, presented by optical telegraphy ; first of all, in consequence of the absorption presented by the atmosphere, especially if cloudy or dusty, the distance to which such signals are perceptible is relatively small and varies greatly with atmospheric conditions ; the movements of the air produced by heat or by wind take away a certain distance the sharpness of the signals, which become therefore unintelligible long before they are invisible. Then again optical signals do not warn the receiver of their advent as do acoustical signals, even when his attention is directed elsewhere. This defect renders constant attention on the part of the receiver a *sine qua non*, which attention is extremely fatiguing. Another grave defect is that optical signals, even when properly directed are visible within a large circle around the point at which they should be received and therefore do not lend themselves to secrecy in the communications.

As a consequence of these defects and inconveniences, optical telegraphy has been obliged to leave the field almost free to electric telegraphy (with the exception of some few cases in which this was impracticable, as the communication between the ships at sea or between these latter and

the coast), notwithstanding the fact that the use of conducting wires joining the receiving and sending stations gave rise to very heavy expense both in the way of plant and of maintenance, and even presented sometimes, as in the case of trans-oceanic communication, technical difficulties of the gravest nature.

The discoveries made in magneto-electric and electro-magnetic phenomena have opened up, however, other means for attempting communication to a distance by profiting of the means offered by nature as the air, water, the earth, and the hypothetical "cosmic ether," without having recourse to acoustic or optical phenomena.

Among the most obvious examples of action at distance across space, even if empty, we have that of the action of a magnet upon another magnet (magnetic action), that of electrifying a body in a neutral condition by the influence of another body in an electrified state (electro-static induction), the production of an electric current when the density of a current passing in another circuit at some distance from the first is varied (electro-dynamic induction), etc. Even the transmission of an electrical current through water or through the earth constitutes a means of sending signals without the need of an artificial line, and therefore may be numbered among the systems of telegraphy without wires. It may be said that at every new discovery of action at a distance, an attempt has been made, sometimes with a modicum of success, to apply it to wireless telegraphy; and that is only natural, inasmuch as upon the solution of the problem of communication to a distance depends one of the most urgent wants of our social life, and therefore impels the mind to seek its solution by every possible means, according to their applicability and to the particular cases which in practice may present themselves.

It appears that as far back as two centuries ago, attempts had been made to transmit signals to a distance by purely magnetic means, but owing to the very limited knowledge which at that time existed of physics and the shortness of means, they did not lead to any conclusive results.

The first positive results in telegraphy without wires was, according to some, to be attributed to a Scotchman, James Bowman Lindsay, who, in the year 1831, succeeded in tele-

graphing across the water of the river Tay to a distance of over an English mile. By some, however, the date of this experiment is carried forward to the year 1854, so it is somewhat dubious whether priority should be attributed to Lindsay or Samuel Finley Morse, the inventor of the telegraphic system which bears his name. In 1842, Morse, who was then making experiments in telegraphy, found himself unable to complete them in consequence of an insulated wire which he had stretched across a canal being broken by the weighing of a ship's anchor. He therefore tried to dispose his wires along the banks, leaving to the water the task of conducting the electricity from one shore to another. However, the problem of electric telegraphy without wires had been clearly solved by C. A. Steinheil in 1838, that is to say anterior to the experiments of Morse. First of all Steinheil had tried as a half measure between an artificial line and a natural conducting line, to make use of the rails of railroads (which at that time were sufficiently common in England). Not being able to succeed in this intention in consequence of the difficulty of insulating the rails the one from the other across the ground, a fact which led him to discover the possibility of communicating telegraphically with a single wire by making use of the earth as a return conductor, he instituted experiments in order to establish the laws in obedience to which an earth return current distributes itself in this unlimited conductor, and recognised that a galvanometer can give indications of current when it is in communication with the earth at two points which are not at a great distance from those at which two poles of a battery are placed in contact with the earth. He adds "the future must decide whether it will be possible to telegraph to great distances without metallic communication. For lesser distances, up to 50 feet, I have certified this possibility by experiment, but for greater distances it is admissible to suppose that such would be the case, provided the causative galvanic force were augmented; or by the construction of multipliers specially adapted to this end; or lastly, by the enlargement of the superficies of contact with the extremity of the multiplier." After Morse had published the results of the experiments above cited, which were executed in 1842, and in which he had succeeded in

telegraphing from one bank to the other of a river across the waters, the telegraphic engineer, J. H. Wilkins, in 1849, proposed an arrangement by means of which it would be possible to telegraph from England to France across the air without the use of conducting wires. Bonelli in Italy, Gintl in Austria, Bouchot and Donat in France, occupied themselves with the solution of a similar problem, but the details of their experiments are not known.

The experiments of H. Heiten, which begun in 1852, and lasted nearly 20 years, led to some practical results of interest, and the numerous patents were taken out in consequence for systems of wireless telegraphy, among which we may mention the following: Smith in 1881 and 1887; Phelps in 1884 and 1886; Dolbear in 1886; Woods, 1887; Ader, 1888; Somzee, 1888; Edison, 1891 and 1892; Stevenson, 1892; Senate, 1892; Evershed, 1892 and 1896; Preece, 1893; Rathenau, 1893; Blake, 1894; and Kitsee, 1895.

All these patents had reference to transmission by simple conduction, or by inductive action, by which means the distance that could be reached was always limited; some of these patents referred simply to suggested apparatus, others, however, to apparatus with which actual practical trials had been executed.

Among these last must be noted those of Preece, the Director of the English telegraph system, who, as we shall see, has executed experiments which were conclusive even from a practical point of view.

A new field for experiments in wireless telegraphy was opened up by the famous discoveries of Herz in 1887 and 1888, on electrical oscillation. These extremely rapid oscillations, which take place at the rate of tens of millions in a second, transmissible with the velocity of light (200,000 miles per second), exercised, as we shall see, their action at a distance on certain pieces of apparatus called *resonators*, and therefore lend themselves to the transmission of signals. Fortunately an apparatus called a *coherer* was devised, gifted with an extreme sensibility for announcing the arrival of such waves, and of this, advantage was taken to construct the first apparatus for wireless telegraphy by means of electric waves, which, being gradually improved, has permitted us to carry the transmission of signals to the enormous distance of

5,000 kilometers (3,000 miles), a distance which certainly will be exceeded in future.

As a consequence of these results obtained by electrical waves, all other systems of wireless telegraphy lose in great part their importance, and only remain as records of courageous and glorious attempts to reach the end towards which radio-telegraphy has so far advanced.

But must we, therefore, pass over in silence these attempts? This would be as if in narrating the taking of a fortress, one only took count of the combatants who had penetrated therein, and not of the dead who had been left behind. Every conquest of science over natural laws corresponds to a new fortress captured. The lives of thousands of scientific men must be consumed in abstruse scientific researches, researches which were made for no other purpose but the discovery of truth, before any one of the truths thus laid bare will reach the triumph of a large practical application. As we had said before, compared to the results of radio-telegraphy, all other methods of wireless telegraphy lose their practical importance, it would, however, be unjust not to mention some of these less fortunate attempts. Among these, besides those already mentioned, there are two other systems of telegraphing without wires which it would be well to bear in mind, one preceding and the other following upon the invention of radio-telegraphy. The first one is based upon the use of the radiophone, discovered in 1878 by Graham Bell, well known as the inventor of the telephone. We shall describe this system more minutely with the others (see page 43), for the present it is sufficient to mention that it is based upon the property possessed by selenium to allow a current of electricity to pass more freely through it, while it is exposed to light, than when it is kept in the dark, so that, if we allow an intermittent ray of light to fall upon selenium, the intermittent rays being sent from a distance, while the selenium is in circuit with a battery and sounder, or telephone, these intermittent light waves transmit themselves into corresponding electrical currents, which produce in the telephone, or sounder, acoustic signals, which can serve as telegraphic communications.

The other system is that of telegraphy by means of the

ultra-violet radiations, a conception of Zickner's in 1898, and which is based upon the discoveries made by Herz, that light containing ultra-violet radiations, that is to say, radiations or vibrations more rapid than those which give rise to the violet rays, facilitate the spark discharge between two conductors in opposite electrical conditions ; by means of a source of electricity, two such conductors are maintained charged, and they are removed at a sufficient distance from one another that they shall not discharge their sparks unless ultra-violet rays are thrown upon them ; if now, on these two conductors, ultra-violet rays be allowed to fall, a series of sparks of longer or shorter duration will take place between the two conductors, according to the greater or lesser duration of time for which the ultra-violet rays are allowed to act. Hence, the possibility of sending by this means signals analogous to telegraphic ones.

It is to be noted that the ultra-violet rays are invisible to the eye, for which reason telegraphy by this system has not the defects, which we noted in optical telegraphy, of being intercepted by a station other than that to which it was destined.

Leaving on one side the system of wireless telegraphy, purely optical or acoustical, a description of which would take us too far from our present scope, we will describe now, in a rather more detailed manner, the other systems before mentioned, which can be called electro-telegraphic systems, inasmuch as electrical properties are utilised in them under several aspects, and we will add a few remarks on a system which has been proposed, but which does not appear yet to have received any extended application, in which the thermic infra-red rays are utilised.

We will therefore classify our studies under the following heads :

1. Conduction systems.
2. Induction systems.
3. Radiophonic systems.
4. Ultra-violet and infra-red ray system.
5. Electric wave system.

Naturally to the description of this last system, in view of it being of higher importance, we shall give the larger development.

CHAPTER II.

WIRELESS TELEGRAPHY BY CONDUCTION.

Theoretical Principles.

It is well known that bodies, with reference to the manner in which they behave with regard to electricity, are usually distinguished as *conductors* and *insulators*; conductors are those which allow themselves to be traversed by electricity, insulators being those which intercept such passage.

As a matter of fact, there are no bodies which are perfectly conductive, or perfectly insulating, but, bodies which conduct or which insulate electricity more or less well. The best conductors are metals; but saline solutions conduct fairly well, hence sea water and fresh water, which, as is well known, contains always some salts dissolved in it, are fairly good conductors. The superficies of the earth can also conduct electricity; this property was discovered, as we have already seen, by C. A. Steinheil in 1838, when he attempted to utilise the rails to transmit telegraphic currents. He found that it was impossible to prevent the passage of electricity from one rail to the other to cross the ground. Up to that time, telegraphic transmission had always been effected with double lines, a go, and a return wire. Steinheil having discovered the conductivity of the ground, thought to utilise the earth as a return conductor, and succeeded in realising one of the most important progresses in telegraphy, namely that of telegraphing with a single wire, the extremities of which terminated in two large metal sheets buried in the ground. Steinheil, as we have already seen, made attempts to transmit telegraphic signals by the

use of the ground alone, and succeeded therein for small distances (50 feet), thus giving rise to a system of telegraphy without wires. However, the earth, owing to its heterogeneous constitution and to its low conductivity, does not lend itself so well to such transmission as the sea, rivers, and lakes, hence the most satisfactory attempts in the direction of wireless telegraphy by conduction were made through water.

Besides water and the earth, there are no other media sufficiently extended to serve for this purpose. We may

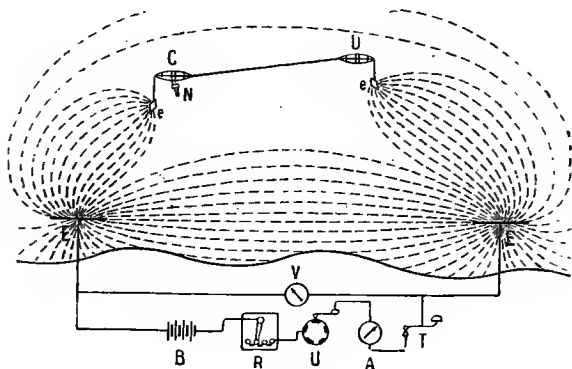

Fig. 1.

now study how we can conceive of electrical transmission through or across a medium which extends in every direction. If we have two conducting sheets, $E E$ (Fig. 1), immersed in a conducting medium of unlimited extent, as, for example, water, kept in contact with the two positive and negative poles of a battery, the electricity passes from one to the other sheet, following certain lines, called lines of electrical force, or lines of current, having curvi-linear forms, which are close together near the sheets and gradually open out as they get farther from them, as shewn in our figure.

The distribution of these lines of force is perfectly similar to the lines of magnetic force which are obtained during

the performance of the well-known experiment for shewing the magnetic field. (Fig. 2.)

If on the poles S and N of a horseshoe magnet, we placed a sheet of glass or a paper, and some iron filings be allowed to fall upon this latter, the filings will arrange themselves in certain special lines, which radiate from the two poles, and which form arcs that pass from one pole to the other. These lines are the lines of magnetic force, that is to say, they indicate the direction in which a magnetic pole which found itself in the field of the horseshoe magnet would tend to move itself. Since the lines of force indicate the direction of magnetic force, in the perpendicular direction to these lines, the magnetic force is nil; and therefore

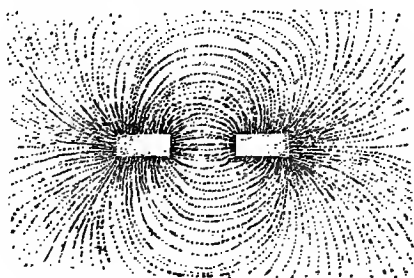

Fig. 2.

if we trace in Fig. 3 (which represents with continuous lines the lines of force which emanate from two magnetised points, $+E$ and $-E$) the dotted lines which cut always in a perpendicular direction the lines of force, the new lines would indicate the directions in which a pole would not have any tendency to move, since along those lines the magnetic force is nil. Such lines are called equi-potential lines. If the two points, $+E$ and $-E$, instead of being two magnetic poles were two points electrified respectively plus and minus, the conditions of the electric field around them could be represented in a precisely similar manner, the lines of force (continuous) will now indicate the direction in which a positive electrified body, if free to move, would move itself, if placed in such a field, and the equi-potential

lines, which are perpendicular to these, will indicate the directions in which the motion of such a body could not take place.

Let us now return to our Fig. 1 (page 9), representing the distribution of the lines of electrical force, or lines of current issuing from the two sheets E and E immersed in the water, and charged one positively and the other negatively. If the conductivity of the medium is constant at all points, the disposition of the lines of force is regular, but if at certain points the conductivity becomes greater, as at ee , in consequence of there being immersed, say, for instance, two large metal plates joined together metallicly, the lines of force bend towards these plates, and the electricity passes

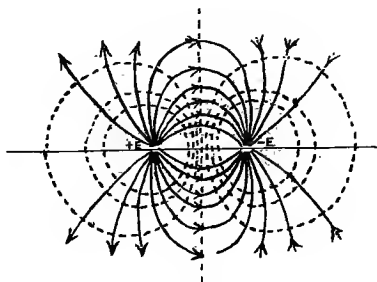

Fig. 3.

from one to the other through the wire, which joins them. It is evident that between these two plates it is not the entire current that passes from the plates E E , but a portion of it called the shunt or derived current, which, however, is much greater than would pass through the wire in the case if this were simply immersed in the water without carrying the plate extensions.

It is necessary to note here that the quantity of current which will pass along the wire ee must depend on the position which the plates ee have with regard to the water and the distance which separates them. If the two plates should be on the same equi-potential lines, as there the electric force along these lines is nothing, there will be absolutely

no current from the one plate to the other, hence the wire will not be traversed by any current, but if the plates ee should find themselves over two points belonging to two lines of different potentials, the wire ee will be traversed by a current of greater quantity in proportion as the difference between the potential of these two points at which the plates are immersed, differs.

Since the potential varies by a constant quantity, in passing from one equi-potential line to the next, so the difference of potential between the plates ee , and therefore the quantity of current which traverses the wire ee will be greater in proportion as the number of equi-potential lines cut by it in its passage is greater, that is to say that the longer it is and the more it is placed transversely as regards the equi-potential lines or what comes to the same thing, the nearer it is to parallelism with those lines which are perpendicular to the former, the greater will be the current.

In Fig. 1, which refers to the experiments of which we will speak farther on, the wire ee is purposely placed in such a manner as to cut the greatest number of equi-potential lines, or to be as nearly as possible parallel to the lines of force.

Somewhat similar but rather more irregular would be the disposition of the lines of force in the case in which the sheets EE and ee were immersed in the ground, as in the experiments already referred to at page 4, made by Steinheil. If the wire ee be inserted into a receiving apparatus (galvanometer, Morse receiver, or telephone), and the contact of the sheets EE with the source of electricity which keeps them charged be not permanent but interrupted from time to time at longer or shorter intervals, the receiver also will become impressed by equal intermittencies, and one can thus establish telegraphic communication between the sending station which charges the sheets EE and that in which it is placed in the receiver.

Transmission through Water.

Morse and Lindsay's Experiments.—The first patent for wireless telegraphy through water was granted in 1854 to the Scotchman, James Bowman Lindsay, and in it are described

the conditions essential for the transmission of the despatches. However, it appears that he had as far back as 1831 applied practically his system for telegraphing across the river Tay at a distance of over an English mile (1,609 metres). His system does not appear to have differed from that which was applied in 1842 by Samuel Finley Morse. It has already been said how the breakage of a wire crossing the river, made use of by Morse in experimenting with his system of telegraphy, led him to attempt to telegraph through the water itself, taking advantage of the conductivity of this latter.

Fig. 4 represents diagrammatically Morse's system: $A B$ $C D$ are the banks of the river, $N P$ the battery, E the

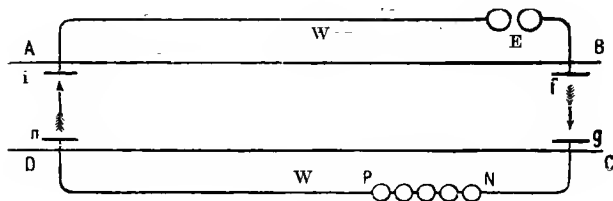

Fig. 4.

receiving electro-magnet which at will could be replaced by a galvanometer, $W W$ are the conducting lines running alongside the shore and which are connected to the sheets $i f n g$ that are immersed in the water. According to the ideas of Morse, the electricity set up by the batteries passed by the positive wire P to the sheet n , and from this across the canal which was 80 feet wide (24.5 metres about), to the sheet i and to the electro-magnet, returning by the wire N to the battery across the sheets $f g$.

The few theoretical principles which we have already given will suffice to show that we must interpret the transmission according to our more modern ideas; at any rate the experiments made with varying lengths of wire and with differing numbers of couples composing the battery shew that the quantity of electricity which crosses the river is proportionate to the dimensions of the sheets, but also

14 WIRELESS TELEGRAPHY BY CONDUCTION

that the quantity depends likewise on the distance between the two sheets placed on one and the same side of the river.

According to Morse, that distance should be three times the width of the river to be crossed; and no advantage will be gained in augmenting the distance beyond the said limits.

The system patented by Lindsay is represented in our Fig. 5, and is, as we see, almost identical with that of Morse. On the two sides are placed two similar apparatus which terminate in two plates immersed in the water;

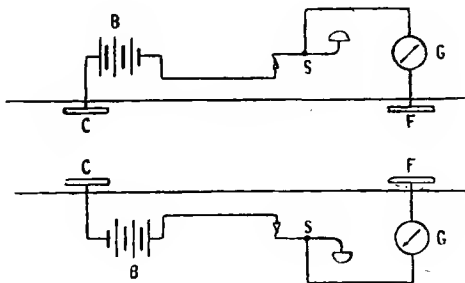

Fig. 5.

connecting wire between the two plates runs overground and has inserted in its circuit a battery with a key and galvanometer. The two batteries b and b are connected so as to work in series.

The length of the two conductors which run parallel to the river banks was calculated in such a manner that the total resistance of the conductor, along with the battery and the apparatus, should be less than the resistance of the water that lies between the two plates that are on the same side of the floor, so that in obedience to the laws of derived currents (shunt currents) the greater part of the current must pass through the conductor to earth. Thus every time that one of the keys $S S'$ is pressed, in consequence of the interruption of the current in the corresponding conductor, there is produced a weakening of the current in the

conducting system on the opposite shore which manifests itself by a diminution in the deflection of the galvanometer readings.

In order to obtain the desired end, the length of the two conductors to earth must be much longer than the width of the river. Lindsay conceived this system with a view to save the expense of laying across the river a costly cable, which would be subject to injury through the strong currents which flowed in that river, and through the nature of its rugged bottom. However, as we see, he was obliged to use a much longer cable as earth conductor. This method is therefore only applicable where there are no earth currents to be encountered, and then only for short distances.

Smith's System.—Willoughby Smith, in order to establish telegraphic communication between the Fastnet Lighthouse and the coast facing it, in a situation where, owing to the great roughness of the sea, a cable could not be placed, adopted the following system. Starting from the lighthouse, were stretched among the cliffs in opposite directions two bare wires terminating in two metal sheets immersed in water. From the shore end started a cable about 15 kilometres in length (about 10 miles) anchored near the rocky shore. By using strong induction currents they were able to receive on the sheets, currents sufficiently strong to work the receiving apparatus; when the impetus of the waves at any time caused the wires to detach themselves from the sheets and beat them against the cliffs, it was found sufficient to immerse the wires in the water, when immediately telegraphic communication was re-established.

Highton's System.—H. Highton occupied himself for 20 years, from 1852 onwards, with the problem of establishing communication across water, and proposed with this view three different methods. The first is no other than Morse's method (page 13), and consists in causing four metal plates to terminate two by two facing each other immersed in water, the conducting lines being stretched on the two opposite banks of the river.

The second consists in joining, by means of non-insulated wires lying in the water, the extremities of the wires facing one another that are stretched along the two sides of the river; the third method is a modification of the second, in

which one of the imperfectly insulated wires is suppressed altogether, and the water alone is made to act as the return conductor.

Highton found the second method, in the majority of cases, the most convenient; this was applied more especially in India by the English telegraphic engineers, who found it adapted for crossing the very largest rivers, provided that the two non-insulated wires that were immersed in the water were at a considerable distance the one from the other.

Barbouse System.—During the siege of Paris in 1870, attempts were made to profit by the conduction of water in order to put the city in communication with the territory beyond the circle of besiegers.

In the Seine were immersed outside the said limits two metallic plates in connection with two conductors and a battery, and this produced deflections in the galvanometer in circuit with two other plates immersed in the Seine within the city.

Preliminary experiments gave good results, but before the entire apparatus was got into working order, the city capitulated.

Rathenau and Rubens System.—Fig. 1, page 9, is a diagrammatic representation of the arrangement adopted in these experiments, which were undertaken in 1894 in Germany at the initiative of the naval authorities of the Empire, with a view to establishing the practicability of telegraphing through water by conduction, and also of verifying the theory as to what part was played by conduction in the corresponding experiments made at that time by Preece, which we shall notice farther on (page 39), in which inductive action was employed. Rathenau and Rubens used for their purpose continuous currents exclusively.

In the aforesaid Fig. 1, *B* indicates the source of electricity, *R* the regulating rheostat, *U* a contact breaker, actuated by a motor, *A* an ammeter, *T* a tapping key, while *E E* are the two plates of about 16 square yards superficial area. These stand at a distance of about 416 yards apart in the water, which closes the primary circuit; *V* is a voltmeter put in shunt with this circuit. *C* and *D* are two boats communicating with each other by means of a cable,

the ends of which terminate in two conducting plates *ee* immersed in the water. The distance between the two boats was varied from about 45 to 250 yards. From one of these boats was placed a telephone *N*, which was inserted in the secondary circuit and acted as the receiver.

In consequence of the presence of the contact breaker, a continuous and constant sound was heard in the telephone,

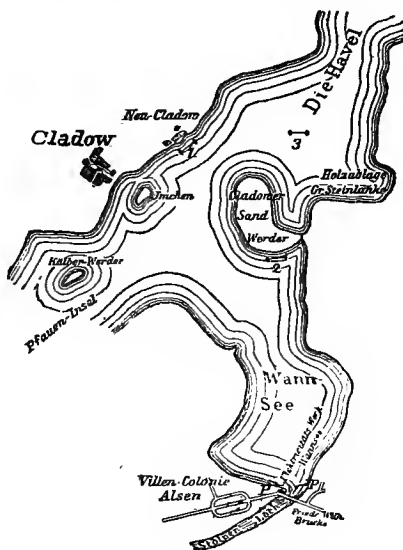

Fig. 6.

as long as no signals were being sent. These were transmitted by working keys and interrupting the current for longer or shorter intervals according to the Morse system, so that pauses were heard in the telephone, which were longer or shorter according to the length of the interruption produced by manipulating the key. These experiments were executed in the Lake of Wannsee, which is situated near the River Havel at Potsdam. The sending station was at the point indicated by *P* (Fig. 6), and the receiver was

successively carried into the localities marked 1, 2, and 3. The quantity of the primary current was 3 amperes only, and the number of interruptions made by the contact breaker amounted to 150 a second. Although the greatest sensibility of the telephone was found to be when the interruptions were made at 600 per second, signals were clearly distinguishable at a distance of about 4 miles, which was the greatest distance available, that is to say, when the receiver was placed in 1 near Neu-Cladow.

Comparative experiments made when the receiver was placed at 2 or 3, that is to say, before or behind an island which was separated from the shore by a narrow canal of no great depth, shewed that the interposition of the island did not constitute an obstacle to the transmission. Rathenau is of the opinion, which was to be foreseen as a consequence of the theory which we have evolved at the beginning of the chapter, that the distance reached might be increased, by making use of a more intense current, by augmenting the distance between the primary and secondary plates, and by tuning the contact breaker with the receiving telephone.

Communications through the Ground.

Steinheil and Michel System.—We have already noted on page 4 the experiments made by Steinheil towards 1838, by means of which he proved the possibility of being able to transmit across the ground currents through a galvanometer up to a distance of about 50 feet. After these attempts, experimenters dedicated themselves especially to the transmission of signals without wires across water, a means which, owing to its greater homogeneousness and conductivity, lent itself better to the solution of the problem. It was only after the receiving apparatus was perfected by the introduction of the telephone that fresh attempts were made to transmit through the ground. In 1894 the Abbe L. Michel was able to telegraph to a distance of about 1 kilometer through the ground by making use of an arrangement shewn in our Fig. 7. A battery of accumulators *B* has one of its poles in communication with the upper layers of the ground and the other in connection with the tapping key *S*, from which starts a wire which, penetrating in a well that

crosses a layer of poorly conducting earth, finds its exit in a lower stratum of soil of more conductive nature. In a similar manner at the receiving station, the two extremities of a telephone are arranged so that one is immersed in the superficial stratum and the other penetrates into the deeper stratum, which is separated from the first by one that is almost insulating. From the arrangement thus adopted, it follows that the current can go to the receiving telephone and returns therefrom, following almost exclusively the conducting strata, losing comparatively little in the soil.

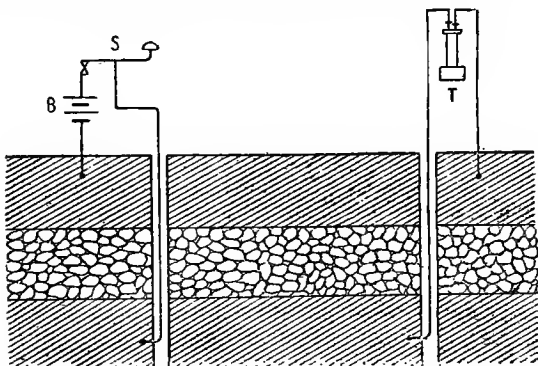

Fig. 7.

Strecker, Orling, and Armstrong's Experiments.—Shortly after Strecker carried out through the soil, experiments similar to those which Rathenau and Rubens had attempted in water. He obtained a perceptible transmission up to a distance of nearly 17 kilometres, using for this purpose a primary line of 3 kilometres in length, a secondary of 1 kilometer in length, and a current which varied from 14 to 19 amperes. He ascertained that the limit of distance of transmission increased in proportion to the quantity of the primary current and with the increase in the distance between the terminal plates, both on the one and the other lines; and lastly, that the best results which were obtained when the two lines were perpendicular to the right line which conjoined their central point. These results, which

are readily comprehensible by the theory evolved at the beginning of this chapter, shew that if we are desirous of going beyond the limits of distance attained by Strecker, and of using currents of less volume than those used by him, which are too strong for general application, it would be necessary to give to the lines much greater length, that which would in most cases detract from the practical utility of the system.

The more recent experiments of Orling and Armstrong were undertaken by means similar to those followed by Rathenau, by Rubens, and by Strecker, that is to say, by means of a primary transmitting line, and a secondary receiving line, both terminating with two plates taken to earth. The difference consisted in their having used for a receiver a relay of great sensibility, (which we will describe later on, along with other similar instruments, at chapter viii.,) which, when excited by the current that arrives, even if this be very weak, closes the circuit of a local battery that is sufficiently strong to actuate an ordinary telegraphic receiver.

By this system, called by the inventors *Armorl*, we have therefore the advantage of receiving written despatches, and of being able to telegraph at equal distances with weaker currents, or, if using the same current, to greater distances, provided that the said relay have really a greater sensibility than the telephonic receivers used in the other systems.

According to Orling and Armstrong, the greatest distance to which they have been able to transmit would be about 16 miles, and this could be increased by using their apparatus as a repeater, that is to say, by placing at the greatest distance that a single apparatus would act the relay to start a second battery which would act upon a second relay placed at a correspondingly greater distance.

Maiche's System.—Maiche has recently patented a system for the transmission of telegraphic and telephonic signals through the ground, which is based upon the principles of the previously described methods. At the sending station we have a battery with its sending key, from which start two wires above ground in opposite directions, and at right angles to the position in which the receiving station is placed; these two wires terminate in two metallic plates

in two porous vases full of water, or in damp soil. The apparatus at the receiving station is arranged in a similar manner, except that in place of the battery and key we have a suitable receiver, as, for example, a telephone.

According to the inventor, when the circuit of the sending station is closed, we set up in the two poles that go to earth, magnetic fields of opposite signs, the effect of which is felt on the line parallel at the receiving station. In order to avoid dispersion, the inventor proposes to place behind the wires of the transmitting station, on the side opposed to that of the receiving station, either an insulating diaphragm, or else to dig out a deep ditch to serve the same end.

Advantage has also been taken of the conductivity of the soil and of water in devising other systems of wireless telephony, of which we will speak in a special chapter.

CHAPTER III.

WIRELESS TELEGRAPHY BY INDUCTION.

Theoretical Considerations.

“INDUCTION” or “influence” is the name given to certain phenomena which one body can produce in another placed at a distance from it without there being any apparent means of communication between the two; thus, if at a certain distance from a magnet be placed a piece of iron, this latter becomes magnetised by induction; similarly, if an electrified body be approached to a conducting body, the latter becomes electrified by induction; if a circuit traversed by a momentary current be brought near to a closed circuit, this closed circuit has a current set up in it which is said to be an induction current.

As a matter of fact, in the actual state of science, we cannot admit “action at a distance,” but rather that the medium interposed serves as the intermediary, which transmits the action from the one and the other bodies, and since many of such “actions at a distance” can be transmitted even across a vacuum, so we must admit that in space, which we call void, there must exist a medium, which we designate “ether,” capable of transmitting such actions.

Precisely in the same way that a body that sounds in air strikes it, and this motion propagates itself in the air until it reaches our ear, so if a body be capable of striking the ether, the undulations will propagate themselves and will be able to excite at a distance another body sensible to such excitement.

Here, therefore, we are in possession of another natural

medium, namely, the ether, for the transmission of telegraphy without wires, a means which is not, however, of recent invention, since it is the very same that Nature continually employs for the transmission of light and heat from one star to another, and one of which advantage has been taken for a very long time, although without its being known, in optical telegraphy.

Now it is just to the intermediary action of the ether that all electrical actions at a distance which constitute the phenomena of induction, already mentioned, are to be attributed. Electrical inductive phenomena are usually divided into two classes, viz., electro-static and electro-dynamic. The production of an induced charge on a conducting body by the approach of an electrified body belongs to the category of electro-static phenomena, because the charge which is thereby produced tends to become stationary in the induced body: while the current set up in a circuit by the approach of another current must be regarded as a phenomena of electro-dynamic induction, since the electric current thus induced may be considered as a certain quantity of electricity in motion.

However, this distinction is not rigid, because, even in the case of electro-static induction, the movement of the inducing charged body gives rise to a movement of electricity and therefore of an electrical current, and a current of electricity also takes place in the induced body at the time of its becoming charged.

Be that as it may, we shall for convenience keep up the distinction between *electro-static induction* and *electro-dynamic induction*.

Applications of Electro-static Induction.—Electro-static induction may be applied to wireless telegraphy in two different ways:

1st Mode.—Let *A* and *B* at Fig. 8 be two conductors facing one another; the conductor *A* can be placed in communication with the source of electricity *E* by means of the key *T*, and the conductor *B* in communication with a telephone. When the key is depressed, *A* becomes charged at the same time a current of electricity becomes evident on *B* charging it, and the telephone gives notice by a sound of the passage of electricity. If then *A* be placed in com-

munication with the ground, A discharges itself as does also B , and the telephone T' gives another acoustic signal.

2nd Method.—A conductor C communicating with a telephone T' (Fig. 9) is near another line or wire, $A B$, through which by the means of a key a current may be made to

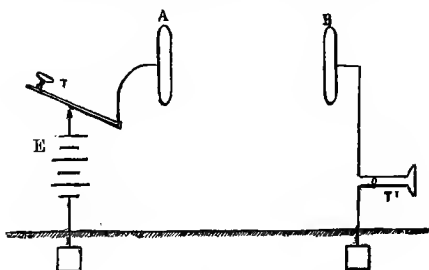

Fig. 8.

pass or be interrupted; at the act of making contact, C becomes charged in the same manner as if an electrified body were approached to it, thus producing a current which excites the telephone; when the current in $A B$ ceases, the conductor C discharges itself just as if a charged body were suddenly withdrawn from its vicinity, and the telephone

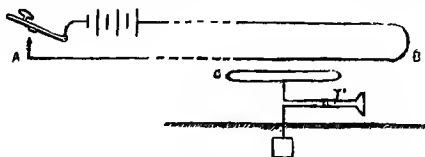

Fig. 9.

gives another signal. In both these cases, by manipulating in a suitable manner the key, telegraphic correspondence can be established between two stations by means of conventional acoustic signs.

Applications of Electro-dynamic Induction.—The fundamental phenomenon, of which advantage is taken in telegraphing without wires by induction, is that discovered by

Faraday in 1831, and is ordinarily known under the name of electro-dynamic induction. It consists in the following :

If we have two circuits facing one another, one at I (Fig. 10), containing a battery P and an interruptor T , by means of which the circuit can be closed or opened at will, and another at I' closed upon a galvanometer G ; every time that the circuit is closed or opened at the contact key T , the circuit I' is traversed by an instantaneous current (induced), which is revealed by a kick in the needle of the galvanometer. The induced current which is produced at the act of closing the circuit is in the opposite direction to that which is set up at the moment of opening it, and for this

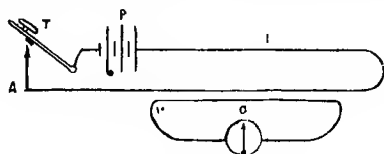

Fig. 10.

reason the two successive impulses which the galvanometer needle receives are also in opposite senses. If the distance between the two circuits I and I' be increased, the current set up in I' will be lessened in intensity, but they can be rendered sensible even at rather great distances by augmenting the sensibility of the galvanometer or of any other receiving apparatus placed in its stead, or else by increasing the intensity of the current in the inducing circuit I , or, lastly, by any of the other devices suggested by the study of the laws of the phenomenon.

In order to explain the mechanism of this transmission through a distance, it is well to remember that all round the wire traversed by a current is formed a magnetic field, whose lines of force (see page 9) are circles in planes perpendicular to the wire, and having for their centre the wire itself.

The formation of this magnetic field is shewn by the fact that if near the wire traversed by the current be placed a magnetic needle, suspended so as to be free to move $N S$ (Fig. 11), this needle will place itself perpendicularly to the

direction of the current; this can also be shewn by the experiments of the magnetic spectrum in Fig. 11, which is analogous to that in Fig. 2, the wire AB passes perpendicularly through a piece of cardboard, on which are scattered lightly some iron filings; when the wire AB is traversed by a current, the iron filings arrange themselves in concentric circles as shewn in the figure.

Reciprocal phenomena also manifest themselves, that is to say, that the production or disappearance of a magnetic field gives rise to a current in a wire placed perpendicularly to the lines of source in that field, so that, if parallel to the

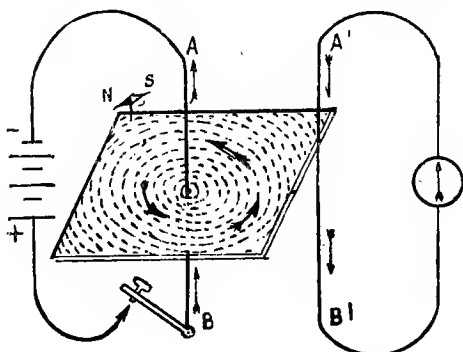

Fig. 11.

wire AB be placed at a distance another $A'B'$, when the magnetic field set up by the inception of the current on the first reaches the second, this latter becomes traversed by an instantaneous current, which is the induced current on closure. On interrupting the current, the magnetic field is withdrawn, and this withdrawal produces in the wires $A'B'$ another instantaneous current in the contrary direction to the preceding, which is the "opening" induced current. The production of this magnetic field can be obtained by other means, as for example by approaching to the wires $A'B'$ a magnet, in such a way that *its* lines of force (Figs. 2 and 3) should intersect the wire perpendicularly; even in this case the magnetic field which is set up near the wire

produces in it an induced current, and a current in the opposite direction is obtained if the magnet be withdrawn ; this fact, as is well known, has an extraordinary practical importance, inasmuch as it presents to us the means of obtaining in our dynamo-electric machines, currents without having recourse to batteries, and that by the simple displacement of a magnetic field of a magnet with regard to a closed circuit.

It is important, in view of the applications that we shall have to make, to observe that if the wire AB is traversed by electrical discharges that are either interrupted or alternate, since every discharge consists in a passage of electricity, that is to say, produces an electrical current, so at every one of the discharges will correspond the production and the successive disappearance of the magnetic field, and hence the production of so many alternate currents in the conductor $A'B'$.

Turning now to the case mentioned at Fig. 10, if it be desired to obtain at I' a rapid series of induced currents, we may insert in the circuit I an automatic break, as, for example, a rotary one (see chapter vii.), instead of the key ; in which case, however, it were well to replace the galvanometer by a telephone which indicates the arrival of each induced current by a little noise, which is perfectly perceptible to the ear, and which may even become an almost continuous or musical sound, provided the interruptions take place with sufficient rapidity. If, besides the contact breaker, there be placed in the circuit also, the key T , we can, by closing the circuit for longer or shorter intervals, cause to be heard in the telephone, sounds of greater or less duration, corresponding respectively to the dots and dashes of the Morse alphabet, and thus to transmit despatches without making use of wires communicating between the inducing and the induced circuit. This method finds, as we shall see, useful application when it is desired to establish communication between a fixed line transversed by the inducing current and a moving receiving station in proximity with it, which contains the induced current, as in the case of telegraphic communications with trains in motion or with beacon ships, which, according to the direction of the wind, change position, so that it is not possible to

connect them with the coast by means of a cable, which would not admit of such movements. In these cases, we have truly done away with the wire of communication between the two stations, but the inducing and the induced wire must be at, comparatively speaking, small distances from one another.

In practice, however, it often happens that the two circuits cannot be placed at so small a distance from one another; we have therefore to study the conditions suggested by theory and verified by practice, in order to cause the signals to reach, intelligibly, much greater distances.

The two circuits, I and I' , in the preceding figure, may be placed on the same plane, or they may face one another in parallel planes. Both theory and experiment have shewn that the intensity of the induced current is greater in the second than in the first case. However, as we shall see, experiments in induction telegraphy have been made by placing the inducing and the induced wires in the same plane. When it is a question of communication to great distances, and the disposition of the circuits in parallel planes is adopted, it is evident that these planes must be vertical, and in such a case two modes can be followed: either the two circuits used are each perfectly closed on themselves, or else the ground or water is used as a return conductor, as is shewn in our Fig. 12, that is to say, making use of a single wire raised above the soil, and terminating in two metallic plates immersed in the earth or in the water. The two examples are at first glance very different, but in reality they correspond. In fact, in the case shewn at Fig. 12, the one and the other of the two sheets immersed form the lines of current of which we have spoken above (page 26), which are traversed by innumerable currents called shunt or derived currents. The sum of all these currents is, however, equivalent to a single current which traverses a single conductor R , which, along with the aerial conductor L , constitutes, as in the first case, a closed circuit. The depth to which the lines of current are sensible, and therefore the depth to which we must imagine the resulting conductor R must be led, increases with the increase of the distance between the two buried sheets of metal.

In the experiments made by Preece and Frodsham, where the aerial line had a length of over 100 yards, it was found necessary to suppose that the earth conductor were placed at a depth of 100 yards; and in the experiments of Conway, with a primary line of over 410 yards in length, the distance calculated for depth was over 116 yards, while in the experiments made at Ness-See and Kilbrannau-Sound, in which the distance between the immersed sheets varied from 2 to 4 miles, the depth to which the lines of current were sensible reached about one-sixth of a mile. From this it

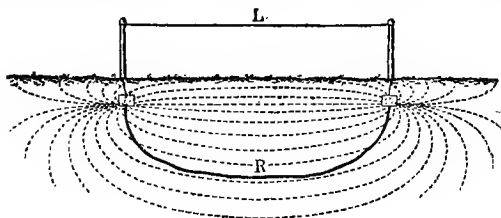

Fig. 12.

appears that by lengthening and raising the earth line *L*, the superficies comprehended between the inducing circuit go on increasing in sympathy, not only as an effect of the enlargement of the part of the superficies that is lying over the terrestrial surface, but also by increasing the depth of the resulting earth conductor *R*.

Special experiments of Preece have shewn that with the increase of this surface, the inductive action between the inducing and the induced circuit is also increased.

In these experiments two bobbins of wire, the one facing the other, were employed, of which one constituted the primary circuit and the other the secondary, and by means of a telephone the production of the induced current in the secondary circuit was listened for. By these means it was recognised, that the inducing effect of a spiral was rendered sensible to a much greater distance by augmenting the diameter of the spirals than by increasing the number thereof.

Now, since, as we have already seen, a single wire stretched along the ground with its extremities in communication with the latter may be looked upon as being a bobbin

with one single spiral, but with a diameter much greater than that of a metallicly closed spiral would have, so the said stretched wire is much more efficient than a spiral closed upon itself.

Having recognised, therefore, that the greater the area comprised in the inducing circuit, the greater will be the induction, it is obvious that one of the conditions in which a signal can be transmitted to a distance is that of using primary and secondary wires, long, high, and terminating in sheets buried in the soil or, better, in water. If the two circuits at Fig. 10, page 25, instead of consisting of a conductor making but one single turn, were made up of several turns, it is reasonable to infer that since every spiral of the circuit I acts inductively on each spiral of the circuit T , the induced current in this latter would be more intense, and, therefore, we are led to believe that in transmitting to great distances, it would be preferable to employ, instead of conductors consisting of a single turn, bobbins having many turns.

The elements which enter into this function are too numerous to permit us to decide by simple reasoning on the adaptability of one or the other of these two arrangements, the more so if we are to hold in account the case of the spirals with their extremities put to earth, in which the earth conductor set up takes a form which has not been well determined, a thing which will be readily recognised is that, with the increase of the number of spirals, the length of the conductor, and consequently its resistance (unless, indeed, the diameter of the wire be increased in the same proportion as it is lengthened, which would necessitate an increase in the expense), this increase in the resistance diminishing the volume of the induced current, and therefore, to maintain this last constant, would necessitate a proportional increase in the electrical energy of the primary circuit. Besides this, it must be noted that by multiplying the spirals we set up another induction (self-induction) between the turns of the primary circuit, which, producing in *this* induced currents, alters the quantity of the inductive current, increasing it in certain cases and diminishing it in others, for which reason, in order to decide the question, it was better to have recourse to direct experiments.

The experiment was made by Preece in the following manner :—Two wires of determinate length were wound on two bobbins, and the intensity of their inductive action at a given distance, the one on the other, was determined, as well as the distance at which these actions were no longer perceptible. The two bobbins were then unwound, and the two wires were stretched out so as to form two rectilinear conductors, making use of the earth as a return ; and it was found that, using the same electric power as in the first case, that the inductive action as well as the distance to which these actions were perceptible was in his case many more times more intense than in the first arrangement.

These experiments confirm the advisability of adopting for transmission to great distances a single aerial line of great length, stretched as high as possible, parallel to the surface of the earth, and communicating at its extremities with two metal plates plunged in the ground or in water.

Electro-static System.

Smith and Edison's System.—The first applications of telegraphy by electro-static induction were made with the view of establishing communication between railway stations and trains in motion. Smith, in 1881, devised to this end the plan of allowing a telegraphic line to run parallel to the rails, and so placed as to lie as near as possible to the roof of the carriages running on the rails. The roof of the carriages was covered with a metallic sheet perfectly insulated, from which started a wire which led to one of the binding screws of the telephone placed in the inside of the carriage, the other binding screw being put in connection with the ground through the wheels.

The interior telephone was found to reproduce telephonic conversation transmitted along the line wire. Rather more complicated was the apparatus that Edison patented in 1885, and which served the same end as the preceding ; its fundamental principles are identical with Smith's ; but we think it advisable to omit the description of it here in order not to leave the field of wireless telegraphy.

As a matter of fact such a name would not be appropriate

to systems like these, in which, although there is actually a discontinuity between the line and the receivers, it is absolutely necessary that there should be a wire that runs the whole length of the line along which it is desired to effect communication.

Edison tried his system in 1889 on a line of 35 miles in length, on the Lehigh Valley Railway; the despatches were transmitted by acoustic telegraphic signals which were received by a telephone, and along the whole line communication was found to be perfect.

Dolbear's System.—The following system, which is due to Dolbear, is represented diagrammatically in Fig. 13, and

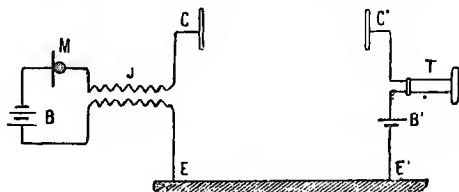

Fig. 13.

admits of establishing communication between much greater distances. At the sending station is placed a battery B , having an electro-motive force of at least 100 volts, one pole of which is put to earth at E through a spiral of a bobbin J , and the other communicates with the metal sheet C through the microphonic contact M and the other coil of the bobbin J . At the receiving station is a weaker battery B' , whose poles communicate one with the earth at E' and the other across a telephone T , with the metal sheet C .

The two sheets C and C' thus constitute the coatings of the condenser of small capacity, in consequence of the great distance which intervenes between the one and the other. But as these two sheets are near the ground, each one may be considered as a condenser, whose other coating is the ground, and of much greater capacity than that of the condensers $C C'$.

When the microphone M is spoken into, its vibrations render the charge on the coating C variable; this acts by

induction partly on the ground near E and partly on the coating C' , as a consequence this sends currents through the telephone T , which repeats the vibrations of M , reproducing the words spoken before M .

Other Forms of Edison's System.—In consequence of the greater distance existing between C and C' than between C and the ground, much more energy is lost between C and E than actually passes between C and C' .

In order to diminish this dispersion between C and the earth, it is necessary to diminish the capacity of the con-

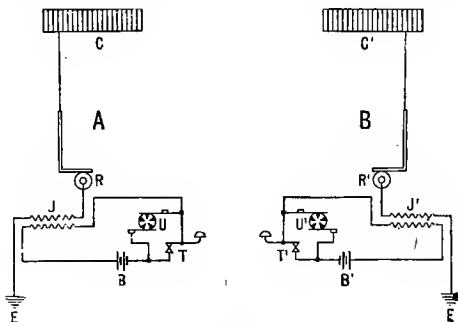

Fig. 14.

denser, of which C and the earth form the coatings, and this can be done by raising C above the level of the earth.

One of the first to recognise this fact was Edison, who, in one of his patents on wireless telegraphy overground, points out the necessity of placing the coating of the condenser at such a height that the absorbing action of houses, of trees, and of the ground be reduced to the smallest possible point.

In order to support such sheets, besides advising the use of high poles or masts, he suggests that of kites or small balloons.

The apparatus employed by Edison is represented in our Fig. 14, the two capacities C and C' are placed a considerable height above the level of the ground and communicate by means of metallic wires with the receiving apparatus R ,

which he calls an "electromotograph," and with the secondary winding of an induction coil J . The electromotograph consists in a rotating cylinder on which rests a metallic brush, which, by the friction it sets up on the cylinder, gives rise to a sound of a given pitch. When the brush is traversed by a current, the degree of friction varies, and with it also varies the pitch of the sound emitted. These variations in sound constitute the signals which serve for telegraphic communication.

In place of the cylinder R may be used any receiving apparatus that can be put in action by alternating currents.

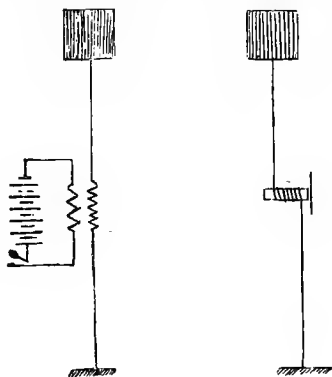

Fig. 15.

The primary of the induction coil J is included along with the key T in the circuit of the battery B . In its usual condition the key T is depressed; when it is raised the current from the battery passes through the rotary break U through the primary J as a series of intermittent currents, which produce in the secondary corresponding alternate currents that, propagating themselves until they reach the surface of the condenser C , charge it alternatively with positive and negative electricity.

These electro-static impulses are transmitted by induction to the sheet C' of the receiving station, producing currents along a wire which goes to the receiver R' , which gives evidence of their arrival in the manner above indicated.

Another and more simple arrangement was conceived by Edison in 1891, and this is represented in Fig. 15. At the sending station a key opens or closes the primary circuit of an induction coil, the secondary of which is placed in communication on the one side with a high mast carrying at its extremity a metallic plate, and at the other of the ground; at the receiving station a similar mast communicates to the ground through a telephone. According to the inventor, this arrangement formed a condenser in which the sheets and the wires formed the coatings, while the air acted as the dielectric.

Here again, when the plate at the receiving station became charged or discharged by the effect (induction) of the other plate, currents were produced in the wire which caused the diaphragm of the telephone to vibrate, and thus to transmit the desired signal.

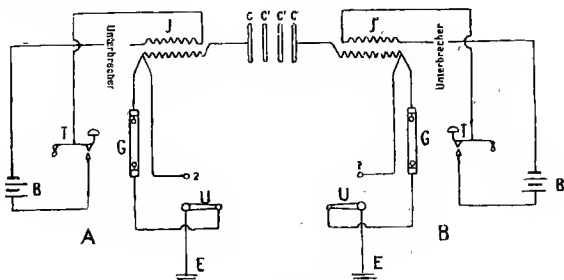

Fig. 16.

Kitsee's System.—Not unlike that of Edison, is the method employed by Kitsee and shewn at Fig. 16.

As receiver is employed a Geissler tube *G*, which by becoming illuminated announces the arrival of the currents sent by the sending station. The primary of the bobbin *J* is inserted in the battery *B* along with the contact breaker (not shewn in the cut), and a key which acts in the usual manner, that is to say, leaving the circuit open when not in use.

The secondary wiring of the bobbin *J* is connected on one side with the capacity sheet *C* and on the other either

directly to earth when the commutator U is put in the second position (in which case the apparatus is ready for transmission), or in communication with the ground through the intermediary of the Geissler tube G , when the commutator U is placed in position 1, when the apparatus is ready to receive.

On manipulating the sender G one can thus produce a lighting up of longer or shorter duration of the Geissler tube at the receiving station, which can be thus made to correspond to the dots and dashes of the Morse alphabet. In order to increase the distances of transmission, there may be introduced between the sheets C and C_1 other insulated sheets as at C_2 and C_3 , which serve as static transmitters. But such devices cannot, however, be made use of beyond certain limits, because at every new transmission a certain loss of energy takes place, for which reason the distances which can be reached are always very small.

The Tesla System.—Tesla, before he had thought of applying "electric waves" to telegraphy without wires, devised an application of electro-static action and had recourse to vibrations emanating from a conductor of large area placed in communication with one of the poles of an alternate current machine, capable of setting up about 20,000 alternations per second, the other pole of which was placed in contact with the ground. He thought that if at a distance from the same conductor were placed another similar, also earth connected, and having a period of oscillation equal to the first, this latter, owing to the phenomena of resonance, a phenomenon with which we shall have to occupy ourselves largely later on, would partake of the variations which might be made in the first conductor, and thus the system would serve for the transmission of signals from the one station to the other.

This system forms a link between the electro-static method of Edison and those in which electrical waves are employed, in which the alternations are at the rate of 10 millions per second. Tesla, basing himself on the above-mentioned principles, took out in 1898 a patent for a method of controlling at a distance the route of a screw steamship.

Electro-dynamic Systems.

The Trowbridge System.—The first notable application of the phenomena of electro-dynamic induction to the transmission of signals at a distance was made in 1880 by Professor Trowbridge of Cambridge (U.S.A.). Two wires along which the signals were transmitted were one mile apart. The inducing wire was an ordinary telegraph wire that united the Observatory at Cambridge with the City; the signals that had to be transmitted were the beats of a clock that at equal intervals of time interrupted the current passing along the inducing circuit. In the induced circuit, which consisted of a wire of about 160 yards in length, were received by means of suitable apparatus, the induced currents therein set up.

Phelps and Woods-Adler Systems.—In 1884 Phelps utilised these same phenomena in order to effect communication between trains in motion and the railway stations. The inducing circuit consisted in an insulated wire which ran from station to station, passing through a conduit that was placed between the rails and was in communication with the transmitting apparatus in the stations. In one of the waggons of the train was placed the induced circuit, which consisted in an insulated copper wire of about 3,000 yards in length, wound in many turns on a vertical rectangular frame, one side of which hung out below the waggon as near as possible (about 9 inches) to the underlying wire of the inducer to which it was parallel.

The two ends of the induced circuit were connected up to a very delicate relay which, on receiving the induced current, closed the circuit of a local battery that put into action an ordinary Morse receiver.

Each time the inducing circuit was closed by working the key at any of the transmitting stations, an intermittent current passed along its wire, and the induced current produced by this in the induced circuit, caused the relay to work and thus to register the signal.

The experiments made on a line of about 10 miles in length gave very satisfactory results. In order to telegraph from the train to the stations, use was made of the local

currents of the train, and by means of a suitable key, interrupted currents were sent along the circuit contained in the train, and these currents set up by induction others in the wire of the line, which led to the station, where they were picked up as signals by means of a telephone.

In the years 1887 and 1888, similar apparatus were devised by Woods and Adler, which were tried successfully, but it does not appear that they ever had very extended application.

The Eversted-Lennet System.—Fig. 17 represents an arrangement devised by Eversted and Lennet, by means of

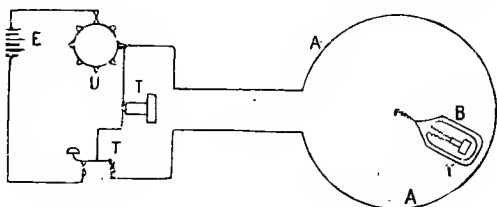

Fig. 17.

which one can telegraph from the shore to a beacon ship at anchor, or to a ship which can be met as it enters a certain determinate sphere of action. In *B* is represented a beacon ship at anchor, which, according to the direction of the wind, may take up various positions in a circular field having for its centre the anchor. In order that the ship may in any of these positions receive communications from the coast, a cable is placed at the bottom of the sea which covers the said field, and which is in communication with the transmitting apparatus on land. The ship is externally wound with a spiral of at least 50 turns of insulated wire, which constitutes the closed secondary circuit with the telephone *T*. By means of the key *T* and the automatic contact breaker *U* intermittent currents are sent in the circle of cable, which currents, acting inductively on the spirals wound on the ship, produce in the telephone the signals on the Morse system.

It is quite evident that a similar system may be adopted for communicating with an unanchored ship, provided it be

furnished with a receiving apparatus, and that it enter within the field embraced by the circular cable.

Preece's Experiments.—The methods hitherto described permit only of signalling between distances that are relatively small, and they can only be considered as entering in the category of wireless telegraphy, inasmuch as there is no metallic communication between the two circuits; but they require that there should be wires both at the sending and at the receiving stations, and that they should be near one another. The necessity of communicating between shore and isolated lighthouses, floating or otherwise, and possibly also between shore and ships *en route*, has spurred inventors in their endeavours to find a more general and efficacious solution of the problem.

Preece, the chief electrician of the English telegraphic system, has proposed to this end three different methods, which were subjected with every advantage to the proof of experiment.

The first means consisted in placing along the coast a conductor of some miles in length, and another conductor as long as possible on the ship. If the first circuit were transversed by intermittent currents, these induced in a second circuit other currents, the intensity of which depended on the length of the two circuits, on their respective distances, and on the length of the primary current.

In the second method, a metallic conductor was placed on the side of the vessel, the extremities of which were immersed in the sea, parallel to the conductor on shore, so that the circuit which went through the receiving instruments was closed across the water and sea.

In the third experiment, a light submarine cable was made use of, which on one side was connected to the coast station, and was prolonged until it was near the ship, where it terminated in an induction coil. On board this latter was a second induction coil, on which the first acted by induction, thus transmitting the signal.

All these methods are also applicable to communication between two distant shores, in which case the difficulties of transmission are more easily overcome, since it is then possible to give to the receiving line much greater extension than in the case in which this latter is placed on ships. on

little islands or rocks, a thing that often happens in isolated lighthouses.

Preece's experiments were begun in 1884, and had in the beginning for scope that of studying the laws of transmission of electro-dynamic induction across space, and of choosing the most appropriate means, and of verifying the conditions in which these gave the best results. Of these experiments we have already spoken in the theoretical part of the present chapter; we shall now limit ourselves to the description of the experiments in which practical use was made of the results obtained by the above described.

In 1886 the first of the methods just mentioned was applied to the transmission of messages between Gloucester and Bristol on the banks of the Severn, at a distance of about $4\frac{1}{2}$ miles. Parallel to the two shores were stretched on the telegraph posts two wires having a length of about 14 miles joined to other wires, which passing at a great distance from them formed two closed circuits. One of these circuits was traversed by a current of $\frac{1}{2}$ an ampere subject to interruptions so rapid as to produce a continuous sound in a telephone inserted in the same circuit. A telephone inserted in the other circuit reproduced the sound of the first one.

In 1893 experiments on a larger scale were undertaken in the Bristol Channel between a promontory called Lavernock Point, and the two little islands Flat Holm and Steep Holm (see Fig. 18), situated across the Channel, the first at a distance of about $2\frac{1}{2}$ miles, and the other at about 4 miles from Lavernock Point. Communication was perfect with the first named island, and perceptible, though not very sure, with the second. The arrangement consisted in a line three-quarters of a mile long at Lavernock Point, through which was sent the current from an alternator of 192 periods per second, the current density of 15 amperes.

A line of one-third of a mile in length was stretched on each of the two islands. The line wires were supported on poles, and had their extremities taken to earth.

Other experiments were also made with a steam launch, communicating with a wire about half a mile in length covered with gutta percha, of which one extremity was on board and the other communicating with a floating buoy.

At distances of less than a mile the signals arrived so long as the wire was suspended in the air or immersed in the water; for distances greater than a mile the signals did not reach unless when the wires stretched in the air. In consequence of the good results obtained with these experiments, the arrangement between Lavernock Point and Flat Holm was made a permanency, with the view to keeping up communication between the coast and the lighthouse placed on this island, and from March, 1898, a

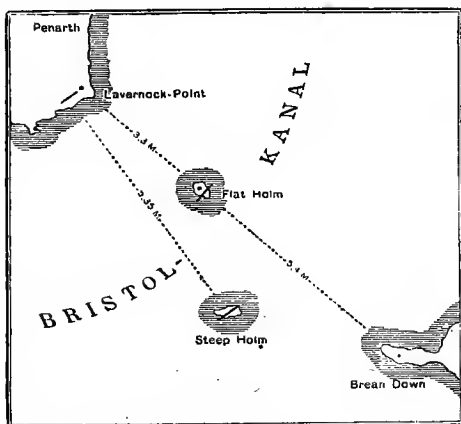

Fig. 18.

regular service of telegraphic messages has been carried on between the two places. However, instead of the alternator a battery of 50 Leclanche cells coupled to a contact breaker, which gave 400 interruptions per second, has been substituted, it being found that at this frequency the telephone receiver seemed to acquire the greatest sensibility, and the arrangement was improved by adding thereto a highly sensitive relay of the Evershed type.

The signals reached perfectly, and the rapidity of transmission was in certain cases as much as 40 words a minute.

The Syntonised System of Lodge.—This system may be looked upon as a kind of transition stage between simple

electro-dynamic induction and those based on the electric waves, inasmuch as in it advantage is taken of the induction between two bobbins, but these are connected up to "capacities" in such a way as to give rise to electrical waves, which do not differ from the ordinary waves, except that their length is much greater.

The comprehension of this system requires a knowledge of the principles on which the systems of electric waves are based ; for which reason we shall describe them along with these (see chapter viii.).

CHAPTER IV.

RADIOPHONIC SYSTEM.

Theoretical Principles.

THE American physicists, Graham Bell and Sumner-Tainter, in a course of experiments in the reproduction of sounds by means of light, made in 1878, discovered that a beam of light which had been rendered intermittent, falling upon a thin sheet held against the ear gave a sound, the number of whose vibrations, in a given time, is equal to the number of the intermissions of the luminous ray in the same time.

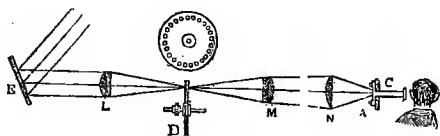

Fig. 19.

The apparatus by means of which this phenomenon can be reproduced, was called by its inventors a Photophone; but Mercadier, who carried out most intricate experiments on this same subject, proposed the name "Radiophone," since not only luminous radiations were able to excite it, but also thermic and actinic radiations.

The apparatus is represented at Fig. 19. A beam of solar rays reflected by the mirror *E* are firstly brought to a focus by the lens *L*, and then, by means of two other lenses *M N*, concentrated on a very thin smoked sheet, which is brought

near the ear either directly or by means of a little acoustic horn *C*.

At the point in which the rays reach a focus on leaving the lens *L* is placed a disc furnished with a ring of circular apertures around its edge, and this is mounted on the axle of a small electro-motor, the speed of which can be regulated at will. On rotating this disc, the apertures around its edge open and close in succession the passage to the light, as an effect of which the little metal sheet *A* is put in vibration, emitting therefore a note, which is sharper in proportion as the motion of the disc is more rapid. This sound is supposed to be due to the successive dilatations and contractions of the air contact with the vibrating lamina of metal produced by the heating set up on this at the moment in which the radiation reaches it, and to the cooling which follows when the radiation ceases; for this reason the apparatus was also called a thermophone.

It is easy to make this system serve to the reproduction of conventional signs such as the dots and dashes of the Morse alphabet. It is sufficient, for example, to cause to pass before the source of light a screen, the movements of which are regulated by a lever, which can be operated in such a manner as to allow the light to pass for a longer or shorter time, according to whether it be desired to pass in the receiver, which shall correspond to the dashes and dots of the Morse alphabet. Using the thermophonic receiver above described, the distance of transmission is relatively small; this can, however, be largely increased if a selenium resistance be inserted in a circuit comprising a battery and a telephone. This receiver is based upon the singular, and somewhat mysterious, property that crystalline selenium has, of being a much better conductor of electricity when illuminated, the conductivity increasing with the increase of light. If therefore such a resistance be exposed to a luminous radiation of variable intensity, the variations in the intensity of the light will produce corresponding radiations in the resistance of the selenium, and therefore in the circuit in which this is inserted; such variations in the resistance will produce in their turn corresponding variations in the strength of the current, which will traverse the telephone, that will therefore emit

sounds having the same rhythm as the variations in the intensity of the luminous radiations.

With similar devices to those used with the thermophonic receiver, it is possible to obtain with the selenium receiver acoustic signals corresponding to the Morse alphabet. Fig. 20 represents one of the forms given by Mercadier to the selenium resistance to satisfy the two conditions of exposing an extended surface of selenium to light, and of rendering at one and the same time the surface great and the thickness small of the selenium interposed between the electrodes.

The electrodes consist in two long thin strips of sheet copper insulated by a strip of paper of equal width coiled between them in a spiral form, and compressed by a little thumb-screw as shewn in the figure. The two metallic strips are connected, one to the terminal e and the other to e' . After having rendered the faces of the system perfectly level, the whole is heated to such a point that by rubbing over the edges with a little stick of vitreous selenium, this latter melts and sops the paper; the piece of apparatus is then placed in a stove and heated until the vitreous selenium acquires the crystalline condition. The two binding screws e and e' enable this selenium resistance to be placed in the circuit between the battery and the telephone. In order to set the thermophonic or selenium receiver in action, it is not necessary that the beam of luminous rays that fall on either the one or the other be intermittent, as shewn at Fig. 19 by the aid of a perforated disc; it is quite sufficient that the light should undergo variations in intensity to produce analogous variations in the sound in the telephone.

In order to obtain this beam of variable intensity, we can act either upon the mirror B which reflects the beam of light, or directly upon the beam itself as it issues from the luminous source.

In the first case very small oscillatory movements may be given to the mirror, so that the beam may slightly change in position, and thus cause the quantity of light concentrated upon the receiver to vary. The simplest means of imparting such movements to the mirror is to construct the mirror of a very thin substance, say very thin glass or thin mica (silvered), and to produce a sound at the back of the

mirror, the surface of the mirror then oscillates, and as a consequence these oscillations are picked up by the receiver and reproduced as sonorous oscillations similar to those produced behind the mirror.

And so perfect is the reproduction that if we speak behind such a mirror, we obtain in the receiver a reproduction of the words, thus realising a system of telephony without wires.

In those systems in which it is desired to act directly on the intensity of the luminous source, it is evident that recourse must be had to an artificial source, as ordinary gas,

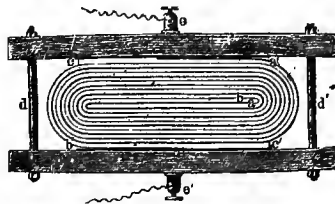

Fig. 20.

acetylene, or the electric light. A gas jet or an acetylene flame can be rendered variable by altering the pressure of the gas, which is easily done by employing a manometric capsule, which we will describe a little further on (see Fig. 22), in which the variations in the pressure of the gas are produced by oscillations in an elastic membrane which is fastened on to the sides of the holder or recipient, into which the gas passes before arriving to the jet. Even here the sensibility of the arrangement can be made so great that if the oscillations of the membrane are set up by words spoken in front of it, the receiving apparatus reproduces the words, and thus constitutes another system of wireless telephony.

Finally, if, in order to reach greater distances, the electric arc be made use of as the luminous source, the same variations in intensity may be produced, capable even in this case of reproducing the spoken words, by taking advantage of certain interesting properties of the voltaic arc recently

discovered, and known under the name of Duddel's singing arc, of which we will now give a short description.

The fundamental fact is as follows :

If near a continuous current which is feeding an arc be placed in suitable conditions an alternate current of small intensity, the arc itself emits a sound which reproduces the oscillation of the alternating current, and at the same time equal oscillations are produced in the light emitted by the arc. If the said alternating current be that which is set up in the circuit of a microphone when spoken into, the arc can reproduce the spoken words ; and if then the light emitted by the arc be received by a selenium receiver placed at a distance, the luminous oscillations cause the spoken

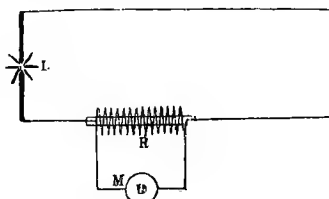

Fig. 21.

words to be reproduced at the telephone of the receiver ; whence we have a third system of telephony without wires.

The alternating current may act on the lamp circuit, either by induction when it traverses a circuit near to that which feeds the lamp, or else directly by traversing a shunt circuit taken from two points of the feeding circuit.

The second mode gives rise to arrangements that are simpler and more efficient, one of which, due to Ruhmer, is represented in our Fig. 21. R is a bobbin wound on a core of soft iron, around which passes the entire current that feeds the lamp. From the extremities of this bobbin start the wires of the shunt circuit, in which is inserted the microphone M . If the resistance of R be properly determined, it is possible to do without any special battery for the microphone. When the microphone is spoken into, the modifications in resistance set up by the sonorous oscillations modify the current which flows round the

bobbin, and feeds the lamp, and the light of this latter vibrates in correspondence with the diaphragm of the microphone, while similar vibrations reproducing the spoken words make themselves heard in the selenium receiver placed at a distance from the lamp.

It is probable that similar effects, but of greater intensity, might be obtained in the arc, by inserting the bobbin with the microphone in front, in the inducing circuit of the dynamo, which produces the main current, since every modification in the current of the inducing circuit alters the magnetic field, and this in like manner modifies the currents which feed the lamp, and which are induced in the armature that is moving in the said fields.

With regard to the explanation of these phenomena presented by the arc, the one which has met with greater acceptance, although perhaps not complete, is that of Simon, which is based upon Joule's law.

According to this law, the heat which is set up in a circuit is proportional to the square of the current which traverses it, for which reason small variations in current produce variations proportionately larger in the quantity of heat given off. In the phenomenon of the singing arc, the variations of current produced by the superposition of the microphonic current to the current that feeds the arc develops according to the said law corresponding, but larger variations in the heat developed by the arc, and in consequence analogous variations in the volume of the incandescent gases which constitute the arc itself, and also in the temperature of the carbons; and these variations in volume are those which generate in the air sonorous vibrations, reproducing the vibrations of the microphone, thus giving rise to the singing arc.

The variations in the temperature of the carbon must be accompanied by similar variations in the intensity of the light emitted, which are revealed by the selenium receiver.

We must notice finally that the speaking arc can be transformed into a hearing arc. For this purpose it is only necessary to replace the microphone by a telephone, in order that this should repeat the words spoken near the arc, and concentrate upon it these words by means of a bell or funnel. Here we have the inverse phenomenon to that of

the preceding case; the variations in volume of the gases in the arc which are set up by the sonorous oscillations produce analogous variations in the resistance of the arc, and consequently we have in the circuit those variations of current which cause it to reproduce in the telephone the words pronounced in front of the arc itself.

Experiments and Applications.

The Bell-Tainter Radiophone.—This is a radiophone similar to that illustrated in Fig. 19, but which has a selenium receiver. The inventors, using solar light, obtained sounds perceptible in the telephone even when the distance

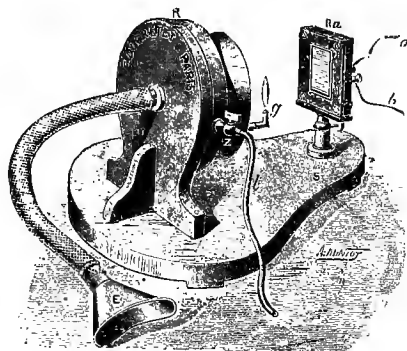

Fig. 22.

between the reflecting mirrors and the selenium was greater than 250 yards. Even when using as the source of light a candle only, they obtained a distinct sound, but only for a short distance.

The inventors then transformed their apparatus into a true optical telephone; capable of reproducing words, for which reason, at the time of the discovery, the Parisians said with enthusiasm, that Bell had succeeded in making light talk. One of the means employed was that of making use as a source of light of a small gas flame communicating with one of Koenig's manometric capsules (Fig. 22). This

capsule consists in a little box arc divided into two compartments by a sheet of indiarubber; in one of these compartments the illuminating gas or, better, the acetylene, which feeds the flame, enters; the other compartment communicates with a tube, at the extremity of which is placed a speaking trumpet, into which the operator speaks. The sonorous vibrations of the voice cause the membrane to vibrate, and these vibrations are transmitted to the gas feeding the flame, which therefore undergoes variations in brilliancy corresponding to the sonorous vibrations.

The resistances of the selenium *Ra* that receives the light of the little flame undergoes similar variations, that are reproduced in the telephone connected to the wires *a* and *b*, which therefore reproduces the words uttered before the speaking trumpet.

In order to reach greater distances of transmission, the inventors used in preference another method, which consists in causing the light, which has to transmit the sound, to fall on a very thin sheet of silvered mica or glass, behind which the words are spoken.

The light that falls on the silvered face of the lamina is reflected as in the case of Fig. 19, and is projected by lenses towards the receiving station, where it is concentrated on the usual selenium receiver.

The sonorous vibrations cause the specular lamina to vibrate and modify the form of its surface, thus varying in correspondence the distribution of the light of the reflected beam, and at the same time of the light concentrated upon the face of the selenium receiver.

The telephone which is inserted with this therefore reproduces the sound emitted behind the mirror.

The inventors carried out experiments at Washington, and at a distance of 213 metres the transmission of speech succeeded perfectly; by using the more powerful means, which are now at our disposition, they would certainly reached much greater distances.

The Mercadier Radiophone.—This is a radiophone with a thermophonic receiver. The transmitter is similar to that just described; it consists in a thin, silvered sheet, which closes the bottom of a speaking trumpet. The light of the sun, or that of an electric arc, is reflected from the back

surface of the sheet, and concentrated upon the receiver at a distance. This latter consists in a little tube of glass with very thin walls, closed at one extremity, inside which is placed a minute sheet of smoked mica. At the open extremity of the tube is placed an indiarubber tube, which can be brought near the ear. The beam of light of variable intensity which falls upon the little receiving tube produces on the lamina of mica vibrations similar to those set up on the silvered sheet, and the ear takes cognisance of the words pronounced in front of this latter.

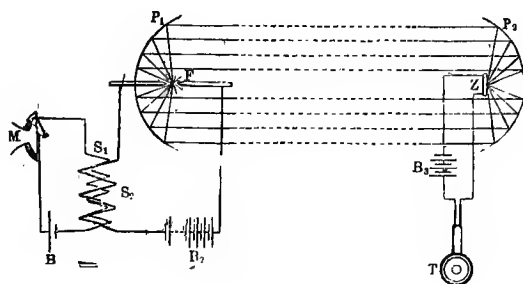

Fig. 23.

Simon and Reich's Radiotelephone.—The principal parts of this are represented in our Fig. 23. It is based upon the property of the singing arc, which we described in the portion of this chapter devoted to theory. Here the circuit of the microphone M acts inductively on the circuit of the arc F . This is placed in the focus of a parabolic mirror P_1 , which sends the light on to the parabolic receiving mirror P_2 , by which it is concentrated on the selenium apparatus Z .

The telephone T placed in circuit with this latter serves to listen to the sounds transmitted. In reality the circuits in the two stations are somewhat more complicated than shewn in Fig. 23, as they comprise (see Figs. 24 and 25) the capacities C in shunt, resistance R , and self-induction bobbins I in series, which serve to render transmission more regular.

Figs. 24 and 25 represent a complete arrangement of the most efficient kind, the first for the sending and the second for the receiving station; it would be possible, however, to

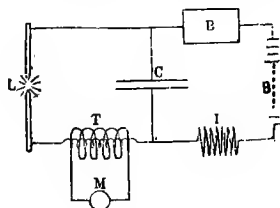

Fig. 24.

employ in the sending station, the apparatus without transformer, as shewn in Fig. 21.

The inventors found it preferable to use in these trials short arcs taking currents of small quantity, partly because the variations in the intensity of the light are more sensible

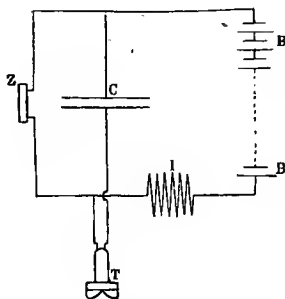

Fig. 25.

and more effective in their action on the selenium receiver, and partly because they lend themselves in this case to be concentrated with greater precision by the parabolic reflectors.

At the Electro-Technic Exhibition of New York in 1899, use was made of this apparatus, substituting, however, for the

selenium receiver a radiophonic one, consisting of a small glass balloon filled with filaments of carbon and communicating with tubes of indiarubber to be applied to the ear. The distance between the two stations was about 125 yards, and it was considered that at the receiving station the sound had an intensity of about one-third of that which they possessed at the sending place.

Ruhmer's Radiophotophone.—His arrangement is similar to that shewn at Fig. 23; a Drummond light takes the place of the speaking arc, and a little tube of glass containing small grains of carbon placed in circuit with a battery and a telephone, replaces the selenium receiver.

The Drummond light is produced by a lighted jet of a mixture of oxygen and hydrogen, which impinges upon a lime or zirconia cylinder; Ruhmer applies behind this cylinder the diaphragm of a telephone, which itself is placed in circuit with a microphone before which speech is effected. The vibrations of the telephone cause the lime or zirconia cylinder to vibrate, and corresponding vibrations are produced in the intensity of the variations thrown off by the lamp.

These radiations on reaching the receiving radiophone heat it more or less according to the calorific intensity of the incident beam; the little grains of carbon therefore oscillate, thus modifying the resistance of the circuit, so that the receiving telephone reproduces the sounds emitted before the sending microphones.

Clausen and van Bronck's Radiophone.—The German philosophers, viz. Clausen and van Bronck, have lately presented the Academy of Science with one of their special and perfected apparatus, in which the acetylene light is utilised in order to influence at several kilometers distance (a mile is equal to 1.6 kilometers) the thin sheet of selenium of the receiving apparatus, and thus establish communication.

“At the transmitting end the vibrations of a speaking trumpet or mouthpiece are amplified by a microphone and transmitted to a telephonic apparatus that determines the variations of the luminous power of the acetylene jet. The luminous rays are directed to the receiver by means of an ordinary lens. The receiving apparatus is fitted with a large parabolic reflector, and in its

focus is placed a little sheet of selenium. The conducting power of the selenium sheet for electricity is proportional to the quantity of light received, and thus all variations of light emitted are rendered evident by it being placed in circuit with a telephonic apparatus, calls into action the bell thereof, at the same time placing the receiver in a condition to receive the communication from the transmitter."

CHAPTER V.

ULTRA-VIOLET AND INFRA-RED RADIATION SYSTEMS.

Theoretical Principles.

IT is admitted by physicists that, as sound is the product of vibrations in the air or other elastic bodies, so light is produced by vibrations in the ether, and, since sound varies in pitch with the number of vibrations, so light with the change in the number of its vibrations, changes in colour. Except only that luminous vibrations are much more rapid than sound vibrations, for while perceptible sounds are comprised within a range of from 16 to about 27,000 vibrations per second, visible vibrations are comprised within a minimum of 400 billions (red rays) and a maximum of 800 billions (violet rays) per second.

Beyond these said limits, it is possible still to have vibrations in the air and in the ether, but the ear is as deaf to the former as the eye is blind to the latter.

The vibrations in the ether, which are slower than 400 billions, give rise to the vibrations which are known as infra-red, those which are more rapid than 800 billions produce the so-called ultra-violet; and both these are capable of producing effects which reveal their presence. For example, the infra-red warm the bodies on which they fall, and are thus rendered evident by certain special instruments, such as bolometers and thermo-electric piles; and the ultra-violet shew their presence by their photo-chemical effects, being capable of impressing a photographic plate, as may be seen these invisible radiations retain some of the pro-

erties of visible radiation, but they also present special ones, and it is just one of these special properties of the ultra-violet rays that has been utilised in one of the systems of wireless telegraphy. This property, discovered by Herz in 1887, and utilised for this special purpose by Professor Zickler in 1898, consists essentially in the faculty which the ultra-violet radiations have of facilitating the discharge of the sparks between two bodies electrified in opposite sense.

If, for example, we gradually separate two little balls, between which are passing the sparks from a small Ruhmkorff coil (see Chapter VII.), we shall come to a point in which the sparks will cease, the difference of potential between the two little balls being no longer sufficient to overcome the resistance of the air lying between them; but the sparks will reappear if between the two little balls ultra-violet rays be allowed to fall, and will disappear with the disappearance of these latter. In other words, the potential required for the discharge is lowered under the action of the ultra-violet rays.

The ultra-violet rays may be projected to a distance in the same manner as luminous rays, and it is easy to understand how, by rendering the beam of ultra-violet rays which fall upon the coil from a distance *intermittent*, it is possible at will to produce a series of sparks, of longer or shorter duration, corresponding to the dash and dot of the Morse alphabet, and thus establish telegraphic communication between the two stations.

In order to understand the particulars of the apparatus with which Zickler put this principle in practice, it is necessary to know some of the means of producing and of intercepting these ultra-violet radiations, and of the devices that the study of the Herz phenomena have suggested, to render the action of the ultra-violet rays more efficient in the determination of the spark.

In order to obtain ultra-violet rays, it is necessary to have recourse to bodies rendered luminous at a high temperature, to which do not, however, omit pure violet rays, but these mixed with luminous radiations and infra-red rays. The sun's light contains ultra-violet rays, but of little efficacy for the phenomenon in question, probably because their vibrations are still too slow: it is likely that the sun

emits ultra-violet rays of higher rapidity, but these may be absorbed by the lower strata of our atmosphere.

The magnesium lamp is richer in ultra-violet rays, but the most efficient radiations are furnished by the electric spark, better if produced between cadmium, zinc, or aluminium electrodes, also by electric arc lamps, more especially if, as recognised by Righi, the positive carbon be replaced by a rod of zinc.

Usually for our purpose, recourse is had to the arc light, as being more convenient and more constant as a powerful source of ultra-violet rays. These have, like luminous rays, the power of traversing, with greater or less rapidity, many bodies, and, as there are bodies which are transparent, and others which are opaque to ordinary light, so there are some which are transparent to these ultra-violet rays, that is to say, they allow them to pass almost completely, while there are others which are opaque, and intercept or absorb them completely, or almost completely; and although luminous vibrations are analogous to them, except in the greater length of its wave, not all the bodies that are transparent to the former are likewise to the latter, and *vice versa*.

For example, a thin sheet of glass or of mica, both of which are exceedingly transparent to the light, intercepts almost completely the ultra-violet rays, whilst a thick sheet of celluloid, which is hardly transparent to light, allows the ultra-violet rays to pass freely.

In repeating Herz's experiments, it is sufficient, therefore, to interpose between the source of light and the sparking balls of the coil, a sheet of glass, in order to cause the flow of sparks that the said rays have set up to cease, whereas the interposition of a xylonite sheet would have no effect.

There are, however, other bodies, such as quartz, capable of being traversed equally well by both kinds of radiation, and use is therefore made of lenses and sheets of quartz, when a medium is desired that shall give passage equally well to the visible radiation as to the ultra-violet, while, on the other hand, *glass* sheets or lenses are made use of when it is necessary to allow the luminous rays only to pass.

One of the circumstances that favour the manifestation of the Herz phenomenon is the rarefaction of the gas in which

sparks pass when it is acted on by the ultra-violet rays. For this reason, in practice, it is preferable to place the electrodes between which the sparks are to pass inside recipients in which a vacuum can be produced; it is, however, to be noted that rarefaction must not be carried too far in order that along with the spark discharge there should not be formed that other form of discharge that is seen in the ordinary vacuum tubes. Naturally, it is necessary that the said recipient should have the sides through which the ultra-violet rays have to pass closed by a lamina of quartz or some other bodies that does not absorb them.

Finally, in the application of these facts, it must not be forgotten that E. Wiedemann and Ebert have shewn that in the production of the Herz phenomenon it is not necessary that the ultra-violet rays should strike both the electrodes between which the spark has to pass, but it is sufficient that they should strike the negative (cathode), and it is immaterial whether they do or do not strike the positive (anode), and whether they traverse, or do not traverse, the gas lying between them.

Ultra-violet Ray Systems.

Zickler's Apparatus.—Fig. 26 is a sectional view of the transmitting apparatus used by Zickler in his system of

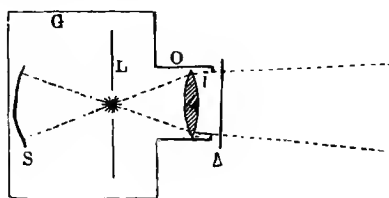

Fig. 26.

telegraphy. Inside the lantern *G* is placed an arc lamp *L*, which serves as the source of luminous and ultra-violet rays; the arc is in the centre of the figure of the spherical mirror *S*, and also in the focus of the quartz lens *I*. This latter projects outside the lantern not only the rays that the

arc send directly to it, but also those which the arc sends on to the mirror S , and that this re-concentrates on to their point of departure. The rays issuing from the latter in a parallel beam are in a condition to be sent to a distance with the least loss of intensity; in their path may be interposed at will a glass screen Δ . When the rays arrive at the receiving station, they are gathered by the receiving apparatus figured in 27. The two electrodes between which the spark which announces the arrival of the ultra-violet rays pass, are a little disc of platinum and a

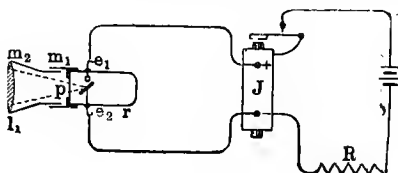

Fig. 27.

small metallic ball placed at a short distance the one from the other, within a glass recipient r closed hermetically at p by a sheet of quartz.

The two electrodes communicate by means of other two electrodes e_1 and e_2 welded into the glass, one with the positive wire and the other with the negative wire of a small Ruhmkorff coil J .

In the tube r the air is rarefied to a convenient point. The quartz lens l_1 concentrates upon the thin sheet p which is suitably inclined towards it, the parallel rays which arrive from the sending station. In both the stations use can be made of a concave mirror instead of the quartz lens, in whose focus is placed, in the one case the arc, and in the other the electrode, made of thin sheet platinum. Naturally, the mirrors must in this case be metallic, because those of glass would absorb the active radiation, and they must be arranged as shewn at Fig. 23, page 51.

Before allowing the passage of the ultra-violet rays, the resistance which is to be introduced into the circuit that feeds the coil, is adjusted in such a way that sparks just do

not pass between the electrodes contained in the tube r , but so that the very slightest diminution of resistance, or the slightest increase in the strength of the current feeding the coil, shall suffice to make the sparks re-appear.

The apparatus is then ready for receiving. The theoretical principles previously set forth enable us to understand without further explanation the mode in which the apparatus acts. At the sending station the ultra-violet radiations emitted by the arc lamp pass nearly all of them across the quartz lens I , and in case no sheet of glass be interposed in their path, they are projected in a parallel beam along with the luminous rays to the receiving station.

Here the ultra-violet rays are concentrated by the quartz lens on the sheet of platinum which constitutes the discharging cathode of the coil, a condition which we know to be necessary to the production of the Herz phenomena, whose manifestation is in this case facilitated by the two discharging poles being surrounded by rarefied air. The phenomenon then takes place: that is to say, under the influence of the ultra-violet rays, the potential required for the discharge of the coil is diminished; therefore since this finds its two poles at a potential hardly inferior to that necessary for the discharge without the intervention of the ultra-violet rays, under the action of these, a discharge takes place and a flow of sparks visible to the eye and perceptible to the ear occurs between the two poles.

This flow will last as long as at the sending station the sheet of glass which absorbs the effective rays *is not* interposed, and will begin again directly the said glass sheet be removed, and so on.

By manipulating the glass sheet in order that it should give free passage to the ultra-violet rays for longer or shorter intervals, there may be produced at the receiving station flows of sparks of longer or shorter duration, thus establishing correspondence by means of conventional alphabets of dots and dashes similar to that of Morse.

Zickler joined to his apparatus an ordinary telegraphic receiver, which was set in action by a current switched in by a suitable relay, placed in circuit with the secondary of the coil; closing or opening the circuit at the same moment in which the flow of sparks set up by the ultra-violet rays

began or ceased, so that it was possible to register dots and dashes in accordance with the flow of sparks of shorter or longer duration.

As the discharges of the coil are always accompanied by the emission of electrical waves, Zickler also obtained registration of the signals, by causing the printing Morse to act by means of one of the receivers ordinarily employed for telegraphy with electric waves.

Zickler, after having made several laboratory experiments, tried his system in the open air on the 25th of April, 1898, obtaining good results at a distance of 50 metres between the two stations: on the 6th of May the distance was increased to 200 metres, and on the 6th of October good results were recorded between the stations 1,300 metres apart. In this last case a powerful arc taking 60 amperes was employed, the light of which was directly projected to the receiving station by means of a concave mirror 2' 8" in diameter. The pressure of the air in the recipient containing the electrodes was first 340 and then 200 millimetres. Although the results thus obtained were promising, it does not appear that the system can be applied to communications on a large scale, especially after the far more grandiose results furnished by wireless telegraphy of the electromagnetic wave class.

Compared to optical telegraphy, Zickler's system has the advantage of lending itself better to secrecy, because optical signals can be seen within a very large circle around the station to where they are directed, whereas the signals of the Zickler system can only be discovered by means of a spark-receiving apparatus, since the eye does not perceive the difference between the rays that are emitted with or without the interposition of the glass screen. And this advantage of greater secrecy the Zickler system maintains, even as compared to the wave system, since the effective rays of his system can easily be directed in any determined direction, a thing which cannot be done with equal facility by the wave system, such as is used in wireless telegraphy.

Sella's System.—In this system the bundle of ultra-violet rays which starts from an arc lantern and a quartz lens similar to those shewn at Fig. 26 is rendered intermittent by the interposition of a revolving disc which carries near its

periphery a series of equi-distant holes, the whole length of one circumference, having for its centre the axis of rotation. A small electro-motor serves to actuate this rotating disc, and the speed of rotation of this disc can be regulated by altering the resistance in circuit.

At the receiving station, which may be at a considerable distance from the sending, the rays are as in the Zickler receiver figured at 27, concentrated by means of a quartz lens on a thin sheet of platinised brass, and inclined to an angle of 45° to the direction of the ray, this sheet of brass forming the cathode of a sparking receiver, the anode of which consists in a small sphere of platinum, with this difference, that these two electrodes, instead of communicating with the poles of a coil, communicate by means of a telephone with the discharge conductor of a powerful electro-static machine in action, which machine has no condenser fitted to it.

If the disc is held still so as to intercept the passage of light, the telephone, excited by the currents that accompany every discharge in the machine, gives a sound the pitch of which corresponds to the number of the said discharges; but if the disc turns slowly every time that one of the holes allows the passage to the beam rich in ultra-violet rays, these rays falling upon the cathode of the receiver, modify strongly the sound emitted by the telephone, so that in a given time may be heard as many modifications in sound as there are holes, which in the meantime pass in front of a lantern.

With the increase in the velocity of rotation of the disc, a single sound is given out, whose vibration number corresponds to the interruptions to which the beam has been subjected. Therefore, this sound can be made sharper or flatter by increasing or diminishing the velocity of the disc.

In order to transmit by this means acoustic signals which can be interpreted by the Morse code, it is sufficient to manipulate a sheet of glass in such a way that it would allow the rays to pass for a longer or shorter time according to whether it is desired to transmit a dash or a dot. If it is desired that the sound emitted by the telephone should be audible in a large room or hall, it is sufficient

to insert in the discharging circuit of the machine the secondary of a Ruhmkorff coil in place of the telephone; while in the primary circuit of the same coil the telephone is connected up; this acts as a transformer, and to this may be added at the mouthpiece a conical trumpet.

The experiment may be varied so as to realise a true transmission of sound to a distance. To this end the periodical illumination, instead of being effected by the revolving disc, is obtained by means of a mirror attached to a membrane, which is fitted to the bottom of a trumpet or horn, before which speech is made. The mirror is arranged so as to reflect from the one to the other station the light issuing from the latter. If any sound be now produced before the membrane, this oscillates along with the mirror; the reflected beam therefore undergoes angular changes of position which render periodic the illumination of the cathode of the receiver, and the telephone emits a sound having equal periods to that which was emitted in front of the membrane.

Dussaud's System.—Dussaud causes the intermittent beam of ultra-violet rays to fall upon a fluorescent substance, near which is placed a receiver of the selenium type similar to those used in the radiophonic system (Fig. 20). Under the influence of the luminous rays, and more especially of the ultra-violet, the fluorescent substances become luminous, and therefore act upon the selenium receiver, which, by means of a telephone, transform in the manner above described the variations in luminous intensity into variations of sound intensity.

In this manner it is possible to transmit signals by dot and by dash, and even to transmit speech when the variations of luminous intensity are set up by the sonorous oscillations emitted by him who speaks.

Infra-red Radiation Systems.

Albert Nodons begins by denying that any practical importance can arise from the Zickler system, because the violet and the ultra-violet rays are so easily absorbed by dust, by watery vapour, and by the gases that sometimes are found in the atmospheric air, the rising of a fog

absorbing, as has been shewn experimentally, the working ultra-violet rays, that this would be sufficient to interrupt any communication which in fine weather had been established even at a very small distance. This depends upon the very shortness of the ethereal waves constituting the ultra-violet rays, because the absorption of ethereal waves of any nature, either by the gases or by the aqueous vapour in the atmosphere, is so much the greater as the waves themselves are shorter, and therefore their rapidity of vibration is greater. He cites as an example the very short waves which constitute the Rontgen rays, and which are absorbed by very small strata of air, whereas the Herzian waves, which, as we shall see, are longer, and their vibratory rate much smaller, traverse with great facility air, aqueous vapours, and atmospheric precipitations (fog, rain, etc.), as well as the greater part of solid and liquid bodies. It is just in consequence of this property that the Herzian waves lend themselves so advantageously to wireless telegraphy. Besides these waves, the dark calorific rays (infra-red) also partake of the property of traversing the atmosphere loaded with aqueous vapour or with dust without suffering sensible absorption, and this though they are much shorter than the Herzian waves. For this reason these dark heat waves may be considered as adapted to wireless telegraphy, the more so as there is no lack of powerful calorific sources necessary to their production.

In such applications the receiver may be a bolometer or a thermo-electric pile, two instruments which are highly sensitive to calorific rays, by means of which a relay can be made to act as is employed in wireless telegraphy in order to cause the signals received to be registered by a suitable printing apparatus.

The transmitter should consist, in the most intense possible source of dark calorific rays, of a parabolic reflector placed behind it in order to render the rays parallel, and of a screen, that by intercepting or permitting the transmission of the rays would take the place of a telegraphic key.

It does not appear that any attempts to transmit telegraphic messages by this method have proved satisfactory.

CHAPTER VI.

WIRELESS TELEGRAPHY BY ELECTRIC WAVES.

Production of Electric Waves.

Herz Oscillator.—Being desirous of keeping as far as possible within the limits indicated by the title of the present book, we will not enlarge farther on the very interesting subject of electric waves, and we, therefore, refer the reader, who is desirous of extending his knowledge on the above, to another volume of the "Library of Electricity," by Professor Garbasso, entitled: *Fifteen Experimental Lessons on Light, considered as an Electro-magnetic Phenomenon*, wherein, in a readable form, the theory of Electric Waves is treated, and the full analogy which exists between the phenomena which can be obtained from electric waves, and those from a luminous source is demonstrated.

We shall here limit ourselves with regard to electric waves in stating only that which is necessary to the comprehension of the principle of their application to wireless telegraphy.

The fundamental apparatus with which Herz produced electrical oscillations is that represented in our Fig. 28.

Two small solid brass balls, $b b'$, placed at a small distance from one another communicate, by means of two metal rods, with two large hollow metallic spheres $A A'$. The arrangement $A b b' A'$ of the four balls of the two conducting rods constitute the so-called Herzian oscillator, which is the producer of the electric wave. In order to cause it to act, it is necessary to charge the two parts $A b A' b'$, of which it is made up, to a high potential of opposite signs; to this end

the said parts may be connected, the one to the positive pole and the other to the negative of a static electric machine, but it is more convenient and efficient to join them as indicated in the figure with the terminals of the secondary circuit of an induction coil, which become charged in contrary sense at every interruption of the contact breaker.

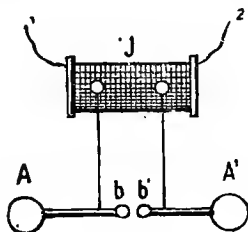

Fig. 28.

As fast as the spheres $A A'$ become charged, their opposite electricities tend to neutralise each other by discharging across the interval between b and b' ; but finding at this point an insulator such as air, it is necessary, in order that a discharge may take place, that the difference of potential between b and b' should reach to a value sufficiently elevated that it may overcome the resistance of the interposed dielectric.

If the distance between b and b' be not too great for the power of the coil, the difference of potential necessary to the discharge is quickly reached, when this takes place producing between the points b and b' a brilliant spark.

The phenomenon may be compared to that which would take place in the hydraulic apparatus represented at Fig. 29, in which two tubes $A A'$, communicating the one with the other, should have along the channel of communication a very thin elastic diaphragm $b b'$, and a pump P which draws the water from the tube A to inject it into the tube A' . As the dislevel between the A and A' increases, the membrane $b b'$ becomes more and more tense in the direction indicated by the dotted lines until, when the dislevel has reached a certain limit, the elastic membrane $b b'$ gives way, and the water discharges itself from the tube A' into the tube A .

In the analogous electrical phenomenon these portions have their counterpart, the membrane $b b'$ by the gap $b b'$ in Fig. 28; the two tubes $A A'$, by the two spheres $A A'$, the dislevel between A and A' by the difference of potential between the two spheres, and the pump P by the induction coil J , which serves to charge the two spheres.

But the analogy between the two cases continues to shew itself even after the discharge has taken place. In the hydraulic example, as soon as the membrane has broken and there has been established ample communication between A' and A , the water from A' rushes into A , raising the level on this side; but when the two levels have reached to an equal height, the motion of the water does not cease

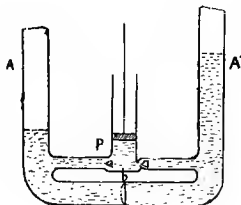

Fig. 29.

immediately, but, owing to the velocity acquired, it continues in the same direction as before, carrying the level in A higher than that in A' ; then the water recedes, and the level in A' becomes higher than in A , then again recedes, and so on until after a number of oscillations, the amplitude of which decreases gradually, the water comes to equilibrium, presenting equal levels in the two tubes.

Similarly, during the discharge of the electrical oscillator $A A'$ (Fig. 28), the potential (electrical level) is not immediately rendered equally in A and in A' , but if at first it had been higher in A' , it makes itself higher in A , and then again in A' , and so on alternately, so that the conductor $A A'$ becomes the seat of successive and extremely rapid currents, first in the one direction and then in the other, which constitute the so-called electrical oscillations. In order to render the hydraulic phenomenon more

directly comparable with the electric, it will be necessary to suppose (that which in practice would be difficult to realise) that at every oscillation the elastic membrane which divides the two tubes should reconstitute itself, since the rupture of the membrane has to correspond with the breaking-down of the dielectric by the discharge of the spark. Because after the passage of the first sparks which rendered the explosive interval $b b'$ for the time being a conductor, this returns to be an insulator as it was at first, and therefore every oscillation is accompanied by a new spark; these oscillations becoming gradually weaker and weaker, follow upon one another as long as the energy communicated to the vibrating system by the first spark of the induction coil

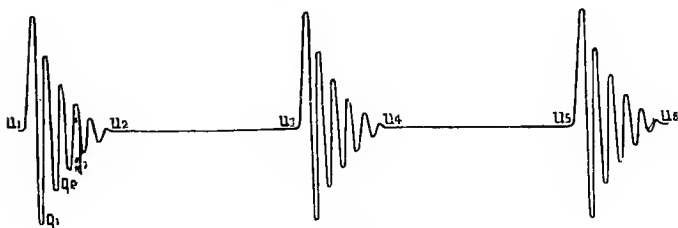

Fig. 30.

be not so much weakened as to no longer allow that the discharge should take place across the sparking interval. But the next spark from the coil restores to the system the energy lost, and a new series of waves succeeds, and so on as long as the coil works.

At Fig. 30 is represented graphically a series of these waves of diminishing amplitude, produced by three successive discharges of the induction coil.

The similitude between the hydraulic and electrical phenomena shews itself also in other points. So if in the hydraulic example the channel of communication between A and A' (Fig. 29) were somewhat limited, the water would pass from the one tube to the other with less velocity, and would surpass by little the level of equilibrium, and would come to repose after a lesser number of oscillations; this might be expressed by saying that the oscillations would

be more damped ; finally, if the channel of communication were very minute (indeed capillary), the water passing from the one tube to the other with very trifling velocity would not overpass the equilibrium level, and therefore the hydraulic oscillations would be wanting altogether. In the same manner, with the increase of the resistance that the conductor $A A'$ (Fig. 28), and principally the interval $b b'$, present to the passage of electricity, so the electrical oscillation would undergo an increasing damping effect ; that is

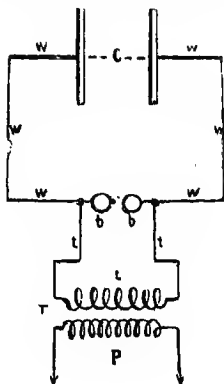

Fig. 31.

to say, a lesser number would be produced between the one and the other spark from the coil ; and lastly, when the said resistance exceeded a certain determined limit, electrical vibrations would no longer shew themselves.

On the other hand, if the resistance be diminished and the capacity of the one and the other be increased by bringing them closer together, somewhat like a conductor closed upon itself as shewn at Fig. 31, in which $p t$ represent the primary and the secondary of the induction coil, the damping effect will be very small. In Fig. 32 are compared the damped oscillations produced by a Herz oscillator with those of a Herz resonator with an almost closed circuit, in which the damping effect is very trifling.

From this it is easily understood that the production of electrical waves and their quicker or slower damping will depend on the dimensions and the proximity of the conductors in which they are set up, conditions that theory can foresee and that experiment has verified.

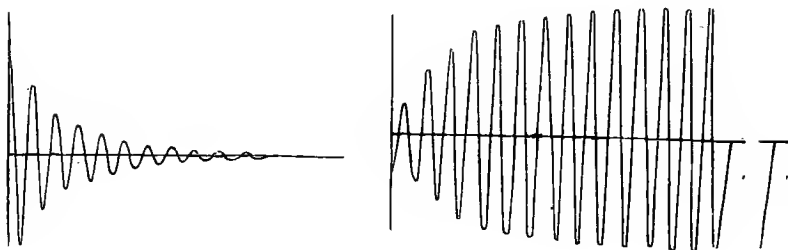

Fig. 32.

Electric waves, like every other kind of undulatory motion, are characterised by various elements, some of which are dependent on the nature of the vibrating body; others on the period or duration of the oscillations, their amplitude, and the damping to which they are subjected; others again to the medium in which the vibrations are propagated; and lastly, on the velocity of propagation and the length of the wave.

The period or duration of the Herzian electric vibration is, as we have said, very short. The number of vibrations that are effected in a second (frequency) can be counted by millions, and therefore its period is measured in millionths of a second. It depends on the size and on the shape of the oscillator, and it may be augmented: first, by increasing the electrical capacity of the system, that is to say, by increasing the length and the thickness of the wires, rods, communicating between the spheres $b b'$ $A A'$ (Fig. 28), or by making the terminal conductors $A A'$ much larger, or by substituting for these conductors having large capacity, such as electrical condensers as shewn in Fig. 33, which represents a Herzian oscillator similar to that in Fig. 28, in which the two terminal capacities $A A'$ consist in two con-

densers with their outer coatings connected to earth; secondly, augmenting the self induction (see page 30) of the system by increasing the length of the wires from A to A' , or, better still, by wrapping these round in the form of a spiral, and yet more by introducing into such spirals bundles of soft iron wire.

On the other hand, it is possible to diminish the frequency by proceeding in the contrary manner, that is to say, by diminishing the size of the oscillator to the point even of suppressing the terminal spheres A and A' and the connecting rods, so as to reduce the apparatus simply to the little balls b and b' . The oscillators used by Herz had periods varying from one-fiftieth of a million to one five hundredth of a millionth of a second; in other words, they gave rise to

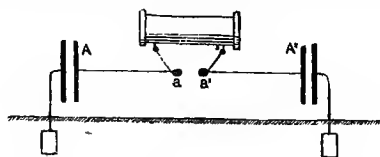

Fig. 33.

fifty millions or to five hundred millions of oscillations per second. These frequencies are intermediate between the acoustic waves which are to be counted by hundreds only per second, and the optical waves which amount to hundreds of billions per second. The length of the wave in the medium of propagation is the constant distance which lies between the points in which one wave begins and a successive wave starts, and it is also the distance that the wave traverses during one complete vibration; it is therefore the product of the period by the velocity of propagation, and as these electro-magnetic waves in propagating themselves in metals or in the air attain a velocity equal to that of light, that is to say, of 300 millions of metres in a second, so the above mentioned electric waves used by Herz had a length in metres of from $1/50,000,000 \times 300,000,000$ up to $1/500,000,000 \times 300,000,000$, that is to say, from 6 metres to 60 centimetres. Even when reduced to these limits, the Herzian electric waves had a length several hundreds of

thousands times greater than the optical waves, to which Herz, and other scientists who continued his work, desired to shew they were identical.

It was then their great desire to bring down the frequency and to diminish the length of the wave in order to be able to reproduce as faithfully as possible with the electric waves the analogous phenomenon of the optical wave. This intention was realised by using vibrators which gave waves of a few centimetres or even of a few millimetres in length.

Marconi's Oscillator.—In the application which was afterwards made of electric oscillations to telegraphy, use was primarily made of oscillators giving a very short wave length, which were reduced to simple exciting balls, but it was soon recognised that on returning to the primitive Herzian oscillator furnished with terminal capacities the distance of transmission was increased, and the more so when to the wires that connected the spheres to the terminal capacity a vertical position and a great length was given. As this long wire had in itself sufficient capacity and self-induction, the use of a terminal capacity was found superfluous, and it was found sufficient to adapt a single wire, that is to say, to connect one of the small balls to a long vertical wire (wing). It is evident that by increasing the length of the vertical wire, the capacity and the self-induction of the system were also increased, as the period of vibration and the length of the wave were also augmented. In order to maintain in the system the symmetry of the Herzian oscillator, it would have been necessary to connect the other exciting sphere with another wing equal in size to that attached to the other little ball and directed in the opposite sense; it was found that this second wing could be done away with if replaced by a good conductor to earth from the corresponding small ball; in fact this communication to earth was recognised as being one of the most efficacious means for augmenting the distance of transmission.

The oscillator thus modified took the form given in Fig. 34, in which b b' represent the little spheres at the explosive point T , the sheet which puts b into communication with earth A , the wing or sky rod in communication with b' , and R the induction coil. We shall call this exciter

by the name of its inventor, "Marconi's first system Exciter."

The length of the wave emitted by this oscillator can be, with pretty close approximation, considered equal to that emitted by a wire rectangle, having a side length equal to the height of the sky rod, and therefore equal to four times the length of the sky rod itself. As a matter of fact the length of the wave, according to the definition already given (page 71), is the space which the electric impulse traverses during one complete vibration, and as one complete oscillation is performed while the electric impulse which starts from b arrives in A and returns to b , and is followed by an

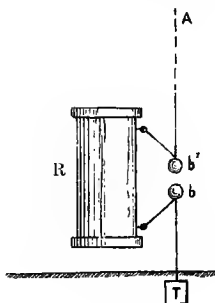

Fig. 34.

impulse of opposite sign, that accomplishes the same travel, during one complete vibration the electric impulse will traverse four times the length of the sky rod; the length of the wave along the sky rod will therefore be equal to four times the length of the sky rod itself, and will have the same value even for the waves transmitted in space; since, as has already been said (page 71), the velocity of transmission of electric waves in air and in metals is equal to the velocity of light.

The case is analogous to that of a sounding tube or pipe, closed at one extremity. During one complete vibration such a tube is traversed twice, once in the outward travel and once in the return of the condensed wave, and again twice by the rarefied wave, and for that reason gives as its

fundamental note, one, the length of whose waves is equal to four times the length of the tube.

Besides the fundamental, the sky rods, like the sonorous tubes, can give other vibrations, having wave lengths three, five, or seven times smaller, but the fundamental wave is found to be the most efficient.

Direct experiment confirms this view, that the waves emitted by the sky rod are very long; in fact Lt. Tissot, to whom we owe the interesting systematic studies on wireless telegraphy, has been able, by means of a rotating mirror, to decompose into many sparks, the spark emitted by the oscillator fitted with sky rod; this suffices to shew that the oscillations are much less rapid than those employed by Herz, which are not separable by the rotating mirror; moreover, from the distance of the images given by the single sparks in the mirror, he was able to calculate the period, which was found to be for 0.06 to 1.8 millionths of a second, and therefore hundreds of times longer than that of an ordinary Herzian oscillator.

Lecher's Oscillator.—Lecher has given to the Herz oscillator a form suitable to allow the waves which it sets up to

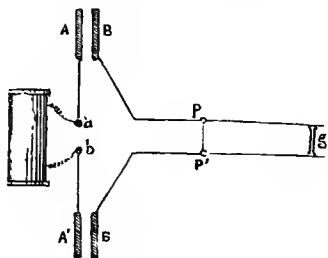

Fig. 35.

be propagated along metallic wires instead of in the air. In this oscillator (Fig. 35) the two terminal capacities $A A'$ of the Herz oscillators (Fig. 28) are replaced by two metallic sheets $A A'$, which he calls primary sheets, at a little distance from which are placed two other metallic sheets parallel to the former $b b'$, called secondary sheets, from these start two

wires which, after being brought near to one another, are continued parallel to one another. Along these parallel wires a third short metallic wire $p p'$ folded twice at right angles can be slid along, and this he calls a bridge or slider. When the sparks from the coil are produced between a and b , the system which is almost closed, that is comprised between the spark and the bridge, is the seat of electro-oscillation, having a well-defined period, these oscillations are transmitted to the wires that are beyond the bridge or slider with an intensity which is greater in proportion to the length of the wire constituting the bridge.

These oscillations can be recognised by any kind of resonator, but Lecher made use of a Geissler tube g placed across the wires, which became illuminated with a brilliancy which was more intense in proportion to the intensity of the electric oscillations at the two points between which it was inserted. By sliding the bridge along the parallel wires, it is possible to vary within rather large limits the period of vibration of the system. Although the Lecher oscillator has not received any direct application to wireless telegraphy, nevertheless the transmitting apparatus of some of the radio-telegraphic systems come, as we shall see, very nearly to the form given to this oscillator.

The Propagation of the Electric Waves.

Let us now try to give a reason for why and wherefore an oscillator, which is the seat of electrical oscillations, can exercise its action at a distance. For this purpose it will be necessary to study, in the first instance, the action of the Herz oscillator, whence we can pass to that of Marconi.

Considering the case of the apparatus shewn at Fig. 28, let us bear in mind that at the instant at which the sphere A of the oscillator finds itself at a positive potential, and the sphere A' at a negative potential, if at a given point, say P (Fig. 36) of the surrounding mediums, were placed a small body positively electrified, this would be repelled by A and attracted by A' , and would travel from A to A' , following a certain line $A P A'$, which is called the line of force, or the line of tension, analogous to the line of magnetic force,

which we have noticed at Fig. 3, page 10. If the charge of $A A'$ remained constant, the electric force in P would also remain constant; but if the charges were increased or diminished, the electric force in P would at the same time increase or diminish.

It is admitted that the greater or lesser intensity of electric force is due to a state of greater or lesser tension (polarisation) of the ether contained in the electric fields,

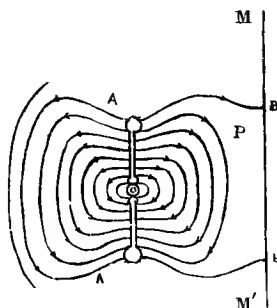

Fig. 36.

that is to say, in the space wherein these electric forces manifest themselves.

If at a certain distance from the exciter there should be a conductor MM' , the lines of force would bend themselves towards it, and would separate in two parts AB and $A'B'$, and it would become charged by induction, drawing from the medium a certain quantity of energy, it being understood, however, that the quantity of energy that it could acquire at different distances would diminish approximately in proportion to the cube of the distances, since, as all the lines of force are connected with A and A' to form a single electric field, and in order to produce an action at the distance d , all the ether contained in the volume of the sphere that has for its radius d must find itself in a state of tension. This accounts for the fact that actions which are simply electro-static or electro-dynamic are sensible only at distances which are relatively small. But if the discharges

between A and A' take place with that extraordinary rapidity which characterises the Herzian electrical oscillations, the phenomenon changes character; the lines of force which in the case of charges that are stationary, or charges and discharges at a slow rate, rest always with their

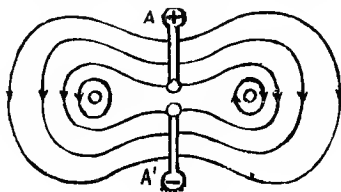

Fig. 37.

extremities on the conductors A and A' , in consequence of the violence of the discharge, detach themselves from these, and close upon themselves as shewn in Fig. 37, and propagate themselves into space with the velocity of light, carrying with them the energy arising from the tension of the ether enclosed by them, and thus become independent

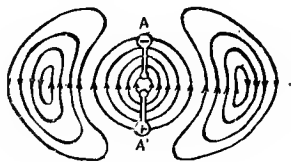

Fig. 38.

of whatever happens at the origin of the vibrations; precisely as happens to the acoustic waves which go on propagating themselves independently of the sonorous origin from which they emanated, and which waves persist even when the sonorous body has ceased to vibrate.

Our Fig. 38 represents the condition of the lines of force after the first half vibration has taken place, that is to say, after the advent of the first spark which discharges between the spheres, and whilst these are getting recharged in the

opposite directions, that is to say, while a second group of lines of force is getting ready in a direction opposite to that of the first.

Of these systems of independent waves there will be produced between the one and the other spark from the coil, as many as there are electric waves between the one and the other spark, that is produced in the oscillator, but the series will be reproduced after another spark from the coil.

If the vibrations of the oscillator are much deadened, as takes place in the Herz oscillator considered by us up to the present, which is greatly damped, they are small in number in each series, as is represented by our Fig. 30 at page 68, and between one spark and another of the coil there is also an interval of pause; but with other oscillators similar to that shewn at Fig. 31, page 69, the damping can be greatly reduced, so that the electric oscillations do not cease between each successive spark of the coil, and with these it is possible to have an uninterrupted emission of electric waves in space.

The emission on the part of the oscillators of this series of lines of force closed upon themselves, which transport to a distance the energy supplied to the oscillator by the coil, is that which constitutes the radiation of energy under the form of electrical waves, upon which is based the new system of wireless telegraphy, and which therefore takes the name of radio-telegraphy. Since the electric waves thus radiated are now independent of the vibrator which has produced them, they exercise an action that no longer depends upon the state of tension in the ether which is interposed between them and the vibrator, and therefore, although propagating themselves in all directions, they go on extending themselves indefinitely, acquiring more and more a spherical form, the intensity of their action will be in inverse ratio to the superficies occupied by them, and not to the volume comprised in them, and therefore in about the inverse square instead of being the cube of the distance from the centre of vibration.

But the modifications in the system introduced by Marconi have rendered this diminution even less rapid. In order to grasp the mode of action of the Marconi oscillator,

we must remember that the two contrivances that distinguish this latter from the Herz oscillator, contrivances of which the great importance has been recognised for the transmission of signals to a great distance, are the following :

1. To cause one of the two spheres of the oscillator to communicate with a long vertical rod (sky rod).
2. To place the other sphere in communication with earth.

By these means we pass from the Herz oscillator to that shewn at Fig. 34.

The system of lines of force which are thrown off by such an oscillator can be represented graphically as in Fig. 39,

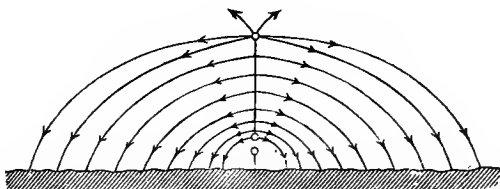

Fig. 39.

since the conducting soil constitutes a prolongation of the conductor taken to earth at $b T'$ (Fig. 34); the lines of force being compelled to pass from one conductor to the other, go from the insulated conductor to earth in the form of semi-circles, and the corresponding waves in space are hemispheres having the sky rod for a polar axis. At the act of the formation of the spark, if this have the desired quality, it happens as in the case shewn in Figs. 37 and 38, that the extremities of the lines that rest on the insulated metallic conductor are thrown off from this by the violence of the discharge, and they close upon themselves through the ground with the other extremities which have not left the ground. The systems of lines of force that are thrown off in successive oscillations by the oscillator through the sky rod are therefore represented in Fig. 40, where are shewn two systems of lines of force emitted in opposite directions in two successive half oscillations, and the lines of force that

start from the sky rod at the beginning of the following oscillation.

Transmission thus takes place almost entirely through the air, but it is completed by the surface of the earth, on which we may consider that the return currents slide to complete the lines of force, this taking place with greater ease if that surface is a better conductor; which fact explains the greater facility of transmission over the sea than over land.

These waves, which maintain continuous contact with earth, are not propagated throughout space, but undulate

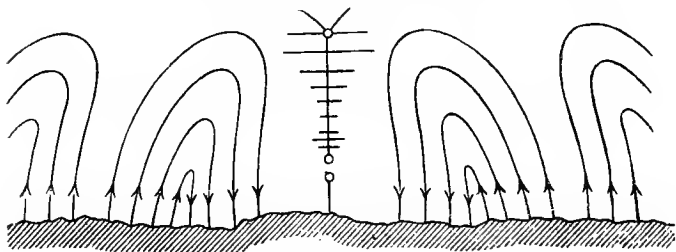

Fig. 40.

along the superficies and cannot be reflected by earth into space, as they would do if they were waves completely closed upon themselves, as those shewn at Fig. 38; this therefore prevents the dispersion of energy in any disadvantageous direction, and at the same time facilitates its transmission in a useful direction, that is to say in the horizontal; and in practice it is found that the intensity of waves thus produced does not diminish much more rapidly than the simple inverse of the distance from the centre of emission.

Besides this, such a constitution of waves allows them to follow the curvature of the earth's surface even when it presents undulations arising from obstacles of various nature, provided these have not dimensions that are too large in comparison to the size of the wave; from this is seen the desirability of using long sky rods which furnish

high and ample waves, and which are therefore capable of passing over obstacles (among which is the curvature of the earth), which may occur in transmission to a great distance.

As the sky rod is farther away from the receiving point, so the dimensions of the waves increase; therefore a distant obstacle will be more easily overcome by them than one which is near.

A phenomenon which is here met with is one which in physics is called the diffraction of the wave, and which shews itself more distinctly when the waves are long; as an effect, when the waves reach an obstacle, they are not stopped, but they flow round it, so that behind the obstacle the vibrations are still sensible.

The waves of the sea, for example, easily flow round the breakers, acoustic waves can make themselves heard even behind obstacles provided they are not too large: while optical waves, which are very small, leave behind opaque bodies a perfect shadow; except only in the cases where these obstacles are of very small dimensions, in which case they also present the phenomenon of diffraction and shew a penumbra.

In order to render our explanation as simple as possible, we have confined ourselves solely to the lines of electric force that emanate from the oscillator; we must observe, however, that as the oscillator should be considered as a conductor traversed by currents succeeding one another rapidly in opposite directions, and as from each conductor traversed by a current there emanates a magnetic force perpendicular to the conductor (see page 25), of such a nature as tends to arrange a magnetised needle perpendicularly to the conductor itself, so the emission of the lines of electric force which we have mentioned is accompanied by the emission of magnetic lines perpendicular to them, which, in the case of the sky rod oscillator will therefore take the form of horizontal circles, having for their centre the sky rod.

The intensity of magnetic force emitted by different points along the sky rod is greater in proportion as the current that traverses it at that point; so that the current is nil at the extremity of the sky rod (the node), that being the point of retrocession in the electric movement, while it is

greatest at the point where the spark occurs, the maximum intensity of the magnetic force corresponding to the lines that find themselves in the horizontal plane of the spark, that is to say near the ground; therefore the energy transmitted by the lines of magnetic force will also have its greatest efficiency in the most useful direction, viz. horizontally.

From this double emission of electric and magnetic lines of force the field produced by the oscillator has acquired the name of the electro-magnetic field, and the corresponding waves are called electro-magnetic waves.

On the Reception of the Electric Waves.

Having spoken of the production and of the propagation of electro-magnetic waves in their application to telegraphy, we now pass to consider the means of receiving them.

We have already seen, at page 76, that on meeting with the conductor, the lines of electric force bend upon themselves and break up when in contact with it, giving rise to a determinate movement of electricity along the same; in order to detect the presence of such electric movements, special apparatus called wave indicators or detectors are made use of; these can have many and various forms.

Herz adopted for his indicator the spark form, which he called, for reasons which we shall give later on (see page 88), resonators, the simplest of which consists of a straight wire of suitable length, in which is a gap at about the middle of its surface. If this wire be placed in the position of the right line MM' at Fig. 36, page 76, when it is struck by the lines of force parallel to it, the electric movement which manifests itself in it causes sparks to pass at the point of interruption; and these serve to indicate the arrival of the electric waves.

As in Herz's experiments, the transmission was to small distances; the energy which reached the above described indicator, provided it were suitably placed, was sufficient to cause it to act, but its sensibility would have been absolutely insufficient in order to signal to any great distance, the quantity of energy that in such a case would reach the receiving station being so very small.

-Fortunately a revealer or detector of electric waves was shortly afterwards discovered, called a *coherer*, gifted with so much sensibility as to render it comparable to the human eye, which acts with the smallest quantity of luminous energy, for which reason it has been happily designated "the electric eye." We will describe later on (Chapter VII.) various forms of coherer; suffice it now to say that the commonest is a tube containing metallic filings, which can be struck by a little hammer (called a decoherer). This tube, which is almost an insulator in ordinary conditions, becomes a conductor when affected by the electric wave, again returning to its insulating state if struck when the waves have ceased.

If the coherer be placed in circuit with a battery and any current indicator, say, for example, an electric bell, the advent of the electric wave will be immediately rendered evident by the ringing of the bell, which will relapse into silence with the cessation of the arrival of the waves, to ring again when a fresh wave reaches, and so on. It is easy to understand how, by emitting waves for a longer or shorter period of time, communication by means of the Morse system can be established.

At Fig. 41 we represent a receiver with coherer, T is the coherer, F the decoherer. When the coherer feels the action of the electric wave, it allows the passage of the current from the battery P , by means of which the electro magnet R becomes energised, and attracts its armature, which closes the circuit of the other electro magnet F , that, like an electric bell, causes the decoherer to strike upon the coherer and at the same time on a bell placed near it that gives the signal of the arrival of a wave. This arrangement was contrived by Popoff (1895) in order to give notice of the electric wave set up by storms, and which were sent off to the apparatus by connecting one of the extremities of the coherer to the sky rod of a lightning conductor; and this is the foundation of the present systems of reception.

Marconi, however, besides using the coherer, adopted for the reception of the waves another piece of apparatus, altogether different, which is called "a magnetic detector," which we shall describe later on, along with the other indicators. But the indicator, however sensible it be, has need of

a "gatherer" which shall bring to bear upon it the largest possible quantity of energy that the electrical waves carry into its vicinity.

Popoff, as we have already said, made use of a lightning conductor for this purpose; later on, in the first experiments of Marconi, large cylindrical or parabolic reflectors were used, that concentrated on the coherer, which was placed in their focal line, the electric waves which arrived to their

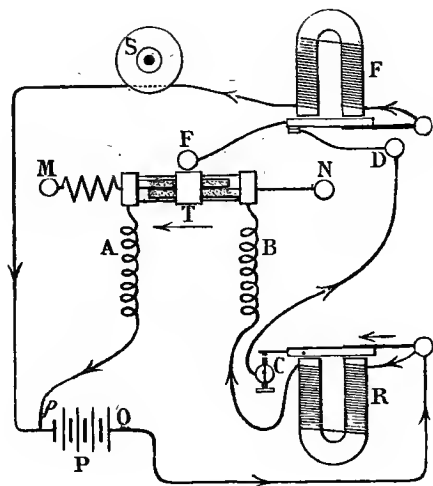

Fig. 41.

surface, precisely in the same way in which curved mirrors concentrate at their focus the luminous and calorific energy which falls upon them; it is, however, necessary that the mirror should have dimensions proportionate to that of a wave which they have to reflect; such a mirror became useless when such long waves as came into use were employed; for that reason it was happily substituted, even at the receiving station, by an antenna or sky rod identical with that which had been found so efficacious for the emission of the waves.

For this reason the receiver assumed the form diagrammatically represented at Fig. 42, which is analogous to 34 (page 73), representing the radiator in which the spark

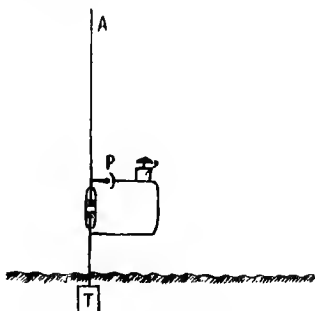

Fig. 42.

gap is replaced by a coherer, in communication on the one side with the sky rod *A*, and on the other with the earth at *T*, while instead of the coil a battery *P* with the signalling bell is placed in circuit.

We shall see later on, details which are adopted in the various systems in order to render the receiving apparatus more sensitive, and to cause it to register the messages.

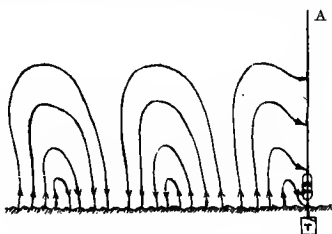

Fig. 43.

We may now study the cause of the efficiency of a receiver thus constructed in gathering the electro-magnetic waves which are radiated by the radiator in Fig. 34. If we suppose that near the sky rod *A* (Fig. 43) a succession of

electric waves of the form represented in Fig. 40 (page 80) should arrive, the lines of force will direct themselves, as in the case shewn at Fig. 36 (page 76), towards that conducting body in order to go to earth through it; the higher the sky rod is from the ground, so much the higher will be the lines of force that it would be able to grasp, hence the higher the potential to which the sky rod will be brought.

In consequence of the intersection of the successive lines of force, the sky rod will be brought to potentials alternately increasing and decreasing; it will therefore be traversed by electric oscillations, which, exciting the coherer, will throw into action the corresponding warning or registering apparatus. The lines of magnetic force which accompany these first, and which are constituted, as we have already said (page 81), of a parallel series of horizontal, concentric circles, cut the receiving sky rod *A* in a direction perpendicular to its direction; the antenna, or sky rod, therefore finds itself in a similar condition to that of the conductor *A' B'* at Fig. 11 (page 26), and therefore the effect produced by the successive lines of magnetic force will be the production of the induced currents of an oscillatory character, which will be transmitted along the mast, thus contributing to the excitation of the receiver.

The longer the mast *A* is, the greater will be the number of lines of magnetic force that will traverse it contemporaneously, and their concordant effects will become additive, and will produce along the mast an effect which will be greater in proportion to its length.

In their totality the lines of electro-magnetic force that strike against the receiving sky rod or mast will set up in it other electro-magnetic vibrations that may excite the receiving apparatus.

We have said "may," since although the coherer be, as we have said, a most sensitive apparatus, its sensitiveness is finite, and therefore, in order to throw it into action, it is necessary that the intensity of the vibration set up in the receiving sky rod should not be below a certain critical intensity which marks the limit of the said sensitiveness.

Now, in transmitting to great distances, the vibrations, even when emitted by the most powerful apparatus, reach so much weakened that it is necessary to adopt special

precautions in order to attempt to reach the point of critical intensity.

Syntony and Damping.—The two fundamental conditions necessary to carrying out this intention are :

1. That the sending and receiving apparatus be syntonised, that is to say, that they should have equal vibration periods.
2. That the vibrations radiated from the sending apparatus be damped as little as possible.

Since these two principles lie at the base of the radical improvements lately introduced into wireless telegraphic apparatus, it will be necessary for us to form an idea of their mode of action.

With regard to the first condition, we must observe that the receiving apparatus is a vibrator similar to the sender ; and therefore, on the first arrival of an electric impulse, electrical vibrations will be produced in it, having periods similar to those of the receiving apparatus ; the same effect will be reproduced with the arrival of every wave ; and since the effects awakened by the various systems of waves are additive, it would be necessary that the arriving waves should have the same rhythm or period as those which are set up in the receiving sky rods, otherwise the vibrations set up by the successive impulses will overlap each other irregularly, weakening and annulling each other, giving rise to that phenomenon which is known under the name of *interference of waves*.

And since the arriving waves have the same period as the sending apparatus, while those awakened have that of the receiving apparatus, it is needful, in order to obtain the greatest effect, that the two periods should be equal.

This is precisely the same as when it is desired to cause a heavy bell to ring. On first drawing the bell rope, the bell hardly moves, but the bell soon begins to swing with its own particular period of oscillation, and if the second pull be given at the moment when the bell begins its second swing, the effect of this latter will add itself to that of the first, and the oscillation will increase, and will continue so to do if every new pull be given at the instant that the bell begins a fresh swing, so that the effects will be added together, and the amplitude of the swing will go on increasing until at last the bell rings.

It is easy to see that in order to obtain the desired effect the ringer must adapt himself to give in a given time so many pulls to the bell rope as the bell itself will make oscillations in that time ; the two movements must therefore be syntonetic.

For this same reason the Herz resonators (page 82) are more efficacious in proportion as their length is such that their period of vibration shall equal that of the exciter.

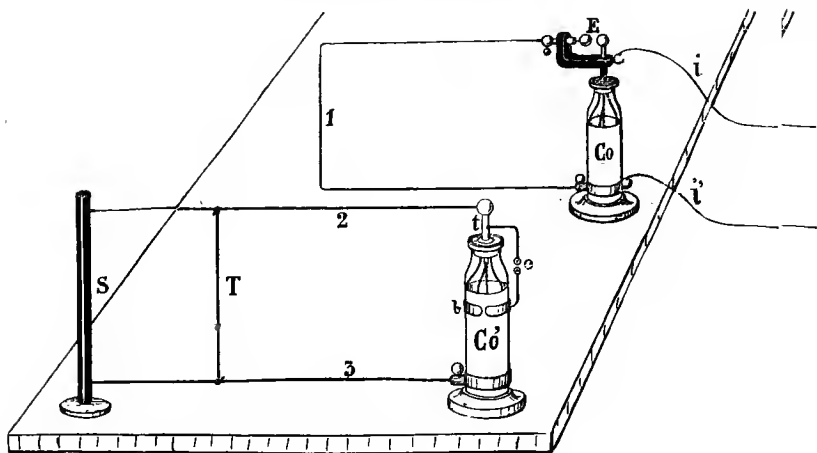

Fig. 44.

With the vibration of this latter, they also vibrate by electrical resonance, similar to the acoustic resonance, and it is from this that they derive their name.

A very convincing experiment known as the tuned or syntonised jars was devised by Lodge in 1894 to demonstrate electrical resonance.

The coatings of two Leyden jars Co Co' (Fig. 44) are put into communication by means of two metallic circuits, in which the one from the bottle Co has fixed dimensions, while that of Co' has variable dimensions, the wire T being movable along the parallel wires 2 and 3. The spark gap of the first jar is at E , while that of the second jar is at e .

If by means of the two wires $i i'$ the two coatings of the first jar be placed in communication with an electrical machine in action, brilliant sparks discharge themselves at E , and also at e when T is in such a position as to render the capacity of the two circuits identical, so that the wave periods are the same; but however little T be displaced either in the one direction or in the other, the sparks at e become weaker, and, under the influence of greater displacement, cease altogether.

In this experiment the electrical oscillations which are produced in the circuit of the jar Co excite others similar in the circuit of Co' , but perfect resonance only takes place when the two circuits have similar periods of vibration, that is to say when they are in syntony.

The apparatus of Lecher (Fig. 35) lends itself also very well to the demonstration of the principle of resonance. Having placed the Geissler tube near the free extremities of the parallel wires, it will be noticed that its luminous intensity is greatest when the bridge piece has a determined position; in this position the system comprised between the spark and the bridge is in perfect resonance with that included between the bridge and the end of the wires. By displacing the bridge from that position in either direction, the light in the tube becomes sensibly weakened, thus shewing that perfect resonance no longer exists; in fact, the vibration period increases in the system when the displacement of the bridge increases the length of the wire, and diminishes if the movement be such as to decrease it, so that the two periods cease, being equal.

The example of the ringing bell gives an explanation of the effect of damping also; since if with little force it were desired to ring the heavy bell, it would be necessary to accumulate the effect of many consecutive pulls; so in the case of electrical waves, if the energy of the incident waves be small, it is necessary that the effect of several waves be accumulated in order that the oscillations of the sky rod should reach that intensity necessary to excite the receiver.

If the exciter at the sending station produces waves which are very much damped, as, for example, those represented at Fig 30 (page 68), this cumulative effect cannot take

effect, and the result on the receiving sky rod will be that of the first one or two impulses; in this case it would be almost superfluous that the two apparatus be syntonised, and the coherer will only become excited in the case in which the amount of energy brought to bear upon the receiving sky rod be great, and therefore the distance to be traversed cannot be very great.

The oscillating sky rod is precisely in this condition. From experiments instituted by Tissot, specially for this purpose, it appears that between one spark and another from a coil, only three oscillations are set up, which rapidly fall off, after which the vibration becomes insensible. In order to obtain a series of ample and numerous similar waves, as, for example, those represented to the right of Fig. 32 at page 70, it is necessary therefore to use an undamped vibrator.

From the application of the two above-mentioned conditions, that is to say, syntonony and small damping, it would appear, at least from a theoretic point of view, that it is perfectly possible to attain another very important result in wireless telegraphy, namely, that of independence of the stations, in other words, that a station *A* may be put into communication with another station *B* without exciting the receivers of other stations in the slightest degree, by means of which, besides the advantage of being able to communicate at will with many stations, there would be that of secrecy.

It would suffice to this end that each station were characterised by a special vibration period, but that it should be possible to change it at will and put it in tune with any other station with which it was intended to hold communication.

And this is precisely the case of the well-known experiment in acoustic resonance.

If several tuning forks of different resonance periods are placed upright on a table, it is possible from a distance to cause the one or the other of them to give forth its sound at will, provided that another tuning fork capable of giving the same note be struck. Unfortunately, however, it appears that the phenomenon of acoustic resonance differs considerably from the corresponding electrical one.

In the acoustic phenomenon there is a very marked maximum of resonance ; a tuning fork answers to the vibrations of another, provided that syntony be perfect, however little the two are out of pitch it hardly responds ; in the case of the electric vibrator it will answer to another vibrator most perfectly when the sparking period is identical, but still answers although with less intensity when the two periods are anything but a little different ; on the contrary, as we have already said at page 90, if the receiving antenna can gather a sufficient quantity of energy, it will answer, whatever be the period of the sending station, owing to the fact that the vibrations set up in each become those of the receiver itself.

It would be necessary therefore to be able to regulate the amount of energy that reaches the receiving station in such a way that it should answer if in tune, and should not answer were it not ; in this case the more distant stations would not receive the communications directed to it.

Nevertheless, the nearer stations receiving more energy would still be able to receive the messages, or at least would be disturbed in the messages directed to them.

We shall see later on to what point we have reached in the direction of the solution of the problem, and we shall study the means devised by various inventors to satisfy the two conditions aforementioned. We may, however, here make a few remarks on the subject.

With regard to syntony, if it is a question of using sky rods, in which the length of wave (see page 73) may be looked upon as being four times the length of the rod itself, it will be sufficient that the masts be of equal length in order that they should have an equal vibration period, and in fact the larger part of the experiments made were carried out as far as possible with equal sky rods ; but with these oscillators, in consequence of the strong damping effect, the efficiency is, as we have already said, very small ; even as regards syntony.

It is evident, therefore, that our efforts should be directed to diminish, as far as possible, all damping. This may be compassed by lengthening as much as possible the sky rods, and in this there is another advantage, because in so doing the length of the wave also increases, and theory

shews us that the damping diminishes with the increase of the length of the wave; even in acoustics it is found that high notes are more readily damped than deep ones.

The problem, however, still presents considerable difficulty; the principal cause of the damping of the oscillator antennae lies in the great quantity of energy which they radiate, and this should not be diminished, since it is exactly this radiation that carries to a distance the energy necessary to excite the receiving sky rod.

Oscillators are indeed known which have but little damping; such are, for example, all those which are closed upon themselves, such as the one represented at Fig. 31, but these being constituted of two portions close together, which are vibrated in contrary directions, the actions set up by these mutually destroy each other at a distance; the surfaces which they enclose being but small, the volume of the dielectric which is interested in the vibrations is also small, and they therefore give persistent vibrations, but of very little radiating power.

The two problems, therefore, of little damping and great radiating power present a kind of incompatibility for a common solution, recourse has therefore been had to a mixed system, such as is represented in our Fig. 45.

The induction coil communicates with an oscillator closed upon itself, and containing a condenser C ; the oscillator circuit acts on the sky rod A by electro-dynamic induction (see page 24), and in order that the induction set up should be more efficacious, the two facing circuits are wound in spirals like the primary and secondary of an induction coil, thus constituting what is called a transformer.

The sky rod radiates freely into space the energy which it receives from the transformer, and its oscillations tend to damp off, but the persistent vibrations of the primary oscillator circuit $P C$ revivify them, and the same result is obtained as if the oscillations from the sky rod were but little damped.

The oscillator $P C$ loses at every oscillation the energy which it communicates to the sky rod, but it will always have a reserve sufficient for many oscillations, provided the condenser C , which usually consists of a Leyden battery, have sufficient capacity.

One condition, however, which is indispensable in order that great efficiency should be obtained, is according to the principles already evolved at page 87, that the two oscillators AS or PC should be in tune; that is relatively easy (page 70) by regulating the self-induction of S and the capacity of C .

A similar arrangement is adopted for the receiving mast, which acts inductively also on the almost closed circuit of

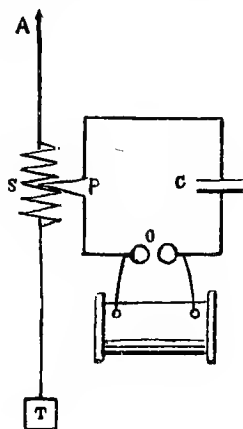

Fig. 45.

the coherer through the intermediary of a transformer, which augments the difference of potential at its electrodes; however, in obedience to the principle of resonance, in order that the impulses which the sky rod receives, should be added together in it, and should add themselves also to those which it transmits to the coherer circuit, it is necessary that the sending sky rod should have the same vibration period as the receiving one, and this again the same period as the circuit of the coherer proper; and since the sending sky rods must be in tune with the oscillator, it follows that, in order to obtain this general resonance, and therefore the maximum effect, it is advisable that the two masts or sky rods, the

vibrator, and the coherer circuits should have vibration periods exactly similar.

In order to obtain this accordance, the number of spirals in S of the sending station, and which take part in the vibration, may be varied, so as to be able to put its sky rod in unison with that of the stations with which it is desired to communicate, and the capacity C may be modified in order to maintain unison between the two circuits of the station.

Not every system of radio-telegraphy is based exclusively on the principles just enunciated, nor are these applied in the same manner in every one: thus, for instance, in one of the more largely diffused, namely, that of Slaby-Arco, the inductive excitation of the antenna is not employed, and in the Braun system, which is also largely used, the antennae do not communicate with the ground, but with a condenser. Of these and other differences, we shall speak when we come to describe them singly.

On the Influence of Daylight.—A rather serious difficulty which presents itself to radio-telegraphic communication to great distances, is that depending on the fact that daylight presents an impediment to communication; Marconi recognised this influence at distances greater than 800 kilometres (500 miles).

While travelling towards America on the "Philadelphia," he found no difference between the signals received in the daytime and at night, until he had reached that distance from the transmitting station from Poldhu, but at greater distances the signals transmitted from Poldhu after sunrise reached him much weaker, and at a distance of 1,100 kilometres (800) miles, they were absolutely imperceptible, whilst during the night they remained decipherable up to 3,300 kilometres, say 2,000 miles. To this inconvenience a remedy may be found in the use of much greater energy at the sending station; nevertheless, up to the present time it does not appear that anyone has been successful in transmitting Trans-Atlantic despatches in the daytime.

Marconi attributes this injurious influence to the fact which has been verified by many experimenters, that daylight tends to partially discharge bodies that are negatively electrified, for which reason it will discharge in part the sky

rods during that half of their oscillation period in which they are electrified negatively.

Lodge, on the other hand, is of opinion that the greater dissipation of the energy of the electric waves that takes place during the day, occurs all along the space traversed. According to the most recent views and experiments respecting the similarity existing between electrical and optical phenomena, it is admitted that under the influence of the solar ultra-violet radiations the material molecules which are scattered in the air detach themselves from the so-called electrons or atoms of electricity whose presence render the atmosphere slightly conductive. The electric waves which, in the case of the atmosphere being perfectly insulating, would run horizontally, guided by the conducting surface of the sea, finding themselves in a partially conducting medium, dissipate themselves in space, becoming rapidly weaker.

CHAPTER VII.

Radio-telegraphic Apparatus.

IN this chapter we do not propose to give a minute description of all the apparatus that may serve in radio telegraphy, inasmuch as the greater part is the same as what is used in other electrical applications, and of which we have already spoken *in extenso* in other volumes of this "Library." For the theoretical notions of such apparatus, we refer the reader to the excellent book by G. Finzi, *Trattato di Elettrocità e Magnetismo*, and for their practical use to Barni's *Il Montatore elettricista*. We shall only say here what is necessary in order to render comprehensible the modifications which the apparatus that is in general use has had to undergo in order to render it fit for the exigencies of radio-telegraphy.

On the other hand we shall give a more detailed description of those pieces of apparatus, such as oscillators, radiators, syntonisers, detectors, etc., which are exclusively or almost exclusively employed in the production of electric waves, and in radio-telegraphy. In order to proceed methodically, we will describe them in the same order as that in which they enter into action during transmission; therefore we will begin first with those which are peculiar to the sending station (sources of energy, coils, oscillators, etc.), then those which are common to both stations (antenna, or masts, earth plates, syntonisers, etc.), then those specially adapted to the receiving station (detectors, relays, printing devices, etc.), and, finally, any such as may be placed between the one and the other station (repeaters).

In this description we shall restrict ourselves as far as possible to the description of the single pieces of apparatus,

reserving an account of their grouping together to the chapter dedicated to the various radio-telegraphic systems.

Sources of Energy.

The current necessary to work the induction coil, may be that of a central station, or it may be furnished on the spot by batteries or accumulators ; in some cases direct recourse may be had to the current of a continuous dynamo, or to one giving an alternate current (alternator). It is found that connecting a continuous current dynamo to the primary of the coil gives rise to inconveniences, because the primary itself may be traversed by currents of high potential that might injure the armature of the dynamo.

Besides, the transmission of signals, which necessitate the closing of the primary circuit at longer or shorter intervals, sets up violent variations which are injurious to the work of the dynamo. However, on board ship on which there exists an extended wiring, it is possible without serious inconvenience to place the primary of the coil in shunt with the general circuit, a rheostat being placed between them. In the greater number of cases it is advantageous to make use of accumulators having from 50 to 100 hours' capacity, which may be charged either from batteries, when the plant is only provisional, or better, with a little charging set consisting of a gas or petroleum engine and a 500-watt dynamo.

By the use of syntonised systems, the quantity of energy necessary for communication has been greatly lowered, so that at present communication up to 30 kilometres' distance (20 miles) may be obtained by the use of currents so weak that a battery of dry cells suffices to produce them.

In communicating to very great distances, owing to the enormous disproportion between the quantity of energy employed at the sending station and that utilised at the receiving, it is necessary, in order that this latter should receive a sufficient quantity to work the apparatus, that the sending station should have sources of energy relatively very powerful. Thus, at the station of Poldhu intended for Trans-Atlantic transmission, the energy is furnished by a

31 H.P. motor, which sets into action a proportionate alternator.

Yet more powerful are the generators installed at the Trans-Atlantic stations at Cape Breton and Cape Cod, where alternators of 40 to 50 kilo-watt capacity (from 55 to 65 H.P.) are employed. When it is borne in mind the short time in which the energy of emission of each oscillation takes place, about one millionth of a second for waves of 300 metres in length, it is easy to calculate that the instantaneous radiating powers of the sending apparatus must amount to several tens of thousands of kilo-watts.

Dr. Parkin, referring to the Cape Breton Marconi apparatus, in order to give an idea of the extraordinary power of the discharge at each depression of the transmitting key, likens it to a hurricane in miniature, in which the lightning flashes have an apparent thickness of over a centimetre (two-fifths of an inch), and the noise of which is so loud as to render it necessary that the operator should protect his ears with cottonwool.

The following data refer to the energy consumed in transmission to medium distances on the Slaby-Arco system. Up to 40 kilometres an induction coil is made use of that will give up to 15 centimetres, (6 inches) spark, the contact breaker being of the ordinary vibrating hammer type. The voltage of the exciting current which is furnished by a battery would be about 16, and the energy expended may vary from 500 to 1,000 watts. For distances up to 80 kilometres, a coil giving a 12-inch spark is used. The break is in this case a rotating mercury form, and is fed directly with an alternating current, which consumes nearly a kilo-watt. For greater distances the expenditure of energy rises up to 3 kilo-watts or more, and in these cases, if the current be not alternate and used directly as such, the direct current is converted into alternate by the aid of a special converter.

Keyboards.

The keyboards, like the ordinary telegraphic keys, serve to render the current supplied by the coil intermittent, in such a way that the sparks from this latter do not succeed each other without interruption, but in long and short emissions,

corresponding to the dots and dashes of the Morse alphabet, which we reproduce here below :

<i>a</i> . —	<i>j</i> . — — — —	<i>s</i> . . .	<i>I</i> . — — — —
<i>b</i> — . . .	<i>k</i> — . —	<i>t</i> —	<i>2</i> . . — — —
<i>c</i> — . — .	<i>l</i> . — . .	<i>u</i> . . —	<i>3</i> . . . — —
<i>d</i> — . .	<i>m</i> — — —	<i>v</i> . . . —	<i>4</i> —
<i>e</i> .	<i>n</i> — .	<i>w</i> . — — —	<i>5</i>
<i>f</i> . . — .	<i>o</i> — — — —	<i>x</i> — . . —	<i>6</i> —
<i>g</i> — — .	<i>p</i> . — — .	<i>y</i> — . — — —	<i>7</i> — — . . .
<i>h</i>	<i>q</i> — — . —	<i>z</i> — — — . .	<i>8</i> — — — . .
<i>i</i> . .	<i>r</i> . — .		<i>9</i> — — — . .
			<i>0</i> — — — — —

This keyboard differs from the telegraphic ones, inasmuch as this latter interrupts and makes contact with currents of

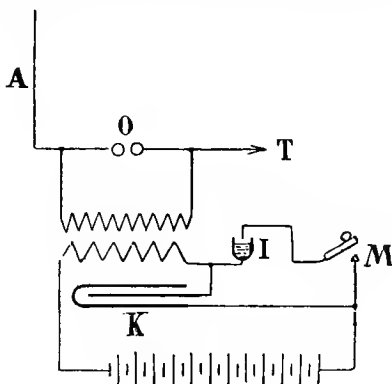

Fig. 46.

little E.M.F., whereas the former has to work with very intense currents, consequently its points of contact must be of larger surface than the ordinary ones. At the act of breaking the circuit strong sparks (self-induction) are produced, and it is useful and often necessary to avoid them. For this reason a condenser *K* is often placed in shunt with the keys as is shewn in Fig. 46.

Fig. 47 shews one of the keys used by Marconi, in which contact takes place between platinum and platinum, and in the base is enclosed the condenser K (shewn in Fig. 46).

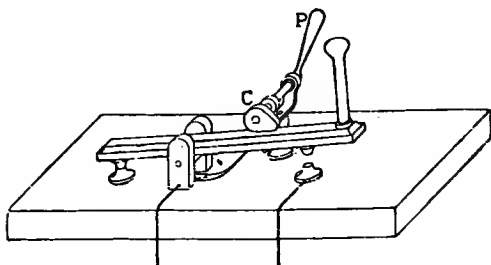

Fig. 47.

Ferrié has used with great success the key shewn at Fig. 48, in which the interruption takes place between two little copper bars contained in a recipient filled with paraffin.

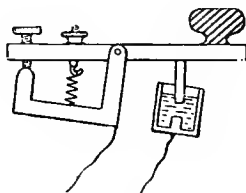

Fig. 48.

Another key used by Marconi is that figured at 49, which serves at the same time as a commutator or two-way switch, that is to say, it puts the antennae in communication with the receiving apparatus at the time that the key is not being worked, so that the apparatus is ready to receive. The part T of the key is in this case made of ebonite. When in the position indicated by the figure, the antenna or sky rod communicates with a , and through the key with f , which

leads to the coherer. If the key is depressed, the contact between a and f is interrupted, and the current from the source s passes through the primary of the induction coil.

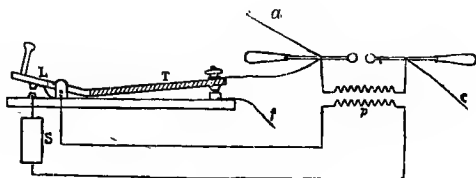

Fig. 49.

In the installations known as "ultra-powerful," like that at Poldhu, in which a current having an E.M.F. of 2000 volts and 20 amperes has to be interrupted, it would not be possible to work directly with the Morse key, and an alternator would not stand such treatment. The key (Fig. 50)

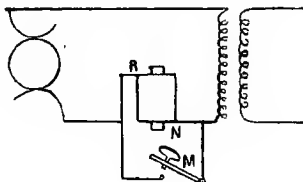

Fig. 50.

is therefore arranged in such a manner as to put into circuit the reaction coil R , whose reactance when its core N is completely immersed, is such as to damp entirely the exciting current; therefore the core is then entirely introduced, and the key is worked. Every time the key is lowered the current excites the primary of the transformer and discharges are produced; when, on the other hand, the key is raised, the exciting current is annulled by the effect of the reactance introduced, and the discharges cease without there being any necessity of altering the working of the alternator.

In the system adopted by Giulio Cervera Baviera, commander of the Military Engineers, which is adopted in the Spanish army, two special keys are used, which constitute one part of the peculiarity of this system.

One of these is a transmitter having keys similar to those of a typewriter, by pressing the finger against the ebonite button which carries the letter or the sign that has to be transmitted, contacts are automatically produced which give

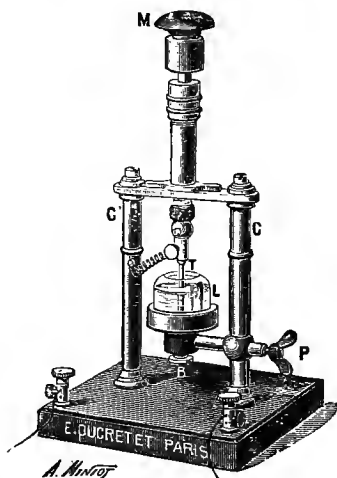

Fig. 51.

the dots or dashes characteristic of that letter or sign in the Morse alphabet. In the other key, Cervera suppresses entirely the spark which is usually produced on the breaking of current. He obtains this by earthing on the one side directly, and on the other side through a condenser, the two points between which the interruption takes place. •

At Fig. 51 we represent another transmitter used in the Popoff-Ducretet system. The contacts are produced between two copper rods inserted in petroleum or vaseline oil, contained in the recipient *L*. The two columns *C* and *C'*, are insulated one from the other. *C'* is joined to the bar

above by means of a flexible wire, while the other column is in communication with the lower bar. On lowering the key, contact takes place, which is broken immediately pressure ceases to be applied on the handle *M* by the effect of a return spring.

Fessenden, in his system of radio-telegraphy, makes use of a special key which, instead of closing or opening the circuit, establishes or destroys the resonance between the transmitting and the receiving apparatus, while the exciter is continuously in action. It is clear that if the key be touched in such a way that the resonance between the two

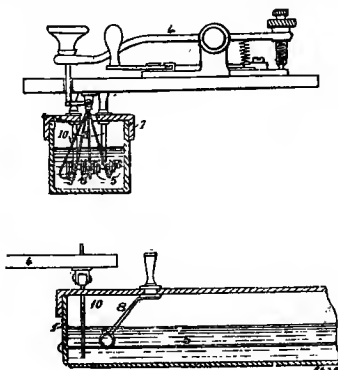

Fig. 52.

stations is perfect, the receiving station will take up the long or short signals according to the time in which the key remains in that position, and on destroying the resonance the receiving apparatus will not receive any impressions, notwithstanding the continuous emission of waves on the part of the sending apparatus.

The key made use of by Fessenden (Fig. 52) has the form of an ordinary tapping key, below it is arranged a long rectangular box, in which are stretched parallel metallic wires immersed in oil. These wires are placed two by two in communication by movable contacts (8) which carry at their lower end small pulleys, in the furrows of which the underlying wires engage, and which can run along the wires themselves.

The lowering of the key determines, by means of an angular lever, the lateral displacement of metallic prolongations (10), which, touching successively the parallel wires, insert into the circuit of the oscillator that capacity and inductance represented by each pair of wires, and which differ the one from the other in consequence of the different positions which each individual pair of wires holds with regard to the movable contacts.

In this manner, with a single lowering of the keys, it is possible to produce many different "chords" according to the number of metallic rods moved by the key, and if one of these chords corresponds to that for which the designated station is tuned, this station receives the signal, and it will be easy to change the tune when there is any reason to believe that it has been discovered by another station interested in intercepting the messages. Evidently signals can be transmitted either by establishing, at the desired instant, the resonance between two stations, or by altering a pre-existing accordance.

Automatic Transmitters.—Similar to those automatic transmitters with perforated cards used in ordinary telegraphy, devices may be employed instead of keys for wireless telegraphy. Such transmitter is represented to the right below in the figure given at Chapter VIII., in which is shewn the Lodge-Muirhead apparatus. This transmitter consists of two distinct instruments; one, more to the right, that serves to produce on a strip of paper perforations corresponding to the Morse alphabet signs, and the other, which is the true transmitter, through which the said perforated strips pass, and which allow to flow, in correspondence with the holes, the exciting current which sets up the emission of the signals.

By this means a much more regular succession of sparks can be obtained than with the ordinary key.

Coils and Contact Breakers.

The purpose of the induction coil is to transform currents of low potential furnished by the source of energy, into currents of high potential, capable of producing between the balls of the oscillator those powerful sparks which give rise in it to the production of electric waves.

Even the sparks of an electro-static machine (Holtz, Wimshurst, etc.) would be capable of exciting the oscillator, and many studies on electric oscillations were made by means of electro-static machines as exciters, but in practice preference has been given to the use of induction coils, as their action is more certain, and they are more easily regulated.

In the radio-telegraphic apparatus with sparks applied directly to the sky rods (pages 72 and 73), since the capacity of this latter is relatively small, there is no means of increasing the energy of the discharge but that of increasing their potential, and therefore augmenting the size of the induction coil.

This is limited by the difficulty of producing currents of the highest potential.

On the other hand, in those apparatus in which the excitation of the antenna or sky rod is brought about by induction (page 93), the capacity of the oscillating circuit may be increased at will by increasing the capacity of the condenser inserted in it, and when it is necessary to bring into play a very large quantity of energy, as in the extra powerful stations, recourse is had to the industrial transformers of high potential, fed by alternating currents instead of the ordinary induction coils (see Fig. 50, page 101). However, in the greater number of the installations use is made of the induction coil.

The Ruhmkorff Coil.—The classical type of induction coils is that of Ruhmkorff (Fig. 53), which consist essentially of two bobbins of wire, one of which is placed inside the other. The internal bobbin, which is formed of thick wire of few turns, constitutes the primary or inducing circuit, and is traversed by the current set up by the source of energy; the external bobbin is formed of very fine wire making many turns constituting the secondary or induced circuit, and it is its two extremities that are placed in communication with the balls of the oscillator between which the sparks pass.

The inducing bobbin encloses along its centre a bundle of soft iron wire.

In Fig. 53 the extremities of the induced circuit are represented by two wires which come out from the upper part of the bobbin.

In very large coils many makers divide the induced circuit into a number of sections placed one close to the other, so that in case of injury it is sufficient to remove and replace the damaged section. The currents set up in the secondary or induced circuit (page 25) only manifest themselves at the act of making or breaking the inducing circuit; in order to interrupt or to close this circuit, contact breakers are made use of (see Fig 53 to the left), of which we shall speak later on. In consequence of the induction which

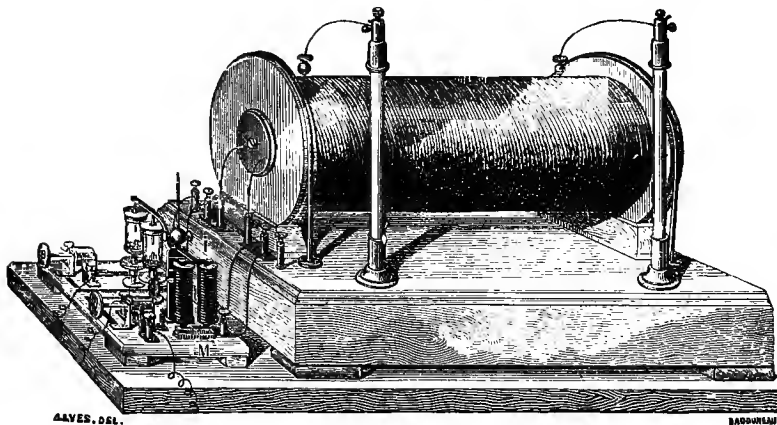

Fig. 53.

takes place between each successive turn of the inducing circuit induced, currents are set up in this latter (known as extra currents), which during the act of making and breaking the contact produce vivid sparks at the point where the circuit is interrupted. These sparks cause disturbances in the working of wireless telegraphy, and various means of avoiding them are made use of, one of which is the employment of a condenser, as shewn at Fig. 46, page 99.

As the inducing action takes place in each of the turns of the induced circuit (secondary), it is necessary in order to increase the difference of potential at the ends of the induced wire to increase the number of the said turns, and therefore

to give the coils dimensions which will be greater in proportion to the potential desired. Usually the power of a coil is expressed by the maximum length of spark that it can give; coils are made capable of giving sparks from 16 up to 42 inches in length. When a coil is not strong enough to furnish the desired length of spark, two or more may be united together by placing their primaries in series and their secondaries in parallel.

As to the relation that exists between the power of the coil and the distance to which they can telegraph, we refer the reader to page 98.

Almost any form of coil can be used for radio-telegraphy, provided that it will bear one pole of its secondary being put to earth when the arrangement is made for direct sparking.

For that reason one cannot judge by the length of spark which a given coil will furnish under ordinary conditions of its fitness to serve for this purpose. Certain forms which give, when not put to earth or connected to sky rod, from 16 or more inches of spark, will only give from $\frac{3}{4}$ to $1\frac{1}{4}$ inches' spark when earthed or connected to the sky rod, and even less when coupled to condenser; while others will still give from 3 to 4 inches under like circumstances. These are to be preferred, because they bring into play more energy as they charge the sky rod or the condenser to a higher tension.

Usually the core of the coil is placed horizontally; however, coils are constructed in which the core is vertical (see Fig. 54). These can be fixed to the walls, as is often done in the German radio-telegraphic stations.

Much may be expected from improvements in the construction of coils, which up to the present have been used for purposes almost exclusively scientific, but have now entered into the field of industrial applications, inasmuch as their output, that is to say the proportion between the energy consumed in the primary circuit and that given by the secondary, rarely surpasses 20 per cent.

Unipolar Transformer.—A coil which is largely made use of, especially in the French radio-telegraphic installations, is the so-called transformer of Wydts and de Rochefort (Fig. 55); it consists in a primary of two layers of wire wound round soft iron wire core, enclosed in an insulating tube;

the secondary, of shorter length of thick wire wound in one or two bobbins, and which only occupies a small central part of the length of the core. The wire is so wound that one of its two extremities, namely, that nearer to the core, is at a very low tension, while the other extremity is at an extremely high tension. The entire bobbin is then immersed in a viscid insulator, which is obtained by dissolving paraffin wax in hot petroleum.



Fig. 54.

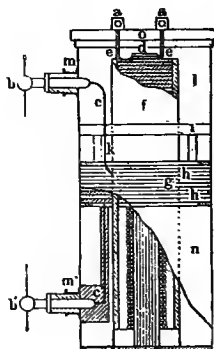

Fig. 55.

In arranging for sparking by direct application to the antenna and to earth, this latter is connected to that part of the secondary in which the E.M.F. is lowest, thus the length of the spark does not suffer so much by being placed in communication with the ground, as in the case of ordinary coils.

With a unipolar transformer, Tissot has been able to transmit messages to a distance of 40 miles, while with an ordinary coil giving a spark of equal length, not more than 20 miles could be covered.

Contact Breakers.

Contact breakers are most important in the working of coils, and although indispensable in the case of coils fed by continuous currents, they may be considered as an organ apart, and very often are really distinct and separate. We shall not enter here into any very minute description of these. We shall limit ourselves to pointing out the principal types in use, and the qualities which render some preferable to others in practice. Contact breakers for use in wireless telegraphy must be simple, and allow a prolonged and regular working, for this reason some types which are very convenient in the laboratory, such as the electrolytic break, have not given good results in telegraphy.

In every case it is necessary that the interruptions should be extremely rapid, because in consequence of the rapid damping of the oscillation, there is always between one spark and another an interval of time, which must be rendered the briefest possible, during which the oscillations are extinguished. If these intervals of time be too long, the receiver has time to put itself in rest between two successive operations, and will signal a series of dots instead of a continuous line. For this reason the types preferred are the dry contact breakers and the rotary or turbine form.

If the coil, instead of being fed by a continuous current, is worked by an alternate one, it is evidently no longer necessary to employ contact breakers. Figs. 56, 57, and 60 are diagrammatic representations of the three principal types of contact breaker, viz.: the clapper or dry, the mercury break (Foucault's), and the rotary or turbine form.

In the three figures we have represented the primary circuit alone, b' wound round a cylinder, within which is placed the core of soft iron wire, that in Fig. 56 may be seen protruding from the cylinder in b . In all three cases, the end b' of the primary communicates directly with one of the poles of the source of electricity F ; the other extremity going to the other pole of the source, passing however through the contact breaker.

Dry Contact Breaker.—As shewn at Fig. 56, this consists in a fixed screw K , that touches against a spring bearing in

its upper extremity a small circular piece of iron H (hammer), which is placed directly facing the soft iron bundle b . When at rest, K is in contact with the spring; if by means of the keys (not shewn in the figure) the circuit be closed, the current passing through the primary magnetises strongly

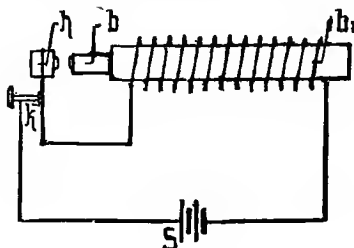

Fig. 56.

the bundle of soft iron wire, which attracts the hammer, pulls the spring away from the screw K , and thus interrupts the current. With the cessation of the current, the core becomes demagnetised, releases the hammer, and the spring, in returning to its former position, re-establishes the contact with K .

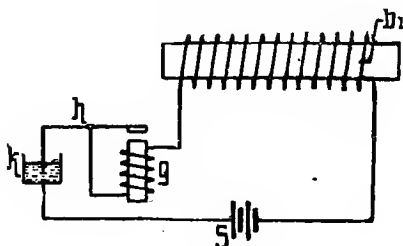

Fig. 57.

Again the circuit is closed, to be again broken by the attraction of the hammer, and so on.

The Foucault Break.—In Fig. 57 the contact breaker consists in a small iron point, which dips into a mercury

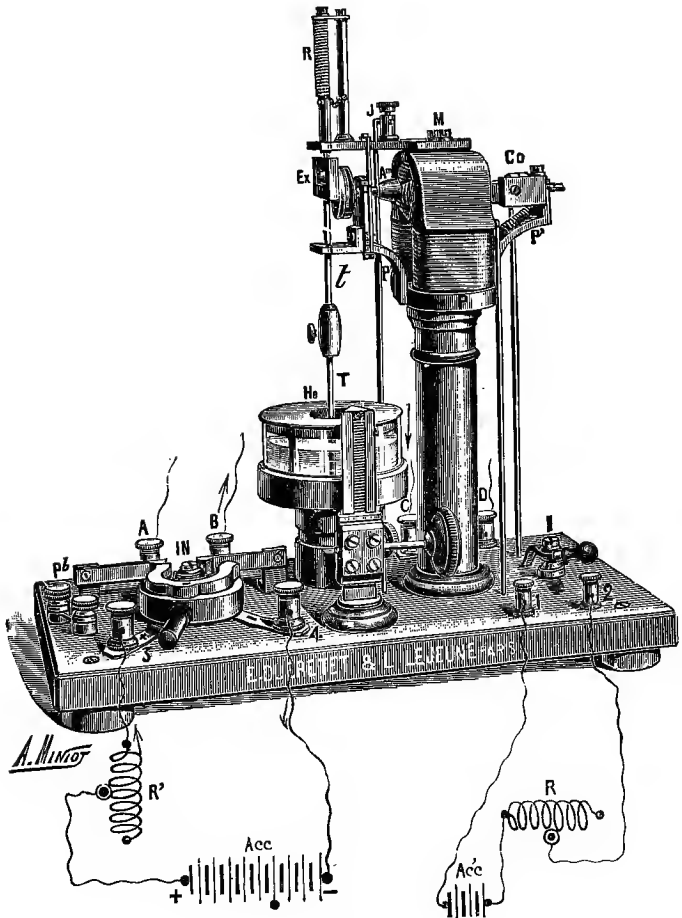

Fig. 58.

cup *K*, which is raised by the lever *h* at the moment that the current passes, in consequence of the attraction which

takes place between the electro magnet *g*, that is traversed by the primary current, and a piece of iron (armature) fixed to the other end of the lever. When the iron point is thus raised out of the mercury, the current is interrupted, the electro magnet no longer draws the iron piece, and the lever actuated by a spring returns to its place again, causing the point to dip in the mercury. Again the current passes, but immediately afterwards it is similarly interrupted, and so on.

In some modifications of this type of break, the movement of the interrupting point has been made independent of the primary current, and is produced by means of a separate small electro motor, which lowers and raises the

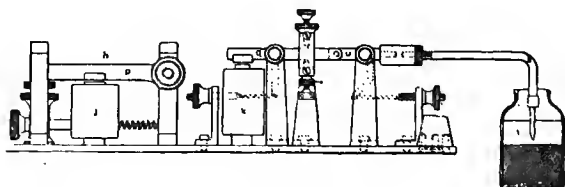

Fig. 59.

rod with a vertical movement. By this means the splashing of the mercury can be prevented, and the number of interruptions can be varied at will.

Fig. 58 represents one of these contact breakers, as constructed by Ducretet. The interrupting rod *T* is put in motion by the little electro motor, placed on the column *P*, the velocity of which can be regulated by means of a suitable rheostat, and gives from 600 to 800 interruptions per second.

The Lodge-Muirhead Break.—In the latest form given by these inventors to their apparatus, a mercury break of the form called “Buzzer” has been adopted. This we represent at Fig. 59. It consists in an ordinary mercury break, which is caused to work by means of two electric magnets placed in series instead of one only. The first of these acts as in an ordinary electric bell; the movable arm vibrates, while the transmitter circuit is closed, and in

vibrating opens and closes the circuit of the second electro magnet k , to the armature of which is attached the lever that carries the point that dips into the mercury. This arrangement gives, according to the inventors, a succession of sparks more regularly than those which can be obtained with the ordinary Foucault break.

Rotary or Turbine Breaks.—In the turbine break shewn at Fig. 60 the free end of the primary wire communicates with a metallic ring S , furnished with apertures which is placed in a cylindrical recipient g , at the bottom of which mercury

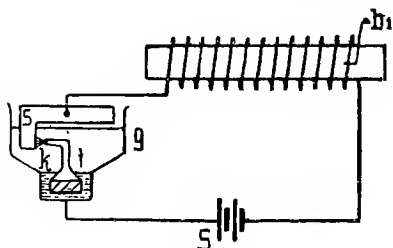

Fig. 60.

is placed. In the mercury is placed the turbine z , which is moved on its vertical axis at a great velocity. This consists of a tube, which at its lower extremity dips into the mercury, while its upper end being bent at right angles is directed towards the ring. The rotation of the turbine causes the mercury to rise in the tube, whence it rushes out in the form of a jet at its upper extremity. Here it strikes against the ring. Since the mercury is in communication with the free pole of the source of electricity, when the jet meets the metallic sides of the ring, the circuit is closed, and the current passes through the primary of the coil; when, on the other hand, the jet strikes the apertures in the ring, the current is interrupted.

By duly proportioning the number of apertures to the velocity of the motor, it is possible to obtain a speed of even 1,000 interruptions per second.

In these two last types of contact breakers, over the mercury is placed a stratum of some insulating liquid

(alcohol, vaseline, etc.), in which the sparks take place at the make and break, the purpose of which is to avoid the oxidation and the evaporation of the mercury, as well as to render the interruptions more sudden and effective.

Fig. 61 represents the external form, and Fig. 62 a section of a rotary contact breaker, constructed on this principle by the Berlin Allgemeine Elektricitats-Gesellschaft.

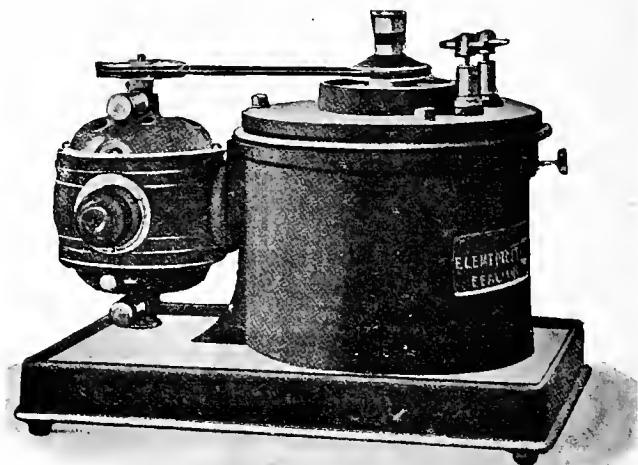

Fig. 61.

Wehnelt Break.—An interruptor of a type entirely different from the preceding is Wehnelt's electrolytic break, one form of which is shown in Fig. 63. The cathode is a sheet of lead p , the anode a platinum wire k , which protrudes slightly from the lower extremity of a little glass tube that surrounds it, the electrolyte being dilute sulphuric acid. These two electrodes are inserted in circuit of the primary of the coil and a battery of at least 20 accumulators, as it is necessary for its proper working that a fairly strong current should be used.

At the moment that the circuit is closed the platinum wire, if the current be sufficiently powerful, becomes red hot, the water that touches it evaporates, and the sheath of vapour

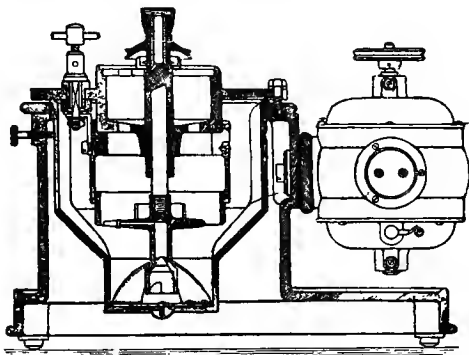

Fig. 62.

which is thus interposed between the liquid and the electrode interrupts the circuit and gives rise to a spark. When the current ceases the platinum cools down, the electrolyte

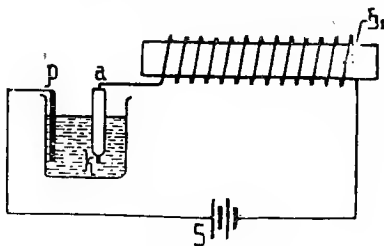

Fig. 63.

again comes into contact with it, again allowing the current to pass when the same series of phenomena is reproduced.

The interruptions produced by this apparatus are extremely rapid, reaching several hundreds per second. This

break has been applied to radio-telegraphy, but, generally speaking, without much advantage.

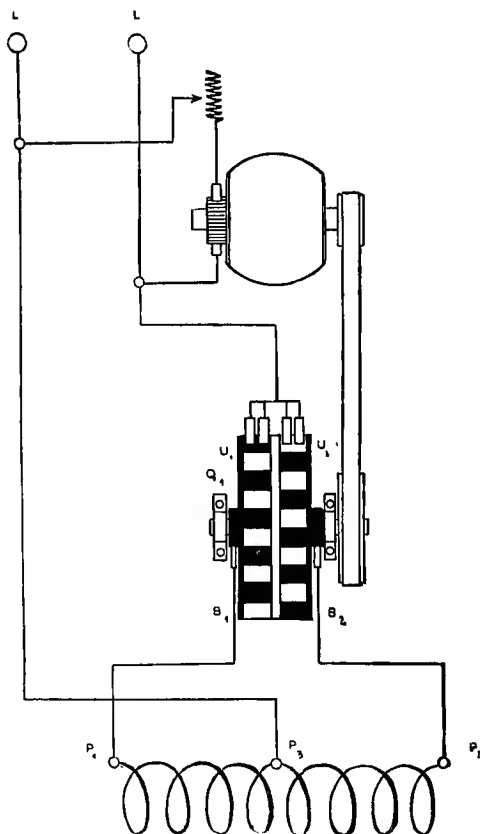

Fig. 64.

The Cooper-Hewitt Break.—Later on (Chapter VIII.) we shall see that the lamp known as the Cooper-Hewitt can be employed as a contact breaker.

Converters.—The use of mercury breaks is not without inconvenience when very powerful discharges of current are required; in these cases therefore it is preferable to do away with the break, and to make use of an alternating current generator, or to transform a continuous current into an alternating one by means of special pieces of apparatus called converters.

Figure 64 represents diagrammatically the Grisson converter, used for the purpose in some installations of the Slaby-Arco system; the primary winding of the coil has besides the two terminals, P_1 and P_2 , a central terminal P_3 . The continuous current by means of a commutator passes first through the winding of the first bobbin P_1 to P_3 , and then through the winding of the second bobbin P_2 to P_3 . The two bobbins have a common iron core, and the two windings are such that when the current passes from P_2 to P_3 it induces in P_1 , P_3 a counter electro-motive force, capable of reducing almost to zero the current circulating in it, as the two halves of the iron core are magnetised in the opposite sense. At the same time the current is interrupted in the first circuit, and immediately the current in P_2 , P_3 attains its maximum, and so on.

In order to obtain the automatic closure of the one or the other circuit, two commutators, U_1 and U_2 , insulated electrically from one another, but both on the same axis, are employed. Each commutator is connected electrically with a side ring, and from these by means of suitable brushes with the wires B_1 or B_2 ; a common brush makes contact alternately with the segments of U_1 and with those of U_2 . The two commutators, with their respective rings, are kept rotating by means of a small electro motor. The current of the converter is thus delivered in an alternate form, and the size, etc., of the waves may be varied between large limits.

The frequency can be easily made to vary between 15 and 100 cycles per second, and since the current is not interrupted when it has attained its maximum value, the sparking is very slight, and it is possible by the aid of this converter to feed the coil with currents of large quantity.

Exciters and Oscillators.

We call *exciter* or *exploder* that part of the wireless telegraphy apparatus in which the sparks that set up the electrical vibrations are produced, and which either directly, or by means of the transformer are radiated into space.

We shall reserve the name of oscillator or vibrator to the entire apparatus joined to the exciter proper, and which takes part in the electrical oscillations along with its physical accompaniments: as capacity, self-induction, etc., and which determine the period of the oscillations themselves.

We shall speak more particularly of oscillators at Chapter VIII. when describing the various systems of radio-telegraphy. The exciter consists generally in two metal spheres connected to the other parts of the oscillator (as antennae, earth, transformer, condenser, etc.); and these spheres form the terminals of the two wires of the secondary of the coil or of the transformer that sets up the oscillations.

In Hertz's first oscillator (Fig. 28, page 66) the exciter consisted in the two little balls $b b'$, and the oscillator in the whole system $A b, b' A'$. In the production of electric waves for scientific research, it was found that the state of the exciter was of signal importance in the regularity of the vibrations set up, and it was necessary in order to obtain this regularity that the little balls should be frequently cleaned from the stratum of oxide which resulted from the passage of the sparks.

In order to avoid this tiresome operation, Sarasin and De La Rive proposed to cause the sparks to take place through an insulating liquid (oil), and this method was followed in the early days of wireless telegraphy. When the sparks take place through air and when large quantities of electricity are brought into play, there is a tendency to form a permanent arc between them, which, closing the circuit continuously, would not only hinder the production of electrical oscillations, but would constitute a danger for the safety of the apparatus.

In order to prevent the formation of the arc, it was customary either to blow on the spark with a powerful bellows, or else to set up the spark between the poles of an electromagnet which acts as a magnetic bellows.

The Hertzian oscillator underwent in the hands of the several experimenters who employed it for scientific researches, modifications specially intended to cause it to emit waves of the shortest description. One of the forms that met with the greatest success was that given to it by Righi.

The Righi-Marconi Oscillator.—The Righi oscillator in the form used by Marconi in his first experiments in radio-telegraphy is represented at Fig. 65. Every pair of spheres $d e$ is fixed in a short piece of ebonite tube that can run in a larger tube d_3 . Each sphere $d d$ is joined to the rod d_5 that serves to connect it with the external circuit and to regulate the distance between the spheres $e e$. To this end the rod d_5 is joined to the sphere d by means of a spherical joint which allows the rod to turn without turning d . The rods

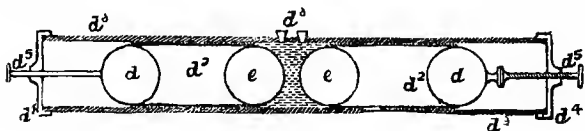

Fig. 65.

d_5 have a thread on them and run in the female screw enclosed in the cover d_4 , so that by turning the milled heads on the rods, the tubes d_2 are advanced or withdrawn, thus regulating the position of the little balls $e e$ in the tube d_3 as well as the distance between them.

The space d_6 which lies between the spheres $e e$ is shut off by the external tube and forms a recipient in which is placed vaseline oil. This apparatus bears also the name of three-spark oscillator.

The balls $d d$ that constitute the exciter are placed in communication with the induction coil, the two exciting sparks that take place between d and e determine the electrical oscillations in the balls $e e$ between which the third spark takes place. Later on the use of oil between the balls $e e$ was given up because it was found that with the heavy discharges necessary in radio-telegraphy, the oil was partially decomposed, particles of carbon being liberated, which diminished the insulating power of the liquid, hence return was made to the dry ball system.

The ball oscillators as above described give forth waves of no great length (about 10 inches with balls 4 inches in diameter), and hence fit to be reflected by cylindrical mirrors of moderate dimensions. Such oscillators were in fact made use of along with reflectors that sent on the waves in a determined direction.

The spheres *d d* were afterwards connected by Marconi, the one to the sky rod and the other to earth; in this way the length of the wave was increased and the reflectors became superfluous.

Tissot's Oscillator.—Lieutenant Tissot, to whom are due systematic researches on telegraphy by Hertzian waves, prefers for transmission to short distances to connect to the sky rod one of the two central spheres and the other to earth, while the two externals are connected respectively to the two poles of the induction coil. This method is justified by the fact that the two outer spheres serve only to charge the central ones, between which alone, as we have already seen, the oscillator discharge takes place.

This arrangement has the advantage of not causing the induction coil to be asymmetric. Tissot has made comparative experiments in order to ascertain if the number and the diameter of the spheres which constitute the exciter had any important effect on the transmission, and found that they had no influence; with exciters of 4, of 3, and of 2 balls equally good results were obtained; however, provided the distances were not great, he gave preference to the 4-ball arrangement above described.

Ruhmkorff Exciter.—However, in general, the use of the four balls has been discarded and the single spark form has been largely used (see Fig. 49, page 101). These are simply the exciters of Ruhmkorff coil, consisting of two rods that play in two metallic collars well insulated from the ground but communicating with the poles of the coil itself. The two rods bear at their facing extremities two solid balls of brass, and at their other extremities insulating handles, enabling the operator to approach or to separate them without receiving a shock. From the same metallic collars start the wires that place the balls and exciter, the one in communication with the earth and the other with the sky rod.

In the syntonised oscillators (Fig. 45, page 93) the exciter is also constructed with two brass balls, which, however, are placed in communication with the two ends of the circuit containing the condenser *C* and the self-induction coil *P*.

Armstrong-Orling Exciter.—Armstrong and Orling proposed to make use of an oscillator of two large hollow balls in which were introduced a number of smaller ones, the large balls being immersed in oil. This arrangement, according to the view of the inventor, serves to modify the period of vibration and to put it in accord with that of a

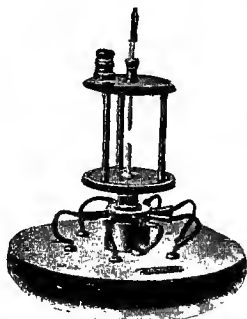

Fig. 66.

given receiver. It is not clear, however, how the presence of the little balls enclosed in a conductor can possibly have any sensible influence on the vibration period of the oscillator.

The Slaby-Arco Exciter.—Fig. 66 represents the exciter used by the Allgemeine Elektricitäts-Gesellschaft in their transmitting apparatus on the Slaby-Arco system; it has no spheres, and consists in two vertical brass rods, of which the upper one is movable. It is surrounded by a cylindrical mantle of cardboard or micanite (not shewn in the figure), which serves to deaden the noise of the sparks.

The internal ventilation of the cylinder is facilitated by a tube of ebonite applied to the cover.

From the two poles of the exciter start the wires that lead

to the poles of the secondary of the coil, which generally takes the vertical form (Fig. 54, page 108), and is fastened to the wall.

As in this system, one of the poles of the coil is always in communication with the ground, care is taken that the earthed pole is that which is in communication with the upper movable rod of the exciter, so that it can be handled without danger, while the lower pole, which would give powerful shocks, is inaccessible.

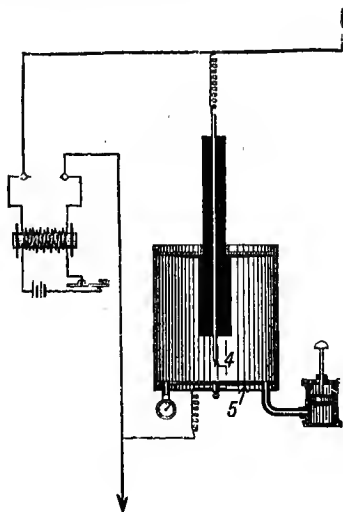

Fig. 67.

This exciter constitutes the little cylinder in the apparatus shewn at Fig. 104, page 164, which represents the entire Slaby-Arco oscillator.

The Fessenden Exciter.—In this exciter, shewn in Fig. 67, the spark, instead of taking place in ordinary air, passes through air under high pressure. By increasing the pressure, the power of increasing the potential of discharge is also gained along with the carrying power of the wave, and

this without increasing the length and the resistance of the spark, because with a like difference of potential, the sparks are shorter in proportion to the height of the pressure. In the model shewn at Fig. 67, the spark takes place between the point 4 and the floor 5, in a chamber communicating with an air pump, which can compress the air therein to between six and seven atmospheres. Up to a pressure of 3.3 atmospheres, Fessenden did not find any increase in the carrying power of the waves, but this augmented at 4 atmospheres, and at 5.3, the carrying power was $3\frac{1}{2}$ times that which it was at 3.3 atmospheres.

Antennae, Radiators, or Sky Rods.

Sky rods constitute one of the most essential parts in wireless telegraphy, when it is desired to reach any considerable distance, since, with the increase of the height of the antennae, the distance to which, under like conditions, transmission can be effected, increases in like proportion.

In connection with this subject, Marconi found that the law that establishes the distance of transmission to increase as the square of the height of the sky rod was verified.

In practice, however, it would seem that the distances which can be reached with antennae of some height are somewhat greater than those indicated by this law; in fact, in the following table we have placed side by side the maximum distances of transmission found by Tissot, using sky rods of different lengths as compared with those in use from the said law, taking as a basis an antenna or sky rod 25 metres in length, from which it will be seen that with antennae of 30 metres and more the values found are sensibly larger than those calculated.

Length of sky rod.	Maximum distance of transmission	
	calculated.	found.
12 metres	1.6 kilometres	1.8
20 "	4.8 "	4.5
25 "	7.5 "	7.5
30 "	10.8 "	13.5
35 "	14.0 "	22.0
45 "	24.0 "	40.0

Sky rods are common to both sender and receiver ; the principal service rendered by these parts has been already considerably explained by us in the preceding chapters, and we may briefly recapitulate them as being, that the sending sky rod (also called radiator) must radiate into space energy

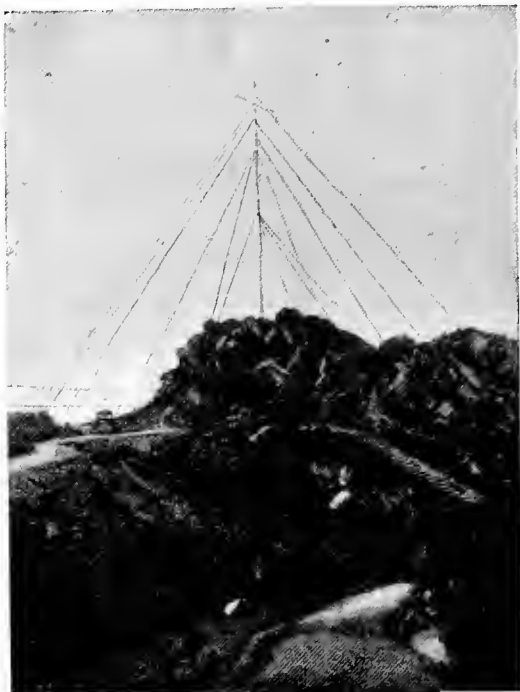

Fig. 68.

under the form of successive emissions of electric waves, and must give these sufficient length and amplitude in order that they may pass on to great distances, overcoming obstacles that they meet ; the receiving sky rod, on the other hand, must gather the energy which the said waves bear to them, adding the effects of all the successive waves

constituting a single emission and transporting this under the form of other electrical waves to the coherer or other detector that announces the arrival of the waves sent by the sending station. In the systems of direct excitation, the length of the antennae determines the length of the wave (see page 73), whereas in the inductive system of excitation (page 93) the length of the wave depends, as has been shown recently by C. A. Chant, very little on the length of the sky rod, but almost entirely on the oscillating circuit comprising the condenser.

We shall now pass to describe the various forms that the antennae have assumed in practice.

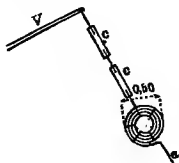

Fig. 69.

The Popoff Antenna.—The sky rod was first applied by Popoff (see page 83) to the receiving apparatus with which he gathered the atmospherical electrical waves, and consisted in an ordinary lightning conductor.

The Marconi Sky Rod.—The first experiments made by Marconi in London (see Chapter VIII.) at a distance of about two miles, were performed without antennae, and with the use of parabolic reflectors at the two stations. He afterwards found it useful to connect thin metal sheets to the oscillator, and to the coherer by metal wires, which were found to be the more efficacious in proportion as they were more elevated, and finally he recognised the uselessness of the sheets, and the sufficiency of the aerial wires alone, thus making the important discovery of oscillators with sky rods.

The aerial wires in permanent installations are supported by a cross tree attached to the upper extremity of a vertical mast, rigged up like the masts of a ship, as shewn in Fig. 68,

which represents the radiator at the station of Caprera ; or else they are fixed to towers or other lofty edifices ; but in temporary installations they may be supported by small balloons or even by kites. In any case it is necessary that their insulation should be perfect ; for that reason the upper part of the sky rod is fixed to the mast by means of intermediary cylinders of ebonite, and the yards are arranged slightly inclined so as to avoid contact with the vertical mast, as shewn in Fig. 69, which represents the upper part of one of the antennae used by Marconi at Wimereux, attached to the yard V by two ebonite cylinders $c c$, and terminated by a naked wire a coiled into a spiral.

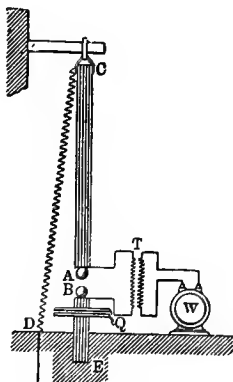

Fig. 70.

At their lower extremities the wires enter into the room where the apparatus is placed, traversing thick ebonite ends, borne by porcelain insulators.

Multiple Sky Rods.—At first simple antennae were used, consisting of a single bare or insulated wire ; but it was afterwards found advantageous to increase the capacity of the sky rod by employing three or four parallel wires kept at a constant distance apart by means of suitable wooden separators. Sometimes many wires were arranged in cylindrical form (the Slaby and Guarini antennae, Figs. 70 and 71),

or taking the shape of a cone with its vertex pointing downwards (Ducretet's antenna, Fig. 72). Braun, with a view to increase the fitness of the system to emit or to gather waves, without greatly increasing its capacity, proposed various



Fig. 71.

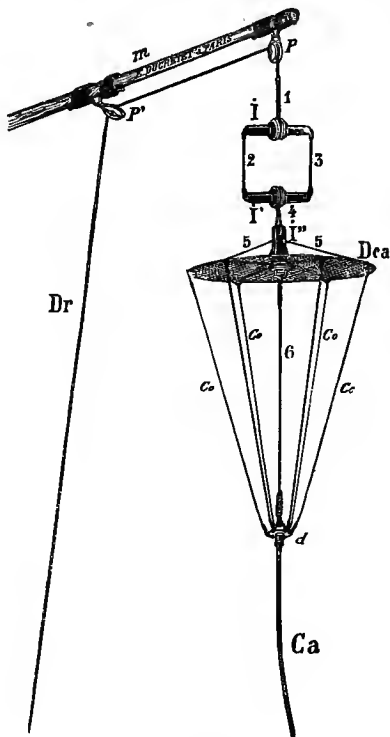

Fig. 72.

other forms of antennae (Fig. 73), consisting of parallel wires connected together at one or both extremities; or even of two such arrangements, either one near the other, united in series, or one in front of the other with their wires crossed, or finally having a wire wound in the form of a solenoid of

rectangular section, with a metal plate or net introduced into the interior of the rectangle, etc.

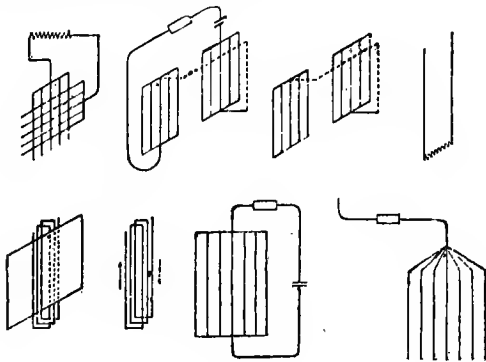

Fig. 73.

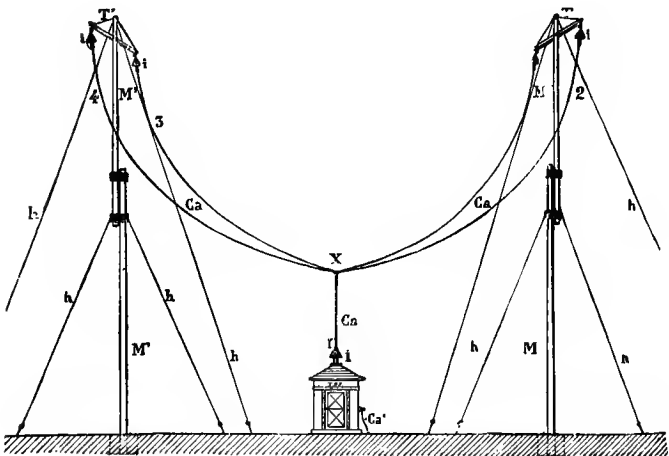

Fig. 74.

According to Popoff a good arrangement consists in the adoption of two masts of suitable height, dependent on the

distance to be reached, separated from each other by 20 to 25 metres, each of which supports two insulated and inclined wires, which join together a little above the apparatus house.

Popoff makes use of a similar arrangement when the stations are on board ship, in such cases the sky rods are the two masts of the ship itself.

Lodge and Muirhead in their field apparatus (see Chapter VIII.) employ a sky rod of pyramidal shape, erected at a height of about 16 yards.

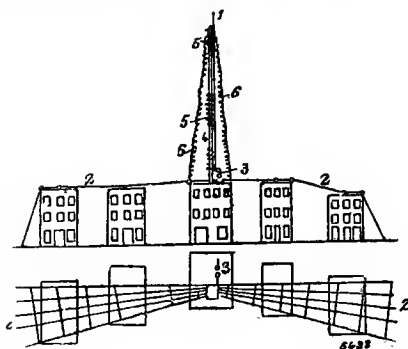

Fig. 75.

Fessenden, starting from certain theoretic ideas of his own respecting the part played by the earth in the conduction of the waves, holds the view that the antennae should be placed with the network of good conductors extending for a length of at least one quarter of the wave in the direction of the receiving station, or more if the sending station be surrounded by buildings, trees, or other obstacles capable of absorbing the waves; and for this reason he adopts sky rods of the form represented in Fig. 75.

The lower end of the sky rod is connected through a spark gap to a network of diverging wires (2), which go to earth at a distance of at least one quarter the wave length of the sky rod. Along the said rod are arranged induction bobbins (5 ... 5), the oscillation period of which is different from that of the waves employed for transmission, on which, according to his views, those atmospheric or other

oscillations that are not in tune with the local apparatus will dissipate themselves.

Aerial Pavilions.—On vessels, besides the usual masts employed on the land stations, the so-called aerial tents are made use of. These consist of strands of wires stretched between the masts, and which terminate in the cabin con-

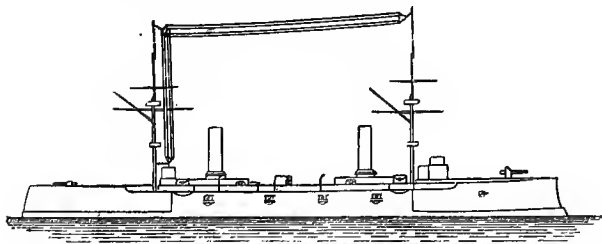

Fig. 76.

taining the apparatus. Figs. 76 and 77 represent the aerial tents successively employed on the Italian ship "Charles Albert" during its voyage to Kronstadt.

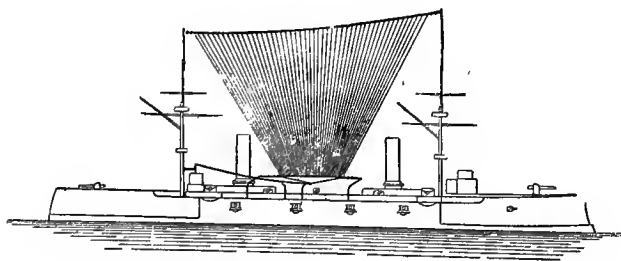

Fig. 77.

In 1876 the tent consisted of four wires stretched between the main mast and the mizzen mast at a height of 16 metres from the deck. From the former the said wires were brought down and entered into the working shed. Fig. 77 represents the arrangement adopted later on during the same

voyage in order to put the vibration period of the receiver more perfectly in tune with that of the oscillator at Poldhu.

This tent was constituted of 50 copper wires disposed in the shape of a fan, and supported by a steel cable stretched between the two masts; the height of the masts, which at first was 45 metres, was during the return voyage increased to 52 metres.

These (pavilions or tents) gather the waves over an extensive surface, and concentrate them on the receiving apparatus, multiplying the effect that would accrue from a single wire.

Ultra-powerful Radiators.—As the distances through which radiators were called to act were increased, it was found necessary to augment the energy radiated, and that the sky rods of the radiator should be proportionately increased in emitting power. In the ultra-powerful stations, destined to trans-Atlantic transmission, in which electric waves of the length of about 300 metres are fed by 50 kilo-watt alternators, the sky rods must have the power of radiating several tens of thousands of kilo-watts in the very short duration of one oscillation ($\frac{1}{10,000}$ second). These stations are therefore fitted with multiple antennae, formed of a greater number of wires arranged as shewn in Fig. 78, reproduced from a photograph of the Glace Bay station.

Four wooden turrets, interlaced with a network of wire about 70 metres in height, and placed at the four corners of a square of 70 metres in the sides, suitably strengthened by steel stays, support four cables stretched horizontally, each of which carry a hundred copper wire ropes of seven strands each. All these conductors converge below, and are united to a connecting square, from which starts a wire that goes to the sending or the receiving apparatus.

The tension to which this multiple sky rod at the said station is charged is such that sparks of from 12 to 16 inches in length can be obtained between any of the conductors composing it and the earth.

The necessity of obtaining the highest insulation will be readily understood, both at the base of the sky rods and also for the suspension of 400 conductors of which the network is made up. This presents no slight difficulty, especially in damp climates.

Another difficulty arises from the enormous hold that the wind gets on the very considerable surface presented.

Antennae with Concentric Cylinders.—Another type of antennae is that consisting of two concentric cylinders

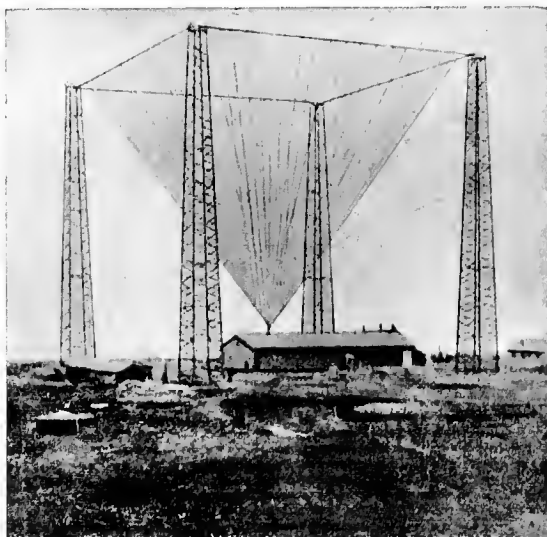

Fig. 78.

(Fig. 79), of which the interior one goes to earth, and is in connection with one of the balls of the exciter, while the external cylinder is connected to the other ball only.

The arrangement with concentric cylinders gives to the antenna great capacity without necessitating a great height, and therefore permits the use of sky rods of limited height, especially fitted for movable radio-telegraphic stations.

On land, sky rods of from $6\frac{1}{2}$ to $7\frac{1}{2}$ yards in height suffice to obtain communication to a distance of from 35 to 40 miles, whilst on sea the same distance could be covered by sky rods having a height of a yard and a quarter, with cylinders 16 inches in diameter.

Antennae for Directed Waves.—Many efforts have been made to construct antennae that should radiate only, or principally, in one given direction, and that for the double reason of diminishing the dispersion of energy, and of facilitating the secrecy of the messages.

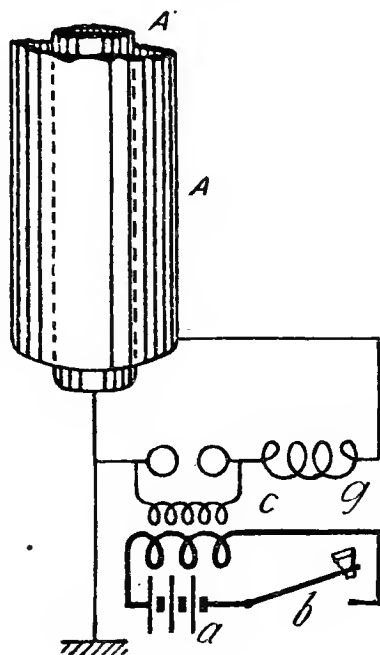

Fig. 79.

It does not appear, however, that these attempts have been crowned with any practical success.

Guarini used antennae similar to the last described, in which a wire or central metallic cable was surrounded by a cylinder of sheet metal, in which an aperture was left, this communicating with the ground. According to the inventor, the emission of waves would only take place along the

planes containing the cable and the aperture in the shield, and would not be gathered but by a receiving antenna, which found itself in the same plane.

Kitsel and Wilson proposed a receiving antenna (Fig. 80) bearing four sheets directed towards the four cardinal points, each one in communication with a special receiver. According to the inventors, the receiver that was in connection

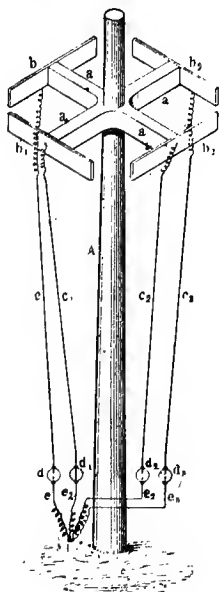

Fig. 80.

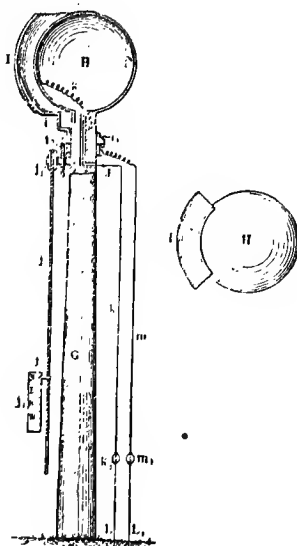

Fig. 81.

with that sheet facing the source of the waves would be more influenced than the others, and would consequently admit of the recognition of the direction of the source.

Another proposal by the same inventors is that of causing the upper part of the antenna to terminate in a sphere *H* (Fig. 81), communicating with a receiver *K*, and to cause a spherical segment *I* to revolve round it, this segment com-

municating with another receiver m' . When J , during its revolution, was interposed between the balls and the sending station, the receiver K' of the sphere would cease to act, instead of which the receiver belonging to m' of the segment I' would enter into action, and thus give indication of the direction of the waves.

It does not, however, appear probable that these two receiving apparatus, being so close, could give different indications.

The Artom Radiator.—An extremely ingenious system lately proposed and tried with success for guiding the waves in any pre-determined direction, is that of the engineer Artom, professor of telegraphy at the Royal Industrial Museum of Turin.

This method consists of making use of two antennae perpendicular to each other, instead of a single sky rod. These are traversed by electrical waves of equal amplitude and frequency, but such that the one that passes in one antenna, is a quarter of a period in advance of that which flows in the other. From the combination of these two vibrations results a single vibration travelling in the desired direction.

In order to have an idea of the manner in which two oscillations having the afore-mentioned characters can combine together into one, we must refer to Fig. 82, in which A and B represent the two perpendicular antennae. To represent the state of vibration of the two antennae at the same instant, we indicate at Fig. 83 by the continued line the state of vibration of the antenna A , and by the dotted lines that of the antenna B .

In the figure the complete period of oscillations is divided into 16 intervals, from which it will be seen that the antenna A finds itself in the intervals 0, 1, 2, 3, 4, etc., in the same state of vibration in which the antenna B finds itself, respectively in the intervals 4, 5, 6, 7, 8, hence this latter is always in retard by four intervals, that is to say, by a quarter of a full period. If we extend the lengths $A_0, A_1, A_2, A_3, \dots$ perpendicularly to the antenna A , starting from O , and we shall have the lengths $OA_0, OA_1, OA_2, OA_3, \dots$ etc., that will represent the electric force emanating from the antenna A at the instants 0, 1, 2, 3, ... and similarly by extending the

lengths $B_0, B_1, B_2, B_3 \dots$ perpendicularly to the antenna B the lengths $o, O B_1, O B_2, O B_3, \text{etc.}$, will represent the electric force emanating from the antenna B at the instants $0, 1, 2, 3, 4$.

The electric force at any given instant is given by the diagonal of the parallelogram erected on the right lines

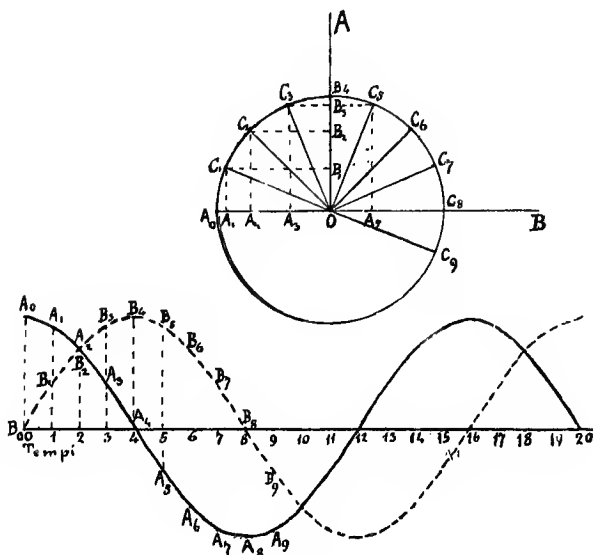

Fig. 82-83.

representing the electrical forces emanating from the two antennae at that given instant. Hence at the instant 0 , there will be given $O A_0$, because $B_0 = 0$; at instant 1 , we shall have from $C_1 O$, the resultant of $O A_1$ and $O B_1$; at instant 2 from $C_2 O$, then from $C_3 O$, etc. We therefore see that the electric force resulting from the combination turns round the point O , thereby producing what is called a rotary electric field, which propagates itself along the perpendicular line drawn from O at the plane of the antennae A and B , and which has therefore a determinate

direction, variable at the will of the operator, as it suffices to this end to vary the plane on which the two antennae are placed.

Magni's System.—We shall treat fully of this, in which two parallel antennae are joined together at their lower extremity by a wire, in Chapter IX.

All that we have said on the various forms of sky rods, etc., applies as much to the transmitters as the receivers; inasmuch as they are in general identical, nay, in the same station the same sky rod may serve alternately one or the other purpose.

As far as possible the same length is given to the two sky rods, and when they are inclined, the two are kept as nearly as possible parallel. For some time it was thought that the two antennae should be in sight one of the other in order that communication should be possible; but afterwards, by using receivers of greater sensibility, it was found that this condition was not necessary.

According as the systems of radio-telegraphy vary, so the mode of connecting the sky rods to earth, the oscillator, or to the receiver, also differ, as likewise the mode of regulating the periods of the oscillation of the antenna itself; but of these special arrangements we shall speak while describing the individual systems (Chapter VIII.).

Radiators without Antennae.—Blochmann instituted experiments with guided waves, using an apparatus without antennae. The oscillator is placed in the focus of a lens made of a dielectric substance (paraffin). The electric waves produced were refracted in passing through the lens, as if they were luminous waves, and were projected in the direction of the axis of the lens. A similar lens was placed at the receiving station, turned in such a manner that the axes of the lenses were in the same direction; in the focus of this latter the coherer is placed connected with the necessary hearing or registering apparatus.

The inventor claims for his system several advantages over those using sky rods. The first is that the receiving station cannot be influenced by signals coming from other stations differing from those with which it should communicate, which excludes any disturbances, intentional or otherwise, in reception.

In the second place, his system permits the receiving station to ascertain the direction in which another similar station is placed, that is emitting signals, and that is not on the axis of its lens. For this purpose it is sufficient to place several detectors in a horizontal line, passing by the focus of the lens; the direction sought will be that given by the right line joining the detector that is influenced with the centre of the lens.

The inventor in the course of experiments undertaken in 1903 succeeded in telegraphing with his system to a distance of about a mile, while using at the sending station an energy of not more than one kilo-watt, and expresses the hope of being able shortly to render the distance of transmission ten times greater.

Connections to Earth.

In the greater part of wireless systems both the sending and the receiving sky rod are kept in good connection with the earth. This arrangement is the fruit of experience. Marconi was the first to notice that the distance of communication increased in large proportion when one of the two plates communicating with the exciter or with the receiver was substituted by placing them respectively to earth. Communication is also possible without such connections, and in some arrangements of the Slaby-Arco, Braun and Lodge systems all connections of the antennae with the ground are suppressed, and substituted by capacities of suitable size; however, the introduction of these capacities may be looked upon as being rather the substitution of an indirect connection for a direct one, than as an entire suppression.

From experiments made to this end by Ferrié, it would appear that it is much more important to place the sending antennae in communication with the ground than the receiving. For example, it was found that it was necessary to double the length of the sending sky rod and only to increase the length of the receiver by one half when it was desired to obtain the same transmission distance while suppressing in the former and in the latter their connection to earth.

Earth connection appears to act advantageously to transmission, firstly because it determines a doubling in the length of the wave by giving capacity which is practically infinite to the second part of the oscillator, and then because it serves, as we saw at page 80, to prevent the waves from diffusing themselves too much from the useful direction (which is the horizontal), and thirdly, because it diminishes the disturbances which atmospheric electricity produces in the receiver, more especially those due to the slow variations in the potential of the air.

In order to secure a good earth connection, it is necessary that the sending or receiving apparatus that is to go to earth should be connected by means of as short a wire as possible with sheets of large surface plunged in the soil at a spot in which it presents either naturally or artificially the greatest possible conductivity, adopting for this purpose the same precautions that are followed for the earth connections of lightning rods.

We may mention as examples the arrangements adopted for earthing the wireless telegraphy installations between Biot and Calvi (Chapter X.). At Biot there are four earths, one to a near brook; two others, consisting of a sheet of zinc of two square metres surface, buried horizontally to a depth of .5 metres; a fourth, consisting of five or six sheets of zinc plunged to a depth lying between three metres and half a metre.

At Calvi the earth connection was at first installed by burying horizontally 20 square metres of sheet zinc to a depth of $\frac{1}{2}$ a metre; the superficial area was afterwards increased to 30 square metres, as it was found that the rocky nature of the soil having few fissures did not ensure sufficient communication with the sea.

It was found preferable to arrange the earth in this manner instead of seeking to effect it with the sea shore, in order to avoid the great length that would have been necessary to give the earth line.

A trial made at Biot had shewn that as a matter of fact reception was stopped when more than 30 metres of wire intervened between the receiver and the earth plates.

Transformers.

Transformers are apparatus that serve to transmit inductively the energy of an alternating current from one circuit to another.

The electrical energy of a circuit is found by multiplying the electro-motive force of that current by its quantity, and transformers in transmitting energy from one circuit to another, allow us to vary at will in the resulting product, one of the factors at the expense of the other, that is to say, of doubling or triplicating the electro-motive force, while reducing the quantity to one-half or one-third, or of doubling or triplicating the volume of current, and reducing the E.M.F. in the same ratio; deducting of course those losses which are always encountered at every transformation of energy.

Transformers consist generally in two spirals wound around the same core, perfectly insulated the one from the other; in the one passes the primary current, and in the other the induced or secondary; the relation between the E.M.F. of the primary current and that of the secondary is equal to the proportion that exists between the number of turns in each coil. Thus, if the two coils have an equal number of turns, the E.M.F. set up will be equal in both; but if the secondary coil has ten times the number of turns that exist in the primary, the E.M.F. in this latter will be ten times that of the primary, and consequently the amperage or volume of current will be ten times less. On the other hand, it is possible to have in the secondary an E.M.F. ten times smaller than that in the primary, provided the number of its turns be also ten times less.

The Ruhmkorff or induction coil already described at page 106 is a true transformer, which transforms the low potential current given by the source of energy into a current of high potential in the secondary, and it is for that reason that the primary consists of a few turns and the secondary of very many.

The principal use of transformers in wireless telegraphy is in transforming suitably the energy of the oscillator to the antenna in the case of the sending apparatus,

and that from the antenna to the detector at the receiving station.

In the account that we shall give of the successive variations undergone by radio-telegraphic apparatus, we shall see (Chapter VIII.) how the transformer was first applied to the receiving apparatus, and later on to the sending. These two transformers act under very different conditions, and therefore have to be constructed differently.

*The Marconi-Kennedy Receiving Transformers (Jiggers).—*As far back as 1898 Marconi (Chapter VIII.) modified the receiving apparatus, by insulating the antenna from the coherer circuit, and using the one to act on the other by induction, instead of by direct contact. He found that in this transmission the construction given to the transformer was of the highest importance, as its windings formed part of the circuits of the antenna on the one hand and of the coherer on the other, insomuch as if for this purpose ordinary transmitters with few turns in the primary and many in the secondary were employed, transmission, instead of being facilitated, suffered considerably. The transformer is only useful when it is wound around a core of determined diameter, with turns having a given number and position verified by practice.

Marconi, along with Captain Kennedy, has tried a large number of forms of the transformer in question, to which he has given the name of "jigger." Among others he has patented the forms diagrammatically represented in Figs. 84 and 89 as being those which have given the best results.

In these figures, which only give the upper half of each section, the primary winding P attached to the antenna is represented by thick lines, and the secondary S , which is connected to the coherer by thin lines, although the two wires are as a rule of the same thickness.

The windings are not represented in section, that is to say, with one or more series of dots for each winding, but are shewn with zigzag lines, which give a better representation of the mode of construction.

Every horizontal line represents one layer of the winding round a tube of glass of about $\frac{3}{8}$ inch in diameter, which is shewn in half section in G , and the length of the superimposed lines indicates the relation that exists between the

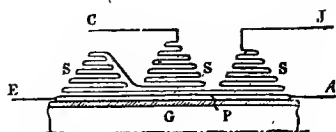

Fig. 84.



Fig. 85.

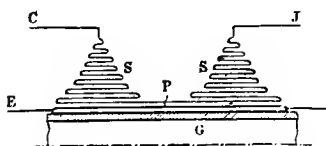

Fig. 86.

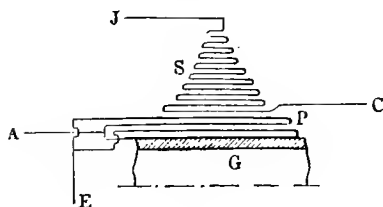

Fig. 87.



Fig. 88.



Fig. 89.

number of constituent turns and the successive strata of wire.

From these figures it may be seen that the number of turns diminish with each successive layer in proportion as these get farther from the glass tube which constitutes the core. Of all the forms of jiggers tried, the one shewn at Fig. 84 gave the best results. In this the two windings were of wire of .01 centimetre in diameter (equivalent to about No. 40 B.W.G.), and the primary consists of two layers arranged in parallel of 160 turns each.

We shall see later on (Chapter VIII.) to which apparatus of the receiving station the extremities $A E$ of the primary, and the ends $J C$ of the secondary are connected.

The secondary winding is divided into three parts, the first and the third are equal, and consist of ten layers; with respectively 45, 40, 35, 30, 25, 20, 15, 12, and 5 turns in the successive super-imposed layers; and the second consists of twelve strata formed respectively of 150, 40, 39, 37, 35, 33, 29, 25, 21, 15, 10, and 5 turns.

The theoretic reason for such an arrangement is not known; however, Marconi lays great stress on these arrangements, which, according to him, have the effect of preventing the electro-magnetic induction from acting in a contrary direction to the electro-static, at the heads of the bobbin.

In the description of these experiments (Chapter X.) we will treat of the advantages obtained by Marconi with this arrangement.

In 1899 Marconi patented other forms of jigger which differ from the preceding, especially by the introduction of a condenser, half way between the total length of the secondary.

Figs. 90 and 91 represent in the same conventional manner as the preceding, the half section of the new forms of jigger or transformer. The winding of the primary is the same as in the preceding figures, and it communicates as usual with the antenna and earth; j_3 is the condenser which divides the secondary wire in two. From the sheets of the condenser start two wires which, through two suitable conductors, lead to the relay battery, while the extremities $C J$ are in connection with the poles of the coherer.

The transformer shewn at Fig. 90 has, in its primary, 100 turns of insulated copper wire of No. 28 B.W.G. wound round

a tube of glass $\frac{1}{4}$ inch in diameter, while the secondary wire is of half that diameter, viz. about No. 36 B.W.G. The two windings begin in the middle and are led in the same direction as those of the primary, and each one consists of 500 turns distributed in decreasing numbers from layer to layer, of which there are 17, beginning at 77 and ending with 3.

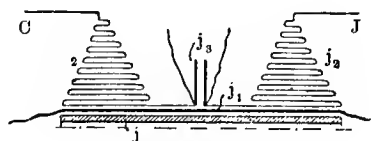

Fig. 90.

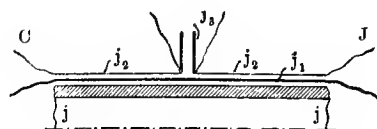

Fig. 91.

In the transformer (Fig. 91), the primary consists of 50 turns of No. 22 B.W.G. wire wound on a tube of one inch in diameter, and each half of the secondary contains 160 turns of very fine wire (0.05 millimetres in diameter) arranged in a single layer.

With respect to these arrangements, which are sanctioned more by the result of numerous trials than suggested by theoretical reasons, all that is known is, that the best results are obtained when the secondary of the receiver being wound with a single layer of turns at a certain distance apart (2 millimetres), in order that the capacity may be negligible, as shewn in Fig. 91, the length of the said secondary wires should be equal to the height of the antenna or sky rod.

This depends, according to Marconi, on the fact that a transformer constructed as aforesaid has a vibration period approximately equal to that of a vertical wire having a length equal to that of its secondary wire.

Marconi's Transformer for the Sending Apparatus.—The

transformers generally used by Marconi for the sending station are constructed as follows:—In the centre of a square wooden frame (paraffined), 12 inches in the side, is wound a single turn of the conductor which constitutes the primary. This conductor consists of from 1 to 10 wires coupled up in parallel at their extremities; on either side of the primary is wound in a plane above the square a certain number of turns of highly insulated wire, forming the secondary. The number of turns of this wire is greater or lesser according to the length of the wave to be employed. The ends of the secondary wire communicate, the one to earth and the other to a self-induction coil, into which at will can be introduced a greater or lesser number of turns, in order to regulate the oscillation periods of the antenna in the syntonised instruments.

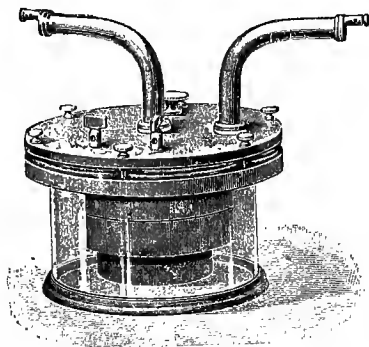

Fig. 92.

This coil is made of copper wire of $\frac{3}{8}$ inch in diameter, wound as a helix of 6 inches in diameter on an insulating cylinder.

Braun's Transformer.—In this wireless system the oscillator acts on the antenna of the transmitting apparatus by the aid of a transformer, into the primary circuit of which the current derived from the exciting circuit is passed, and whose secondary is connected up to the antenna.

Fig. 92 represents the form given by the firm Siemens to such a transformer.

Since it has to work with very high potentials, it is placed in a closed recipient full of oil.

Also in the receiving apparatus the antenna acts upon the coherer circuit by means of a transformer; this is represented at the right hand of Fig. 102, page 153, along with its relative condenser. As in this case the apparatus is subjected to very small differences of potential, air insulation alone is sufficient.

The Tesla Transformer.—A type of transformer used specially in the so-called extra-powerful stations in order to transform to high potential the alternating currents furnished

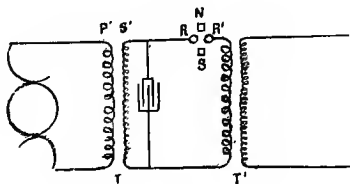

Fig. 93.

by one of the ordinary alternators, is that of Tesla, as shewn at Fig. 93. The current of an alternator passes through the primary circuit P' of a transformer T . In the secondary S' of this transformer a current of equal frequency to that of the alternator, is set up, having, however, a much higher potential, there being more turns in the secondary than in the primary.

The current set up in S' charges the condenser alternately, and this discharges itself through the little balls of the exciter $R R'$, producing electrical oscillations in the primary circuit of a second transformer T' that has no iron core, and which is plunged into boiled oil, either vegetable or mineral. The transformer T' constitutes the Tesla coil.

The electric oscillations of the primary P' are excessively more rapid than those of the generator, for which reason there are generated by induction in the secondary of T' currents of equal frequency to those of the condenser, but of much exalted potential. The transformer T , which serves to the first raising of the potential of the current supplied by

the alternator, is an ordinary commercial transformer. Professor Tuma of Vienna, who was the first to employ, in 1898, the Tesla transformer in experiments with wireless telegraphy, made use, instead of the ordinary transformer, of a Ruhmkorff coil fed by a battery.

In the extra-powerful stations like that of Poldhu, commercial transformers, which raise the alternate currents from 2,000 to 20,000 volts, are employed. Such transformers require to be built with especial care, in order to ensure perfect insulation of the secondary.

For this reason, the secondary is built up in sections, as in many Ruhmkorff coils (see page 106), and the sections

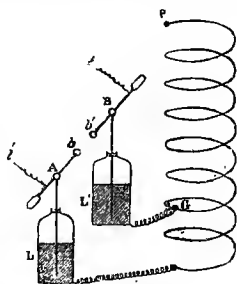

Fig. 94.

are built up in the following manner:—A piece of highly insulated conductor of convenient length is passed through a hole made in a disc of ebonite, in such a way that half of the conductor is on one side of the disc, and half on the other; each of these two halves is then wound into a spiral, flat with the surface of the disc, the windings being continuous on the two surfaces. These discs or “cakes” are then strung over the primary winding, and their extremities united in series. In this manner is obtained a well insulated secondary of low resistance, capable of charging in a very short time a condenser of great capacity, like that of the Poldhu station, which we will describe at page 154.

The Oudin and d'Arsonval Transformers.—At Fig. 94 we give a representation of the Oudin transformer: the inside

coatings of two Leyden jars communicate through two wires $i i$, with the terminals of an induction coil, and also with the little balls $b b'$ of the exciter. The external coatings of these same jars communicate, the one with one end of a vertical spiral, and the other with a sliding contact G , running along the spiral itself. The spiral is thus divided into two portions, the length of which will vary according to where the sliding contact is placed. If the position of G be such that the period of the oscillator (comprising the jars and the first part of the spiral) be in tune with the vibration period of the remaining length of the spiral $G P$, the point P becomes the seat of electrical oscillation of very high tension, which shews itself by intense luminous brushings. If the point G be displaced up to P , the instrument becomes the d'Arsonval transformer, which may be considered as a modification of Tesla's.

Condensers.

The essential portions of a condenser are, as is well known, two large metallic sheets facing one another, like $C C$ at Fig. 96.

These should be very near one another, and separated by some insulating substance D . These are called coatings. Such a system possesses great "electrical capacity," that is to say, it is able to receive a heavy electrical charge before it assumes high potential. For example, the arrangement of the two balls $b b'$, shewn at Fig. 95, has little capacity; hence if $b b'$ be placed in connection with the poles of the Holtz machine, it will suffice that the machine should furnish a very small quantity of electricity of opposite signs to the two balls, in order that these should acquire a sufficient difference of potential to enable the spark to fly from b to b' . So that if the machine is kept working, a series of weak sparks will flow rapidly from the one to the other.

But if we connect the little balls $b b'$ to the condenser shewn at Fig. 96, in which $C C$ are the coatings and D the insulating medium, we shall have an arrangement of much higher capacity, so that the machine will have to supply to the two spheres $b b'$ a much greater quantity of electricity before their difference of potential can reach the value

necessary to enable the spark to pass between them. Consequently, if the machine continues to work, we shall get in

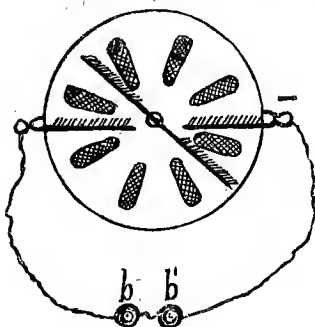

Fig. 95.

the same time fewer sparks than before, but in exchange they will be more vivid and noisy, since the quantity of electricity discharged each time will be much larger.

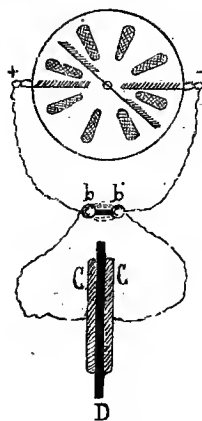

Fig. 96.

The capacity of the condenser increases with the increase of the area of the coatings, and will decrease with their

distance apart. Consequently, the nearer the coatings $C C$, the fewer and the more brilliant will be the sparks; and at equal distances, if for the coatings $C C$ be substituted larger sheets, or if these be connected to other condensers similar to $C C$, so also will the sparks be less frequent and more brilliant.

One of the commonest forms of condensers is that of a Leyden jar (Fig. 97), which consists in a glass jar coated



Fig. 97.

inside and out with tinfoil, up to a certain distance from the brim. The tinfoil inside constitutes one coating, that outside the other, and the glass the insulating medium.

We have already seen that in their application to wireless telegraphy, condensers are inserted principally in the circuit of the oscillator, in order to prolong the period of the electric oscillations set up in it, and also to increase the energy put in motion at each discharge of the coil.

In syntonic systems it is necessary, besides, as has already been said, to be able to regulate the period of the oscillator, and of the receiver, to put them in tune with those of the two antennae, and therefore condensers used for this purpose must have a capacity capable of regulation.

The form of condenser used for this particular purpose is generally that of a battery of Leyden jars, connected in parallel, that is to say, having all their outer coatings on the one hand, and all their inner coatings on the other, united. In order to be able to regulate the capacity, the usual

means employed is to add to or take away a certain number of jars from the battery, or to substitute another Leyden battery of different capacity; and in either case the variation of capacity proceeds by jumps.

If it be necessary to vary the capacity in a more continuous manner, it is better to use condensers of variable capacity. The ones most used consist in two parallel sheets, the distance between which can be varied; or else of two series of parallel layers disposed as shewn at Fig. 98, so that those

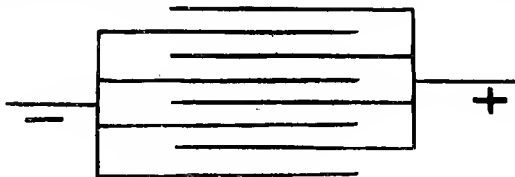

Fig. 98.

of one series can be pushed in between those of the other, thus allowing the one set to enter deeper or be withdrawn according to whether it is desired to increase or to diminish the capacity. Condensers formed of metallic sheets separated by strata of micanite plunged into recipients filled with petroleum have also been employed successfully.

In this way great capacity can be obtained with little bulk, and by grouping differently the different sheets, it is possible to vary at will the capacity put in circuit.

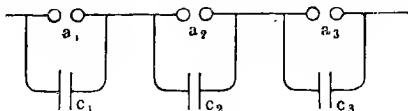

Fig. 99.

Braun Condensers.—Among the different methods of grouping the condensers, besides that of placing them in parallel, we note that represented in Fig. 99, which was adopted by Braun in his system.

As may be seen, each condenser bears its own sparking gap, so that by adding or taking away any of the elements the

oscillation period of the discharge is not altered, the energy only set in motion by the discharge being increased or diminished.

The best form to give to this arrangement is, according to Braun, that shewn at Fig. 100, in which one of the coatings

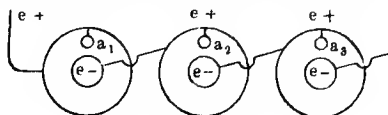

Fig. 100.

of each condenser being completely surrounded by the other, the capacity of the sparking balls and of the connecting wires is reduced to the minimum possible. The form definitely given by Siemens and Halske to the battery of Braun condensers as applied to the transmitting apparatus of the radio-telegraphic stations, is that shown at Fig. 101.

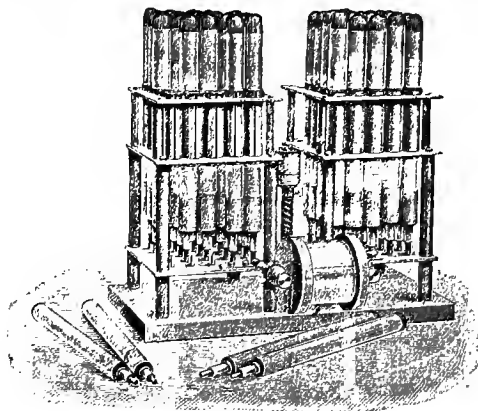

Fig. 101.

Each condenser is constituted of a certain number of Leyden jars, each one formed of a glass tube 1" in diameter, having a thickness in the sides of from $\frac{1}{10}$ to $\frac{1}{8}$ of an inch.

The appearance presented by the battery is that of a group of test tubes standing upside down in their respective racks, and the manner in which the jars are united together allows of their number being increased or diminished with the greatest ease, as also of their replacement in case of breakage. The capacity of each element is from .0004 to .0005 of a unit (micro-farad). These condensers are charged by means of a coil specially wound to furnish, not so much high potentials, as a large quantity of electricity.

The transformer through which the primary passes the discharge current of the condenser is that shewn at Fig. 92, page 145.

The condensers of the Braun receiving apparatus, although they have a capacity similar to that of the transmitter, are much smaller, as they have to stand much lower potential, and are generally formed of a certain number of conducting sheets, separated by thin insulating layers.

At Fig. 102 on the left, we have the external appearance of such a condenser connected up to its corresponding transformer for the reception of waves of 200 metres in length.

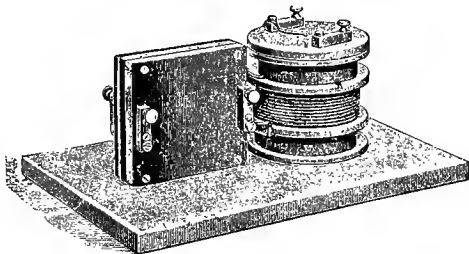

Fig. 102.

Slaby-Arco Condenser.—Our Fig. 103 shews the arrangement given by the Allgemeine Elektrizitäts-Gesellschaft to the battery of Leyden jars in the transmitting apparatus on the Slaby-Arco system. The jars are in pairs, fitted one in the other, each having a capacity of .001 micro-farads, fitted between two wooden discs, against which they are bolted, rings of felt being interposed.

Their external coatings are placed in communication by

means of a sheet of tinfoil placed on the lower wooden disc, the internal coatings are separated the one from the other, making contact with a well insulated central sheet, on which are arranged the contacts that can be grouped together as



Fig. 103.

desired. This battery is surrounded by a cylindrical tube of cardboard or of micanite, and introduced into the large cylinder of the sending apparatus shown in Fig. 104.

The Condenser at Poldhu.—In extra-powerful stations, the condensers used in the discharge circuit, which determine the period of oscillations, must allow of the enormous quantities of energy employed being brought into play, and therefore must have considerable capacity.

In the station at Poldhu these consist of a score of single condensers joined up in parallel. Each one of these consists of a sheet of glass coated on its two surfaces with a square sheet of tinfoil 12" in the side. Twenty such sheets arranged parallel in a vessel filled with boiled linseed oil constitute a single condenser that presents the capacity of about $\frac{1}{20}$ of a micro-farad. The complete condenser consists of 20 single condensers arranged in parallel, and presents therefore a capacity of about one micro-farad.

A condenser built up of many elements has the inconvenience that, when it is inserted in the charging circuit, the elements do not occupy the same position in the circuit, and

therefore the partial discharges will not have equal periods. This is especially injurious in syntonized radio-telegraphy, in



Fig. 104.

which the circuit containing the condenser must have a determinate tuning.

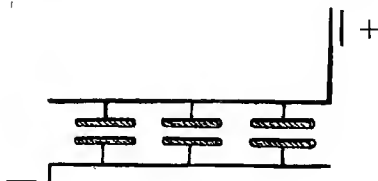

Fig. 105.

This inconvenience may be obviated by arranging the component condensers in the manner shewn at Fig. 105.

The length of the discharge circuit is in this arrangement exactly the same for each of the component condensers, so that their partial discharges have a period which is rigorously equal.

Syntonisers.

The apparatus which serves to place two stations or two different oscillating circuits of one and the same station in tune or in accord with one another goes by the name of "tuner" or "syntoniser."

Since agreement takes place when the oscillation periods of the circuits to be tuned are equal, and the vibration periods depend upon the capacity and on the self-induction of the circuits so to obtain this agreement, it is necessary to be able to vary the one or the other or both of these elements; syntonisers are therefore generally constructed either with self-induction bobbins introduced in the circuit to be tuned, the self-induction of which bobbins can be varied by increasing or diminishing the number of turns inserted in circuit, or in other manners, which we will describe in the chapter on "Syntony."

Syntonisers are likewise constructed like condensers of variable capacities, as for example those at Figs. 98 to 101, pages 144 to 152.

Different makers adopt special arrangements in order to render these variations in self-induction and in capacity prompt and convenient: Fessenden adopts the syntonising key already described at page 103, Fig. 52; others favour the arrangement indicated at Fig. 94, in which the contact *G* can be slid along the spiral, thus increasing the length inserted in the oscillating circuit; Ducretet makes use of a large mural square which serves as a support for a copper wire of about 100 metres in length, bent zigzag fashion, along which contacts are run that permit of the insertion into the circuit of a greater or lesser length of the said wire.

Portable Syntonising Coil.—Count Arco has devised an apparatus which allows several stations to be placed in perfect accord with each other, without previously communicating the one with the other. This is represented at Fig. 106, and consists of a cylindrical box that bears at its upper extremity a spinthermometer (spark length measurer), and a

sliding contact that runs along a graded vertical scale. In the box is placed a self-induction coil, the lower end of which is put into communication with the bottom of the sky rod,

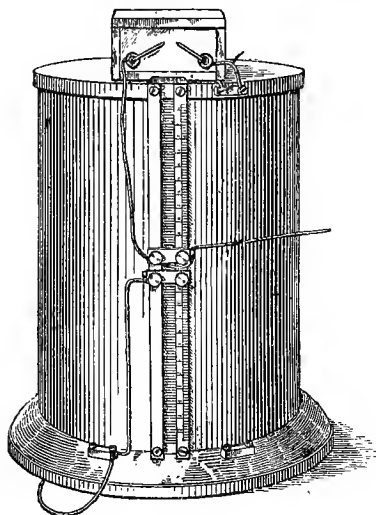

Fig. 106.

that is above the spiral U (Fig. 107) that in the Slaby-Arco system places the sky rod to earth, its upper extremity is connected to one of the points of the spark length measurer and its intermediate point, which is variable, is in connection with the movable external contact. The other point of the spark length measurer is connected with the sliding contact.

In connection with the wires from the coil and from the movable contact that goes to the spinthermometer a condenser having the same capacity as that of the coherer used in the receiving station is inserted in shunt. After having tuned the period of the oscillator with that of the sky rod by working on the self-induction U and the condenser K the synchronising coil is applied to the base of the sky rod, and the movable contact is shifted until the spark at the spinther-

momenter has acquired its greatest length. In this position the period of the syntonising coil coincides with that of the station.

The movable contact is now to be set at this position, and the coil is now carried to the station to be tuned with the first, attaching it to the base of the antenna, and the self-induction U and the capacity K of the oscillator are varied until the sparks at the spark length measurer of the syntoniser again reach the maximum length. The two stations are then in a condition to emit waves of equal frequency.

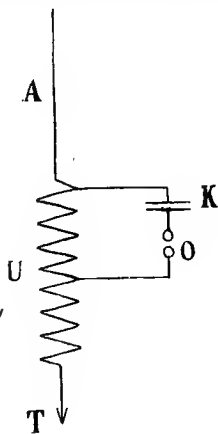

Fig. 107.

In precisely the same manner, by replacing for a moment the coherer by an auxiliary exciter, the receiver is syntonised, and so on, for the other stations.

This apparatus can also be graded in order to give directly the wave length of the oscillator with which it is in tune.

Doenitz Wave Measurer.—According to Doenitz the data given by means of the Arco Syntoniser have not sufficient exactitude, due to the too great damping of the open circuit bobbin that serves as a measure. He therefore contrived the apparatus represented at Fig. 108, called Undometer or Wave Measurer, in the vibrating circuit of which is a closed

circuit containing both self-induction and capacity, and which can be easily put in tune with the vibrating circuit, the wave length of which it is desired to ascertain.

To the right of the figure is represented the self-induction coil that can be replaced by the other two coils furnished with the apparatus, these are such that their self-inductions are in the ratio $\frac{1}{4} : 1 : 4$. In the middle of the apparatus is placed a cylindrical recipient full of oil, in which are several semi-circular metallic sheets, parallel to one another and

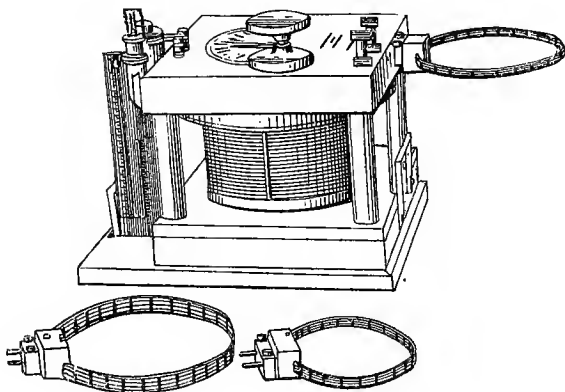

Fig. 108.

fixed ; while an equal number of similar semi-circular sheets movable around a vertical axis play ; these, by means of an external knob, can be fixed to slide more or less into the spaces between the fixed sheets, so as to constitute a condenser of variable capacity similar to that shewn at Fig. 98. To the left is shewn the indicating apparatus, which consists of an air thermometer, in whose bulb is enclosed a spiral, on which another spiral, that forms part of the main circuit, acts by induction.

The vibrating apparatus, the length of whose wave it is desired to ascertain, is caused to act inductively on the self-induction coil of the undometer, and by turning the external knob the capacity of the condenser is altered, until the

thermic indicator shews the greatest rise of temperature ; the undometer is then in tune with the vibrating apparatus, and the length of wave can be read off a graded dial, over which a pointer connected with the knob travels.

This quadrant or dial bears three gradings, each one of which serves for one of the three self-induction coils furnished with the apparatus.

With the capacities and self-induction coils adopted by the inventor, it is possible to measure waves having a length of from 140 to 1,200 metres.

Wave Detector.

The Coherer.—The detector more commonly made use of to notify the arrival of the electric waves upon the antennae of the receiving stations, putting into action the different appliances that announce or register them, is, as we have already said, the coherer.

For the same purpose, Marconi made use of an entirely different piece of apparatus, called by him a "magnetic detector," or simply "detector," which we will describe later on. In truth, any one of the very numerous forms of apparatus employed by different experimenters from Hertz onwards, in the study of electric waves, might be used for the purpose ; but since none of them has a sensibility at all comparable to that of the coherer, their use is entirely excluded in practice, where the receptive portion must have the highest sensibility, since the quantity of energy at our disposition for exciting them is at a minimum.

We shall therefore limit ourselves to the description of such detectors as are used in wireless telegraphy.

We have already said that the coherer is based upon the property that certain metallic and other powders have of impeding, in ordinary conditions, almost entirely the passage of the electric current, but of permitting, on the other hand, such a passage as soon as they have received the impact of the electric wave.

Moreover, such powders return to their original non-conducting condition, provided they are agitated mechanically by little taps, or otherwise.

Such powders are therefore almost non-conductors under

ordinary conditions, but when under the action of electrical oscillations they become conductors.

Such powders or filings are usually enclosed in small glass tubes (Fig. 109), between two metallic electrodes *S S*, from which start the wires that serve to place them in the circuit with the battery *B* and the electric bell *L*. This latter, by its ringing, announces the arrival of the wave. Sometimes a more sensitive apparatus, called a relay, is interposed.

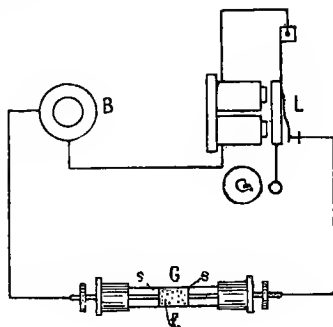

Fig. 109.

If the little tube is on the same base as the bell, the vibration of this latter will generally suffice to restore the non-conducting conditions of the filings or powder within, at the cessation of the arrival of the waves.

History of the Discovery.—The little tube with filings used as a revealer of electric waves was proposed by Lodge, who gave it the name of “coherer,” because he attributed the conductivity that it acquired under the action of the wave to a kind of cohesion or contact that established itself between the grains of powder, as an effect of reciprocal attractions, or of sparks discharging between them, a contact that agitation would afterwards destroy, re-establishing the primitive condition.

Lodge was also the first to show the extreme sensibility of the arrangement; however, the coherer originally used by him was a single contact coherer, consisting in two little

balls very close to one another, or in a metallic point *N* (Fig. 110), in proximity to a metallic spring, between which, on the receipt of the electric wave, a minute spark took place, that put them into contact with one another; de-coherence was effected mechanically by means of a slightly-cogged wheel *t*, which was kept in rotation by a clockwork movement on which the spring *o* dragged.

Lodge substituted for this a tube of filings, after he had learnt the researches contemporaneously made by Branly, in which he recognised the fact of its being a multiple contact coherer, much more convenient and sensitive as a wave detector than his, with single contacts.

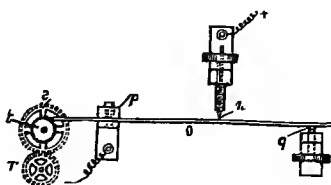

Fig. 110.

The discovery of the diminution of resistance in tubes containing metallic filings or grains, or semi-conducting bodies, when traversed by discharges or by electrical currents, dates back as far as 1838, and was made by Munck of Rosenschöld, who also ascertained that these powders re-acquired their primitive resistance after having been subjected to mechanical disturbance: the phenomenon was, however, forgotten.

In 1884 and 1885, Professor Calzecchi-Onesti of the Royal Lyceum of Fermo, instituted, independently of such researches, a systematic study of the conductivity of metallic powders, in the course of which he ascertained the fact of a gradual increase in the conductivity of powder by successive interruptions in the current sent through them, or by a similar passage of discharges from a Holtz machine, or from a coil, or finally, in lesser degree, even by the mere influence of an electrified body.

This last fact may be numbered among "actions at a distance."

Calzecchi caused the tube to lose the conductivity it had acquired by making it rotate on its own axis.

In 1890 Branly, ignorant of the researches of Calzecchi, took up the study of the resistance of powders, extending it also to mixtures of metallic powders and insulating substances, either compressed or melted together so as to form solid cylinders, put into contact simply between rods, sheets, or metallic balls. He ascertained not only the diminution of resistance in the cases studied by Calzecchi, but he recognised that the action of a discharge takes place not only when they act upon conductors in metallic contact with the powders, but also when the electrodes are placed at greater or lesser distances from these latter, even by the interposition of non-metallic diaphragms. He ascertained that mechanical disturbance or a slight heaping up was sufficient to cause the powders to lose the conductivity acquired under electric action; and lastly, he discovered that with suitable powders (such as antimony, aluminium, etc.) it was possible to construct tubes (anti-coherers) that behaved in the opposite manner to the ordinary ones, that is to say, that under the action of the waves their resistance increases instead of diminishing.

Lodge saw in the phenomena presented by the Branly tubes an effect of the electric waves awakened by the discharges at a distance, and made, as we have said, a detector of electric waves from such a tube, adding afterwards a little hammer, whose function was to restore the primitive conditions on the cessation of the action of the wave.

The little hammer first used by him was that of an electric bell, actuated by the same current that traversed the tube; but afterwards he replaced this by a hammer moved mechanically, since he found that the spark at the contact breaker of the electric bell often prevented the filings from re-acquiring their original resistance, as even these sparks were accompanied by electric waves.

Theory of the Coherer.—Experimenters having recognised the great sensibility of the coherer, rather than replace it by other devices, gave their attention to perfecting its construction, in such a manner as to produce an apparatus of regular and certain action, as required in such important and delicate service as is needed in wireless telegraphy.

The attempts towards perfecting the coherer required, as a guide, a knowledge of the mechanism of their action, a subject which has remained hitherto somewhat obscure, notwithstanding the many studies that have been made to ascertain it.

The coherer, in fact, presents a complication of phenomena which it is difficult to explain by a single theory.

There are four categories of coherers, of which theory should explain the action :

1. The ordinary coherers, which are in the larger number, and in which the resistance *diminishes* under the action of electric waves, to re-acquire it by mechanical shocks, by slight heating, or by other external actions.

2. The anti-coherers discovered as aforesaid by Branly, which on the contrary have their resistance *increased* by the action of the waves, and lose it by percussion.

3. The self-decohering coherer, which re-acquires spontaneously their resistance when the action of the waves ceases, without requiring either blows or other external action. These are coherers with carbons, and the mercury carbon form by Tommasina.

4. The self-cohering decoherers, which are obtained specially when to the dielectric employed in other coherers is substituted an electrolyte (water). These at the cessation of the electric waves lose spontaneously the greater resistance that they had acquired under their influence.

Among the various theories proposed to explain these phenomena, that which has met with the most general acceptance, is that of Lodge (see page 161). It explains in the simplest manner the commonest phase, which is that presented by the ordinary coherer.

According to this theory the electric waves set up electric vibrations among the particles of the filings, between which little sparks take place, giving rise to a bridging over with fine powder carried along with the spark from the larger grains. A shake, a blow or heating, breaks down this bridging over and re-establishes the primitive condition. In some few bodies (carbon, or carbon mercury) which present the phenomena of spontaneous decohesion (third category), in consequence of some special structure, these "bridges" would be excessively delicate, and would break up of them-

selves without any mechanical jolt as soon as the action of the waves ceased.

It is perhaps more difficult to form an idea by this theory of the mode in which the second category (anti-coherers) act, and in fact these are few and very uncertain in their action; in some it may be attributed to a chemical reduction or change in the bodies, in others, as in anti-coherers, made of a silvered glass sheet, crossed with very fine lines traced by a diamond, to the existence of very fine metallic filaments that have remained like bridges across the furrows; and such filaments either are broken in consequence of the sparks, and are renewed on the condensation of the metallic vapours, or else they undergo an increase in resistance by the heating that takes place under the action of the wave, as in ordinary metallic wires.

Other theories go farther than that of Lodge, as for instance that of Ferrié, in which the coherer is likened to a series of condensers formed by successive grains of filings, which discharge upon themselves, soldering themselves together by the increase in the difference of potential produced by the wave. Guthe and Trowbridge suggest that the diminution of resistance is due to the ionising the insulator lying between the particle of filings caused by the greater difference of potential that manifests itself between them when under the action of the electric waves.

Many direct observations support Lodge's theory, as among others that of the formation under the action of electric waves, of true chains of filings adhering between two electrodes, on one of which was placed metallic filings, as shewn by Tommasina.

Again, Arons and Malagoli have ascertained that real sparks pass between the filings. These two facts seem to justify the acceptance which this theory has received, a theory which, if it does not fully explain, at least throws much light on such a complex phenomenon as that presented by the coherer.

Branly has proposed another, according to which the electric waves impart temporary conductivity to the small stratum of insulating medium that separates the particles of filings, or at least would permit the passage of electricity between two particles which find themselves at a greater

distance than that at which the passage of the simple current from the battery connected to the coherer would be able to traverse; in either case, on the cessation of the action of the waves, the former conditions would obtain.

This latter theory lends itself therefore better to the explanation of the relatively rare cases of spontaneous decohering coherers than to that very common one of the coherers that decohere at mechanical jolts. In view of this theory, Branly gave the name of "radio-conductors" to the tubes with filings, a name which some prefer, as it only points to a fact, leaving the true nature of the phenomenon unexplained.

The action of coherers belonging to the fourth category otherwise than by Lodge's theory, by admitting that the electrolyte which takes the place of the dielectric, is more or less decomposed, according to the greater or lesser difference of potential applied to it, and that the increase of resistance is due to the gas thus given off; this producing an anti-coherer. But the gas escapes as soon as it is set free; therefore the resistance spontaneously falls as soon as the cause that increased the difference of potential ceases, and therefore we have a self-decohering coherer.

Practical Notions.—However ingenious and persistent have been the studies made of the theory of coherers, it does not appear that the hoped-for suggestions as to the ways of bringing about perfection in these delicate appliances have given any result, since any improvements introduced into their construction have been based more upon practical results than upon theory.

The conditions to be fulfilled by an ordinary coherer for wireless telegraphy are sensibility and regularity in action; that is to say, it must present a maximum of diminution in resistance for a minimum of difference of potential, and a rapid and certain return to its primitive resistance with the slightest jolt.

An experimental result which is very useful as a guide in researches as to the best conditions of the action of a coherer, is that found by Blondel, namely, that decoherence by taps does not take place when the difference of potential between the electrodes of the coherer reaches or surpasses a determinate limit, that Blondel calls *the critical tension of coherence*. This tension is not a well-defined physical con-

stant, but varies with the nature of the metal, the degree of oxidation, and with the pressure on the filings.

It is therefore necessary to use in the coherer circuit a cell or battery of rather small electro-motive force, in order that, in addition to the above, that set up by self-induction at the instant of the breaking of the coherer circuit, the aforesaid critical tension point should not be reached, otherwise the coherer, even after being tapped, continues a conductor, and the signal lasts.

Since, however, the use of a battery of too small electro-motive would necessitate the use of too sensitive a relay, it is sought to diminish the E.M.F. of self-induction by joining with shunt wires the two extremities of the coils in the circuit, in which such E.M.F. is set up.

During the action of the coherer the metals that compose it get oxidised; therefore the critical tension of cohesion, and with it the conditions of good work, vary.

In order to avoid this, Lodge has advised the use of a vacuum in the tubes, or the substitution therein of an inert gas, such as nitrogen, to air. It appears, however, that the injurious effects of the oxygen of the air on the filings, and therefore the duration of the coherer, are less to be dreaded than moisture enclosed in the little tube; hence the gas contained in it must be absolutely dry.

The conditions which have the greatest influence on the sensitiveness of the coherer are, the nature of the metallic filings and of the electrodes, their degree of oxidation, the fineness of the filings, and the pressure exerted by these on the electrodes.

With respect to the nature of the metals, it is necessary and sufficient in practice that one of them should be slightly oxidisable, without which the critical tension point will be too low; the filings must be fine, but not too minute, because with metals in fine powder the results are irregular; the pressure must not be too weak, as that would render the instrument too sensitive, nor yet too strong, because that would render them permanently conducting.

The pressure can be regulated by varying the quantity of filings, or by causing a magnetic field to act on them in those cases in which the electrodes and the metals are magnetic.

It must not be thought that it is advisable to increase indefinitely the sensitiveness of the coherer; this sensitiveness, that is to say its power of acting with the least difference of potential set up by the incident wave, is generally inversely as its regularity, that is its capability of recovering its original existence in receipt of the slightest tap. If, for example, the pressure of the filings was increased to such a point that a minimum E.M.F. would set up coherence, the tap which ought to restore it to its normal condition may increase the density of the filings and put it into a state of permanent coherence.

One of the conditions that favours sensitiveness and, at the same time, regularity, is the use of a cell of low E.M.F. at the electrodes of the coherer, because of the difficulty encountered in obtaining coherers at one and the same time very sensitive and very regular, experimenters have contented themselves to sacrifice the first quality for the second, which is much more important, and employ controllable coherers having relatively small sensitiveness.

The practical principles now explained give us reasons for the modification and details of construction adopted in the principal types of coherers which we are now about to describe.

Types of Coherers.—In order to describe these methodically, we shall classify coherers in the following types:

1. Ordinary Coherers with filings.
2. Magnetic Coherers, in which the electrodes and the filings are of magnetic metal, in order to be able to regulate by a magnet the pressure on the filings.
3. Simple Contact Coherers, in which, instead of filings, there are short rods or metallic spheres that offer one or more points of contact with each other.
4. Spontaneous Decohering Coherers.
5. Anti-Coherers.

To the description of the three first types of coherers we shall add that of the devices employed to decohere them.

Ordinary Coherers with Filings.

Lodge's Coherer.—It was Lodge, as we have said, who was the first to use the coherer with filings as a revealer of

electric waves. This was nothing else than the Branly Tube, to which Lodge had added the decohering hammer. We know (page 167) that later on he proposed producing a vacuum in the tubes and introducing therein an inert gas, in order to avoid that during work the degree of oxidation of the filings should become modified, thus altering the sensibility of the apparatus.

Along with Muirhead, he proposed also a magnetic coherer, which we will describe later on (see Fig. 123), in which the filings were retained between two metallic sheets without the intervention of a tube.

The Marconi Coherer.—One of the first cares of Marconi, when he began his experiments on wireless telegraphy, was that of modifying the construction of the Branly tube, so as to give it the necessary sensitiveness and regularity.

Fig. 111 shows the particulars of the construction of the coherer used by Marconi in 1897, and which remained



Fig. 111.

afterwards in use in his apparatus. The metallic powder is placed between two silver stoppers connected to the external circuit by platinum wires, welded to the ends of the glass tube. The powder is a mixture of nickel filings, with 4 per cent. of silver filings. By increasing the proportion of silver, the coherer becomes more sensitive, but if it is rendered too sensitive it becomes too subject to the influence of atmospheric electricity.

A little globule of mercury added to the metallic powder also increases the sensibility of the coherer.

The quantity of mercury must not be such as to render the powder pasty; instead of mixing the mercury with the powder, the faces of the stoppers may be amalgamated.

The dimensions which Marconi gives as being most suitable for the tube are $1\frac{1}{2}$ inches long by $\frac{1}{10}$ inch internal diameter. The length of the silver stoppers is about $\frac{1}{5}$ of an inch, and the distance between them about $\frac{1}{50}$ of an

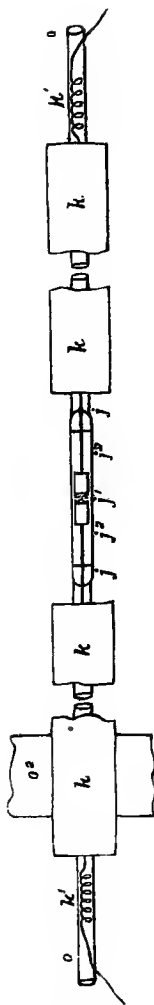

Fig. 112.

inch. The shorter this distance, the more sensitive the coherer, but there is a certain limit beyond which the instrument will no longer act correctly.

The metallic powders must be coarse, and made with a coarse file, and of uniform size; with suitable sieves, any grains that are too fine or too coarse must be separated. The files must be frequently washed and dried, and only used when dry. The filings between the two stoppers must not be too tightly compressed, so that they may move freely when the percussor strikes the tube.

It is not essential to have a vacuum in the tube, but it is useful; usually a vacuum of $\frac{1}{10000}$ of an atmosphere is produced.

If the coherer is well made, it should be affected by an electric bell at a distance of 1 or 2 metres. It also should immediately interrupt the current in a non-inductive circuit containing a single cell.

Through the coherer there should not pass more than one milli-ampere, and for that reason use is made of a single Leclanche element; if an electro-motive force greater than 1.5 volt were employed, the current would pass through the coherer, even without the action of the electric waves.

Fig. 112 represents the said coherer with the addition of the metallic plates $k k$, which were made use of in the experiments of 1897 (see Chapter X.) to place the coherer circuit in tune with the transmitter circuit, in order to facilitate reception. The plates $k k$ are in communication with the ends of the sensitive tube, and have a width of about $\frac{1}{2}$ inch, and are about $\frac{2}{5}$ of an inch in thickness. The vibration period of the electrical

discharges in these plates depends on their length, and the most suitable length must be determined experimentally.

This is effected in the following manner:—A piece of tinfoil is gummed on a piece of glass, and is divided into two equal sections by cutting it along a median line. The two sections are exposed to the waves emanating from the transmitter, and they are lengthened or shortened until sparks pass with the greatest brilliancy across the gap, even at a considerable distance from the transmitter.

The plates $k k$ of the apparatus must be about half an inch shorter than the length thus determined.

These plates $k k$ are fixed to a thin tube of glass O , which should not be more than 12 inches long. This tube is fastened on one side to a wooden support O^2 , or else the sensitive tube may be fixed permanently at both ends. The coils $k' k'$, called choking coils, corresponding to the two $A B$ of the Popoff apparatus (Fig. 41), serve to prevent the waves passing into the circuit of the battery. Later on, by the use of longer waves, the plates $k k$ became superfluous, and were suppressed.



Fig. 113.

The Slaby Coherer.—The coherer made use of by the Allgemeine Elektrizitäts-Gesellschaft in the Slaby-Arco system is represented in Fig. 113. It is a tube from which the air has been removed, narrower at the central portion, into which enter two silver cylinders that fit it so well that between them and the sides of the tube the fine powder that lies between the cylinders cannot pass. From the cylinders start platinum wires that serve as conducting wires, and which are soldered to two little capsules that are cemented to the ends of the tube.

A peculiarity of these tubes is that of having, notwithstanding the perfection of their sealing, a controllable sensibility. For this purpose the two facing superficies of the little silver cylinders are not parallel, but one of them is

cut on the skew, so that the gap left for the powder becomes **V**-shaped. The powder fills barely one-half of the aforesaid space; if the coherer is placed in such a manner that the narrower portion of the **V** space is downwards, the powder occupies the greater height in the gap, its pressure is greater, and the sensitiveness of the apparatus is at its maximum. If, on the contrary, the larger portion of the **V** be turned downwards, the powder takes a lower level, and exercises the least pressure, so that the sensitiveness of the coherer is also at a minimum.

The tube is rested on supports that permit it to rotate on its own axis, so that this gives the means of altering the degree of sensitiveness to any point between the aforesaid limits, by inclining more or less, with regard to the vertical, the receptacle of the powder.

By this arrangement the sensitiveness of the coherer can be made to vary, even during the receipt of a telegram.

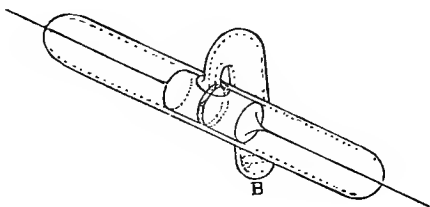

Fig. 114.

The Blondel Coherer.—This is shewn at Fig. 114; it consists of a vacuum coherer, the cylindrical tube of which bears a lateral tube closed below, and which contains the filings. This can be opened in accordance with the gap comprised between the cylindrical electrodes.

By suitably inclining the tube, the filings contained in the space between the cylinders may be caused to leave the space, and to enter into the lateral tube, thus diminishing the pressure and the sensitiveness, or they can be caused to enter into the gap, thus obtaining the opposite effect.

Instead of using filings of different metals as employed by Marconi, Blondel employs alloys of an oxidisable metal, and one not oxidisable (silver and copper, or nickel). With a small proportion of the oxidisable metal, alloys are to be obtained which only oxidise when heated. By heating filings thus prepared, the desired degree of oxidation may be given to them, which will not alter at ordinary temperatures.

The Ferrié Coherer.—Ferrié has modified the form of the preceding coherer, while retaining the principle, in order to render it less fragile and more convenient for placing on its supports. The reserve supply of filings is contained in a hollow *H* (Fig. 115) made in one of the electrodes. By means of a little channel *r* forming a feeder, the filings may

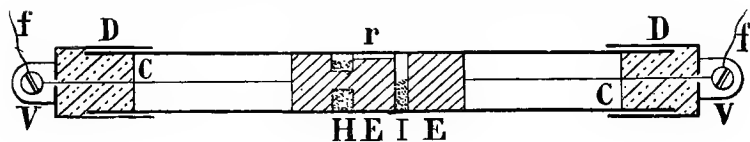

Fig. 115.

be caused to pass from this hollow reservoir into the useful space *I*, or may be withdrawn therefrom. The tube is closed with sealing wax, and its extremities are protected by little metallic caps, to which are attached the wires that come from the electrodes. According to the sensibility desired, Ferrié makes use of filings, either of gold or of silver, alloyed with copper in variable proportions, or of gold and silver in the pure state, enclosed between electrodes of German silver or of steel. Pure gold furnishes the most sensitive coherers. These instruments are used with an E.M.F. of from 0.2 to 1 volt, controlled by a suitable rheostat, which admits of the regulation of the voltage in such a way as to give it the nearest possible value, to the critical tension of coherence.

Ducretet's Coherer (Fig. 116).—An ebonite tube *T* contains two electrodes *A B*, between which is placed the filings' receptacle. The first electrode output is a fixture, and is cut obliquely; the second is movable by means of the

screw *B*, and is cut perpendicularly in the axis of the tube ; the whole is permanently and hermetically closed, but no vacuum is made therein.

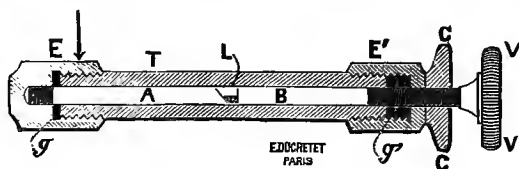
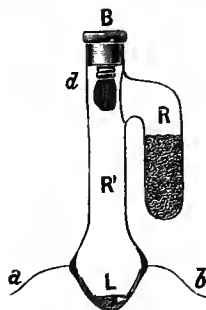

Fig. 116.

A suitable quantity of filings having been introduced into the receptacle and the apparatus closed, it is possible by means of the screw *V* to advance or withdraw the electrode *B*, thus causing the height of the filings, and with it the sensitiveness of the coherer, to vary.

In this coherer, nickel filings of medium coarseness, such as will pass through a sieve having 80 holes to the square inch, but not through one having 120, are preferred. These should be slightly oxidised by placing them on a sheet of steel gently warmed, until they have acquired a golden yellow tint, when they must be withdrawn.



EDUCRETET
PARIS

Fig. 117.

Fig. 117 gives an idea of another coherer devised by Ducretet, in which the electrodes are two parallel wires of

platinum *a b*, welded into the glass and placed at the bottom of the recipient *L*.

From the reservoir *R* a sufficient quantity of filings prepared as aforesaid are caused to pass on to the wires, and the height, and therefore the pressure of these filings, is regulated according to the degree of sensitiveness to be obtained.

The little bulb *d* contains some hygroscopic substance.

Rocheport's Coherer.—This consists in two electrodes, of which one is annular and surrounds an insulating cylinder; the other, which is in the form of a rod, passes through the axis of the first, and enters into the insulating cylinder.

The rod and the ring are respectively connected to two platinum wires, which are welded into the two ends of the tube. The filings are placed between the two electrodes in such a way as to come almost level with the rod. A piece of calcium chloride in the form of a cigar, keeps the tube dry, in which a vacuum can be maintained. This coherer can be made of the magnetic type; with this it suffices to make the electrodes and the filings of soft iron.

Magnetic Coherers.

Tissot's Coherer.—This consists of two electrodes of soft iron from 3.5 millimetres (say $\frac{1}{5}$ of an inch) in diameter; these are cut obliquely and placed in a glass tube, and between them lies a small quantity of soft iron filings.

From the electrodes start the conducting platinum wires that issue from the extremities of the tube into which they are welded. In the tube is produced a vacuum equal to about 1 millimetre of mercury, and above the tube is arranged a magnet, by means of which the pressure of the filings against the electrodes can be regulated.

This mode of construction is based upon the observation made by Tissot that when a coherer containing metallic filings is placed in a magnetic field, having its lines of force parallel to the axis of the coherer, both the sensibility and the regularity of its action are largely enhanced. There is also the advantage that a much higher E.M.F. can be used between the electrodes, without any risk of exceeding the critical tension of coherence limit, since this increases with the distance between the electrodes; and these may be

separated by an interval of from 6 to 8 millimetres ($\frac{1}{4}$ to $\frac{1}{3}$ inch) without the sensitiveness of the coherer being diminished, whereas in the ordinary form a distance of $\frac{1}{25}$ inch (1 millimetre) suffices to produce a decrease.

Braun's Coherer.—On the "Braun" system, as applied by the "Gesellschaft für Drahtlose Telegraphie," coherers made up with steel filings between electrodes of the same material are employed. No vacuum is made in the tube, which is of ebonite.



Fig. 118.

One of the electrodes of the coherer protrudes a little from the tube, and is placed between the poles of a horse-shoe magnet, movable in such a way that one or the other of its poles can be approached to the electrode, or be placed so that the electrode lies symmetrically between the two poles in such a manner that their action on it balances. Thus, the coherer receives weak magnetisation of controllable intensity, which is favourable to its sensibility.

Fig. 118 represents the whole and the constituent parts of this coherer, which is shewn in position at Fig. 141, page 203.

Simple Contact Coherers.

Lodge's Coherer.—This was the first coherer used as a revealer or detector of electric waves. It is constructed in the mode already indicated at page 162 (Fig. 110).

Orling and Braunerhjelm's Coherer.—This consists in a number of small conducting balls placed in single file

between two electrodes, within a closed insulating tube, in which a partial vacuum has been made.

In order to vary the pressure of the balls, one on the other, the tube is placed on a support that allows of its being inclined more or less from the horizontal.

A modification of the same apparatus, due to the same inventors, is that shewn at Fig. 119, in which the little balls are arranged in two rows, one on the top of the other ; the

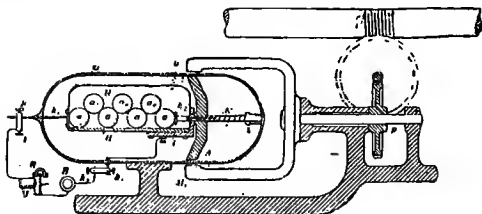

Fig. 119.

tube remains always horizontal, but the pressure of the balls is modified by pressing the lower line of balls more or less against the other by the aid of a piece of iron *A*, under the influence of the magnet *M M'*, which itself is movable under the action of an endless screw and rackwork.

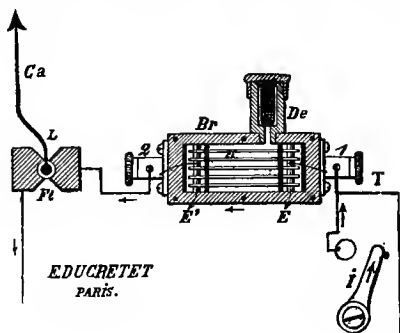

Fig. 120.

The Popoff-Ducretet Coherer.—This consists in little metallic rods *Ti* (Fig. 120) enclosed in a hermetically-sealed

mount, containing a drier *D e*. These metallic rods, as well as their supporting electrodes *E E'*, may be of different metal, and must be brought to the same degree of polish and of oxidation as above indicated in speaking of the Ducretet filings coherer (page 174). The authors prefer tempered steel rods, and in this case, by means of a magnet furnished with the apparatus, it is possible to regulate the pressure of the rods on the electrode.

The Branly Coherer.—This coherer consists of a tripod of steel needles resting on a metallic plane. The working contact is that made by the needles on the plane.

Decoherers.

Mechanical Decoherers.—For brevity's sake, we shall give the name of decoherer to all devices used in order to cause coherers to lose the coherence acquired under the action of the electric waves. We have already pointed out (page 163) that Lodge employed to this end a little hammer or electro-magnetic percussor in connection with the Branly tube, and afterwards a similar device moved mechanically.

Electro Magnetic Tappers are even now the most commonly used method for obtaining a decoherence. Tappers have a great importance, because on the regularity of their action depends largely the accurate registration of the signals. Popoff (see Fig. 41, page 84) also made use for decoherence, of a little hammer *F*, similar to that of an electric bell, which during the attraction of the electro magnet struck the bell, and on its return struck an india-rubber ring that surrounded the coherer tube.

Marconi employs a similar tapper, which, however, strikes the tube in its forward stroke (see Figs. 156 and 159); this has a very high resistance (500 ohms), and its movement is extremely small, so that the little hammer only just touches the tube. This allows the coherer to be used with a voltage very close to the critical tension, without any risk that the too accentuated strokes of the hammer should condense the filings, and cause them to re-acquire conductivity by increase of pressure.

In some of Marconi's receivers (Fig. 154) the blow is given on the return stroke. Care must be taken to avoid

the formation of sparks at the interruption of the hammer, because these being accompanied by electric waves, might influence the coherer. For this reason, shunt circuits are connected to the bobbins of the electro magnet, which shunts take the name "spark arresters." Slaby, in order to facilitate decoherence, breaks the coherer circuit before this receives the tap. For this purpose he makes use of the apparatus represented in Fig. 121—the lever NA bears at N the striker; when this is lowered by the effect of the attraction of the electro magnet E , it causes, by means of the little rod LA , the springs LR to become detached from the screw H , thus opening the coherer circuit. With this arrangement the shunt spark arrester becomes unnecessary.

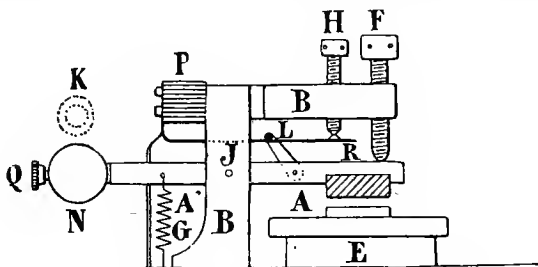

Fig. 121.

Another device of Slaby's for decohering is seen at Fig. 146. Rupp decoheres by keeping the coherer in continual rotary movement on its own axis, utilising for this purpose the same motive power that drives the strip of paper p of the Morse receiver (see Fig. 145).

Magnetic Decoherers.—In magnetic coherers, decoherence is generally obtained by magnetic means. Turpain, for example, places the Tissot coherer in the field of an electro magnet that is excited at the moment that the coherer becomes conductive, so that the coherer receives a shock that decoheres it rapidly. Brown surrounds the coherer (which has iron electrodes) with a wire traversed by an alternating current, which, magnetising the electrodes alternately in opposite sense, keeps up agitation in the nickel filings interposed, or he obtains the same result by causing

a horse-shoe magnet M (Fig. 122) to rotate before the said iron electrode.

Magnetic decohesion can be obtained with opportune appliances even in coherers that are non-magnetic. For example, in the coherer patented in 1898 by Lodge and

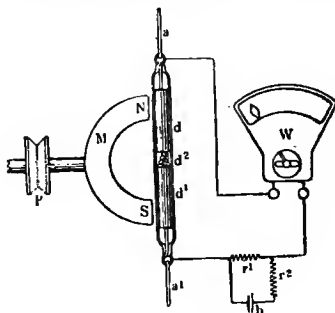

Fig. 122.

Muirhead (Fig. 123), the filings are enclosed between two sheets, one of which, b , which is over and near to the poles of a permanent magnet E , is covered with varnish,

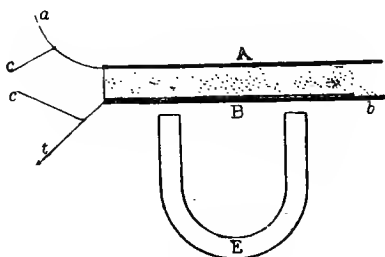

Fig. 123.

except along a streak at b ; c and c' are two conductors that lead to the relay, and a and t respectively those to the antenna and to the earth wire. When the electric waves render the filings conductive, the coherer current traverses the sheet b , and by the action between currents and magnet

the sheet is attracted by the magnet, and the movement set up decoheres the filings.

Orling's Coherer (Fig. 119, page 177) is also worked by magnetic decoherence; this is effected by means of two electro magnets, one placed above and the other below the two, actuated by a special current, which is closed by the relay actuated by the coherer.

Some inventors utilise for decoherence the vibrations of telephonic diaphragms.

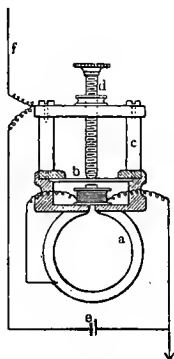

Fig. 124.

Mareschal, Michel, and Dervin have patented many appliances based on this principle. Two of these are shewn at Figs. 124 and 125. The first is a single contact coherer consisting of a screw *d* and a telephonic sheet *b* underlying it. When by effect of the electric waves the contact becomes conductive, the current of the battery *e* goes through the coil of the electro magnet, the telephonic sheet or tongue is attracted, thus determining decohesion.

The apparatus shewn at 125 has a coherer constructed like that of Orling's (page 177) of a number of little metallic balls contained in an insulating tube, closed at the two ends by two telephonic diaphragms that touch the extreme balls of the series. The current that traverses the coherer when it becomes conductive passes also through the electro magnet of the telephone; this shakes up the telephonic diaphragms and determines decohesion.

Coherers with Spontaneous Decoherers.

The mere fact of the great variety of apparatus invented in order to set up decohesion in the decoherers is a sufficient proof that they leave much to be desired, and it would therefore be interesting, even from the point of view of simplicity only, to be able to do without such delicate accessories.

The ideal solution would be furnished by coherers spontaneously decoherable, of such in fact as should become conductors at the arrival of the electric wave, and that should spontaneously re-acquire their primitive resistance at the instant the wave ceases to arrive.

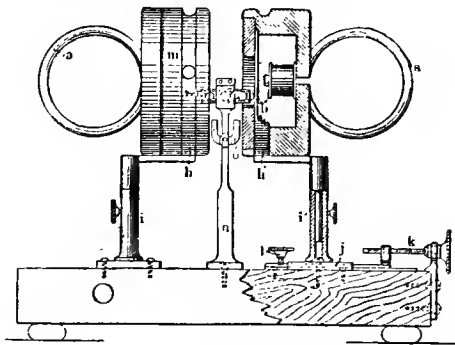

Fig. 125.

This would reduce the receiving apparatus to the greatest simplicity, as it would suffice to introduce a telephone in the circuit with the coherer, in order to receive the messages acoustically.

Many coherers have been discovered which possess the said properties, but although they present sufficient sensitiveness it does not appear that for regularity of action they can be substituted for ordinary coherers in continuous service.

The body that seemed up to the present time indispensable to the construction of self-decohering coherers is carbon; it acts either alone or in union with different metals.

The Hughes Coherer.—This is nothing less than the ordinary microphonic contact discovered by the same author, consisting of rods or sheets of carbon in imperfect contact with one another inserted in a circuit, in which is placed a battery and telephone.

We shall see (Chapter X.) that Hughes, as far back as 1879, that is to say even before the discovery of the Hertzian waves, in using such an apparatus observed phenomena, which he attributed to electric waves, and applied to the transmission of signals to a distance of about 350 yards.

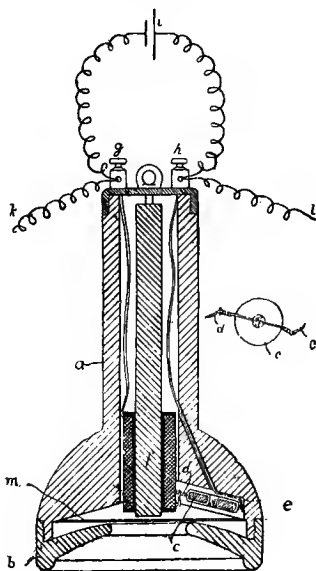

Fig. 126.

The Tommasina Telephonic Coherer.—The aforementioned experiments of Hughes were only published by him recently, and it is only now that we can form a reasonable idea of the true part that they played in microphonic contact. Independently of these, Tommasina made the discovery that

radio-conductors with carbon grains were possessed of spontaneous decohesion.

In a thin sheet of ebonite c (Fig. 126), $\frac{1}{10}$ of an inch thick, is made a hole 2 millimetres in diameter, closed by two thin laminae of mica, between which is contained powdered carbon, the same as that used in the Swiss microphones. The poles of this radio-conductor are made of two German silver wires d , e , which are plunged in the carbon at a distance of about 1 millimetre ($\frac{1}{25}$ inch) from one another.

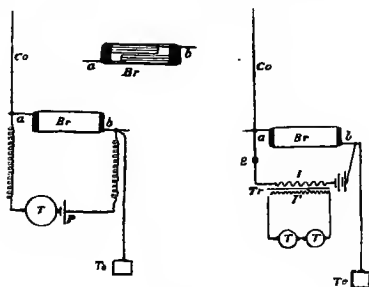

Fig. 127.

The inventor gave to the ebonite sheet the form of a rectangle, about 15 millimetres by 12, which could therefore be placed in the case of an ordinary telephone (see Fig. 126, c) by inserting it in the self-same circuit of the electro magnet in such a manner that it did not touch the vibrating diaphragm.

By this construction we produce a telephonic coherer that will act in any position, and which, on being brought near the ear, produces for every spark of the oscillator a noise similar to that of the ticking of a watch, a sound which permits the despatch to be received acoustically.

The Popoff Coherer.—The Popoff coherer constructed by Ducretet is much used in the Russian Navy. It is another automatic decoherence coherer, and is therefore adapted to telephonic reception. It consists in a tube Br (Fig. 127) containing two sheets of platinum, between which are introduced grains of carbon or of hard steel at different degrees

of oxidation; the steel grains are obtained by crushing tempered steel balls.

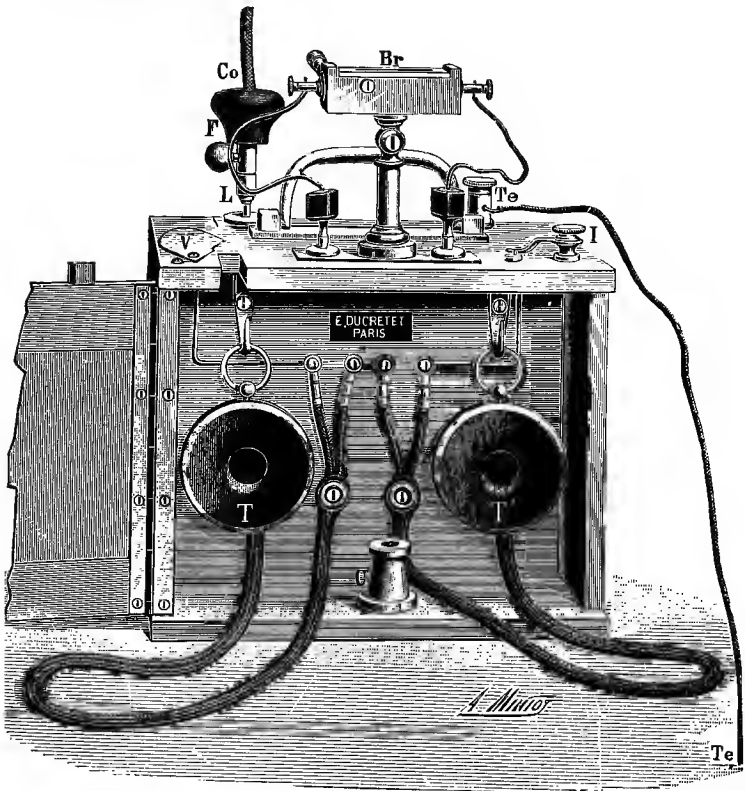

Fig., 128.

In order to increase the sensibility and the regularity of the coherer the inventor divides the tube into several sections, by means of insulating diaphragms.

The telephone *T* may be inserted directly in the circuit of the coherer, as shewn in the figure to the left, or else it

is inserted in the secondary of a transformer, whose primary is placed in the coherer circuit along with a battery, as shewn in the figure to the right.

Another form has been given to this coherer similar to that of the Popoff-Ducretet coherer at Fig. 120, in which case the electrodes $E E'$ are of carbon, and upon one of them rest the metallic wires.

By inserting such a coherer in a circuit containing a battery and one or two telephones, we have the radio-telephonic receiver of Popoff-Ducretet represented at Fig. 128.

The "Italian Navy" Coherer.—This consists of two electrodes of carbon or of iron, between which is placed a globule of mercury (Fig. 129), or else of two globules of mercury separated by a little cylinder of iron (Fig. 130).

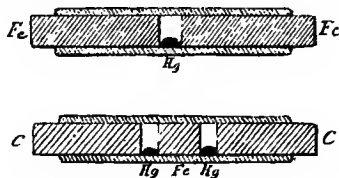

Figs. 129-130.

The self-decohering property of mercury, in conjunction with carbon, was first recognised by Tommasina; but its practical use in wireless telegraphy was first proposed by the semaphorist Castelli, and adopted by Captain Bonomo in the installation between Palmaria and Leghorn, under the name of the "Italian Navy" Coherer, and Marconi himself used it in the first wireless Trans-Atlantic transmissions. (See Chapter X.)

From experiments made at the station of Palmaria, it appears that for a well-designed tube the electro-motive force must lie between 1 and 1.5 volt. The perfect automatic decoherence depends firstly on the purity of the mercury from amalgam, on the smallness of the globules, and on the absolute cleanliness and dryness of the interior of the tube. The globules of mercury should have a diameter lying between $1\frac{1}{2}$ and 3 millimetres, and the tube an internal diameter of 3 millimetres.

This coherer is also known under the name of the Solari revealer or detector.

Lodge's Self-Decoherer.—This is actually in use in the Lodge-Muirhead system, and consists, as shewn at Fig. 131, of a rotating steel wheel, having a cutting edge *a*, that dips in a recipient that contains mercury, on which lies a thin stratum of oil. There is no actual contact between

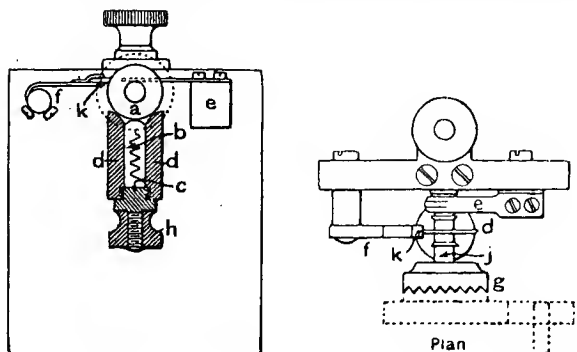

Fig. 131.

the wheel and the mercury, notwithstanding the immersion, because of the film of oil lying between the two, but a difference of pressure of less than 1 volt applied between the two is sufficient to break down the film and to close the circuit, which is immediately re-opened by the rotation of the wheel.

As the potential of a cell would be too high, this is lowered by means of a potentiometer (rheostat) so that the mercury shall be negative and the wheel positive, and the coherer shall not act except at $\frac{1}{10}$ of a volt. At the instant in which coherence is set up, a receiver of small resistance is put in action, which reproduces with great precision the signals of the sending station. To register these, the "syphon recorder" as used in the Trans-Atlantic telegraph may be employed, or the signals may be received acoustically from the telephone.

The inventor declares that this apparatus is a modification

of another mercury coherer described some years ago by Lord Rayleigh, and farther modified by Rollo Appleyard.

This coherer, notwithstanding its sensibility, is extremely easy to regulate. A micrometric screw $\frac{1}{2}$ allows the mercury to be lowered or raised at will, and in a few seconds the apparatus can be regulated.

Solomon in describing this apparatus considers it to be the most promising innovation in the Lodge-Muirhead system, and says that it is superior to every other form of revealer hitherto contrived.

Dorman Coherer.—This consists in a glass tube, with two metallic electrodes sliding into its two extremities, between which is placed a drop of mercury previously covered with a minute film of mineral oil, then with very fine powders of oxide of iron, of emery, of carbon or different metals. The inventor considered it more energetic, more stable, and less sensitive to atmospheric waves than other coherers of spontaneous decoherence.

Anti-Coherers.

These are, as we have already seen, resistances with imperfect contacts, that behave themselves in the opposite manner to coherers—that is to say, their resistance increases under the action of electric waves. We have the Branly anti-coherer, consisting of tubes with lead peroxide, of platinised glass, or of glass coated with gold leaf; that of Aaron that is obtained by cutting a strip of tinfoil previously glued on a glass, and covering the gap with metallic filings; that of Neugschwender, consisting of a silvered sheet of glass, the silver on which is rendered discontinuous by an interruption of about $\frac{1}{3}$ millimetre in length, on which is deposited a stratum of moisture by breathing thereon; that of Aschkinass, which is practically an ordinary coherer with filings, the interstices of which are moistened with water, etc.

The anti-coherers, that up to the present have found any extended application in radio-telegraphy, are Schaefer's plate and De Forest and Smithe's "responder."

Schaefer's Plate.—This is a modification of Neugschwender's anti-coherer, and consists in a sheet of glass

covered with tinfoil, along which a fine cut is made that divides the tinfoil into two parts, separated the one from the other. If the fissure lying between these two parts be dry, the current from the battery that is in connection with them is interrupted; but if it be breathed upon, the little drops of water that settle thereon, and that touch one another, constitute conducting bridges that permit the passage of the current. Under the action of electric waves the little drops gather themselves together into larger drops, but are separated to too great a distance to allow the passage of the current.

Lodge has shewn that the electric waves have a similar influence on soap bubbles, two such bubbles which touch one another under the influence of the electric waves coalesce to form one single and larger bubble.

In actual use, the Schaefer plate is not breathed upon, but close to it is kept a cloth moistened with water, or a small vessel containing water; hence as soon as the action of the waves has ceased, the fissure returns to its primitive conducting state.

It is affirmed that such an apparatus is much more sensitive than the coherer, besides being much simpler and not needing extraneous appliances to restore it to its normal condition.

Schaefer, Renz, and Lippold have since patented a Schaefer anti-coherer, having multiple laminae, as represented at Fig. 132. The metallic strips $q r s t$ are arranged adhering to insulating supports u within a box c that terminates in two binding screws $h r$ and which contains some porous moist body.

The mode in which this is arranged in the circuit is shewn at the lower part of the figure; h represents the sky rod, u the receiver, and i the relay, which is attracted in the normal state, and is free when the radiations pass.

De Forest's and Smithe's Responder.—This is made of a little tube of ebonite, or of glass (Fig. 133), in which there are two metallic electrodes 3.2 millimetres in diameter, and between which is placed an auxiliary electrode e_3 of the same diameter, the distance between the opposing surfaces being about 1.6 millimetres; the gaps between the electrodes are filled with a peculiar paste, made of rather coarse

filings mixed with an equal quantity of oxide of lead, with the addition of glycerine or of vaseline and a trace of water or alcohol. The sensitiveness of the apparatus can be regulated by the pressure of a screw applied to one of the electrodes.

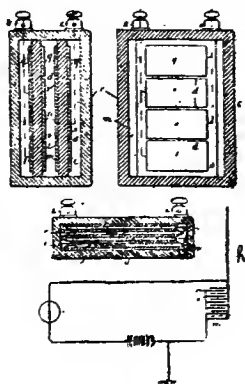

Fig. 132.

According to the inventors, if the apparatus be subjected to the passage of the current, minute metallic particles detach themselves from the anode and are carried towards the cathode across the medium interposed and joining themselves one with the other, form conducting filaments between the two electrodes.

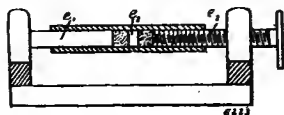

Fig. 133.

When to the local current the effect of the electric waves is superadded minute bubbles of hydrogen, derived from the decomposition of the water, introduce themselves between the cathode and the linked particles of the filaments, thus greatly augmenting their resistance. On the cessation of

the action of the waves, the oxide of lead present in the mixture acts as depolariser, absorbing the bubbles of hydrogen and re-establishing the conducting bridges as they were before.

After some days the apparatus becomes inactive, because the oxygen of the depolarising material is exhausted.

Whether this, or any other theory of the action of the apparatus be correct, there is no doubt that it works extremely well, as it takes up very rapidly and without any need of tappers the initial state which had been altered by the action of the waves as soon as these latter cease, thus permitting a very rapid transmission of the signals.

• Various Revealers or Detectors.

The Rutherford Detector.—Rutherford gave the name of magnetic detector to a form of revealer contrived by him in 1896, which is based on a principle altogether different from that of the coherer, namely, upon the fact, previously observed by Lord Rayleigh that rapidly alternating currents, such as those set up by the discharges of a Leyden jar, for example, permanently modify the magnetisation of a magnetised steel bar. Rutherford discovered that an apparatus founded on this principle has a sensibility for long waves comparable to those of the coherer. The apparatus used by him consisted of a bundle of very fine steel wires about $\frac{1}{3}$ inch in length, insulated the one from the other by sealing wax. These are strongly magnetised; around the bundles is wound a long spiral of copper wire, the ends of which are connected to a reflecting galvanometer of high sensibility.

As soon as the apparatus is struck by an electric wave a rapid demagnetisation manifests itself in the bundle, in consequence of which, as explained at page 27, a current is produced in the spiral that shews itself by a reflection in the index of the galvanometer.

By re-magnetising the bundle it is rendered fit to announce a fresh arrival of electric waves.

The inventor ascertained that the apparatus gave indications of electric waves produced at a distance of about half a mile (800 metres) even with houses intervening.

He applies this to the measurement of the resistance of electric sparks.

The Wilson Detector.—At about the same time (1897) Wilson employed as a detector of electric waves, an apparatus similar to that of Rutherford, except that the magnetisation of the bundle of wires, instead of being permanent, was caused to be cyclic, by placing near the bundle a horse-shoe magnet kept in rotation in the manner indicated at Fig. 134.

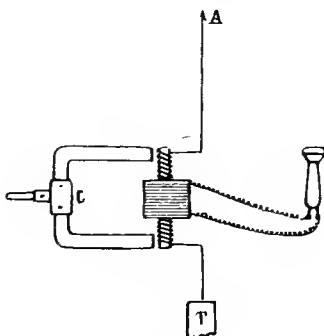

Fig. 134.

When the coil surrounding the bundles was influenced by the electric waves a sudden variation shewed itself in the magnetisation of the bundle that was rendered evident by the deflexion of a galvanometer or by the sound in a telephone placed in its stead.

The Marconi Detector.—Rutherford's apparatus, discovered before electric waves had been applied to telegraphy, was perfected by Marconi in order to render it fit for signalling electric waves which succeeded each other rapidly. It took the form represented at Fig. 134, the coils, instead of communicating with a galvanometer, are connected up to a telephone, which is quicker in its indications than the galvanometer, and around the bundle of wires was wrapped a spiral that on one side communicated to the antenna and on the other to earth, thus better concentrated on the core the action of the electric waves which strike the antenna.

The core is placed as in the Wilson detector in the field

of a horse-shoe magnet *C*, which, being rotated on its own axis by means of a little electro motor, keeps the core always in readiness to receive.

Marconi perceived that the telephone signals were most intense when the wires of the magnet were approaching the core, that is, when magnetisation increases. In order to take advantage of this favourable circumstance he gave the detector the form shewn at Fig. 135.

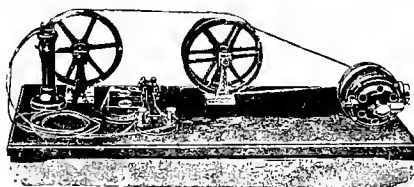

Fig. 135.

For the fixed bundle of wires, he substituted a cord made of iron wires, which is wound so as to form a continuous strand between two pulleys set in rotation by a little electro-motor represented to the right of the figure. This endless cord, at the lower portion of its travel passes into the bobbin on which are two windings, one in communication with antenna and earth, and the other in communication with the telephone. As soon as it issues from the bobbin, it passes over to the poles of a powerful horse-shoe magnet. By this arrangement the portions of the strand that go through the bobbin are in the stage of increasing magnetisation due to their approach to the fixed poles of the magnet, thus realising the aforesaid condition, which is favourable to the proper action of the instrument.

Marconi explains the working of his apparatus on the basis of a fact discovered by Geroza and Finzi that iron traversed by rapidly alternating current electricity (and therefore also by electrical oscillations) obeys better the action of magnetic fields than iron in a state of repose, which presents the phenomena called hysteresis, and which therefore assumes sluggishly and imperfectly the magnetism that it could take up in view of the intensity of the field that

magnetises it. While the magnet is turning, the bundle of wires in the absence of waves finds itself, by hysteresis, at a different degree of magnetisation from that which it ought to have at that moment in view of the position of the magnet; but, on the impact of the waves, its magnetisation instantly assumes its full value, and this rapid variation of magnetic intensity in the bundle sets up the sound in the telephone.

Tissot's Detector is represented at Fig. 136; its form recalls that of the Gramme ring. A ring of steel wire carrying two windings, one over the other, is arranged so as

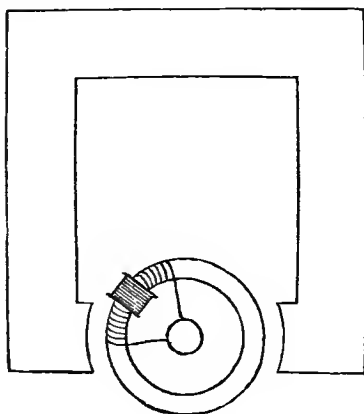

Fig. 136.

to be movable between the poles of a fixed electro magnet. The primary formed of a single layer of fine wire, has its extremities connected to two rings, insulated the one from the other, fixed on the axis of rotation, which, by means of two brushes, are connected the one to earth and the other to the sky rod.

The secondary is a bobbin joined up in a similar manner to a telephone. By arranging on different parts of the ring two or more such devices, it is easy to insure that at any moment some one of the bobbins will find itself with its core in the increasing phase of magnetism, which is the most useful for reception.

Tissot also made use of a detector on the principle of

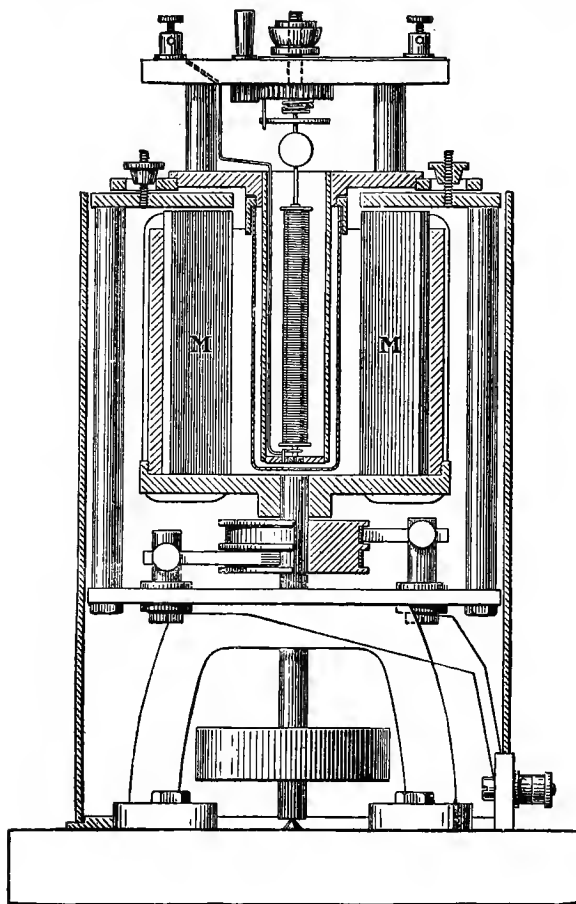

Fig. 137.

that of Fig. 134, but which had in place of the horse-shoe magnet, either a C-shaped magnet or else an electro-

magnet. In both these pieces of apparatus the most suitable velocity of rotation appears to be from 1 to 5 turns per second.

Tissot states that the period of the waves does not directly influence the working of the apparatus; on the contrary, with an equal amount of energy, it would appear that waves that are very much damped, give the greatest effect, from which the effect would appear comparable to that of a blow given by the first oscillations, as happens in the primitive apparatus of Rutherford, and the effect registered by the detector was found to be proportional to the maximum intensity of the current induced in the sky rod.

The Ewing-Walter Detector.—This apparatus (Fig. 137) recently presented by Ewing and Walter to the Royal Society, consists in a coil of steel wire (silk covered) placed between the wedge-shaped poles of an electro magnet, traversed by an alternate current, and supported on a vertical pivot. In consequence of hysteresis, the coil tends to rotate, but it is restrained by a counter spring, and only deviates to a certain angle from the position of rest.

When the coil is struck by electric waves, the hysteresis in this special case increases notably, and with it the deviation, and this increase serves not only as a revealer of the waves, but also as a measure of their intensity, which may be very useful in seeking the best conditions for tuning, and in other problems in practical radio-telegraphy.

The Arno Detector.—This consists, as shewn in Fig. 138, of two discs D, D of iron or nickel, attached to the extremity of a rod supported by bifilar suspension. The upper disc is under the action of the electro magnet $A B C$, traversed by alternating currents, differing by one-third of a period, which, combining their actions in a mode similar to that indicated at page 136 for two electrical oscillations differing by a quarter of a period, produce a rotary magnetic field (Ferraris' field), which tends to make the disc move. The lower disc is under the influence of the Ferraris' field, equal but opposite, produced by the electro magnets A', B', C' , so that the system is in equilibrium. The upper disc, however, is surrounded by an encircling coil, one end of which goes to earth, and the other to the antenna; when this coil is traversed by the electric waves proceeding from

the antenna, these by modifying the hysteresis of the disc, upset the equilibrium between the action of the two fields and produce a deviation in the movable portion of the system, which serves as a revealer of the waves, so that the apparatus may be used as a radio-telegraphic receiver.

Detectors or Magnetic Revealers are perhaps more sensitive than coherers, and are certainly superior to them in regularity of working; they are, however, subject to the disadvantage of not lending themselves to the automatic registration of the signals, which must be gathered by the ear applied to the telephone.

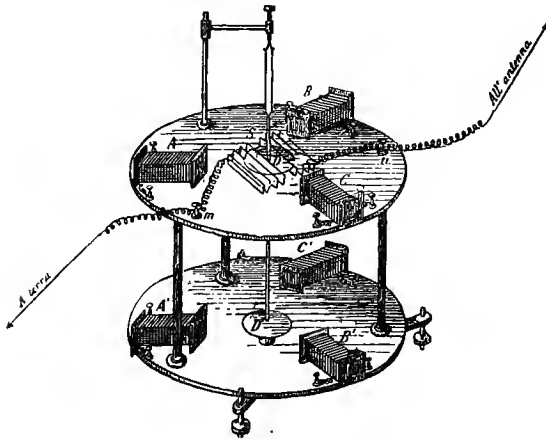

Fig. 138.

Fessenden's Thermic Revealer.—This revealer depends upon the property which metals have of presenting a higher electric resistance as their temperature increases. It consists essentially (see Fig. 139) of silver wire bent into the shape of a V (14), having a diameter of $\frac{5}{100}$ of a millimetre, with a nucleus of platinum wire of $\frac{1.5}{1000}$ of a millimetre in diameter. The lower extremity of this must be immersed in nitric acid, which by dissolving the silver uncovers for a short length the platinum. The V-wire is contained in an outer covering of silver, and this in a second glass recipient

from which the air has been extracted, and which is traversed by the two leading wires (16) soldered to the extremities of the silver wire. When the wire 14 is traversed by electric waves, it heats up rapidly, to cool down as rapidly at their cessation. Now, if in the same circuit be placed a battery and a telephone, the variations in the distance that accompany these variations of temperature produce in the telephone sounds which are more or less prolonged according to the duration of the emission of the waves, and therefore adapted to the transmission of signals by the Morse code.

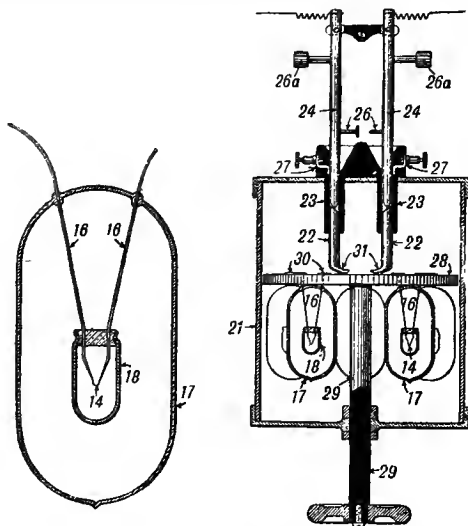

Fig. 139.

Several tubes constructed as above described, but of differing sensibilities, are mounted upon an ebonite table (28), movable on its axis by means of the button (29), that permits the large contacts (22) being brought into connection with one or other of the tubes containing the reflectors.

It would appear that the superiority of this detector resides firstly in the greater rapidity of transmission, owing

to the quickness with which the wire becomes heated and cooled.

The inventor affirms that his system permits the transmission of 65 words per minute, while with the ordinary coherers more than 15 words per minute are not transmissible.

In the second place, there is a greater facility in obtaining syntony. In fact, by this method all the energy which is carried by the oscillations is accumulated on the receiver under the form of heat, which admits of the employment of prolonged low tension waves, instead of waves of high tension, which are needed to excite the coherers that are principally sensitive to the higher values of energy. For that reason shorter antennae suffice, and in fact it has been stated that with the Fessenden system communication has been effected to a distance of 100 miles, with $\frac{1}{4}$ inch spark coils, and with simple sky rods of 12 metres in height.

Recently Fessenden has substituted for the platinum wire of the thermic revealer a liquid. The new revealer he calls a "baretter," consisting of a little recipient containing the liquid, in which is immersed a diaphragm having a minute hole, before which is placed a very fine point connected with the antenna. Under the action of the electric waves that strike the antenna the thin stratum of liquid contained in the hole of the diaphragm becomes heated, and acts as the platinum wire in the afore-described receiver in the production of signals.

This new receiver has the advantage of not being liable to be burnt up as in the former case, and therefore does not require to be protected by a conducting sheath. Moreover, as liquids diminish in resistance with their increase in temperature, while solids increase, the current that remains available at the act of the wave striking the liquid receiver is more intense when the waves are not passing, and therefore can be better utilised to cause the receiver to act.

The variations in resistance in the solid thermic receiver are, according to Fessenden, from $\frac{1}{4}$ per cent. of the initial resistance, while, under similar conditions, with the liquid receiver they are 12 per cent., that is to say, 50 times greater; this latter is therefore much more sensitive.

The L. H. Walten Revealer.—This consists in a recipient of mercury, in which is immersed a capillary glass tube that encloses platinum wire reaching to $\frac{3}{10}$ of a millimetre from the lower aperture of the tube. Above the mercury is placed a stratum of water, that acts as an insulator. The mercury and the wire are in connection with the poles of a battery, but the current does not pass, because by capillarity the mercury remains depressed and does not touch the wire; but if a Hertzian wave reaches the apparatus the capillary force changes, the mercury rises, establishes contact with the wire and a current which acts on the register passes; at the same time an electro magnet set in action by the same current raises for an instant the tube, the current is thereby interrupted, and the whole returns to the primitive conditions ready to receive again.

Schoemilch Revealer.—This bases its action on phenomena not yet thoroughly understood, which presents itself when a very fine platinum wire serves as an anode in a voltameter, with dilute acid, to which is applied electro-motive force barely superior to that necessary to produce electrolysis. In such a case a very weak current passes, which, however, increases instantaneously when the apparatus is stricken by the electric wave.

A telephone inserted in the circuit indicates by its sounds these augmentations of the intensity of the current corresponding to the arrival of the waves, and therefore serves to render the signals perceptible.

Armor's Electro-capillary Revealer or Relay.—As this apparatus is more usually known under the name of electro-capillary relay, we shall describe it among the other relays (page 205). It has been more particularly employed in wireless telegraphy through the ground (see page 19), but according to what is said, its sensibility is sufficient to admit of its being used instead of the coherer in wireless telegraphy through space.

Placher's Revealer.—As this is intended for use in telephony, we shall speak of it at Chapter XI.

On the Sensibility of Revealers.—Professor Fessenden gives the following table of the sensibility of the various revealers or detectors of Hertzian waves employed in wireless telegraphy. The numbers represent the energy required

to produce a signal, expressed in ergons (1 ergon is equal to about one hundred-millionth of a kilogrammeter) :

Marconi's Coherer, nickel, silver, mercury,	4,000
Alloy, 95 per cent. gold and 5 per cent. bismuth	1,000
Solari's Revealer (carbon, steel, mercury),	0,220
Fessenden's solid thermic revealer,	0,080
" liquid " "	0,007

Relays.

Relays are pieces of apparatus much used in ordinary telegraphy, in those cases in which the currents that arrive at the receiving station are too weak to cause the registering apparatus to work directly. Fig. 140 sufficiently explains the action of the relay.

Let M be the recorder that it is desired to set in action, and PRB the circuit traversed by the current that is *too weak* for the purpose. In this circuit, instead of M the relay R is inserted. This consists in an electro magnet before whose poles is placed a lever of soft iron a so pivoted as to be influenced by the slightest attraction on the part of the electro magnet. When the circuit BPR is traversed by the weak current, this is sufficient to cause the lever a to rise, and by such motion the circuit is closed at M between the local battery P' and the printer or registrator ; when the weak current at R ceases, the lever a falls back, thus interrupting the circuit of the local battery and causing the printer to cease work, to recommence on the arrival of a fresh current in R , and so on.

In wireless telegraphy the relay lends important service, and Fig. 140 represents precisely the relay R inserted in the circuit of the coherer B of a receiving station.

We find relays in the original apparatus of Popoff (see Fig. 41, page 84) in which the circuit of the call bell FF is normally open, and is closed at C on the arrival of the waves by the action of the electro magnet R , that is actuated by the relay.

We know (page 166) that in order to maintain the sensibility of the coherer it should be inserted in the circuit of a battery P of low electro-motive force, hence the current that

Polarized Relay, a plan of which as seen from above is shewn in Fig. 142.

Its mode of action is as follows: A permanent steel magnet magnetises the iron cores P_1 P_2 , on which are wound the bobbins, in such a manner that their polar extremities acquire the same name; besides, a thin tongue of soft iron that is placed, free to move, between these two polar extremities becomes magnetised in contrary sense to the cores. This tongue is kept in a given direction by two contact screws, D_1 D_2 ; the first being for the position

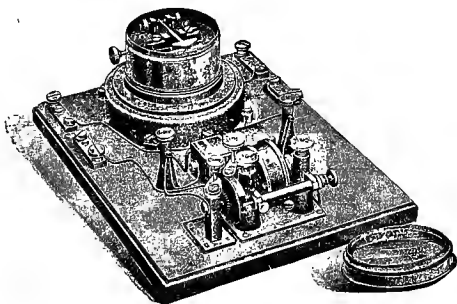

Fig. 141.

of rest, the second for the working state. When the winding of a relay is traversed by the weak current of the coherer, the magnetisation of the core P_2 is increased and that of the others decreased, and the tongue, which finds itself in a kind of unstable equilibrium between the two cores, becomes attracted by P_2 and strikes against the contact D_2 , thus closing the circuit of the local battery.

The relay adopted by Marconi is of similar construction.

Movable Coil Relay.—In France preference is given to the “movable frame” or “movable coil” relay of the Deprez pattern (Claude’s model), consisting in a frame on which is wound a conducting wire, connected to the coherer and with a battery. This is suspended between the poles of

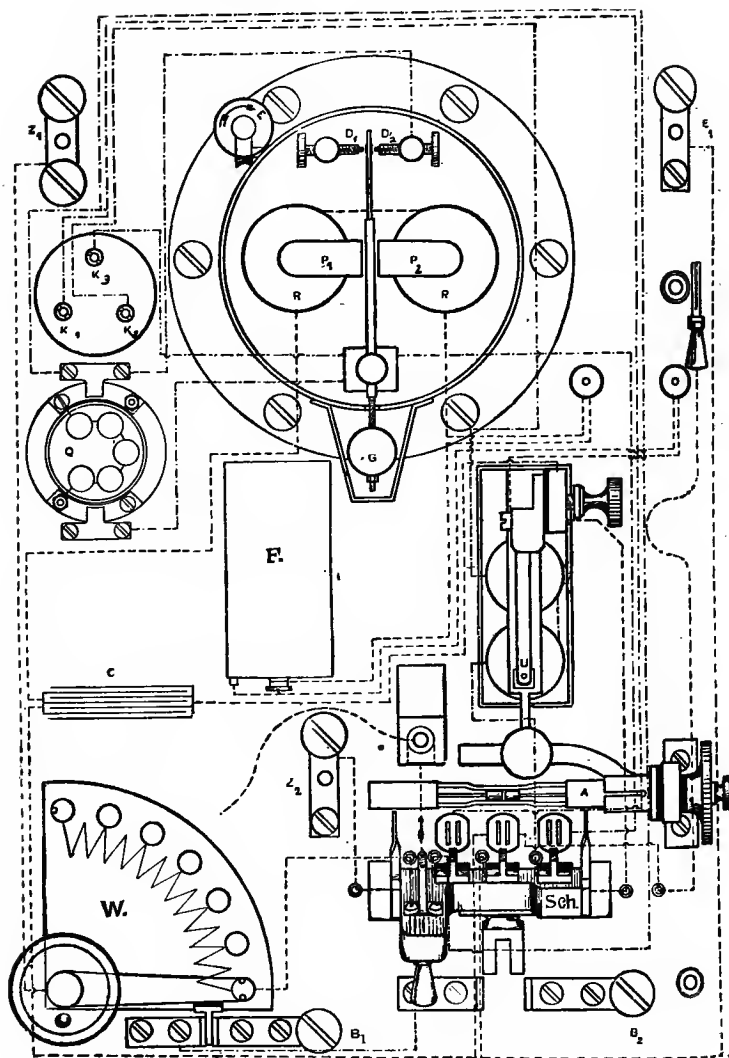

Fig. 142.

a permanent magnet. When the wire is traversed by the current, the coil or frame is subjected to angular displacement, which determines contacts by means of which the circuit of the local battery is closed. In experiments made by Tissot, it is found that such relays would work with a current of .25 of a milli-ampere.

Other Types.--In the Popoff-Ducretet system, a Siemens' polarized relay, modified by Ducretet, is employed. Other relays have been proposed, and made use of in wireless telegraphy by Czudnochowski, by Kitsee and others, but we do not think it necessary to describe these.

Generally speaking, relays for use in wireless telegraphy have a very high resistance, variable in proportion to that of the coherer. Marconi makes use of some having a resistance up to 10,000 ohms. The one above described on the Slaby system has a resistance of 2000 ohms, which is equal to that of the coherer.

Ferrié, after many trials, decided upon one of 500 ohms, constructed by Darras, that gave evidence of high sensibility and perfect regularity.

The "Armorl" Electro-capillary Relay.—This relay serves also as a wave detector, and may be used instead of the coherer. Its name is taken from the combination of the names of its two inventors, Armstrong and Orling. Its action is based on the fact that the capillary attractions at the point of contact between mercury and dilute sulphuric acid undergo modification when the said contact is traversed by electrical currents, a fact that gave rise to the construction of a very sensitive electrometer, known as the "Lippmann Electrometer."

In this "detector relay" of Armorl (Fig. 143), f is a syphon full of mercury, which tends to overflow from a recipient a into a lower recipient b , containing dilute sulphuric acid, but as the extremity h of the syphon is very minute, the mercury retained by capillary attraction does not escape. However, if between the points i communicating with the mercury and the point j communicating with the acid a difference of potential be set up, the mercury is displaced in the direction in which the current is set up, for which reason, if i is positive, minute drops of mercury escape from the syphon, and

striking the extremity of the lever *K* cause it to touch the screw *C* and thus close the circuit of a battery that works the Morse receiver.

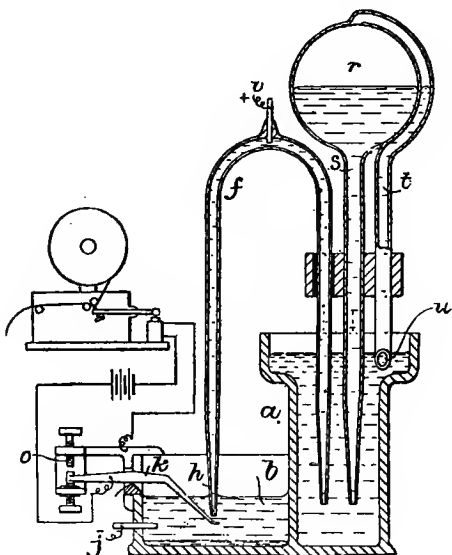

Fig. 143.

The recipient *r* constitutes the species of Mariotte's flask, and serves to maintain the level of the mercury in the vase a constant.

This receiver has shewn itself very sensitive, and might also be made use of as a radio-telegraphic repeater (see page 215).

Among the modifications of the apparatus there is one that acts like a balance (Fig 144). The ends of the line wire pass into a tube that is suspended on knife edges like the beam of a pair of scales; this is slightly turned up and contains acidulated water along with a drop of mercury. When the current passes the mercury is displaced in the direction of the current; this causes the beam to deviate, and the

pointer dependent from it touches one of the two side contacts (8 and 9), and thus closes the circuit of a local battery.

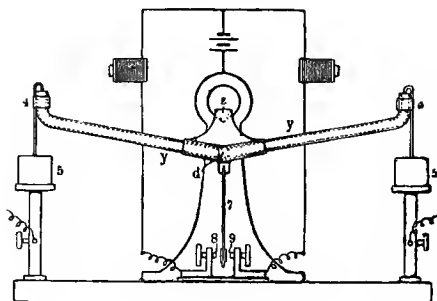

Fig. 144.

Registrators, or Printers.

The apparatus more commonly used in radio-telegraphy is the ordinary Morse receiver (Fig. 145), inserted as shewn in Fig. 140 in the local circuit that is closed by the relay. In this apparatus, as is well known, the signs of the Morse alphabet, dots and dashes (see page 99), are inscribed on a strip of paper p p , which, carried on by clockwork, runs over a stylet r or a little wheel previously inked; the stylet, etc., touches the paper when the electro magnet A of the registrator is traversed by the current, and lifts itself from it when the current ceases.

It therefore makes a dot or a dash according to whether the passage of the current had been of long or short duration.

The "Morse" employed in wireless telegraphy is almost exactly the same as that used in ordinary telegraphy, with the exception that owing to the greater slowness of transmission of signals the paper strip must unroll itself slowly, say at the rate of about $22\frac{1}{2}$ inches per minute, and therefore by some means the ordinary speed of the apparatus must be slackened, which can be done by altering the diameter of the drums which carry the paper.

It must be borne in mind that in the case of wireless telegraphy each signal consists of as many emissions of waves as there are interruptions made by the interruptor or contact breaker of the coils at the sending station during the emission of the signals, and therefore the registrators must register each signal as a series of very close dots instead of one continuous line. However, the inertia of the movable parts of the receiver is generally sufficient to cause these dots to run together into one continuous line.

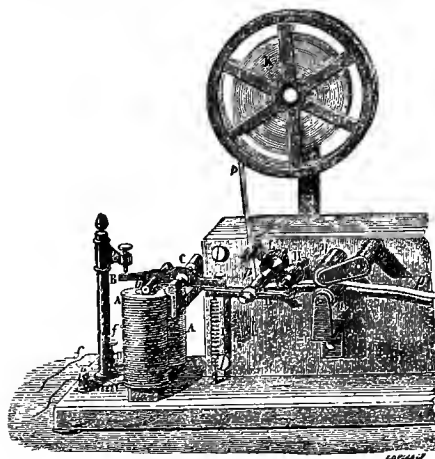

Fig. 145.

In general, the Morse apparatus is placed in parallel with the striker of the coherer, and for that reason these two resistances must be commensurate the one with the other.

In a patented arrangement of Slaby-Arco (see Fig. 146), the same lever *b* that bears the registering styllet of the "Morse" carries the little ball *i* that strikes the coherer and thus decoheres it. Zammarchi has observed that the markings of radio-telegraphic despatches with the ordinary Morse are not perfect, as the inertia of the pallet is not sufficient to reduce the series of dots into one continuous line, or to arrest its movement at the precise instant in

which the arrival of the current ceases; he found instead that the acoustic signals that can be obtained by substituting for the Morse an electric bell are free from this inconvenience. For that reason he constructed a modified Morse receiver, in which the lever that raises the paper strip against the stylet or inked wheel, instead of remaining continually raised the whole time during which the signal lasted (be it dot or dash) oscillates rapidly and lightly, like the hammer of an electric bell. In order to obtain this movement the inventor adopted the same device as is employed

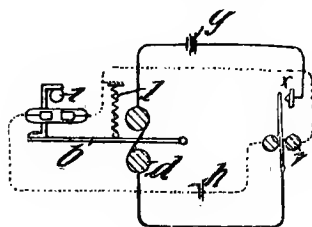

Fig. 146.

in electric bells, that is to say, to arrange so that the attraction of the lever should bring about the interruption of the circuit, for which reason the lever after being attracted immediately returns to its first position, again closing the circuit, and therefore being again attracted, and so on.

The signals given by this apparatus have their dots and dashes marked in continuous lines, that begin and cease at the same instant in which the relay closes or opens the circuit of the registering apparatus.

The Hughes Printer.—In ordinary telegraphy, the registrar more commonly used after that of Morse, is that of Hughes. It is also called the printing telegraph, because it registers the despatches, not with the conventional signs of the Morse alphabet, but with ordinary characters. This is obtained as a result of the perfect synchronism of two apparatus, one at the sending and the other at the receiving station, by means of which, at the instant that at the first station a key is touched corresponding to a given letter, the receiver prints the same letter.

Among the other advantages of this system there is that of the rapidity of transmission, since each letter is obtained by a single emission of current, whereas on the Morse system as many such are required as there are dots and dashes in the letters.

As in wireless telegraphy, transmission is rather slow, it has been sought to apply the Hughes receiver to this purpose.

The possibility of such application was shewn by K. Strecker in 1899, and in 1903 some very successful transmissions of printed telegrams were obtained in the presence of Marconi under the direction of Lt. Sullino, printed with the Hughes apparatus between the radio-telegraphic stations of Monte Mario and the Ministry of Marine in Rome. As far as we know the arrangements adopted have not been published ; but it appears that at the Monte Mario station there was a Hughes transmitter in perfect synchronism with the printing receiver placed at the Ministry of Marine. The first controlled the emission of the electric waves, which, on arriving at the second station, threw into action, by means of the coherer and its relative relay, the printing receiver. By virtue of the synchronism of the two apparatus, at each emission of the waves set up at the sending station by touching the key corresponding to a given letter, the same letter was printed at the receiving station.

Other Printing Receivers.—Recently there have been announced other propositions of new printing appliances to be applied to wireless telegraphy. One of these is due to the engineer Kamm, but upon this we have very few details. It is said that the apparatus does not differ externally from an ordinary typing machine, but that at the back it bears electro-magnetic apparatus.

The inventor claims that the apparatus is so perfectly synchronised as to render secrecy absolute, and to present impossibilities in intercepting the messages.

The inventor has demonstrated the work of his apparatus in his own laboratory in London before in the presence of the chief engineer of the Marconi Company.

Another apparatus of the same kind was invented by Guisepe Musso of Vado Ligure, and is based, like that of Hughes, on the synchronous movement of two apparatus, one

at the sending and the other at the receiving station. Such apparatus consist of minute and ingenious mechanical details, the description of which would carry us too far, hence we refer the reader who might desire to know more about them to the clear descriptions given in *L'Electricita*, in its illustrated article of the 9th August, 1903, or to the more detailed account which appeared a short time before in the *Bollettini delle Ferrovie, industrie, ecc.*

We shall only point out that the inventor has adopted ingenious arrangements by which stations with which it is unnecessary or undesirable to correspond can be cut out, and that the system is suitable for acting as a duplex, that is to say, in such a manner that the same stations can both transmit and receive simultaneously.

It is announced that in America a Company has been formed with a capital of one million dollars for the sale of the apparatus called "The Musso Duplex Typewriting Wireless Telegraph Company."

The Lodge-Muirhead Recorder.—These inventors, in the last form given to the apparatus on their system, have adopted a recording apparatus in which the registration takes place as in the Trans-Atlantic telegraphs, by means of a device called "Syphon Recorder." On this plan the receiving apparatus has the peculiarity of not having a relay in the coherer circuit; the coherer and the rheostat, of which we have spoken at page 187, are placed directly in series with the writing apparatus; the pen consists of a small glass tube in the form of a syphon, which is suspended to the movable frame of a galvanometer, which is caused to deviate by the current to which the coherer gives passage on the arrival of the waves. One extremity of the syphon dips into an ink reservoir, the other stands over the strip of paper on which the tracing is to take place.

When no signals arrive, the pen traces on the paper a thin straight line, but when signals occur the pen is deviated and the line marked presents gibbosities, which have a shorter or longer base according to whether the signal transmitted be a dot or a dash. The sensitiveness and exactitude of this apparatus is such that on examining the mark traced by the syphon, it is easy to recognise whether the sparks of the coil at the sending station be or be not regular, since any

irregularity in the said sparks produces a waviness more or less pronounced in the lines traced by the recorder.

Repeaters.

This name is given in telegraphy to such apparatus as may be placed between the sending and the receiving stations when these are too far apart to allow, with the means at disposition, of the signals being transmitted directly from one to the other. They are relays, analogous to those already described at page 201, which, instead of being used to cause the receiving apparatus to act, are employed to cause the auxiliary station in which they are placed to repeat automatically the arriving message, picking up the necessary current from a fresh source placed in the repeating station. It is evident that many such stations can be employed, repeating the one after the other at convenient distances, and thus cause the despatch to be sent to continuously increasing distances.

Although wireless telegraphy lends itself to transmission to very great distances, this result is not to be obtained except at the cost of a very high energy on the part of the sending station, and the consequent use of very powerful apparatus: for which reason, even in wireless telegraphy, it has been proposed, and attempted to use repeaters, which would allow us to obtain with moderate outputs transmissions to distances which would otherwise necessitate much more powerful apparatus.

Generally speaking, every radio-telegraphic station in which are found sending and receiving apparatus can be transformed into a repeating station. It is sufficient for this purpose to arrange in such a manner that the relay of the coherer which is connected to the receiving sky rod shall close the circuit of a local coil connected to the transmitting antenna instead of closing the recorder circuit; by this means signals similar to those emitted by the first sending station will be reproduced; the despatches therefore can arrive at a second repeating station, and thus proceed from station to station until they arrive at the final.

In the case of wireless telegraphy, the action of the repeaters presents difficulties which are not met with in

ordinary telegraphy, due to the fact that radiographic signals are transmitted in all directions around the sky rod, so that if an intermediate station repeats a signal, this latter is not only received by the following station but also by the preceding; this latter would therefore send it on a second time, and so on, so that it would give rise to an inextricable confusion of signals.

The devices proposed to obviate such an inconvenience vary according to the inventors.

The Cole-Cohen System.—In order to obviate the aforementioned trouble, Cole and Cohen proposed either to put the relay at the station in a condition of not being able to register immediately on receipt of the return signal, or to render it unable to receive signals directly after it has played its part as repeater, except that it may be ready after a few seconds for a new repetition. To meet this second case the inventors propose the employment of synchronised commutators; they have also proposed a third system: they employ two aerial wires at each station, each one of which is protected by a semi-cylindrical metallic tube, terminating in a hood.

According to the inventors, by turning these semi-cylinders in given directions, it is possible to receive only the signals coming in in one direction, and transmit them by means of the other aerial wire in the opposite direction.

Fig. 147 shews the apparatus and the circuits of an intermediate station on the Cole-Cohen system: $a a'$ communicate respectively with the receiving and repeating antenna; c is the coil, d the exciter, $e e'$ the coherers, $h h'$ the relays, w their battery, $l l'$ are two auxiliary relays, s another battery, $f f'$ the strikers, t is a condenser and v is the earth.

The outer stations are arranged as usual.

On the arrival of a signal, which, according to the inventors, induces the current in their aerial wire a only, this current passes through the contact m of the auxiliary relay l , and the contact o , thence from the coherer e and finally to earth at v .

The circuit of the relay h being closed, h comes into contact with j , and the battery excites the relay $l l'$. The two movable contacts m' and n' rest respectively on p' and r' . The contact m' breaks the connection between the coherer

e' and the wire a' , and causes a' to communicate with one of the balls of the exciter d . The lower contact n' closes by means of r' , the circuit of the battery s , through the strikers $f f'$, and the primary at c .

The signals are thus transmitted by the wire a' to the succeeding station, and are not, according to the inventors, perceived in the slightest degree by the preceding station.

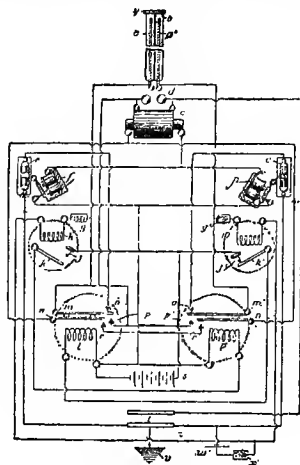

Fig. 147.

The Guarini System.—The Guarini Repeater is represented at Fig. 148. It consists of a single antenna connected at one and the same time with the receiver and transmitter, with an arrangement for interrupting the communication between the antenna and the receiver, when the former is acting as a transmitting antenna.

The apparatus that serves for reception is contained in the metallic box 14, 15. That which is employed for repetition is outside this latter. Numerous precautions were taken by Guarini in order to ensure the proper working of the apparatus, and several devices in order to impede that the waves emitted by the sky rod should, when acting as a repeater, act upon the coherer of the receiving apparatus,

otherwise the apparatus when once set into action would not stop itself. Of the experiments made at Brussels, at Antwerp, and at Malines, with the Guarini Repeater, we shall speak later on (Chapter X.).

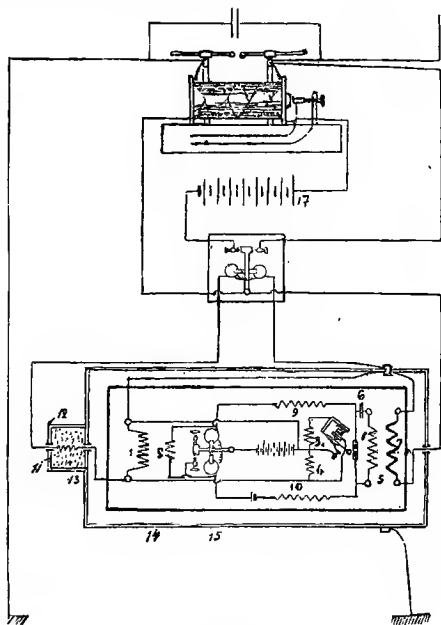

Fig. 148.

Guarini has great faith in the future of repeaters, especially for overland transmission.

Armorl System. Armstrong and Orling, the inventors of the electro-capillary relay (see Fig. 143) propose, as we have already pointed out (page 32), to use the same apparatus as repeater also.

CHAPTER VIII.

ON THE VARIOUS SYSTEMS OF RADIO-TELEGRAPHY.

Generalities.

WIRELESS telegraphy systems with electric waves are now numerous, and we may say that every nation has its own, although in truth it is not very easy to specify the degree of originality which is due to each one of them.

In *Italy* the Marconi system is exclusively worked; the Artom system is still in the experimental stage, and the Duddel-Campos system is only projected.

In *England* the Marconi system (of which the "Marconi Wireless Telegraph and Signal Company" is the proprietor) is working under the English patents No. 12039 (1896), 29306 (1897), 12325 (1898), 12326 (1898), 5547 (1899), 6982 (1899), 25186 (1899), 5387 (1900), 7777 (1900), 18865 (1900), 20576 (1900). Besides these, we have the Lodge and Muirhead system, of which the English patents are, No. 18644 (1897), 11575 (1897), 29069 (1897), etc., the Armstrong and Orling system (Armort), the English patents being 19640 (1899), 14841 (1900), the Preece system and that of the Fleeming Wireless Telegraph Company; with English patents 20576 (1902), 3481 (1902).

In *France* use is made of the Rochefort-Tissot apparatus (French patent No. 301615, June 25th, 1900), and Ducret (English patents No. 9791 of (1899), 23047 (1899)). The Marconi system has also been tried, as well as that of Pop-Pilsoudski, and it has been proposed to try the Valbreuze system.

In *Germany* the following systems have contended for the field: Slaby-Arco (German patent No. 12720 (1898), 113285 (1889), 7021 (1900), 13342 (1900), 13648 (1900)), which are worked by the Allgemeine Elektrizitäts Gesellschaft of Berlin, and that of Ferdinand Braun, bearing German patents No. 111578 (1898), 115081 (1898), 104511 (1898), 13221 (1900), worked conjointly with the firm of Siemens and Halske of Berlin. The two companies have amalgamated into the "Gesellschaft für Drahtlose Telegraphie," forming a single system called "Telefunken" (Spark Telegraphy).

In *Belgium* experiments have been made on the Guarini system with alternating currents (English patent No. 1555 (1900)), and with the repeater by the same inventor; but there are several interesting installations set up by the Marconi Company.

In *Spain* the Minister of War has applied the system perfected by the commander of military engineering, Julio Cervera Baviera (English patent No. 20084 (1899)).

In *Switzerland* use is made of the telephonic receiver on the Tommasina system (French patent No. 299855 (1900)).

In *Russia* both army and navy make use of the Popoff system (English patent No. 2777 (1900)), as made by Ducretet.

In *Austria* and in *Hungary* the Schafer system is adopted (English patents Nos. 602 (1899) and 1224 (1901)), and they are now trying the Marconi system also.

In the *Argentine Republic* Ricaldoni's system, under the English patent 15870 (1900), is employed.

In the *United States* the Fessenden system is applied (English patent No. 17706 (1902), also the De Forrest system (English patent No. 10452); the Tesla and the Cooper Hewitt systems appear to be only in the state of projects as yet.

We shall describe firstly the Marconi system, as being the one which has actually worked in practice, and which has the merit of having obtained the most signal success and the largest application; we shall seek to lay it before our readers in historical order, by indicating the particular advances which it has successively made. The other systems will be looked upon as modifications of the Marconi

system; we shall therefore treat specially of the peculiarities which they present, which differentiate them more or less from that system.

Respecting the order followed, we shall seek as far as possible to describe first those systems of the earliest date, but this order may be slightly modified in those cases in which in order to facilitate description, it will be convenient to group together several systems having the greatest degree of resemblance among themselves.

The Marconi Systems.

Marconi Apparatus of the First System.

Rudimentary Apparatus.—The appliances that served in the first studies of wireless telegraphy are represented in Figs. 149 and 150. The transmitter is indicated diagrammatically in Fig. 149. The terminals of the secondary circuit of the coil R are connected to two metallic spheres $G H$, sufficiently near to one another to permit the passage of the sparks from the coil.

The primary circuit C of the coil includes a battery E , and a tapping key. When this latter is depressed, a series of sparks flashes between the spheres G and H , and there is produced, in the manner already explained at Chapter VI., a set of electro-magnetic waves, radiating in every direction, from the gap existing between the two spheres. If the key D be kept depressed for a long time, a long flow of waves is emitted, if for a short time the emission of the waves is brief, and thus dots and dashes corresponding to the Morse alphabet can be transmitted to any receiving apparatus fit to detect the presence of Hertzian waves.

The receiving apparatus, which is likewise represented diagrammatically in our Fig. 150, consists in a coherer with filings at T , the extremities of which are placed in communication with two metallic sheets $M N$ of such a size that the vibration period of the system of which they make a part shall be equal to that of the waves set up by the transmitter.

The coherer is then inserted in the circuit f of the battery K , in series with which is also placed a telegraphic

receiver L . When the apparatus is at rest, the electrical resistance of the coherer is so great that the current that can flow through the circuit J is very small, and therefore not able to excite the receiver L ; but when the Hertzian waves strike the oscillator $M N$, the coherer T coheres, presenting at that instant very small resistance (see page 160),

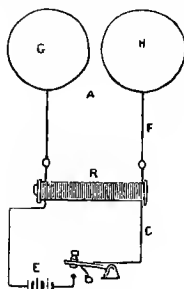

Fig. 149.

so that the current in the circuit J becomes strong, and sufficient to energise the receiver L , which marks a long or a short line according to whether the corresponding duration of the emission of the waves by the transmitting apparatus has been longer or shorter.

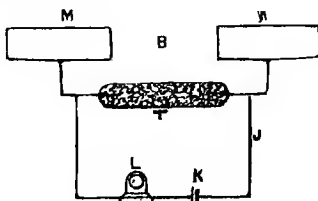

Fig. 150.

In order, however, that the receiver should cease to register the dots or dashes on the cessation of the waves, it is necessary that the current that passes through the telegraphic receiver should immediately be interrupted on the cessation of these latter.

To this end the coherer is kept in continual movement by being struck by the hammer of an ordinary electric bell, which is not shewn in the figure. This continual striking tends to keep the coherer decohered (see page 160), but it has no effect as long as the arrival of the waves lasts, since these keep it cohered; however, as soon as the advent of the electric waves ceases, the agitation decoheres the coherer, which retakes its high initial resistance; the current in the circuit J ceases, and the receiver interrupts the line that it was marking, to begin it again on the arrival of a new series of waves, thus recording with Morse signals the message sent by the sending station.

This is the apparatus reduced to its simplest form, and which could transmit to a distance of a few score metres; it serves, however, to give an idea of the fundamental principle of the system. But in practice, when it is desired to communicate to considerable distances and to ensure regular action, it is necessary to introduce other appliances that serve to increase the carrying power of the apparatus and to remove the inconveniences which the rudimentary apparatus presents.

Apparatus with Reflectors.—Fig. 151 represents one of the first transmitters used by Marconi for experiments in the open air. Two pairs of balls, either of brass or of copper, $k k$, $e e$, are supported on ebonite arms $d' d'$; the distance that separates the arms d' can be regulated by suitable screws; around the balls $e e$ is wrapped a piece of parchment paper, of such a shape as to form a kind of recipient which is filled with vaseline, thus constituting an oscillator similar to Righi's (see Fig. 65), in which the insulating liquid lying between the two balls increases the radiating power and permits of obtaining more uniform effects.

The distance between the balls $k e$ depends on the electro motive force adopted in working the instrument. The effect increases with the distance between k and e , up to the point that the discharge can pass freely. With a coil that gives sparks 18" in length, the distance between k and e should be 25 millimetres (1 inch) and the distance between e and e about $\frac{1}{2\frac{1}{5}}$ inch. The sizes of the balls in this apparatus have an important influence on the distance to which

the signals can be transmitted; under similar circumstances, the larger the balls the greater the distance of transmission.

Behind the oscillator there is a cylindrical mirror f of parabolic section made of thin metal sheet, in the focal line of which the gap between the two balls $e e$ should be placed; this mirror may be used to direct a bundle of rays in any determined direction.

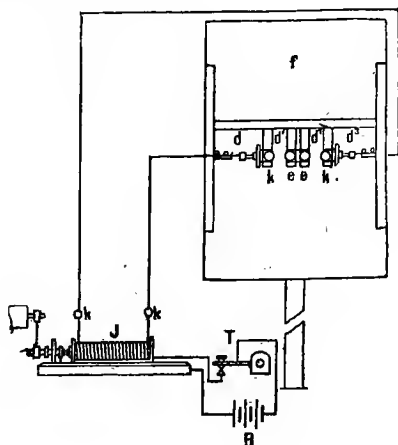

Fig. 151.

When the reflector is not made use of, the waves are transmitted in every direction. The ends of the secondary circuit of the induction coil J are connected to the two outer spheres $k k$. It is necessary that the coil should be furnished with a good automatic break. This may be either of mercury or any other usual form; in the figure we represent that employed by Marconi, in which a little motor causes the platinum cylinder which serves as contact to rotate.

Instead of the balls $k k, e e$ mounted as aforesaid, Marconi also made use of the oscillator described at page 119, Fig. 65, which facilitates getting the spark between $e e$

in focus. The difference between the sending station and the receiving is rather more marked in practice than in the diagram, as represented in Fig. 150. When it is a question of receiving from considerable distances, it is necessary that the instruments should possess the maximum sensibility, as they are affected by a very small fraction only of the energy emitted by the transmitter.

Besides this, it is necessary to prevent the instruments being affected by electrical waves accidentally produced at the receiving station itself, which, acting on the coherer, would confuse the actual message received; therefore means must be taken to avoid the production of sparks by extra current in the Morse apparatus, in the decoherer, etc.

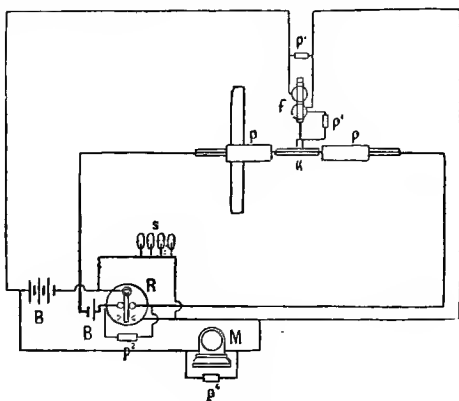

Fig. 152.

Fig. 152 represents in its entirety, the receiver used by Marconi, along with the transmitter shown at Fig. 151. The coherer represented at *K* is inserted in the circuit of the battery *B*, which consists in a single element, because, as we know, in order to maintain the coherer at its highest sensibility, it is necessary that it should be traversed only by extremely weak currents (1 milliamper) even when it is cohering. Such currents are, as a rule, insufficient to put the recording apparatus *M* in action. This difficulty is overcome by using the relay *R* (see page 202). The weak

current which is developed in the coherer circuit when this coheres is sufficient to move the very light armature of the relay, thus closing the circuit of a more powerful battery B' , in which is inserted the recorder N .

On the same circuit is a shunt, which causes the striker E to work. This is similar to the hammer of an ordinary electric bell, but rather shorter, and which has for its scope the striking of the coherer K , in order to annul the conductivity acquired under the action of the electric waves, thereby interrupting the current from the battery B . At the same time that the lever of the relay R falls back in its place, it interrupts the two circuits of the battery B' , so that both the recorder and the striker come to rest, remaining thus until a new series of waves arrives to put them in action again.

The bifilar shunts of high resistance p^1 , p^2 , p^3 , and p^4 , which are connected to the striker, to the relay and to the Morse apparatus, prevent the production of the extra current sparks, and the electrical oscillations that they would produce at the instant in which the current in their respective apparatus would be interrupted, and which might renew the conductivity of the coherer at the very moment when it is necessary to destroy it.

Another resistance S is inserted between the points of contact of the battery B' and the relay R . At this point it is preferable to use a liquid resistance having a counter electro-motive force of from 10 to 15 volts, which corresponds to a resistance of 20,000 ohms. This consists in glass tubes filled with acidulated water, in the extremities of which are welded platinum wires. Such a resistance must allow the passage of high potential currents, that may be produced during the interruptions in the circuit, and oppose themselves by virtue of the electro-motive force of polarisation, which is developed between the platinum electrodes to the passage of the current from the battery B .

Marconi considered it essential that the coherer circuit should be in unison with the frequency of the transmitter, in order to secure the greatest advantage from electrical resonance; to this end he makes use at K of a coherer having an adjustable period, as described at page 202. Fig. 112. By means of such an apparatus Marconi made his first

experiments in London in 1896 (see Chapter X.) at a distance of about 2 miles.

Apparatus with Radiating Laminae.—In order to attain greater distances and to overcome any obstacles between the transmitters and the receivers, Marconi afterwards made use of a transmitter of the form shewn at Fig. 153, which consisted of two sheets t_2 , which were larger in proportion as the distance became greater; similar sheets were also connected with the receiver.

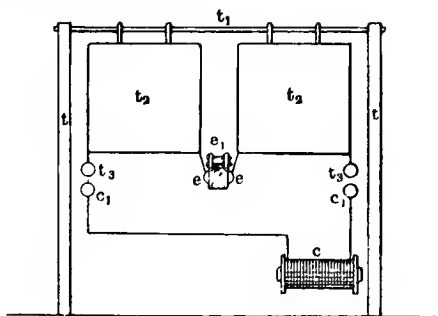

Fig. 153.

Apparatus connected to Earth.—Later on he perfected the apparatus, and augmented considerably the distance to which communication could be kept up by suppressing one of the sheets and substituting for it a connection to earth, as was indicated at Fig. 154. In this apparatus one of the transmitter balls D is earthed at E , and the other is put into communication with a sheet u , suspended at a considerable height above the ground, so that the radiator acquires an aspect similar to that of Edison's (see Fig. 15, page 34). The higher the sheet u is situated the greater will be the distance to which transmission may be effected, so that the said sheet may, with great advantage, be suspended from a captive balloon or from a kite at a considerable height from the ground. The receiver for use in connection with the transmitter No. 154 is that represented at Fig. 155, in which the details of connecting up, which are the same as those in

Fig. 152, are not shewn. One side of the coherer J is connected with the metallic plate W , which is supported by a long rod X , or by a kite or balloon at a considerable elevation; the other end of the coherer is in connection with an

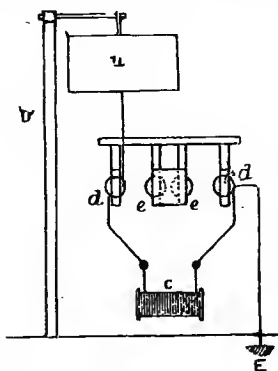

Fig. 154.

earth plate E . The bobbins $K K'$ are choking coils analogous to $A B$ (Fig. 41) and to $k' k'$ (Fig. 112), that serve to

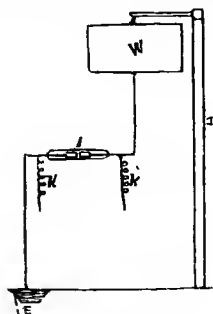

Fig. 155.

prevent the waves from passing in the battery circuit. With the above-described apparatus Marconi carried out experiments across the Bristol Channel in 1897 (see Chapter X.).

Apparatus with Antennæ.—By successively modifying the apparatus illustrated at Figs. 154 and 155, bending the metallic sheets *U* and *W* into the shape of a closed cylinder, and placing it at the extremity of a pole after the fashion of a cap, he came to the conclusion that what decided the distance to which transmission could be effected, was the height at which the said sheets or cylinders could be placed.

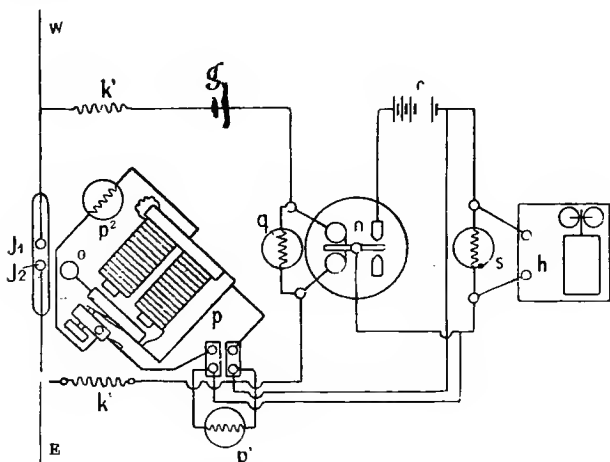

Fig. 156.

W=the antennæ; *J*₁, *J*₂=the coherer; *E*=earth; *k*, *k'*=the choking coils; *g*=the coherer battery; *o*=the decoherer; *n*=the relay; *r*=the printer battery; *h*=the printer; *p*², *p*¹, *q*, *s*=the lightning arresters.

Hence, being convinced that the essential point was not the capacity at the end of the line, but simply its length, he ended by throwing aside all attempts at increasing the capacity, and adopted simply the form of sky rods or antennæ of vertical wires, supported by poles or stakes, or by balloons or kites, when great heights were desirable.

After the adoption of antennæ and of the communication of the coherer to earth, Marconi abandoned the use of metallic sheets applied to the coherer, which were supposed to be put in tune with the period of a sending station. In fact the capacity given to the coherer by this new arrange-

ment, that is to say, by the use of the antennæ on the one hand and the earth connection on the other, rendered the capacity of the sheets negligible.

Fig. 156 represents the receiving apparatus after the introduction of the aforesaid modifications.

The explanatory text below the figure explains sufficiently, after what has been said, the action of the separate parts. We need only observe that the liquid resistance of Fig. 152 is replaced by the resistance p' made like the others, p^2 ,

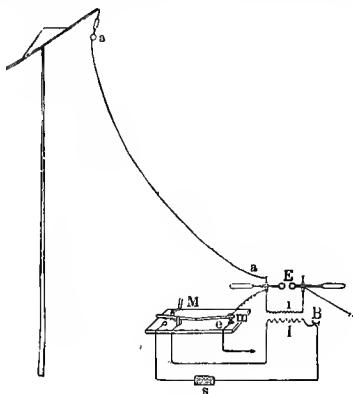

Fig. 157.

g and s , of double windings of wire. Each of these resistances represents four times the resistance of the electromagnets, or of the circuits on which it is shunted. These, besides having the effect of preventing the extra current sparks, have that of keeping up constantly a weak current, and therefore a certain degree of magnetism, in the electro magnets of the apparatus, even when the relay does not make contact.

This contrivance contributes, along with the inertia of the armature of the receiver, to cause that a succession of waves should be registered by the receiver in the form of a line of greater or of lesser length, rather than as a series of detached dots, and it serves to give to the relay and to the decoherer greater sensibility.

Double Stations.—It is not sufficient in practice that a station should act simply as a sender and the other simply as a receiver, but it is necessary that each station should be able alternatively to carry on either function; each complete station possesses therefore both transmitting and receiving instruments, and the sky rods alone are common to the two apparatus. In such a case the antenna or sky rod is connected permanently with one of the poles of the secondary of the coil (Fig. 157), but at the same time communicates at m through the sounding key with the wire e which leads to the coherer; thus, while the sending apparatus is at rest, the apparatus is ready to act as a receiver. When the key is depressed in order to send a despatch to the other stations it interrupts at M the communication between the coherer and the antenna, and this latter being connected only with the oscillator, fulfils its office as emitter of waves.

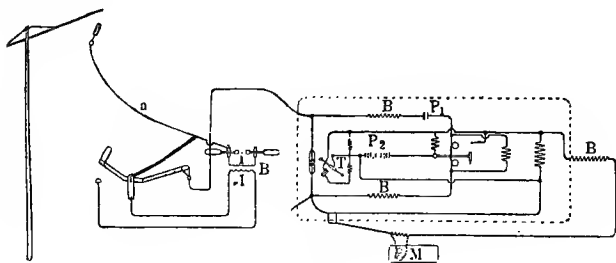

Fig. 158.

A suitable switch prevents the antenna from being placed in communication with the coherer as long as the work of transmission is going on. All this is clearly seen at Fig. 158, which represents a compound receiving and transmitting station, reduced, however, to its simplest form. The key is more clearly represented at Fig. 49, page 101.

With the exception of the sending key and of the Morse receiver, all the other pieces of apparatus are enclosed in metallic boxes communicating to earth. The contact of the Morse key is also surrounded by a metallic casing placed in communication with earth.

Receivers in which the Antennæ are Insulated from the Coherer.—As far back as 1898, Marconi introduced an important modification into the receiving apparatus, a modification which was not introduced into the sending portion until later on. This consists in cutting out of permanent communication the antenna from the coherer, and causing one to act on the circuit of the other by induction only. He had recognised that the action of the electric waves on the coherer depends more on the electro-motive force of the vibrations than upon the number which strike the coherer in a given time. He therefore sought to increase the electro-motive force of the waves at the expense of the quantity, and obtained this result by using a transformer, as shewn at Fig. 159.

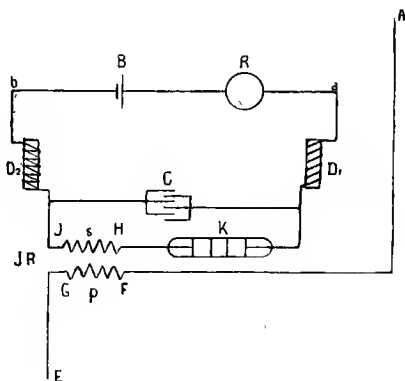

Fig. 159.

The coherer is completely insulated, both from the antenna *A* and from the earth *E*. The antenna is at *G* in communication with earth, and between the points *A E* the communication line is inserted with the primary *p* of the transformer. The coherer *K* is on the one hand connected to the secondary *J s H* of the transformer, and on the other hand with the circuit of the relay *R*. The other extremity *J* of the secondary goes to the battery *B*, which is also in communication with the relay, so that the coherer circuit remains closed.

$D_1 D_2$ are the usual choking coils that deaden the oscillation set up in s before they can act on the relay. Between two points of the wires which lead from the coherer to the resistance D on the one hand, and on the other to the resistance D_2 to the secondary, is inserted in shunt the condenser C , the purpose of which is to neutralise the differences of alternate potential, which are set up in the secondary s of the transformer, when the primary p is traversed by electrical oscillations which reach the antennae. Fig. 160 represents a similar arrangement, which only differs from

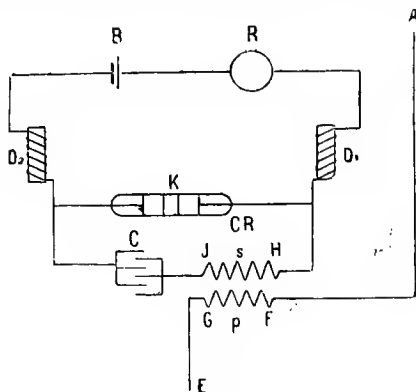

Fig. 160.

the preceding in having the coherer K in the shunt circuit, and the condenser C in the main circuit. It appears, however, that this second arrangement gives results which are inferior to the first.

Another advantage that, according to Marconi, accrues from the separation of the antennae from the coherer is that of the elimination of any danger arising from atmospheric perturbations, because the antenna being permanently in good communication with the ground, acts as a lightning conductor. In this mode of transmission the manner in which the transformer is constructed is of great importance. Induction coils of the usual pattern, with the primary consisting of a few turns of coarse wire and the secondary of many

turns of fine wire, appear to have an injurious effect. For this reason he has devoted much time and study to the details in construction of transformers to be employed in such circumstances; and adopted one of the forms, which we have described under the name of "jigger" (see page 141 *et seq.*).

In the jiggers represented from Figs. 84 to 91, the ends *E* and *A* of the primary correspond respectively to the points *G* and *F* of the figures 159 and 160; while the ends *C* and *J* of the secondary correspond to the points *J* and *H* of the same figures.

Syntonic Apparatus having Concentric Cylinders.—We have already seen in the theoretical portion (see page 87) the great advantages which wireless telegraphy gathers from having the receiving apparatus in tune or syntonised with the sending. We have seen how, by this means, not only does the distance from which the radiogram can be sent increase, but also it leads us to hope (without which the range of utility for such messages would be very limited) that multi-communication and secrecy in the despatches is also possible.

Marconi became cognisant from his very earliest experiments of the utility of syntony; in fact we have seen that the coherer (Fig. 112, page 170) which he employed as early as 1897 had organs which served to regulate its period. But with the increase of the capacity of the sending apparatus by the introduction of sky rods and connection to earth, the trifling variations in capacity that could be effected by means of the regulator on the coherer were so insignificant in action, that the regulator was abandoned.

One of the first steps made by Marconi in the direction of syntonisation was the adoption of two or three transmitters in the same station of the form of those indicated at Fig. 157, but with antennae of very different lengths, and adopting in the transformer of the receiver, for example in that of Fig. 159, a secondary wire of variable length, in order to be able to put it in tune with the length of the transmitted wave. He noticed that the best results were obtained when the length of the secondary wire *HJ* of the receiving transformer was equal to that of the vertical wire at the transmitting station.

Of the results obtained by this method we will speak in their place (see Chapter X.); these, however, although somewhat satisfactory, did not appear to Marconi a complete solution of the problem, inasmuch as he found it impossible to obtain two distinct despatches at one receiving station, if the two sending stations were at equal distances from it, whatever might be the different lengths given to the two antennae. We know that theory suggests

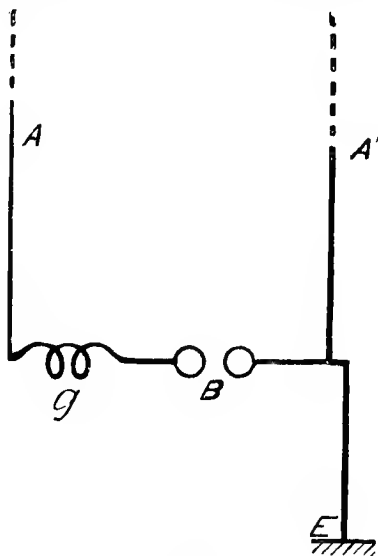

Fig. 161.

as an efficacious means of obtaining syntony that the period of the waves emanating from the sending station should be very definite, and that the damping of the oscillations should be diminished as much as possible. Marconi fulfils this requirement by increasing the capacity of the oscillator, without increasing at the same time or in the same proportion its radiating part, that is to say the initial intensity of the emitting wave following on each discharge. To this end he began by adapting (see Fig 161) a vertical wire A'

communicating with the neighbouring soil near the usual antenna A ; thus the system of two wires became a condenser, with a capacity sensibly greater than that of a single antenna, and this without increasing the superficies of the conductor A , which would have in that way acquired greater facility of radiating energy during the first operation.

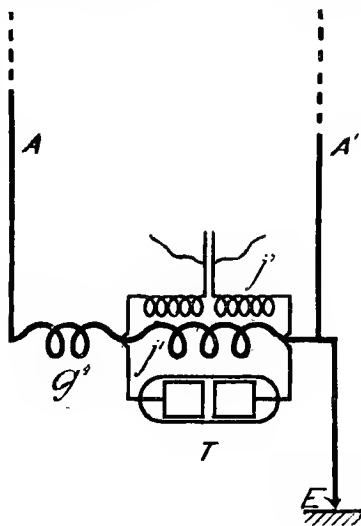

Fig. 162.

A similar arrangement was adopted in the receiving station, as our Figure 162 shews, in which the second wire A' is represented as attached to a receiver furnished with a "jigger" of the form of those described and figured at 90 and 91. Carrying out the idea of increasing the capacity of the antenna, Marconi arrived at the form given at Fig. 79, patented on the 21st March, 1900, in which the conductor A communicating to earth consists of a cylinder of zinc, surrounded by a second zinc cylinder that constitutes the radiating conductor. This communicates by means of the inductance g with the spark gap, the balls of which are connected to the secondary of the induction

coil c . It is a condition necessary to success with this method that the inductance of the wire that joins A' to earth shall be less than that which connects A to the spark gap, hence the necessity of the introduction of the inductance g .

According to Marconi this fact depends on the necessity that exists, that there should be a difference of phase between the oscillations of the two cylindrical conductors, in order that radiation may take place, instead of neutralisation. However this may be, the fact is that the results obtained were very remarkable. By means of the use of the inductance g , says Marconi, it has been found possible to cause the oscillation period of the receiver to agree with that of any one among several sending stations, thus receiving from that one alone the signals.

With zinc cylinders of only seven metres in height and $1\frac{1}{2}$ in diameter (8 yards by 3 yards and a third) signals could be obtained about 30 miles off, and these signals were not affected by those from any other station in their neighbourhood. The greater capacity of the receiver answered only to well defined frequencies, and therefore did not answer to the excitation of untuned transmitters, nor that set up by atmospheric discharges. The receiver is not represented in the figure, but it consists in cylinders similar to those used in the transmitter represented at Fig. 29; it is sufficient in this figure to substitute in place of the spark gap and its relative induction coils the coherer T and the relative jigger shewn at Fig. 162 to have this form of receiver.

“Marconi” Apparatus of the Second System.—In the apparatus hitherto described, the exciter or spark gap was placed in direct communication with the radiating antenna on the one side and with earth on the other. A very important improvement was realised by Marconi when he adopted the principle of separating the oscillator from the antenna, and of causing the one to act on the other by induction; by this means the oscillator became, so to say, closed upon itself, furnishing vibrations but slightly damped, and whose periodicity was easily regulated in order to obtain syntony.

These radical changes give to the Marconi apparatus a

distinct character, for which reason the new system is designated "the second system."

One of the inconveniences of this first system was the too rapid damping of the oscillation consequent upon the great irradiation from the antennae.

Lodge acquainted Marconi with a very persistent form of transmitter shewn at Fig. 163, which differs from the ordinary transmitters in the insertion of the condenser *e*, and he shews that by placing it near to another similar circuit it is easy to produce the effects of the experiment on the tuned Leyden jars (see page 88).

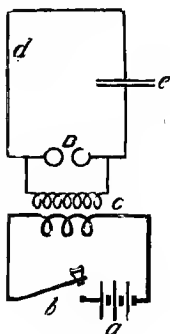

Fig. 163.

For the purposes of wireless telegraphy it became necessary to transform this apparatus into a good radiator; and this Marconi attained by uniting it as shewn at Fig. 164, with an antenna *A*, that is to say with a good electrical radiator, on which the circuit shewn at Fig. 163 acts by induction. To this end a portion of the almost closed circuit is wound into a spiral, thus constituting the primary of a Tesla transformer (see page 93), the secondary winding of which is in communication on the one side with earth, and on the other with the antenna. This latter connection, as has been said at page 145, is made in such a manner that the self-induction and consequently the period of the system constituted by the Tesla secondary and the aerial conductor can be varied and so tuned as to have the same

period of the almost closed circuit, consisting of the condenser e , the primary d of the Tesla and the spark gap B . If this condition be not satisfied for the reasons already given when speaking of resonance (page 87), the vibrations set up on the antenna by the successive impulses of the oscillator do not become additive, so as to strengthen the emitted waves, but may interfere with one another, thus weakening or destroying their effects.

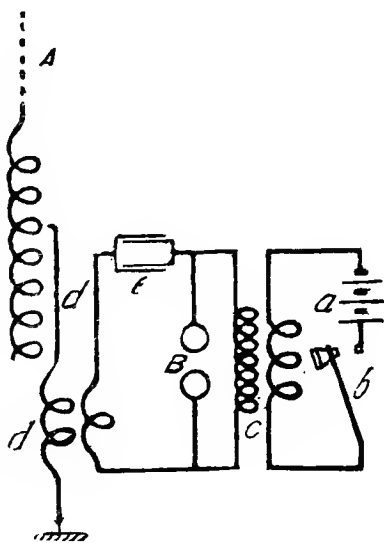

Fig. 164.

The oscillation period of the vertical conductor A may be increased by introducing more spirals in the conductor interposed between A and d , or diminished by taking some away. The condenser e of the primary is made of variable capacity; thus by varying the vibration period of the two circuits the necessary accord between the two periods may be obtained.

In this arrangement we see that the direct communication between the antenna and the oscillator of the sending

apparatus has been taken away, as has been already done for other reasons, and some time before in the non-syntonised receiving apparatus (see page 228), by means of which with new arrangements it had been possible to increase the symmetry of the two stations and to render the variations necessary in the receiving apparatus, in order to syntonise it with the sending, easy of application.

In fact, at Fig. 165, which represents the sytonic receiver to be used along with the transmitter shewn at Fig. 164, we see that the only modifications introduced into the

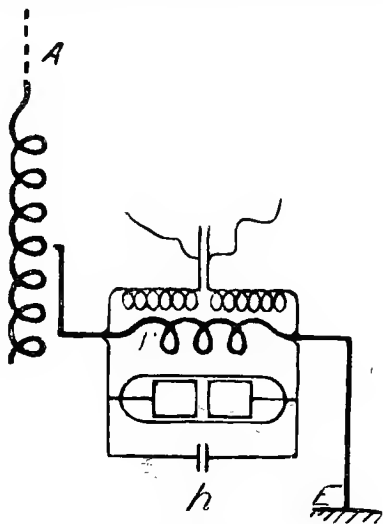

Fig. 165.

receiver (Fig. 162) is that of having rendered the number of spirals constituting the inductance connected to the antenna variable, and of having introduced in shunt with the coherer circuit the condenser h , which serves to put this circuit in tune with the period of the conductor constituted by the antenna of the receiver and the primary of the jigger.

By virtue of such arrangements the various circuits of any single system may be placed in perfect resonance

among themselves, and with other stations, thus ensuring the highest efficiency in transmission.

Theoretically, in order that such resonance may take place between the four circuits, that is to say, the two of the receiver and the two of the transmitter, it is necessary, provided the resistance be negligible (see page 71), that the product of the capacity by self-induction shall be equal in all forms. In practice it is not easy to measure capacities, and less still the inductances employed; but experimental

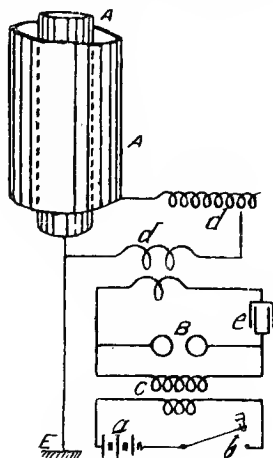

Fig. 166.

trial as to tuning may be made. Basing oneself on the rule already pointed out at page 144, according to which the periods of the antennae and of the receiving transformer are equal to the length of the antennae and equal to that of the secondary wires in the receiver, it is possible by using in the two stations antennae of length equal to that of the secondary on the transformer of the receiving station, to have three of the circuits in tune, and there only remains to regulate the capacity of the condenser *e* (Fig. 164) of the transmitter (which in this case is constructed with movable coatings) in order to obtain accord between all four of the circuits,

By adapting the arrangement (Fig. 164) cylindrical radiators, of the concentric type shewn in Fig. 169, the apparatus represented diagrammatically in our Fig. 166 is obtained, by means of which it has been found possible to correspond to a distance of about 30 miles, using cylinders only 5 feet in height and 3 feet 4 inches in diameter.

Later on Marconi sought to determine the least distance a transmitter similar to the one just described, and tuned for a certain frequency, should be placed from a receiver tuned to a different frequency, in order that this latter should not be affected; and on testing with oscillations of very divers periods he found that transmitters capable of telegraphing to about 30 miles which were using a receiver tuned to its period would not affect an untuned one at a distance of about 60 yards.

If the periods differ less the untuned receiver may even reply at some miles' distance.

Portable Stations.—The use of concentric cylindrical radiators has enabled us, as we have seen, to diminish largely the height of the antennae, and has led Marconi to construct a portable apparatus which may lend excellent service among other things to field operations. He has in fact described a complete installation that can be affixed to an automobile. On the roof of the car is arranged a cylinder of about $6\frac{1}{2}$ to 7 yards in height, which may be lowered during travelling, and which suffices to establish communication to places 30 to 35 miles off.

A strip of metallic netting placed on the ground serves for an "earth," and the car in motion may keep up the earth connection by dragging the netting behind it; communication may also be made to the boiler or engine of the automobile instead of with the earth.

For transmitting the messages a coil, giving about 10-inch spark, actuated by accumulators and consuming about 100 watts, will suffice. The accumulators are charged by means of a little dynamo that is driven by the motor of the car; transmission may be effected to considerable distances even when the cylinder is placed in a horizontal position.

Ultra-powerful Apparatus.—With the syntonised apparatus just described, Marconi was able to transmit messages to a distance of about 200 miles (March, 1901), that is

between Cape Lizard (Cornwall) and St. Katherine (Isle of Wight), using about 150 watts; to reach greater distances he proposed to make use of much greater quantities of energy. He therefore undertook the task of installing so-called ultra-powerful stations, the first of which was that of Poldhu (Cornwall), which he made use of in 1902, for the experiments with the "Charles Albert," and for the first trans-Atlantic messages, that is to say to distances of more than 1000 miles. At the ultra-powerful station at Poldhu the source of electricity is a 50 kilowatt alternator *A* (Fig. 167) driven by an engine of about 100 H.P., that gives a current of 25 amperes at a pressure of 2000 volts.

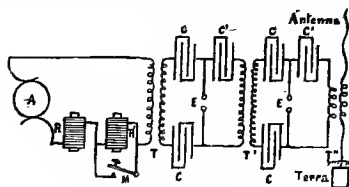

Fig. 167.

This current, after having traversed the two choking coils *R R'*, passes through the primary circuit of a commercial transformer *T*, which raises its tension to 20,000 volts. The secondary of this transformer communicates through the two guard condensers *C C*, with the spark gap *E*, which is placed in shunt on another circuit, which comprises the condenser *C'*, having a capacity of about 1 microfarad, and which has already been described at page 154, and with the primary of a first Tesla transformer *T*₁; so that in order to excite the primary of the Tesla *T*₁ we have a capacity of 1 microfarad charged at a potential distance of 20,000 volts. A circuit similar to that which unites the secondary of *T* with the primary of *T*₁ joins the secondary of *T*₁ with the primary of the second Tesla transformer *T*₂, whose secondary is at one extremity in communication with the antenna, and at the other taken to earth.

The sky rod used in these experiments is of the multiple type already described at page 131; and other Tesla transformers may be inserted between *T*₂, and the antenna or

the transformer T_2 may be suppressed, and the antenna may be made to communicate directly with the secondary of the transformer T_1 .

The two guard condensers $C C$ have been introduced, following the example given by d'Arsonval, in order to avoid the formation of a permanent arc between the balls of the spark gap. To a certain extent this aim is served, even without the use of the condenser $C C$, by the choking coil R , the core N of which is plunged into its bobbin to such a depth as to prevent the formation of a permanent arc at E without disturbing the phenomena of oscillative discharge from the condensers C' ; but the use of the two condensers $C C$ renders the suppression of the arc absolutely certain.

The coil R' , whose core is entirely withdrawn during the above-mentioned manipulation of the core of R , constitutes, along with the key N , the manipulator already described at page 101, by means of which the series of discharges (both long and short) corresponding to the sign of a Morse alphabet are emitted. Condensers $C C'$ have their parts disposed as shewn at Fig. 105, page 155.

On the Arrangement of the Apparatus.—At pages 242 and 243 we have given the arrangement of the apparatus in a station of Marconi's first system. Figs. 168 and 169 represent the disposition of the apparatus in Marconi's station of the second type, such as were adopted by Biot in his experiments between France and Corsica (see Chapter X.). In order to pass from transmission to reception, or *vice versa*, the extremity of the antenna was joined up successively to one or the other of the two stations.

Sending Station.—This is represented at Fig. 168, the circuit from the accumulators Q is in communication with the primaries of the two coils $B_1 B_2$, one of which may be cut out of circuit when a single bobbin is found sufficient. The circuit $O C_1$ comprising the spark gap O , the condenser C_1 and the primary of a d'Arsonval transformer S , must present the least possible self-induction, in order that the oscillation may assume the highest intensity. It is therefore advantageous to diminish as far as possible the length and to increase the thickness of the wires in this circuit, including that of the primary S ; in order to approximate as

far as possible the apparatus in this circuit the transformer S is placed above the condenser C_1 .

The regulation of periodicity is effected by preference by varying the capacity of C_1 only. The transformer S is usually plunged into a receiver full of petroleum or of linseed oil, to insure insulation.

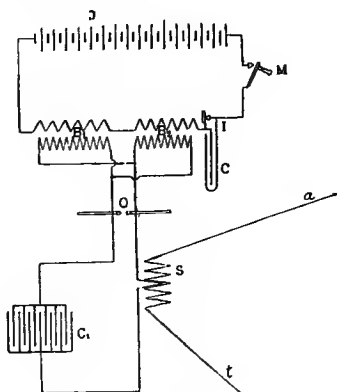

Fig. 168.

The Receiving Station.—As in the arrangement shewn at page 228, all the portions of the receiving apparatus, with the exception of the Morse receiver and the bell, are placed inside a metallic case B (Fig. 169), in communication with the earth.

Modifications have, however, been introduced into the details of the internal apparatus, more especially in the resistances and in the shunts attached to them. In order to avoid waste in the battery P , that works the Morse M and the decoherer T , through the shunt applied to the relay, this latter is built up of a non-inductive resistance E about 1000 ohms in series with a little condenser K_2 .

In like manner, in order that the whole of the current which the conductivity of the coherer allows to flow should pass through the bobbins of the relay, which has a resistance of 10,000 ohms, the shunt on these bobbins consist of a non-inductive coil C , in series with a little condenser K_1 ;

when, however, coherers of great sensibility are employed the condensers are suppressed.

Another condenser K_3 has been placed in shunt across the self-induction bobbins, which serves to arrest the operations dependent on the Morse, to shunt off to earth the

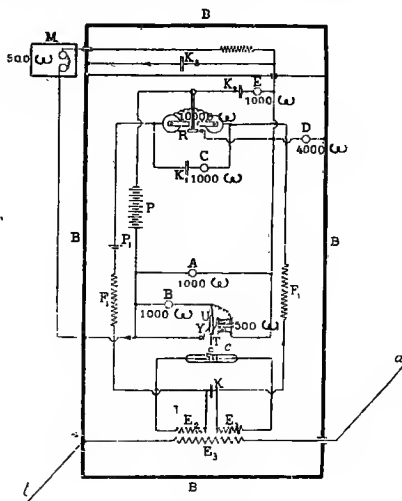

Fig. 169.

oscillations which might reach the self-induction bobbin itself. To facilitate comprehension of the above description we represent at Fig. 170 the interior of the temporary station of Biot (France), with the apparatus of the second system. To the right is seen the transmitting apparatus, to the left the receiver, in the centre a key. Starting from the right we find the coil (hardly visible on the round table), with the oil tank on the transformer, the battery of Leyden jars, and the key, which, along with the accumulators placed under the table, constitute the transmitter; then comes the box containing the apparatus figured at 169, and, lastly, the Morse receiver. The wire which crosses the room is a prolongation of the antenna, which

can be placed in communication with the sending apparatus when transmitting, or with the receiver when receiving.

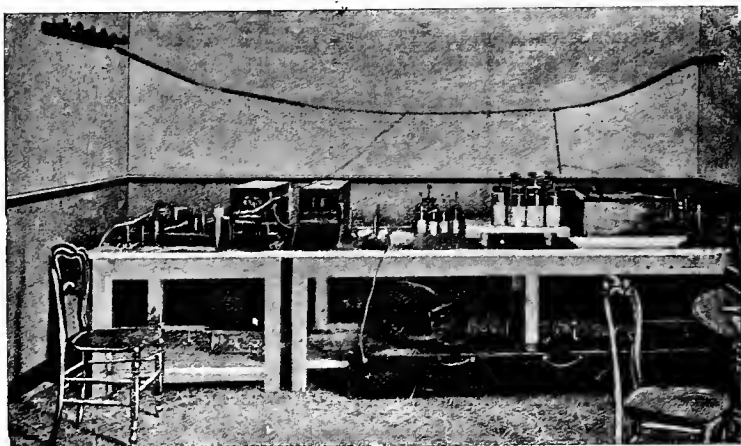

Fig. 170.

Lodge-Muirhead System.

To Lodge, to whom wireless telegraphy is indebted for the discovery (see page 161) of the extraordinary sensibility of the coherer to the electric waves, is due also much of the merit for the progress made after the first experiments of Marconi; he it was, in fact, who, after arduous study on the theory and conditions which electric waves must satisfy in order to be serviceable to wireless telegraphy to a great distance, introduced, when radio-telegraphy was in its first stages, those important innovations that pointed out the way to the principal successive improvements. Hence, although Lodge has not yet given to his system of radio-telegraphy that large industrial development that has been given to others, we hold it to be our duty to give to a description of his system the first place after those of Marconi.

Syntonic Induction Apparatus.—The first experiments undertaken by Lodge in the field of wireless telegraphy date from 1898, that is to say from the time of Marconi's first successes. He started with the idea that telegraphy by induction with alternate currents of low frequency between closed syntonised circuits would offer as compared with wireless telegraphy using electric waves several advantages, among which that of lending itself to overcome any obstacles interposed between the stations (a property which was later on recognised as being participated in by electric waves of great length), and that of allowing the effects to be increased by the use of closed circuits of great extent.

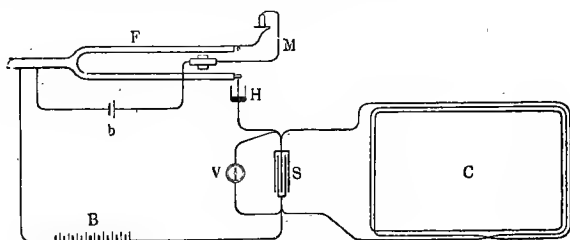

Fig. 171.

Fig. 171 represents the arrangement of the apparatus in a sending station. An electro-magnetic tuning fork *F* serves to render the current emitted by the battery and accumulators *B* intermittent, and this current passes through the rectangular coil *C*, which has large dimensions (about 160 yards by 40 yards), between the terminals of which the condenser *S* is placed in shunt. A Morse key (not shewn in the figure) serves to transmit the current for longer or shorter intervals at times corresponding to the signal of the Morse alphabet. At the receiving station is placed an apparatus identical with the above as regards the dimensions of the coil and the capacity of the condenser, brought into perfect syntony with it by the addition of supplementary self-induction coils, the only difference being that it bears in the place of the tuning fork and battery a telephone. The apparatus, as is seen, resembles the syntonised jars (see page 88); however, owing to the great capacity of

the condensers and the strong self-induction of the bobbins, the discharges in this are very slow—that is to say, a few hundred only per second, which is that rate of frequency in acoustic vibrations that are adapted to being received by the telephone.

On using in the circuit a current of from 10 to 20 amperes, audible signals are obtained up to two miles distance. Lodge calculated that with a length of about $1\frac{1}{2}$ miles of copper wire in the coil, an electro-motive force of 100 volts at 400 periods per second, with the insertion of suitable condensers, a current of 500 micro-amperes could be obtained, giving an induced current of 500 micro-amperes in the syntonised apparatus at about 80 miles distance—that is to say, a current more than sufficient to work an ordinary telephone, or better still the more sensitive telephones or micro-telephones constructed for this purpose by Lodge himself, and tuned to the same frequency as the two circuits.

Notwithstanding Lodge's calculations, he abandoned his project after the first experiment, which was a hybrid between the system of simple induction and electric waves, and turned his attention to the latter portion only, taking part in Muirhead's researches. Muirhead having from 1894 applied electric waves to telegraphy, Lodge, strengthened by a prolonged scientific preparation in the subject, intuitively grasped the conditions which were essential in order that the electric waves should be able to make themselves felt at great distances, among the first of which was the syntonisation of the sending and receiving stations; and to him is due the merit of the first attempt based on this principle, which was afterwards so largely applied by the different experimenters in perfecting or creating their systems of radio-telegraphy.

Electric-Wave Syntonic Apparatus.—One of the pieces of apparatus constructed by Lodge for syntonised transmission is that shewn at Fig. 172, which allows of the production of high-tension discharges but slightly damped and having a well defined period. The wires that start from the extremities of the secondary of the coil shewn, and which are in communication with the little balls of the spark gap, are also connected up to the inner coating of two Leyden jars,

the outer coatings of which are coupled up to the little balls h_4 h_1 , facing which are two other little balls connected to two wires that lead to two small self-induction coils, h_2 h_3 , terminating in two other small balls.

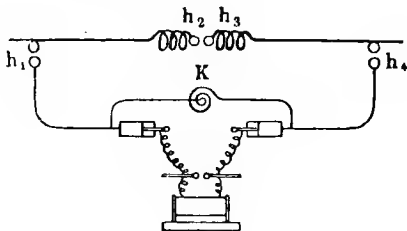

Fig. 172.

When the spark is produced at the spark gap attached to the coil the outer coatings of the jars also discharge themselves, and they produce two sparks at h_1 h_4 , and one between h_2 and h_3 . The external coatings of the jars are also united by a powerful self-induction coil K , the purpose of which is to allow the two jars to acquire their full charge. During the discharge this acts as a shunt, but does not in the slightest degree prevent the sparks from discharging at the spark gap.

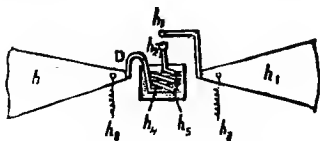

Fig. 173.

In order to intensify the radiating power of the transmitting apparatus, two aerial radiating plates (known as wings) similar to those represented at h and h_1 (Fig. 173) were added to the ends of the wire contained in the spark gap h_2 h_3 , Fig. 173 being a modified form of the Lodge transmitter.

At 174 we have an apparatus that serves equally as transmitter and as receiver: h_6 h_7 are the wires coming from a

powerful induction coil; the two coarse horizontal wires act as services of considerable capacity; h_4 is the self-induction bobbin plunged into an insulating substance, as that of Fig. 173. The little bridge piece h_9 serves to bridge over the spark gap when the apparatus is to be used as a receiver. The coherer is shewn at e , the local battery f , and the receiver or relay at g .

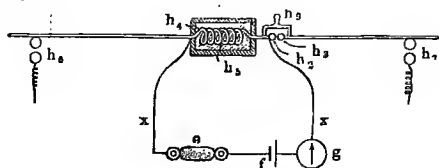

Fig. 174.

At Fig. 175 is a plan of two syntonic stations, the one transmitting and the other receiving; in these the plates or wings h h_1 are replaced by two combs h h_1 . A four-ball oscillator brings about in the transmitting apparatus the oscillatory discharge between the two central balls h_2 h_3 , which are connected to the combs by means of self-induction coils. The receiving apparatus is approximately of the same size, capacity, and self-induction as the transmitter, with a view to render the conditions of resonance as perfect as possible.

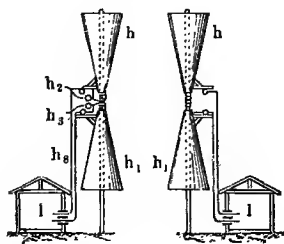

Fig. 175.

However, the vibration periods can be easily modified by acting on the self-induction only of the coils introduced. One means consists in having several spirals (Fig. 176) at

hand that can be introduced or removed from the circuit by means of the switches $A_1 B_1 C_1$ as needed; or else a single coil may be employed, more or fewer of its constituent spirals being thrown into circuit; or else the step may be modified by pushing the coils closer together or by drawing them out.

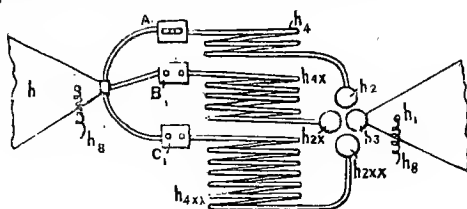

Fig. 176.

At Fig. 177 we have another arrangement of the receiving apparatus in which the coherer circuit is insulated from the aerial conductors, which act upon it by induction. The

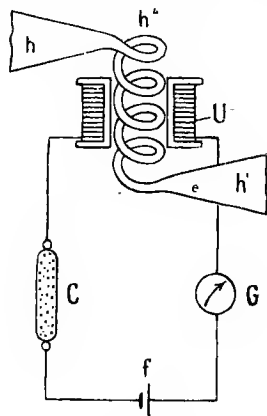

Fig. 177.

aerial conductors h h^1 transmit the electric waves to the primary h^1 of a transformer, having the bobbin U for its secondary, and this has in its circuit the usual receiving apparatus.

As is seen, this is the inductive communication between the two circuits, which was one of the most useful improvements introduced later on by Marconi, first in the receiving apparatus (Figs. 159 and 160) and then in the sending apparatus (Fig. 164) of his system.

It does not appear that this modification of Lodge's system has been applied on any large scale.

Lodge-Muirhead New Apparatus.—These inventors have more lately reached a high point of perfection in their apparatus, and the form which they have recently put in the market is that represented at Fig. 178. The pieces of apparatus which are figured at 178, starting from left and going to the right, are :

The accumulators, the syphon recorder (described at page 211), with, in the middle, the automatic coherer described at page 187; the sparker, seen above; the coil, the automatic perforated transmitter, the key, and above, the buzzer.

The figures here reproduced represent diagrammatically two types of the system adopted for the transmitter (Figs. 179 and 180) and two for the receiver (179 *bis* and 181), which depend on the principles already studied.

At *AA* we represent the type endowed with the greatest power; *c* and *r* represent respectively the coherer with its wheel and the syphon recorder, *a* and *E* are the antennae and the earth. The most noteworthy thing in these arrangements is the absolute want of direct communication to earth.

We know that, in the opinion of many, the earth only serves as a second coating of a condenser, of which the first coating is the aerial wire with its annexed capacity. Lodge and Muirhead appear to entertain this idea, since in their system the second capacity is attached to it, but is insulated from the earth. In these systems we see that the coherer, the oscillator, the capacity, the self-induction coils, etc., are indifferent in their position, as we also see, whether the transformer be used or not, that the oscillations are introduced in a closed circuit as at *B*, or in an open circuit as at *A*.

Either the one or the other of these possible arrangements may be adopted in the setting up of a station,

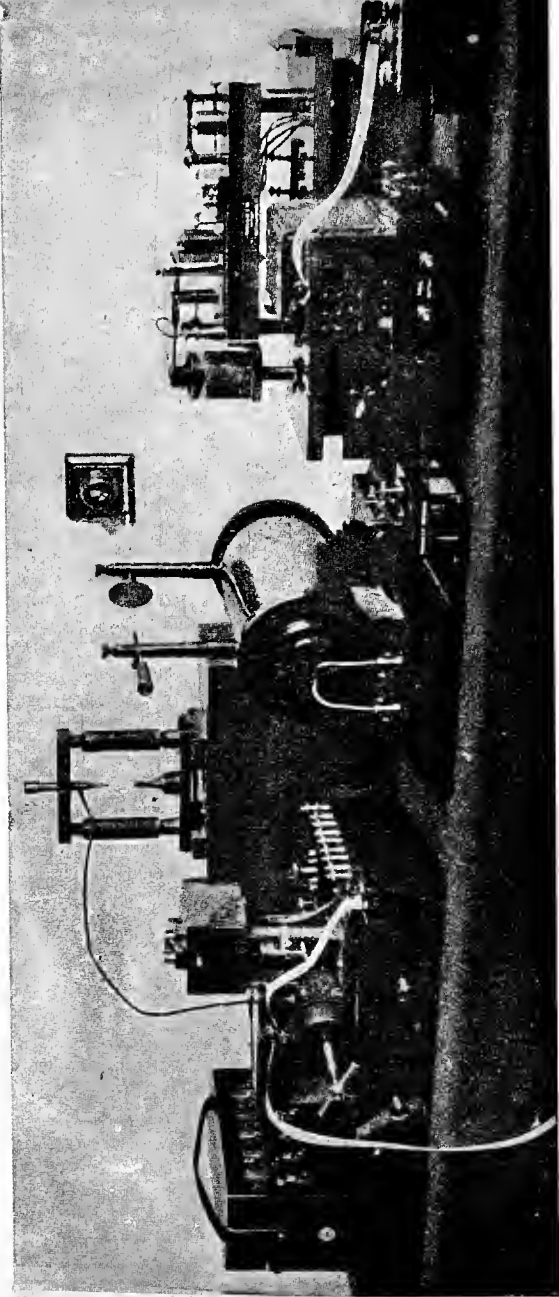

Fig. 178.

according to the purposes which it has to serve and the conditions in which it has to work, each arrangement having its special advantage for determinate purposes.

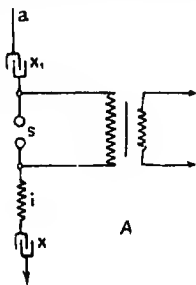

Fig. 179.

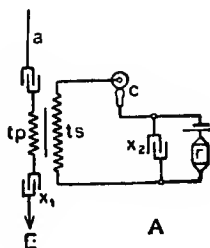

Fig. 179 bis.

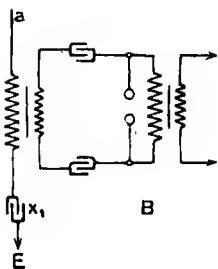

Fig. 180.

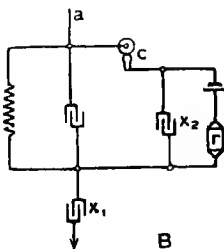

Fig. 181.

Two experimental stations with the above systems have been installed, one at Elmers End and another at Downe, about $7\frac{1}{2}$ miles apart overland; but, owing to local circumstances this distance may be reckoned as being equal to eight or nine times greater than if it were at sea. However, in setting a value on the merits upon any given system, all considerations respecting distance are of secondary importance, since Marconi has clearly shewn that, given sufficient energy, almost any distance can be covered. Certainty in communication and clearness in the messages and the power of syntonisation are of higher importance than mere distance-

reaching, and under these aspects it is said that the new Lodge-Muirhead system is among the most promising.

Apparatus for Military Use.—Lodge and Muirhead have also given to their new apparatus a form which lends itself to military use. The plan adopted for the installation of the two stations is similar to that shewn in Figs. 179 and 179 *bis*, except that in the sending station the condenser *X* is done away with, so that one of the balls of the oscillator communicates directly with the aerial line, which, as we have said (page 129), is built up in the form of an upright pyramid on a square base to a height of about 18 yards, this smaller height being adopted because Lodge is of the opinion that a rapid synchronism between the transmitting and the receiving circuits has a much greater importance than the simple height of the antennae.

The four faces of the pyramid consist of four wires bent into a triangular form, the one insulated from the other, that pass through apertures made in the upper portion of the pyramid, and which descend down the axis of this latter in order to be connected up to the apparatus.

This antenna is borne on the roof of a car, in the interior of which are arranged the different pieces of apparatus. The vehicle, with its relative instruments, weighs about 1000 lbs.; the aerial line about 36 lbs., the antenna about 400 lbs., and the copper netting that sweeps the ground in order to make a good earth, weighs about 300 lbs. The peculiar advantage of the apparatus is the quickness with which it can be installed or moved about.

To set it up takes only about 40 minutes, and in about 45 minutes it can be dismounted and packed. The apparatus has been used in the last great English military manœuvres, and it is intended for overland communication to a distance of about 20 miles.

Braun's Systems.

Transmissions through Water.

Professor Braun of Strasburg began his experiments on wireless telegraphy in 1898, making use of water as the vehicle of transmission.

The Principles of his Method.—Starting from the principle, that while a continuous current sent in a cylindrical conductor fills uniformly the whole section of the conductor, while an alternating current is not propagated therein except as a superficial layer, the depth of which is less in proportion as the oscillations are more rapid, it may be considered that by immersing in a large body of water a metallic sheet communicating with a wire traversed by alternating currents or by electrical oscillations, the current will not be sensible beyond relatively small depth.

Braun held the view that this depth would be less than 2 yards; he then thought to substitute electric waves for

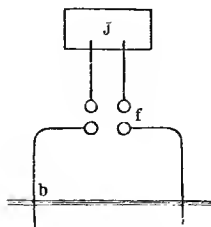

Fig. 182.

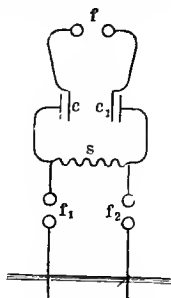

Fig 183.

continuous currents, which had been employed some time previously (see page 12) by others for a similar purpose. With electric waves, besides the advantage that the lines of the current would propagate themselves only along a stratum of water of little depth, there would be the other, that communication would only demand an uninterrupted service of water, and that islands and peninsulas would not present any obstacle to a transmission of signals.

Apparatus Requisite.—In Braun's first experiment he set up electric waves in water, by using the arrangement shewn at Fig. 182. The two poles of the secondary of a coil *J* terminate in two small balls facing two others which communicate with two conductors plunged in the water at a certain distance the one from the other. When the coil is in action sparks pass between the balls, which produce in

the wires electrical disturbances, part of which are transmitted in the air and part in the water.

Braun quickly recognised the necessity of giving to the discharge circuit a well defined and slightly damped oscillation period; for which reason, instead of making use of a single coil, he employed several circuits almost closed, which presented well defined capacities and coefficients of self-induction, of which one is represented at Fig. 183. The two small balls f constitute the Hertz oscillator connected up to the coil; $C C_1$ are the two condensers, the external coating of which communicate with one another through a self-induction coil s , at the extremity of which are two other small balls $f_1 f_2$ that discharge themselves upon the conductors plunged

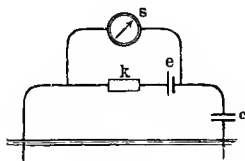

Fig. 184.

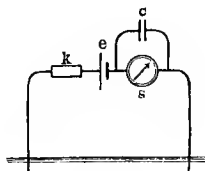

Fig. 185.

into water. At the receiving station two other conductors immersed in the water form part of the circuit, in which is included a coherer k , a condenser c , a relay s , and a battery e , arranged as shewn in elevation (Figs. 184 and 185).

Practical Experiments.—In the summer of 1898 Braun performed some experiments in transmission with the above system, by immersing transmitting and receiving wires at the two opposite extremities of the moat (of a winding form) surrounding the ancient fortifications of Strasburg; and then again on a larger scale at Cuxhaven, close to the mouth of the Elbe. In this last case, notwithstanding the very temporary nature of the arrangements, good results were obtained up to a distance of about 3 kilometers, equal to about 2 miles. Numerous trials made by the author shewed that transmission was effected purely through electric waves set up in the water, and not by conduction or by induction between the closed circuits or by electrical waves propagated in the air.

Notwithstanding the good results of these experiments, Braun did not follow them up, but devoted himself to the more promising problem of transmission through the air.

Aerial Transmission.

Fundamental Innovations.—As far as can be deduced from the dates of the patents, Braun must have been the first to reform the transmitting apparatus, with the view of diminishing the very considerable damping which all apparatus in which the antenna was directly joined up to the oscillator presented, and of increasing the length of the oscillation waves. This would have given the power to bring into play larger quantities of energy, and of obtaining more considerable diffraction effects, by thus giving to the waves the faculty of passing more easily round any obstacles which might oppose themselves to the propagation of the waves in a straight line.

The adoption of an oscillator but slightly damped, as made by Braun independent of the antenna, brought with it the necessity, owing to the very small radiating power of such an oscillator, of causing the oscillator to act by induction on the radiating antenna, and of making use therefore of a transformer for transmission of the oscillations from one to the other. He determined accurately the oscillation periods of his transmitters, and found experimentally the length which had to be given to the antenna, in order that it should be in tune with the period of the oscillator, a length which should correspond to one quarter of the fundamental wave length of the oscillator, as we have already seen in our resumé of the theoretical portion (page 73, Chap. VI.).

It is easy to see that these innovations are inspired by the same theoretical principles which influenced those introduced by Marconi to his apparatus in their transition from the first system to the second, and it is natural that both should have carried on their experiments in such a way as to evolve apparatus which finally differed but little.

It is not our intention here to discuss the priority of these two experimenters; these are questions that have more interest to the various companies that are reaping

commercial advantages from them than to the public for whom we are writing; hence we pass without further delay to the description of the principal arrangements contrived by Braun for wireless telegraphy across the air.

Principal System.—One of the first and simplest forms of Braun's apparatus is that represented at Fig. 186. The spark gap consists of an almost closed circuit, comprehending a condenser C and the self-induction bobbin S . The little balls of the spark gap are, as usual, attached to the extremities coming from the secondary of a Ruhmkorff coil, which is not represented in our figure.

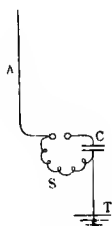

Fig. 186.

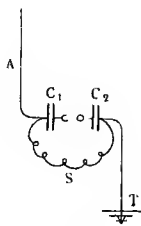

Fig. 187.

The two ends of the self-induction coil communicate, the one with one of the balls of the spark gap and the sky rod, the other with one of the coatings of the condenser, and also to earth.

Braun has shewn experimentally that although the circuit $C S$ be a weak radiator, the antenna, which is in direct communication with it, becomes the seat of strong oscillations that radiate freely from it when its length is equal to one quarter of the length of the wave of the oscillator. Later on Braun adopted the more symmetrical arrangement as in Fig. 187, which may be looked upon as a Lecher circuit (see page 74), with the difference that the resonating circuit formed by the two wires, of which one constitutes the antenna and the other of which is in communication with earth, is connected directly to the secondary coatings of the condensers instead of being attached at two points, which are near the one to the other, of the self-induction coil S .

It is a well-known fact that in Lecher's apparatus the effects of resonance are more intense in proportion as the bridge which joins up the parallel wires is longer. In the case illustrated at Fig. 187, the bridge may be looked upon as consisting of the entire self-induction coil S .

Later on Braun found that it was unnecessary, at least in the transmitter, to have any communication to earth, which only made the apparatus too sensitive to atmospheric discharges, and therefore he insulated one of the wires that started from the self-induction extremity, and took the other to make connection with the antenna, giving the former for symmetry a length equal to that of the sky rod (Fig. 188).

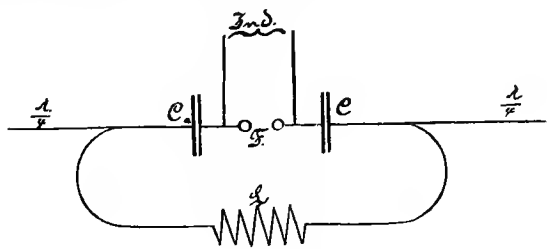

Fig. 188.

Again, later on he increased the number of condensers, coupling them together in a manner already shown at pages 151 and 152 (Figs. 99 and 100), so that at the act of discharge the sparks should pass between the coatings of each condenser, thus permitting the utilisation of very large quantities of energy without compromising the oscillatory character of the discharges or altering their periods, since each condenser can only discharge itself across its own coatings.

Instead of setting up direct communication between the antenna and the oscillator, Braun also made use of an inductive coupling to a transformer LS , as is shown at Fig. 189, in such a manner that the exciting circuit CL is always separated both from earth and from the sky rods; in this case the winding S of the secondary that communicates with it on the one side and with the antenna on the other with a symmetrical wire having a length equal to the

antenna. This transformer is oil insulated, and is enclosed in a glass recipient (see Fig. 92).

In their entirety we have here also in the transmitting apparatus two essential parts communicating one with the other, one being an oscillatory circuit, almost closed on itself, having a well defined period, which, as a result of the trifling damping to which it is subjected, acts as a kind of reservoir of energy, and a transmitting circuit properly so-called, which is open, and which is the seat of strongly damped oscillations, consequent upon the permanent radiation of energy which they themselves produce.

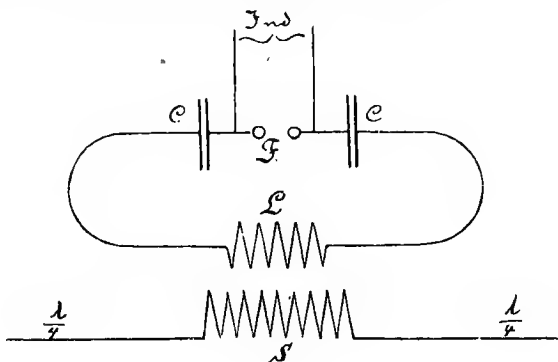

Fig. 189.

The symmetrical wire in Fig. 189 is traversed at every instant by equal and contrary currents to those which flow at the same instant through the aerial line; it is therefore possible to replace it by a condenser, or by a suitable coil selected to produce the same effect. Even the earth might be made to serve the same end, although it would be hardly advisable in view of the difficulty of making a good earth, and also because any atmospheric discharges that might occur would disturb transmission.

The firm Siemens & Halske, that make the Braun apparatus, assure us that these are altogether free from any such defect. Even with the system of inductive excitation represented at our Fig. 189, many condensers can be united, as shewn at Figs. 99 and 100, each one of which can

discharge itself on its own coating, and is in communication with a special portion of the primary of the t transformer, as is shewn in Fig. 190; or the arrangement given at Fig. 191

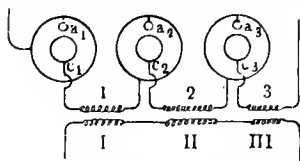

Fig. 190.

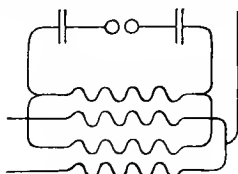

Fig. 191.

may be adopted, distributing the primary oscillation among a certain number of inducing circuits, arranged in parallel, which reacts upon so many induced circuits communicating on the one hand with the antenna, and on the other to earth.

The receiver is shewn at Fig. 192, and it may be said to be the inverse of the transmitter. Its peculiar property is that

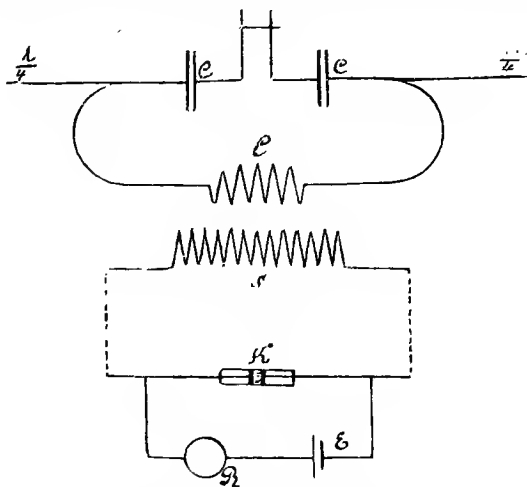

Fig. 192.

of being very sensitive to waves having the same period as the transmitter, and insensible, or almost so, to waves of different periods.

The waves are received by an antenna, which transmits them to a resonant circuit $CC L$, which must accumulate the energy which comes to it up to the point of rendering them able to act on the coherer K . The period of the circuit $CC L$ must be in tune with the circuit SK , including the secondary of a transformer, the coherer, the battery E , and the relay R , which throws into action the secondary circuit (not shewn in the figure), wherein is placed the registering apparatus.

In the transformer of the receiver which works at very low pressure, there is no necessity of using oil insulation, air

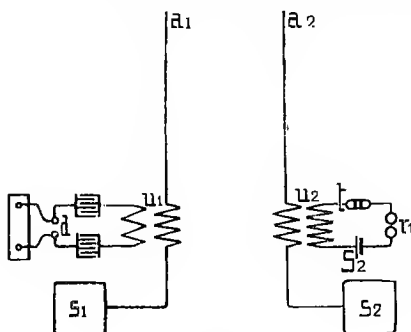

Fig. 193.

insulation being quite sufficient (see Fig. 102). Likewise, in the receiving apparatus, the wire in symmetry with the antenna may be done away with, and replaced by a suitable condenser, that in its turn may be looked upon as an indirect communication to earth.

By adopting such changes in the sending and receiving apparatus the Braun system may be represented diagrammatically as at Fig. 193, in which S_1 S_2 represent the capacities that take the place of the tuning or symmetrical wires, that go to the antennae A_1 and A_2 .

Other Modifications.—Braun also makes use of the plan shewn diagrammatically at Fig. 194. In this the antenna A is energised by means of a condenser K , one coating of which is connected to the antenna, and the other to one

of the balls of the oscillator, or spark gap. The condenser K' , which is placed in shunt with the oscillator, serves to regulate the period of the oscillations produced. In the earth wire T is introduced another spark gap O' .

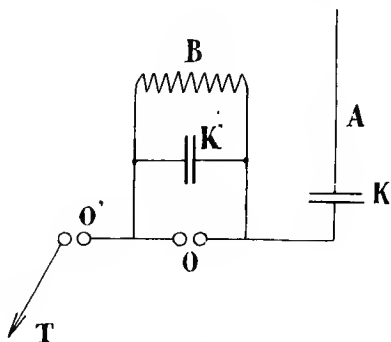

Fig. 194.

It would appear, however, that this arrangement gives results that are not quite so good as those given by the inductive excitation plan, which, conjoined to the advantages already mentioned, has that of rendering the antenna harmless. In fact, in this latter case only Tesla currents are set up in the antenna, and these do not produce any disagreeable sensation on the antenna being touched. Any

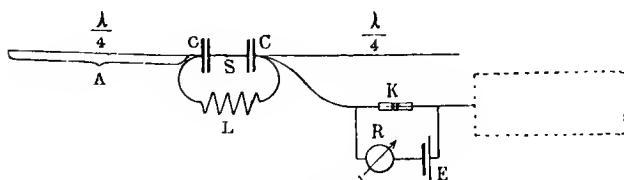

Fig. 195.

accidental defects in insulation are in this case less serious.

In the receiver, besides the inductive excitation already described (Fig. 192), Braun employs the arrangement

shewn at Fig. 195, in which the coherer circuit is attached directly to the coating of the condenser, that is likewise in direct communication with the antenna, and the mixed arrangement of Fig. 196, in which the coherer circuit communicates, on the one side with the secondary of the transformer, and on the other with the coating of the condenser and with the antenna.

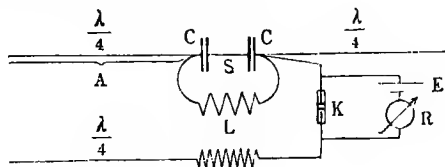

Fig. 196.

Practical Arrangements.—Fig. 197 is a sketch of the connections of the receiving apparatus, and Fig. 198 represents the interior of a station on the Braun system.

At Fig. 197 the first terminal to the left is attached to the receiving line wire, and the oscillations gathered up by it go to excite the oscillatory circuit, comprising the condenser *C* and the inductance *L* (see Fig. 102).

From the second terminal to the left starts the wire of communication with the plate that takes the place of the symmetrical wire of the line wire.

The circuit represented by dots serves to connect up to the secondary coil the coherer *Coh*; that represented by dots and dashes is the primary of the relay *R*, the secondary of which is indicated by dashes separated by two dots. The decohering hammer or percussor is represented in *K p f*, the call bell by *K l*, and at *N* we have the connection to the Morse apparatus.

The coherers are those filled with steel filings, as already described by us along with the other coherers at page 169. The letters W_1 W_2 W_3 represent the inductive resistances which serve to annul the sparks which would take place on the opening of the circuits of the relay, of the percussor and of the electric bells, similar to those marked p_1 p_2 q *s*, etc., of the Marconi apparatus at page 223.

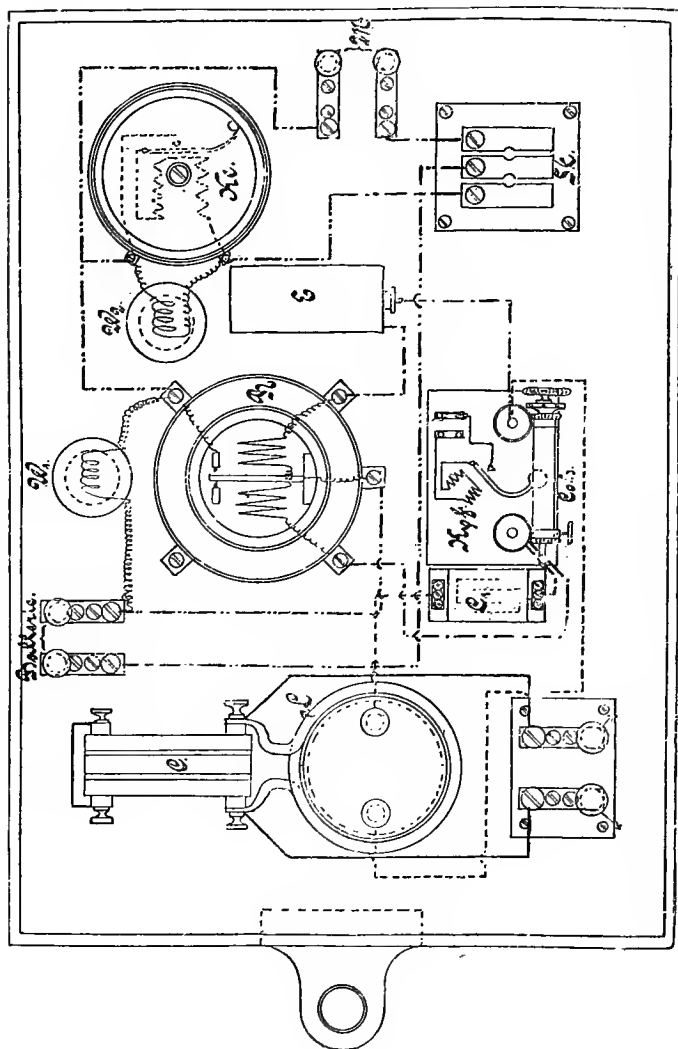

Fig. 197.

Fig. 198, which represents the interior of the station at Cuxhaven, does not call for much explanation. To the left on the bench are seen the battery of condensers

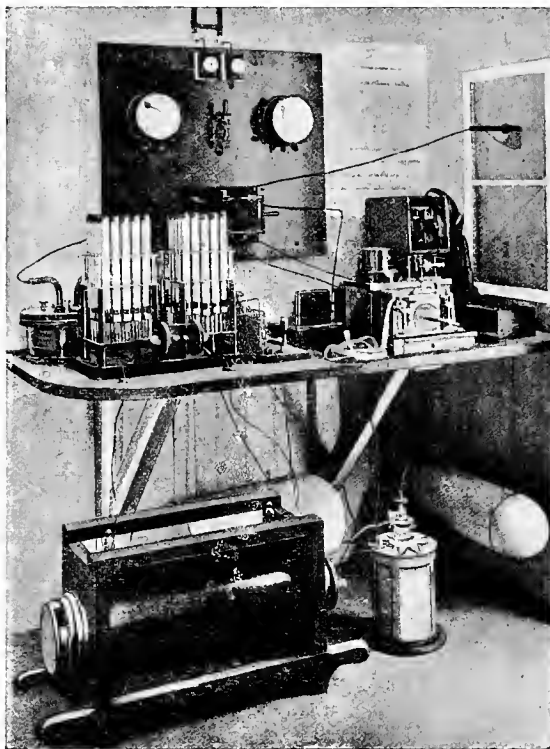

Fig. 198.

described by us at page 152; to the right is the Morse receiver, below is the coil, and close to it is the Wehnelt brake (see page 115) of a special form adapted to this purpose.

Radio-Telegraphic Apparatus for Field Work.—The firm Siemens & Halske have applied the arrangements suggested

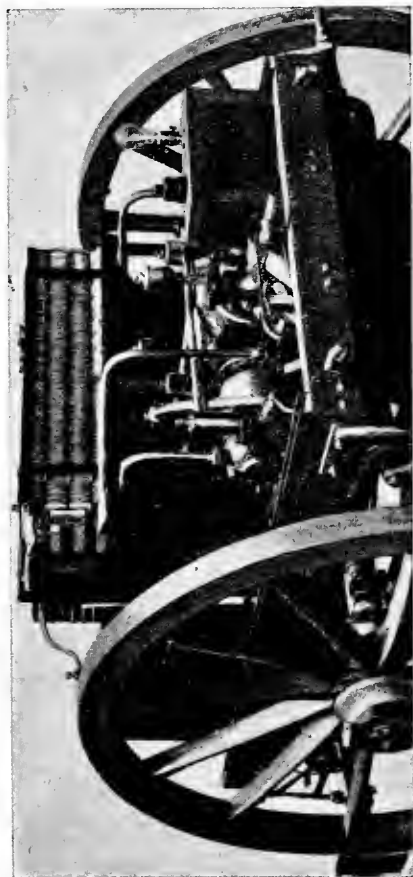

Fig. 199.

by Braun to the construction of a complete portable field radio-telegraphic apparatus, as represented in Figs. 199 to 201.

The disposition of the different parts has been made in a very convenient manner on two waggons, well suited to use in the battlefield, very similar to two artillery limbers attached together and drawn by three pairs of horses.

The foremost contains all that is required for the reception, while the hindmost carries the apparatus necessary to transmission. From Fig. 199 it is possible to form an idea of the group generating electrical energy and the mode in which it is arranged on the artillery limber, on which there is room for the operators.

A benzine motor running at 800 r.p.m., and having about 5 horse power, drives a 2.5 kilowatt dynamo, which furnishes a normal potential of 120 volts.

The benzine tanks are placed under the back portion of the self-same limber; close to the generating group is the regulating rheostat, which may be seen to the right of the figure, enclosed in a wooden case. Above may be seen the fan radiators, along with a small rotary pump that carries the cold water, destined to the cooling of the cylinder, into circulation.

An idea of the radiator may be more fully gathered on examination of Fig. 200, which gives a view from the front. Here may be seen the dynamo and the coil, capable of giving 10 inch sparks. On the dividing panel between the anterior and the posterior halves of the generator and radiator car, is seen mounted the switchboard, on which are placed the measuring and controlling instruments, besides the battery of Leyden jar condensers similar to those which are already described at page 152.

These consist in 40 small Leyden jars, 12 inches in length and 1 inch in diameter, grouped into two sets, destined to form two condensers, which in our Fig. 198 (page 265) are represented to the right and to the left of the spark gap or oscillator.

The total capacity of these is 0.01 microfarad, and must be kept unvaried. The entirety of the radiating system thus briefly described allows the operator to obtain for every spark passing through the spark gap several score of waves radiated from the aerial wire, which is raised to a great height by means of captive balloons or by kites, when the wind is favourable to their being flown. The foremost car

carries, as we have already said, the receiving apparatus, and Fig. 201 gives an idea of the construction of the car

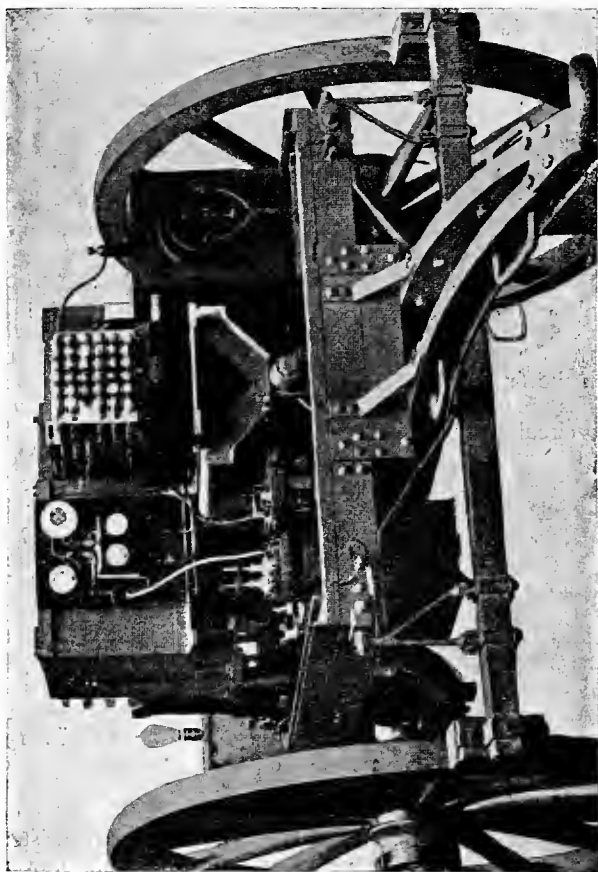

Fig. 200.

itself. To the right may be seen the coherer and the relative relay, in the middle is the Morse instrument, both parts being fed by Hellesen dry cells.

In the same manner that the back car carries the benzine tanks, so the front car bears hydrogen gas recipients, that

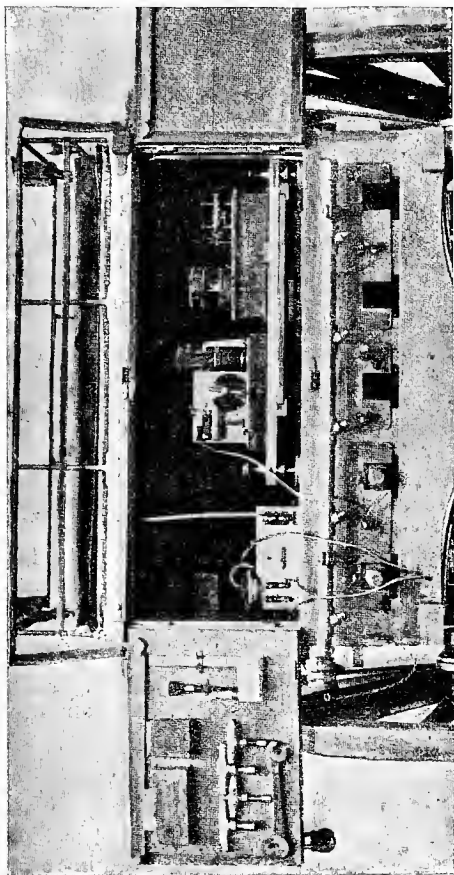

Fig. 201.

are necessary to the filling of the captive balloon for raising the aerial wire.

Naturally, the two cars carry all that is necessary for

ballooning, etc. The operators, as distinguished from the drivers, consist in one officer, one non-commissioned officer, and five men. Messages can be sent a few minutes after the halt. They have been found to succeed perfectly, and, according to the information given in the *Elektrotechnische Zeitschrift*, have been sent as far as 50 miles; but it is considered that communication can be established without difficulty in a normal way to a distance of not less than 80 miles.

Parabolic Radiator System.—Braun has recently patented radiators for telegraphy, having the form of a cylinder of parabolic section, and built up of a number of little rods arranged vertically according to the generating curve of the cylinder; each rod being joined by means of an electro-linear wire to a sphere which is placed in the focal line of the cylinder.

Two similar pieces of apparatus are joined together in such a manner that the spheres should find themselves two by two at a short distance one from the other, thus constituting a series of spark gaps. All the rods are excited at the same instant, but the phase in each one depends upon the length of the connecting wire. The total action of all these little rods is to produce a bundle of rays, exactly parallel to the axis.

The capacity of each little rod may be raised at will by the addition of condensers, which allows them to radiate a larger amount of energy. The capacity and the self-induction of each rod are chosen in such a manner that their vibration periods shall be all equal.

Such a radiator lends itself to a system of telegraphy by guided waves, similar to that carried out in another way by Blochmann (see p. 137).

The Slaby-Arco System.

Slaby, Professor at the Charlottenburg Polytechnic, undertook his first experiments in this direction in 1897, shortly after having assisted in England with the experiments made by Marconi, and the apparatus he made use of was similar to that then employed by Marconi.

At the sending station he adopted an induction coil made

by Siemens & Halske, giving from 5 to 6 inch spark, fed by 8 accumulators, and acting on an oscillator of the Righi type (see Fig. 65), the internal balls of which were at a fixed distance of 2 millimetres apart ($\frac{1}{12}$ th inch), and the externals at a distance variable from $\frac{1}{8}$ to about $\frac{3}{4}$ inch.

At the receiving station the primary circuit consisted of the coherer, a dry cell and a Weston galvanometer arranged in series. The pointer of the said galvanometer was arranged so that it could act like the armature of the relay (see p. 203), that is to say, could be made to close the circuit of a local battery.

The inductive resistances $k' k$ (Fig. 112, p. 170) that Marconi employed in order to prevent the electro-magnetic

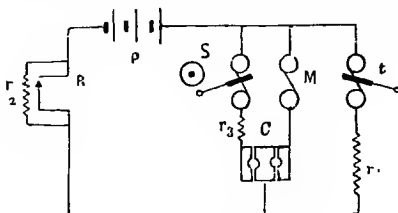

Fig. 202.

waves from disturbing the relay were suppressed. The secondary circuit was that represented in our Fig. 202. The battery p and the hammer of the coherer t and the pointer of the Weston galvanometer R are in series; the switch C allows of the bell S and the Morse machine M being put in parallel.

With this arrangement, using an aerial line of the height of 100 metres (112 yards) supported by a captive balloon, Slaby was able to keep up communication up to a distance of 21 kilometres (12 miles). Later on, a more careful consideration of the conditions of the vibrating apparatus led him to effect some radical alterations in this primitive apparatus, in virtue of which it acquired a certain degree of originality.

In studying these modifications, he was assisted by Count Arco, hence, the system is now known under the name of "Slaby-Arco."

Principles of the System.—The consideration that formed the starting point of the modifications adopted by Slaby, was that as the coherer is sensitive to differences of potential and not to variations in current strength, it should be placed at the upper extremity of the antenna, where the differences in potential reach their maximum and not at the foot thereof, where they are at a minimum, there being there a node in the variations in the potential.

If, notwithstanding this unfavourable position of the coherer, it lends itself fairly well to a communication, that is due, according to Slaby, partly to the great sensibility of the instruments, and partly to the presence of secondary waves, that set up variations in potential even at the points in which the node finds itself; and to the want of symmetry in the system through which a true node is not to be found at any one spot.

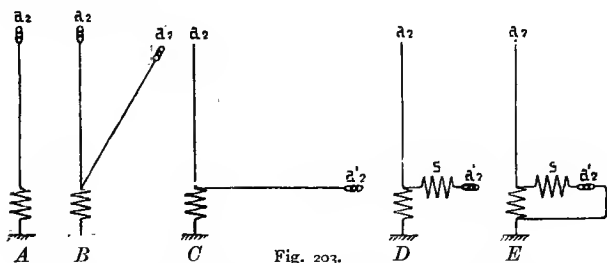

Fig. 203.

By placing the coherer at the upper extremity of the antenna, certain difficulties would be imported into the apparatus, so as to render it difficult in practice; however, Slaby found the means of reproducing the oscillations in potential, which take place at the upper end of the antenna, in a more accessible spot, in which the coherer could be conveniently located.

In our Fig. 203, *A*, *a*₂ shews the coherer placed in the most rational position; however, if close to the vertical wire be arranged a wire of equal length inclined to it, as is shewn at Fig 203 *B*, at the end of the second wire variations of potential similar to those that are manifested at the end of the first wire will be produced, just in the same manner that

by setting in vibration one side prong of a tuning fork, the other enters spontaneously into vibration.

The excitation of the second wire is independent of the angle which it forms with the first, hence a horizontal direction may be given to it, as is shewn in our Fig. 203 *C*.

In the Figs. *A*, *B* and *C*, the dotted lines represent graphically the extreme values of the potential and various points along the line.

This was precisely the arrangement given by Slaby to the new receiver, that is to say, from the foot of the antenna started a horizontal wire of a length equal to that of the height of the antenna, called the prolongation line, and at its extremity was placed the coherer.

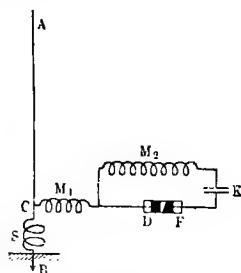

Fig. 204.

However, if the antenna is of considerable height, even the horizontal wire in Fig. *C* becomes inconvenient; but as far as the electrical work is concerned, it may be bent into the shape of a helix, as shewn at Fig. 203 *D*, and at the extremity of this the coherer may be placed.

If the free end of the coherer be taken to earth, as is shewn at our Fig. 203 *E*, the differences of potential that affect the coherer lie between zero and plus V and between zero and minus V , and are therefore at their maximum equal to V , supposing that the maximum excursion of a potential be $\pm V$. Slaby has doubled the difference of potential acting at the ends of the coherer, by joining up these two latter to the ends of a bobbin M_2 (Fig. 204) having about twice the length of M_1 , in such a manner that the length M_2 should correspond to a half wave; during

vibration, the point D will always be a half period behind that of the point F , and for that reason the two points are always in opposition of phase, and the difference of potential that is exciting the coherer will be that between $+V$ and $-V$, that is to say of $2V$, therefore double that in the preceding case.

The coil M_2 , instead of communicating directly with F , may communicate with it through the condenser K ; in this case, it is necessary that the vibration period of the circuit $M_2 K$ should correspond to half that which is used in signalling.

When making use of the coil M_2 , Slaby became aware that it increased the electro-motive force acting upon the coherer, in a proportion much greater than what was expected, hence he gave to that bobbin the name of "multiplier."

We would point out that Murani does not hold the view that the theory by virtue of which Slaby justified the use of this prolongation wire is correct; in fact, he points out that the node of potential would really be formed at the base of the antenna, at the point where Marconi places his coherer, if the antenna be in direct communication with earth, but since between the antenna and earth the coherer is interposed (which is of very high resistance), one must look upon the antenna as being insulated from earth, and he has shewn experimentally that in an insulated antenna a node is formed at the centre and the loop at the two extremities; therefore in Marconi's system, the coherer, before becoming a conductor, finds itself in a loop of vibration, that is to say, in the most advantageous spot for being rendered conductive by the waves; therefore, the prolongation wire would be not only unnecessary, but actually injurious, as it would give rise to a dispersion of energy.

Syntonised Systems.—The action of the multipliers that depends upon the form of the winding not only increases its effect on the coherer, and at the same time the carrying distance and certainty of the transmissions, but prevents also the coherer from feeling the influence of waves, having different periods to those for which it is tuned, and therefore contributes largely to the syntony existing between the sending and receiving apparatus.

In order that the tuning of the receiver on the Slaby-Arco system to a given length of wave may attain its end, viz., that of acquiring the maximum sensibility, it is necessary that the sending station should emit waves of that given frequency for which the receiver is tuned.

The first arrangement adopted by Slaby is represented at

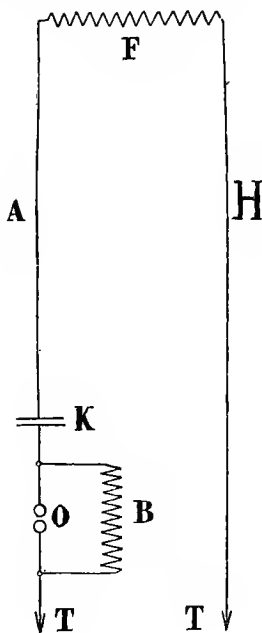

Fig. 205.

Fig. 205; it is furnished with two aerial lines *A* and *H*, joined by means of a powerful self-induction coil *F*, and communicating below, one to earth and the other with one coating of the condenser *K*, the second coating of which is connected to one of the little balls of the sparker *O*. The second ball of this spark gap is coupled up to earth. The wire *A* constitutes the radiating antenna, because, according

to Slaby, the self-induction coil F presents too great an obstruction to the oscillations produced at the discharge to allow it to pass on to the other wire. The condenser K serves the double end of increasing the quantity of electricity liberated at each discharge, as well as the period of the oscillation; this last is determined by the capacity of the condenser and by the length of the antenna, for which reason, without employing antennae of too great a length, it is possible by increasing the capacity of the condenser to have waves of long period.

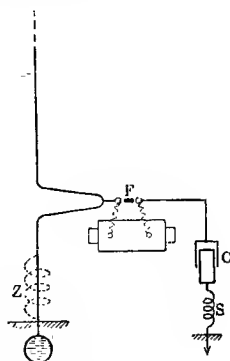

Fig. 206.

Slaby quickly recognised the inconvenience of this arrangement; in fact, in order that the wire H , introduced with a view of determining better the vibration period by localising the same in an almost closed circuit, without upsetting the effects of the wire A in the inductance F , should be so great as to prevent the oscillation of A to propagate themselves in H ; but in that case the oscillation can only be effected in the antenna A . Hence, a return was made to that type of open radiator, endowed with much damping, and therefore with an ill defined period.

Slaby therefore introduced into the earlier arrangements successive modifications which we will not describe, and which led him on to the system that he finally adopted, and which is represented diagrammatically at Fig. 206,

The circuit in which the oscillations are set up is made up of the oscillator F , fed by an induction coil. The two little balls and the sparker both communicate to earth by the intervention on the one side of a bobbin of coarse coils Z , and on the other with the condenser having movable coatings C and the self-induction coil S . As the circuit is closed it has a definite period. The radiating antenna is put in shunt on this circuit, and therefore takes part in its vibratory movements, and the maximum effect is attained by

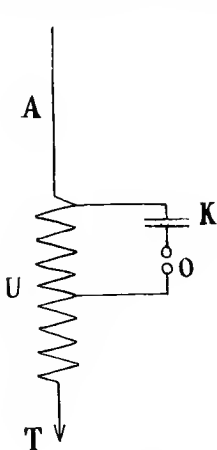

Fig. 207.

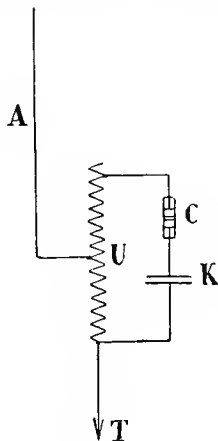

Fig. 208.

regulating the period of the oscillator in such a way so that it should correspond to the period of the antenna. In order to obtain this accordance the period of the antenna can be made to vary by varying its length, and the period of the closed circuit by varying the capacity of the condenser C , or the number of turns in the self-induction coils ZS . Probably, however, with this arrangement the energy radiated by the antenna will be somewhat less than the energy at disposition, in consequence of the direct communication between the antenna and earth.

Figs. 207 and 208, which call for no explanation, represent another arrangement adopted by Slaby, the first for the

sending station and the second for the receiving. Latterly, the oscillator has been rendered symmetrical by placing a capacity also near the other ball of the spark gap, as is shewn at Fig. 209, which renders its arrangement identical to that of Braun (Fig. 187).

In warships the arrangement shewn at Fig. 210 has been adopted. The exciter F_1 is placed in the ship in some protected place, and works with low potentials; in circuit with it is placed the capacity K and the self-induction S_1 . An insulated wire puts the oscillator in communication with

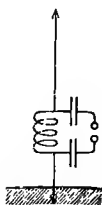

Fig. 209.

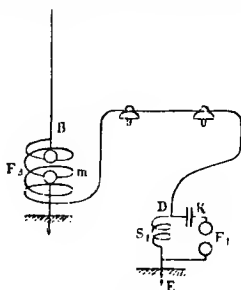

Fig. 210.

the self-induction coil F_3 , having coarse spirals, that acts as a multiplier, and which terminates with the radiating antenna B . Within the spiral F_3 are placed two metallic balls, the one in communication with the antenna, and the other with earth; the effect of the multiplier is to increase considerably the potential at the extremity of the antenna, so that the sparks in m are ten times longer than those in F_1 . The receiving station is represented at Fig. 204.

Practical Arrangement of the Apparatus.

The diagrammatic arrangement just described must be carried out completely in practice with all the accessories necessary to the working of the station.

Transmitting Apparatus.—In the transmitting apparatus two parts may be distinguished: the low tension circuit that feeds the primary of the coil, and the high tension circuit

that comprises the secondary of the coil with its condensers, inductances, etc., which serve to regulate the periods of the oscillations to be transmitted to the antenna. The low tension circuit is shewn in the scheme at Fig. 211, and consists of an inducer that may be fed by the continuous current coming from the mains (+ and -).

In the rotary interruptor (see Figs. 61 and 62), when very heavy supplies of current are required, in order to avoid the use of mercury the continuous current may be converted into an alternate one by means of the Grisson converter (see page 117). In the circuit is also placed the Morse key, furnished with a magnetic spark blower (see page 118)

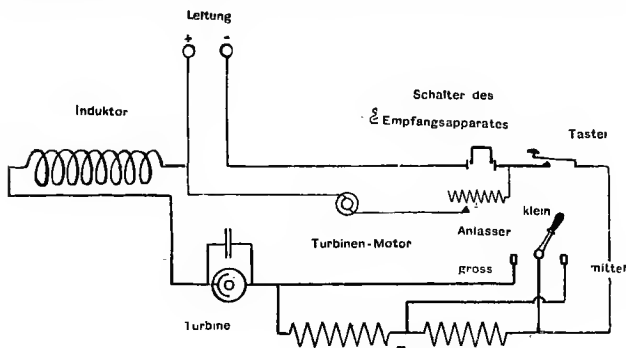

Fig. 211.

and regulating resistance having three contacts, viz., Small, Medium, and Great, in order to reduce the volume of current to the transmitter when it is desired to transmit to short distances only, according to the position of the switch, 2, 1 or none of the auxiliary resistances represented below are inserted. The high tension circuit consists of the condenser, sparker, transmission wire, the automatic interruptor or switch, the syntonising bobbin, and the lightning conductor.

The condenser consists of from 3 to 7 or 14 Leyden jars, having a capacity of $\frac{1}{10000}$ th of a microfarad each, according to whether the height of the antenna be less than 20 to 40, or above 40 yards in height.

The spark gap placed in connection with the ends of the secondary of the coil is that already described by us at page 121, Fig. 66, with the sparking balls arranged vertically, the upper one being movable and connected up to earth, and therefore not dangerous; while the other, contact with which would be dangerous, is placed in a position not easy of access, and for safety is distinguished by being coloured in red.

At Fig. 104 may be seen the little cylinder which encloses the spark gap, and below it is the large cylinder containing the battery of Leyden jars described at pages 152, 154. The transmitting wire is an insulated conductor, whose upper extremity for about 10 per cent. of its whole length is wound round into the shape of a cylindrical cage. The automatic switch is placed between the antenna and the battery of Leyden jars, and serves to throw automatically the high tension between the transmitters and the receiver out of circuit during the reception of the messages.

The tuning bobbin consists of a few turns of wire wound round the cylindrical case containing the Leyden jars (Fig. 103); and a lightning arrester inserted between the antenna and the laboratory is opened in case of storms.

The Receiving Apparatus.—The general arrangement of the receiver is represented at Fig. 212. It consists of two distinct circuits, that is to say a low tension circuit including the coherer and battery, and the other one at higher tension that is closed by the relay with the local battery that works the registering apparatus.

In our Fig. 212 the wires belonging to the first circuit are marked in dashes, while those belonging to the second are indicated by dots. In the coherer circuit we have the coherer *A*, the switch *U*, the cell of the coherer battery *F*, the winding of the relay *R R*, the condenser *C*, the additional resistance *W*, and the switch *S M*.

The coherers are of the hermetically sealed type, of variable sensibility, as described at page 169. The connection to the spring switch *U* is carried out in the manner indicated at page 179, in order to avoid the formation of sparks among the filings of the coherer. The relay is constructed in the manner shewn at page 202.

The condenser is in parallel with the dry cell, and with

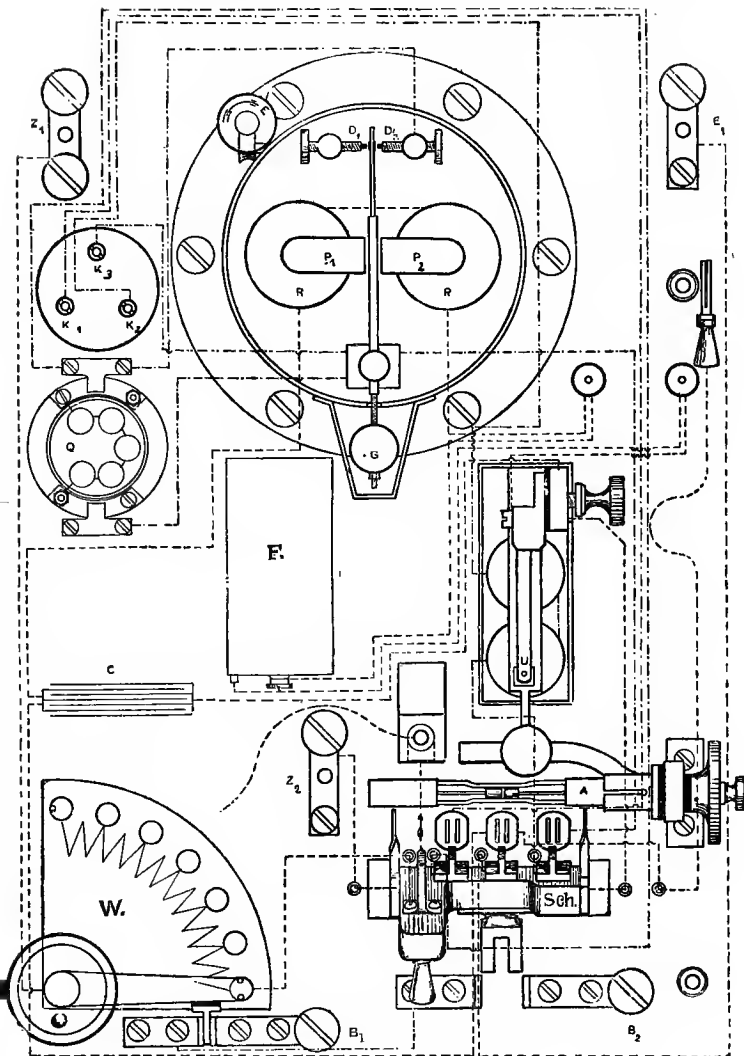

Fig. 212.

the windings of the relay it has a capacity of .01 microfarad, and is therefore infinitely great as compared to that of the coherer; it serves to absorb the excess of tension which might influence the coherer, as a result of the self-induction of the relay, hence it facilitates decoherence. It is built up of tinfoil, separated by laminae of mica. The earth wire which goes to E_1 runs directly to the coherer (thus avoiding the self-induction of the relay) through the condenser and through the interruptor U .

The additional resistance serves to weaken the intensity of reception in movable installations when telegrams are sent to very short distances. By varying the position of the handle, it is possible to alter the tuning and thus diminish the effect of the waves on the coherer.

The relay, besides putting into action the decoherer or percussor, also actuates a call bell and a Morse receiver; these two last are not shewn in the figure, nor is the battery of four dry cells that furnishes the current to these pieces of apparatus. The battery when not at work is closed across a series of polarised resistances, which, while they prevent the exhaustion of the battery, which would take place if non-inductive ohmic resistances in parallel were inserted, are arranged in such a manner as to gather the self-induction currents due to the circuits actuated by the relay, and to prevent the production of sparks in the contacts of the relay itself.

When the spring of the relay closes the circuit, the current flows through the winding of the hammer, the resistance of which is about 6 ohms; and the polarisation cells put in short circuit by the relay, discharge themselves at the same time.

When the spring returns, the polarisation of the cells take up the electricity produced by the self-induction of the hammer and the Morse electro magnet, as a consequence of the interruption of the current, and therefore the break spark, which might influence the coherer, is not formed at D_2 . The Morse apparatus is put in parallel with the hammer. It is furnished with four bobbins, placed two by two in parallel, of which one pair can be cut out by means of a switch; a shunt from the pair that are permanently in

circuit leads to a call bell which must be put in circuit only when no one is present in the laboratory.

The sparks produced by the interruptor on the call bell are taken up by the polarisation cells, that are placed on the table that supports the bell itself. In order to syntonise the stations, Slaby devised the syntonising coil already described at page 157. In order to complete this description, we give

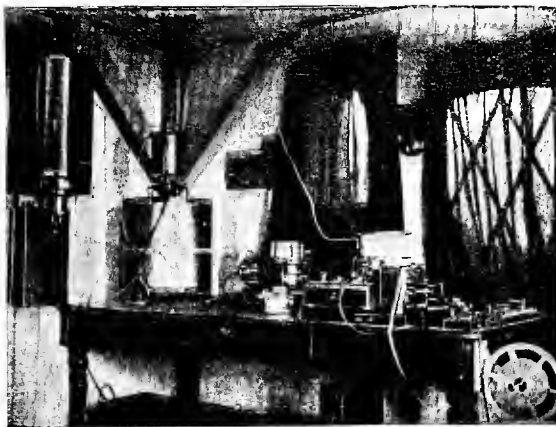

Fig. 213.

at Fig. 213 a view of the interior of a station at Bremerhaven, which is worked on the Slaby-Arco system. It will be easy by following the above description to recognise the different pieces of apparatus.

The Popoff-Ducretet System.

The general principle of this system is the same as that of the Marconi, and as we know, the Popoff receiver comes in historical sequence before the Marconi receiver, which has all its fundamental parts in common. However, in the Popoff-Ducretet system, as now used, the most minute details of construction have been studied with the greatest

care in the Ducretet workshops, with the view of perfecting the system which shall be at once easy and certain in use. The chief peculiarity consists in the use of a controllable percussion coherer of the Ducretet type (page 174) inserted in the usual circuit in the relay; for distances at which the relay receiver begins to be unreliable with the energy employed, the radio-telephone Popoff-Ducretet (Fig. 128, page 185) is substituted in the said figure, L is connected up to the antenna, $B r$ is the self-decohering coherer, $T e$ is the earth connection, $T T'$ are the two telephones, which, along with the coherer, are in circuit with the dry cell contained in the back part of the box.

The relay employed is of the Siemens movable frame type, as modified by Ducretet (see page 205); and the registering apparatus is a Morse automatic.

Fig. 214 represents the transmitting apparatus. The two balls of the oscillator O are connected one with the antenna in P , and the other to earth at T . At I is seen the mercury break, with its electro motor; at M is a special manipulator already described at page 111 and at page 102. Likewise on this system, in order to facilitate transmission and reception at great distances, syntonised circuits are made use of. In such a case the sending antenna, instead of communicating directly with one of the poles of the induction coil, communicates with the secondary of a Tesla circuit (see page 146), the primary of which is connected up to a condenser and to an exciter applied to the poles of a Ruhmkorff coil.

At the receiving station tuning is obtained by inserting in the circuit of the coherer by means of movable runners, greater or lesser lengths of parallel wires arranged on a wall frame. In this system, the antennae take the special form represented at Figs. 172 and 174. This system is applicable to the exchange of signals between ships and the shore at distances greater than 160 miles by using relay receivers; such distances can be increased by using radio-telephones and by augmenting the power of the transmitter.

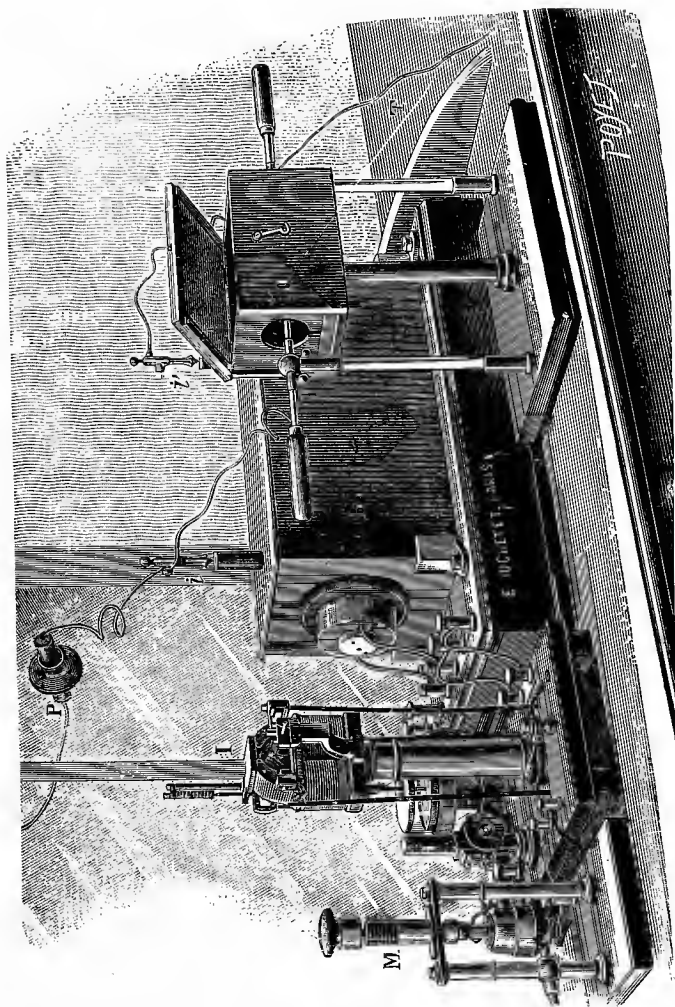

Fig. 214.

Fessenden System.

We need not enter into a discussion of the ideas evolved by Fessenden, when presenting his own system of wireless telegraphy, according to which his apparatus does not give rise to waves similar to the Hertzian waves, but to waves of a different character, which he calls "semi-free waves," that is to say, half waves instead of complete waves, which travel on the superficies of conductors, and therefore not in straight lines; but we will pass without other considerations on to the description of his apparatus.

The plan of a double station of the Fessenden type is represented at Fig. 215; the antenna 1, already described by us at page 129, is connected to one extremity of the secondary winding of an induction apparatus (2), the other extremity of which goes to earth. When the lever of the switch is on the contact *a*, the apparatus is in the transmitting position, and the induction coil is in continuous work. For the production of Morse signals, the key 4 is lowered and raised in the ordinary manner (see page 103), and this key, instead of breaking or making contact with the exciting current to the coil, modifies the capacity and the self-induction of the oscillating circuit, by destroying the syntony which had been first established between the transmitter and the receiver.

The said key will also work as an ordinary key. In order to pass from the transmitting position to the receiving, it is sufficient to carry the lever 3 over to the contact *b*. The receiving circuit comprises the antenna 1, the condenser 12, an inductive capacity 13, which consists as also 5 of parallel wires stretched under oil, and the indicator (hot wire) already described at page 197. Recently, the inventor has replaced this receiver by the liquid thermic receiver described at page 199.

In parallel with the indicator a telephone 15 is mounted, in which the variations in the distance set up in the indicator under the influence of the waves are transformed into sounds perceptible to the ear.

In order to increase the sensibility of the apparatus, and to render it capable of serving as a call, the vibrating

diaphragm of the telephone is provided with a microphonic contact 32, which is placed in the primary circuit of a transformer 33, whose secondary is connected to a telephonic bell 34.

The apparatus is protected from atmospheric discharges

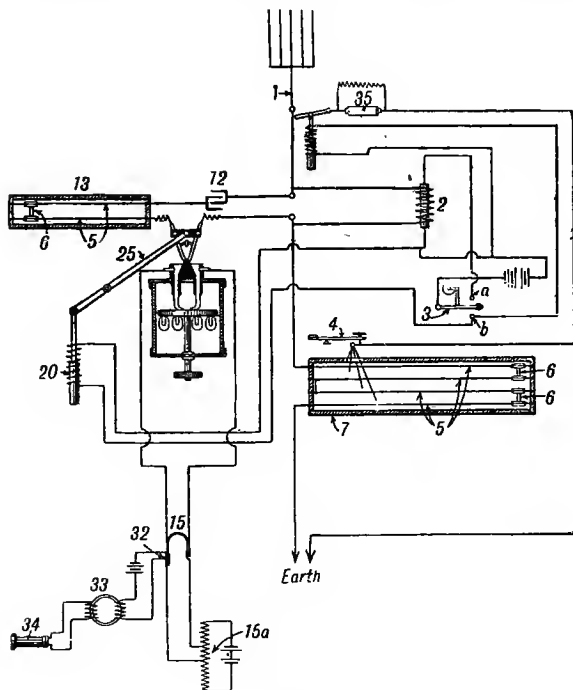

Fig. 215.

by a coherer No. 35, which plays the part of a lightning arrester.

Special arrangements are adopted in order to give notice if a station be occupied or free.

Among other peculiarities of the Fessenden system are: The spark gap under pressure already described by us at

page 122, of which use was made for distances of 340 miles, when ordinary antennae are employed, and for distances of over 120 miles, when antennae of 24 feet are used; and an arrangement by means of which short antennae can be employed if enclosed along with the oscillator, in a sheath surrounded by water or other liquids of high dielectric coefficient, an arrangement which according to the inventor greatly increases the energy of the electro-magnetic waves and the distances to which they can reach.

This system, as we have already said at page 199, allows of great rapidity of transmission, and necessitates in similar conditions antennae of lesser height than the other system.

Fessenden, besides the arrangement described, has patented several others that differ from it specially in the receiver, for which he has adopted the plan of inductive excitation, adapting it to the registration of signals by means of a registering syphon or some photographic process. He has also patented other methods for putting the sending in tune with the receiving station.

One of these is based on the use of two or more antennae, a, b, c, d, \dots at the former station, and of others a', b', c', d', \dots at the latter, tuned together in pairs, that is to say a with a' , b with b' , etc., etc., the periods, however, of a, b, c and d being different the one from the other.

At the sending station is a rotary cylindrical switch or commutator, having metallic contact so arranged on it that the exciting current passes alternately through one or other of the exciting circuits, which energise the respective antennae, or even contemporaneously through several of them; the velocity of rotation of the commutator must be strictly in accord with the velocity of the unrolling of the strip of paper at the receiving station. At this station, the several antennae communicate with the coherer, which is thrown into action by whichever of the antennae or groups of antennae enter into vibration.

De Forest's System.

This system, which is rapidly extending itself in the United States and in Canada, where it is employed by two Companies that are said to rival in power that of Marconi

himself, has been represented by its inventor as an adaptation of the Lecher circuit (see page 74) to wireless telegraphy.

Fig. 216 represents the transmitter circuit, at T are represented the primary and the secondary circuits of the coil; the secondary is placed in parallel with the spark gap S , and with the condenser C , that altogether constitute the oscillator.

From the condenser start two secondary wires that run side by side for a length equivalent to half that of the wave emitted by the oscillator. At the extremity where the node

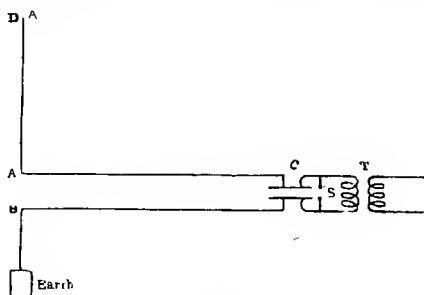

Fig. 216.

of vibration is formed, the said wires are bent, so that one goes upwards to the antenna, and the other downwards to earth. In practice, as it would not be convenient to adopt precisely the two-wire Lecher system as shewn at Fig. 216, de Forest has found that it may be replaced by two insulated wires lying side by side at a distance which is determined by the thickness of their insulation, and forming with them a twin wire which is wound into the shape of a helix on a bobbin, having its turns not too far apart. Good results have been obtained in which the thread of the helix was $\frac{1}{3}$ rd of an inch, the bobbin being 3 inches in diameter.

Fig. 217 represents the arrangement adopted by de Forest for exciting the oscillator. Instead of using a coil, he employs a transformer fed by an alternate current machine. The primary current is at 110 volts pressure, and at 120

alternations is raised in the secondary circuit to a pressure of 25,000 volts.

Signals are produced by the closing and opening of the primary current by means of a special key or interruptor that works in oil.

The spark discharges itself between two metallic discs that are in shunt across a suitable condenser, and which is connected on the one side with the antenna, and on the other with earth, through a double-wired coil (not shewn in the figure).

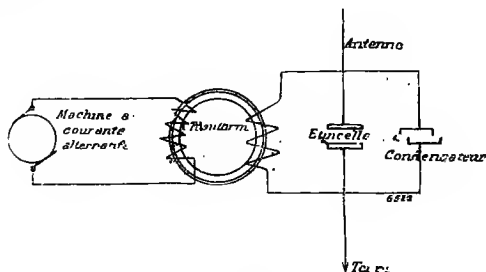

Fig. 217.

Fig. 218 represents one of the arrangements adopted for the receiver. The principal novelty consists in the adoption, in place of the coherer, of the so-called de Forest-Smithe responder, as already described at page 189, which acts as an automatic recovery anti-coherer. The anti-coherer presents normally a weak resistance only, therefore permits the passage of a considerable current through the telephone circuit. At the instant when the antenna receives the impact of the electric waves, the anti-coherer diminishes in resistance, the current increases in intensity, and the telephone emits a sound which is renewed with each fresh arrival of waves.

Instead of a single responder, two may be employed in series, as shewn in the figure, which permits the employment of a higher E.M.F. S_1 , S_2 are the usual self-induction or choking coils, B is the battery, R a variable resistance placed in shunt on the circuit, which comprises the telephone and a condenser.

In another arrangement, de Forest separated the local circuit, which includes a telephone, from the circuit of the antenna, causing the one to act inductively on the other by means of a transformer; and he has also substituted for the telephone a relay which throws into action a Morse apparatus.

In experiments recently carried out under his system, de Forest has employed a receiver based on the electrolytic system, of which, however, he has not given a description, as he has not yet secured a patent, but which appears to present marked advantages over that of the responder, but

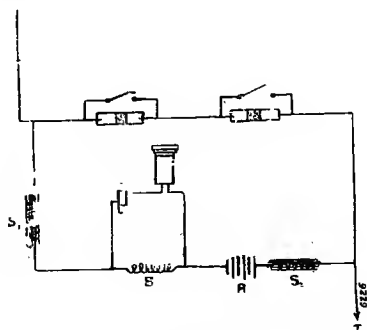

Fig. 218.

like it seems to present a diminution of resistance under the action of the waves.

A special form of radiator that he has devised must be noticed. This is of the aerial type, and consists of five wires taken to a height of about 70 yards, and joined together above, and kept apart at half way down to a distance of about 3 yards, the one from the other, by means of stretched ropes. At their lower extremity, four of the wires are metallically joined together and go to a little metallic ball. The fifth is separate from the others and is connected to a second ball, between these two is placed a third, which is connected to the sparker or oscillator.

When the antenna is acting as a transmitter, sparks fly freely between the central ball and the two lateral ones, so

that the antenna acts as if it had five wires in parallel, but when it is acting as a receiver the bundle of four wires remains joined up in series with the fifth wire, thus forming a closed circuit with the communication to earth.

De Forest says that he makes no pretensions to syntony, but rather believes that absolute synchronisation is practically impossible. He simply arranges the circuits so as to get the maximum effect; by this means he is able to synchronise to a certain point, but he does not pretend that the arrangement is absolutely mute to waves that are not intended for it, although these may generally be distinguished from the others in consequence of their difference in frequency.

In order to regulate the apparatus so as to obtain the maximum effect, de Forest introduces in the oscillating circuit by means of a movable contact, a greater or lesser number of spiral turns, wound round a cylinder about 18 inches in diameter. In consequence of the exalted frequency, a very trifling displacement of the movable contacts suffices to produce a considerable difference in the nature of the waves emitted.

One of the advantages claimed for this system above others similar, lies in the enhanced velocity of transmission, which may reach from 25 to 30 words per minute. It lends itself to transmission and reception even from stations fitted with other systems, thus, for example, the Coney Island station has been able to send messages to the Steamship *Deutschland* at a distance of about 80 miles, this latter being fitted with a Marconi apparatus. Besides the many installations set up by the de Forest Co. in the United States and in Canada, we may point out that they have constructed machines of the power of 150 kilowatts, that are to be installed in California, at Honolulu, at Manilla, and in Hongkong for trans-Pacific service, and that the New York Central Railway, in view of the satisfactory results obtained in the preliminary trials, has adopted the de Forest system in its express trains in order to keep up communication with the stations during the journey.

It is stated that the Marconi Co. has commenced an action against the de Forest Co. for the infringement of the patent.

Various Systems.

Some of these, rather than being true wireless telegraphy systems, are simply originalities imported into one of the methods already described, either by substituting one or more of the ordinary apparatus by others which are either entirely different, or more or less modified; others again claim to have introduced peculiar adaptations in obtaining syntony, in insuring secrecy, or in bringing about other improvements in the practice of radio-telegraphy, hence in describing these we shall have practically little else to do than to refer to the descriptions already given.

Rochefort-Tissot System.—The Rochefort transmitter does not differ from that patented by Marconi in 1897 (No. 29306). The secondary of an induction coil in series, with whose primary is a source of current and a key, is connected on one side with earth and with one ball of the oscillator, and on the other with an antenna and to the second ball of the oscillator.

Afterwards the coil was replaced by a unipolar transformer (see page 108), in which the whole tension was carried on one of its poles (that connected with the antenna), and for that reason the length of spark was not diminished by taking to earth the low tension pole.

The Rochefort receiver is of the Popoff type, as experimented with in Russia as far back as 1895 (see page 84); but each part is made on a model specially devised with great care by Rochefort himself. The antenna is connected to earth through a coherer put in circuit with a battery and Claude relay (see page 203) having a movable quadrant. This relay causes a percussor and a Morse automatic to enter into action.

The coherers employed are those of Tissot and Rochefort described at page 175. The arrangement shewn at Fig. 219 has also been adopted by Tissot, and this seems to increase the certainty of reception. The antenna is directly connected to earth through the self-induction bobbin S , while the coherer c communicated on the one hand to earth and on the other to the antenna through a condenser C .

Ducretet, who is the constructor of the Rochefort-Tissot apparatus, has himself introduced therein several modifications.

The Popp-Pilsoudski System.—The antenna in this system, instead of being elevated, is buried in the ground, and consists in a wire which goes to a metallic sheet placed on a sheet of glass moistened with petroleum and resting on the ground. At the transmitting station the wire is connected to one of the balls of the oscillator, while the other

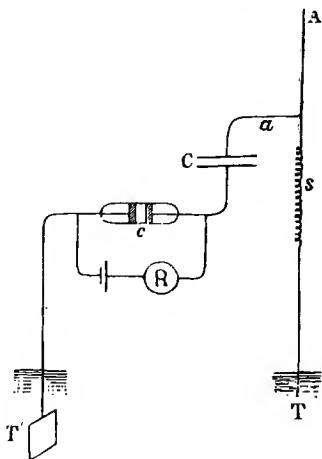

Fig. 219.

ball is taken to earth to a wire, and to a large metal sheet, buried deeply under the ground. At the receiving station the same arrangement obtains; the wire that starts from the sheet is joined to a very sensitive coherer, the other electrode of which is taken to earth. The apparatus works on the principle that the electric waves are propagated through the earth, and the inventors have even proposed to apply it to the recognition of the position of metallic strata in the earth by means of Hertzian waves. For such a purpose the inventors propose to instal the two stations at two points between which the presence of the mineral strata are

suspected. If such mineral strata exist, these owing to their conductivity form screens to the electric waves, so that the waves emitted at one point cannot reach the other.

In July, 1901, experiments with this system were executed at Vésinet, by which it was established that communication could take place between two stations placed at a distance of about 500 yards from one another even in the midst of houses.

The Guarini System.—The particular scope proposed by this inventor was that obtaining communication preferably it appears on land, using a minimum of current, so that he succeeded in telegraphing from Malines to Antwerp, a distance of about 15 miles, using only 35 watts.

This end he attained principally by suppressing the spark which serves to produce the Hertzian waves, and using instead the low frequency waves that he obtains from intermittent and alternating currents, acting on imperfect contacts.

Guarini applies the principles on which his invention is based in several modes, which, however, can be reduced to two main varieties: first, the method in which the receiver and transmitter circuits are open; second, that in which these circuits are closed.

In the first method the receiver is of the perfected Popoff type (see page 283), and the transmitter consists in an induction coil (without oscillator), in which the secondary is united to earth on the one side and to the antenna on the other.

In the other system Guarini makes use of alternating currents, and employs as a transmitter a source of variable electric currents, connected either directly or through an induction coil to a closed circuit, such as for example a sheathed antenna (see Fig. 71).

As a receiver a somewhat similar arrangement is employed, in which the coherer, with its battery and relay, take the place of the source of variable currents in the transmitter.

Guarini has also applied his system of telegraphy, the automatic repeater that bears his name, and which we have already described at page 214.

The Cervera System is similar to that of Rochefort-Tissot; the transmitting apparatus is distinguished from this latter

by the insertion of condensers between the antenna and the earth plate; and is furthermore characterised by two tapping keys described at page 101.

The Cervera receiver approaches in its latest form to the Marconi receiver (Fig. 165, page 237), with cylindrical concentric antenna joined to earth through the primary of its small transformer.

The battery that in the coherer circuit throws into action a first relay, closes the circuit of a second relay which has four functions: 1st, that of putting the Morse into action; 2nd, that of putting the decohering percussor into play; 3rd, that of interrupting the coherer battery current, which is effected by the armature of the percussor itself; 4th, of interrupting the circuit of an electro magnet that governs by magnetic cohesion the sensibility of the coherer.

The Morse printer, the percussor and the electro magnet have each a separate battery, that along with the two of the coherer and relay cause the Cervera receiver to have five sources of electricity, a combination which must render the apparatus rather slow in transmission, although we have been assured that by its use a speed of 25 words per minute has been obtained.

The "Armorl" System.—The originality of this system consists in the adoption of the mercury electro-capillary relay already described by us at page 205. Although we have not to hand any complete data as to the practical results of this system, it appears that the relay by which it is characterised is well fitted to detect the microscopic currents that reach a distant station through the earth.

The Preece System.—This is a system of wireless telegraphy acting by induction (see page 39), and was among the first of the methods employed before the application of electric waves.

The Schaeffer System.—This system, as far as is known, differs only from that of Marconi in the employment as a detector of the Schaeffer type instead of the coherer. This we have described with other methods at page 189. It was tried as far back as 1899 by Schaeffer and Rola at Trieste and Venice, and subsequently on the Bristol Channel and elsewhere.

The Blochmann System.—In this no antennae are made

use of, and the waves are guided by means of lenses of some dielectric (paraffin), as described by us at page 137, and is a system which would ensure safety in reception, and would permit a recognition of the direction from which the waves arrived, so that it would be possible to locate the position of a ship lost in the fog if the waves emitted by this ship were received by two stations on the coast.

The inventor has shewn that lenses as large as might be deemed necessary at first sight are not required; in fact, he has succeeded in telegraphing to a distance of nearly $\frac{3}{4}$ mile with lenses 40 inches in diameter and waves 4 inches in length, with a consumption of power in the primary of less than 1 kilowatt.

The Tesla-Stone System.—This method is chiefly intended to ensure the safety and the secrecy in the messages. The principle upon which it is based is the following:

The sending station emits its signals by means of two or more sets of contemporaneous waves differently tuned. The receiving station has as many detectors, each one tuned to the period of one of the said systems of waves, but the receiving apparatus does not act until all the detectors are simultaneously excited.

As a consequence, the receiving station is not disturbed by any station that emits waves of one period only, because, as these can only affect one of the detectors and not the others, the receiver is not affected by any single wave.

The sensitiveness of the receiver to signals that are not directed to it may be diminished, not only by increasing the number of the distinct vibrations acting together, but also by judiciously selecting these vibrations, and the succession in which they are produced.

Figs. 220 and 221 represent respectively the plans of a transmitting and of a receiving station, in the case in which it is desired to employ only two different sets of waves, which will be found in the greater number of cases to afford sufficient protection.

At Fig. 220 S_1 and S_2 are flat spirals, that communicate by their internal periphery with the antennae, terminating in the capacities E_1 , E_2 , and at their lower extremities with earth at E . The electrical vibrations are transmitted to the secondary systems D_1 , S_1 , E and D_2 , S_2 , E by the primary

windings $P_1 P_2$, which surround the spirals. The bobbins $P_1 P_2$ are mounted in series in two independent circuits that comprise the condenser $C_1 C_2$, the variable self-induction coils $L_1 L_2$, and the brush carriers $B_1 B_2$ that sweep the teeth of the rotating wheel PP , which is in communication with the conductor F and with earth. A source S of high potential charges the condensers $C_1 C_2$, evolving in the two circuits, having different capacities and self-inductions, electrical oscillations of different periods that

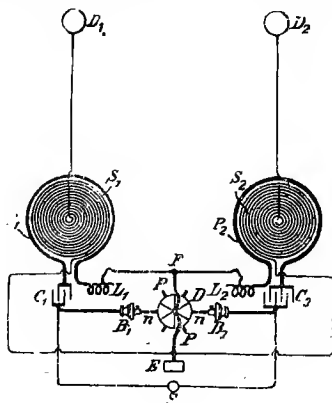

Fig. 220.

are renewed in a rapid succession at every fresh contact of the teeth of the wheel with the little brushes n . The two antennae thus emit simultaneously successions of waves of different periods.

The receiving station represented at Fig. 221 has likewise two antennae ending in two capacities, and joined up to the two flat spirals, forming two systems of different periods, but each one tuned to one of the two systems of the sending stations.

Parallel to the spirals are arranged two local circuits or receivers, each one consisting of a wave detector $a_1 a_2$ (e.g. the coherer), a battery $b_1 b_2$, a variable resistance $r_1 r_2$, and a relay $R_1 R_2$.

The armatures l_1 l_2 of the two relays are united by a connecting wire W , and when they are attracted they touch at c_1 c_2 two contacts that close a third circuit, comprising a battery and a printer. In order to close the circuit, and therefore to throw into action the printer, it is necessary, however, that both the relay armatures should be attracted simultaneously, otherwise the circuit remains broken at the contact, corresponding to the non-attracted armature, and therefore it is necessary that the waves which arrive should be capable of influencing at the same time the receivers connected to both the antennae.

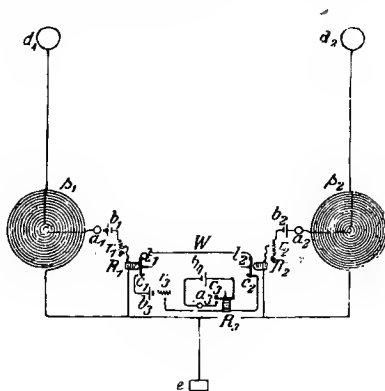

Fig. 221.

The Artom System.—This system is characterised by having two antennae at right angles traversed by electrical oscillations of equal amplitude, one of which lags a $\frac{1}{4}$ of a period behind the others, a combination, as has been shewn at page 136, that gives rise to the production of electrical waves travelling in the direction of the rectilinear, that starts from the point of meeting of the two antennae, and which is perpendicular to their plane.

Such waves being unable to influence any receivers but those placed in that direction, offer a means of guiding the waves in any pre-established direction, thus influencing any determinate station and not affecting any others.

Fig. 222 represents the plan of the arrangement. MNP are three discharging conductors placed on the vertices of a rectangular triangle of equal perpendiculars. Between M and X is inserted the capacity C , and between X and P is the self-induction bobbin S ; the points X and M are united to the poles of the secondary of an induction coil R .

The two antennae are connected either directly or through induction bobbins, one with the ball M and the other with the ball N , and by suitably proportioning the capacity C

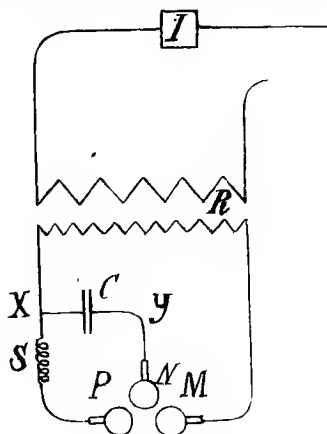

Fig. 222.

and the self-induction S , it is possible to ensure that the two discharges which take place, the one between N and M and the other between N and P , shall be of equal amplitude and displaced by a quarter of a period, in order to give rise to the above-mentioned combination.

The same effect may also be obtained with antennae inclined at an angle differing from 90° , provided that the self-induction coil S be so modified that the lag between the two oscillations be not of a quarter of a period, but have another value given by theory.

Thus, we have in this system of syntonising the two stations, besides the usual elements, capacities and self-

induction coils, that of the different value that be given to the lag of the two oscillations, the one with regard to the other, and that of the different lengths of waves that can be obtained by giving the rods different lengths.

The syntony obtained by equalising all these elements is thus rendered more difficult of discovery or of imitation by those who do not know the elements themselves; therefore the secrecy of the correspondence is better ensured.

The Duddell-Campos System. — The engineer G. Campos has studied the possibility of utilising the electrical oscillations that are set up in the circuit of a singing arc (see page 47) to wireless telegraphy. At page 51 we have

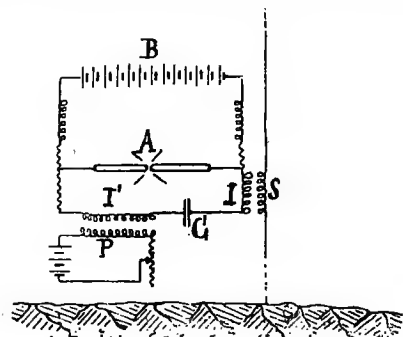

Fig. 223.

described the more suitable arrangements for the utilisation of the Duddell circuit to the reproduction of articulate speech; requirements for the production of a simple musical sound from the arc is a much easier matter; for this purpose (see Fig. 223) it is only necessary to join the extremities of the arc with a circuit comprising condenser G and self-induction coil II' . If certain conditions are satisfied, at the instant that the circuit of the arc is closed, the condenser becomes charged and discharged with a rapidity corresponding to the vibration period of the circuit with which it is in circuit, producing thereby alternating currents, which, overlapping the continuous current feeding the arc, causes it to vibrate with a period equal to that of the

alternating current; and if the said period lies between the limits of perceptible sounds the arc admits a musical note.

The circuit *AIGI*¹ is known under the name of Duddell's circuit.

As the continuous current that feeds the arc supplies continuously to the vibrating circuit the energy which it loses, these vibrations are much more persistent than those of the Hertzian circuits, in which the energy is supplied by the explosive discharges between the balls of the exciter.

When speaking of syntononic vibrations (page 87), we have pointed out the necessity of persistence in the exciting oscillations, in order to bring about the effect of the resonance; hence the vibrations in the Duddell circuit are eminently fitted to transmission of signals into space by means of syntonised apparatus, and Duddell from the time of his first experiments in 1900 pointed out their applicability to wireless telegraphy.

Campos has recently taken up and enlarged upon Duddell's idea, and has verified that the Duddell circuit, just because it is an excellent oscillator, is a radiator of little or no efficiency, because it consumes energy in itself without radiating any to the surroundings, whilst for wireless telegraphy a large quantity of radiated energy is absolutely necessary.

Campos has proposed to overcome this difficulty in somewhat the same manner as is done in the other systems of radio-telegraphy, when for open oscillators have been substituted those which were almost closed (see page 92), that is to say, by causing the continuous oscillator to act by induction on an open oscillator, of which the antenna forms a part. To this end, it suffices that the self induction coil *I* of the Duddell system (Fig. 223), should act as the primary of a transformer, the secondary *S* of which should communicate on the one side with the antenna, and the other with earth.

However, the Duddell circuit, such as is ordinarily employed, presents the inconvenience of allowing only a very small quantity of energy being set in action, as compared to the wants of wireless telegraphy to great distances.

In one case calculated by Campos, this energy would be of about 40 watts, while in the oscillator of the Poldhu station for Trans-Atlantic transmission, it is reckoned that an average of about 30,000 watts is needed.

Among the means proposed by Duddell and by Campos in order to increase the amount of energy employed in the Duddell circuit, there is that of using several arcs either in series or in parallel, instead of a single one; thus, for example, with 10 arcs in series, the energy at disposition

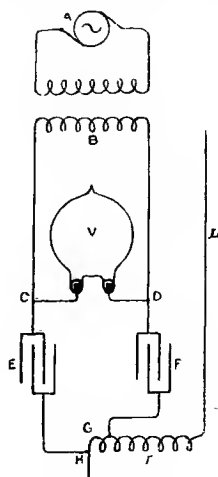

Fig. 224.

would rise to 2170 watts; however, in this case it becomes necessary to devise some expedient in order to regulate the work of the arcs, or else to make use of closed arcs in which the work is more regular.

Among other expedients to be tried, Campos has pointed out the employment of the Cooper-Hewitt lamp (see Fig. 224) instead of the arcs; or of the cathodic valve known as Villard's as well as that of Greetz, or finally, of the tubes of rarefied gases which were used by Righi to obtain sonorous phenomena analogous to those of the arc.

The Duddell circuit, in consequence of having little or no damping, lends itself eminently to awakening resonance in a resonator tuned to it; such resonance being very powerful in the case of perfect coincidence in the periods of the two circuits, and fading away rapidly when this coincidence becomes less perfect. This circumstance, besides favouring the work of synchronised stations, permits in marked manner the increase in the number of distinct stations that may communicate at the same time in the same zone by making use of different wave-lengths without diminishing the safety and the secrecy of the messages.

Upon this great sensibility of his system to the conditions of resonance, Campos bases his method for the transmission of signals; discharges would be continuous and the signalling would be obtained by destroying and by re-establishing sympathy between the sending and the receiving stations.

This could be effected not only with the usual plans, but by using an auxiliary alternating or inductive current that traverses the primary P (Fig. 223), of a coreless transformer; the secondary I' forms part of the Duddell circuit. A suitable key would serve to interrupt or to re-establish the passage of the auxiliary current, by which means it would be possible to alter the vibration rate of the Duddell circuit, thus destroying or re-establishing the accordance between the two stations for longer or shorter intervals of time corresponding to the signals to be transmitted.

Cooper-Hewitt System.—This is very similar to that just described, except that in place of an arc lamp a mercury vapour lamp of the Cooper-Hewitt style is employed.

This lamp consists of a brass tube full of mercurial vapour, fitted with two electrodes, the positive being of iron and the negative of mercury.

This lamp, which is very economical from an illuminating point of view, has among its other singular properties, that of not permitting the passage of current through it when inserted in an alternating circuit, until the difference of potential between its two electrodes has reached a very high critical value; from that moment the current passes, but ceases immediately the potential difference has fallen below a certain limit, to re-establish itself as soon as the potential has again risen to its critical value, and so on.

Cooper Hewitt has utilised this property of the said lamp to the production of very rapid electrical oscillations applicable to wireless telegraphy. As may be seen in Fig. 224, the lamp is inserted in the secondary circuit of an alternator, and parallel with it are placed two variable capacities E and F , along with a variable self-induction bobbin, of which one end goes to earth and the other to the antenna L .

The current of the alternator at those times in which the lamp does not allow of its passing, charges the condensers, which then discharge themselves, producing electrical oscillations at the moment in which the lamp becomes conductive; but this lasts less than a half period of the alternator, because when the tension of this latter falls below the lower critical point the current traversing the lamp again stops, the condensers becoming recharged, again discharging themselves, and so on.

The lamp therefore acts as an interruptor by means of which controllable interruptions at enormous velocity can be obtained. The discharges in the vacuum of this lamp are not subject to the irregularity which takes place with discharges in air, and it is therefore possible to set up and maintain by means of the above mentioned arrangement of continuous oscillations, of that absolutely definite nature that is necessary in wireless telegraphy.

Simon and van Reich almost at the same time as Campos studied the suitability of the Duddell circuit and that of the mercury lamp for obtaining persistent currents of the high frequency necessary to render more marked the phenomena of resonance in syntonic wireless telegraphy. They calculated that the frequency of the singing arc reached 20,000 periods per second, but they succeeded in reaching as many as 1,000,000 per second with a Hewitt mercurial lamp.

They afterwards stated that better results might be obtained from a spark gap in vacuum thrown into action by a continuous current, that would necessitate the employment of a large amount of energy (several thousands of horse power), but which would give correspondingly intense effects.

The Valbreuze System.—Like the two preceding, this system has for its scope the production of rapid electrical oscillations of little damping and controllable at will.

The essential portion is a tube CD with mercury electrodes (Fig. 225) that is in series with the source A of continuous currents and with a self-induction bobbin D ; in shunt with the same circuit if placed in condenser E .

The bobbin D is the primary of a coreless transformer, the secondary of which consists of another spiral D' that on one side is led to earth, and the other side is connected to the antenna.

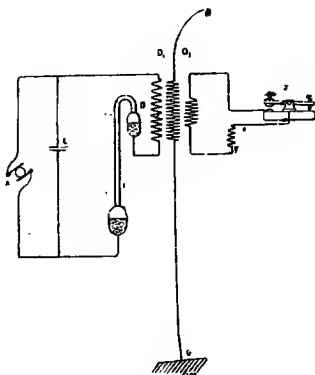

Fig. 225.

A key, or switch T , opening and closing the self-induction circuit I , in series with a third coil D_2 , serves to emit the signals without interrupting the main circuit. The action of the apparatus is based on the phenomenon observed by Warren de la Rue with a vacuum tube fed by a battery of 1080 elements. When this was put in shunt with a condenser the light in the tube became stratified and the circuit was traversed by an undulatory current of short period. In precisely similar conditions does the tube CD find itself, and the undulatory currents thus produced are those which are utilised to excite the vibrations in E_2 . Such a transmitter is capable of radiating a very great quantity of energy, because mercury tubes can be constructed for currents of several hundreds of amperes, and, when more intense currents are required, several such tubes can be put in parallel.

“Telefunken” System.—The new system of wireless telegraphy resulting from the amalgamation of the Braun and the Slaby-Arco methods have received this name.

Other Systems.—Other inventors such as Blondel, Anders Bull, Tommasi, Ascoli, etc. have introduced or proposed modifications in the methods of obtaining syntonisation; but we will discuss these respective systems by themselves in a later chapter on syntonisation.

CHAPTER IX.

SYNTONY AND SELECTED INTER-COMMUNICATION.

WE have on several occasions called attention to the importance that the solution of the problem of syntonizing the apparatus has in radio-telegraphy, that is to say, in causing the waves emitted from an apparatus at one station to excite a pre-arranged apparatus only, at another station, as takes place in ordinary telegraphy. When this problem shall have been solved, it will be possible to have true independent stations, capable of being multiplied and enlarged according to needs, without fear of mutual perturbation. Then, and then alone, shall we have attained the scope of secrecy and of selected inter-communication.

The perfect solution of the problem presents difficulties that are almost insurmountable; let us suppose that at a given moment several groups of people were seated round several tables talking to one another, and that they, withdrawing from the table, were desirous of continuing their conversation from different parts of the room, speaking across one another, with the expectation that they would be heard only by those to whom their speech was directed, and would not be disturbed by the discourse of the others. We should then have an idea of the difficulties that have to be overcome by the proper syntonisation of the different apparatus used in wireless telegraphy.

We have seen at page 30, that the phenomena of electrical resonance, similar to those of acoustic resonance, have indicated one of the means to be followed in attempting the

solution of the problem, at least in the special case of a small number of stations.

A fact that has been really ascertained in this direction is that, between two stations tuned for the same length of wave, it becomes possible to exchange signals with transmitting apparatus of much less power and with receiving apparatus of lower sensibility than those which would be called for had not accordance been obtained ; moreover, by using wave lengths and quantities of energy of very different values (nearly in the proportion of 1 to 2), it has been possible to transmit with a single antenna, and to receive simultaneously, telegrams from two different stations ; and other experiments, even more complex have been said to succeed. However, as we have seen, we are still very far from the desired complete solution of the problem.

There are two conditions which must be sought in order to facilitate this syntony, which we may call physical: 1st, that the sending apparatus should emit waves of well defined period, damped but little or hardly at all ; 2nd, that the period of vibration of the pieces of apparatus at the two stations should be capable of being easily regulated, so as to bring them into the condition of perfect coincidence.

We have seen in the description of the various systems of radio-telegraphy, that many means have been attempted or proposed to attain the first conditions of physical syntony, such as the substitution of the closed oscillator of the Lodge type to the open oscillator of the Hertz type (page 93), the employment of alternators in place of induction coils, the substitution of the Duddell arc oscillator, or Cooper Hewitt's mercury lamp, etc. to the ordinary spark oscillator.

In the majority of the said systems, the second condition is satisfied by regulating the capacity or the self-induction of the oscillating circuits and of the antennae until the four sets, viz. : the spark gap system, the transmitting antenna, the receiving antenna and the coherer circuit, have the same vibration period.

If, besides this, as occurs in the extra powerful stations (see page 239), the spark circuit is multiple, that is to say, if it consists of several spark gaps in series acting one on the

other, it is necessary that each of these separate circuits should be in tune with one another and also with their respective antennae.

The tuners or accorders (see page 156) answer this purpose ; and by presenting the capacity and the self-induction of the said circuits in suitable arrangements, admit of tuning being effected and recognised with facility.

Fessenden and Tesla's methods (pages 286 and 297) differ from the other systems of syntonisation described by us, inasmuch as in the first, by means of the syntonising key, syntyony is destroyed only at the moment in which signals are being transmitted, and in the second, signals are transmitted by means of two or more systems of different waves, each of which must be in tune with its own special receiver.

Artom's system admits, as we have seen (page 299), of various special methods for obtaining syntyony.

We now pass on to describe other methods proposed for reaching the same end ; among these, besides the method by which physical syntyony is attained, we have others whose scope is to obtain a syntyony that can be said to be mechanical, since two pieces of apparatus of this kind cannot correspond if in their mechanism certain special conditions are not satisfied.

Syntonisation Systems.

Blondel's.—Blondel pointed out in 1898 a method of syntonising, which consists in tuning together not the oscillation frequency due to the transmitter or to the receiver, but to those artificial frequencies of much lower velocity, that are altogether arbitrary, dependent on the amplitude of the acoustic vibrations, and independent of the antennae, that is to say, the frequency of the charge of the antennae and that of a selective receiver, as for example a Mercadier's mono-telephone.

In this case, it is necessary to keep quite constant the frequency of the interruptors, which must be equal to that of the receiver. In this case, in connection with the telephone, a self-decohering coherer must be employed. Under this system every group of high frequency waves (which must be strongly damped) that is set up between two

successive openings of the switch acts together as one single blow on a slow vibration telephone.

It is also found advantageous to place in shunt with the wave detector a capacity so reckoned as to form with the transmitting station a circuit of pseudo-resonance.

This method lends itself to an easy differentiation of signals in the receiving station, because, generally speaking, acoustic syntony is more sharply defined than electrical syntony. but it necessitates the employment of self-decohering coherers. which up to the present time have been found of low sensibility and rather uncertain in action, hence the application of this system is only possible to comparatively short distances.

Even the use of strongly damped waves, which are rendered necessary in this method, because in every set of waves the first impulse is the one that acts most energetically, diminishes the carrying power of transmission, because the sensibility of coherers is much greater to persistent waves than those which are strongly damped.

Ascoli's Method.—Ascoli notes that transmission between two apparatus that are not in syntony can only be done by opening or closing the circuit of the primary of the induction coil ; but if the apparatus be syntonised, correspondence can be established by other means.

Let us suppose the generator be not in tune with any of the receivers with which it has to correspond. When it is desired to communicate with a station *A*, the clapper of the coil is set into action, and it is allowed to work continuously the whole time that the message is being sent round.

In order to transmit signals, the primary of the induction coil is not touched, but syntony with the station *A* is either produced or removed in one or other of the ways indicated in the following paragraph.

By this means we have the advantage of being able to impede, in an untuned apparatus that lies in the vicinity of the transmitting station, the power of tapping the correspondence, as in this apparatus, we should only get a succession of indecipherable signals, consisting of a continuous line, instead of a series of dots and dashes given by the Morse alphabet.

As we have already seen, this method was put into practice by Fessenden (page 286), and also proposed by Campos Duddell (page 301).

According to the inventor, the best way of establishing or doing away with the accord with a given piece of apparatus is the following: In circuit with the generator is placed a vertical cylindrical bobbin, which is wound with such a number of coils that no one of the receivers will answer when it is in its entirety in circuit.

In the interior of this bobbin a massive cylinder of copper can be made to run, which, acting as a short circuit secondary, diminishes the self-induction of the bobbin. Hence, if the copper mass be placed at different heights, it is possible to establish, without touching the secondary of the coil, syntony with any one of the receivers; a very small displacement of the copper cylinder sufficing to produce or destroy syntony.

When it is desired to correspond with station *A*, the cylinder would be placed in a determinate position a little below that which is necessary to produce accord. Having set the coil in action, it will be sufficient to raise the cylinder a trifle in order to bring about syntony and be able to send signals, and thus, by raising or lowering, the Morse signals can be transmitted. These movements of the cylinder can be effected by means of a lever similar to that of an ordinary Morse key. As the key in this case has neither to open nor close any circuit, it may be of the simplest construction.

It is also possible to arrange the correspondence beforehand, by placing in short circuit a certain number of turns on the coil, instead of causing the cylinder to run up and down, and for corresponding, to establish or to destroy the accord by very small movements of the cylinder.

Other methods for compassing the same end, although they are, according to the inventor, less practicable, consist in acting by means of a key on the movable coating of a condenser, or upon the reciprocal distances between certain given turns on self-induction coils.

Or, the key might be made to serve to put in short circuit given turns on the coil, were it not that it is to be feared if

using high potential, heavy discharges would take place at the breaking and the making of the short circuit.

Ascoli, however, has shewn experimentally that even this last method, which is the simplest and most easily demonstrated, gives successful results.

Stone's System.—The system proposed by Stone for perfecting the syntony between the sending and the receiving stations is based upon the two following principles :

1. That magnetic hysteresis and its analogue dielectric hysteresis, when present in circuits, powerfully diminish the effects of resonance.

2. That resonance is the more powerful in proportion as the period of the vibration be more regular (harmonically).

He therefore eliminates magnetic hysteresis by excluding from the circuits all bobbins with iron cores, the dielectric hysteresis being suppressed by making use of air condensers instead of Leyden jars. In order to render the period of vibration harmonic, he filters out the vibrations emitted by the bobbin, and which are somewhat irregular, by causing them to pass through several vibrating circuits, acting by induction the one on the other, and all tuned to the same period, the last of which acts inductively on the antennae.

By the principle of resonance (see page 88) a circuit having a well determined period will gather up from a vibration of mixed periods those vibrations having a period nearer to its own, and thus will be obtained a vibration of purer period, and by causing this circuit to act inductively on another of equal period, this latter will furnish a vibration of greater purity and so on.

The author finds that in practice two successive circuits suffice to give almost perfect resonance in the way of harmonic vibration.

The arrangement of the circuits in Stone's method is similar to that in Fig. 167, with the difference that in place of the transformer T' we have an ordinary bobbin. The first circuit $CC'TT'$ contains the spark gap E , the second $CC''T'T''$ does not include the spark gap E , but serves to render more harmonic the vibration transmitted to it by the first.

The plan of the receiving apparatus is similar to that of the transmitter, except that instead of the spark gap E , we

have the coherer with its relative printing circuit. The vibrations that reach the antenna act inductively on a harmonizing circuit, and from thence pass to a second circuit tuned with the first, through which they reach to the coherer harmonized.

In experiments at Cambridge and at Lynn, the inventor obtained at a distance of 14 miles a variation of 10 per cent. ; that is to say that a variation of 10 per cent. in the period caused the intensity of the effects in the receiving apparatus to pass from the maximum to zero.

Anders Bull's System.—Here we enter into the domain of mechanical syntony. The principle on which its action is based is different altogether from that on which Marconi and similar have obtained their results

Instead of employing for the transmission of signals simple electrical impulses, use is made of a series comprising a certain number of impulses following one another at determined intervals of pre-established time. Thus, supposing that every signal is to consist of 5 distinct impulses separated from one another by 4 intervals of time, t_1, t_2, t_3, t_4 , giving to each of these intervals different values, it becomes possible to vary to infinity the series utilisable for transmission.

Let it be desired, for example, to transmit from a station T to a station R a portion of the conventional Morse alphabet, it will be necessary to send a series of 5 impulses separated by the pre-established intervals of time t'_1, t'_2, t'_3, t'_4 , for which the tuning of the receiver placed at R_1 has been previously arranged, and which will therefore register a single point. When the same station T has to communicate with another R_2 that is tuned for the other series of intervals $t''_1, t''_2, t''_3, t''_4$, station T will modify the tuning of its own transmitter in such a manner that it will transmit the impulses in accordance with these latter intervals of time, so the despatch will be received by R_2 , but not by R_1 , nor by any other station that is differently tuned. This is the fundamental principle of the system ; the practical realisation was brought about by Anders Bull, by means of two pieces of apparatus called by him the dispenser and the collector respectively, which work two operations automatically : 1st, of transforming the transmission effected in

the ordinary manner by a Morse key into a series of 5 impulses, separated by the predetermined interval of time; and, 2nd, the recomposition of these 5 impulses into one single signal.

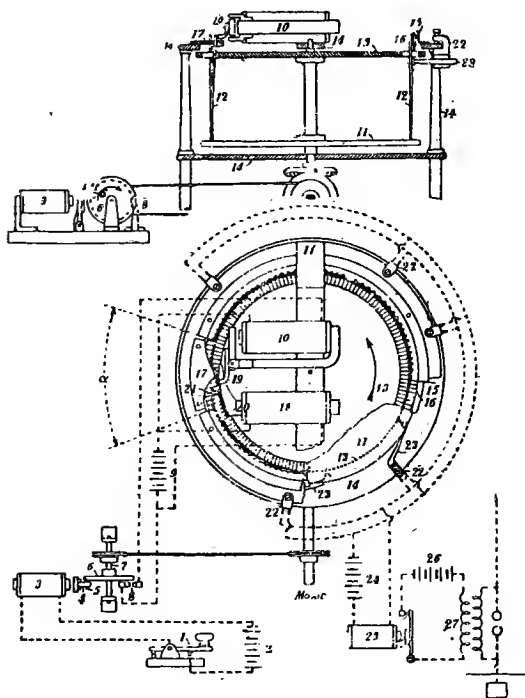

Fig. 226.

At Fig. 226 we have plan and elevation of the parts essential to a transmitting station. On pressing the key 1 a current is sent from battery 2 through the winding of the electro-magnets 3, whose armature is connected to a detent that engages in the tooth of a disc 6; this latter fits by friction on a rotating axis with a velocity of 5 turns per second, and along with which it will rotate every time that

it is free to do so by being released from the detent. When the disc turns, tooth 4 touches the tooth spring 8 and closes a circuit fed by the battery 9, which includes the electromagnet 10; if the key be lowered for a short time only as for the transmission of a dot, the disc can only complete a single revolution, and the last-named circuit receives current only once; if instead the key be lowered for a longer time, the circuit itself is closed several times at intervals of the fifth of a second.

The dispersor consists of a disc 11, to which are attached concentrically a large number of steel springs 12, the upper extremities of which are free, and pass easily in radial slits made in a second disc 13, which leave it free in the radial direction only. The two discs are mounted on the same axis, and they turn with the armature 14, to which is attached a ring 15, that serves as a guide to the springs, so that during the rotation they are compelled to run either along the ring or else in the U-shaped channel on the ring itself 16. A piece of the ring corresponding to the angle d is cut away and replaced by a piece of bronze 17 that bends the springs, inclining them towards the poles of the magnet 18, which is kept constantly energized by the current furnished by the battery 9, thus attracting the steel springs, overcoming their elasticity and keeping them out of their position of equilibrium into the position marked in the figure at 20.

If, however, the magnet 10 be also excited, its tooth and armature 19 withdraws its polar piece, by means of which No. 18 is brought into action, and the springs that at that period of time are passing along the piece of bronze 17, return to their vertical position and become engaged in the Ω -shaped channel at the position 21, not withdrawing themselves therefrom for one entire turn.

A certain number of contacts 22 are arranged all round the circumference of the dispersor already described, each one formed of two springs 23 insulated from each other; by means of screws they can be placed in any desired position. Things are so arranged that the springs that are engaged in the channels establish contact during their rotation, so that during the inactive period of magnet 10, in correspondence with which all the springs pass outside, no contacts are

made. When instead a short current passes round the magnet 10 one spring gets engaged in the channel in the manner described, and this goes successively to establish contact with each one of the pairs of springs that are distributed round the periphery.

The contact springs are electrically connected with one another, as is shewn in the figure in such way that at every closure the current of a battery 24 excites the magnet of a switch 25, the armature of which closes a battery 26 on the primary of an induction coil 27; in a subsequent interruption of the circuit a discharge takes place at the spark gap, and consequently the transmission of an oscillatory impulse is set up, so that at each closure of the circuit of the magnet 10 we get as many transmissions of impulses as there are double contact springs arranged round the periphery of the dispersor.

As the disc rotates with uniform motion, the intervals of time that intervene between the various discharges are proportional to the angular distances, according to which the distribution of the contact springs has been made.

Fig. 227 represents the plan of the receiving station. The oscillations that strike the aerial line 28 affect the coherer 29, and thus the relay becomes energised in the usual manner; the current also affects the magnet of the percussor 31, and the magnet 32 of the collector, the winding of which is put in shunt with the preceding. The collector is of identical construction with the dispersor, so that on the arrival of each oscillatory impulse one spring gets engaged in the channel of the ring 33; the series of 5 impulses having arrived from the transmitting station, brings about the engagement of 5 springs into the channel in question, the angular distances of which are proportionate to the times elapsing between one impulse and the other, because the velocity of this system is kept constant.

On the periphery of the collector are arranged double contact springs, equal in number and in distance to the corresponding springs of the dispersor; these contacts are connected up in series with one another, as may be seen at Fig. 227, so that current cannot pass into the Morse unless all the contacts be simultaneously closed, and this cannot take place if the angular distances between the springs

engaged in the channels of the collector be not equal to those of the fixed contacts. When this condition is satisfied the current can pass into the Morse, giving rise to the impression of a signal, that is to say, of a dot. When the distances between the double springs in the two pieces of apparatus do not correspond perfectly, the movable springs arrange themselves at different distances to the fixed springs; simultaneous contacts cannot take place, and the Morse does not work.

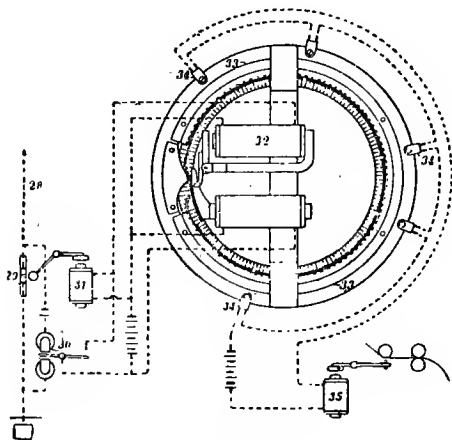

Fig. 227.

The apparatus in its entirety is shewn at Fig. 228, wherein the collector and the dispensor are included in a single apparatus marked *A*, one half of which serves for transmission and the other for the reception of messages. Motion is imparted by means of a little electric motor *B*, whose velocity can be regulated by means of the break shewn at *C*, the disc bearing the steel springs rotates with a velocity of 30 r.p.m.; and bears 400 springs.

The apparatus in Fig. 226 at Nos. 3-8 is shewn in Fig. 228 at *D*, and is likewise set in action by the motor *B*. Finally, the relay is shewn at *E*; it is designed to work very quickly, and is therefore provided with a light lami-

nated armature; it works with a current of $\frac{1}{10}$ th of a milli-ampere.

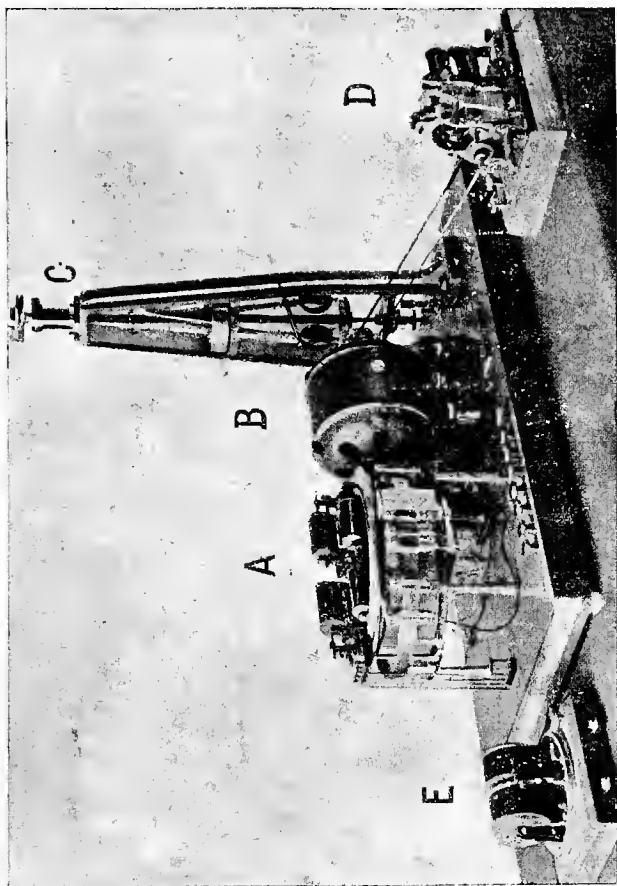

Fig. 228.

Anders Bull has executed experiments with one sending and one receiving station, however, by means of three groups

of different contacts for reception, he has been able to experiment on the transmission to 3 distinct Morse receivers by means of the same manipulator working on 3 distinct transmitters, each one being tuned to one of the receivers.

In the experiments made by the inventor the number of contacts and of impulses constituting each series was 3; the distances were small, and simultaneous transmissions were not attempted. The speed of transmission attained was 50 letters per minute, but the inventor has no doubt that he will be able to increase this with ease. Above all things, he insists on the advantage his system presents of absolute secrecy, and the possibility of applying it to the receiving apparatus of Hughes's printer.

The inventor exhibited with complete success his system in action to the general public in December, 1902, in the Polyteknisk Forening at Christiania.

In order to ensure the secrecy of the system, Anders Bull describes two methods devised by him. The first consists in making the time intervals elapsing between the two impulses of the same series sufficiently long to overcome the period intervening between two consecutive series, which would thus overlap one another.

The other method consists in the simultaneous despatch of signals tuned along with others of arbitrary and different periods; such a method of overlapping would give rise to a series of almost uninterrupted dots, which would be altogether undecipherable.

Walter's System.—This is very similar to the one of Anders Bull just described. In this also every signal consists in a series of impulses or emissions of separate waves, which follow one another at intervals, which are determinate, but unequal.

To this end the apparatus that generates the waves is thrown into action by a special manipulator, which, besides closing the current on the coil, frees a rotating disc and causes it to complete rapidly one revolution, during which by means of certain bosses arranged irregularly along its circumference as many brief closures of the same circuit are established. The other station has, in the circuits of its own coherer, a disc similar to the first one, that is, freed by the effect of the first impulse set up at the transmitting

station, and which round its circumference has contacts arranged in a similar manner to those on the disc of the transmitting station. This latter rotates with the same velocity as the former, so that at every impulse that reaches from the sending station the receiver is ready to receive, allowing it to pass through one of the contacts that go to excite the coherer.

The registering apparatus is so constructed that it will not work unless in answer to impulses of the rhythm corresponding to the number and position of the two rotating discs; so that waves transmitted having different rhythm could not be registered.

Hughes System.—Receivers working under the Hughes system (page 209) may be considered as working by mechanical syntonny, since, in order that registration may occur, it is necessary that the sending and receiving apparatus should have the same speed of rotation. Such speeds may be changed at pre-established times in order to prevent their discovery and any attempts towards surprising the messages by any one interested.

Systems of Multi-communication.

Having obtained the syntonisation of the stations in such a manner that the receiving station will only answer to the wave emitted by a station tuned to its period, it will be easily understood that if there be several receiving stations, each one tuned to a different period of electrical oscillations and whose corresponding length of wave is known at the sending station, this latter can tune its own apparatus in such a manner that the despatch shall be received by one determined station among these, and then modify the tuning in order to communicate with another, the message with the first having ceased and so on.

The problem of multiple communication, that is to say, the communication simultaneously to several stations in any direction and in a similar radius of action, is therefore intimately associated with that of syntonisation. Those systems of radio-telegraphy that have had the largest application were adapted by their inventors to serve to multiple communications, and incessant studies

are still being made in order to obtain this end more completely:

It will be easily understood that a given station will have greater importance, even from the business point of view, in proportion as the number of special stations with which it can communicate be greater.

We will begin with Slaby-Arco's method, because it is the first with which public experiments were successfully executed.

Slaby-Arco's System.—Slaby-Arco's syntony system, described at page 270, is well adapted to establish syntony between a sending station and several receiving stations. In fact, in order that the electrical oscillations at the extremity of the antennae should shew themselves with

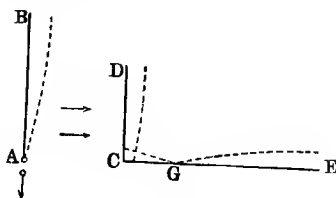

Fig. 229.

equal intensity at the end of the prolongation wire (see Fig. 203 C, page 272), it is not indispensable, according to Slaby, that the portions CD , CE (Fig. 229) be equal, but it is enough that the joint lengths CD , CE be equal to double the length of the transmitting antennae AB , that is to say, equal to half the length of the wave. This means that in the case of inequality between CD and CE , the node, instead of being formed at C , will exist at another point, as for example at G . If, therefore, at the receiving station be placed another antenna CD (Fig. 230), with prolongation wires of different lengths, CE , CF and CG , at the extremity of which is placed a coherer, each one of these will be excited in preference by determinate waves; thus the coherer E , by waves having a length equal to double DC plus CE , the coherer F by waves double DC plus CF and so on, that is to say, that if the length in yards

of the wire are those indicated in the figure, the coherers *E*, *F* and *G* will answer respectively to waves of 240, 200 and 160 yards in length.

If these be emitted by different stations, the apparatus will register separately the despatches emitted by them, and will lend itself therefore to multiple communication.

Naturally, equivalent coil bobbins may be substituted for the prolongation wires, and corresponding multipliers may be added to them, as in the Figs. 203 *D* and *E* at page 272. The intensity of the ventral segment of vibration in *E*, *F*, *G*

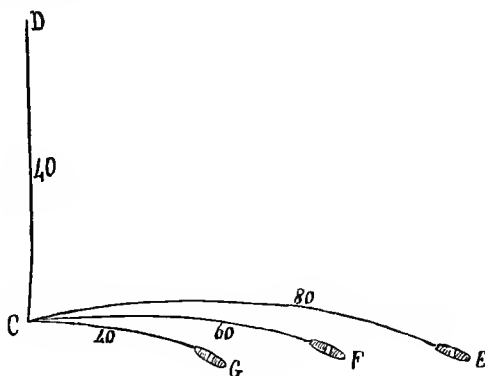

Fig. 230.

depends only in a small degree in the point *C* being or not being in communication with earth; therefore, as the receiving antennae may be used, any conductors already existing, even lightning conductors, provided they have not the length of a quarter of a wave.

It was in fact with an apparatus constructed on this principle that Slaby demonstrated publicly in 1900 his system of multiple communication with wireless telegraphy, of which we shall treat further at Chapter X.

Our Fig. 231 is a plan of the arrangement given by Slaby for this experiment. The receiving apparatus which stands in the middle has a single antenna a_2 and a'_2 , which on one side is joined by means of a self-induction coil *S* to the

coherer f , and on the other side by the induction coil S^1 with the coherer f^1 . The period of the system $a_2 S f$ is tuned with that of the transmitter a' and the period of the system $a_2 S' f'$ is tuned with that of the transmitter a' ,

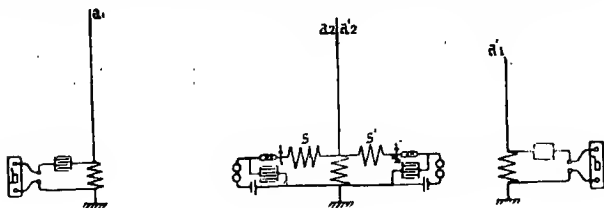

Fig. 231.

differing from the first, so that the former receives only despatches sent by a' , while the latter only those sent by a_2 .

Later on, in order to ensure better tuning in the stations,

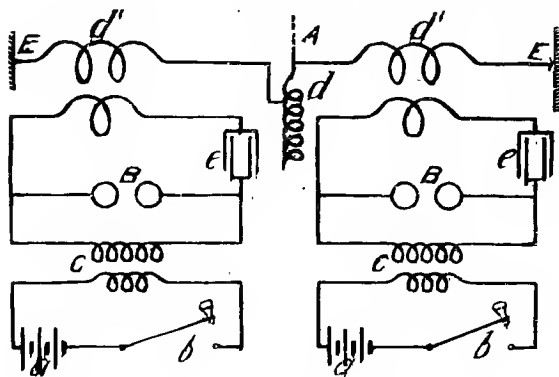

Fig. 232.

Slaby-Arco adopted the use of the tuning described at page 157.

The Marconi System.—Marconi's syntonic system likewise lends itself to multiple communication, and at Fig. 233 is represented the arrangement of a sending station capable of

communicating with two differently tuned stations. Instead of modifying at the instant of correspondence a capacity and the inductivity of the sending station, in order to tune it with the receiver, Marconi, for greater facility and certainty of action, causes conductors of different capacity and inductance to be thrown into contact with the antenna *A* of the sending station, as is shewn in the figure, these being tuned with as many transmitters, which in their turn are tuned with one or the other of the stations with which it is desired to communicate; communication with the several stations can therefore be kept up simultaneously.

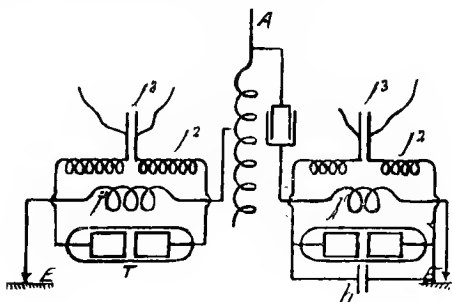

Fig. 233.

Marconi also attains multiple transmission between two determinate stations, that is to say, the simultaneous transmission of several despatches from a single antenna, by connecting to the antenna of the receiving station inductances respectively equal to those connected to that of the multiple sending station, each one being joined to a receiver tuned to it, as is shewn at Fig. 233; by this arrangement each transmitter connected to a single vertical wire can simultaneously transmit different despatches, and these being received also simultaneously, each one by the corresponding apparatus of the receiving station, which is tuned with the respective sending apparatus.

In 1901, during the experiments on simple communication between Biot and Calve, of which we will speak later on (see Chapter X.), experiments in multiple communication

were also made, with little success, however, by using three different tones, No. 1, No. 2 and No. 3, equal respectively of 300, 150 and 70 metres of wave length. By using different antennae, messages made with tone No. 1 were not registered by the receiver tuned to No. 2 and *vice versa*, but on using the two receivers joined to the same antenna they were influenced by both, unless in one of them self-induction coils and capacities sufficient to silence them were introduced, and in the transmission trials one of the receivers registered one or other of the despatches, while the other either registered both or neither. The introduction of tone No. 3, which was made in order to render the selective power greater, did not better these results, because the new receiver that should have registered shorter waves, was not affected.

The experiments in this direction made in May 1903 by Lieut. Vilarey of the Royal Italian Navy, between the station of Spezzia and that of Palmaria at a distance of 3 miles, and of Leghorn to a distance of 50 miles, gave better results. The apparatus at the sending station emitted waves of two different tones, the one *A* fitted for a distance up to 100 miles, and the other *B* intended for a distance up to 200 miles, both the intensity of the source of energy and the capacity of the condensers is doubled in the latter case, consequently also the length of wave emitted as compared with the former. The two tuned receiving apparatus for these tones, both communicated with a single antenna at Spezzia, were able to receive simultaneously telegrams from Palmaria and from Leghorn, not only when the tone of the longer wave was acting from the more distant station, but even when the emitted tone was reversed at the two stations.

Messages were also successfully transmitted with a single antenna simultaneously to Leghorn and to Palmaria. When Marconi was interviewed in his last journey to Rome, he declared that he had succeeded in November 1903 in transmitting at one and the same time from a single station (Poole on the English coast, near London) 5 distinct telegrams to 5 several stations situated in the neighbourhood within a radius of from 14 to 30 miles. In the sending station the 5 differently tuned pieces of apparatus communicated each one to a special antenna, and the despatches

reached their destination without the slightest confusion. He declared besides that he was in possession of 25 tones, each one quite distinct, with which he could communicate simultaneously and independently with so many stations.

Tommasi's System.—The method proposed by Tommasi tends to maintain secrecy in correspondence in cases where tapping was attempted by a station furnished with very sensitive receivers, such as might be able to respond to all kinds of electrical vibrations, whatever might be the nature of their intonation. It consists in fitting the transmitting stations with two oscillators, of which one being more powerful for the syntonic transmission of signals to a greater distance and the other of lesser power, the scope of which is to emit incoherent signals, which, overlapping those intended for greater distances, mix themselves up in the surrounding zone with those of the signals of the true correspondence, but which are incapable of acting in consequence of their lesser intensity on the tuned receiver at a distance, with double oscillators of different powers, that is to say with different lengths of spark, communication can be established at will with stations at different distances. This system, however, does not guard against the receivers which may be placed beyond the zone, in which the vibrations of the lesser powerful oscillator reach a zone which may be diminished by gradually diminishing the sensibility of the coherers.

Jegou's System differs from Tommasi's system just described, inasmuch that while the former depends on varying the carrying power by altering the length of spark, Jegou arrives at the same end by altering the lengths of the antennae. In each of the receiving stations are two antennae, one long and one short; the former has precisely the length necessary to enable it to communicate to the maximum distance decided upon. The two antennae are in communication with two distinct circuits, each comprising a coherer, a battery and a coil. These two coils are wound in opposite directions around the common core, and they constitute the primary of a transformer, the secondary of which communicates with a relay or a current protector. When the waves emitted by the farther station arrive, these influence only that primary coil which is connected to the

taller antenna, and the despatch is then registered, but if waves arrive from a near station, these latter influence both the bobbins, which being opposed annul one another's action.

When, on the other hand, it is desired to communicate with a nearer station, use is made at the transmitting station of a shorter antenna, so tuned that the shorter waves act only on the taller antenna at the receiving station.

The Magni System.—Magni considers that syntony alone is not sufficient to ensure multiple communication, because even perfectly syntonised stations do not answer *only* to the waves of the period for which they were tuned, but also to those of periods near to them, the same as occurs in acoustics, with a resonator, which, on being tuned to a certain note, will answer also to a note a little higher or a little lower than its own. He therefore proposes to utilise for this purpose besides the principle of syntony, that of the interference of waves (see page 87), according to which two waves of equal periods that join together after having traversed spaces of different lengths may, according to the point in which union takes place, either add the sum of their effects together, producing a maximum effect (centre of vibration), or annul one another (vibration node).

In order that the coherer should be affected, it is not sufficient that it be in a circuit syntonised with the transmitter, but also that it be placed at the ventral portion of the wave. And since the position of the ventral portion varies with the length of the wave received, so a coherer placed in a given position will be for these two reasons unaffected by the length of wave different from those to which it is tuned, and can therefore, among all the waves that may strike upon it, discern only those which are directed to it.

To carry out this purpose Magni proposes the use of two antennae at the sending station and two at the receiving station. At the sending station the two antennae are placed at half a wave distance apart, and are traversed by the waves of equal period, strength and phase, that is to say without any lag between the one and the other (see page 136). These waves propagate themselves in every direction; but in the plane that includes the antennae, the waves that

arrive from the two antennae interfering with one another destroy each other, and in this plane their effect is annulled, while in the plane perpendicular to the first, that is directed in the position in which telegraphy is taking place, the effect is at the maximum.

This gives us also another means of obtaining "guided" waves (see page 132 *et seq.*). The use of the double antennae at the receiving station is most interesting. The feet of the two antennae are joined together by a wire that extends from the two parts, constituting two prolongation wires. The length of the two antennae and of the prolonga-

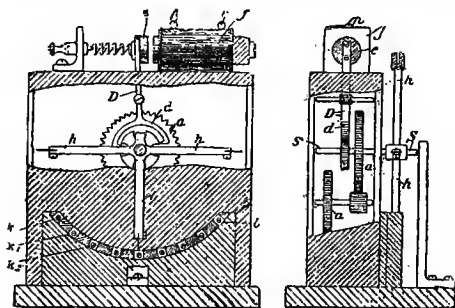

Fig. 234.

tion wires and of the adjoining wires may be so chosen that at the middle point between the two antennae the wave to which the coherer is tuned should form a segment of vibration, while those waves whose length differs even by a little form there a node. The coherer is placed at that precise spot, and therefore cannot be influenced by any wave not directed to it. The desired effect is obtained by giving, for instance, to the antennae and to the prolongation wires lengths equal to a quarter of the wave, and a distance of half a wave length between the two antennae.

Magni made privately experiments at distances of from a mile and a half to two miles with very successful results, ensuring independent action at the different sets of stations.

Cohen-Cole System.—In order to solve the problem of multiple communication, Cohen-Cole adopted an arrange-

ment similar to that which is used in certain systems of multiple telegraphy, in which by means of an apparatus called a selector, communication is set up between several pieces of transmitting apparatus, one after the other at short intervals, with the antenna, while at the other stations an identical selector running at the same rate as the first fulfils the same function for an equal number of receiving apparatus.

Fig. 234 represents one of these selectors proposed by Cohen and Cole, which is built up of brushes h that, induced

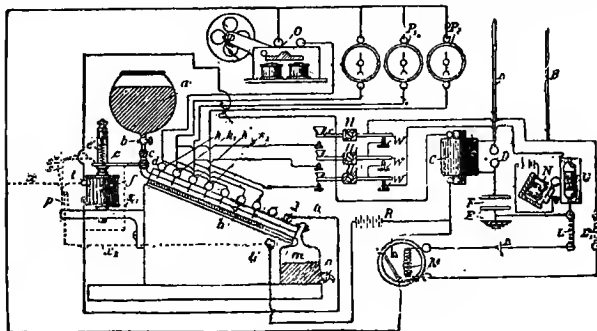

Fig. 235.

with a rotary motion, rub on a series of contacts $K K_1 K_2 \dots l$ arranged as the arc of a circle, placing thus successively in contact the sending station with one or the other of the receiving apparatus.

Another system of selectors represented at Fig. 235 utilises the fall of drops of mercury along an inclined insulating tube, wherein establishes momentary contacts between a conducting strip h arranged along the tube and a series of platinum points $k k_1 k_2 \dots$ that are connected up to the different telegraphic apparatus. Special devices serve to keep up between the distributors of the two stations perfect synchronism, so that each transmitting apparatus is placed in communication each time with its own receiver, and if the turn be repeated with sufficient rapidity, each transmitter can communicate with the corresponding receiver just as well as if the communication were continuous.

CHAPTER X.

PRACTICAL EXPERIMENTS AND APPLICATIONS.

IN our description of wireless telegraphy systems, we have taken an author's privilege and followed that order which caused the mechanical improvements imported by the different inventors in their apparatus to stand out with the greatest clearness. In the following descriptions of experiments, we shall follow as far as is possible the chronological order, which will allow us to weave the history of this marvellous conquest made by man over the laws of Nature.

What was the first experiment in wireless telegraphy by means of electric waves? A long time ago there appeared a number of an old French Journal *La Liberté* of the 26th April, 1876, in which it was announced that a certain Loomis, an American meteorologist, in some experiments made in the Rocky Mountains, had succeeded in transmitting signals by means of kites, the strings of which contained a conducting wire, and which were at a distance of about 10 miles the one from the other. The signals were transmitted and received by means of a Morse apparatus, but no more is known as to these experiments, so that it is doubtful whether a true transmission by electric waves had been effected, and it is not risking too much to say that the reality of the news itself is involved in doubt.

On the other hand, the experiments in telegraphy which were undertaken by Hughes in 1879 are to be attributed to electric waves. Hughes is the celebrated inventor of the printing telegraph (page 209) and of the microphone (page 183). His experiments, although carried out in the presence

of many scientific men, were not made public until some years after, that is to say, when wireless telegraphy on the Marconi system had already reached a fair development.

Hughes had observed that a telephone inserted in a circuit with a microphone (without the usual battery) gave out sounds when an induction coil was being worked at some yards from it, and that the effect was due to the extra currents that were produced at every interruption of the current that supplied the coil.

The same effects were produced by the discharges of an electric machine, and even at that time Hughes attributed them to the electric waves set up by the discharges and which propagated themselves in the ambient air-waves, the existence of which was experimentally shewn 8 years later by Hertz.

Hughes with his microtelephonic contact, which evidently acted as a self-decohering coherer, was able to perceive sounds produced by the wave emitted by a coil in action, not only through the whole distance possible in his dwelling, consisting of several storeys, but was able to take cognisance of them to a distance of about 600 yards by walking up the street in which his house was erected, while keeping the telephone to his ear and the receiver in his hands. Not having been able to give a scientific demonstration as he desired, as to the true nature of the phenomena, he did not publish these experiments, the explanation of which as divined by him was found afterwards to be in perfect accordance with the successive experiments of Hertz and Marconi.

With the exception of these experiments which remained as isolated facts and unknown to the scientific world, we find no notice of any method of wireless telegraphy until we come to that first fruitful germ arising from the experiments of Hertz in 1887. It certainly may be said that on the day in which Hertz was able to draw from his resonators the first sparks without direct communication with the oscillator, the basis of wireless telegraphy was laid, since shortly afterwards Hertz himself carried out an experiment, the result of which, although foreseen by him, filled him, as he says, with emotion; he carried his resonator into a neighbouring room to that in which the oscillator was placed; he closed the

door, and he noticed that at every spark produced in the former, a corresponding spark was emitted at the latter. Perhaps Hertz did not know how to work the Morse key, but the humblest telegraphist who had been present at that experiment would immediately have found himself in a position to have transmitted by that means a message embodying the greatness of the discovery which enabled conventional language to be transmitted without wires

But it never entered Hertz' mind to turn his discovery into a commercial success, he wished only to follow out the scientific conceit which had guided him to a great discovery, that is to say, of shewing experimentally the identity in the behaviour and the nature of electric and luminous waves, and he succeeded in this intent, thus opening out a wide field to science by the conquest of truth ; and to humanity by the conquest of the useful. Righi and Marconi, not to speak of others, launched into this field, each one guided by his own ideal in order to move towards the two conquests, each gathering laurels of equal value, and if those offered to the former have attracted less notice than those that have fallen to the lot of the latter, it is simply because the ranks of those who follow after truth, do not amount to the huge phalanx of the admirers of the useful.

The waves with which Hertz had to do were 10,000,000 times longer than luminous waves ; to these gigantic waves was wanting, so to say, that agility which allows the latter to reproduce the most delicate optical phenomena. In the hands of Righi these waves became smaller, thus acquiring the required degree of agility to be able to reproduce with apparatus not much larger than those which are made use of in ordinary optical experiments, all those delicate evolutions which manifest themselves to our eyes under the forms of the most complicated luminous phenomena. This gave rise to that interesting work by Righi, which he happily named *The Optics of Electric Oscillations*.

Marconi, a friend of Righi, who was admitted into his laboratory to participate in some of the experiments therein conducted, and it is probably there that, having seen with what facility the Righi resonators responded at a distance to the oscillations of the exciter, as in the above-cited Hertz experiment, conceived the idea of attempting by means of

electric waves the solution of the problem of telegraphic communication without wires, a problem that had been with great ardour studied in England, where he had often been since his childhood, and where this problem had already been partly resolved with the establishment of wireless communication, by induction, between Lavernock Point and the lighthouse of Flatholm at a distance of about 3 miles (see page 41).

The field was already ripe for the great discovery. Two years before (1894) Lodge had announced that his coherer was so sensitive to electric waves as to reveal them at a distance of half a mile, and one year before Popoff had applied the coherer to the reception of the electric waves set up by a Hertz oscillator at a distance of about 3 miles with the apparatus described by us (see Fig. 41), which had all the organs necessary for a wireless telegraphy receiver, viz.: antenna, coherer, choking coils, relay, decoherer and printer. Nothing was now wanting but the man who could and would dedicate himself to the complete solution of the problem; a man gifted with a powerful genius and of prodigious activity. This man was Marconi.

Marconi made his first trial in his own villa near Bologna, with such apparatus as he could get together from the appliances in the household. Little or nothing is known of these experiments, which must have simply gone over the beaten track of his predecessors. In fact, the first patent taken out by him (No. 12039, 2nd June, 1896, of the English Patents) shewed as a transmitter the three-spark Righi oscillator (see page 119) and a receiver built up like Popoff's (see page 83). The modifications which were successively introduced by him into his apparatus, among which principally was the introduction, even in the transmitter, of the antenna which in Popoff's apparatus figured only in the receiver, have already been amply described and discussed by us in another part of the present volume (see page 226 *et seq.*) along with other apparatus proposed and perfected by other experimenters, from which we can only imagine the results of more important experiments carried out with them, and which gradually led to the transmissibility of radio-telegrams from distances of a few miles to such enormous ones as over 3,000 miles.

We shall first describe the experiments as to communication between land and sea only, reserving for later on the results of multiple radio telegraphic experiments in mountainous regions, with balloons and other appliances.

Marconi's Experiments at London and on the Bristol Canal, 1896.

After the private experiments made at Bologna, in which he succeeded in getting messages through a distance of 2,400 metres (about $1\frac{3}{4}$ mile) Marconi came in July 1896 to England, where he explained his system to W. Preece, the Director of the English telegraphic system, who had already devoted several years and many experiments to the study of wireless telegraphy, from terra firma to the lighthouses by means of the close circuit induction system described at page 39. Preece received the young inventor favourably, and made with him the first experiments in London in the summer of 1896 from the rooms in the Post Office to a station at about 90 yards off, and then to Salisbury Plain at a distance of 4 miles.

Preece, in a meeting held in London, called attention to these results, which, although obtained with the rough appliances constructed by Marconi, gave promise of a large application in the future. At the meeting Preece presented the apparatus, but he really did not shew anything beyond the two boxes in which they were contained, declaring that he was not at liberty to divulge the details of the apparatus. He said, however, that he was using an induction coil, giving a 10" spark, along with a Lodge oscillator and a parabolic reflector. The transmitter and the receiver were, as appeared afterwards, of the type represented in our Figs. 151 and 152 (pp. 221 and 222). The news spread rapidly, in consequence of which, even before Marconi had given publicity to the construction of his apparatus, many experimenters basing themselves on what was already known of the means of producing and receiving electric waves, immediately repeated experiments in wireless telegraphy, with apparatus that were afterwards recognised as being analogous to those of Marconi.

Among these experimenters we may mention Lodge, who

in September invited the members of Sec. A of the British Association to assist in his laboratory in experiments which gave results similar to Marconi's, with an apparatus set up for that purpose by his assistants; Ascoli, who in April 1897 held a meeting in Rome for the study of the same subject, demonstrating experimentally the possibility of telegraphing with electric waves; and Tissot, in France, who executed his experiments the day after the announcement of those of Marconi.

In May 1897 comparative experiments between the Marconi and the Preece induction system, which was already being worked experimentally on the Bristol Channel (see Fig. 18, p. 41), near Cardiff, between Lavernock Point and the little islet at Flatholm, with its lighthouse, to a distance of about $3\frac{1}{3}$ miles, also from the coast and between Lavernock Point and Breamdown, situated on the other side of the Channel, at a distance in a straight line of about 5 miles in the first case and $8\frac{3}{4}$ miles in the second. In these experiments the apparatus shewn at Figs. 154 and 155, page 225, were employed, in which reflectors were replaced by aerial lines supported on poles 27 yards in height, having terminal plates for capacities.

The waves used were calculated to have a length of 48 inches, and a frequency of 250 millions per second. The sending station was at Flatholm, where a coil giving about 20" spark was employed, this being fed by a battery of accumulators.

On May 11th, 1897, after having experimented on the Morse plan, trials were made to communicate between Flatholm and Lavernock on the Marconi plan, which began to work as soon as the aerial lines had been raised to 25 yards, and gave completely successful results with a farther raising of the wires.

On May 14th communications were also established between Lavernock and Breamdown, and the experiments were continued. All these experiments, besides demonstrating the practicability of the system, shewed the influence that the height of the antenna had upon the distance to which the message can be transmitted. As the result of these experiments, Marconi formulated the law, already noticed by us (see page 123), which governs the relation

between the height of the antenna and the distance of transmission.

Preece, speaking of these experiments before the Royal Institution on the 4th June, 1897, pointed out that it was curious that hills and other apparent obstacles did not hinder transmission, probably because the lines of force avoid these obstacles; that weather apparently had no influence on the regularity of the transmission, which were effected equally well during fog, rain, snow and wind.

In the meanwhile, Marconi had covered his invention by patents, and in August 1897 a Company with a capital of £1,000,000 was formed under the name of the Wireless Telegraph and Signal Co. in order to work the same.

Marconi's Experiments at Rome and at Spezzia, July 1897.

In June 1897 G. Marconi went to Rome, and after having undertaken in this city, at the instigation of the Minister of Marine, several experiments from one floor to another with a conductor three yards in height, was invited by the Hon. Brin, Minister of Marine, to undertake in the presence of a select commission composed of officers who were specialists, belonging to the Royal Marines, some fresh experiments. The place chosen was the Gulf of Spezzia. The experiments took place between the 11th and the 18th of July, 1897. The apparatus made use of for transmitting and receiving was similar to those employed on the Bristol Channel, that is to say, aerial wires ending above in metallic sheets (Figs. 154, 155, page 225). The coil was less powerful than that used in the former case, giving sparks 10" in length only.

The transmitting apparatus was located during the entire series of experiments (fig. 236) in the electrical laboratory of St. Bartholomew, and bore an aerial line about 75 feet in height, which was afterwards prolonged to 90, terminating in a square metal sheet of about 8 feet in the side.

On the first three days, viz., 11th, 12th and 13th of July, the experiments were executed on land, which gave very good results up to a distance of $3\frac{1}{2}$ kilometres, or say 2 miles;

on the 14th of July the receiver was set up on board a tug, having a mast about 50 ft. in height, which bore an aerial wire of equal length ending in a sheet about 8 feet in the side.

The transmitting station was bound to carry out the following instructions :

Ten minutes after the start of the tug, it was to send for 15 minutes dots and dashes at intervals of 10 seconds ; then transmit a phrase, maintaining between each signal an interval of 10 seconds ; then to suspend transmission for an interval of 5 minutes, after which it should go through

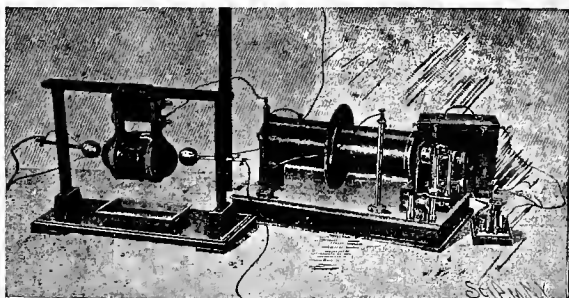

Fig. 276.

the same round, but with intervals of 5 seconds instead of 10 between each signal.

The tug having started from the little port of St. Bartholomew, the receiver registered some signs even before transmission had begun on land, a fact due doubtless to extraneous causes. She directed her course towards the western mouth of the mole and continued to receive signals, not, however, in the order and in the intervals that had been pre-arranged, but much more frequently. The sky was covered with stormy clouds and in the distance lightning was frequent, hence it was surmised that besides the signals that were really transmitted, others due to atmospheric influence were impressing themselves, which rendered the strip of paper on which they were registered illegible.

On again repeating these experiments after the storm clouds had disappeared, correspondence came out very clearly up to a distance of 5500 metres (nearly 3 miles) with the tug stationary. The tug was again put in motion, so as to interpose between itself and the station at St. Bartholomew the point called Le Castagne, in order to ascertain what effect such a screen would have on signalling.

The signals ceased as soon as the obstacle intervened, to re-commence on the tug being moved from its influence. On the return journey, the messages continued to come out clear and exact.

On the 17th July trials were made from the same stations of St. Bartholomew to the armoured ship San Martino, anchored at a distance of about $1\frac{3}{4}$ miles from the transmitting station, the aerial conductor of which had been carried to a height of about 40 yards, while the ship bore at the receiver an aerial line first of 20 and then of 30 yards in height.

Transmission succeeded perfectly, independent of the position of the coherer and the receiver, that is to say, even if they were screened at the sending station and surrounded by metallic masses under cover or placed below the water line in the ship.

On the following day experiments were made with the San Martino in motion, with the result of obtaining perfect transmission up to a maximum distance of 16,300 metres (equal to about 14 miles). But the interposition of the island of Palmaria caused all communication to cease completely, notwithstanding that the distance was only about half that which lay between St. Bartholomew and the ship, when it was not covered by the island, being distant from it only about a couple of kilometres.

From these experiments it would appear that the masts of ships, the funnels and the bridge, when they interposed themselves between the receiving wire and the sending station, lowered the speaking distance to about $6\frac{1}{2}$ kilometres, say 4 miles. The useful speaking distance both in the case of the tug and the armoured ship was found to be less on the return journey than on the out journey. This was partly due to the screening effect of the masts and the

yards between the aerial line and the sending station, but also in part to the variation in the position of the two antennae wires, which, instead of being vertical, formed somewhat oblique curves, which came nearer to parallelism in the outward journey than during the return.

Experiments with Other Systems.

Lodge and Muirhead's Experiments.—Whilst Marconi sought to perfect his apparatus by basing himself on the results of previous experiments, Lodge and Muirhead were laying those scientific bases that were to conduct to further improvements, among which the first place must be given to the principle of syntony. We have seen that in the first system of radio-telegraphy which bears their name (page 244), by the means of appropriate self-induction coils and capacities in the oscillator and in the receiver, and by the separation of the coherer-circuit from the receiving antenna, the syntonisation of the two sets of apparatus has been rendered possible. If from the theoretic side the Lodge-Muirhead apparatus on the first system have great importance (as in them are to be found the germs of the most perfect system of radio-telegraphy of to-day), it does not appear that the inventors made with these apparatus any experiments on a large scale.

The Experiments of Slaby in Germany (from September to October, 1897).—These experiments on wireless telegraphy were repeated in Germany as soon as Slaby had returned from England, where he had taken part in several of those instituted by Marconi on the Bristol Channel (see page 335). The apparatus employed was similar to that of Marconi. After some successful trials of transmission from Charlottenburg to neighbouring localities, others on a larger scale were attempted in the Imperial Gardens of Potsdam. The transmitting station was placed under the portico of Sacrow Church (Fig. 237), where it was joined by means of a metallic wire with a rod extending from the extremity of the platform of the belfry at a height of 25 yards.

The receiving station was fitted up in the neighbourhood of the Glienicke Bridge on the river Havel at about 12 miles from Sacrow Church, and an aerial wire of about 28 yards

height supported by a vertical pole. As may be seen from Fig. 237, the antenna employed in this experiment was wanting in the terminal metallic sheets employed up to that time by Marconi, and which were afterwards abandoned by him (see page 224).

As a rule, transmission was effected perfectly, except only when the wire from the transmitter was carried behind or close to the trees, since, according to Slaby's opinion, the wires from the two stations should be visible the one from the other, it sufficing that the sails of a ship or the smoke of a steamer should intervene between the two wires in order to impede the signalling.

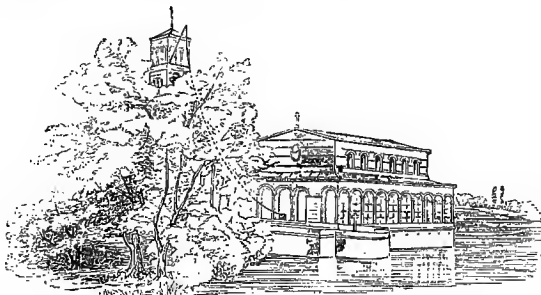

Fig. 237.

In October 1897 Slaby instituted experiments in transmission over open ground, between the polygon of Schoeneberg near Berlin and the military station of Raugsdorf at a distance of about 16 miles, which was arranged as the receiving station. As antennae, copper wires of about 320 yards in length, supported by captive balloons were employed, these, however, being distinct from the steel cables that were used to retain the balloons.

Excellent communication was possible in fine weather, but atmospheric electrical perturbations rendered experiments in bad weather dangerous. It was ascertained, however, that the devices employed in ordinary telegraphy to combat the danger of atmospheric discharges were also valid in the case of wireless telegraphy.

These experiments demonstrated for the first time the

possibility of telegraphing to great distances with electric waves even on land; in fact, such communications were established on an open plain at a distance of 21 kilometres (about $16\frac{1}{2}$ miles), whilst the record distance reached at that time was that of 16 kilometres (12 miles), obtained during the experiments at Spezzia on the open sea.

It is to be noted that the intensity of the action of the waves on the coherer in these experiments was such, that Slaby considers that instead of requiring a wire of 300 metres in length, one of 100 would have been sufficient as an antenna.

Experiments made in 1898 and 1899.

Marconi's Experiments, 1898.—The principal aim of these was to ascertain the practicability of the system for a prolonged service, under the most varied atmospheric conditions, or other difficulties that might present themselves in work. The greater part of the apparatus was the same as that used in the Spezzia experiments, only that the use of metal plates or cylinders at the upper part of the antennae was discarded, as also the employment of the 4-ball Righi oscillator, which was replaced by one having only 2 balls, in air, each one 1" in diameter and $\frac{1}{3}$ rd inch apart, whilst the coil was capable of giving a 3" spark.

At the beginning of the year a couple of experimental stations were erected between Alum Bay, near St. Katharine's, Isle of Wight, and Bournemouth, at a distance of about 18 miles, which was afterwards extended to 21 miles by transferring the Bournemouth station to Poole in Hampshire; the aerial wires and antennae were at first about 40 yards in height, but afterwards, as the apparatus was improved, this height was diminished to 25 yards. During fifteen months' continuous experimenting, between one and other of them, and also between the Isle of Wight and a steam-ship having a mast 60 feet in height, signals were obtained at distances of 17 miles; and it was ascertained that bad weather or electrical conditions of the atmosphere did not arrest or seriously affect the working of such an installation. It was found possible to transmit on an average one thousand words in both directions per day.

During July of the same year the wireless Company put into execution a novel kind of service directed by Marconi in person, which had found great application in the daily papers; that is to say, he was entrusted with the work of supplying to the *Dublin Daily Express* from oversea the incidents occurring during an interesting regatta that took place at Kingstown.

The wireless despatches were transmitted from the tug "Flying Huntress," that followed in the wake of the regattas, to a land station furnished with antennae of about 100 feet in height, and thence were telephoned to Dublin, to be published in the evening editions. On board the tug, the transmitting apparatus that was in the captain's cabin communicated with antennae having a height of 70 feet. In this manner the relative positions of the various yachts were telegraphed up to a distance of 12 miles from the land station, whilst the races were taking place, and were published long before the yachts had returned to port.

During the days that this system was in use, 7000 despatches were sent between the tug and the land station. On trial at greater distances, it was found that with an antenna 75 feet long on board, and another of about 120 feet in height on land, it was possible to communicate up to 25 miles distance, points between which the curvature of the earth intervenes considerably.

Among the other services fulfilled by the Wireless Company in that same year, the one which took place between the Royal yacht "Osborne," with the Prince of Wales on board, and the Queen's residence, Osborne House, is also very interesting, and this was effected not only whilst the yacht was anchored at Cowes Bay (about 2 miles from Osborne House), and which was not even visible, as the hills of East Cowes lay between, but also during the frequent excursions that the Prince made in open sea.

During these experiments perfect communication was obtained up to a distance of 8 miles, notwithstanding the interposition of hills of over 150 feet in height that masked the two stations, including the extremities of the antennae. The antenna on the yacht rose to a height of about 75 feet above the deck, that erected at Osborne House was about

120 feet in height, the average speed of transmission was 15 words per minute.

On the Improvements in the Apparatus.—Whilst in these and other applications the Marconi Company was perfecting the details of the radio-telegraphic apparatus on the basis of the experimental results obtained, the problem of long distance transmission by means of electric waves was being theoretically studied by many scientific men, such as Lodge, Braun, Slaby, etc., who applied the principles of the theory of resonance, already known to science for the applications that had already been made of it, first to acoustic resonance, and later on to electrical resonance.

Marconi had had more particularly in view improvements in the receiver, and in fact it was in June 1898 that he made application for the patent of the receiver represented at Fig. 162, page 233 (without the rod A'), in which the wire of the receiving antenna is insulated from that of the coherer, and acts upon this by simple induction; and is controllable as regards the period of the coherer circuit. But in the meantime, specially after the studies of Braun, it had been recognised that it was necessary to modify reasonably the transmitter circuit with a special view of diminishing the too rapid damping of its oscillations, for which reason Marconi, in the summer of 1898, carried out the first experiments with the transmitting apparatus (which he afterwards patented in October of the same year) constructed on the plan of Fig. 164, page 236, with a closed circuit oscillator acting by induction on the wire of an antenna, tuned to the same periodicity. The principal resonance thus applied to the transmitting apparatus figures also in the apparatus patented by Marconi in 1900.

Marconi's Experiments on the Channel.—Between March and June 1899 the Marconi Co. were anxious to establish communication between France and England across the Channel, to the end of shewing the French the practicability of the system. The stations chosen were Wimereux, on the French Coast, 5 kilometres north of Boulogne (about 3 miles), Fig. 238, and the electrical workshop of the South Foreland Lighthouse (see Fig. 239), at a little over 4 miles east of Dover, on this side of the Channel (see map, Fig. 240).

Marconi preferred these stations to Calais and Dover, because their distance was 46 kilometres (about 27 miles), whereas the distance between Dover and Calais is only about 20 miles, and therefore but little greater than the distance between the two permanent stations of Poole and Alum Bay (page 342).

The Marconi Society obtained the necessary authorisation to set up their installation in February 1899, under the conditions that a French commission should assist in all the

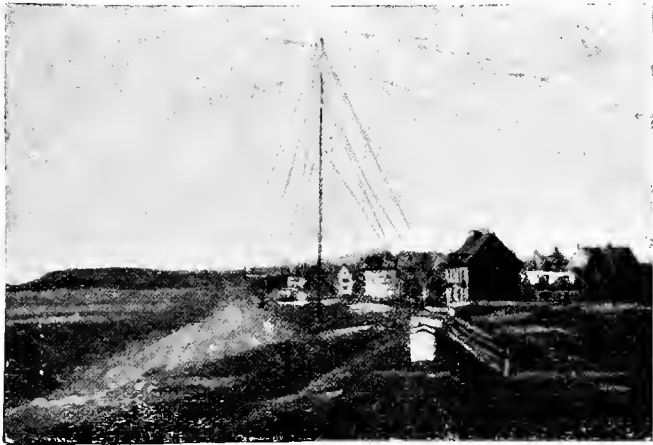

Fig. 238.

experiments made, and that the French station should be destroyed on the completion of the trials.

The two antennae were distinctly visible the one from the other, and first had a height of 150 feet, which was afterwards reduced to 110, which appeared to be the lowest limit for successful working. The wires of the antennae were doubled by means of a second conductor connected in parallel with the first. Besides these, there was to the east of the South Foreland, and at a distance of about 12 miles, a third station that had been installed a month or so before on board the lightship "E. S. Goodwin," and which was

destined to transmit regular messages from this ship to the coast; the antenna of the Goodwin was 75 feet in height, the ship, the spars and the yards were all in iron. The receiving apparatus were built up on the plan of Figs. 159 and 160, pp. 229 and 230, and the transmitters had undergone no essential modification from those used in the experiments at Spezzia, that is to say, they were in the conditions shewn at Fig. 157, page 227, with the two exciter balls in direct communication, one with the antenna and the other to earth.



Fig. 239.

Preliminary trials were made on board the despatch boat "Ibis" (Fig. 241) and the transport "Vienne," the first having antennae 66 feet in height and the other 100 feet in height. The results were as follows:

The communications between South Foreland, Wimereux and the Goodwins, and *vice versa*, have always been most satisfactory whatever the weather, be it cloudy, windy, rainy or tempestuous. The communication between the moving stations (the "Ibis" and the "Vienne") and the three fixed stations have likewise been very good, whether the ships

were stationary or in motion. The maximum distances reached were: Between the "Ibis" and the Goodwins, 14 miles; between the "Ibis" and the South Foreland, 16 miles; between the "Ibis" and the South Foreland, 30 miles; between the South Foreland and the "Vienne," 33 miles.

The reason for which in these two latter cases communication in one direction could be effected at a greater distance than in the opposite, depends, according to Marconi, upon the fact that the receiver of the "Vienne"

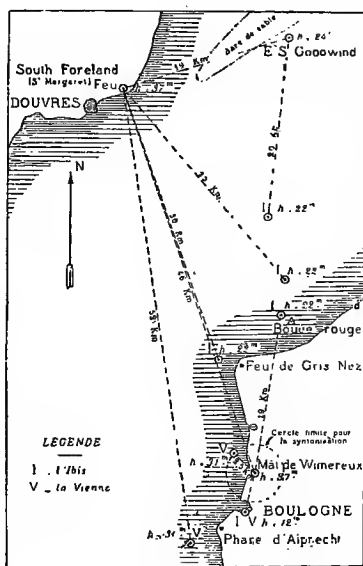

Fig. 240.

was regulated to the highest sensibility, whilst that of the South Foreland had been adjusted only to communicate with Wimereux at the distance of 46 kilometres, and was therefore not sufficiently delicate for distances that were greatly superior.

Besides these experiments on simple communication in the open sea, others were made with the interposition of obstacles, thus the "Ibis" being placed near the red buoys to the east of Cape Gris Nez at 19 kilometres from Wimereux (see Fig. 240), it was possible to exchange telegrams between the two stations notwithstanding the interposition of the mass of Cape Gris Nez at a maximum height of about 100 metres (say 120 feet).



Fig. 241.

In like manner the "Vienne," anchored in the port of Boulogne, was able to communicate with Wimereux at about 3 miles distance with antennae of the respective heights of 12 and 37 metres, notwithstanding that the mass of the Creche lay between to a height of about 75 metres (80 yards), besides all the electrical wire works existing in the port of Boulogne.

It was also intended to have carried out some experiments in multiple communication with receivers tuned to different vibrations, but owing to Marconi having fallen ill the definite experiments did not take place.

In the month of September of the same year (1899), on

the occasion of the British Association meeting at Dover and of the "Association française pour l'avancement des Sciences" at Boulogne, despatches were exchanged between Dover and Wimereux notwithstanding the existence of great masses of rock and breakers between the two stations at a distance of about 30 miles.

The record distance obtained during these experiments and kept up by the communications was that established between Wimereux and Harwich and Chelmsford, both in the county of Essex on the other side of the Channel, at a distance of about 136 kilometres from Wimereux, the former being on the coast and the second about 10 miles inland, a circumstance which is considered less favourable for radiographic communications. These experiments succeeded perfectly with antennae about 150 ft. in height.

Marconi's Experiments between Ships in Motion (Oct. 1899).
—This, as can be easily understood, is one of the most important and promising applications of wireless telegraphy, whether viewed from the commercial or from the tactical point. The naval administration of the United States, to carry out this latter intention, caused trials to be made, directed by Marconi himself, in October 1899, with apparatus installed on the cruiser "New York" and on board the armoured ship "Massachusetts." The "New York" was able to receive messages from the "Massachusetts" up to a distance of 57 kilometres; however, signals in the opposite direction reached only up to a distance of 27 kilometres.

During the British Naval Manoeuvres in the same year, even better results were obtained. The two ships that exchanged despatches had antennae of 50 and 40 yards in height respectively.

The signals were received at distances of 50 and 80, and in one case up to 100 kilometres. It is noteworthy that in this last case, owing to the curvature of the earth, the two antennae were not visible the one from the other, and in order that they should be so, it would have been necessary for them to have been 200 metres in height.

If we do not admit that the electric waves shall have crossed the water in a straight line, we can only say that

they must have gone round the surface of the globe by diffraction.

In the following year (1900), during the English Naval Manoeuvres, the two ships "Juno" and "Europa" were able to exchange despatches up to a distance of over 60 miles (106 kilometres).

Schaeffer's Experiments.—The Hungarian engineers, Schaeffer and Bola, carried out at this time experiments in radio-telegraphy between Trieste and the S.S. "Maximilian" en route for Venice.

The apparatus used were of the Marconi type, the coherer, however, being that devised by Schaeffer and described by us at page 206.

The transmitting apparatus was on the Trieste lighthouse and the receiver on board the steamer in a suitable cabin.

From the lighthouse at Trieste telegrams were sent at every 15 minutes to the steamer, which had started at midnight on the 19th of July from Trieste bound to Venice. For 65 kilometres the telegrams reached distinctly and clearly, after which they either failed or gave only undecipherable signs. On the return journey from Venice to Trieste, the experiments were repeated with equal success.

First Experiments with Syntonised Apparatus.

Braun's Trials in the Summer of 1899.—At this period Braun had already outlined his system of telegraphy (see page 253), which was undertaken with the view of placing on scientific bases wireless telegraphy, which had hitherto been developed on experimental lines only; his system, as we have already seen, had for its starting point the use of waves of great length and but little damped in the circuit of the exciter; the separation of this latter circuit from that of the antennae on which it acted only by induction and the syntonisation of these two circuits the one with the other, and also with the two corresponding circuits at the receiving stations.

In his first trials Braun had in view to prove above all that the arrangements devised by him were superior to those that up to that time had been used by Marconi. To this end, several comparative experiments were undertaken, 1st,

in 1898 at Strasburg, and then during 1899 at Cuxhaven, and later on up to the autumn of 1900 in various localities situated at the mouth of the Elbe, and communicating either the one with the other or else with the island of Heligoland.

Notwithstanding difficulties that were met with in the installations, interesting experiments in correspondence were made towards the end of 1899, not only between the stations of the Continent and Heligoland, but between these stations and ships that were traversing the North Sea.

During the winter of 1899 and 1900 telegrams were exchanged without error up to a distance of 30 kilometres between one land station having antennae 30 yards in height and the S.S. "Silvana," that had an antenna of 45 feet in length only; and at a distance of 50 kilometres signals were still received.

Braun, in comparing these results with those obtained by Marconi, in his experiments for the American Marine Service in the spring of the same year, under almost identical conditions with regard to the height of the antennae, and in which transmission did not exceed 14 kilometres, concludes that the disadvantages of antennae of lesser height can be compensated by a larger emission of energy obtained by the introduction of condensers, and by inductive excitation.

In September 1900 other trials were undertaken between Heligoland and the continent, comparing the two arrangements, that is to say, Marconi's with the two ball oscillator actuated by a coil, one ball being taken directly to the antenna and the other to earth, and that of Braun. The height of the antennae was 29 and 31 metres, and the distance between the stations 62 kilometres. The conditions were exactly the same (coherers, height of the antennae, coils and the number of accumulators), and out of 450 signals transmitted on the Marconi plan, not one was noted at the receiving station, whereas none of those emitted on the inductive excitation plan failed to be received and registered.

Braun naturally concluded from the result of this and other similar experiments, which were also compared with others obtained by the Wireless Co., that his system was

incontestably superior to Marconi's; this latter, however, had in the meanwhile perfected his system by endowing it with the characteristics similar to those of Braun.

Slaby's Patents.—In order to follow out as far as possible the chronological order we have proposed, we must note that about this time (November 3rd, 1899), that Slaby had secured a patent on the arrangement shewn at Figs. 204, 205, for his system of telegraphy, but it was not until the summer of 1900 that experiments had been executed which proved the practicability of his system, and in the autumn of 1900, that is to say, after the Wireless Co. had claimed their new patent, that the Allgemeine Elektrizitätsgesellschaft asked for Slaby's.

Marconi and his Patents on the New System, 1900.—In this year the Wireless Co. extended considerably the bases of their applications of the Marconi system; it is hardly worth while to chronicle the various installations set up by them on land and at sea; we will, however, note the following, as they have special importance:

In 1900 the Wireless Co. entered into a contract with the English Admiralty for the installation of 32 wireless stations, part on board warships and partly on stations in ports. The conditions imposed were: That the apparatus should permit of the exchange of despatches between two ships at a distance of 65 miles, of which one was placed near Portland, and the other in Portsmouth Harbour. Between the two stations there lay a tract of land including the Dorsetshire Hills; the undertaking was executed under these conditions in a very satisfactory manner.

About the same time (May 1900) a regular service of wireless telegraphy was inaugurated between the lighthouse of Borkum Island, near the mouth of the Ems (see Fig. 242), and the lightship "Borkumriff," that had to signal to Borkum the arrival of the S.S. belonging to the Norddeutscher Lloyd Navigation Company. From North Borkum, by means of a special telegraphic line, the radiotelegrams were sent to Emden, and thence to Bremen. The distance between the lighthouse and the ship was of about 39 kilometres, and the antennae had a height of 115 feet on the lighthouse and 100 feet on the ship; the antenna on the lighthouse was also furnished with a metallic

netting of about 1 yard square. Many telegrams were exchanged between the two stations, and between them and the ships in motion.

The S.S. "Kaiser Wilhelm der Grosse" was able to exchange telegrams with certainty to a distance of about 50 miles, and to send intelligible signals up to a distance of

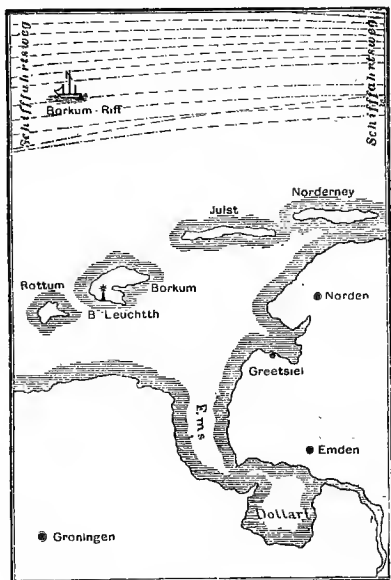

Fig. 242.

60 miles. In the meanwhile Marconi had introduced important modifications in his transmitting apparatus, rendering it capable of being syntonised with the receiver, and of increasing the duration of the vibrations in the manner we have indicated at pages 234 *et seq.*

The modified apparatus, which is that shewn at Figs. 164 and 165, pages 236 and 237, constitute what we have called Marconi's second system.

Slaby's Experiments.—By this time Slaby had already, along with Count Arco, developed that system of telegraphy

which bears their name, and gave a public experimental demonstration of its efficiency on the 22nd December, 1900, at Berlin, in the presence of the Emperor William; it was on this occasion that the first trials were made in multiple communication, which we have noted at page 323.

Experiments in France and in Russia.—We cannot give here a detailed account of the numerous experiments in wireless telegraphy that were made about this time by the different nations. We may particularise, however, that in France many trials were made at Brest under the direction of the ship Lieutenant Tissot, Professor of the Training Ship "Borda," who deduced from his experiments the interesting conclusions that we have noted in their several places; and that other experiments were undertaken by a Commission presided over by Captain Gadaud, between the semaphores of Ouessant-Stiff and Keramezee. On the 29th September, before this Commission, experiments on the high sea between Ouessant-Stiff and the armoured cruiser "Bruix," that sailed from Brest for Rochefort, took place; the cruiser maintained constant communication for the whole 3 hours of its voyage.

In like manner very many experiments were carried out by Popoff in the Gulf of Finland during the winter 1899-1900, between the islands of Kotka and Kohland, about 47 kilometres apart. These had hitherto had no means of communicating, either telephonically or telegraphically, in consequence of the great difficulties in access.

In 84 days there were exchanged with great regularity, between these two stations, no less than 440 official telegrams.

Guarini and Poncelet's Experiments, Jan. to March, 1901.—Early in 1901 Guarini and Poncelet established between Brussels and Malines and Antwerp, experimental communication overland with the Guarini system and with his repeater (see page 214). The antennae were raised in the manner indicated at Fig. 243 on the column of the Congress at Brussels, and on the towers of the cathedral of Antwerp and Malines.

In the first place, successful experiments were made in communication between Brussels and Malines reciprocally, at a distance of 15 miles. After having ascertained that

with apparatus of the sensibility employed, it was not possible to communicate directly between Brussels and Antwerp, a distance of about 30 miles, the repeater was placed at Malines, which stands a little out of the direct line joining Antwerp to Brussels. Poncelet gives us to



Fig. 243.

understand, in his account, that these experiments were fully successful, but some people argue that from this same account it would appear that the system left something to be desired. A portion of the signals despatched from Brussels was actually received at Malines and transmitted automatically by the receiver, and was registered at Antwerp, but another portion was, however, not noted at Malines, and much less at Antwerp.

It was also noted that the signals received at Antwerp did not coincide perfectly with those that passed through Malines and were there registered and re-despatched.

It does not appear that this system had been subjected to new trials after this, but on the contrary, that the use of repeaters has been abandoned in view of the great distances to which direct communication could be effected.

Experiments with Marconi's Second System (1901).

Experiments between St. Katherine's and the Lizard.— As soon as Marconi had modified his system of telegraphy, he applied it immediately to the conquest of record distances in radio-telegraphic transmission. To this end he set up a station at the Lizard (Cornwall), which was immediately put into communication with Marconi's experimental station (see page 342) at St. Katherine's, Isle of Wight, at a distance of 300 kilometres (about 200 miles), in which he

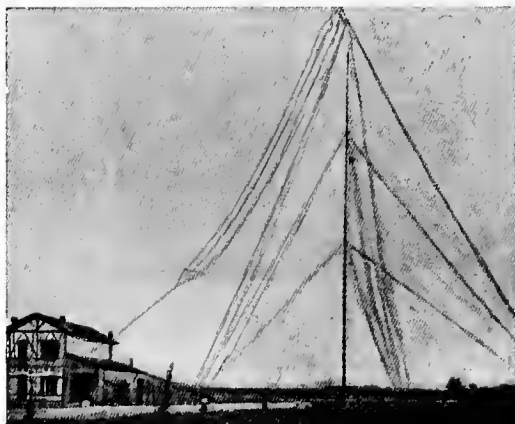

Fig. 244.

used an aerial conductor consisting of four vertical wires standing about 5 feet from one another, about 144 feet in height, along with a strip of wire netting of the same length.

Under the new system the energy required to telegraph to a given distance was very much diminished, so that 150 watts sufficed to communicate to the 300 kilometre distance.

Fleming, in a lecture given on February 12th, 1901, to the members of the Liverpool Chamber of Commerce, was

authorised by Marconi to publish the result of these experiments, by announcing that the first despatch between the said stations was sent off on the first day of King Edward VII.'s reign. From that time forward Marconi communicated between the Lizard and St. Katherine's, and, still following the report given by Fleming, was in a position to receive contemporaneously, two or three telegrams^{at} each station.



Fig. 245.

Experiments between France and Corsica.—Other interesting experiments were carried out by the Wireless Telegraph Company, beginning in April 1901, between the stations of Biot (Fig. 244) near Antivis, on the French coast, and that of Calvi in Corsica (Fig. 245), 175 kilometres apart across the open sea. The apparatus were those on the second Marconi plan (Figs. 168 and 169). The coil gave a 12" spark with a platinum break, and was fed by special accumulators, which in their turn could be charged from a battery of 100 dry cells.

According to the number of Leyden jars that were used from the condenser of the oscillator circuit (see Fig. 164), that is to say, according to the length of the wave employed, the form and the size of the transformer were also varied,

This latter was constructed as detailed at page 144. The one most suitably employed (13 jars), with a wave-length of 300 metres, had a single turn on the primary, the secondary having 6 coils, 3 on each side of the primary, arranged in a spiral plane over the wooden frame around which the primary was wound. The aerial conductors consisted of 4 wires, connected in parallel, as already described by us at page 125, standing about 6 feet apart; the 4 conductors were connected to a single insulated wire that led into the station. The height of the antennae to support the conductors was about 60 feet at Biot, and 65 feet at Calvi, above the level of the apparatus.

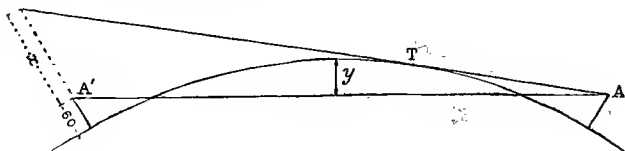

Fig. 246.

Taking into calculation the relative length of the antennae and the curve of the earth, the position of the two antennae is that shewn at Fig. 246, from which it would appear that if we draw from the antenna A a tangent of the arc of the maximum circle passing between the two antennae, it would strike a prolongation of the antenna A' at a point much higher than the extremity of this latter.

If a calculation be made, taking count also of refraction, it would appear that a luminous ray starting from A in the direction of the said tangent, would pass 1350 metres above the point of the antenna. The antennae were therefore perfectly invisible, the one from the other. On the other hand, a straight line uniting the upper extremities AA' of the antennae would pass about 500 metres under sea level. In both stations great care was taken to ensure a good earth-contact, having a large surface united to the apparatus by means of the shortest possible wire.

In reference to this, we will refer the reader to what we have previously noted at page 139. The fact there noted,

that the reception of telegrams was interrupted when more than 30 metres of wire were placed between the earth contacts and the receiver, was caused by interference due to the presence of a transformer inserted between the antennae and the earth. The transformer of the receiver (jigger) corresponding to that above described, viz., suitable to a wave-length of about 300 metres, was constructed on the plan already described by us at page 141. The Biot station was 200 metres from the sea through inequalities in the ground; the apparatus was placed on the ground floor of an isolated house, and the antenna stood at a distance of about 21 yards off. Between the antenna and the sea there lay a line of railway, with its relative telegraphic wires. The station at Calvi was erected outside the fortifications at about 160 feet from the sea, and even here, between the antenna and the sea, numerous telegraphic lines occurred. The apparatus here was installed on the first floor of a house, and the antenna stood at a distance of 100 feet from it.

Fig. 170 represents the interior arrangement of the station at Biot.

We now pass on to describe the result of the experiments in simple communication between the two stations, those referring to multiple communications we have already noted at page 325. The simple communications were established between the two stations in three different *tones*, always with satisfactory results, but it was found that the longer wave came out more perfect (using 13 jars with 300 metre waves), which may be attributed to the greater exactitude in the accordance between the antenna and the oscillators of the transmitting station, and likewise to the phenomena of diffraction, which facilitate the transmission of the longer waves. It was found that not all hours of the day were equally suitable to transmission; at midday communication was more difficult, and sometimes impossible. Whatever the weather might be at certain hours of the day, between 11 in the morning and 6 in the evening, and with a maximum at 2 o'clock, the receivers registered parasitic signals of atmospheric or telluric origin, which necessitated a slower transmission of the messages.

To these atmospheric perturbations were added some-

times more or less clear signals, due to the exchange of radio-telegrams between mercantile or warships on the high sea that were exchanging messages. It was ascertained that, unfortunately, the registration of all these stray signals took place with much greater facility during the state of super-excitation in which the coherer found itself whilst it was registering another telegram.

Finally, experiments were made in receiving and transmitting very long messages, with the view of ascertaining the degree of stability presented by the different pieces of apparatus when once regulated, and here the results were satisfactory. It was found possible, for example, to keep up consecutive messages three hours in length, on two separate occasions, without having to readjust the apparatus. It was, however, necessary to alter the contact breaker of the coil, the percussor and the relay, which necessitates an expert operator.

With regard to the speed of transmission, it was possible to receive the word "Paris" 14 times in a minute; a despatch of 46 words could be received in 4 minutes 50 seconds, and repeated in the same time; but it was found that under normal conditions, in consequence specially of the irregularity of the coherer, it was not possible to reckon on a higher average speed than 6 to 8 words a minute.

The experiments were conducted under the control of a Commission comprising the delegates of the Ministries of Telegraphs, Colonies, War and Marine.

On the First Trans-Atlantic Experiments.

Encouraged by the results of the experiments in communication between St. Katherine's and the Lizard (300 kilometres), page 356, Marconi put his whole heart into the attempt to resolve the arduous problem of establishing trans-Atlantic radio telegraphic communication.

Repeated experiments had shewn that long waves, either by successive reflection or diffraction, could turn round the surface of the earth, so that their transmission to very great distances resolved itself only into a question of sufficient power in the transmitting apparatus, and sufficient sensibility in the receiving; but these necessitated large financial

means, which would, however, not be wanting in a man whose business acumen was not less surprising than his experimental ability.

Being largely subsidised by the Marconi Wireless Telegraphy Company, Marconi began early in 1901, unknown to every one, his trials, by establishing two specially-powerful stations at Poldhu, near Cape Lizard, in Cornwall, on one side of the ocean, and at Cape Cod in Massachusetts on the other side. The results of these first trials are not known, and, judging by the silence maintained in this regard, they were probably negative.

The two stations, that had cost the sum of more than £15,000, were destroyed by storms in September of the same year.

Marconi caused the station of Poldhu to be rebuilt, furnishing it with powerful machines and radiators, and decided to attempt communication with St. John's, Newfoundland, that is to say, to a lesser distance than that previously chosen, viz., of about 1500 miles. At St. John's, Newfoundland, where Marconi had obtained from the Government every facility for making the trials, the installation was of the simplest character, consisting of a receiving station only. The aerial line was maintained at a height of about 400 feet by means of a kite.

Marconi had already agreed with the station at Poldhu, that every day, at six o'clock in the evening, a long series of letter *S* should be sent. This letter in the Morse alphabet (see page 99) consists of three dots. The transmitter at Poldhu was on the same plan as that used between Biot and Calvi (see page 357), but of more colossal dimensions, and the receiver was an electro-radiophone (see page 43), combining also Marconi's jigger (see page 141), and sometimes Castelli's automatic decoherer (see page 186).

The message was received telephonically. On the 12th of December, 1901, Marconi announced that he had received the different *S* at equal and determinate intervals, and he proclaimed that it was practically, physically and mathematically impossible that the signals could have come from any other place but Cape Lizard.

The great authority of Marconi did not suffice to cause all to accept as truthful these results. The fact that these

signals were received telephonically, and were therefore not registered, gave rise to much scepticism, and many went out of their way to find extraneous causes to which they could be attributed; some set them down to atmospheric electricity, others to distant lightning flashes, others again derived them from telegraphic stations on the American Continent, and others set them down as originating in wireless telegraphy apparatus on board passing ships, or even to the practical joke of some lively person.

Marconi, however, had heard and seen sufficient for his purpose, and he decided to return to Europe and to put in hand, in full faith, the preparation necessary for those experiments that led, as we shall see, in one year later, December 20th, 1902, to put him in a position to send to the Kings of England and of Italy, the first radio-telegrams across the Atlantic.

Marconi's Experiments on board the "Philadelphia," Feb. 1902.

In February 1902, Marconi, while crossing the Atlantic from Southampton to New York on board the ship "Philadelphia," of the American Line, instituted new experiments between the transmitting station at Poldhu, which had already been made use of in the experiments in trans-Atlantic communications just described, and a receiving station set up on board the "Philadelphia."

At the Poldhu station the charge of the aerial pavilion had been raised, and this had been itself enlarged, and now consisted of 15 conducting wires.

The potential to which these conductors were charged was sufficient to determine a spark 12" in length flowing from the upper extremity of these wires to a conductor connected to earth. At the receiving station of the ship the aerial conductor was a quadruple wire 180 feet above sea level, and joined to the primary of the transformer, the secondary of which, tuned with the sending station, was connected up to the coherer.

Marconi's assistants at Poldhu had received instructions to send a succession of "S S" and a short message at a certain prearranged rate, every 10 minutes, alternating with

5 minutes' rest, during the following hours, viz. : from 12 to 1 a.m. ; from 6 to 7 a.m. ; from 12 to 1 p.m., and from 6 to 7 p.m. (Greenwich time) every day from the 23rd of February to March 21st inclusive.

It is noteworthy that in these experiments Marconi for the first time became aware that daylight rendered communication more difficult (see page 94), having ascertained that there was a marked weakening in the reception that appeared to augment in proportion to the daylight at Poldhu.

In a note presented by Marconi to the Royal Society, June 12th, 1902, he declared that he had made other experiments between the Poldhu station and other receiving stations similar in all regards to those in the "Philadelphia," and to have become aware even with these of the detrimental action of daylight on transmission. For example, at the station of North Haven, which is about 152 miles (243 kilometres) from Poldhu, of which 109 are on the sea and 43 on land, he found that the signals from Poldhu were transmitted correctly in the night time with four vertical wires 12 metres in height, whereas in the day time, under similar conditions, in order to receive signals with equal clearness, the length of sky rod required was $18\frac{1}{2}$ metres.

We have elsewhere spoken of the theory proposed to explain this phenomenon (page 94 *et seq.*). Marconi proposes to study this completely with a view to ascertaining whether the same effects are to be observed when the transmitting sky rods are covered with some material which is opaque to ordinary light.

The Voyage of the "C. Albert" (Summer 1902).

This voyage will ever be memorable in the history of radio-telegraphy, as having led to results superior to the most sanguine expectations ; in fact, it shewed that it was possible to receive signals at Cagliari from Poldhu at a distance of about 1000 miles, $\frac{2}{3}$ rds of which is on the Continent across the whole of France, and complete telegrams from Poldhu to Gibraltar, a distance of rather less than 1000 miles, a good half of which was on land,

across the most mountainous parts of Spain. By the aid of the account given by Lt. Solari of the Ministry of Marine, we can follow the principal phases of the experiments carried out during this voyage.

In June 1902 the ship "Charles Albert," having to make a voyage in the North Sea, had been fitted with some of the old type of Marconi apparatus, with which, as soon as she had arrived in English waters, she placed herself in radio-telegraphic communication with Cape Lizard station (see page 356), where Marconi was, and arranged with him to replace her instruments with others of the more powerful and sensitive type belonging to his "second system."

On the 26th June Marconi went on board the "Charles Albert," taking with him the magnetic detector (see page 192) which was to be compared for the first time with the coherer as a receiving organ.

The first experiments were made during the voyage of the "Charles Albert" towards Kronstadt (see page 365).

At the receiving pavilion the first thing employed was that described by us at page 249, Fig. 176. The conduit of the aerial sky rod to the station containing the apparatus was carefully protected from any eventuality of lateral discharges by means of an ebonite tube; the connections to earth were made in the most careful manner possible, connecting several points of the framework to different parts of the engine. In the station on the "Charles Albert," that served only as a receiver, were arranged two Marconi coherers with metallic filings, and three detectors, each coupled to three telephonic apparatus, destined to acoustic reception.

The transformer communicating with the coherers was tuned to the best degree possible to the period of the electrical oscillations emitted by the station at Poldhu. Later on, in order to tune the receiving apparatus with the transmitter, the fan-shaped pavilion already described by us at page 130, Fig. 77, was adopted. The experiments were carried out in the manner regulated by Marconi, in the following order :

Every day from the Poldhu station, between the hours of 12 and 1 midday and from 1 to 3 Greenwich mean time, were to be sent during the first 10 minutes of every quarter

of an hour, the signal of the "Charles Albert," "C. A.," followed by a long series of "S S" and some sentence concerning the most interesting public news of the day.

On July 7th Marconi embarked at Dover, and experiments were immediately begun by attempting transmission at a distance of about 530 miles (848 kilometres), of which about $\frac{6}{10}$ ths were over rough ground (see Fig. 247). As soon as

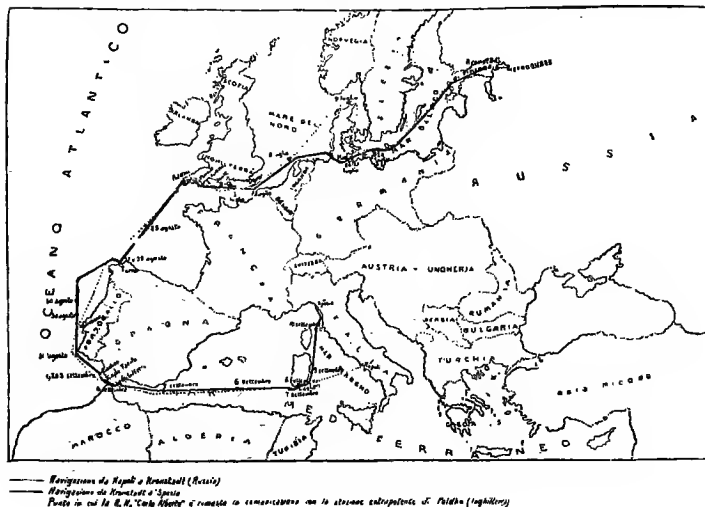

Fig. 247.

syntony had been obtained in the telephonic apparatus of the detector, the rhythmical "S S" sent from Cornwall were heard; these signals, however, were very weak, partly through defective syntonisation and partly as a result of the discharging action of daylight.

Next day reception was much better, so much so that it was possible to register the telegrams by means of the Morse printer. On increasing the distance, it appears that reception ceased during the day, but at night communication was again effected with Poldhu, at a distance of 900 kilometres, with the telephonic detector receiver, and later on registration

by means of the Morse apparatus connected with the coherer was effected.

On the next day, at 12 o'clock, the distance was 1000 kilometres, but in consequence of the disturbing action of light, no registration was obtainable with the Morse, and the detector only gave evidence of the rhythmic sounds of some "S S"; at night, however, the signals were more intense, and were received even with the coherer and Morse printer.

Things continued thus until July 12th, when the "Charles Albert" cast its anchor in the port of Kronstadt; and notwithstanding that between the sending and receiving stations, England, Denmark and the mountainous Scandinavia intervened, and that the distance was about 2000 kilometres, signals were still exchanged. At Kronstadt the signals received by the telephone were, however, rather weak and could not be picked up by the Morse, and it was only after the addition of wires to the receiving pavilion, in order to bring its period more in syntony with that of Poldhu, that the series of "S S" transmitted during the night could be distinctly heard.

Satisfactory results were obtained during the following nights up to the 23rd, when the anchor was raised for the return voyage towards Kiel. On the night of July 24th the "Charles Albert" was in the further portion of the roadstead of Kiel, and reception due to the diminished distance was perfect, both with the detector and with the coherer in connection with the Morse, although during the voyage itself, from some unknown cause, reception had become difficult.

On the night of 26th messages were received during a violent thunderstorm, the perturbations of which were eliminated by introducing in the receiving apparatus suitable inductances and capacities.

A trial was also made of the Castelli coherer (see page 186), but owing to the fact that each atmospheric electrical disturbance put it out of order, its use had to be abandoned.

During the night, from Kiel to England, although the distance was rapidly diminishing, no substantial difference was noticed in the conditions of reception.

Having put up at Plymouth for 20 days, up to August 25th, and having perfected the receiving "pavilion," which

was now made up of 54 conductors of 150 ft. in height from the deck, the return voyage to Italy was undertaken.

On August 30th, the ship being on its way to Cadiz, it was ascertained that the distance at which reception in the day time was certain and perceptible with the given power of the transmitting station and the sensitiveness of the receiver was 1000 kilometres.

In the night between the 30th and 31st the effect produced by the interposition of the Spanish Continent in a straight line between the two stations was observed. This interposition did not prevent the telegrams containing the news which in those days interested Europe from being received on board the "Charles Albert," even when this ship found herself in the innermost portion of the harbour of Gibraltar, at a distance of about 1500 kilometres from Poldhu, across the most mountainous portions of the Spanish Peninsula, and did not cease even when the ship was in the Mediterranean between Cagliari and Spezzia, where the successful voyage terminated.

We here reproduce the conclusions that Lt. Solari arrives at as the result of the observations made by him, although they seem in some instances somewhat premature, to say the least :

1. There is no distance limit to the propagation of electric waves on the terraqueous surface of the globe, provided the energy of transmission employed be proportionate to the distance to be reached.

2. Land lying between a transmitting and a receiving radio-telegraphic station, does not interrupt communication.

3. The light of the sun has the effect of diminishing the field of radiation of the electric waves, and renders it therefore necessary that more power should be employed in daytime than at night ; the influence of atmospheric electrical discharges necessitates a diminishing of the sensitiveness in the apparatus so as to render them independent of such discharges, and this at the same time calls for an increase in the energy employed in transmitting, in order to obtain the desired effect with less sensitive apparatus.

4. The efficiency of the magnetic detector has been demonstrated by this positive experiment to be superior to that of any known coherer, partly because it does not

require any adjustment and partly because of its absolute constancy in work, as also for its easy application and great sensitiveness.

5. Marconi's system of wireless telegraphy is, under the new arrangement, the most suitable for practical application, whether for commercial or military purposes, without any limit as to distance.

As bearing on the memorable trial of the "Charles Albert," we must, however, record the fact that, however surprising be the results obtained and hoped for in future, there are still several serious difficulties to be overcome in order to ensure that degree of secrecy and certainty that telegraphic communications demand.

Mr. Maskelyne, the Director of the radio-telegraphic station at Porthcurnow, at 280 kilometres from Poldhu, points out in a number of the *Electrician* for November 7th, that the signals and the telegrams sent by the station of Poldhu and intended for the "Charles Albert" were registered by the apparatus at Porthcurnow so faithfully as to place the staff of that station in a position to follow step by step the progress of those experiments.

At Porthcurnow the despatches directed to the "Charles Albert" arrived at the beginning mixed with other signals produced by electrical waves of less intensity, simultaneously emitted by the Poldhu station, in order to render these despatches less intelligible at short distances; but Maskelyne, by diminishing the sensibility of his coherer, was able to suppress the reception of these intermixed waves, and to receive only those of greater intensity, which were intended for the "Charles Albert." The control thus effected by Maskelyne shewed how radio-telegraphic transmissions have still to combat difficulties dependent upon causes that are as yet unknown, since the reception on board the "Charles Albert" of one of the despatches was not effected until the morning of the 9th September, during the passage from Cagliari to Spezzia, whereas it had been transmitted repeatedly from Poldhu ever since the evening of the 6th.

Hence, the receiving organ on the "Charles Albert" must have been for two whole days at the mercy of some extraneous causes, that impeded it from receiving that despatch.

These experiments carried out on the "Charles Albert" shewed therefore the possibility of transmitting despatches with the Marconi apparatus to distances of over 1,500 kilometres, notwithstanding the intervention of wide continents and of high mountains; but they also shewed that the system required to be greatly improved before it could lay claim to that certainty of transmission which is obtained with ordinary wire telegraphy.

Trans-Atlantic Communications, December 1902.

After the Newfoundland trials (page 360), in which Marconi had succeeded in receiving by telephone the "SS" transmitted from Poldhu, he was obliged to give up further experiments in that region, in consequence of the rights of the Anglo-American Telegraph Co., who had, it appears, the monopoly of trans-Atlantic communication, not only through cables, but also through the air, the sea and land.

The Canadian Government, however, offered Marconi, in accordance with a special Convention and Subvention, the option of continuing his experiments in Canada. Marconi accepted, and put in hand the installation of a large station at Table Head, situated in the Island of Cape Breton, facing the peninsula of Nova Scotia (see Fig. 248), at a distance of about 2 hours from Sydney and 3,800 kilometres from Poldhu, and situated on one of the most easterly promontories of the island, at the mouth of Glace Bay.

The radiator was that already described at page 131, and was identical with that at Poldhu, consisting therefore of four wooden towers of about 80 yards in height, placed at the corners of a square of 75 yards inside, joined at their upper extremities by four cables from which started the radiating lines that converged at their base towards the shed in which the apparatus is placed.

The Italian Government conceded to Marconi the use of the ship "Charles Albert," in order that it should assist in the work of setting up the station at Glace Bay, and therefore on the 30th September, 1902, the said ship, having been placed in a condition to bear with its high masts (144 feet in height) the winter storms of the Atlantic, sailed from Spezzia for the Coast of Cornwall, where Marconi was taken

on board, and started on October 20th from Plymouth for Sydney, where it cast anchor on October 31st.

During the voyage the ship received regularly signals from Poldhu, even during the fury of very violent storms, and continued to receive them even when it was well within the roadstead of Sydney. On his arrival Marconi immediately took in hand the setting up of the apparatus at the station, and after a month and a half spent in preparation and in

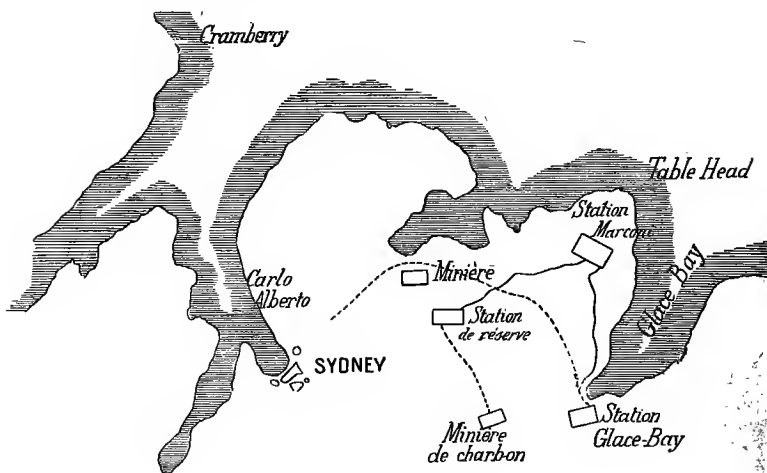

Fig. 248

preliminary trials, he was in a position to despatch from Table Head to Poldhu on December 20th the first radio-telegrams announcing the inauguration of the said station to the Kings of England and Italy, and rendering homage to the two sovereigns.

The ship "Charles Albert," having thus finished her scientific mission, started for another mission in the waters of Venezuela, and Marconi remained at Table Head with Lt. Solari, the representative of the Italian Government, where he continued to receive and despatch radio-telegrams to and from Poldhu, in order to study the means of improv-

ing the regularity of transmission and of reception, and of increasing the speed of working. In the meanwhile, at Cape Cod, in the United States, another extra powerful station was being got ready similar to that at Table Head, at a distance of 3,200 miles from Poldhu, that is to say, 660 miles farther than Table Head.

The little chart below (Fig. 249) shews the relative positions of the three stations and the position of the trans-Atlantic cable (which are indicated by continuous lines that run from England to North America).

On January 16th the station at Cape Cod was ready for work, and a complete radio-telegram was transmitted from President Roosevelt to H.M. the King of England.

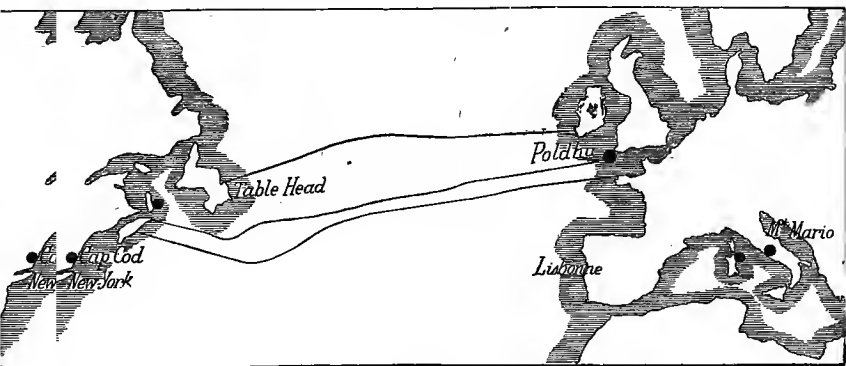

Fig. 249.

Marconi's other Radiographic Campaigns.

After Marconi's important experiments on trans-Atlantic communication he did not sleep on his laurels, but he turned his marvellous activity to the study of the best conditions for securing radio-telegraphic service of vast and certain commercial applications. He undertook several voyages between Europe and America, and between the various European ports, on ships furnished with his apparatus, of more or less powerful types, that communicated either with the extra-powerful stations of Poldhu, of Table

Head and of Cape Cod, or with the ordinary stations on the coasts.

Among these trials, the most fruitful in practical results were those executed on board the "Lucania," the "Duncan" and the "Campania," of which we will give a brief relation.

The Voyage on the "Lucania."-- The Cunard liner "Lucania" started on August 22nd, 1903, from Liverpool for New York, with Marconi and Lt. Solari on board. The "Lucania," besides having the usual short distance station on board, which was destined to commercial communication between the "Lucania" and the coast-line stations, and which was placed at the disposition of the commander and of the passengers, was fitted with another receiving station for long-distance work, specially for receiving communications from Poldhu and from Table Head (see Fig. 249), in order to be able to judge of the relative efficiency of the two radiators, which were constructed in different manners.

The principal conclusions arrived at were:

1. That radio-telegraphic service to great distances on the open sea could be carried on regularly without interfering with the working of the communication between ships and coast-line stations, taking place with instruments of less power. In fact, whilst Poldhu was sending messages to the "Lucania," the station at Lizard, standing 6 miles from Poldhu, was keeping up communication with other ships sailing to New York.

2. That the arrangement of the pavilion of Poldhu was preferable to that at Table Head, since the former had been able to keep up communication with the "Lucania" up to a distance of nearly 3000 miles, while the second shewed much less efficiency, notwithstanding that its pavilion was of equal height, and was using a spark of 3 times the length.

3. That the influence of sunlight (see page 94) has some relation to the special form of transmission, which leads to the hope that means may suggest themselves in order to overcome this disturbing action.

4. That the system of syntony adopted does not influence a station that is out of tune, even if it is placed at only 300 feet from it.

Whilst these technical experiments were being carried out, the passengers, by means of the short-distance apparatus,

were sending messages to the coast, and to other ships during the entire voyage, and received a daily bulletin printed on board containing radio-telegraphic news of the principal events that were taking place in the world.

Marconi and Solari having landed in America carried out experiments on Lake Michigan near Chicago, by means of which they were able to shew that fresh water is equally favourable to radio-telegraphic transmissions as the salt water.

On the return voyage to Europe, the facts above ascertained were confirmed; every evening the first-class passengers received the *Cunard Bulletin* printed on board, and containing long despatches from New York, from London and from Ottawa.

The Voyage of the "Duncan."—As soon as Marconi had arrived at England, the English Admiralty placed at his disposal the ship "Duncan," in order that he might carry out thereon some radio-telegraphic experiments under the control of the officers of the British Fleet. A voyage from Portsmouth to Gibraltar was undertaken, during which the "Duncan" received daily despatches from Poldhu, thus confirming the results formerly obtained during the voyage of the "Charles Albert" (see page 363).

In the Bay of Biscay a violent wind broke the rattlins attached to a mast that supported the conductor; and although the height of the conductor was thus reduced, the reception of despatches was not interrupted.

From 28th October to November 1903, the ship remained anchored at Gibraltar, continuing to receive despatches from Poldhu.

The commander of the "Duncan," in the name of the British Admiralty, continued the experiments on board, and a lieutenant of the English Navy assisted in the transmissions from Poldhu.

At this same period, other experiments between Poldhu and the station on the Rock of Gibraltar confirmed the possibility of telegraphing from England to Gibraltar, notwithstanding the interposition of the Spanish Continent with its high plains and mountains. From these experiments also, it became evident that the electrical waves emanating from ultra-powerful stations do not disturb the

communications between the stations destined to short-distance service.

Voyage of the "Campania."—In June 1904, Marconi having embarked on the s.s. "Campania" (Cunard liner), carried out some new experiments in reception from the ultra-powerful stations at Poldhu and Table Head. He tried four different systems of reception, and chose the best, which allowed him to gather easily messages despatched from a distance of about 2000 miles. This success enabled him to conclude a contract with the Cunard Company of furnishing a daily service of news, to be published by that Company's ships when they were crossing the Atlantic. It appears that the contract assumed by Marconi was that of furnishing about 200 words a day.

During this voyage, Marconi not only was able to keep himself in constant communication, first with England and then with Canada, but for three days he was simultaneously in communication with the two extra-powerful stations on the two sides of the Atlantic.

Projects for Fresh Experiments.—Up to this time, long distance communications (from 1000 to 4000 kilometres) between land stations and ships were always one sided, that is to say, the station on the ship only received despatches from the land station, but did not transmit any. That depended upon the difficulty of installing on the ships the enormous pavilions on which the great carrying power of the ultra-powerful stations depends.

It appears that the recent researches of Marconi have led him to believe that with pavilions of much lesser height and extension than those which had been arranged at the ultra-powerful stations, transmission to distances comparable to those obtained at these stations could be effected.

It is affirmed that Marconi will ask the Italian Government to place at his disposal a ship fit to undergo the necessary transformation, to enable him to execute at the least expense a first experiment, not yet attempted by any other nation, viz., that of receiving and sending radio-telegraphic messages to great distances from a ship; such a new application would have great utility in the transmission of orders and of news to distant fleets.

The ships of a fleet would in general be provided with a

short-distance Marconi apparatus (200 miles approximately), but one of them would, in case the new experiments succeeded, be fitted with a long-distance transmitting apparatus (from 5000, or even more, to 6000 kilometres), which would gather the news from the other ships in order to transmit them to an extra-powerful land station, as, for example, the one which is about to be built, as we shall point out a little later on (page 386), at Coltano, near Pisa, and from this receive orders and news proceeding from the central command, in order to transmit them to other ships; which will effect an enormous saving in time, in cruisers and in advices.

Should the experiments succeed, the definitive type of warship that will answer, not only to the technical requirements of radio-telegraphy, but also to the strategic exigencies of a unit of fleet in war, will have to be studied.

It is easy to understand how, with a small number of ships furnished with ultra-powerful transmission apparatus, which can serve as intermediate stations, it would be possible to transmit, to constantly increasing distances, despatches emanating from ultra-powerful land stations; and to Marconi is to be attributed the idea of causing a telegram to complete the circuit of the world, returning to the emitting station.

Fresh Experiments with Other Systems.

The various systems of radio-telegraphy which have arisen alongside that of Marconi have for the greater part limited their field of application to correspondences, to small or medium distances, up to 350 miles, that appear to present the most extended use for the application of the new means of communication.

The experiments were therefore specially directed to rendering practicable and sure communications within the said limits, rather than to extending the radius of action of the respective stations. These experiments, notwithstanding their practical importance, do not present that interest of novelty possessed by Marconi's, with which he has attempted to surmount with persevering audacity the most arduous problems that radio-telegraphy could present.

Marconi's system is the only one up to the present time

that can boast of those marvellous installations known as ultra-powerful stations, whose radius of action is to be measured by thousands of miles; while, on the other hand, the efforts of the other inventors have been directed rather to obtain transmission with the least expenditure of energy than to the increase in the power of the stations.

Under the Fessenden system (see page 286) was established in 1903 a service between New York and Philadelphia, a distance of about 80 miles, with antennae of 120 feet in height, not absorbing more than $\frac{1}{4}$ H.P. of energy; during the hours of service, 40 telegrams were exchanged between the two stations, notwithstanding the proximity of over 135 wireless telegraph stations in the two cities, which proves the efficiency of the syntonisation system adopted by Fessenden.

In like manner a French wireless company using the Branly Pott system succeeded in transmitting in March last year, between the two stations of Amsterdam and of Kampew (Zuyder Zee), at a distance of 66 miles, printed despatches by the Morse, using only a spark of $\frac{1}{25}$ inch in length, with a consumption of energy equal to that of an 8 C.P. incandescent lamp.

Among communications overland to greater distances, we may note that established under the Slaby Arco system between Berlin and the Port of Karlkrone, situated at a distance of about 300 miles apart.

Under the same system, two stations at a distance of about 30 miles were set up in the Lofetena Islands in Norway, with high rocky masses intervening, which opposed serious obstacles to the passage of the electric waves. Communication was effected in a satisfactory manner by employing an energy of 200 watts only.

Popoff's system, with which the principal Russian ships and fortresses are provided, is now undergoing a fiery ordeal in the Far East; but up to the present time we know little of the real work that it has done. The Japanese Fleet also makes use of a special system of wireless telegraphy to communicate the orders of the Admiral of the Fleet to other ships, and perhaps also communicate with Japanese ports; the news which we shall get at the end of the war on the working of their system will certainly present much interest.

Another success worthy of note is that obtained with the de Forrest system during the actual war in the Far East. The *Times* correspondent on board the s.s. "Haimun," furnished with apparatus on this system, sends daily to the English station at Wei hai Wei long despatches from the points on the Yellow Sea, where the "Haimun" is placed to gather news. The regularity with which the said despatches are published in the *Times* is a proof that the system works with certainty even in difficult conditions.

Wireless Telegraphy in the Royal Italian Navy.

Following out the chronological order which we propose, we have thus followed up little by little those experiments that by the work of Marconi and others have brought wireless telegraphy to its highest point, viz. that of trans-Atlantic communication.

In such a description, having collected those experiments that mark the progress over the results of preceding trials, we have on two occasions found that the officers of the Royal Italian Navy have lent efficient and intelligent aid in carrying out such improvements, firstly with the experiments at Spezzia (page 337), then in those on the "Charles Albert" (page 363).

It is our duty also to record how from 1897 up to the present date our Royal Navy, having understood the great advantages that wireless telegraphy presented to the service of the fleet, has without interruption dedicated to radio-telegraphic experiments the activity and the intelligence of its officers and subalterns, and the resources of a fund which, compared to that of other of our other Ministries, may be called princely.

Few are the documents which we have shewing what long and untiring work has been employed, but by means of these, we can give a short account of the persevering researches that the Italian Royal Navy has undertaken with a view of rendering radio-telegraphic service practicable, applying to the same those improvements which from time to time were proposed by other experimenters, and in most cases introducing new ones of their own.

Directly after the experiments of Marconi at Spezzia, that

is to say, in 1898, a permanent station was erected on the heights of the island of Palmaria, in the Gulf of Spezzia, close to the semaphore; in 1899 two similar stations were erected, one on the highest point of the island of Borgogna, and the other at Leghorn, in the enclosure of the Royal Naval Academy.

Under the direction of Professor Pasquilini and of Lieut. Simion, a series of continuous experiments was kept up between these two stations, with the intention of availing themselves of the information thus obtained for the erection of similar stations at all the semaphores in the kingdom



Fig. 250.

At Fig 250 we represent the station of Palmaria, which is situated in the square inside the fort at a height of 600 feet above sea level.

This consists in a wooden hut, containing a small 1.5 kilowatt dynamo driven by a Winterthur petroleum oil engine, for charging the accumulators necessary for feeding the large Balzarini induction coils, giving a 2' spark. The antenna, which is divided into three pieces, is 162 feet in height.

The radiator consists in copper conductors having a total

superficial area of $12\frac{3}{4}$ square metres built up of 19 single wires, each one of No. 21 gauge covered with an insulated coating. Earth is taken to a copper sheet of large surface buried in the ground and packed in charcoal.

The station of Gorgona is built on a hill 255 metres above sea level close to the semaphore. The antenna, the transmitter, and the receiving apparatus are similar to those at Palmaria.

The charging of the accumulators is effected by a 30 amp. 65 v. dynamo driven by an Otto petroleum motor of 3 H.P.

The station at Leghorn rises from the square of the Royal Naval Academy and is only $4\frac{1}{2}$ metres above sea level. The antennae and the other apparatus are similar to those at the other two stations, with the exception that it was found more convenient to divide the supporting masts into three pieces instead of two.

During 1898 and 1899 many experiments were performed at these stations, Marconi's "first system" being employed. The details of the aerial wire and of the mode in which it was raised were carefully studied, as also the influence which the thickness and the structure of the wire might have upon the results. It was ascertained that considerable advantage was to be obtained in transmission by raising the wire of the receiver, whereas relatively less benefit accrued from raising the wire of the transmitter.

It was verified also that the working distance between the two stations was not proportional to the product of the length of the two aerial lines, but that within certain limits it followed Marconi's law on the proportionality between the length of the antennae to the square root of the distance to be traversed (see page 123).

The conclusion was also arrived at that the nature and the section of the conductor have no sensible influence on the facility of transmission, and that the presence of a capacity placed at the upper extremities of the wire was not justified by the results.

Notwithstanding the precautions taken and the improvements introduced into the apparatus, a true telegraphic correspondence was not obtained before 1900; sometimes the messages arrived even during bad weather, at others,

they failed even in fine weather. In 1900 the superintendence of the experiments having been entrusted to Chevalier Bonhomo, captain of a sloop, better results were obtained, following upon systematic experiments made, as to the part which the regulation of each single piece of apparatus had upon the regularity of transmission.

Captain Bonhomo increased the potentials of the battery of accumulators, studied carefully the insulation of the aerial wire and its appurtenances, adapted simple coherers in which the vacuum had been carried to its highest point, substituted to the single aerial wire multiple wires (see page 126) and introduced other modifications which removed all uncertainty from the regulation of the relay, thus realising much more certain transmission.

Notwithstanding all this, the distance limit still remained at about 45 miles, and the maximum speed was only about 24 letters a minute. The most important improvement was that of the employment of a self-decohering coherer, proposed by Paolo Castelli, already described by us at page 186, which, by permitting the use of the telephone for receiving, simplified largely the receiving apparatus.

In these new conditions, matters changed completely; the regularity in transmission was thus insured, and the distance and speed notably increased. It became possible to carry on signalisation between Palmaria and Leghorn, a distance of about 45 miles, with sparks of about $\frac{1}{8}$ th of an inch in length, at the transmitter, and messages were received at the Porto Ferraio Lighthouse, despatched from Leghorn, Gorgona, and Palmaria, at a maximum distance of 90 miles.

Thanks to the Castelli coherer, they were able, in September, 1901, to effect clear and precise transmission to a great distance (200 kilometres) about 120 miles between a station set up at Mount Telajone (the island of Caprera) and another placed near the semaphore of Mount Argentario. After these experiments, the two stations were dismantled. The Telajone station, because it was too subject to atmospheric discharges, was replaced by another a short distance away, on the point Becco di Vela on the island of Caprera. This station was equipped on Marconi's second system and has been for two years in radiographic

communication with the Monte Mario station near Rome and with that of Leghorn at the respective distances of 150 and 160 miles from Becco di Vela.

The antenna shewn at Fig. 68, page 124, is actually that of Becco di Vela, from whence starts an aerial wire formed of four wires joined in parallel like that used in Biot's station (see Fig. 244), having a total height of 160 yards from the point at which it enters into the apparatus shed. This latter is situate in a small brick building specially constructed, divided in two. In the first division is a gas motor and a dynamo for charging the accumulators (18 elements). In the second is a table on which are arranged the apparatus almost in the same way as shewn at Fig. 170. To the right are two induction coils giving one inch spark, arranged in parallel, and close to them is the tapping key. Then comes a little battery of four Leyden jars to be used in the transmitting circuit for the emission of waves of about 200 feet in length. Then come another six jars of larger size for waves of 450 feet in length. To the left of these is placed a box containing the magnetic detector, and yet further to the left is placed a receiver with an ordinary coherer and the Morse printer. From the above it may be seen that this station is fitted for syntonisation for waves of two different lengths, which are indicated respectively by *A* and *B*. According to whether it is desired to use one or other of these two pitches for reception, it is necessary to join up the receiving apparatus to a "jigger" specially tuned to the one or other pitch.

In June, 1903, at the epoch in which I was kindly permitted to visit the above station under the direction of Lt. Amicigrossi, this had only been worked when syntonised for *A* or long waves. The service was undertaken only for military purposes, and the average speed of transmission at the distance of 250 kilometres was at the rate of 40 letters a minute; however, the signals did not always come out clearly, and the apparatus was constantly needing regulation. The reception of messages at the telephone of a "detector" came out clearly but somewhat weak. Later on the waves *B* were also applied, and from that time the service greatly improved. Of the other experiments performed by

the officers of the Royal Navy we have already spoken at Chapter IX., page 326.

One of the most recent trials made by the Italian Navy in radio-telegraphy was that undertaken by Captain Bonhomo on board the cruiser "Marcantonio Colonna" in order to ascertain the radius of action of the existing station on the Italian coast. During these trials Captain Bonhomo tested the carrying power from the station on each ship while using various forms of radiators, and has ascertained that it is possible to do without the famous 50 metre antennae which up to that time had been thought indispensable.

The "Marcantonio Colonna" succeeded in establishing communications up to 200 miles distance with 52 feet of vertical wire and a lateral extension of 150 feet of horizontal wire. The Italian Navy is actually performing successful experiments under the Artom system (see page 299). Lately radio-telegrams have been sent successfully from Mont Mario to Ponza and to Maddelana (see Fig. 251) without it being possible for the one station to tap radio-grams sent to the other.

Italian Radiographic Service.

We owe to the Italian Ministry of the Marine the initiation of a complete installation and service of radio-telegraphy, which comprehends in its radius the whole of Continental and insular Italy and the waterway that surrounds them up to a distance of 300 miles from the coast line.

For this service are set aside the 15 stations marked at Fig. 251, each of which has a transmitting power equal to a radius of about 200 miles. These stations are the following:

Cape Mele (Liguria), Palmaria (Spezzia), Fort Spuria (Messina Lighthouse), Cozzo Spadaro (Cape Passaro), Cape Sperone (Sardinia), Becco di Vela (Caprera), Monte Mario (Rome), Camp alle Serre (Elbe), Ponza, S. Maria di Leuca, Asinara (Sardinia), Gargano, Monte Cappuccini (Ancona), Malamocco (Venice), S. Giuliano (Trapani).

These are so arranged that any ship in Italian waters will always be within the radius of action of at least one of

the said stations, and that the radius of each single station shall overlap that of its neighbours, so as to constitute a continual radio-telegraphic connection for the whole of Italy. The radius of action of the said station and the cone of shadow that might be thrown by unforeseen obstacles have been determined by Captain Bonhomo in the cruise which he undertook on board the "Marcantonia Colonna" (see the preceding page) and will be published in the relative charts.



Fig. 251.

All these stations, with the exception of that of S. Giuliano, are actually at work, and the authorisation has been published by virtue of which the said stations are thrown open to regular commercial service and for the exchange of telegrams between them and ships provided with the Marconi apparatus that may be within a radius of 200 miles from the coast.

The charge for telegrams exchanged with ships is fixed at

63 centimes ($6\frac{1}{2}$ d.) per word. As this service has not been fitted up for multiple communication, there are several regulations for fixing the turn of each ship according to their tonnage, the hour of their departure, and the direction and speed, so that, for example, preference will be given to that ship which during its journey shall be the first to get out of action.

The Bari-Antivari Service.—On August 3rd, 1904, the public radiographic service between the Italian stations and Bari and the Montenegrin station of Antivari was inaugurated. The two stations erected at Marconi's expense are in connection with the ordinary telegraphic lines and may therefore serve for international exchange of telegrams in that manner. In the telegrams which were sent during the inauguration, it is stated that a speed of 37 words per minute was obtained with the detector. The Italian station rises in the locality known as San Cataldo, about 2 miles N.W. of the port of Bari (see Fig. 252). At a few yards from the sea are erected two wooden towers about 150 feet in height, at the same distance the one from the other, from the summits of which, but insulated from them, is stretched a steel wire cable that supports the conducting wires which constitute the aerial pavilion. These conductors, at a height of 24 ft. from the ground, are joined together, forming a single conductor that enters, always well insulated, into the building of the station, where the receiving and transmitting apparatus, the ordinary telegraphic apparatus communicating with the central Bari station, and the necessary plant for furnishing the electrical energy required for working the station and for illuminating purposes, are placed.

The plant itself consists in a Campbell petroleum motor of about 5 H.P. which drives by means of a belt an alternator and a continuous-current dynamo; a battery of a hundred accumulator elements, which ensures a continuous service of 3 hours' duration. Besides this there is an emergency set consisting in a 10 H.P. benzine motor coupled to a dynamo and to a second alternator.

On the Montenegro side the station is situated close to Pt. Volovotza; in the neighbourhood of Pristan and is similar to that at Bari, from which it stands about 120

miles away. The radius of action of the two stations is over 350 miles.

The radio-telegraphic apparatus employed are tuned to 3 different pitches, that is to say, pitch *A* and pitch *B*, that are already in use on the stations of the Royal Navy (see page 381) are for use, the first for a distance of 100 and the second at 300 kilometres; the 3rd pitch *C*, which is peculiar to the Bari-Antivari line, is suitable for distances of 500 kilometres (320 miles).

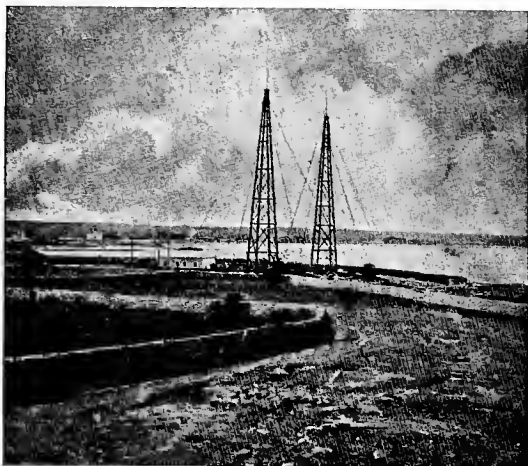

Fig. 252.

The tariff for telegrams from Italy to Montenegro is 9 cents ($\frac{9}{10}$ ths of a penny) per word, (of which $\frac{5}{10}$ ths are taken by Marconi, as his fee for radio-telegraphic transmission) besides a fixed fee of 1 franc (10d.) for each telegram.

By this means a trifling rebate has been possible from the previous rate. This line, besides the convenience it renders for communication between Italy and Montenegro, can also serve for international communication, as in many cases it offers considerable saving in expense, especially in

communication with ships between the parallel of Corfu and Ancona, the usual tariff of which is 63 cents ($6\frac{1}{2}$ d.) per word.

It would appear that the capital necessary to the installation amounted to about 100,000 francs (£4,000). It is said that the Italian Government has previously considered the desirability of connecting these two stations with the submarine cable, which would have cost 2,000,000 francs (£80,000) with an annual upkeep of about £2,000.

The Ultra-powerful Station of Coltano.—Up to the present time the most powerful radiographic station in Italy is that of Bari; however, Marconi, after the first successes obtained with his ultra-powerful station of Poldhu and Table Head, conceived the bold idea of joining Italy with the Argentine by the means of two ultra-powerful stations capable of communicating with one another direct, notwithstanding that their distance is about 6,000 miles, that is to say, nearly double that which exists between the aforesaid trans-Atlantic stations. The Italian Government favours Marconi's idea, and a law has been passed which concedes a sum of 800,000 fs. for this purpose, with the condition that a corresponding Argentine station should be erected simultaneously within three years.

Marconi chose for the new station the spot called Coltana, near Pisa; the plans of the buildings have already been got out and the power of the electric plant, which will be from 2 to $2\frac{1}{2}$ times more powerful than that of Poldhu, has been fixed upon, requiring, as it will, several hundreds of H.P. However, a grave difficulty arose at the beginning of the work, as the Argentine Government rejected the propositions made by the Marconi Company, for the erection of an ultra-powerful station on its territory, under the pretext that this would be too onerous and too uncertain in its results.

It is now under consideration whether the erection of a station at Coltana may turn out useful even independently of a station in the Argentine, as it may serve to put Italy in direct communication with the other extra-powerful stations already existing in Europe and in North America. As this, however, would necessitate a modification in the law voted by the Italian Parliament, the members Crespi and

Bartelli have taken the initiative and have brought forward a measure to grant such modification at the next opening of Parliament. Others, however, have advised that before undertaking to erect a plant on such a grand scale, it would be better to await the suggestions that may be furnished by a long experience with the ultra-powerful stations already erected.

CHAPTER XI.

WIRELESS TELEPHONY.

TELEPHONY differs from telegraphy, inasmuch as the first method transmits articulate voice, whereas the second limits itself to the transmission of signals, based on a conventional alphabet that can reproduce correspondence. In telegraphy the period of the oscillations is unimportant, but for telephony, the reproduction of that enormous quantity of minute vibrations that go to form articulate sounds, necessitates a corresponding rapidity in the oscillations.

As in wireless telegraphy many means were tried before waves were employed, so numberless trials were made to telephone without wires, until at last Marconi pointed out that electric waves presented a new means for the solution of the problem.

Various Systems.

Gavey and Preece's Experiments.—It appears that the first experiments in successful wireless telephony go back as far as 1894, and they were those conducted by Gavey across Loch Ness in Scotland.

At a distance of about $1\frac{1}{2}$ miles from one another, two parallel wires, each about 4 miles in length, were stretched, the extremities of which were taken to earth. On one of these was inserted a Deckert microphone, with a battery of dry cells (14 volts), and in circuit with the other was a telephone which reproduced faithfully speech pronounced before the microphone.

Preece, in 1899, on repeating the experiments noticed a

very great improvement in transmission when the extremities were placed in communication with metallic sheets plunged in the sea.

In England a practical application of this fact was quickly made by connecting telephonically the isle of Skerry's lighthouse with the coastguard station of Cemlin, a distance of about 3 miles. On the isles a line about 700 metres in length was placed, and at the Cemlin station another lying parallel to it and of about 3 miles in length was stretched. The two lines terminated in a metallic plate immersed in the water, and the other extremity communicated with an ordinary telephonic arrangement.

A regular service has been carried on for several years, and communication is as easy and as certain as if there were a line uniting the two points.

A little later on, Gavey set up a similar installation at a greater distance (8 miles) between Rathlin Island and Ireland. A short line of about 1 mile in length stretched in the island, allowed the Rathlin lighthouse to communicate telephonically with a line of 6 miles in length stretched on *terra firma*. The two stations had their terminal plates immersed in the water; transmission through the lines of force took place in a manner similar to that indicated at Fig. 1, page 9.

Ducretet and Maiche's Experiments.—A similar arrangement was adopted in 1902 to communicate overland. The terminal plates of the two stations were buried in the ground, and it was found that the greater the distance between the two stations, the greater also should the distance be between the earth plate, and that this distance would vary also with the nature of the intervening soil and of its vegetation. Thus, with a base of 180 ft. Ducretet was able to transmit to stations at 1,000 metres (3,000 ft.) with little woods intervening.

On analogous principles (see page 20) were based the experiments carried out by Maiche in 1903, at the Castle of Marçais, belonging to the Prince of Monaco. In order to transmit to a distance of 400 metres a base line of 20 metres in length sufficed, and by increasing the length of the base line to 450 metres (say 500 yds.) transmission was effected up to 7,000 metres (say 8,000 yds.) away. At this

distance telephony was no longer clear, but telegraphic signals were transmissible with sufficient precision.

The inventor intends to carry out other experiments between a land station and a ship having a wire free in the sea, so that he can vary the length thereof while the ship is going further out.

Ruhmer's experiments.—In the experiments described hitherto, although there is no connecting wire between the two stations, parallel wires, the total length of which is not very different from that at a distance between the two stations, are necessary. True telephonic wireless communications are those described by us at Chaps. IV. and V., with which transmission to satisfactory distances were obtained.

Among the systems therein described, that which attained the most striking practical results were those of Simon and Reich (page 51), perfected by Ruhmer. The principal improvement imported by Ruhmer was that of the selenium cells, he having found the manner of preparing a selenium cell sensitive to the more intense rays of the voltaic arc (blue and violet), while the ordinary cells shewed greater sensibility for the red rays. The experiments undertaken by Ruhmer early in 1902 on the Lake Wannsee, near Berlin, by means of an 8-10 amp. arc lamp and projector of about 13" in diameter enabled him to converse at a distance of 4 miles, even on rainy days and through a foggy atmosphere.

In the same year, but later on, in the presence of the Emperor of Germany, other trials were executed at Kiel, between the stationary ship "Neptun" and the armoured ship "Kaiser Wilhelm." The words pronounced on board the "Neptun" were distinctly heard until the armoured ship had reached Stollergrund, a distance of 20 miles off.

Systems Worked by Electric Waves.

After the discovery of wireless telegraphy by means of electric waves, many attempts were made to apply the same principle to telephony; however, since telephonic apparatus does not admit of the employment of those powerful discharges that are employed in radio-telegraphy, a means was sought which would lend itself better than air to the trans-

mission of ethereal vibrations, and, by analogy with known acoustic facts, that solids and liquids conduct sound better than gases, water and soil were preferred as conductors of the electric waves.

Placher's Receiver.—For this kind of communication self-decohering coherers are the most adapted, as being those which permit exact reproduction at the receiver of the frequency of the waves emitted by the sending apparatus; for this reason, special receivers were constructed having the degree of sensibility and the readiness to receive an impression necessary to this end.

One of these is the Placher receiver (see page 200), which, like the Walten and Armors (page 200 and 205), is based upon electro-capillary phenomena.

The tube which acts as a capillary electrometer ends in a recipient divided into two parts by a membrane. The variations in level that the incoming electric waves produce in the liquid contained in the capillary tube cause the membrane to vibrate, along with the air containing the second part of the recipient, from which start two acoustic tubes that are applied to the ear in order to hear the sounds emitted by the membranes.

The inventor uses as an electrolyte a solution of potassium cyanide containing 1 per cent. of silver cyanide and 10 per cent. of potassic hydrate.

Lonardi's System.—Rudolph Lonardi, as far back as 1897, that is to say, a short time before Marconi's first successes, discussed the possibility of basing a system of wireless telephony on electric waves. To this end he proposed to cause the two spheres of the Righi oscillator plunged in oil to vibrate by means of the sound waves which were transmitted, keeping the difference of potential between the terminals of the coil or of the electric machine constant.

Since the intensity of the vibration depends upon the distance between the two spheres, electric radiation vibrating in unison with the sound that causes the spheres themselves to vibrate should be obtained. Lonardi believes that as a receiver, a coherer so sensitive as to vary in resistance synchronously with the vibrations of the electric wave would serve, and thinks that a selenium receiver that partakes of this property (as far as regards light, and to some extent also

with regard to electro-magnetic waves) might serve the purpose. Such a receiver ought to be connected to the antenna, and be shielded by a screen that is opaque to light but transparent to electric waves, and be inserted in circuit with a battery and the primary of a coil, the secondary of which should communicate with the telephones destined to reproduce the sound.

It would appear that Lonardi left his system in the state of a project only.



Fig. 253.

Collins' System.—The most extensive experiments in wireless telephony have been hitherto those experienced in America by A. F. Collins.

The apparatus is represented at Fig. 253. It consists in a transmitter and a receiver that can be united in a single piece of apparatus, which will then act as a double station.

The following description, though not too clear, we reproduce, as it is the one given by the inventor.

The primary of the sending induction coil is in series with the transmitter (which appears to be an ordinary microphone), a battery, a changer, and a switch. The ends of the secondary of the coil are in communication with an earth plate and with a compensating capacity. In shunt with the ends of the secondary wire is arranged a Leyden jar. The receiver consists in a closed circuit having in series a telephonic receiver, a dry cell, and the secondary of a transformer, whose primary is taken to earth similarly to the secondary of the transmitting coil.

According to the inventor's theory, in the secondary of the transmitting apparatus that is connected to the soil, electric waves of great length (that is to say, of low frequency and high potential) are produced, and discharges between the coil and earth through the wire and the plate would take place instead of the explosive discharges that occur in air in ordinary wireless telegraphy.

Propagation would therefore take place through the earth, and would be, according to the inventor, facilitated by the fact that the waves being long would be less liable to be absorbed by ponderable masses, in precisely the same manner that the red luminous waves penetrate air and fog more effectually than the violet rays, which are shorter (see page 63).

The greater conductivity shewn by the earth for waves emitted from these apparatus is attributed by the inventor to the greater density of the ether round the atom of ponderable matter than in the vacuum.

In a homogeneous medium, as water, the ether united to the medium would transmit long electric waves farther and better and with less distortion than in a heterogeneous medium such as earth. Hence, the inventor believes that water is the best medium for telephony, as it is for wireless telegraphy.

Collins' experiments were begun at Philadelphia towards the end of 1899, and in 1900 he sent and received speeches through the earth at a distance of about 200 feet. Later on, Narberth (Pa.) was selected as the trial station, and in 1901 a new apparatus was tried across the River Delaware

to a distance of about a mile (11,609 metres), and in 1902 this distance was extended to three miles. The instruments were located on two hills, having the river valley lying between them, some stone quarries, several railway lines, and a telephone service.

Voice was reproduced weakly, but the articulation was perfect. In 1903 many experiments were made on Lake Rockland, N.Y., and although it was not attempted to increase the above-mentioned distance, the instruments were so greatly improved that articulation was clear and the loudness sufficient for all commercial needs, up to a distance of five kilometres, or say three miles.

In order to render the system of commercial applicability, call-bells were fitted up at the two stations that acted without communicating wires. The inventor adds that the value of wireless telephony lies in its fitness in transmitting conversation from one ship to another. Besides this typical case that represents the true sphere of action of the system, there are others to which it may be applied, such as communicating with an island when the laying of a cable would be too costly, or in those localities in which permission to erect or the means of erecting poles or stretching wires is not obtainable.

More recent news describes experiments on the Collins' system between ferry boats in motion on the river North. Between Jersey and New York, with one terminal from the telephone in the water and the other attached to a flagstaff, telephonic communication was easily exchanged between two ships moving in opposite directions between 500 and 600 feet apart.

Russo d'Asar's System.—Even before Marconi had begun his work, Professor M. Russo d'Asar had undertaken experiments in wireless telephony in the Gulfs of Naples and of Genoa, the scope of which was to be able to announce to a ship the approach and the direction of approach of a steamer. The system of transmission adopted was mechanical, and was based upon the property possessed by water of transmitting to great distances perceptible sonorous waves.

His apparatus consisted of two microphones that received through two tubes attached to the sides of the vessel the

noise made by the steamer's screw, and transmitted it in a magnified form to a telephone that shewed on which side of the ship the steamer lay, and whose presence was perceptible even at a distance of 80 or more kilometres (55 miles about).

These experiments were later on repeated on board the Royal despatch boat "Rapido," which had been placed by the Ministry of Marine at the disposition of the inventor.

It would appear that later on d'Asar abandoned this system in favour of one based on the use of electric radiations. In fact, in 1903 he caused experiments to be undertaken in wireless telephony at Nuremberg, between the tower of Fureth and a hill about four kilometres away. Nothing, however, is known of the apparatus used, which is said to have been enclosed in a little box upon a tripod, similar to those used in photography. It is believed, however, that transmission was effected by sending a beam of parallel electric waves, which could be directed to considerable distances.

Capeder-Telesca's System consists in a funnel closed at the bottom by a membrane, into which the operator speaks. To the membrane is connected a microphonic contact inserted in circuit with a strong battery, this contact consisting of two steel springs in a receiver containing brine of the strength of 1 of salt to 100 of water. In circuit with the battery is likewise the primary of a coil, the secondary of which communicates with two balls a few millimetres apart, constituting the exciter; the two balls are connected with the inside coatings of two condensers, the outer coatings of which are in connection, one with the antenna and the other with earth.

When speech takes place before the funnel, the microphonic contact sets up powerful variations in the current of the battery, hence a series of currents of variable tension in the circuit and of high tension in the coil takes place, consequently, sparks of variable intensity occur in the exciter, varying according to the oscillations of the springs of the microphone. These sparks are accompanied by electrical oscillations that are reproduced in the sky rod, which radiate them into space.

At the receiving station the sky rod carries the oscillations

thus received to a coherer having silver or tin electrodes, separated by a space filled with graphite, which is kept in rotation by means of a clockwork movement, and is inserted in circuit with a battery. In this same circuit one or more telephones are connected up in parallel.

The explanation of the reproduction of sound is of the simplest nature. The waves of variable quantity which arrive determine the variations in the quantity of current that passes through the telephone, and this transforms them into sound in unison with those emitted before the membrane of the transmitter.

The inventors succeeded in obtaining reproductions of sound even when using graphite coherers that were motionless, but only weakly, imperfectly and interruptedly.

The Pansa System.—The engineer, Gregorio Pansa, has applied to the solution of this problem, besides the usual laws of the transmission of electric waves to a distance, the property manifested by some metals when subjected to discharges or to electric undulations.

The sending station is furnished with a 4 kilowatt generator, a coil capable of giving a 10" spark, a Righi oscillator, and an electro-motor that drives a rotary mercury interrupter.

The electric waves produced by the oscillator are taken to a pavilion of the reversed pyramid type similar to that at Poldhu (Fig. 28) but of rather lesser height (80 feet) whence they are radiated. Voice transmission is effected by speaking before a special apparatus that the inventor keeps still secret, but which acts as a current interrupter. The current thus interrupted by the voice produces in the oscillator electric waves likewise interrupted, but are gathered by the receiving station, passing through a coherer, which opens and closes a circuit in which is inserted a battery of accumulators. This is connected up to a Righi oscillator which reproduces the undulations.

An apparatus, likewise kept secret, on being struck by such waves enters into vibration and gives rise, like any other vibrating membrane, to a reproduction of the sounds transmitted.

Up to the present time the Pansa telephone has been

only able to work to a distance of a few kilometres. When used for great distances the vibrations of the apparatus are graven, as in the phonograph, on hardened wax cylinders, and are then reproduced.

The Campos System.—The engineer Campos, who, as we have said at page 302, studied the conditions necessary to the application of the Duddell arc to wireless telegraphy, endeavoured to realise the possibilities of using such an arc in a telephonic system. He pointed out that according to Mitzuno, if an ohmic resistance be placed in shunt with an inductive resistance included in an oscillatory circuit, it influences by its variations the period of the system; so that between determined values of the said resistance, minute variations in the latter produce powerful variations in the oscillatory period of the system.

Campos therefore concludes that the introduction of a microphone in shunt with the inductance of a Duddell circuit would allow of the production of the said variations of ohmic resistance, as an effect of the sonorous undulations striking the microphone, and hence the possibility of contriving a system of telephony, profiting by the properties of the Duddell circuit.

The de Forest System.—It is announced that de Forest also is working to resolve the problem of wireless telephony, and he believes that he can compass this end by using continuous currents of very high voltage, basing himself, like Campos, on the phenomenon of the speaking arc.

Majorana's System.—The most recent researches in this direction are those which have been made by Professor Q. Majorana at the Physical Institute of the University of Rome. Majorana is under the impression that the resolution of the problem is not to be found in the employment of persistent electro-magnetic waves, as those obtained in the Duddell circuit, even when these are thrown into vibration by the Hewitt lamp (see page 304) owing to the small amount of energy to be obtained, and he has recourse therefore to the discharges of electro-static machines, or, better still, of coils.

The most efficacious manner thought out by the inventor would be a realisation of Lonardi's project (see page 391), viz. that of causing the sonorous vibrations to vary the sparking distance between the spark gaps of a primitive

Marconi apparatus. The spark gaps connected to the secondary of an induction coil, fed by the alternating town-current (40 periods a second), would have one electrode fixed and the other, consisting of a vein of mercury, inserted in the secondary of a transformer, the primary of which is traversed by the currents of a microphone before which speech is effected.

The microphonic currents thus transformed cause the streak of mercury to vibrate, giving rise to considerable displacements, for which reason the sparks that are continually being discharged between the fixed electrode and the vein of mercury undergo variations of length which are rhythmical with the sound emitted before the microphone.

At the spark gap a constant stream or blast of gas is kept up (see page 118) that maintains the necessary regularity for the occurrence of the sparks. By using as a receiver a magnetic detector (page 192) the inventor has been able to obtain an exact and perfectly comprehensible reproduction of the words spoken by means of the electric pulsation of the antenna.

The radiating antenna was placed outside the building, the receiving antenna was a piece of wire of about a metre in length, completely surrounded by the body of the building. Majorana reckons that in the open air, with an antenna at the detector similar to that at the transmitting station, the carrying power of telephonic transmission would have been of some kilometres' distance.

The inventor observes that this arrangement presented inconveniences, because the mercury vein becomes altered under the influence of the successive discharges so as not to be fitted for continuous work, and he proposes to follow out other contrivances to obtain the pulsatory electric vibrations, among which that of seeking a microphone capable of working with high potential currents and of introducing therein the communication between the spark gap either with the antenna or with the ground.

Since the goodness of all such communications depends on the quantity of energy radiated, so the pulsation of resistance in such a microphone would produce analogous pulsations in the electric waves radiated, thus offering a new means of wireless telephonic transmission.

CHAPTER XII.

VARIOUS APPLICATIONS AND CONCLUSIONS.

THE application of wireless telegraphy does not limit itself to the exchange of signals at a distance, but is extending itself to a great number of other services, some of which are also entrusted to ordinary telegraphy, others belong exclusively to the domain of the wireless.

The number of such services will naturally go on increasing with the number and the carrying power of the stations, and with the increase in the certainty of communication.

Over-sea Communications.—These are the ones in which wireless telegraphy is *facile princeps*, and may be considered as being their real field of action, partly because sea water presents a better vehicle for the electric waves than land, and partly because communication is effected more easily between moving bodies at sea, a function which ordinary telegraphy is utterly powerless to effect.

We have seen that, thanks to wireless telegraphy, the isolation of ships crossing the Atlantic has ceased, since they, apart from the facility of receiving communications from the ultra-powerful stations, can receive and send messages to the coasts by means of the network of stations installed thereon or on islands, which are but few hundreds of miles out of the route of the ocean greyhounds. And the publication of the daily paper, the *Cunard Bulletin*, on board these vessels *en route*, containing the news of the world, is a striking proof that this isolation has ceased.

Given the means of sending and receiving news almost without intermission, and having thus increased for ships *en voyage* the safety of the transit by being able in cases

of danger or of injury to ask for help or to receive information on the most suitable place where succour can be had, and not only for ships but also for lighthouses, whether floating or established on little islands, the feeling of security engendered by the use of radio-telegraphy is greatly enhanced.

Distant expeditions in lonely seas, as those undertaken to the Poles, profit also largely by the help given by wireless telegraphy in giving news or asking assistance; and it is already announced that Dr. Scholl, who is organising an expedition to the North Pole, is in treaty with the Braun-Siemens Company for the installation of a station at Spitzburg, with which a station on board his ship may be able to keep up continual communication.

Another important service that radio-telegraphy may render to shipping is that of being able to receive correct *time*, which, as is well known, is of the highest importance to naval men to enable them to determine the exact position of the ship.

The indication of the time, besides being got from the neighbouring coasts, could be, perhaps, indicated in a manner somewhat similar to that which is done in large cities by the firing of cannon at determined hours. That is to say, at a certain established hour a radiographic signal might be sent from any ultra-powerful station, which would be transmitted almost instantaneously in every direction, and would thus give the hour to all ships that were ready to receive it.

It has also been suggested that radio-telegraphy might be made use of to warn automatically ships of the presence of certain dangers, such as submerged rocks, sandbanks, etc., and also to signal from lighthouses and semaphores in foggy weather. Applications of this kind have been made in France by Captain Moritz and in England by J. Gardner. It is sufficient for this purpose to instal at the desired spot a transmitter with an automatic keyboard, which consists of a wheel, the periphery of which is divided into short and long dashes, corresponding in the Morse alphabet to the name of the place from which signalling is taking place.

On the periphery of this wheel, which is driven by a clockwork or other motor, rests a contact that leads to

the transmitting battery, which thus sends the desired signal.

Application to Meteorology.—Scientific service of the highest importance, as this is, can certainly be greatly improved by means of radiographic despatches sent by ships. It is well known that the weather reports and predictions are made in the central observatories by observing the atmospheric conditions in the largest surrounding zone possible. That portion of the zone which is overland is rich in data derived from the different observatories which are united telegraphically with the central office, but that which lies over the sea is wanting almost altogether in such data, for which reason any charts illustrative of these portions, are compiled in an uncertain manner by inductive reasoning only. These data wanting hitherto can be easily supplied by radiograms from ships specially dedicated to this service, and weather forecasts could thus be given with much greater exactitude.

It is announced that the *Daily Telegraph* has completed a contract with the Marconi Company, in order to have from the ships that pass the stations of Ireland, Scotland, and England, radiograms on the temperature, direction of the winds, and state of the sky, in order to improve its daily weather chart.

Overland Communication.—Even on land, although, as we have already said, communication is more difficult, and can be carried to shorter distances than oversea, radio-telegraphy is very helpful, and may render services some of which can hardly be expected from ordinary telegraphy.

Nearly everywhere overland radio-telegraphic stations have been set up, from which it has been found that transmission is effected with difficulty to distances greater than 40 miles, a distance which varies upon the conditions of the subsoil lying between the two stations.

It would appear, however, according to some experiments made by Marconi between Fraserburgh (Scotland) and Poldhu, that transmission along the coast, which would be a condition intermediate between those of open sea and inland, can be effected easily to distances very much greater than those which are purely overland.

Messages between Trains in Motion.—This problem had

already been studied with other telegraphic systems (see pages 29 and 31), but radio-telegraphy gives at once the most elegant and efficient solution. In this direction experiments crowned with success have been made on the military line from Berlin to Zossen and on several American lines, some of which have adopted definitely this system. (see page 292).

Particulars of the experiments undertaken by Professor Biscan at the Toeplitz station are as follows:

The car carrying the apparatus was coupled to the end of a train, and had two wires projecting on its outside. Hardly had the train approached to within five miles of the Toeplitz station, whence continuous despatches were being transmitted, than the telegraphic apparatus on the car began to work perfectly in a manner similar to that in ordinary telegraphic apparatus.

At New York the system was tried on a very quick train (96 kilometres an hour), when messages were successfully sent to the stations on the journey up to nine miles in advance.

Communications in Mountainous Regions with Balloons, etc.—Telegraphic messages between valleys and the summits of high mountains, as also between the earth and balloons, have succeeded admirably. In fact, between Chamonix and Mont Blanc there is now being set up radio-telegraphic communication in order to effect correspondence with the Janssen observatory. News from London tells us that in that city the application of wireless telegraphy is being studied with reference to its application to firemen; Guarini has even proposed for such a service a special apparatus that would give automatic warning to the fire stations of the place at which a fire has broken out. This apparatus consists of a thermometer, in which a pointer actuated by the rise of temperature closes a relay that sets into motion a clockwork movement, which, by means of a wheel bearing short and long contacts on its periphery, similar to the one described at page 400, closes the circuit of an electric wave exciter, that thus telegraphs to the fire station the locality in which the fire is taking place.

Military Telegraphy.—The overland service is very important in military operations, not only because of the

difficulty of establishing ordinary telegraphic communication in a short time, but also because it is often necessary to communicate with cities or fortresses that are besieged, or for other reasons inaccessible. We have already given at pp. 239, 253, 266, 347, descriptions of different systems of radio-telegraphy adapted to military use; each nation has now its own special type, and all are busy studying the means of adapting radio-telegraphy to this service, of which one of the essential conditions is quickness in setting up the stations.

Among the experiments which have been described in detail we may note those of Lts. Ducretet and Melin at Tunis, with the Popoff-Ducretet system, under conditions approximating as far as possible with those of actual warfare; making use of native labour, ordinary tents for the stations, antennae supported by poles already in existence, with the obstacles of hills, and other impediments, such as bad atmospheric conditions, between the stations.

Communication was established in three hours, and succeeded perfectly up to a distance of 8 miles. There is no doubt that radio-telegraphic stations will be made use of in the actual siege of Port Arthur, but up to the present time any definite news on this subject is not to hand.

Mechanical Applications.—Doubtless radio-telegraphy is an example of transmission of energy to a distance. The energy received by the coherer is certainly very weak, but hopes are still entertained of being able to transmit, by means of electric waves, sufficient quantities of energy to supply useful mechanical work. On this hope is based a prize of 15,000 francs that the International Congress of Aerial Navigation, sitting at the International Exhibition of St. Louis, has offered to him who will give experimental proof of being able to transmit without wires energy equivalent to $\frac{1}{10}$ th H.P. to a distance of at least 300 metres from the source of power.

The application that could be made of this to the propulsion of balloons is self-evident. However, independently of the direct transmission of considerable amounts of energy to a distance, even the minute quantities that can be sent to the actual systems may be made use of to throw into action at a distance devices worked by means of locomotors.

It is easy to understand that the relay, which under the ordinary systems closes the local circuit of the Morse, could be made to close or open the circuit of a motor, and thus from a distance to start, stop, or reverse an engine, close or open the circuit of electric lamps, or, in a similar manner, by admitting the current from a local battery current round the coils of an electric magnet, to control the movement of a rudder in a ship at sea from a distance on land.

Experiments of this kind have actually been made with Armorl's electro-capillary relay (page 205).

Physiological Application.—Professor Gallerani of the Camerino University has shewn experimentally that the nervo-muscular system is as sensitive to electric waves as though it were a coherer or a detector. Gallerani has, in fact, used as a transmitter an apparatus with antennae similar to Marconi's, and as a receiver, a frog prepared according to Galvani's method. Using a tapping key, he has been able to produce at a distance contractions in the frog, which have been registered by means of a suitable rotary graphic apparatus, admitting that a similar action would also take place in the human nervo-muscular system, it would be clearly demonstrable that the cause of the influence of distant electrical discharges, atmospheric or therapeutic, would depend upon this sensitiveness.

Concluding Remarks.—The progress realised by radio-telegraphy in the few years that have elapsed from the day in which Marconi announced it as a practical means of communication are really astounding.

Its field of usefulness is, however, so vast, and the exigencies of the different services to which it lends itself are so varied, that it must be admitted that in its present condition it is far from being what we might call fully satisfactory.

Atmospheric electricity, the disturbing action of sunlight, (see page 94) the number and delicacy of the apparatus necessary even for small distances, the slowness of transmission, and above all, the extreme difficulty of obtaining independent action of the different stations, are so many formidable enemies to radio-telegraphy.

However, even as it stands, the system has imposed itself as an indispensable means of communication,

especially in certain important cases where no other means can be substituted.

Wireless telegraphy must not, however, be considered as a substitute to ordinary telegraphy, but simply as a deputy, in cases in which for some reason, sometimes purely financial, ordinary telegraphy is not applicable. On every occasion that it is possible to stretch a line between stations to be put into communication ordinary telegraphy is to be preferred, even if the expense be somewhat high, because the certainty, the secrecy, and the simplicity of communication which it presents are certainly far superior to those which are obtainable with wireless telegraphy.

In many cases the financial question will be that which will decide in the adoption of the one or the other system. There is no doubt that in the greater part of the installations of any importance, especially those across the sea, the expense of the first outlay, if not also that of working and of maintenance, is greater in the case of ordinary telegraphy, for which reason, it may be in excess of the figure which in view of the importance of the profitable work of the line, it may be wise to reach. In such a case wireless telegraphy gives a satisfactory solution of the economic question.

Ireland and Spitzburg, for example, could not certainly hope to lay a cable that would do away with their isolation at a price that would give any interest on the outlay, but the discovery of wireless telegraphy has already led to the idea of joining them telegraphically with continental Europe; and the day is not far distant when the traveller, buried along with his ship in the icy fastnesses of the highest latitudes, will be able to send daily news of himself to his country.

It is altogether another thing where the traffic is sufficient to pay for the laying of a cable; this, although immensely more expensive than a couple of radiographic stations, is not a single line, but several independent lines, which are thrown across between the two stations, and the line will therefore have a potentiality 8 or 10 times greater than that of the radio-telegraphic installation.

The potentiality of the radio-telegraphic line could be augmented in the case that the trials of multiple communication, which are said to have succeeded in the experimental

way (see page 327), should turn out successful should be employed practically. If, indeed, a single station could send simultaneously with the same radiator 10 different despatches, each one receivable by a special receiver at the receiving station, the usefulness of the line would be tenfold; but the solution of such a programme, that theory would lead us to believe realisable by means of syntony, has shewn itself to be so difficult in practice that, although it has been stated that this has been successfully done (see page 326), no working station undertakes any other but single communication.

The most experienced radio-telegraphists affirm that up to the present time the efficacy of syntony amounts to this, that within the extreme limits of the potential of a transmission, an apparatus tuned with the transmitter receives messages much better than one not tuned.

This agrees perfectly with what takes place in acoustics. If one listens from afar to the sound of an instrument until the distance be such that the instrument can be heard with the naked ear, all the notes will be perceptible. But, if the distance be increased to such a point that the sound be no longer heard, and then a resonator capable of strengthening a given note be placed against the ear, nothing but that note will be heard. It will be seen that in order to feel the effects of syntony, it will not suffice to tune the two stations, but, what is more difficult, to measure the intensity of the radiation to the distance to be reached, in such a manner that such an intensity shall be insufficient to excite a receiver that is not tuned, but will excite one that is tuned. In practice, we see and read that even with the most recently perfected installations (see page 385), the different tunings are employed rather to communicate to different distances than for multiple communications to equal distances, for which reason that in the Italian radio-telegraphic service, although adapted to work between stations having two pitches at their service, establishes (see page 384) a turn in order that there should not be simultaneously more than one communication between the ships themselves or between the different coastal stations.

Therefore, notwithstanding the grandiose experiments of Marconi, which have demonstrated the possibility of trans-

Atlantic communications, and although it has been shewn that the gigantic electric waves emitted by the ultra-powerful stations do not disturb the service of communication at short distances (in the same manner that the roar of a cannon does not upset our perception of a musical melody), nevertheless, unfortunately, it does not appear that radio-telegraphy can compete with, much less supplant the cable system in this field. I say unfortunately, because the contrary is greatly to be desired, but such a substitution could not take place, except in the case that the new system should present notable economic and practical advantages over the old one, and that such advantages should so benefit the immense interests connected with trans-Atlantic communication that the injury inflicted on a few capitalists could be accounted negligible. Up to the present time the Marconi Wireless Co. is the only one that has grappled with the difficulties of trans-Atlantic communications on the wireless system; and although it appears that its example will be followed by the De Forest Co., as it has been announced that a contract has been entered into between this latter and the Government of the United States to connect, radio-telegraphically, New York with Japan, yet these must be looked upon as isolated trials of doubtful commercial success; whereas, nearly all the undertakings of these and the other radio-telegraphic companies confine themselves within the narrower and more modest limit of transmitting messages to short or medium distances, viz. from 60 to 300 miles, with, presumably, more lucrative results. Unfortunately, in this field, besides the struggle of overcoming the technical difficulties which are neither small nor few, there arises that between the industrial interests of the companies engaged therein, and this struggle is embittered by the fact that the special conditions under which radio-telegraphy is carried on seem expressly designed to exasperate. Here it is not the case, as in many other commercial undertakings, of a simple competition that will resolve itself into a diminution of dividends, but of a real struggle for existence, since the work of one company excludes almost entirely the possibility of a competitor working in the same radius. Even if a given station did not wilfully desire to render indecipherable the despatches sent

by another, the mere simultaneous transmission of two despatches from two neighbouring stations would render difficult, and often impossible, the reception of both, unless special agreements and conventions were entered upon, a difficulty between rival companies. A solution could be found in international treaties regulating the cumulative radio-telegraphic working between stations belonging to different countries and using different systems; but the attempts made in this direction at the conference held for this purpose at Berlin in August, 1903, failed. Will the conference proposed for October, 1904, have met with greater success?

It will readily be understood that under the present conditions in which radio-telegraphy is worked, great companies, among the first of which is Marconi's Wireless Co., should attempt to bring about a more radical solution of the question, in the shape of a monopoly in their favour; but now it would be impossible, owing to the growing power of the rival companies, and the support offered to them by their respective States, that a general monopoly should be established in favour of any one of them, to the exclusion of the others. Partial monopolies are, however, possible; and in Italy, where the interests of the Wireless Co. are frequently confused with the glory due to Marconi, a monopoly is ensured to the Wireless Co., inasmuch as the regulations of the Italian radio-telegraphic service (see page 382) specially enjoins that stations on the coast are *not* to receive despatches from any ships but those fitted with the Marconi apparatus. Even in England, Marconi's system has taken such deep roots as to have practically become a monopoly; it would, moreover, appear that the company has obtained the right of insisting that no new stations shall be erected by any who cannot prove that the new installation shall not disturb the service of the pre-existing stations—a thing which, in the present state of wave-telegraphy, is anything but easy to *prove* satisfactorily. What will other nations do? If they permit the establishment of similar monopolies, every ship must either be debarred from availing itself of the advantages offered by radio-telegraphy, or else be provided with as many different systems of apparatus as there are nations on the coast she may have to pass. If this were a

matter in which the commercial interests of the companies only were a consideration, it is easy to foretell that one or a few of the more powerful companies would overcome all the others, remaining masters of the field; but the interests involved are too vital, and too jealously guarded to render it credible that the different States would stand inertly by, awaiting the result of this struggle for supremacy without intervening, either diplomatically or scientifically, in order to prevent a service of such vast importance from becoming a private monopoly.

INDEX.

A

- Action at a distance, 3.
- Accumulators, 97.
- Acoustic resonance, 91.
- Ader's patent, 5.
- Apparatus for syntonising, 246.
 - „ necessary, 96.
- Alternators, 97.
- Anders Bull, 314.
- Antenna, 86, 123, 125, 131, 133, 135, 137.
- Anticoherers, 188.
 - „ Schaefer's 188.
 - „ De Forest's, 189.
- Arc, singing, 47.
- Applications, 399.
- Applications to timing, 400.
 - „ „ meteorology, 401.
 - „ „ warning ships, 401.
 - „ „ moving trains, 401.
 - „ „ military work, 402.
 - „ „ mountainous regions, 402.
 - „ „ power transmission, 403.
 - „ „ physiology, 404.
- Arrangement of apparatus, 241, 263, 278.
- Arno's revealer, 196.
- Armorl's system, 20, 296.
 - „ electro capillary, 200, 205.
 - „ repeater, 215.
- Artom's radiator, 135.
 - „ system, 299.
- Ascoli, 311.
- Automatic break, 27.
 - „ transmitters, 104.

B

- Barbouse system, 16.
- Batteries, 97.
- Bell, G., and the radiophone, 6, 49.
- Blondel's coherer, 172.
- Blondel's syntoniser, 310.
- Blochmann's system, 296.
- Blake's patent, 5.
- Bonelli, 5.
- Bouchot, 5.
- Branly's coherer, 163, 178.
- Braun's coherer, 176.
 - „ fieldwork apparatus, 266.
 - „ condenser, 151.
 - „ parabolic radiator, 270.
 - „ systems, 253, 270.
 - „ transformer, 145.

C

- Calculating wave length, 73.
- Calzecchi Onesti coherer, 162.
- Campbell oil engine, 384.
- Campos' telephony, 397.
- Capeder Telesca's telephony, 395.
- Capacity, 33, 105.
- Cervera's system, 295.
- Chant's observations, 125.
- Choking coil, 101.
- Clausen and van Bronck's radiophone, 53.
- Coil choking, 101.
 - „ and contact breaker, 104.
 - „ induction, 91, 97, 101, 104.
 - „ Ruhmkorff, 105.
- Coherer, 5, 83, 160, 169, 171, 172, 176.

Coherer, theory of, 163.
 Cole-Cohen repeater, 213, 330.
 Collins' telephony, 392.
 Coltano station, 395.
 Commercial considerations, 405,
 408.
 Communication between ships,
 349.
 Cooper Hewitt's system, 304.
 Condenser, 32, 99, 105, 148, 151,
 154.
 Connections to earth, 138.
 Conduction systems, 8.
 Contacts, 99.
 Contact breaker, 109.
 " " Cooper Hewitt,
 116.
 " " Dry, 109.
 " " Foucault, 110.
 " " Lodge Muir-
 head, 112.
 " " Mercury rotary,
 113, 114.
 " " Wehnelt, 114.
 Converters, 117.
 Cost of wireless telegrams, 384,
 385.
 "Cunard" bulletin, 399.

D

Damping the waves, 87, 89.
 Daylight affects transmission, 94.
 D'Arsonval's transformer, 147.
 Decoherer, 83, 178.
 " Dorman's, 188.
 " magnetic, 179.
 De Forest's antioherer, 189.
 De Forest's system, 288, 397.
 Detectors, 191, 193.
 " Armort'scapillary, 200.
 " Arno's, 196.
 " Ewing Walter's 196.
 " Fessenden's 197.
 " Marconi's, 192.
 " Placher's, 200.
 " Rutberford's, 191.
 " sensibility of, 200, 201.
 " Tissot's, 193.
 " Wilson's, 192.
 Doenitz' wave measurer, 158.

Dolbear's system, 5.
 " patent, 32.
 Donat, 5.
 Ducretet's coherer, 173, 389.
 Duddel-Campos system, 301.
 Duddel singing arc, 47.
 Dussaud's ultra-violet system, 63.
 Dynamo, 97.

E

Earliest experiments, 3.
 Ears, protected by cotton wool,
 98.
 Earth plates, 28.
 Edison's patent, 5.
 " system, 31.
 Effects of air compression, 123.
 " monopoly, 408, 409.
 " sunlight, 94.
 Electric bell, 83.
 " waves, production, 65.
 " " propagation, 75,
 85.
 " " transmission, 80.
 " " guided, 132, 329.
 Electro capillary relay, 205.
 " " revealer, 200.
 " dynamic induction, 24, 37.
 " motograph, 34.
 " static induction, 23, 31.
 Energy, sources of, 97.
 Engine, gas and oil, 97.
 Evershed's patent, 5.
 Evershed-Lennet's system, 38.
 Ewing Walter's revealer, 196.
 Exciters, 118.
 Experiments by Hertz, 372.
 " " Hughes, 331.
 " " Loomis, 331.
 " " Marconi, 360,
 362, 369.
 " " Preece, 39.
 " " Righi, 333.
 F
 Ferrié's coherer, 173.
 Fessenden's revealer, 197.
 " system, 286.

G

- Gas engine, 97.
 Gavey's telephony, 388.
 Geissler's tube receiver, 35.
 General notions, 1.
 Gintl, 5.
 Graham Bell, 43.
 Guarini's repeater, 214.
 ,, system, 295.
 Guided waves, 132, 329.

H

- Heiten's experiments, 5.
 Hertz' discovery, 5.
 ,, oscillator, 65.
 Highton's system, 15.
 Holtz machine, 105.
 Hughes' coherer, 183.
 ,, printer, 209, 321.

I

- Induction, 22, 34, 35.
 ,, coil, 91, 97.
 ,, sky rod, 93.
 Influence of daylight, 94, 367.
 Infra red systems, 55.
 Interference of waves, 87.
 Introduction, x.
 Italian navy coherer, 186.

J

- Jegou's multicomcommunication, 327.
 Jiggers, 141.
 Joule's law, 48.

K

- Key, Baviera's, 102.
 ,, Ferrié's, 100.
 ,, Fessenden's, 103.
 ,, Marconi's, 100.
 ,, Popoff-Ducretet's, 102.
 ,, transmitting, 37.
 Keyboards, 98.
 Kites, 33.
 Kitzel's antennæ, 134.
 Kitsee's patent, 5.
 ,, system, 35.

L

- Lecher's oscillator, 74, 89.
 Length of spark needed, 98.
 Leyden jars, 88, 150.
 Length of wave, 73.
 Lines of force, 9.
 Lindsay's experiments, 3.
 Lodge-Muirhead military outfit,
 253.
 Lodge-Muirhead new apparatus,
 253.
 Lodge-Muirhead recorder, 211.
 Lodge-Muirhead systems, 240-
 246.
 Lodge's coherer, 161-176.
 ,, decoherer, 187.
 ,, syntonised system, 41.
 Lonardy's telephony, 391.
 Loomis' experiments, 331.

M

- Maiche's telephony, 389.
 ,, system, 20.
 Magnetic coherers, 175, 176.
 ,, decoherers, 179.
 ,, detectors, 83.
 Magni's intensifier, 137, 328.
 Majorana's telephony, 397.
 Marconi's coherer, 169.
 ,, detector, 192, 193.
 ,, jigger, 141.
 ,, key, 100.
 ,, oscillator, 77.
 ,, sending transformer,
 144.
 ,, system, 220, 239.
 Masts, use of, 33.
 Mercadier's experiments, 43, 50.
 Mirrors, 84.
 Morse alphabet, 99.
 Morse's experiments, 4.
 Movable coil relay, 203.
 Multi-communication, 321.
 ,, ,, Cohen-Cole's,
 330.
 ,, ,, Jegou's, 327.
 ,, ,, Magni's, 328.
 ,, ,, Marconi's,
 324.

- Multi-communication. Slaby-Arco's, 322.
 ,, ,, Tommasi's, 327.

N

- Nodons' infra red system, 68.

O

- Oil engine, 97.
 Optical telegraphy, 2.
 Orling and Armstrong's experiments, 19.
 Orling and Braunerhjelm's coherer, 179.
 Oscillations, 86.
 Oscillator, Armstrong - Orling's, 121.
 ,, Hertz, 65, 118.
 ,, Fesenden's, 122.
 ,, Lecher's, 77.
 ,, Marconi's, 119, 77.
 ,, Righi-Marconi, 119.
 ,, Rubmkorff, 120.
 ,, Slaby-Arco, 121.
 ,, Jissot's, 120.
 Oudin's transformer, 147.
 Overland communication, 401.
 Oversea communication, 399.

P

- Pansa's wireless telephony, 396.
 Pavilions, 130.
 Periód of waves, 87.
 Phelps' patent, 5.
 Phelp's system, 37.
 Photophone, 43.
 Placher's revealer, 200, 391.
 Poldhu condensers, 154.
 Poles, use of, 33.
 Popoff, 83.
 ,, decoherer, 184.
 ,, Ducretet coherer, 177.
 ,, ,, system, 283.
 Popp-Pilsoudski system, 294.
 Portable stations, 239.
 Preece's experiments, 39.
 ,, patent, 5.
 ,, system, 296, 388.

- Printer, or registrator, 207.
 ,, Hughes, 209.
 Production of waves, 65.
 Propagation of waves, 75.

R

- Radiators, 123.
 ,, for directed waves, 133.
 ,, ultra powerful, 131.
 ,, with concentric cylinders, 132.
 ,, without antennæ, 135.
 Radiophonic systems, 43.
 Radio-telegraphy, 6, 49, 50, 51, 53, 390.
 Rathenau's patent, 5.
 ,, and Ruben's system, 16.
 Recorder, Lodge-Muirhead's, 211.
 Reception of waves, 82.
 Registrators or printers, 207.
 Relay, 37, 201.
 Relays, electrocapillary, 205.
 ,, movable coil, 203.
 ,, polarised, 202.
 Repeater, 212.
 ,, Armorl, 215.
 ,, Cole-Cohen, 213.
 ,, Guarini's, 214.
 Resonance acoustic, 90.
 ,, electric, 88.
 Resonators, 5, 82, 88.
 Revealers, 191.
 Revealer, Rutherford's, 191.
 ,, sensibility of, 201.
 Rhythm of waves, 87.
 Rochefort's coherer, 175.
 ,, system, 293.
 Ruhmer's radio photophone, 53.
 ,, telephony, 390.
 Rutherford's revealer, 191.
 Russo d'Assar's telephony, 394.

S

- Schaefer's anticoherer, 188.
 ,, system, 296.
 Selected intercommunication, 308.
 Selenium transmitters, 6, 45.
 Sella's ultra violet system, 61.

- Senate's system, 5.
 Shape of waves, 68.
 Sky rods, 85, 91, 105, 123, 125.
 ,, multiple, 125.
 ,, pyramidal, 129.
 Simon and Reich's radio-tele-
 phone, 51.
 Singing arc, 47.
 Slaby's coherer, 171.
 Slaby-Arco's system, 270.
 Smith's patent, 5.
 ,, system, 15.
 Somzee's patent, 5.
 Sources of energy, 97.
 Spark needed, 98.
 Spirals, 30.
 Spontaneous decoherers, 182.
 Station at Alum Bay, 342.
 ,, Antivari, 384.
 ,, Antwerp, 354.
 ,, Amsterdam, 376.
 ,, Asinara, 382.
 ,, Bari, 384.
 ,, Becco di Vela, 381, 382.
 ,, Berlin, 341.
 ,, Biot and Calvi, 357.
 ,, Bologna, 334.
 ,, Borgogna, 378.
 ,, Borkum Island, 352.
 ,, Bournemouth, 342.
 ,, Breamdown, 336.
 ,, Cape Cod, 361.
 ,, Cape Mele, 382.
 ,, Cape Sperone, 382.
 ,, Charlottenburg, 340.
 ,, Coltano, 375.
 ,, Cozzo Spadaro, 382.
 ,, Elbe, 382.
 ,, "E. S. Goodwin," 346.
 ,, "Flying Huntress," 343.
 ,, Gargano, 382.
 ,, Gorgona, 379.
 ,, Kotka and Kohland,
 354.
 ,, Kampew, 376.
 ,, Lavernock Point, 41,
 334.
 ,, Leghorn, 378.
 ,, Lizard, 355.
 ,, Lofetana Islands, 376
 ,, Malines, 354.
 Station at Malamocco, 382.
 ,, Messina, 382.
 ,, Monte Mario, 381, 382.
 ,, North Haven, 363.
 ,, Palmaria, 339, 378.
 ,, Ponza, 382.
 ,, Poole, 342.
 ,, Porthcurnow, 368.
 ,, Portland, 352.
 ,, Portsmouth Harbour,
 352.
 ,, Rome, 337.
 ,, San Cataldo, 384.
 ,, Salisbury Plain, 335.
 ,, South Foreland, 344.
 ,, St. Katherine, 356
 ,, Spezzia, 338.
 ,, Poldhu, 361.
 ,, Table Head, 369.
 ,, Telajone, 380.
 ,, Trapani, 382.
 ,, Ultra-powerful, 386.
 ,, Venice, 382.
 ,, Wei hai Wei, 377.
 ,, Wimereux, 344.
 Steinheil's experiments, 4.
 ,, and Michel's system, 18.
 Stevenson's patent, 5.
 Stone's syntoniser, 313.
 Strecker's experiments, 19.
 Sumner-Tainter, 43.
 Syphon recorder, 187.
 Syntonisers, 156, 246, 274.
 Syntonisation, 310.
 ,, Anders Bull's, 314.
 ,, Ascoli's, 311.
 ,, Blondel's, 310.
 ,, Braun's, 350.
 ,, Hughes', 321.
 ,, Stone's, 313.
 Syntony, 87, 91, 308.
 System, Artom's, 299.
 ,, Blochmann, 296.
 ,, Braun, 253, 350.
 ,, ,, parabolic radiator,
 270.
 ,, Cooper Hewitt, 304.
 ,, De Forest, 288.
 ,, Ducretet's, 389.
 ,, Duddell-Campos, 301.
 ,, Fessenden's, 286.

- System, Lodge-Muirhead, 244, 246.
 ,, Marconi, 218.
 ,, ,, earthed, 224.
 ,, ,, with antennæ, 226.
 ,, ,, with laminae, 224.
 ,, ,, with reflector, 220.
 ,, ,, portable, 239.
 ,, ,, second, 234.
 ,, ,, syntonised, 231, 324.
 ,, ,, multicommu-
 cation, 321.
 ,, Popoff-Ducretet, 283.
 ,, Slaby-Arco, 270, 322.
 ,, Schaefer, 296.
 ,, Telefunken, 307.
 ,, Tesla-Sloane, 297.
 ,, Valbreuze, 305.
- T
- Tesla's transformer, 146.
 ,, Sloane's system, 237.
 ,, system, 36.
 Telefunken system, 307.
 Tissot's coherer, 175.
 ,, revealer, 193.
 Tommasina's coherer, 183.
 Tones, different, 359, 385.
 Transformer, 105, 140.
 ,, Braun's, 145.
 ,, Marconi-Kennedy, 141.
 ,, Marconi's sending, 145.
 ,, Oudin and d'Arson-
 val's, 147.
 ,, Tesla's 146.
 ,, Unipolar, 107.
 Transmission by conduction, 5, 8.
 ,, by induction, 5, 22.
 ,, by electric waves, 5.
 ,, of time, 400.
 ,, through water, 12.
 ,, through soil, 18.
 ,, of electric waves, 78, 80.
- Transmitter, automatic, 104.
 Transmitting key, 37.
 Trials from ship "Campania," 374.
 ,, ,, "Charles Albert," 363.
 ,, ,, "Duncan," 373.
 ,, ,, "Haimun," 377.
 ,, ,, "Lucania," 372.
 ,, ,, "Marcantonia
 Colonna," 382.
 ,, ,, "Philadelphia," 362.
 Trowbridge system, 37.
- U
- Ultra powerful radiators, 131.
 ,, ,, stations, 386.
 ,, violet rays, 7.
 ,, violet systems, 55.
- V
- Valbreuze's system, 305.
 Various applications, 399.
 ,, minor systems, 293.
 Vibrator, undamped, 90.
 Violet rays, 7.
- W
- Walter's syntoniser, 320.
 Waves, electric, 65.
 ,, ,, damped, 69, 70.
 ,, ,, detector, 160.
 ,, ,, frequency of, 71.
 ,, ,, guided, 132, 329.
 ,, ,, interference, 87.
 ,, ,, measurement, 158.
 ,, ,, reception of, 82.
 ,, ,, rhythm or period, 87.
 Wilkins' experiments, 5.
 Wilson's detector, 192.
 Wireless telegraphy, 1, 2, 3, 4.
 ,, ,, in the Italian
 navy, 377.

- | | |
|--------------------------|------------------------------------|
| Wireless telephony, 388. | Wireless telephony, Preece's, 388. |
| " " Capeder-Telesca's, | " " Pansa's, 396. |
| 395. | " " Ruhmer's, 390. |
| " " Campos', 397. | " " Russo d'Assar's, |
| " " Collin's, 392. | 394. |
| " " De Forest's, 397. | " " Simon and Reich's, |
| " " Ducretet's, 389. | 390. |
| " " Gavey's, 388. | Woods-Adler system, 38. |
| " " Lonardi's, 391. | |
| " " Maiche's, 389. | Z |
| " " Majorana's, 397. | Zickler's ultra violet system, 58. |
| " " Placher's, 331. | |

- Kapp's Transformers, 6s.
 Lamps, Electric, Maycock, 6s.
 Land Measuring Tables, Cullyer, 2s. 6d.
 — Surveying, Middleton, 5s.
 — Surveying and Levelling, Walmisley, 6s. net.
 — Field Work and Instruments, Walmisley, 5s.
 Landolt's Optical Activity and Chemical Composition, 4s. 6d.
 Lathes, Horner, 6s.
 Leather Work, Leland, 5s.
 Leland's Wood-carving, 5s.
 — Metal Work, 5s.
 — Leather Work, 5s.
 — Drawing and Designing, 2s.
 — Practical Education, 6s.
 Lens Work, Orford, 3s.
 Lenses, Photographic, Taylor, 3s. 6d. net.
 Lightning Conductors, Lodge, 15s.
 Locomotive Engineer, McDonnell, 1s.
 Locomotives, Cooke, 7s. 6d.
 — Development, Cooke, 2s. 6d.
 Lodge's Lightning Conductors, 15s.
 Logarithms for Beginners, Pickworth, 1s.
 Loppé and Bouquet's Alternate Currents in Practice, 6s.
 Lubrication, Wheeler, 3s. net.
 Lunge and Hurter's Alkali Makers' Handbook, 10s. 6d.
 McDonnell, How to become a Loco. Engineer, 1s.
 Maginnis' Atlantic Ferry, 2s. 6d.
 Magnetism and Electricity, Ashworth, 2s. 6d.
 — — Bottone, 2s. 6d. net.
 — — Houston, 2s. 6d. net.
 — — Maycock, 2s. 6d. net.
 Manual Instruction, Woodwork, Barter, 6s.
 — — Drawing, Barter, 3s. 6d.
 — — Metal Work, Miller, 3s. 6d.
 Manures, Griffiths, 7s. 6d.
 Marine Engineers, advice to, Roberts, 2s. 6d.
 — Drawing and Designing, Roberts, 6s.
 — Drawing Cards, Sothern, 3s. 6d. net.
 — Electric Lighting, Walker, 5s.
 — Questions and Answers, Wau- man and Sothern, 3s. 6d. net.
 Marine Verbal Notes and Sketches, Sothern, 5s. 6d. net.
 Masee's The Plant World, 2s. 6d.
 Mathematical Tables, Hutton, 12s.
 Mathematics, Elementary, Hatton, 2s. 6d.
 May's Ballooning, 2s. 6d.
 Maycock's Electricity and Magnetism, 2s. 6d.
 — Electric Lighting and Power Distribution, vol. i. 6s.; vol. ii. 7s. 6d.
 — Alternating Current Circuit and Motor, 4s. 6d. net.
 — Electric Wiring, Fittings, Switches, and Lamps, 6s.
 — — Details Forms, 2s. 6d. net.
 — Electric Wiring Tables, 3s. 6d.
 Mazzotto's Wireless Telegraphy and Telephony, 6s. net.
 Measurements, Electrical, Crapper, 2s. 6d.
 — — Hobbs, 1s. net.
 — — Houston, 4s. 6d. net.
 Mechanical Tables, Foden, 1s. 6d.
 — Refrigeration, Williams, 10s. 6d.
 Mechanical Engineer's Pocket-Book, Björling, 3s. 6d. net.
 Medical Terms, Hoblyn, 10s. 6d.
 Metal Turning, Horner, 3s. 6d.
 — Work, Leland, 5s.
 — — Miller, 3s. 6d.
 Metric System, Wagstaff, 1s. 6d.
 Middleton's Surveying and Surveying Instruments, 5s.
 Mill Work, Sutcliffe, 10s. 6d.
 Miller's Metal Work, 3s. 6d.
 Millinery, Ortnor, 2s. 6d.
 Mine, Coal, Boyd, 3s. 6d.
 Mineralogy, Hatch, 2s. 6d.
 Model Engines, Alexander, 6s. net.
 Modern Safety Bicycle, Garratt, 3s.
 Moedebeck's Aeronautics.
 Motor Cars, Farman, 5s.
 Motors, Commutator, Punga.
 Motors, Electric, Bottone, 3s.
 — — Hobart, 12s. 6d. net.
 — Hydraulic, Bodmer, 15s.
 Municipal Electricity Supply, Gib- bings, 6s.
 Nadiéine, Drainage, 1s.
 Nenman and Baretto's Spanish Dic- tionary, 2 vols. 21s.
 Neumann's Electrolytic Analysis, 6s.
 Nicolson's Telegraphic Vocabulary, 3l. 10s. net.
 Optical Activity and Chemical Com- position, Landolt, 4s. 6d.
 Optical Instruments, Orford, 2s. 6d.

- Optics, Geometrical, Blakesley, 2s. 6d. net. [net.]
 — of Photography, Taylor, 3s. 6d.
 Orford's Lens Work, 3s.
 — Optical Instruments, 2s. 6d.
 Organic Chemical Manipulation, Hewitt, 4s. 6d.
 Ortner's Millinery, 2s. 6d.
 Owen's Telephone Lines, 5s.
 Parliamentary Companion, Dod, 4s. 6d.
 Pattern Making, Horner, 3s. 6d.
 Peerage, Dod, 10s. 6d.
 Percentage Tables for Analysis, Guttman, 3s. net.
 Periodic Classification and Chemical Evolution, Rudolf, 4s. 6d.
 Petroleum, Boyd, 2s.
 Pharmacy, Thompson. [net.]
 Photographic Lenses, Taylor, 3s. 6d.
 Physical Chemistry, Reyhler, 4s. 6d.
 Pickworth's Indicator Handbook, 2 vols. 3s. each, net.
 — Logarithms for Beginners, 1s.
 — Slide Rule, 2s.
 Pipes and Tubes, Björling, 3s. 6d. net.
 Plant World, Massee, 2s. 6d.
 Planté's Electric Storage, 12s.
 Plumbing and Sanitary Fittings, Sutcliffe, 5s. net.
 Poole's Telephone Handbook, 6s. net.
 Practical Education, Leland, 6s.
 Preece's Telephony, 15s.
 Price's Hoblyn's Dictionary of Medical Terms, 10s. 6d.
 Punga's Single-Phase Commutator Motors.
 Quantities and Quantity Taking, Davis, 3s. 6d. net.
 Radiography and X Rays, Bottone.
 Radium, Bottone, 1s. net. [net.]
 Railway, Electric, Hering, 4s. 6d.
 — Management, Findlay, 7s. 6d.
 — Material Inspection, Bodmer, 5s.
 — Vocabulary, French - English, Serrailier, 7s. 6d. net.
 Refrigeration, Williams, 10s. 6d.
 Repoussé, Leland, 5s.
 Reyhler's Physical Chemistry, 4s. 6d.
 Rider's Electric Traction, 10s. 6d. net.
 Road Construction, Greenwell and Elsdon, 5s. net.
 Roberts' Drawing and Designing for Marine Engineers, 6s.
 — Advice to Marine Engineers, 2s. 6d.
 Röntgen's X Rays, Bottone, 3s.
 Rudolf's Periodic Classification and Chemical Evolution, 4s. 6d.
 Russell's Electric Cables, 10s. 6d.
 Safety Bicycle, Garratt, 3s.
 Saints and their Symbols, Greene, 3s. 6d.
 Salomons' Electric Light Installations, Apparatus, 7s. 6d.
 — Management of Accumulators, 6s. net.
 — Vacuum Tubes, 2s.
 Sanitary Drainage, Nadiéine, 1s.
 — Fittings and Plumbing, Sutcliffe, 5s. net.
 Sennett's Carriages without Horses, 2s.
 — Fragments from Continental Journeys, 4s. 6d. net.
 Serrailier's Railway Vocab., French-English, 7s. 6d. net.
 Single-Phase Commutator Motors, Punga.
 Slide Rule, Pickworth, 2s. net.
 Sloyd, English, Barter, 6s.
 Sothorn's Verbal Notes and Sketches for Marine Engineers, 5s. 6d. net.
 — Questions and Answers for Marine Engineers, 3s. 6d. net.
 — Drawing Cards for Marine Engineers, 3s. 6d. net.
 Spanish Dictionary, Neuman and Baretta, 21s.
 Specialists' Series.
 Specifications for Building Work, Farrow, 3s. 6d. net.
 Steam Jacket, Fletcher, 1s. 6d.
 — Locomotives, Cooke, 7s. 6d.
 — Model Engines, Alexander, 6s. net.
 — Power and Mill Work, Sutcliffe, 10s. 6d.
 Steamships, Atlantic, Maginnis, 2s. 6d.
 Steam Turbine Engineering, Stevens and Hobart.
 Steel Works Analysis, Arnold, 10s. 6d.
 — and Iron Structures, Twelvetrees, 6s. net.
 — Concrete, Twelvetrees, 6s. net.
 Still's Alternating Currents, 5s.
 Storage Battery, Treadwell, 7s. 6d. net.
 Stresses and Strains, Farrow, 5s. net.
 Stevens and Hobart's Steam Turbine Engineering.
 Structural Iron and Steel, Twelvetrees, 6s. net.
 Stubbs' Telephony, 15s.

- Surveying and Surveying Instruments, Middleton, 5s.
 — and Levelling, Walmisley, 6s. net.
 Surveying Field Work and Instruments, Walmisley, 5s. net.
 Sutcliffe's Steam Power and Mill Work, 10s. 6d.
 — Sanitary Fittings and Plumbing, 5s. net.
 Switches, Electric, Maycock, 6s.
 Tables, Electric Wiring, Maycock, 3s. 6d.
 — Mathematical, Hutton, 12s.
 — Mechanical, Foden, 1s. 6d.
 — Percentage, for Analysis, Guttman, 3s. net.
 Taylor's Optics of Photography, 3s. 6d. net.
 Teacher's Handbook of Metal Work, Miller, 3s. 6d.
 Technological Dictionaries, Webber.
 Telegraphic Vocabulary, Nicolson, 3l. 10s. net.
 Telegraphy, Herbert, 6s. 6d. net.
 — Wireless, Bottone, 3s.
 — Wireless, Mazzotto, 6s. net.
 Telephone System of the British Post Office, Herbert, 3s. 6d.
 — Handbook, Poole, 6s.
 — Lines, Owen, 5s.
 — Service, Webb, 1s. net.
 Telephony, Preece, 15s.
 Thompson's Chemist's Compendium, 2s. net.
 Thomson's Apothecaries Hall Manual, 2s. net.
 Thwaite's Gaseous Fuel, 1s. 6d.
 Traction, Electric, Rider, 10s. 6d. net.
 Transformers, Kapp, 6s.
 — Still, 5s. [net.
 Treadwell's Storage Battery, 7s. 6d.
 Trigonometry, Adams, 2s. 6d. net.
 Tubes and Pipes, Björling, 3s. 6d. net.
 — Vacuum, Salomons, 2s.
 Turbines and Hydraulic Motors, Bodmer, 15s.
 Turbines, Steam, Stevens and Hobart.
 Turner and Hobart's Insulation of Electric Machines, 10s. 6d. net.
 Turning Metal, Horner, 3s. 6d.
 Twelvrees' Structural Iron and Steel, 6s. net.
 — Concrete-Steel, 6s. net.
 Vacuum Tubes, Experiments, Salomons, 2s.
 Verbal Notes and Sketches for Marine Engineers, Sothorn, 5s. 6d. net.
 Volumetric Analysis, Coppock, 2s.
 Wagstaff's Metric System, 1s. 6d.
 Walker's Electricity in Homes, 6s.
 — Electric Lighting for Marine Engineers, 5s.
 Wallis and Hawkins' Dynamo, 15s.
 Walmisley's Field Work and Instruments, 5s. net.
 — Land Surveying and Levelling, 6s. net.
 Wannan and Sothorn's Questions and Answers for Marine Engineers, 3s. 6d. net. [net.
 Webb's The Telephone Service, 1s.
 Webber's Technical Dictionary, 4 vols., English, German, French, Italian. [net.
 Wheeler's Friction, its Reduction, 3s.
 Whittaker's Mechanical Engineer's Pocket-Book, 3s. 6d. net.
 — Electrical Engineer's Pocket-Book, 3s. 6d. net.
 Williams' Mechanical Refrigeration, 10s. 6d.
 Wireless Telegraphy, Bottone, 3s.
 — Telegraphy, Mazotto, 6s. net.
 Wiring, Electric, Maycock, 6s.
 — — Details Forms, 2s. 6d. net.
 — — Tables, Maycock, 3s. 6d.
 Wood Carving, Leland, 5s. [net.
 — — Patterns, Andreen, 7s. 6d.
 Wood's Discount Tables, 1s.
 Woodwork, Barter, 6s.
 — Drawing, 3s. 6d.
 — Joints, Adams, 1s.
 Woven Design, Colour in, Beaumont, 21s.
 Wyatt's Differential and Integral Calculus, 3s. 6d.
 X Rays, Bottone.
 Yates' Botany.
 Yeaman and Gay's C. S. Electricity Supply, 10s. 6d. net.

Complete Catalogue of Technical and Scientific Books, Post Free,

WHITTAKER & CO.

2 WHITE HART STREET, PATERNOSTER SQUARE, LONDON, E.C

