

# Radio reception

Harry J. Marx,  
Adrian Van  
Muffling

125











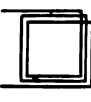
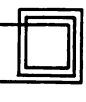











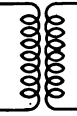
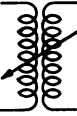
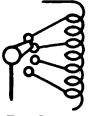
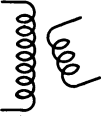
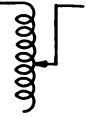
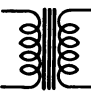
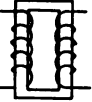





THE NEW YORK  
PUBLIC LIBRARY  
ASTOR, LENOX AND  
TILDEN FOUNDATIONS  
R L

|   |   |   |   |   |
|---|---|---|---|---|
|    |    |    |    |    |
| OUTDOOR   | LOOP ANTENNAE   | SPIRAL  | GROUND  | CONNECTED WIRES   |
|    |    |    |    |    |
| "A" BATTERY   | "B" BATTERY   | RECEIVERS   | CRYSTAL DETECTOR  | VACUUM TUBE   |
|    |    |    |    |    |
| FIXED CONDENSERS  | VARIABLE CONDENSERS   | RESISTANCE  | RHEOSTAT  | GRID LEAK & GRID CONDENSER  |
|    |    |    |    |    |
| FIXED INDUCTANCE  | VARIABLE INDUCTANCE   | TAPPED COILS  | VARIOCOUPLER  | SLIDE TUNER   |
|   |   |   |   |   |
| BAR CORE TRANSFORMERS   | CLOSED CORE TRANSFORMERS  | CHOKES COIL   | HONEYCOMB COIL  | VARIOMETER  |
|  |  |  |  |  |
| POTENTIOMETER   | AMMETER   | VOLTMETER   | PLAIN SWITCHES  | REVERSING SWITCHES  |

Symbols used in Radio Hook-up Diagrams



# Radio Reception

A Simple and Complete Explanation of the Principles of Radio Telephony, and a Full Exposition of the Successful Methods of Radio Reception; with Special Reference to Practical Tuning, and to Radio- and Audio-Frequency Amplifications

By

**Harry J. Marx**

Technical Editor, "The Radio Digest"

and

**Adrian Van Muffling**

Consulting Engineer

*With 92 Illustrations and 38 Hook-up Diagrams*

**G. P. Putnam's Sons**  
**New York and London**  
**The Knickerbocker Press**

1922

H.M.C.M.

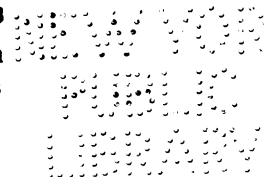

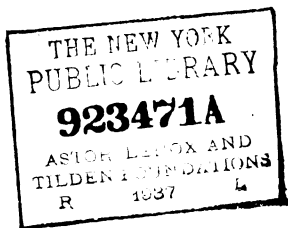

Copyright, 1922  
by  
Harry J. Marx  
and  
Adrian Van Muffling

Made in the United States of America

Replacing copy 69883 A.

ADRIAN VAN  
MUFFLING  
NEW YORK



## FOREWORD

It has been the aim of the authors throughout this volume to cover only such essentials as will convey to the reader a clear conception of the underlying principles of radio reception.

The latest developments in wireless telephony have suddenly brought this means of communication from the physicist's laboratory into the average American home, at first as a means of enjoyment, later—it is to be hoped—as a necessity of everyday life. Under these conditions it is inevitable that many perplexing questions present themselves and that the full possibilities of the apparatus are often not realized. To aid in the understanding of the intricate processes involved, and to offer a solution to the problems that may present themselves, are the objects of this volume.

In the following pages radio reception is taken up step by step, from the simplest forms of apparatus to the most complicated sets—consideration being given to the *relation* of each individual unit to the whole outfit, rather than to a purely mechanical description of various forms now obtainable on the market.

The reader will notice that some statements are repeated once or several times. Wherever this occurs it is done to focus the attention to the most essential fact of which an understanding is necessary for the proper comprehension of the subject that is being discussed.

The authors wish to express their appreciation to Mr. E. C. Rayner, of Chicago, Ill., and Prof. Dayton C. Miller, of Cleveland, O., for their kind coöperation in furnishing a number of the drawings and photographs with which this work is illustrated.

HARRY J. MARX  
Chicago, Ill.

ADRIAN VAN MUFFLING  
New York City.

August, 1922.

## CONTENTS

| CHAPTER  | PAGE |
|--|------|
| FOREWORD. . . . .                                  | iii  |
| I.—ELEMENTS OF ELECTRICITY AND MAGNETISM . . . . . | 3    |
| II.—WAVES AND WAVE ACTION . . . . .                | 23   |
| III.—CRYSTAL AND VACUUM TUBE DETECTORS             | 46   |
| IV.—RECEIVERS AND LOUD SPEAKERS . . . . .          | 67   |
| V.—CONDENSERS AND RESISTANCES . . . . .            | 75   |
| VI.—TUNING AND TUNING APPARATUS . . . . .          | 88   |
| VII.—AMPLIFYING CIRCUITS . . . . .                 | 114  |
| VIII.—ANTENNA AND GROUND . . . . .                 | 128  |
| IX.—BATTERIES . . . . .                            | 145  |
| X.—MISCELLANEOUS APPARATUS . . . . .               | 152  |
| XI.—DON'TS . . . . .                               | 169  |

## APPENDIX

|   |     |
|---|-----|
| I.—RADIO FORMULÆ . . . . .                    | 177 |
| II.—CALCULATION OF TUNING APPARATUS . . . . . | 187 |
| III.—HOOK-UP DIAGRAM . . . . .                | 208 |
| INDEX OF HOOK-UP DIAGRAMS . . . . .           | 231 |
| GENERAL INDEX . . . . .                       | 235 |



## TABLES

| TABLE  | PAGE    |
|--|---------|
| I.—WAVELENGTHS AND FREQUENCIES . . . . .                 | 45      |
| II.—DIELECTRIC CONSTANTS . . . . .                       | 184     |
| III.—HONEYCOMB COIL VALUES . . . . .                     | 185     |
| IV.—INDUCTANCE OF COILS . . . . .                        | 186     |
| V.—ANTENNA CHARACTERISTICS 4-STRAND L                    | 199     |
| VI.—ANTENNA CHARACTERISTICS 4-STRAND T                   | 200     |
| VII.—ANTENNA CHARACTERISTICS SINGLE<br>WIRE L . . . . .  | 201     |
| VIII.—ANTENNA CHARACTERISTICS SINGLE<br>WIRE T . . . . . | 202     |
| IX.—CORRECTION FACTOR K . . . . .                        | 203     |
| X.—TURNS PER INCH OF COPPER WIRE . . . . .               | 204     |
| XI.—WIRE DIAMETERS . . . . .                             | 205     |
| XII.—WAVELENGTH CHARACTERISTICS . . . . .                | 206-207 |





# Radio Reception



# Radio Reception

## CHAPTER I

### ELEMENTS OF ELECTRICITY AND MAGNETISM

THE elementary principles of electricity are today common knowledge, and the reader is more or less familiar with them. To save time and to devote ourselves as quickly as possible to the application of these principles to Radio receiving, no attempt will here be made to elaborate on them. The essential facts of the behaviour of electrical currents are here recapitulated for the purpose of refreshing the reader's memory.

1. An electric circuit is the path through which an electric current flows.

2. Every piece of electrical apparatus has at least two points (terminals) by which it can be attached to a circuit, one through which the current enters and one through which it leaves.

3. Electric current flows only in a continuous or *closed* circuit—that is, a path must be provided through which it can return to its source. It

should be borne in mind that the path is not always visible to the eye. It may flow through the air, or through the ground or through a tube from which the air has been exhausted. But if a current is known to flow we can always trace it back to its point of starting.

4. An electric current always returns to its original source. Hence every kind of generating apparatus has two poles, called positive and negative. The current flows from the former to the latter.

5. Like water in a pipe, a flowing current has rate of flow (measured in *Amperes*) and pressure (also called *Electro-Motive Force*, measured in *Volts*). Just as there may be pressure in a pipe without the water being able to flow, so it is possible to have electric pressure without there being an actual discharge of current.

6. When flowing through a wire, the electric current encounters a resistance which must be overcome by the pressure. This resistance is measured in units called *Ohms*. The resistance may be compared to mechanical friction, and likewise, will cause heating if sufficient current is forced through a conductor.

7. Ohm's law expresses the relationship which always exists between rate of flow, resistance and pressure. According to it:

$$\text{Current} = \frac{\text{pressure}}{\text{resistance}} \quad \text{or} \quad \text{Amperes} = \frac{\text{Volts}}{\text{Ohms}}$$

which is the fundamental formula of all electrical calculations, excepting those dealing with alternating currents. It does not therefore, find much application in matters pertaining to Radio communication.

8. Electrical apparatus may be connected either in series or in parallel. In *series* when all

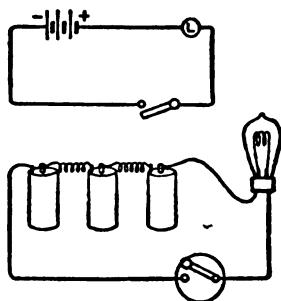

Fig. 1

the current is made to pass through every unit in succession, as in Fig. 1 where the battery, the lamp and the switch are so related.

9. In *parallel* connection the current is divided so as to pass through several units at the same time (Fig. 2).

10. When battery cells (or for that matter any number of electrical sources) are connected in series, the total voltage supplied by them will be equal to the sum of the voltages of each unit, while the amperage will be equivalent to that of a single cell. When they are connected in parallel, the opposite holds true. The voltage is now that

of one unit but the amperages are added together. (See Fig 3.)

So for instance, if it were necessary to obtain a voltage of 8 volts from a set of four dry cells capable of delivering  $1\frac{1}{2}$  amperes at 2 volts each it would be necessary to connect them in series, in which case the amperage in the closed circuit

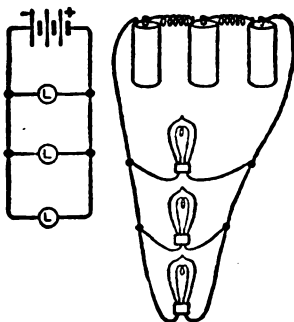

Fig. 2

would be of but  $1\frac{1}{2}$  amps. If the same batteries are connected in parallel however, 6 amperes of current will flow at a pressure of 2 volts.

#### ELECTRICAL CURRENTS

Electric currents can be generated in two ways:—by chemical action and by mechanical motion. In either case it should be clearly understood that no energy is *created* but that a mere transformation of one form of energy—chemical or mechanical—into electrical energy takes place.

In the eighteenth century the Italian physicist Volta first discovered that a peculiar action took place when disks of various materials were pressed together with a piece of felt or paper between that was being kept moist with a salt solution. By adding a large number of such disks, alternating of zinc and carbon, on top of each other, he built his

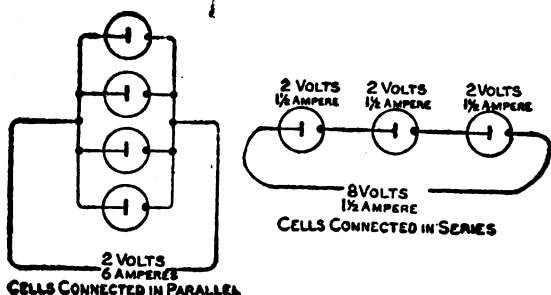

Fig. 3

so-called "Voltaic Pile" and found that a considerable current would flow from the carbon to the zinc disks upon their being connected with a copper wire. That discovery marked the beginning of modern electrical experimentation.

Essentially the modern dry cell is identical with Volta's battery of some two centuries ago. We still use carbon and zinc as the active elements to generate the current; and we still use a salt solution absorbed in some porous material to establish internal electrical connection between the two. However, chemical means of electrical generation are neither lasting nor powerful enough

for most purposes for which currents are required today. They still find a field for usefulness, however, especially for radio work, and a full description of the dry battery will be found later in the present volume.

### MAGNETISM

When an electric current is made to flow in a conductor, for example a metallic wire, there is a peculiar action called *magnetic influence* which makes itself felt in the region immediately sur-

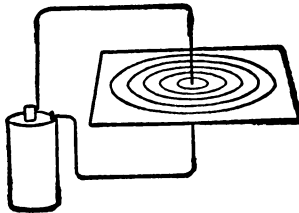

Fig. 4

rounding the conductor, diminishing in intensity as the distance therefrom increases. That such an influence actually exists can be shown by a very simple experiment.

Pass a wire through a hole in a card in the manner shown in Fig. 4 and connect the ends of the wire to the terminals of a dry cell, causing a current to flow through the wire. Now sprinkle some fine iron filings upon the card and note results. It will be seen that the filings arrange themselves



not in haphazard manner but along well-defined lines, called *lines of magnetic force*, or *lines of force* for short. The aggregate of the lines of force is known as the *magnetic field*.

Suppose now the wire were bent in the form of several successive loops, forming a *coil*. In this case the fields surrounding each loop merge into

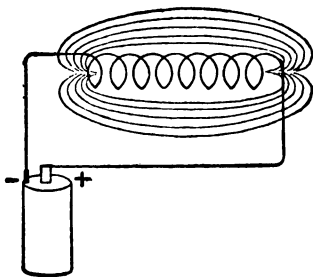

Fig. 5

each other and assume the form shown in Fig. 5 and the strength of the field, that is, the number of magnetic lines of force per unit of area becomes greatly intensified.

If a bar of iron or steel called a *core* is placed within the field it becomes a *magnet* because the lines of force always will follow the path of least resistance which they find in the metal rather than in the surrounding air. Just as a current is said to have a certain direction—from the positive or + pole of a battery to its negative, or - pole, so do the lines of force form a circuit in which magnetic currents flow from a positive to a negative pole.

If the core then is surrounded by the coil as shown

in Fig. 6 the lines of force will issue from one end of the core called the + pole and re-enter it by the opposite end or - pole, and we have thus a complete *electromagnet* or *solenoid* which forms the basis of practically all electrical apparatus in existence, from electric bells to locomotives.

Steel has the property of retaining for a long time any magnetism that has once been imparted to it. Therefore the familiar horseshoe magnets are all made of steel, as are those in automobile magnetos, some of which have been known to retain their strength unimpaired for fifteen years or more. Soft iron cores on the other hand will lose their magnetism almost as soon as the current in the coil is cut off, but they are apt to retain some of it for a very short time (magnetic lag) depending on the purity of the iron. As it is usually desirable to have the lag as short as possible (not more than a few thousandths of a second at the most) it is important that the iron used for cores be as pure as can be obtained. Certain kinds of very soft iron made in Sweden are the best for this purpose. For reasons explained later, cores are never made in one piece but are built up of a large number of sheets or wires fastened together. We have thus *laminated cores* and *wire cores*.

The direction of the magnetic current can be determined by the simple following rule: When the wires in the coil are wound like the threads of an ordinary wood screw and the electric current flows in the direction of our hand when fastening

the screw into a piece of wood, then the magnetic current will flow in the direction that the screw is driven—that is when the current runs clockwise the pole nearest you will be negative. (See Fig. 6.) If any *one* of these conditions is reversed—if

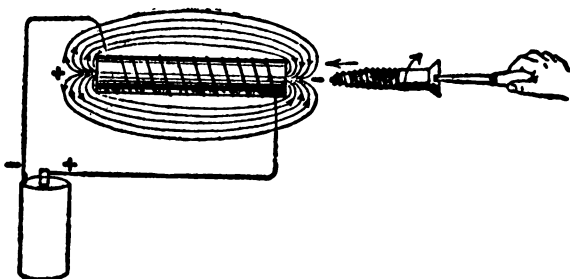

Fig. 6

the current flows counterclockwise or the coil is wound “left handed” the *polarity* of the magnet will also be reversed.

It is now understood how an electric current can be transformed into magnetic energy. The converse also is true, a magnetic field can be utilized to generate an electric current in a closed circuit.

*If a conductor which forms part of a closed circuit is so moved in a magnetic field that it cuts the lines of force of that field an electric pressure (or voltage) is generated in that conductor which causes a current to flow in the circuit.*

This “cutting of the lines of force” can be done in two ways: 1st Case. The conductor (A-B in

Fig. 7) is actually moved by mechanical means between the poles (MN) of a magnet. In this case a current will be *induced* in the circuit (C), the direction of which depends upon the way in which the motion takes place. Thus if the motion is

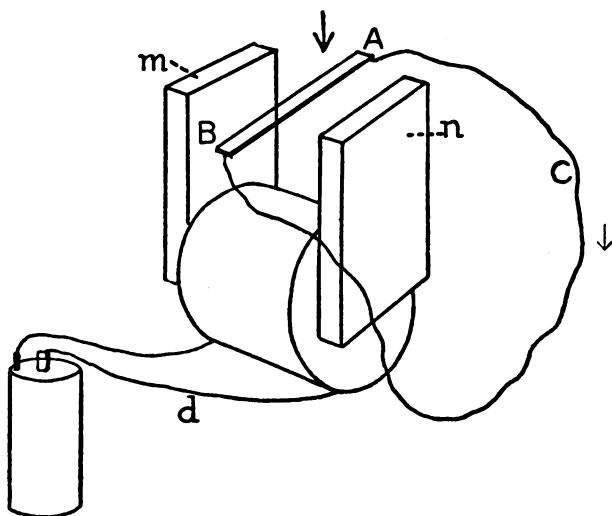

Fig. 7

downward the current will flow as indicated by the arrow, but if the motion is upward the current will be reversed. If the conductor is moved up and down the current in (C) will fluctuate between a maximum in one direction and a maximum in the other, with a period between each fluctuation where the current is zero. Such a current is then said to be *alternating* and can graphically be represented by a curve as shown in Fig. 8 where the

line O X represents the point at which no force is generated. The number of times that two such complete reversals take place in a second is known

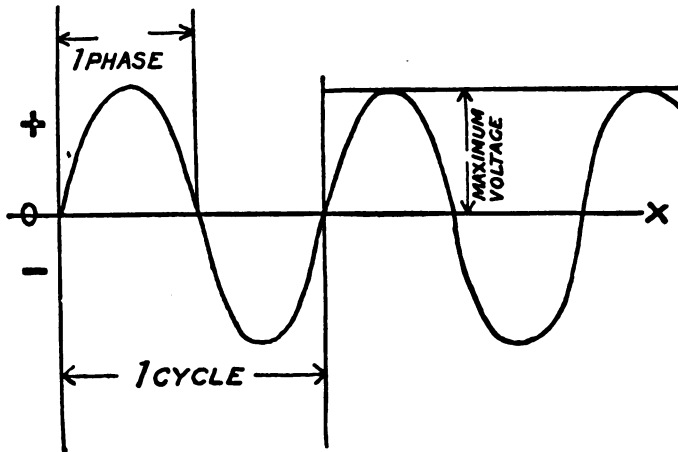

Fig. 8

as the *cycle* of the current. Thus we speak of an alternating current of 60 cycles or 80 cycles meaning thereby a current which is reversed 120 or 160 times every second.

2nd Case. The conductor is stationary (generally consists of a coil wound around an iron bar called the *armature*) and the field is made to appear and disappear by alternately magnetizing and demagnetizing the armature. The effect is the same as in the previous case, as every time the lines of force are generated they have to establish their continuity by passing across the conductor. Now, if two windings, (D) and (E) are wrapped

upon the same core (Fig. 9) a current will be generated in (E) (secondary coil) every time that an interruption takes place in the primary coil (D). This current is called an *induced current*, and will of course, follow the alternations and

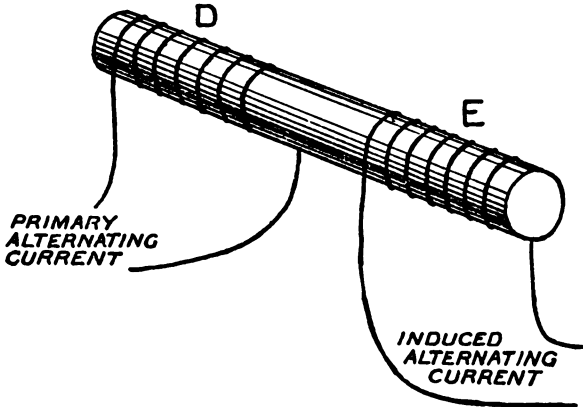

Fig. 9

direction of the original or primary current. This is the principle of a *transformer*. Fig. 10 then shows how both cases of induction can be applied. The battery (K) produces a steady current in one direction only, or what is called *direct current*. This is utilized to excite the electromagnet (F). As the conductor (A-B) is moved up and down between the poles (M) and (N) pulsations of *alternating current* are sent through the coil (D), magnetizing and demagnetizing the core (L). At every reversal of polarity in (L), an induced current is set up in the coil (E). This very simple

apparatus which anyone can rig up with little trouble shows the fundamental principles of electrical generation in a nutshell.

One important fact to be borne in mind is that it is not the *passing* of the current in the primary

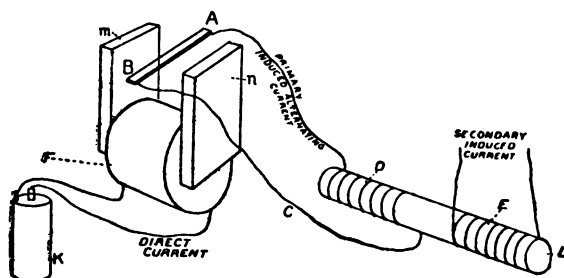

Fig. 10

coil winding, but the *interruption* of that current, which causes induction in the secondary coil.

For that reason the primary current *must* be alternating, or at least pulsating, by which is meant a current the intensity of which varies from a maximum to a minimum without a change in direction. (See Fig. 11.) This change of intensity has an induction effect similar to an alternating current. *Induction is impossible when a steady direct current is used.*

To have induction, it is not imperative to have the coils wound upon the same core. It is merely necessary to have them so placed that any change in the intensity of the magnetic field of one, will affect that of the other. In fact, even the core is

not strictly necessary, although desirable to intensify the field, by giving the lines of force a path to follow and thus avoid *magnetic losses*. Very large currents can be induced from one circuit to another and the pressure or voltage can be changed at will

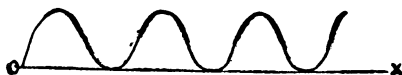

Fig. 11

by a suitable combination of wire sizes and numbers of turns. It is through such transformer coils that the high tension currents generated in large power houses are reduced to limits suitable for operation of street cars or house lighting.

#### INDUCTANCE

*Inductance* is the name given to the property of a circuit or a coil to generate a magnetic field around it. Its magnitude depends upon the current strength, the material of the conductor and the magnetic conductivity (or capacity of concentrating lines of force) of the material through which the lines of force pass. Thus the inductance of a coil surrounding an iron core is much greater than it would be if the core were removed, and that of a coil of 200 turns is greater than that of one of 100 turns only.

The unit of measurement of inductance is called the *henry* which is defined as the inductance of a circuit in which the induced voltage is equal to 1



volt when the primary current varies at the rate of 1 ampere per second. The inductances encountered in radio work, however, are so slight that small fractions of a henry have been given special denominations. (See Appendix.)

#### SELF INDUCTANCE

The inductive effect of a coil may react upon its own winding and cause an appreciable diminution of the current flowing through it. Consider the coil in Fig. 9 energized by an alternating current. During the first half of every alternation while a new current and hence a new field is building up from zero to a maximum, the lines of force, generated from each turn of the winding will be cutting the adjacent turn, with the result that an additional current is induced in them. It can be shown that this current tends to flow in a direction opposed to that of the energizing current and tends to decrease its intensity. As there is thus an induction taking place which reacts against its own generating current this phenomenon is called *self induction*.

Self induction can be experimentally demonstrated as follows: In Fig. 12 (C) is a coil connected in series with the lamp (L) and either alternating or direct current can be admitted to the circuit through the main switch. When direct current flows through the circuit the lamp will burn brightly and neither the coil alone or a core

introduced into the latter will have an appreciable effect. But if alternating current is admitted by throwing the main switch, the lamp will burn dimly due to the "choking" effect of self induction.

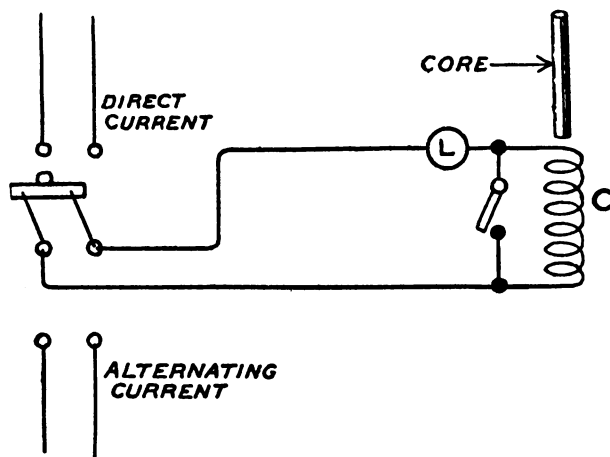

Fig. 12

If a core is now introduced into the coil, its effect may even prevent sufficient current flow to cause the filament to glow at all.

As the effect of self induction is that of holding back the current flowing through the circuit, it can be measured just as resistance is, and its magnitude expressed in *Ohms*. When so expressed it is called *reactance*.

By *impedance* of a circuit, is meant the total resistance in *Ohms* that a circuit offers to the passage of an alternating current, due *both* to the natural resistance of the circuit and its reactance.

## CONDENSERS

Just as it is possible to have water pressure in a pipe without there being an actual flow of water, so can an electromotive force exist in a conductor in the form of electric pressure when the circuit is broken. Thus if a circuit is interrupted, there obviously remains a tension or potential difference in it, which will cause the current to flow again once the connection is reestablished. Electricity may therefore be stored in a conductor somewhat as water can be stored in a pipe. An increase of the surface of the conductor will allow an increase in the amount of current that can be stored. For this reason, whenever such storage of electricity is required, the surface is greatly enlarged by making the conductor in layers of thin sheets; this form of apparatus is called a condenser.

A condenser is a device consisting of a number of plates (tinfoil, copper or aluminum sheets) separated from each other by layers of non-conducting material, called the *dielectric*, which may be glass, celluloid, oil, waxed paper or even air. (Fig. 13.) Each alternate plate is connected to a pole of a circuit. When the circuit is closed the plates will become charged, that is, they will act in a manner that can be compared to the action of a storage battery, as the charge will be retained. It will be given off again if the two poles of the condenser are connected together; the condenser is then said to

be discharging. As the plates of a condenser are separated by the dielectric it will be understood that a direct current cannot pass through it. If the current is alternating, however, a different action takes place: When the flow is in one direction one set of plates is charged positively, the other negatively; when the flow is reversed, the

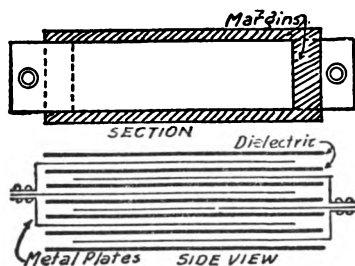

Fig. 13

plates that were charged positively will now discharge back through the circuit. Thus an alternate charging and discharging is produced which corresponds to the phase changes in the circuit.

This action may better be understood by assuming a water chamber in a water line which chamber is divided into two compartments by a flexible rubber diaphragm as shown in Fig. 14. It is clear that a continuous stream of water comparable to direct current cannot flow through the chamber, but that the pressure of the water entering on one side will be communicated to the other, up to the limit of expansion of the diaphragm. If the stream

of water be reversed the diaphragm will bend in the opposite direction. Thus *alternate pulsations of water* will make themselves felt through the chamber. The elasticity of the diaphragm, in a condenser, corresponds to the strength of the dielectric, and the water pressure to the capacity.

The intensity of the charge that can be stored in a condenser depends upon the "effective" area of

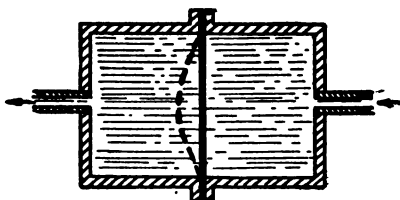

Fig. 14

the plates. By "effective" area we mean the amount that they overlap each other. The *capacity* of a condenser can thus be varied by moving one set in and out of the other, which is sometimes done by a sliding arrangement or, as more often in radio work, by having the plates in the form of a semicircle, one set being held stationary and the other mounted upon an axis. As the latter is rotated, the movable plates move in and out between the fixed plates, and full range of capacity is thus obtained, from minimum to the maximum of which the condenser is capable.

The unit of measurement of capacity is the Farad. This unit is too large for use in radio work and one millionth of a farad, called a Microfarad, has been adopted. (See Appendix.)

## CHAPTER II

### WAVES AND WAVE ACTION

#### WAVE MOTION

To understand how sounds can be reproduced at will at a receiving station thousands of miles away, a study of wave motions and their characteristics is essential.

A wave may be defined as a propulsion of motion through an elastic substance called the *medium*.

The erroneous impression exists in many minds that it is the medium which actually travels away from the point where the disturbance causing the wave is created. But it should be clearly understood that the medium as a whole remains stationary, and the wave action of the individual particles is purely local.

Lay a number of similar coins in a row upon a table so that they will touch each other. Now slide a somewhat heavier coin, like a quarter, along the table against the end of the row, so as to hit the last coin with a smart tap. You will find that the row remains undisturbed and that the only apparent effect is to detach the coin at the other end from its fellows and send it sliding across the

table. We have here a clear demonstration of the propagation of motion by a wave train. What happened is this: When the first coin was touched the force of the blow compressed it somewhat and in regaining its shape, due to the elasticity of the metal, it hit the adjacent coin which was in turn compressed, and so on, until the "wave" reached the last coin in the row. Not having anything to which to impart its energy, this coin had to expend that energy somehow and did so by transforming it into motion. This type of wave is known as a *compression* wave, and is the usual form that wave motion takes when travelling in a solid.

Taking another example: Lift one end of a straight rope and shake it briskly up and down. A wave is thus started in the rope which will travel down its length. It is evident that in this case the wave consists of a successive and individual *vertical* motion of each point of the rope. Supposing the rope to have been divided into a number of short units, then first one unit was lifted to the highest point, then the second, then the third and so on. If the rope is shaken twice, two waves will be started which travel away to the other end, keeping always the same distance apart. If the shaking is repeated rhythmically, a continuous wave motion is started which transmits the energy imparted by the hand to the other end.

The high points of a wave are called the crests; the low ones, troughs. The distance between two



successive crests is the *wavelength*, the height of the crest above the trough, the *amplitude*, while the speed at which the wave apparently travels is called the *frequency*. The latter is expressed by

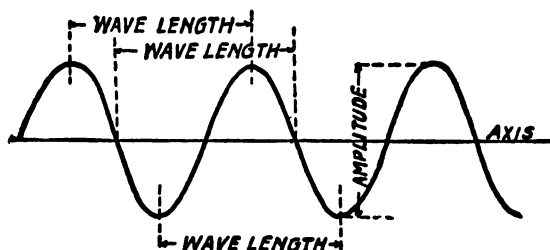

Fig. 15

the number of waves passing a given point each and every second. The above terms are graphically illustrated in Fig. 15, and it is well to bear their relationship clearly in mind.

#### ANALYSIS OF WAVES

Science has gradually realized that all of the perceptions of our senses are due to waves generated in a substance which seems to permeate every thing, and which has been called the *ether*. That such a substance actually exists has long been doubted, but the study of the phenomena in connection with the transmission of heat, light and electricity shows that they are all due to wave actions which cannot be explained unless by the assumption of a medium for these waves to travel in.

All ether waves travel with the same velocity, of

300,000,000 meters per second, which is equivalent to about 186,500 miles. They differ widely in their wavelength, however, and are known to range from a wavelength of 150,000 meters, which are the longest wireless waves yet encountered, to a wavelength so small as to be beyond human appreciation or .000,000,000,05 (one five hundred-billionth) of a meter. All these waves are apparently identical in nature. Some of them can be discovered only by the most delicate instruments, some of them by the sensations of what we know as heat and light; and in the latter case the different colors are again differentiated by wave length variations. Some penetrate so-called opaque objects and are known to us as X-rays; some are invisible to our eyes and to our senses, yet produce certain pathological effects upon the body, such as sunstroke and, it has been claimed, softening of the bones, and finally, some can be detected only by radio apparatus.

The diagram on Fig. 16 shows the full range of ether waves as far as they have become known to us in their various manifestations. It will be noted that there are two gaps in the known sequence of wavelengths, which are marked on the diagram as unknown. That merely means that no one has thus far been able to produce them or has discovered them in nature, and we have therefore no idea as to what their effects will prove to be. It is not unlikely that with their eventual discovery there will be opened to mankind a new range of

possibilities that will put even radio in the shadow. The range known to us at present is truly formid-

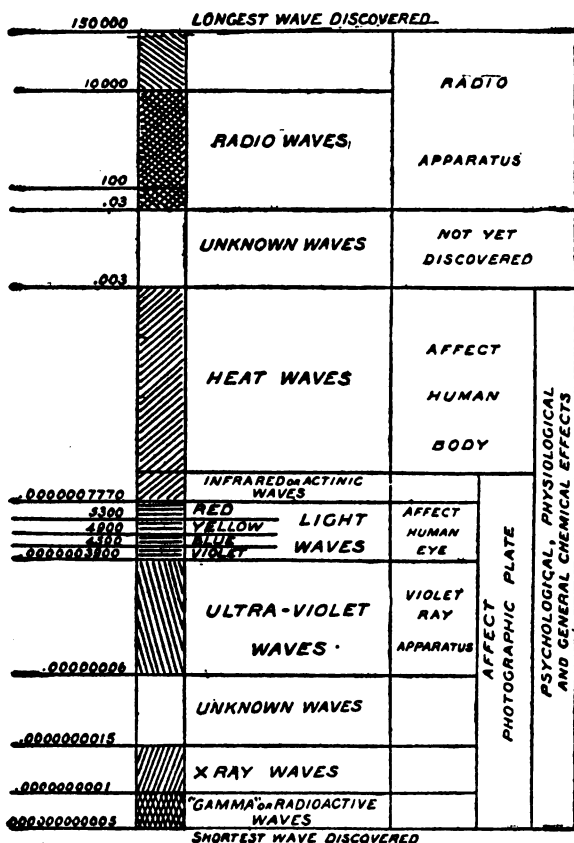

Fig. 16

able, if we consider that the longest wavelength known at present is thirty thousand million,

million times as long as the shortest or "gamma" wave, a figure equivalent to the number of inches travelled over in going around the earth at the equator one hundred and twenty-six thousand times.

#### SOUND WAVES

Sound is a wave motion of the air, not of the ether. If a bell or a piano wire be struck the bell or the wire will vibrate many hundreds or even thousand of times per second. Every vibration hits the surrounding air a slight blow, which starts a wave in the same manner as in the experiment with the coins. From the source of the vibration, these sound waves travel outward in every direction, gradually becoming weaker as the distance from the source increases. In the delicate mechanism of the human ear these vibrations impinge against the eardrums, cause them to vibrate at the same speed and thus produce what we know as sound. The greater the amplitude of the original vibration, the farther will the wave be transmitted; *hence amplitude of sound waves corresponds to the loudness of a tone.* What is known as pitch, on the other hand, is the result of the *number of vibrations per second or the frequency.* The lowest tone which the human ear can "hear" and distinguish, corresponds to 32 vibrations per second, the highest to about 18,000, anything above or below these values being audible not as a

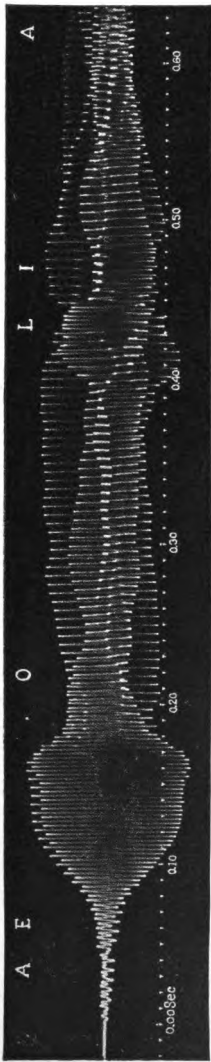

Fig. 17



Fig. 18



musical note but as a "noise." This range is only little more extensive than that of a piano.

Actually, however, sound vibrations are of a more complex nature than the above statements would indicate. There are a great many subsidiary vibrations which determine the character or "timbre" of the sound wave. Our ear has been subconsciously trained to dissociate the typical "overtones" that characterize the various sources of sound and thus we can readily distinguish a violin from a horn, or a piano from the human voice, even though they may all be sounding the same note, and having the same fundamental frequency. The waves emitted by a full orchestra of eighty or more instruments or a chorus of several hundred voices are therefore composed of thousands of fundamental and overtone waves superimposed upon each other, which reach the eardrums simultaneously.

How complicated even the simplest sounds appear is shown in Fig. 17 which is an actual photograph of the human voice vibrations when pronouncing the word "Aeolian." This shows clearly how the overtones which produce the several sounds involved are superimposed upon each other, and that the fundamental tone of the vowel "e" has a greater frequency than the deeper "o." Figure 18 reproduces the characteristic vibration of "e" when pronounced as in "meet," "bee," etc., during  $\frac{1}{10}$  of a second. This sound has a frequency of about 2500 vibrations per second.

The phonograph is an instrument which records an actual impression of such a tone-wave upon a wax surface. The sound waves strike a flexible diaphragm to which is attached a steel point which digs its way into the wax in a manner corresponding to the wave outline. The waxed surface then becomes a record, and the waves can be reproduced in the air whenever desired by passing the point through the groove again and thus causing the diaphragm to vibrate as it did when the record was made.

#### THE TELEPHONE

The telephone affords a means of reproducing sound waves at a distance far greater than the original waves will cover. The sound waves

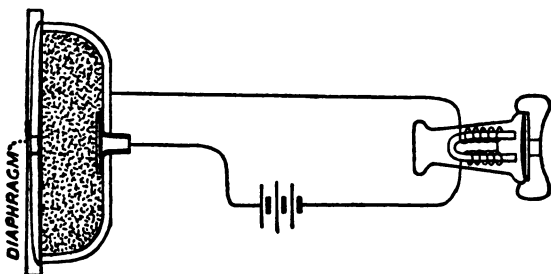

Fig. 19

strike a steel diaphragm which is thereby set in vibration. To the diaphragm (Fig. 19) is attached an electrical contact composed of small pieces of carbon rather loosely held together through which



a current is flowing. When the carbon particles are compressed by the motion of the diaphragm the resistance of the particles is decreased, because they are brought into closer contact with each other, and a greater amount of current flows in the circuit. If this current is made to pass through an electromagnet at the other or receiving end, the magnetic charge in the magnet will vary in accordance with the current changes. The magnet acts upon another diaphragm, which will vibrate in synchronization with the transmitting diaphragm and generate sound waves corresponding to the original ones.

In actual telephone circuits, the arrangement is as shown in Fig. 20. Here the current at the receiving end is passed through an induction coil

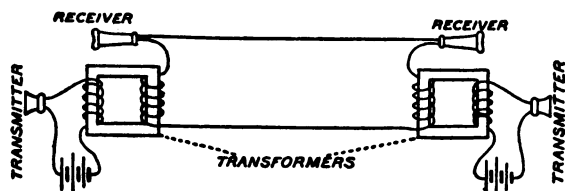

Fig. 20

or transformer and the induced current in the secondary circuit is made to operate the receiver diaphragm. This arrangement enables simultaneous transmission in both directions. The intensity of the current in the primary or transmitter circuit varies or pulsates according to the sound vibrations emitted by the speaker. Thus the

sound waves are reproduced in the form of electrical pulsations in the circuit. This pulsating current, as explained in the first chapter, induces a corresponding secondary current which actuates the diaphragms in the receivers. These in turn reproduce the sound waves, which are heard by the listener.

### HERTZIAN WAVES

In 1877 Prof. Henry Hertz, while conducting a series of experiments with high voltage spark coils, discovered that when a condenser was connected in parallel across the spark gap a peculiar action took place. He noticed that every time a spark was made to break across the gap, some mysterious agency would affect electrical instruments at the other end of his laboratory. He rightly concluded that the spark generated some kind of ether-waves that travelled outward from his apparatus, which were afterwards called Hertzian Waves. For nearly twenty years Hertzian waves remained a laboratory curiosity until Guglielmo Marconi utilized them for the first time for the transmission of messages.

An understanding of the method of generation of Hertzian waves will be found useful for a thorough grasp of the principles underlying radio transmission.

In Fig. 21 which represents the simplest form of wave transmission set, "T" is a high tension spark

coil, which is nothing but an inductance coil, the secondary winding of which is so wound that a very high voltage is induced therein. In practice the secondary voltage will amount to anywhere between 20,000 and 100,000 volts. The primary

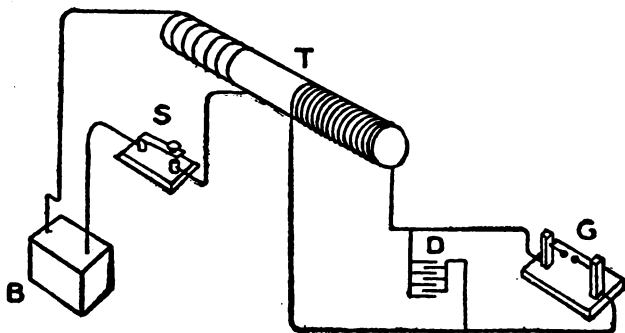

Fig. 21

winding is supplied with current from a battery "B" or any convenient source of current, the circuit being made or broken at the switch, "S." The secondary circuit is continuous except for a gap "G" called the spark gap. A condenser "D" is connected in parallel or "across" the spark gap.

When contact is broken at "S" the primary current will induce a secondary current in the transformer "T." This current will charge the condenser and the tension in the latter increases until the voltage is so high that the current will tend to close its own circuit by jumping across the gap. In so doing, it creates a spark. Now a peculiar action takes place. The discharge of the

condenser across the gap is so rapid that the surge of electrical impulse is carried beyond the zero point and the condenser becomes charged again, but *in the opposite direction*. This charge is immediately gotten rid of through the gap in the form of a return spark. This process is repeated several times, the current surging back and forth and breaking to and fro across the gap, becoming weaker and weaker until it finally dies out.

#### DAMPED WAVES

This complicated action can best be explained by a water analogy. Suppose Fig. 22 to represent two

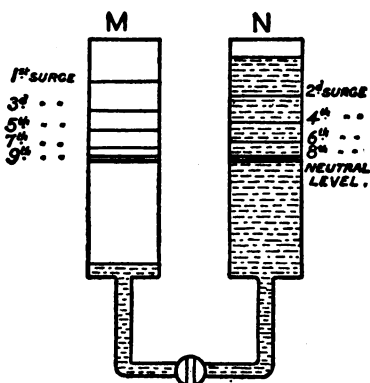

Fig. 22

tanks, M and N connected through a water pipe in the manner shown, the stopcock corresponding to the gap. These can then be compared to two

sets of condenser plates, the difference in level of the water representing the potential difference between them. Now if the stopcock is suddenly opened, the water will rush from N into M and if the original head is great enough, the water, on account of its inertia, will rise in M higher than it would if it were let in slowly. Immediately the water will flow back and the same performance will be repeated. Alternately in each tank, each time the level reached will be somewhat lower than previously, until it finally comes to rest at the same level in both tanks, a condition equivalent to a complete discharge in a condenser, which has thus momentarily become a generator of alternating current. In a water system as well as in an electrical system then, a series of oscillations takes place which begin with a maximum surge and are gradually *dampened* out to zero. A series of currents thus produced is called a *dampened electrical oscillation*.

This can be graphically represented in the form of a *dampened wave curve* as shown in Fig. 23. If they follow each other at short intervals, a wave train will result. (See Fig. 24.) If the electrical oscillations just described are put into an antenna and ground combination instead of a regular condenser, they will set up in the ether a corresponding dampened radio wave.

In a previous chapter it has been shown that if an alternating current is led into a condenser, it will alternately charge and discharge the same

with every impulse of current sent out. It was also stated that air is a good dielectric. Now, suppose an aerial is connected to one terminal of a source of alternating current and the other terminal is connected to the ground, this combination

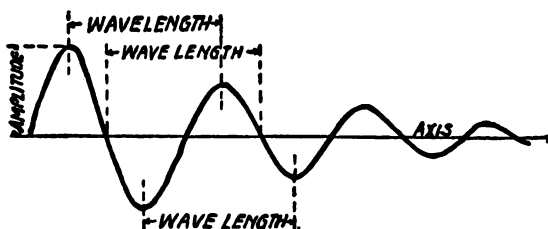

Fig. 23

acts as a huge condenser of which the "aerial" or antenna corresponds to one set of plates, and the ground to the other set.

The antenna (acting as a condenser) radiates this electrical discharge in the form of damped



Fig. 24

waves. It thus becomes the center of an ever increasing set of waves radiating from it in all directions. It is a peculiarity of such an arrangement that if the current impulses charged into the antenna are of high frequency (100,000 or higher) they will be transmitted farther into the

ether than the lower frequencies. Now if another similar aerial and ground combination is set up within the sphere of influence of the radio waves thus sent out they will induce therein an electric charge similar to that of the sending antenna. Thus, the receiving antenna will be charged and discharged with a frequency equal to that of the impulses sent out, and it may then be compared to another condenser *charged from the first*. It is obvious that these impulses can be utilized at the receiving end to energize instruments that will translate them into audible sounds.

In wireless telegraphy then, a series of damped radio waves are sent out into the ether from the antenna in the manner just described. They follow each other with a comparatively low frequency—about 500 impulses per second. This is obtained in practice by having the primary current pass through an interrupter, energized by the magnetism of the transformer core in a manner exactly similar to that of the familiar spark coil of automobile and motor boat ignition systems. It will be noted in Fig. 25 that the primary current passes through the interrupter "I" which consists of a contact point mounted on a short steel spring. When the key S is depressed the current flows momentarily through the primary until the pull of the magnetized core separates the contacts and the current ceases to flow for as long as it will take the spring to bring them together again. This action takes place at a rate of

about 500 contacts per second, and it should be noted *that each time* the current is established, it sets up an induction in the secondary and a *dampened wave* in the antenna circuit "A."

Now a vibration of 500 impulses per second produces a distinct note audible by the human ear.

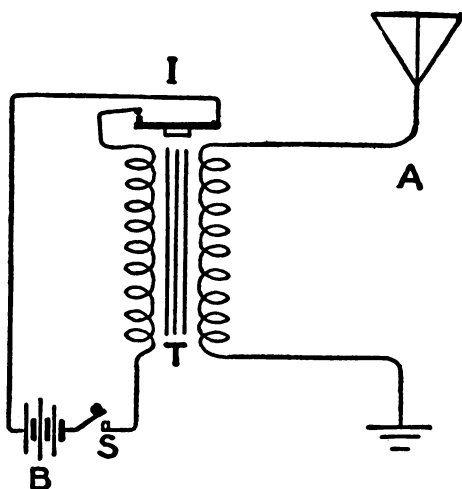

Fig. 25

When these impulses are set up in the receiving antenna by the radio waves they can be used to energize the magnets of a telephone receiver and produce therein a buzzing sound. If the key "S" is depressed according to a prearranged code or the dots and dashes of the Morse system, the telephone receivers will be affected at the other end and the signals can be understood.



## CONTINUOUS WAVES

Damped wave transmission requires a large current and is limited in its application. Of late years the more economical and in many ways more adaptable undamped or continuous system of wave generation has been developed, usually abbreviated to C.W. transmission. (Fig. 26.)

Undamped waves differ from the foregoing in that they are continuous, that is to say, they are

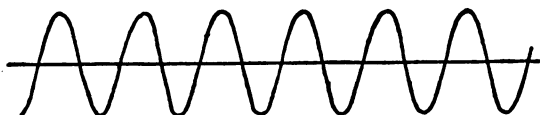

Fig. 26

not built up of successive wave impulses which die out and have to be built up again, but retain the same amplitude. Such waves are produced at very high frequencies—approximately between one hundred thousand to one and one-half million individual waves per second, depending upon the wavelength.

## WAVELENGTH

In determining the character of the various radio waves we do not usually speak of their frequency expressed in oscillations per second, but rather of their wavelength, or the distance between successive wave crests measured in meters. As all waves

travel at a speed of 3,000,000,000 meters per second, the wavelength can be computed by dividing the speed of travel by the frequency, or

$$\text{Wave length in meters} = \frac{300,000,000 \text{ meters per sec.}}{\text{Frequency in cycles per sec.}}$$

The wavelength is usually expressed in formulas by the Greek letter  $\lambda$  (Lambda). If (f) represents the frequency we may write

$$\lambda = \frac{300,000,000}{f}$$

Table I gives the wavelengths corresponding to various frequencies through the range usually employed in radio communication.

By setting a receiving apparatus to respond to only one certain frequency of vibration or wavelength, we can make it record only the vibrations emanating from a receiving station transmitting waves of that particular frequency, and all other waves will be tuned out.

It is by using different wavelengths that several sets of messages can be sent at the same time by various transmitting stations and can be picked up at will without interference. How this is possible can best be understood by a sound analogy. If a tuning fork be held near a piano while the latter is being played, the fork will not be set vibrating until the one note which corresponds to its pitch is struck. When that happens, the sound waves emanating

from the string will strike the fork with a frequency which corresponds exactly to its own frequency. In other words, the wave crests travelling outward from the string follow each other just so far apart that each one gives the necessary push to the prongs of the tuning fork at the proper time to keep it vibrating to and fro. The string is then said to be in *tune* with that particular tone and the vibrations from all the other strings, having another frequency, will not strike the fork in the proper sequence and consequently will not affect it.

As every condenser has capacity, so has an antenna circuit. The wavelength of the radio wave sent out depends upon the inductance and capacitance of the sending antenna, and so of course, of the receiving antenna. In other words, every degree of capacity and inductance corresponds to a certain wavelength and frequency just as the note emitted by a tuning fork or violin string corresponds to a certain sound wave frequency. The inductance can be varied at will by means of a device known as a tuning coil, which is connected in series between the antenna and the ground. The operation of "tuning" a wireless set is therefore analogous to the tuning of a musical string, and by it is meant varying the inductance of the antenna until its period of vibration corresponds to the frequency of the radio waves to be received.

In dealing with radio telephony, as distinguished from radio-telegraphy, the signals that it is desired

to transmit are not merely dots and dashes which can be represented by depressing a key and closing a circuit in a certain sequence, but sounds.

#### MODULATION

It will be understood that radio apparatus must transform the low frequency tone-waves spoken or sung into a transmitting horn into high frequency alternating currents of corresponding amplitude. In Fig. 27 (a) represents the outline of a tone-wave; this line is a graphic representation of the ups and downs of the current which passes out of the receiver during  $\frac{1}{1000}$  part of a second. (b) represents the high frequency alternated oscillations that can be produced in an antenna circuit. Now, if the two curves are superimposed upon each other, that is to say, the amplitude of the antenna oscillations is made to conform to the outline of the sound curve, a composite curve (c) is obtained which represents the shape of the oscillations as they are actually sent out into the ether and caught by the receiving antenna. This process of superimposing the different wave forms is known as *modulating* the current. If it were possible to build receiver diaphragms to vibrate at a rate of hundreds of thousands vibrations per second it would be possible to use the high frequency impulses as they come from the antenna and apply them directly to the receiver. A good deal of the apparatus now required would then not

be necessary. Under present conditions, however, the alternating current must first be rectified into direct current.

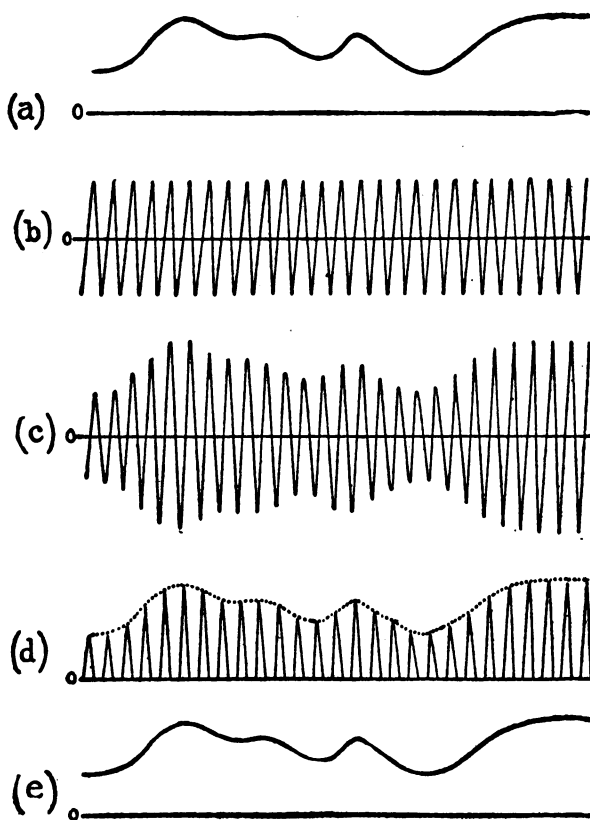

Fig. 27

It has been explained how alternating current is composed of a successive number of impulses, now

in one direction, now in the reverse. To change this into direct current it is necessary to insert somewhere in the circuit a device that will allow the current to pass through *in one direction only*. Graphically the effect is the same as cutting off all the wave impulses below the zero line in (c) Fig. 27. The "rectified" current can be drawn in the shape shown in (d) which represents pulsating direct current.

If the rectified current is passed through the magnets of a very sensitive telephone receiver its fluctuations of current will cause the diaphragm to vibrate. The latter is unable to follow the fre-

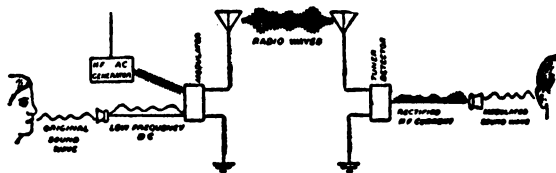

Fig. 28

quency of the radio pulsations clear to the zero line, but can easily follow the ups and downs of the wave crests which are of comparatively low frequency. The motion of the diaphragm will then correspond to the original sound waves, which are thus reproduced, (e) Fig. 27, at the receiving set with more or less fidelity, according to the amount of interferences and distortions that have occurred in this rather complicated train of events, which is illustrated in proper sequence in Fig. 28.

TABLE I

WAVELENGTHS CORRESPONDING TO VARIOUS FREQUENCIES

| Wavelength | Frequency | Wavelength  | Frequency |
|------------|-----------|-------------|-----------|
| 150.....   | 2,000,000 | 1,200.....  | 250,000   |
| 200.....   | 1,500,000 | 1,400.....  | 217,040   |
| 250.....   | 1,200,000 | 1,500.....  | 200,000   |
| 300.....   | 1,000,000 | 1,600.....  | 187,500   |
| 360.....   | 835,000   | 1,800.....  | 166,666   |
| 450.....   | 666,666   | 2,000.....  | 150,000   |
| 485.....   | 618,556   | 2,500.....  | 120,000   |
| 500.....   | 600,000   | 3,000.....  | 100,000   |
| 600.....   | 500,000   | 4,000.....  | 75,000    |
| 700.....   | 428,570   | 5,000.....  | 60,000    |
| 800.....   | 375,000   | 6,000.....  | 50,000    |
| 900.....   | 333,333   | 8,000.....  | 37,500    |
| 1,000..... | 300,000   | 10,000..... | 30,000    |

## CHAPTER III

### CRYSTAL AND VACUUM TUBE DETECTORS

#### THE CRYSTAL DETECTOR

It was shown in the last chapter that the simplest method of transmitting electrical waves through the ether is by means of a high frequency alternating current. It must be understood that this alternating current will not operate the phone receivers so as to give audible sound waves. The current must be rectified and modulated before passing through the receivers.

The simplest form of apparatus for the rectification of high frequency alternating currents is the crystal detector. Its principle of operation is as follows:

If a contact is made with certain mineral crystals by pressing a wire against them and the wire and crystal are connected with the terminals of a source of an alternating current, it is found that very much less resistance is offered when the flow is in one direction, than in the other. The current waves on one side of the O line are allowed to pass through the contact almost without interference, while those on the other side are *almost*



entirely eliminated as shown on the diagram in Fig. 29. This results in a current passing through the circuit which is uni-directional as far as practical purposes are concerned, as the small pulsations in the opposite direction are not sufficiently

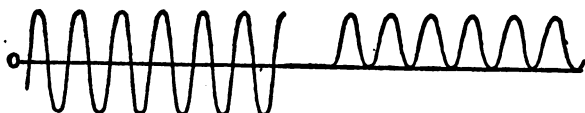

Fig. 29

strong to affect the magnets in the telephone receivers. The latter act as modulators in the manner described in a previous chapter and transform the received waves into sound waves.

The crystals are generally held in clamps or are fastened into cups with Woods metal or some other easily fusible metal. Among the crystals used are lensite, cerusite, silicon, carborundum and galena. Of all, the latter possesses the required faculties in the greatest degree and is therefore almost universally used.

Not the entire surface of the crystal presents this peculiar property, which is concentrated on certain sensitive spots, probably connected with the lines of natural cleavage of the crystal. It is therefore usual to mount the wire on a metal stem which can be turned in any direction until the place of best contact has been found, and is also provided with a thread for varying the pressure between contracts as required. Crystals are ex-

tremely sensitive, but dust and grease will coat the surface and will spoil this sensitivity. Crystal detectors are therefore often enclosed in glass tubes to make them dustproof and to avoid unnecessary handling.

Excellent results can be obtained by pressing together two crystals, in which case the conductive properties of each crystal are added together and

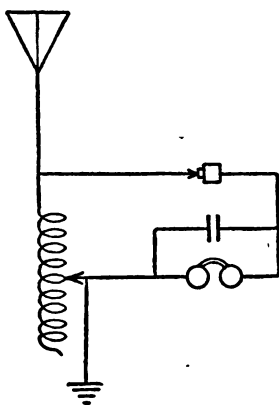

Fig. 30

the reception is thus intensified. As two sensitive spots have to be found simultaneously, this type requires a finer adjustment, and is therefore not suited for instruments of the portable type, or that have to stand any amount of rough handling.

Fig. 30 illustrates the simplest form of crystal detector circuit. It will be seen that only one adjustment has to be made in order to tune in (on the induction coil) to obtain the proper wave-

length in the antenna circuit. Its range of adjustment, however, would hardly suffice to expect good results at any distance or to eliminate any amount of interference. It will be seen that besides the crystal three adjustments are provided to vary the wavelength and capacitance of the receiver circuit. The details of tuning such a set will be taken up in the chapter devoted especially to that subject.

### VACUUM TUBES

While conducting experiments with a view of improving the electric filament lamp, Thomas Edison in 1896 discovered a peculiar action which took place when a metal plate carrying an electric charge was introduced into the bulb alongside the filament, which action could not be accounted for with the knowledge then available. Much later, Prof. Fleming adapted that phenomenon to the rectification of alternating currents with astonishing results. It is no exaggeration to say that the study of the behaviour of vacuum tubes has already fundamentally changed our conception of electricity and bids fair to overthrow all previous notions as to the nature and evolution of matter.

### THE ELECTRON THEORY

All matter had been supposed to consist of very small particles called atoms. And an atom was generally defined as being the smallest part into

which matter could be divided. The properties of atoms were first discovered by Dalton, who formulated the well-known Atomic theory which still forms the basis of all chemical science, as it explains in a satisfactory manner most of the phenomena of chemical reaction between elements.

What the Atomic theory does not explain, however, is the peculiar behaviour of different substances towards electricity. Why should a piece of copper, for instance, allow a current to pass through while porcelain or rubber does not? Or why should the heating of two different metals pressed closely together give rise to an electrical current between them?

When these phenomena were investigated in the light of newly acquired knowledge, it was found that atoms were in reality further divisible into very much smaller particles which were called Electrons and that electrons are responsible for electrical manifestations of all kinds. At first only advanced as an interesting philosophical speculation, the Electron Theory has been proven true beyond doubt during the last few years, and has caused a revision of much of our scientific knowledge. The vacuum tube has been an invaluable aid in this research work, as it affords a means of control so delicate that single electrons have apparently been isolated and measured by its means, although they are so small that no human eye will ever see them.

In mass, size and charge an electron is almost

inconceivably small. Its diameter is such that it would take over three million million of them laid side by side to fill the length of an inch, a figure expressed by the number three followed by twelve ciphers. It is the flow of these electrons that constitute what we know as an electric current. Professor Millikan has stated that an ampere of current flowing through a wire represents not less than six million million million of electrons passing a given point every second ( $6 \times 10^{18}$ ).

Electrons are particles of negative electricity. They are in constant motion. When a body contains just the right amount of electrons it may be considered electrically neutral, if it contains more than it normally should, that body may be said to be electrically charged. A discharge of electricity is a flow of electrons from a negative body to a positive. The flow of electrons thus is opposed to that of the electric current as commonly understood. This apparently confusing statement can best be grasped when we realize that until a few years ago it was only assumed for the sake of convenience that anything actually flowed along an electric circuit. When electrons were discovered and the nature of electricity became finally understood, it was found that their motion really takes place in the direction opposite than had before been imagined.

Electronic flow may be compared with the flow of heat in a conductor. One is used to speak of "heat" and "cold," yet it is fully understood that

by "cold" is meant merely the absence of heat. The process of heating any body means to impart to it some excess heat that is given off by some other body. In a similar manner there are no such things, strictly speaking, as "positive" and "negative" electricity but merely an excess or a deficiency of electrons. And a flow of electricity means a *transfer of electrons from a body (negative) which contains too many of them to one that does not contain enough.*

If this fundamental conception is clearly understood it is seen that the explanation of many abstract electrical phenomena becomes a simple matter. For example, it is difficult to understand the "charge" in a set of condenser plates. But if we think of the negative plates as being actually filled with excess electrons under pressure and positive plates as containing less than they would normally hold, we can readily see that flow of electrons will take place from one to the other and equilibrium will be established if the plates are connected and the circuit is closed.

The familiar statement that "unlike charges attract each other" is therefore explained as the tendency to establish equilibrium between bodies containing respectively, an excess and a deficiency of electrons. The electron theory explains the difference between conductors and non-conductors of electricity thus: When a current is said to be flowing through a wire, the electrons do not flow right through from one end to the other, but rather

a number of electrons are added at one end and the equilibrium in the conductor is unbalanced, to re-establish which, a like number must be released at other end. Now suppose the electrons, present in any particular substance, are very closely bound together into atoms so as to resist the entrance and escape of additional electrons.

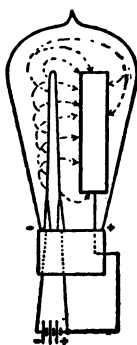

Fig. 31

The passage of current will then be difficult, and the body will be a *poor conductor*. If, on the other hand, the electrons are loosely held together they can move with greater freedom and offer but little opposition. That body will be a *good conductor*.

It will be seen that this theory explains most of the familiar yet obscure facts of electricity in an easy manner. Electrons are in constant motion. Only at the temperature known as absolute zero ( $-273^{\circ}$  Cent.) are they supposed to be at rest. When a body is heated they begin to vibrate, the

amplitude of vibration increasing with the temperature. When the latter reaches a certain value (which differs for various substances) the vibrations become so strong that electrons actually leave the body and fly off into space. This is the explanation of vaporization at high temperatures. Boiling water thus may be considered as a mass of electrons under such violent motion that impelled by their own momentum they leave the body and fly off into the surrounding medium, to form what we know as water vapor.

A glowing filament in an electric bulb thus gives off millions of electrons every second, which fill the space within the bulb. If the heat in the filament is varied by means of a rheostat the number of particles given off varies proportionately. If the current is shut off and the filament allowed to cool, some of them will return to it just as electrons emanating from boiling water will unite and cause condensation as soon as the temperature becomes lower than 212 degrees Fahrenheit.

#### TWO ELEMENT TUBE

These electrons, as has been stated, consist of *negative particles of electricity*. Suppose a metal plate is introduced into the bulb. If the plate is connected to the positive terminal of the filament battery, the plate will be carrying a positive charge with respect to the filament, that is, the plate contains less electrons than it normally carries. The



free electrons which are being given off by the hot filament therefore rush over to the plate to make up the deficiency and thereby establish a connection between the two, closing the circuit and causing an external current to flow from the plate to the filament, as indicated in Fig. 31.

If a battery is inserted in the plate circuit Fig. 32 with the positive side towards the plate, it gives

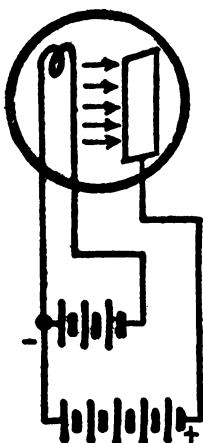

Fig. 32

the plate a positive charge or deficiency of electrons and will therefore facilitate the flow of electrons from the filament to the plate, thereby increasing the intensity of the external circuit. If the negative side of the battery is connected to the plate—then the battery imparts a negative value to it and there will be no attraction of electrons to the plate.

The above can be succinctly stated by saying that the positive plate attracts the negative electrons because unlike charges attract each other, while the like charges between the negative electrons and negative plate are mutually repelled. *The electrons then can only flow from filament to plate.* The phenomenon mentioned above explains the fact which is so puzzling to many students of the subject that the electrons flow in a direction opposed to that of the current as ordinarily understood.

Experimentally the above can be demonstrated in the following manner. Set up apparatus as shown on Fig. 33 in which "A" is a battery which supplies current to heat the filament "F" to a high temperature controlled by the rheostat R, the voltage of this circuit (called the filament circuit) being observed at the voltmeter V. The Plate P is energized by the battery B through a Switch S, G being a galvanometer or milli-ammeter which measures the current passing through the plate circuit. It is evident that by throwing the switch to the right a negative charge is impressed upon the plate, in which case no current will be observed to flow at G. If on the other hand the switch is thrown to the left to connect P with the positive end of the battery a deflection at the ammeter will take place showing that a current is flowing in the circuit.

It is thus apparent that if the filament and plate are connected in series to a source of alternating

current the latter will pass through the tube only when flowing in one direction and not in the other.

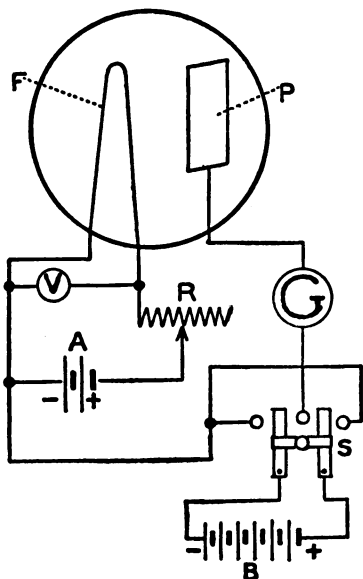

Fig. 33

The alternating current is thus rectified into a pulsating direct flow.

As might be expected, there exists a definite relation between the three factors involved: Temperature of filament controlled by rheostat, voltage of plate circuit and amount of current flowing in the latter. These relationships for three different filament voltages can be plotted as shown on Fig. 34.

It will be observed that as the voltage in the

plate circuit is increased, at first the current flowing through the circuit increased in a like manner. Soon a point (m) is reached, beyond which the curve rises much more rapidly. This takes place until the point (n) is reached where the curve begins to flatten out to become further practically horizontal, showing that increasing the voltage

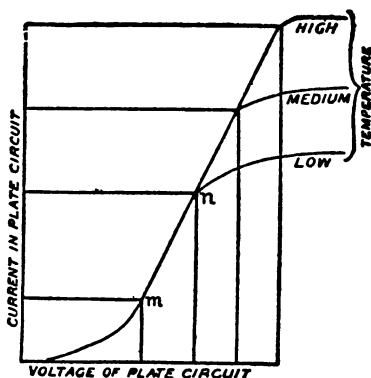

Fig. 34

has thence no further influence on the flow. We can interpret this result as follows: Up to the point (m) there is a fixed relation between voltage and current, that is, the tube follows Ohm's law. From (m) to (n) the resistance of the space between the filament and the plate has somehow been decreased, and the current flows more easily. Beyond (n) the resistance increases, however, to such an extent that no additional pressure can force a greater current across the space. The explana-

tion in terms of electronic theory is as follows: The negative electrons at first are drawn towards the positive plate in proportion to the need of the latter, as it were, to make up its deficiency. In other words, the more negative particles are lacking in the plate, the more will be drawn out of the filament to re-establish equilibrium. This takes place up to a point represented by (m). Now the space between filament and plate is *completely filled* with flying electrons which form a perfect bridge for the current to pass through, encountering very little increase of resistance. The current hence rises very rapidly but if we increase the voltage still further a value is reached at which the plate requires more electrons than the filament can supply (n). From that point on increasing the voltage can have no effect on the current flow because maximum electronic flow, or *saturation point*, has been exceeded.

If we increase the filament temperature the lower part of the curve will be exactly as before, as long as the plate requires no more electrons than can be supplied. But as a hotter filament is capable of delivering a greater number of electrons we may expect the saturation point to be reached somewhat later, and the curve, hence, takes the shape marked "medium" on the diagram. Increasing the filament temperature again will cause the current to reach still higher values.

The simplest form of circuit for rectification of high frequency alternating current is illustrated

in Fig. 35 which is similar to the crystal detector circuit on Fig. 30 except that a tube has been substituted for the crystal detector. As before, only the impulses received in one direction will be permitted to go through the telephone receivers,

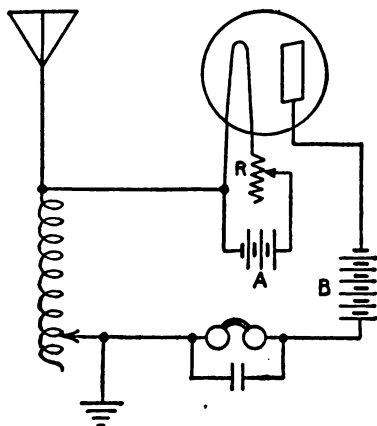

Fig. 35

modulation of the high frequency radio wave taking place in the latter. A battery "A" supplies current to light the filament, the temperature being controlled by means of the rheostat, R.

The filament with the rheostat and battery forms a distinct circuit with one purpose, namely the heating of the filament to the proper temperature, to control the flow of electrons. There is a second distinct circuit consisting of the filament, plate, receivers and tuning coil. (The action of the phone condensers will be described later.)

The tuning coil (as explained in Chapter II) controls the wavelength adjustment.

If the antenna and ground are disconnected, a distinct purring will be heard as the filament is glowing, indicating that there is a flow of electrons from the filament to the plate and therefore a flow of current in the external circuit through the receivers. When the antenna and ground connection are added, and a high frequency alternating impulses are received in them, this current flows *with* the plate current, but in passing through the tube only the impulses in one direction can go through. These impulses add to the plate current and give it a higher value. The ones that *cannot* go through, merely act to retard the plate current but are not of sufficient strength to stop the normal plate circuit flow. The plate current is therefore modulated, that is to say it has been changed into a series of pulsations similar to the high frequency alternations, but flowing in only one direction.

The addition of a battery in the plate circuit intensifies the plate current thereby giving stronger impulses to actuate the receivers.

In this manner,—through the plate battery,—the vacuum tube acts as an amplifier of the received current and thereby increased the range of the receiving set.

#### THE GRID

In 1907 Dr. Lee DeForest introduced a third element into the two-electrode Fleming valve just

described, which increased its usefulness a thousand fold and thereby made modern long distance Radio reception possible by permitting the vacuum tube to be used not only as a detector and rectifier of current, but to amplify the weakest impulses millions of times.

This innovation consisted in surrounding the filament with a wire cage called the *grid*, through

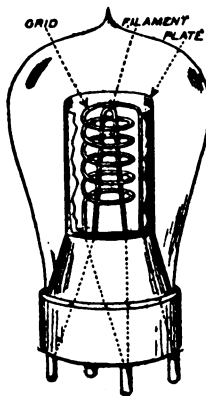

Fig. 36

the interstices of which the electrons have to pass in order to reach the plate. (See Fig. 36.) By impressing a positive or negative charge upon the grid the flow of electrons (and hence the plate current) can be controlled to an almost infinite extent. Besides this sensitiveness, the advantage of the grid consists in the fact that it will respond to current variations measured in microamperes, or one millionth part of an ampere. As it requires an



almost infinitesimal amount of power to operate, it is thus susceptible to the weakest impulses received from the antenna.

In order to understand the operation of the grid one must revert again to the space charge or flow of electrons taking place between the filament and the plate.

Assume the grid G in Fig. 37 to have a slight negative charge impressed upon it. Some of the

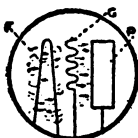

Fig. 37

electrons on their way over to the plate will strike the grid which has of course a repelling action and sends them back towards the filament. These electrons in turn meet others on their way out and cause them to run back. As a result the space within the grid becomes crowded with negative electrons and only a limited number of them are able to penetrate through the grid and reach the plate.

If the grid is charged positively, on the other hand, the charge will actually assist the electrons in leaving the filament (which is nearer to the grid than to the plate) and thus intensifies the current in the plate circuit.

## THE THREE ELEMENT VACUUM TUBE CIRCUIT

In Fig. 38, the filament and plate circuits are very similar to the circuits in Fig. 35, with the exception that the plate circuit is completed to the filament instead of passing through the tuning coil. Disregarding the balance of the diagram, the same purring will be heard in the receivers when the filament is lighted, indicating that the

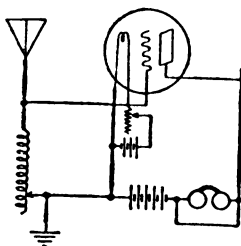

Fig. 38

flow of electrons is taking place in the plate circuit. Instead of flowing directly in with the plate circuit as before, the high frequency alternating current caught by the antenna and ground is used to charge the grid, the other terminal of this alternating current being connected to the same side of the filament circuit that the plate circuit is. The alternating current constantly varies the charge of the grid. When the charge is distinctly negative, the grid retards the flow of electrons to the plate, thereby decreasing the plate current, but as the alternations reverse, the grid permits an increased flow of electrons to the plate and thereby

intensifies the plate current. In this way the plate current still remains uni-directional, but has been modulated as before to correspond to the fluctuations of the high frequency current. This grid operation of the vacuum tube has a greater sensitivity and is more easily controlled than the old two-element type, and has been the direct cause of the marvelous development that has taken place in the last few years in Radio telephony.

THE GRID LEAK AND GRID CONDENSER

It has been found from experiment that the grid may become too heavily charged with electrons but as the grid is not heated except from the

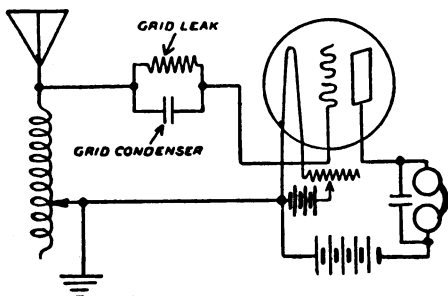

Fig. 39

conduction of filament heat, there is actually only a limited flow of electrons from the grid to the plate. But because of the surplus of electrons, the flow from the filament to the plate is choked, thereby decreasing the sensitivity. To remedy this, it has been discovered that a *Grid Leak* and

*Grid Condenser* in the grid circuit will prevent an accumulation of electrons on the grid.

Fig. 39 shows how the grid leak and condenser connected in parallel are inserted just before the grid connection. The grid leak is simply a very high resistance permitting but a limited flow of electrons to the grid, while the condenser, however, is repeatedly charged and discharged by the alter-

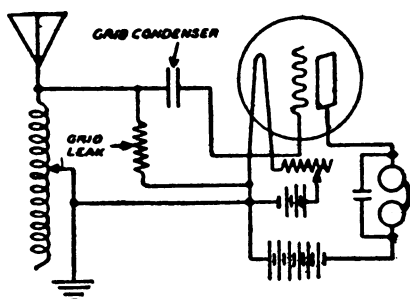

Fig. 40

nating current, thus alternately pushing and drawing back the electrons on the grid side. In this way, the grid is sensitive to the alternating current without the danger of an overabundance of electrons.

In Fig. 40 the grid condenser is placed in series in the grid circuit, but the grid leak is connected between the grid circuit and the filament. In this case the condenser has the same effect as before, while the grid leak allows the surplus charge that accumulates to "trickle" through to the filament, that is constantly losing its electrons, as they flow to the plate.

**CHAPTER IV**  
**RECEIVERS AND LOUD SPEAKERS**  
**TELEPHONE RECEIVERS**

**AFTER** the high frequency currents, radiated by the transmitting station, have been caught by the antenna and then rectified by the detector into impulses in one direction, the telephone receiver performs the important function of converting these impulses into audible sound waves.

The impulses transmitted to the receivers, whether coming directly from a crystal or vacuum tube detector or from an audio frequency amplifier have the shape shown in Fig. 27 with which the reader has become familiar. It is impossible, nor indeed desirable, to make the diaphragm that converts these impulses into sound-waves follow the high frequency outline thus received. What is required is merely a wave form that will conform to the general contour of the high frequency amplitudes, or a sort of slurring of the abrupt and peaked shape of the latter into a gradual easy motion that can be followed by the comparatively slow vibrations of the steel diaphragm as in (e) Fig. 27. This is termed the modulation of the

sound-wave, and it should be noted that it is achieved by a mechanical, and not an electrical process.

The receiver is one of the most delicate instruments of the whole radio set and unfortunately it is the only one that is freely handled and consequently much abused. A study of its construction brings one to the realization that it should always be most carefully handled and protected against jars and shocks of all kinds, no matter how slight.

Essentially the receiver mechanism consists of a steel diaphragm about .004" in thickness which is supported around its rim while the center is subject to a slight constant pull from a permanent magnet, the attraction from which, keeps it in tension like the skin of a drum and prevents it from bulging and becoming flabby. The arrangement is clearly shown in the cross-section on Fig. 41 where "A" is the diaphragm, and "C" is the permanent magnet. Swedish steel of very high quality is used for the latter, as it will retain magnetism once it has been imparted to it for a very long time with practically no variation. The magnetism from "C" is carried to the diaphragm through the two soft iron pole pieces "H." The poles "H" also serve as cores for two electromagnet windings "D" through which the rectified current pulsations pass. The variations of this current as it follows the modulations of the sounds at the transmitting station, imparts additional or

## RECEIVERS AND LOUD SPEAKERS 69

less magnetism to the pole pieces "H" which thus attract the diaphragm and cause a very slight back and forth motion of its center. This in turn sets up a corresponding vibration in the air column immediately before it which is caught by the ear of the listener.

The intensity of magnetic force depends upon the number of turns in the electro-magnet. To

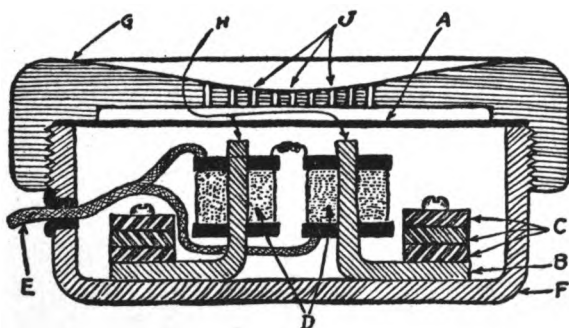

Fig. 41

obtain as many turns as possible in the available space a very fine wire (No. 40 or less) is generally used, which will allow as many as ten thousand turns of wire in each coil.

This length of fine wire offers, of course, considerable resistance to the flow of current, which amounts to as much as 1000 to 1500 ohms.

The poles "H" are made of soft iron on account of this material's property of losing its magnetism quickly with every variation in current strength.

Shocks are the greatest enemies of permanent

magnets and nothing will cause them to lose their magnetic properties faster. One should never forget that every time the receivers are banged upon the table or dropped to the floor their life is shortened and good reception made more difficult. Also the diaphragms are best left alone. The distance which separates them from the magnet poles is only five-thousandths of an inch or so, and the slightest bending or bulging will put them out of commission. Not the least important function of the diaphragms is that of carrying the magnetic flow from one pole to the other, thus lengthening the life of the magnets considerably.

There are many different makes of receivers on the market which differ only in non-essentials, but the reader should beware of worthless devices which are occasionally brought out. After all, the receivers are the things that actually produce the sounds and unless they are in perfect functioning order and of first-class manufacture it is hopeless to expect good results from even the most expensive receiving set.

#### LOUD SPEAKERS

Loud speakers are of two classes, non-amplifying and amplifying. The former utilize the sounds as they come from the receivers directly, and merely attempt to increase the same by resonance of tapered air chambers. The latter, however, use the receiver unit as a relay to control a stronger current to actuate a larger diaphragm.



At the present time none of the many loud speakers on the market may be said to improve the quality of the sound. This is not due to lack of effort or mechanical failure, but rather to the inherent difficulties of the problem of sound amplification.

One of the great difficulties is to get the horn of proper length and the usual snake-like convolutions do not help very much if the instrument is to retain dimensions acceptable in the average room.

The reason why musical wind-instruments are built in that manner is to obtain an amplifying or resonant chamber that is at least as long as the average sound wavelength emitted by the instrument. In cases of very low register, as in the bassoon, this may require a length of eight or ten feet. In the slide trombone the length of the horn is individually adjusted for every pitch sounded, which accounts for the clearness of the tone of that type of instrument and freedom from interfering overtones.

In the practice it is, of course, impossible to build horns of such sizes in connection with radio reception, except in some special cases, and a happy medium is struck. The result is that amplifying horns are very satisfactory for certain ranges but are apt to produce interferences at other times, giving rise to "tinny" "scratchy," or "throaty" sounds. As in the case of phonograph horns certain instruments, of which the vibrations correspond more nearly to the natural vibrations

of the air column in the horns, produce much better results, and sound more "natural." Notable among those are the 'cello, tuba, and among human voices contralto and baritone. It is a well-known fact that certain singers possess good "record voices" that is, their tones are capable of being reproduced with less interference and more purity.

The prime requisite of a good amplifying horn should be stiffness of construction. Every horn has a certain natural period of vibration and when the corresponding note is sounded, it is set vibrating to the detriment of the following sounds. The sides of the horn should be so substantial as to dampen any tendency to vibrate at its inception. It has been proven by actual trial that the purest amplification was obtained with a horn built of concrete and some ten feet long.

Many sets are being constructed today with the radio apparatus and the loud speaking horn in one cabinet suitable for use in the living room; some instruments of this type even contain a loop antenna which is built into the casing, making the set completely self-contained. Sometimes the electric house wiring is used as an antenna.

Another class of loud speakers makes use of an additional 6 volt electric circuit which energizes a fairly large electro-magnet. Between its poles is suspended a very light movable coil which carries the receiver current, and which is connected to a large diaphragm. The current modulations in the

small coil cause the latter to move in the induction field of the electro-magnet, and as the latter is separately and strongly excited, a very small variation results in a comparatively large motion of the diaphragm, which thus reproduces sounds with an intensity far greater than the weak current

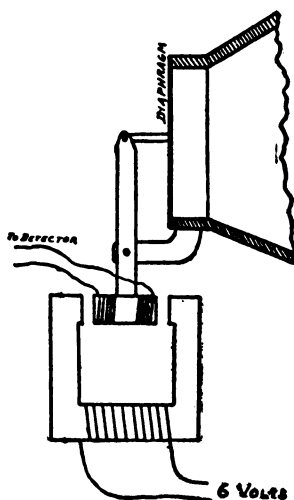

Fig. 42

in the receiver circuit could do unaided. Fig. 42 shows the general arrangement just outlined, in a diagrammatic way.

Another kind of loud speaking apparatus employs the principle of the microphone. Here a receiver is so connected with a transmitter that the vibrations of the diaphragm control the flow of a powerful current in the latter. This current

is then led to one or a number of receivers which are actuated by a strong current and hence carry large diaphragms, generating sound waves of great amplitude. One advantage of this type is that any number of individual loud speakers can be actuated by the same microphone, which makes it particularly advantageous in large halls or for the broadcasting of speech to crowds assembled in the open air.

## CHAPTER V

### CONDENSERS AND RESISTANCES

#### CONDENSERS

A **CONDENSER** is generally defined as a device for storing electrical charges.

Any two conductors which are connected to opposite sides of an electric circuit, but not to each other, will act in a measure as a condenser and will be able to store a certain amount of energy. It has been shown in Chapter III that a flow of current in a conductor is explained by the electron theory as an accumulation of electrons at one end and a release of an equal number of them at the other end of the conductor. If two metal plates are placed close together but with some substance between that has a high "dielectric" capacity (or is a good insulator) the electrons will enter the negative plate and some will be taken from the positive plate, thereby creating a condition of electric tension. If the dielectric is not sufficiently strong it may break down, by which is meant that tension may become so great that an actual rupture takes place and the current passes between the plates in the form of a spark. This is, of course,

more apt to occur where very high potentials are involved, as in automobile ignition or radio transmitting apparatus, than in receiving sets.

If the dielectric is able to withstand the tension, a charge will be retained in the plates for a considerable period. This charge will tend to relieve itself at the first opportunity that a circuit between the plates is established.

It has been explained before how a condenser connected across a spark gap will alternately discharge and recharge itself and thereby sets up damped oscillation across the gap, a property upon which the generation of damped radio waves is based and which is much used in radio telegraphy.

Electrons are supposed to travel and accumulate upon the surface of conductors, from which follows that the capacity or the amount of electricity that can be stored varies with the surface of the plates. The latter are therefore always made as large as possible and of fairly thin material such as aluminum sheeting or tinfoil. The nearer the plates are to each other the greater will be the tension that can be accumulated between them up to the amount that the dielectric will stand. On the other hand if the plates are very closely put together the dielectric becomes too thin and discharges may take place through its pores.

Air is taken as a standard in comparing the dielectric properties of various materials. The dielectric constants are given in Table II in Appendix I. In this table the constant for each mater-

ial expresses the relative strength of current which the material will stand without breaking down, compared with an air layer of the same thickness. In other words, a sheet of mica  $1/16$  inches thick will stand a voltage 6 times greater than an air gap of  $1/16$ , which is but another way of saying that mica is six times as good an insulator as air.

Air is used only for very low capacities such as are encountered in radio reception. Where higher potentials are involved it is necessary to use better dielectrics. Air is by no means a perfect insulator and is subject to what is known as brush discharge, which is a passage of electricity between two charged bodies taking place through the air without an actual spark jumping across the space which separates them. Instead, the edges of the plates will glow—if seen in a darkened room—with a purplish radiation, a phenomenon which is known as St. Elmo's fire when it occurs on a large scale during thunderstorms. Brush discharges can be largely prevented by coating the plates with paraffine for about  $1/4$  inch, all along the edges.

In radio receiving sets condensers are made with plates of tinfoil with a dielectric of waxed paper or thin mica sheets, or with aluminum plates separated by air layers. In either case the plates are alternately connected together, forming a positive and a negative set, as shown diagrammatically in Fig. 13. This type is known as a fixed condenser, that is, its capacity cannot be varied, and is used wherever flow of current changes within fairly

close limits, such as grid-leaks or across telephone receivers. In such cases the condenser acts to steady the pulsations of current and its capacity for storing electricity is utilized somewhat as air is entrapped in air chambers to provide an elastic body to take up the shock due to the stopping and starting of the piston in a water pump, and to equalize the flow. The motion of the receiver diaphragms thereby becomes smoother and more in accordance with the natural sound wave which it is intended to reproduce.

Variable condensers are those, the capacity of which can be regulated according to requirements, and are used chiefly in connection with tuning coils to adjust the capacity of the antenna circuit. In the most widely used type (Fig. 43) one set of plates is fixed to two or more columns with suitable spacers between them to maintain the proper thickness of the air dielectric. The other set is fastened to a shaft in such a manner that when the latter is turned the movable plates will travel between the fixed ones. The plates are cut to a semi-circular shape (see Fig. 46) and mounted so that one half revolution of the shaft will rotate the movable sets from "inside" to "outside" position. Thus the capacity can be varied from a minimum to the full extent of which the condenser is capable. A dial indicates the proportionate amount to facilitate setting.

When all the plates of one set are moved at one time it is often difficult to control the adjustment



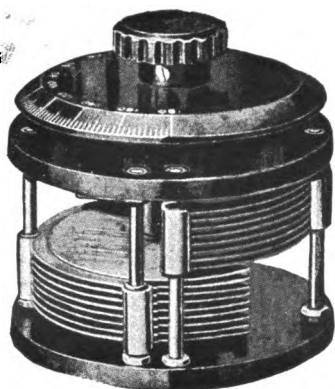

Fig. 43

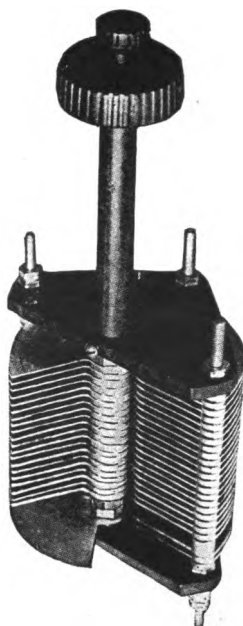

Fig. 44

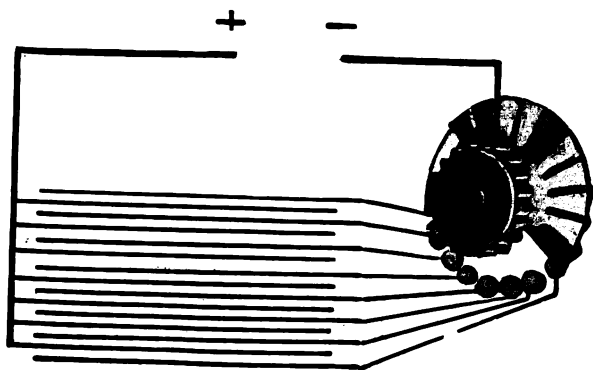

Fig. 45



to a sufficient sensitivity. To remedy this one plate is not connected to the remainder of the movable set but is made separately adjustable by means of an additional knob. In this type of instrument illustrated in Fig. 44 the bank of plates is first set for as fine a setting as can be obtained; finer adjustment being had by sliding the single

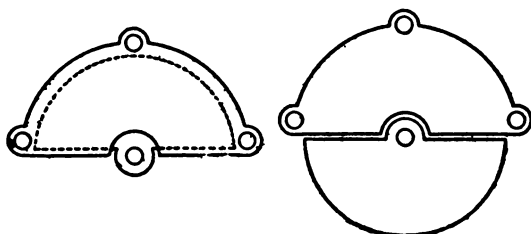

Fig. 46

plate in or out as may be required. This is called a vernier adjustment.

Another type of movable condenser especially favored by amateurs who like to make their own apparatus is one in which plates of tinfoil are each individually wrapped in the dielectric, generally waxed paper. They are then assembled and connected in two groups which are inserted into each other like a pack of cards that is being shuffled. The capacity is varied by sliding the plates in or out horizontally.

Instead of sliding the plates from between each other capacity variation can be obtained by increasing the thickness of the dielectric between two single plates. The "book" condenser is of

this type, in which the opposite plates are mounted on some stiff boards, of wood, ebonite, or porcelain, which are hinged together like the covers of a book. Opening the space between the plates by means of a cam, decreases the capacity.

Similar in principle is the patented device shown in Fig. 47. Here the plates are in the form of an internal and external cone, of aluminum with a sheet of celluloid between. A screw adjustment permits moving the cones towards or away from each other, the conical shape allowing a very delicate respective motion for a considerable amount of turning.

A type of adjustable condenser with fixed plates is shown diagrammatically on Fig. 45. The plates on one side are individually connected to the contact switch as shown. It is evident that by turning the switch any desired number of plates can be connected to one terminal.

#### CONDENSERS IN ANTENNA CIRCUITS

The function of a variable condenser in antenna circuits can best be explained by comparison between tuning such a circuit to a certain wavelength and tuning a musical string to a given note. In the latter case it is common knowledge that if it is desired to increase the pitch—that is, decrease the wavelength of a string, the latter is shortened, or the tension on it is increased. It is also known that thin strings have a higher pitch

for a given length and tension than thick ones. The wavelength thus depends upon three factors and varies directly as the tension and inversely as the length and the mass. In radio the tension corresponds to the natural wavelength of the antenna circuit, which is fixed (just as the tension of, let us say, the "A" string of a violin is

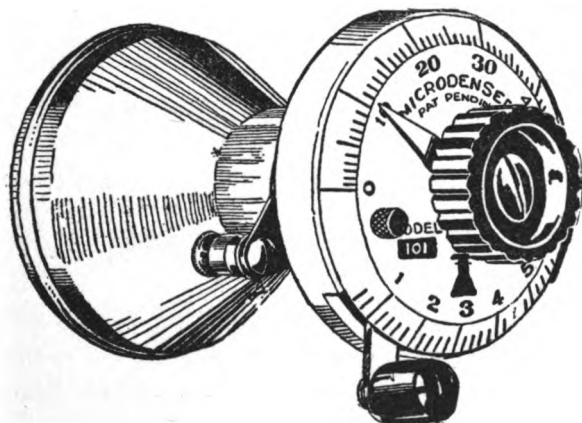

Fig. 47

fixed.) The inductance corresponds to the length, and the capacity to the thickness or mass of the string. If it is desired to tune a decreased wavelength, either the inductance or the capacity may be decreased or *both* which corresponds to shortening a violin string by pressing a finger upon it and substituting a thinner string. Performing both these operations together will give better resonance, in musical as well as in radio frequency

vibrations. Therefore, the reason for using both an inductance coil and a condenser is analogous to employing a fingerboard and a set of strings of different thicknesses.

The formula expressing both relationships is

$$\text{Number of vibrations} = \frac{1}{2} \sqrt{\frac{\lambda}{L \times C}}$$

and an antenna circuit will be in tune when the product

$L \times C$  at the receiving Station is equal to the product  $L' \times C'$  at the transmitting station.

The capacity of a condenser is measured in units called Farads or more commonly in Radio apparatus in Microfarads which are equal to one millionth of a Farad.

If the area of the plates (S) in square centimeters, the thickness of the dielectric (t) in centimeters, and the dielectric constant (K) are known, the capacity in Microfarads can be computed from the following formula

$$C = \frac{.0885 SK}{1,000,000 t}$$

When several condensers are connected in one circuit their combined capacity can be determined as follows:

When they are connected in parallel (Fig. 48) the combination is equivalent to a single large condenser having a capacity equal to the sum of

## CONDENSERS AND RESISTANCES 83

the individual condensers. When connected in series, as in Fig. 49, they act like a single condenser having a dielectric as thick as that of the individual condensers combined. If the four condensers in

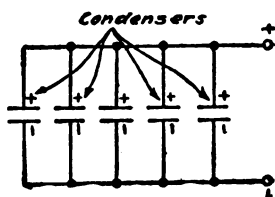

Fig. 48

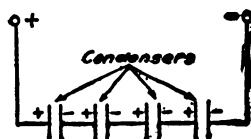

Fig. 49

the figure all have the same capacity, the capacity of the whole will then be one fourth of that of each. The above relations can be expressed as follows:

For condensers in parallel

$$C = C_1 + C_2 + C_3 + C_4$$

For condensers in series

$$C = \frac{I}{\frac{I}{C_1} + \frac{I}{C_2} + \frac{I}{C_3} + \frac{I}{C_4}}$$

### RHEOSTATS

The temperature of the vacuum tube filament is controlled by regulating the intensity of current flow by passing it through a *rheostat*.

A rheostat consists of a length of wire of fairly

high resistance—from 4 to 12 ohms—one end of which is attached to one terminal of the source of current, the other terminal being so arranged that it can be moved along the entire length of wire. In practice this is usually accomplished by shaping the wire in the form of a coil spring which is so mounted on a base that a sliding contact attached to a knob can be made to travel along the wire by turning the latter.

The resistance of a wire is directly proportional to its length. Thus if the resistance of the

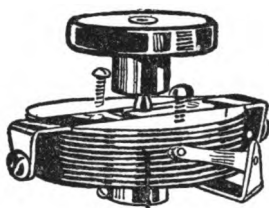

Fig. 50

complete coil is 12 ohms it will be only half of that if the contact is placed at a point midway along the length.

The rheostat is also made to serve as a switch for the filament circuit by allowing the sliding contact to pass beyond the end of the resistance coil.

Under some circumstances, more sensitive adjustment of resistance control is necessary. In Fig. 50, a vernier rheostat is shown in which the contact is established by the travel of the pointer



in a threaded groove in which the resistance wire is embedded.

## POTENTIOMETERS

A potentiometer is a device to control the grid potential with respect to the filament. Its action

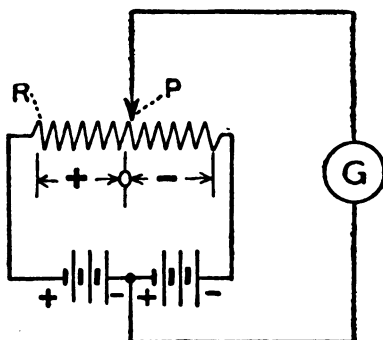

Fig. 51

can best be understood by reference to the diagram, Fig. 51, which represents two sets of batteries in series with each other and forming a closed circuit with a coil "R" of very high resistance, from which the current can be tapped at any point through the sliding contact "P." There are thus two complete circuits—an inner circuit through which the battery current flows full strength, and an outer, from a point between the two batteries to the sliding contact. Now it is evident that there will be some place near the middle of "R" at which the positive and negative

sides of the inner circuit just neutralize each other. If the contact "P" is placed at that point, there is no difference of potential to drive a current through the outer circuit, hence the galvanometer "G" will show no deflection. If the slide is

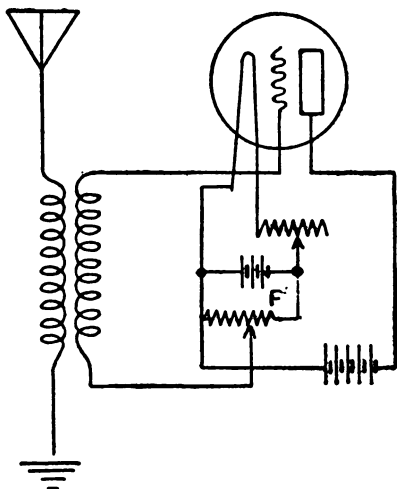

Fig. 52

moved to the left, however, it will make contact with the positively charged side of the resistance and a current will flow in the outer circuit, from the slide to the battery connection. Conversely if the slide is moved towards the right a current will flow in the opposite direction. As the resistance is very high—in practice from 200 to 600 ohms, the variations of potential obtainable in this manner through the outer circuit are very small

and can easily be controlled or completely reversed with a slight motion of the sliding contact.

To impress a positive or negative charge on the grid of a vacuum tube a potentiometer can be connected as shown in Fig. 52. Here it is seen that the grid, the potentiometer and the filament form a circuit which is entirely independent of either the filament lighting circuit or the plate circuit. It is also evident that the potentiometer adjustment permits varying the polarity and voltage of the grid with respect to the filament and thus impedes or facilitates the electronic flow to the plate.

#### GRID LEAK

The sensitiveness of plate current control by the grid potential is greatly increased by inserting a "grid leak" and condenser in the grid circuit. This consists of a small fixed condenser of about .00025 microfarads, in parallel with a high resistance of about .5 megohm (500,000 ohms), though these values are not fixed and should adapt themselves to those required by the particular make of tube used. The grid leak thus is an instrument that will allow extremely small currents to "trickle" through.

Grid leaks are generally supplied in complete units and are frequently encased in glass tubes for protection.

## CHAPTER VI

### TUNING AND TUNING APPARATUS

#### TUNING

**TAKING** all things in consideration, the beginner in radio can take pleasure in operating a receiving set although he may be ignorant of every point about it, except the knowledge of tuning. He may not understand the how and why of the detector, whether to use crystal or vacuum tube, or he may not know how the waves are sent out, and what is meant by high frequency waves, radio, or audio frequency, or many of the other mysteries that make up the new popular recreation. But there is no question that, until he understands tuning, he can never get satisfactory results under the many different conditions that affect radio reception.

The best rule to follow in tuning is to understand what each control does, if only in a general way, and to use the controls in a systematic and not a haphazard manner. One need not know theory of gasolene engines in order to drive an automobile, but one must know the function of each control to drive safely and intelligently, and the better the controls are understood the more perfect the driv-

ing will be. In the same manner an understanding of the general principles of the set and a knowledge of the functions of the various controls is necessary to make reception a source of satisfaction, rather than of annoyance.

In previous chapters the subject of wavelength has been thoroughly explained, but for illustration the following experiment shows what happens in tuning. Take two glasses, preferably thin stemmed wineglasses, that are very similar in tone when struck a slight tap with a pencil. If there is a slight variation water can be added in the glass that has too high a tone, until both sound alike. Now, if the one is struck a smart tap and the hand is then placed over it to stop the vibrations, the other glass will be heard ringing. Both glasses have been tuned to the same vibration, and therefore one responds to the other. If water is added to either one so that the tone is distinctly different, the glasses will be out of tune and there will be no response in the other when one is tapped. In the same manner if two totally different glasses are used, by adding water the natural rate of vibration can be varied until the tones are alike and the one will respond to the other; in other words they have been "tuned in." It may happen that the natural ranges of vibration are too far apart in two different glasses so that it will be difficult to tune in. In the same manner the natural range of a radio set may not be within the range of the sending station and tuning will be a failure.

It has been explained before that the antenna without the set, but with the lead-in and ground connections, has a natural wavelength to which it responds. This natural wavelength depends on the capacity and the inductance. Tables for capacity and inductance of various antennæ are given in the appendix. When the capacity and inductance are known, the wavelength can be calculated from the formula

$$\lambda = 1885 \sqrt{C \times L}$$

in which C is the capacity in microfarads and L is the inductance in microhenries.

When a tuning coil, or the primary of a loose coupler or variocoupler is inserted in series in the antenna circuit (Figure 53), it acts in the same way as adding water to the glasses, increasing the wavelength. When the coil of any tuning apparatus is inserted in series in the antenna or primary circuit the inductance of the coil in microhenries must be added to that of the antenna and substituted for "L" in the wavelength formula. It is easily seen that an increase in the inductance value will also increase the wavelength of the antenna circuit.

The primary coil of any tuning apparatus is usually provided with either a sliding contact or a tapped switch (Figure 54) by means of which the number of turns of wire through which the current flows is varied. By altering the number of turns, the inductance is changed, giving control over the wavelength.

## TUNING AND TUNING APPARATUS 91

When a condenser is inserted in series in the antenna circuit, as in Figure 55, it has the same effect as taking out some of the water in the glass, that is to say, the wavelength it decreased. As the antenna has a capacity and acts as a condenser, the effect is the same as putting two condensers in series. The capacity of the combination, then, will be

$$C = \frac{1}{\frac{1}{C_a} + \frac{1}{C_c}}$$

If any two values for capacity are substituted and the formula is worked out, it will be found that



Fig. 53

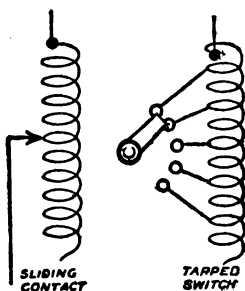

Fig. 54

the resultant capacity of the two in series *will always be less than the smallest*. Adding the condenser in series, then, means that the capacity of the aerial circuit has been decreased, and for this reason—when the resultant capacity is substituted in the wavelength formula to get the corrected wavelength—it will always be found less than before.

If the condenser is of the variable type, of which the capacity can be decreased as desired, the wavelength of the antenna circuit can likewise be decreased.

In any radio receiving sets it will be found that a variable condenser is shunted across the coil as shown in Figure 56. This corresponds to a coil and



Fig. 55

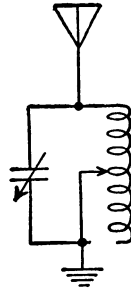

Fig. 56

condenser in parallel connection, but inserted in series in the antenna circuit. Every coil, besides inductance, has also a capacity value, but for the amateur this is not important enough seriously to affect his operation and his knowledge of the apparatus. When a variable condenser is shunted across a coil as illustrated, the tuning qualities are vastly improved. The adjustment to the proper wavelength is approximated by the variation in inductance of the coil through the winding adjustment, whereupon the variable condenser permits a much finer adjustment than would otherwise be possible.



## TUNING COILS

In its simplest form, tuning apparatus consists merely of a length of wire, which is wound on a tube, with sufficient inductance to raise the antenna circuit to the wavelength desired for reception. The inductance depends upon the number of turns, the length of the winding and the diameter of the tube upon which the coil is wound. The usual commercial tuning coil is designed to meet all-around amateur conditions, and for this reason it is not apt to be highly efficient over a great part of its wavelength range. If it is desired for a special range, the dimensions and natural characteristics of the aerial or antenna circuit may not be suited to give the proper wavelength desired. For this reason, tuning apparatus calculations are given in the appendix. Each coil having its maximum inductance, this can be reduced by cutting out part of the windings through sliders or switches.

The simplest type of tuning coil is the one equipped with a single slide making contact with the various turns for the wavelength adjustment. Figure 57 shows how the single slide tuning coil is connected in the circuit. The lead-in from the antenna goes to the coil binding post, while the wire from the ground connection is fastened to the slider binding post. The wire from the point or "catwhisker" side of the crystal detector is connected to the antenna or coil binding post. The wire from the crystal cup side of the detector goes

to one side of the phone, while the other side of the phone is connected to the ground or slide binding post of the tuning coil.

The more popular type of tuning coil is the one furnished with two sliding contacts. The hook-up of this type is very similar to the single slide tuner, as can be seen in Figure 58, with the exception that the one side of the phones is connected to the

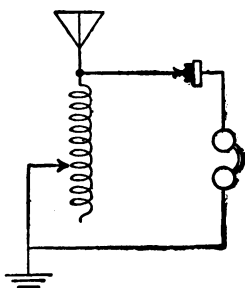

Fig. 57

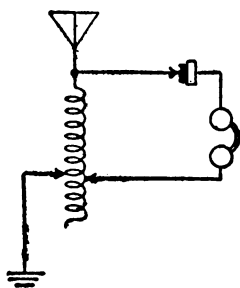

Fig. 58

second slide instead of the same one that the ground wire is. The slide to which the ground wire is connected is used for adjustment of wavelength in the antenna circuit, but the second slide permits an adjustment of the crystal and phone circuit that will materially improve the reception.

Tuning coils with three slides are made, but the advantages claimed for them have not, as a rule, been justified. All the single and double slide tuning coils are used in what is generally called a *single circuit* hook-up. They are also used for vacuum tube hook-ups, but when the amateur has

## TUNING AND TUNING APPARATUS 95

reached the vacuum tube stage he feels that a better type of tuning apparatus is needed, and turns to the two and three-circuit type of connections.

### TRANSFORMER TYPE OF TUNING APPARATUS

In the single and double slide tuning coils there is only one distinct circuit. One of the early developments in the days of spark transmission was the use of the transformer, not only in the well known spark or induction coil but also in what is generally known as the receiving transformer. When the transformer type of tuning apparatus is used the receiving set has at least two distinct circuits.

The first circuit remains just as before—that is, the antenna circuit, which now becomes more generally known as *the primary circuit*. When the high frequency alternating waves pass through, this primary coil has a magnetic field. By placing another or secondary coil, somewhere within this magnetic field, another flow of alternating current is induced, and it is *this current* that is rectified and used for operation of the receivers. Depending upon the location of the secondary and the method of controlling the induced current, there are various types of receiving tuning apparatus, such as the loose coupler, variocoupler, and honeycomb coils. Under the general heading of honeycomb coils can be grouped a number of types of windings

of similar construction, such as spiderweb coils, involute coils or special methods of winding the duo-lateral coils. The induction and variation of induction control is very similar for all, under the general heading of honeycomb coils.

#### LOOSE COUPLERS

The loose coupler is sometimes called the receiving transformer, in fact, more often so than

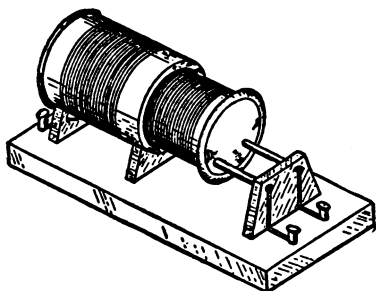

Fig. 59

any of the other type. In this instrument (Figure 59) the primary or antenna coil is wound on a large tube, the windings of which are either tapped for a contact switch or varied by a slide. The primary winding is usually made large enough to cover a considerable range of wavelength. The wire is from No. 22 to 26 B & S covered copper wire. The covering may be enamel, cotton or silk, depending upon the method used for controlling the number of windings; if a slider is used the wire is usually enamel covered.

## TUNING AND TUNING APPARATUS 97

The secondary coil is wound upon a smaller tube arranged to slide in or out of the big one, and it is usually made as large as possible to allow but a minimum amount of clearance, and thus receive the strongest inductive effect. The secondary winding is also tapped to permit adjustment of the number of turns used therein.

The waves received by the aerial travel through the primary and the adjustment for wavelength is controlled by the slider or tapped switch, as the case may be. Magnetic lines are built up around the primary windings which concentrate in the hollow core. This magnetic field passes through the secondary winding and, as the current is alternating, induces an alternating current in the secondary. This secondary current corresponds to the one in the primary, as the alternations of the latter create the induced surges of current in the secondary winding. As the secondary winding is moved in and out of the primary it is shifted into a stronger or weaker magnetic field, the field becoming weaker as the distance from the primary winding increases. Thus the strength of the induced current can be varied. As the number of turns in the secondary winding is altered by the tapped switch, there is a corresponding variation in the ratio of the number of turns of the secondary to that of the primary, which again controls the value of the induced current. Taking advantage of this induction feature the wavelength of the secondary is made to correspond with that of the primary,

whereby a stronger and more defined current is received to pass on for rectification.

In Figure 60 is shown a typical two-circuit hook-up using a loose coupler. The primary and secondary circuits have been indicated by the dash-lines in the illustration. In designing a loose coupler the secondary circuit should have the same

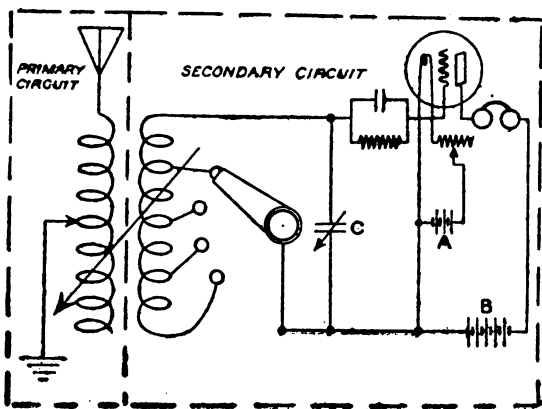

Fig. 60

wavelength as the primary or antenna circuit. It will be noticed that a condenser "C" is shunted across the secondary coil; the capacity of this need not be more than .0005 microfarads. If the desired maximum wavelength in meters is known, the required inductance in the secondary can be calculated from the formula

$$L = \frac{\lambda^2}{3552 \times C}$$

in which

( $\lambda$  is the wavelength in meters)

C the capacity in microfarads

L the inductance in centimeters

(1000 centimeters equal one microhenry)

The number of turns, diameter of winding, etc., can be calculated from the data given in the appendix.

It is of course apparent that the loose coupler is not as compact as the variocoupler and in addition is not as well adapted for panel mounting; therefore it has not enjoyed the same popularity that the variocouplers have had. The range and accuracy of tuning control, however, mark it as an extremely efficient type of radio receiving transformer.

#### VARIOCOUPERS

The use of a variocoupler with two variometers has become very popular especially among amateurs who desire to assemble their own receiving sets. The variocoupler (Figure 63) is another type of receiving transformer in which the induction in the secondary winding is controlled in a slightly different manner.

In the loose coupler the primary winding is usually adjusted for wavelength by means of a slider (though taps are occasionally used) but in the variocoupler the primary winding is always

adjusted by means of tapped switches. Sometimes two contact switches are provided, one for rough adjustment by tapping at every ten turns, and another that taps off at every turn. At first a rough setting is made and then the other switch is set to a finer adjustment. As has been just explained, the inductance of the loose coupler is controlled by sliding the secondary in or out of the

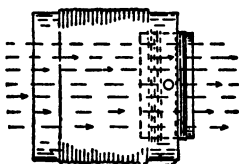

Fig. 61

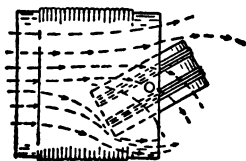

Fig. 62

primary winding, but in the variocoupler the secondary is wound on a smaller tube which is pivoted on a shaft and rotates inside of the primary tube.

Figure 61 shows the secondary winding in the position of maximum inductance, when all the concentrated lines of force pass through its core. As the secondary is rotated (Figure 62) the number of magnetic lines passing through it is reduced, in consequence of which the induced current is diminished. Occasionally the secondary winding is tapped, but as a rule the control depends on the rotational adjustment only. For this reason the variocoupler is usually found with the variometers in the secondary circuit to provide for more accur-



ate control of the latter. In fact a variable condenser is often shunted across the secondary coil.

#### VARIOMETERS

The variometer is one of the persistent curiosities of radio apparatus. Most amateurs have not tried to analyze fully its operation or its theory, yet actually it is a very simple device. It consists of two coils connected in series, one of which turns inside the other. The same effect and control of the induction as before is obtained, but instead of two separate circuits there is only *one*. The variometer coils should both contain the same length and size of wire so that the induced current has the same strength as the initial current. The initial current, then, goes through both coils but in addition there is the effect of the induced current in both coils of the series. Note here that we write the *effect of the induced current*. This induced current may *add* to the initial current or it may *subtract* from it. If the current flows through both coils in the same direction the magnetic fields assist each other and the self induction of the variometer is at a maximum. But if the inner coil is rotated so that the current flows through the coils in opposite directions the magnetic fields will oppose each other and self induction is reduced to a minimum. The self induction of the variometer therefore, depends upon the relative positions of the coils; and by the rotation of the inner coil a

continuous variation of inductance may be obtained.

Commercial variometers are usually made with the wire wound on turned wooden blocks, but are also produced with the wires wound on formed bakelite or other composition. An important feature is the necessity of having both coils equally balanced and with a minimum amount of clearance between the windings as they rotate inside of one another. Figure 64 illustrates the usual moulded form of variometer for panel mounting.

#### VARIOCOUPLER AND VARIOMETERS IN VACUUM TUBE SET

For receiving on wavelengths up to 600 meters the circuit using two variometers and a variocoupler is by far the most popular. To the beginner the numerous hook-ups that are at the present time being published are confusing, and it is hard to select the one that is best suited. For receiving the broadcasting with a vacuum tube set the one shown in Figure 66 cannot easily be surpassed. It should be noted that the dotted lines in the figure do not indicate wires or connections, but simply divide the hook-up into three separate circuits namely, primary, secondary and plate circuit.

The primary circuit consists of the aerial, the ground, a variable condenser and the primary winding of the variocoupler. After the filament has been turned on, this circuit is the first to be ad-

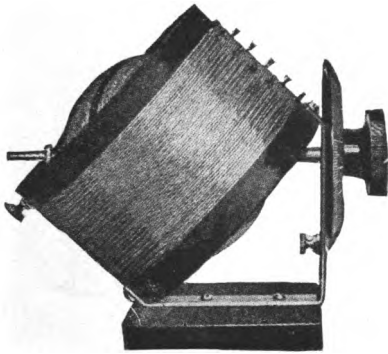

Fig. 63

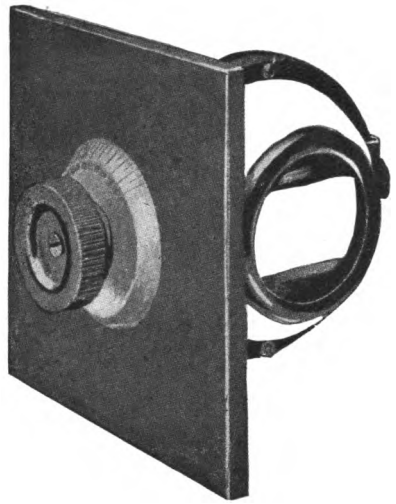

Fig. 64

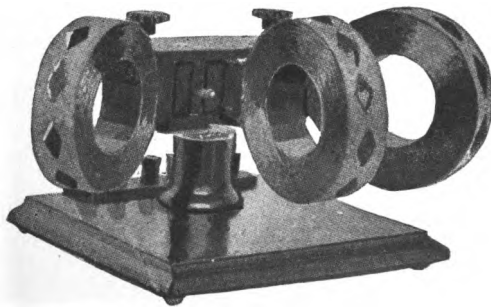
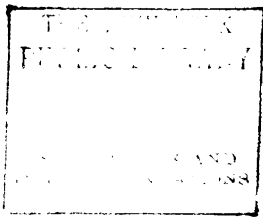

Fig. 65



justed, which is done through the tapped switch on the primary and the variable condenser, worked either in conjunction or separately. After a little experimenting with the set the tap will be found that gives the best results for receiving any particular broadcasting station; this also holds true of the variable condenser adjustment.

The secondary circuit contains the secondary coil of the variocoupler, a grid variometer, grid leak and condenser, and the grid itself. This circuit is controlled by the setting of the secondary coil and the variometer. In tuning, the secondary coil is first adjusted, then the variometer is used for more accurate control of the current flowing to the grid.

The plate circuit consists of the plate, the plate variometer, a "B" or plate battery, receivers and

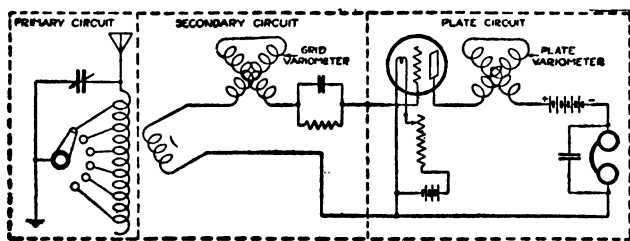

Fig. 66

their condensers. The "A" or filament battery, filament and rheostat are sometimes considered as forming a separate circuit but it is essentially a unit inside of the plate circuit. This circuit is controlled by the plate variometer. Occasionally

the voltage from the "B" battery is varied by tapping off different cells with a multipoint contact switch.

After all the adjustments have been made it is advisable to go over each setting again for slight improvements through finer tuning. Tuning such a circuit will not always be found a simple matter; it requires a little practice and much patience.

#### HONEYCOMB COILS

Another type of tuning apparatus operating under the transformer principle is the honeycomb coil unit. The honeycomb coils are single units and are used in conjunction with adjustable mountings, the coils with the mounting stand making up the tuning unit, as illustrated in figure 65. Similar stands are also made for a two-coil mounting.

When using the honeycomb coil mounting, advantage is taken of the same electrical phenomena as in the case of the loose coupler and the variocoupler. Namely, the oscillatory current flowing through the honeycomb coil which acts as a primary creates magnetic lines of force as shown in Figure 67. When flowing through the core of the honeycomb coil, which is used as a secondary, the lines of force induce a current therein. Now, as the angle is changed between the two coils (Figure 68) the number of magnetic lines affecting the secondary is varied, and therefore the angle controls the

strength of the induced current. Instead of tapping primary and secondary a number of honeycomb coils of different windings must be kept on hand to be inserted as the length of the broadcasting wave requires. This point however, indicates the main source of trouble and prejudice against the honeycomb coils. If a great range in wavelength adjustment is desired, coil units supplied with two or three taps are now obtainable, allowing for more adjustment with one coil.

To determine the proper coils for different wavelengths, Table III in appendix I gives the receiving wavelength in meters, and determines which coil should be used in the primary, secondary and

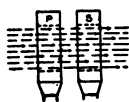

Fig. 67

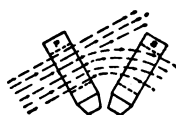

Fig. 68

tickler. The first column under each heading gives the number of turns, the second column the approximate inductance in milhenries and the third column the approximate wavelength range of each coil.

#### CRYSTAL DETECTOR SET

Figure 69 gives the hook-up diagram of the double honeycomb coil and crystal detector set. Tuning is controlled by a variable condenser

across the primary coil, and if available a variable condenser can also be shunted across the secondary.

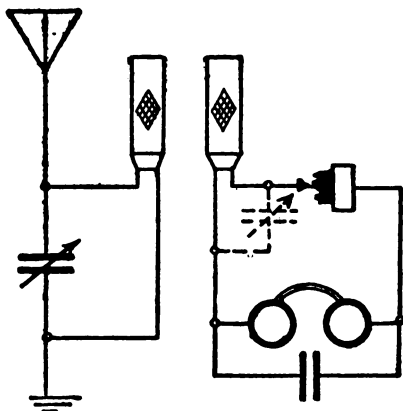

Fig. 69

### TWO COIL TUBE SET

In Figure 70 is illustrated the use of a two honey-comb coil unit in conjunction with a vacuum tube

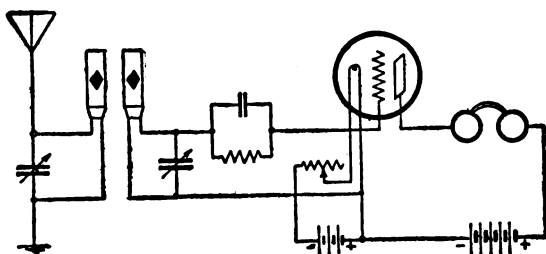

Fig. 70

detector. This circuit is highly sensitive, and through the wide range obtainable in the coils



permits of very flexible tuning. Variable condensers shunted across each coil are recommended. For short ranges the condenser in the primary circuit may be inserted between the ground and the coil.

### LOADING COIL

A use for the honeycomb coil that is often overlooked is the opportunity of substituting it for a loading coil. To increase the wavelength of a station the loading coil is connected in series between the aerial and the tuning apparatus. Honeycombs can be used for this purpose by inserting and trying the various sizes until the proper wavelength is obtained, final tuning to be adjusted at the primary slide of the receiving transformer. (For the calculation of the required inductance of the loading coil see appendix.)

### HONEYCOMB AMPLIFYING SET

Figure 71 illustrates the use of a three-coil unit with one step of amplification. The question of what coils to use is easily solved by referring to Table III in the appendix I.

A typical commercial three-honeycomb coil type of receiving set is shown in Figure 72. The third coil is generally used for regenerative circuits and is popularly known under the name of "tickler" coil. When thus provided it gives one

more adjustment to be made, the proper method of procedure being as follows; set the filament to as near proper brilliancy as it is possible to estimate. On many tubes is easily done—the tickler coil being set at zero during this adjustment—by increasing the brilliancy slowly until a hissing sound is heard in the receivers, and then decreasing just enough to stop the hissing. Now set the

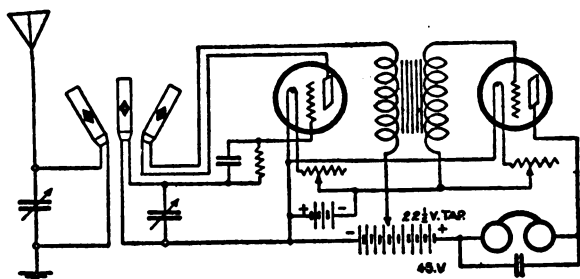

Fig. 71

coupling at or near maximum, the primary tuning control its lowest value, and the tickler at or near its lowest value. Then very slowly vary the secondary wavelength control from zero to a maximum. If signals are not heard change the primary setting five or ten degrees, and vary the secondary through its range again. This should be continued until the signals are heard. If they are not heard increase the tickler setting and repeat. After a signal has been located adjust all controls to best results, remembering that if it is desired to obtain selectivity or freedom from interference, the

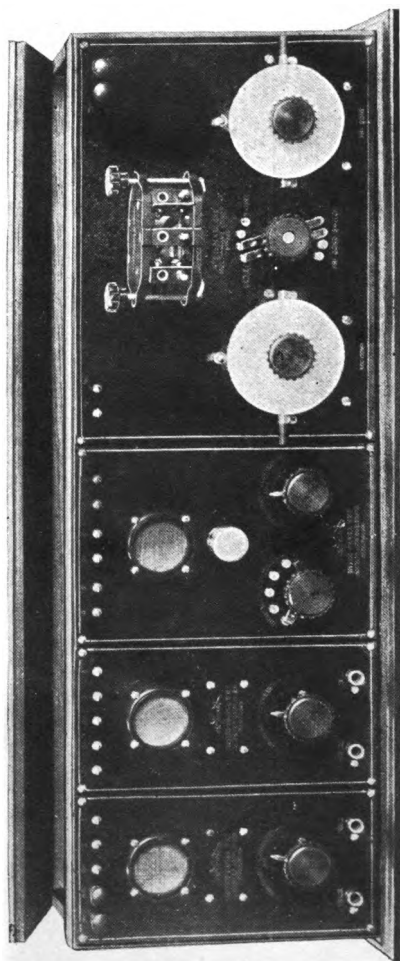
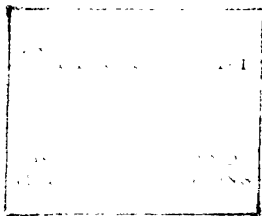

Fig. 72



coupling must be considerably decreased towards zero. This should be done in small steps so as not to lose the signal at any time. The tickler may be increased to best position but not so far as to oscillate the tube, as this spoils the signals. If the tickler is increased too far, the vacuum tube oscillates, that is, it becomes a small generator of high frequency current and as this current goes out on the aerial it causes waves just like those of a sending station (though not as powerful) and other receiving stations will be interfered with. Whenever whistling sounds are heard, varying in pitch, it indicates that some receiving station nearby is radiating waves because its tickler is turned up too far.

#### FIXED COUPLING TUNERS

A fourth type of tuning unit is one in which both the primary and secondary are wound upon the same tube, but are not adjustable relatively to their positions in the magnetic field (See Figure 73). The primary coil is usually provided with tapped switches for both rough and fine adjustments, in addition to which a variable condenser is shunted across the primary coil. The secondary may or may not be tapped but is also as a rule provided with a variable condenser. A tickler coil is added which revolves at one end of the tube, preferably at the secondary end. This of course, makes the set regenerative. In a fixed coupling

the unit is calculated for a limited wavelength range and operates at very high efficiency. A fixed and proper coupling between the primary and second circuits insures maximum signal strength and selectivity and at the same time removes the control that is most frequently misused by the average operator.

The tickler coil when added controls the feedback to the plate circuit. This *feedback* is a bugbear in

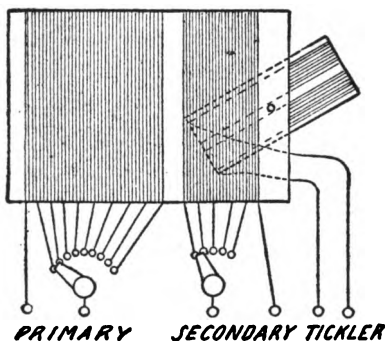

Fig. 73

the minds of the novice but its operation can be easily understood by the following analogy; in the gasolene motor of an automobile it is known that there is plenty of unused fuel ejected from the muffler. Now, if it were possible to sift out the good unused gas from the exhaust and feed it back into the motor to be used over again, this process could be called a "feedback." This is exactly what happens in the regenerative circuit. The tickler coil is affected through induction in a way

## TUNING AND TUNING APPARATUS 111

similar to the secondary coil and this current is fed through to the plate circuit. If too much is fed back however, the circuit is *choked*, so that control of the feedback is provided by rotating the tickler coil. In one position it is in line with the primary and secondary and gets the full strength of the induction. When turned the induction is decreased so that the strength of the feedback current is gradually cut down.

### INCREASING WAVELENGTH

To the amateur the question of wavelength increase with a given set often presents itself in the following practical form: "My set works best when receiving from the 360 meter broadcasting Station A," he is apt to say to himself: "I can also tune in without much trouble for Station B, which sends out at 485 meters. But I am utterly unable to hear Station C of 1250 meters, although it is the nearest of the three." And thus the question arises, "What must I do to get its signals?"

The case is analogous to that of a pail full of water. The pail will normally contain, say, 360 cubic inches of water, and can then be carried about comfortably. It might, if necessary, be filled to the brim to hold even 485 cubic inches. But it is evident that nothing short of getting a larger pail, or building up and altering the old one so as to increase its capacity will ever enable it to carry 1250 cubic inches of water. Similarly the

maximum wavelength that can be received with a given set cannot be increased without adding to or altering the receiving equipment.

In the foregoing pages it has been made clear that the antenna has a certain natural capacity and inductance which depends upon its size and arrangement. So have the condensers and coils in both the antenna and secondary tuning circuits, also depending upon their construction. Each wavelength corresponds to certain combinations of capacity and inductance, and the process of tuning consists in finding the proper combination by actual trial. It is evident, however, that a limit is imposed to the range of tuning by the maximum wavelength which that particular antenna and tuning outfit is capable of being adjusted to. If longer wave reception is desired changes will have to be made in the set to equip it for a new duty.

If the original antenna is rather short it may be necessary to install a *longer* one—not merely to add wires to the existing system. If the antenna is of sufficient length it may only be necessary to insert a new coil. The coil must be capable of tuning at the inductances corresponding to the desired wavelength. Unless they are large enough the variable condensers must be replaced to provide additional capacity.

It is thus seen that there are at least three variable factors that have to be brought into proper relationship to each other. No general hard and fast rule can be given in this connection, and each



case must be worked out individually. In the majority of instances the required equipment can be bought from a reliable manufacturer, or an expert familiar with the local situation should be consulted.

If the owner of the set desires to build his own apparatus, however, or wants to check up the accuracy of purchased material, a calculation which takes all the known factors in consideration is necessary. For this purpose full directions, including the working out of a typical example of this nature are given in appendix II of this volume.

## CHAPTER VII

### AMPLIFYING CIRCUITS

#### AMPLIFICATION

SOUND waves and alternating current waves, as has been explained before, are very similar in form. Both sound and electrical waves have amplitude and it is this amplitude that indicates the power back of the waves. In Figure 74, "A" indicates an alternating current or a sound wave without variation in amplitude.

Amplification means increasing this amplitude of either sound or electrical waves without alteration of the wavelength. The curve "B" shows an amplification of the curve "A" while "C" illustrates still another step of amplification. These curves illustrate quite clearly just what happens in the steps of amplification used in Radio telephony.

The question may be raised that both sound and radio waves do not possess a uniform amplitude but are irregular in form. In Figure 75 the amplification of an irregular wave form is illustrated. The point that should be clear in the mind of the reader is the fact that the frequency of the wave has not been altered but that to increase the ampli-

tude it is necessary to use greater power. This increase of power is obtained through the amplifying qualities of vacuum tubes. Heretofore the vacuum tubes has only been discussed as a detector. It has, however, the additional feature of

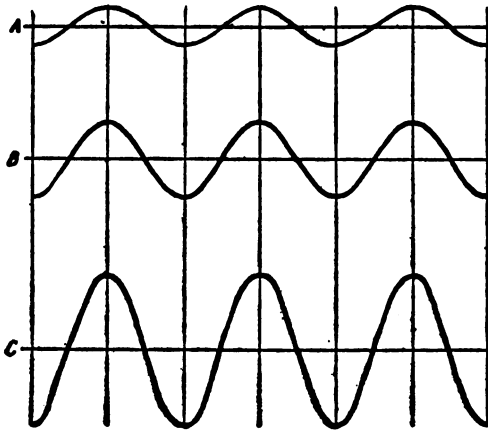

Fig. 74

increasing the potential of an electric current. In this respect it acts as a transformer, and the increased voltage is drawn from the "B" batteries. This *amplification* can be utilized for radio high frequency currents, or for the rectified radio frequency currents.

It may seem strange that the vacuum tube, considered as a detector or rectifier of alternating currents, should now be used for amplification of radio frequency currents without rectification. If the energy or potential of the grid becomes great

enough and the plate circuit has sufficient battery voltage, the tube simply amplifies the radio frequency current. The grid circuit has the condenser and grid leak omitted, permitting the full strength of the incoming current to charge the grid. The

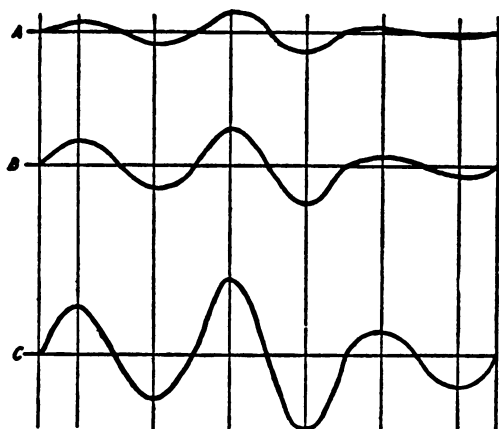

Fig. 75

range of a vacuum tube detector set is too limited for practical and commercial use, but the amplifier has served to increase the range of both receiving and transmitting stations to an enormous extent. The radio wave may be so weak that the detector tube cannot rectify it and supply sufficient energy to operate the receivers. Yet when one stage of radio frequency is added, the weak impulses are magnified to the extent that detection is possible and audible sounds are heard in the receiver. Adding another stage of amplification after the detector

tube will cause the sounds to become loud enough to be heard at considerable distance from the phone. Install another stage and a loud speaking device can be connected and the reception will be heard throughout the room.

Audio frequency amplification has been considerably developed and is in use for both commercial and pleasure purposes. The development

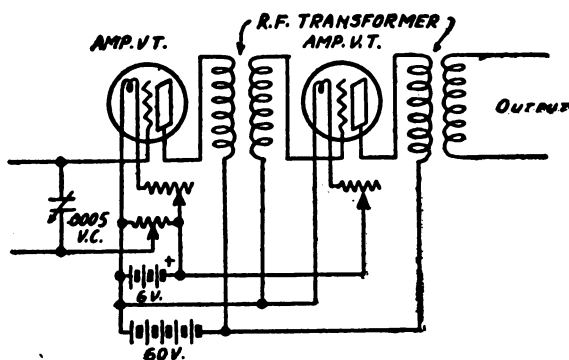

Fig. 76

of radio frequency amplification marks the greatest advance in radio that has taken place since the invention of the three electrode vacuum tube. Reception that has heretofore been too weak to be detected by ordinary means is readily heard with radio frequency amplification, the addition of but a single stage resulting in an astonishing improvement. Not only is there a tremendous increase in the distance over which signals are heard, but the reception is uncommonly clear from distortion.

Selectivity is greatly increased, thus permitting very efficient tuning for stations differing but slightly in wavelength.

Another highly important advantage of radio frequency amplification is that of the use of a compact loop aerial which has heretofore been impractical with audio frequency. The loop, because of its directional properties, offers greater advantages of selectivity. Figure 76 is the typical two-stage

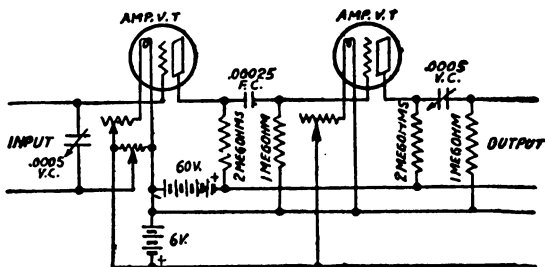

Fig. 77

radio frequency amplifier using transformers. The potentiometer is connected across the "A" battery in order to permit accurate control of grid potential—one of the important features in radio frequency amplification. It must be stated, however, that the range of radio frequency transformers is very limited and requires more than one to cover any considerable wavelength range. Figure 77 is a typical resistance-coupled two-stage amplifier. This type, although it has a greater natural operating range does not have the high efficiency qualities of the transformer coupled type. Unfortunately

its inefficiency is more marked in wavelengths under one thousand meters. In Figure 78 the

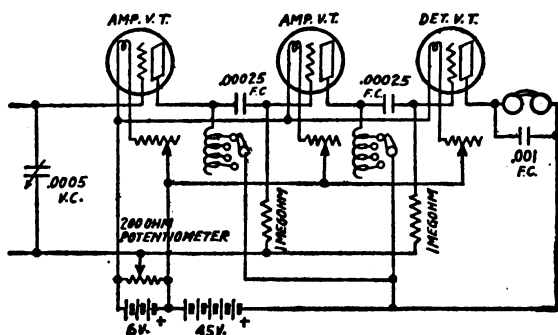

Fig. 78

coupling is accomplished through tapped inductances. This permits an increased operating range,

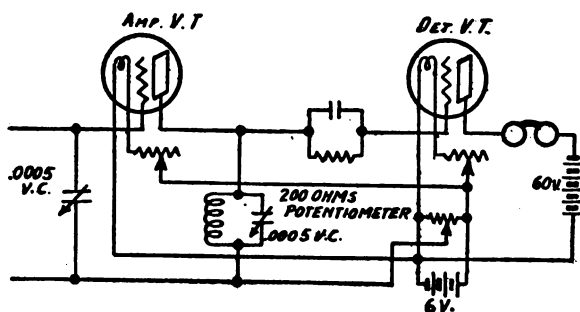

Fig. 79

and at the same time the two switches can be so designed that more than one stage is adjusted simultaneously. A new development is the combination coupling by means of an inductance and capacity

connected in parallel. This is illustrated in figure 79. High efficiency for low wavelengths is claimed for this type of hook-up. Audio frequency amplification has always been very popular in the past. Figure 80 shows the popular transformer coupled type.

The A. F. transformer ratios run from 3 to 1, from 10 to 1, but it has been found from experience

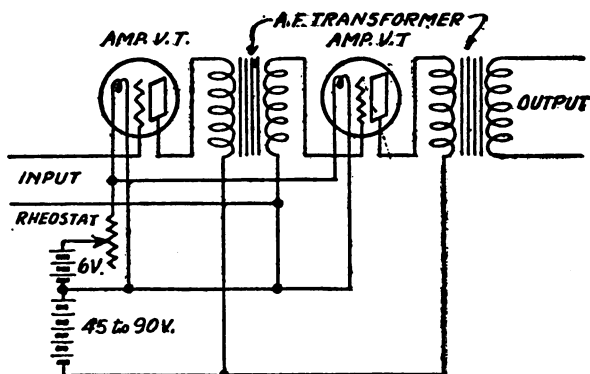

Fig. 80

that the range from three and four to one will give the best results. With the higher ratios the amplification emphasizes tube and battery noises to a great extent.

Figure 81 is an impedance coupled circuit, using "cascade" coupling. In this circuit the entire amplification is accomplished by means of the vacuum tube. Its use, however, is not as popular as the transformer coupling.

Assuming that amplification stages are to be



added to the standard type of hook-up shown in Figure 66, the decision to be made is whether radio or audio frequency is most advantageous. There is one all-important factor to be taken into account, "Is it long distance or local broadcasting that is of more importance to the operator?"

For local broadcasting the radio frequency alternating currents sent out by the broadcasting

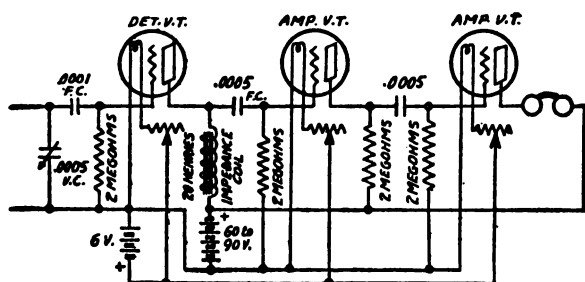

Fig. 81

station are not always strong enough for rectification by the detector tube, and for this reason it is necessary first to amplify the weak radio frequency current, and then send it to the detector tube for rectification. The resulting tones will be found clear enough in the receivers. If further amplification is desired a stage or two of audio frequency amplification can be added.

#### THE SINGLE VACUUM TUBE CIRCUIT

Figure 66 is a simple variocoupler and two variometer vacuum tube hook-up. The list of parts required follows:

- 1 Variocoupler
- 2 Variometers
- 2 43-plate variable condensers
- 1 Grid leak
- 1 Grid condenser
- 1 Detector vacuum tube
- 1 Filament rheostat
- 1 6-volt "A" battery
- 1 22½ volt "B" battery
- 1 .001 Mfd. fixed condenser
- 1 Pair of receivers

A possible addition is a 23-plate variable condenser, shunted across the secondary of the variocoupler.

#### RADIO FREQUENCY AMPLIFICATION

The hook-up of this circuit is given in Figure 82. The numbers enclosed by the circles are for identification of parts which are listed as follows:

- 1 Antenna
- 2 Ground
- 3 Variocoupler
- 4 43-plate Variable Condenser
- 5 23-plate Variable Condenser
- 6 Grid Variometer
- 7 Grid Condenser
- 8 Grid Leak
- 9 Detector Vacuum Tube
- 10 Plate Variometer

- 11 3 Filament Rheostats
- 12 6 Volt "A" Battery
- 13 .001 Mfd. Phone Condenser
- 14 Receivers
- 15 2 Amplifying Vacuum Tubes
- 16 60 Volt Battery
- 17 Radio Frequency Transformers

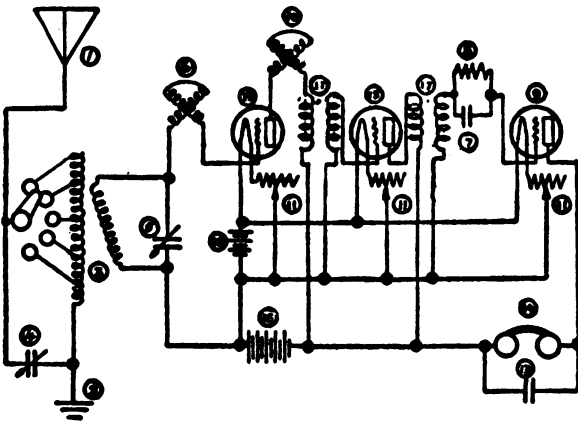

Fig. 82

## AUDIO FREQUENCY AMPLIFICATION

A two-stage audio frequency circuit is outlined in Figure 83. The identification numerals indicate the same parts for numbers 1 to 15 inclusive, as before.

- 16 3-22½ Volts "B" Batteries
- 17 2 Audio Frequency Transformers

## RADIO AND AUDIO FREQUENCY AMPLIFICATION

It is the ambition of every novice ultimately to have a complete and efficient receiving station. He wants to feel satisfied that both local and long

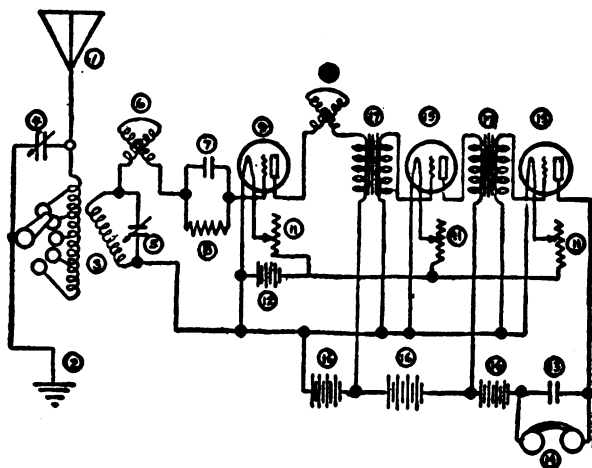

Fig. 83

distance broadcasting are within his reach. The reception in both cases should be strong enough for the satisfactory operation of a loud speaker. After going through the three previous stages he has the necessary equipment to assemble the set illustrated in Figure 84. The list of parts, identified by the numerals, follows:

- 1 Antenna
- 2 Ground
- 3 Variocoupler

- 4 43-plate Variable Condenser
- 5 23-plate Variable condenser
- 6 Grid Variometer
- 7 Grid Condenser
- 8 Grid Leak
- 9 Detector Vacuum Tube
- 10 Plate Variometer
- 11 5 Filament Rheostats
- 12 2-6 Volts "A" Batteries
- 13 .001 Mfd. Phone Condenser
- 14 Receivers
- 15 4 Amplifier Vacuum Tubes
- 16 2-22½ to 45 Volts "B" Batteries
- 17 60 Volt "B" Battery
- 18 Audio Frequency Transformers
- 19 Radio Frequency Transformers

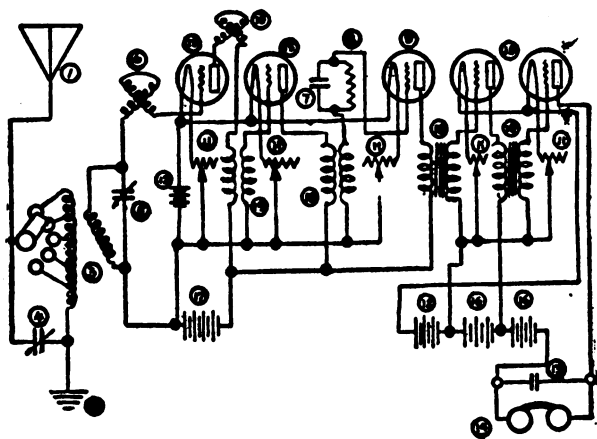

Fig. 84

All these parts are by no means immediately necessary. For example, the variometers can be omitted, the filament rheostats can be reduced to three in number, one to control the filament of both radio frequency amplifier tubes, one for the two audio frequency amplifier tubes, and one for the detector tube filament control. One "A" battery can be used, but the drain of the current required by 5 filaments will soon wear down the battery. For this reason and also because it keeps the radio and audio frequency circuits distinctly separate, it is advisable to use two "A" batteries. The number and voltage of the "B" batteries can be varied by slight changes in the circuit.

#### POWER TUBES

A way to obtain additional power or increased output consists in using tubes which are designed to carry heavy loads. Such tubes are available in the power tubes used for transmission and all of the standard types make excellent amplifiers when used with higher plate voltages. If these tubes are substituted for those in the amplifiers and then a higher plate voltage is applied, the output will be enormously increased, even by the use of only two or three stages.

It was once believed that power tubes were not sensitive enough to carry the feeble impulse through two stages of amplification. But it has been shown that this is not so, and that a power

amplifier using five watt tubes with 350 volts on the plate may be attached to a crystal detector through the medium of a suitable input coil and very excellent results have thus been obtained. This means that power tubes may be used for all stages of amplification, each at the same voltage. What must be watched for, when using such tubes as amplifiers is that the amplifying transformer will stand the higher voltage so that there will be no occasion of a burn-out. In the power amplifiers now available special transfer coils are incorporated so that there is no danger from that source as the coils will stand a pressure of over 500 volts.

Transmitting tubes are much freer from distortion than lower voltage tubes, especially when used at less than their maximum rated voltage.

## CHAPTER VIII

### ANTENNA AND GROUND

#### ANTENNÆ

THE antenna is one of the important pieces of apparatus of a radio set and care should be bestowed upon its proper installation. One hears sometimes of reception through bed springs, mosquito screening, etc., but it should be borne in mind that such cases are decidedly freakish in nature, just as is the occasional transmission to a point far beyond the usual range of a station. Such effects are due to extraordinary local causes which may repeat themselves from time to time but that can never be counted upon to recur at any stated period. Another fallacy that is often met with is the belief that adding wires to a given antenna will improve reception. While this may be true in certain cases it will generally be found, if poor results are clearly traceable to the aerial installation, that the installation itself is at fault—either too low, or too short, or insufficiently insulated, or badly grounded, etc.

It should not be forgotten that the construction of sets and their component parts are usually the



work of experts who have every facility at their command. The antennæ on the other hand are often built and installed by the purchasers of the sets, i.e., amateurs; and the very ease with which it is done and the good results that are occasionally observed in spite of adverse conditions, are responsible for many faulty installations. As an example it may be mentioned that the most perfect reception ever heard by the authors was obtained with a simple crystal detector set, without amplification, the aerial being a length of telephone wire dropped over the window-sill of a building among a maze of skyscrapers in the downtown section of a large city; a condition that would be astounding unless it were stated that the broadcasting station was located but two blocks distant and in direct view.

Antennæ may be divided into two general classes, according to whether they are located in the open air or indoors. The former are unquestionably better from the technical point of view; but modern living conditions in the cities do not always permit outdoor installation and a large percentage of radio set owners would soon lose interest unless they can regard their set as a musical instrument to be moved about at will or capable of being used on different premises without further preparation. The tendency of the trade therefore, is to produce self-contained sets that will fulfill these conditions, if necessary making up for inefficient aerials by additional amplification. Some very excellent

results are being obtained in this manner, especially in big cities. In the country, at greater distance from the broadcasting stations, the objections to outdoor aerials are not so apt to prevail.

The three types of outdoor antennæ generally used are illustrated in Figs. 85, 86 and 87 and are

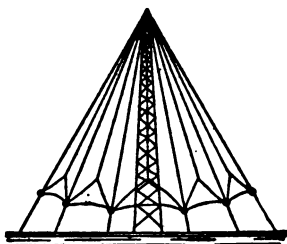

Fig. 85

called respectively the "umbrella type," the "inverted L" type and the "T" type of aerial. The names explain themselves by referring to the views.

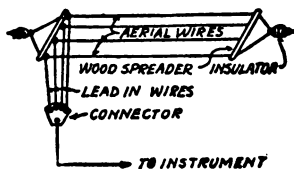

Fig. 86

The former type is the most costly and is beyond the requirements and facilities of most amateurs. It is widely used for transmitting stations, the tower having been built as high as 600 feet.

Whether the "T" or "L" type is adopted depends

generally on the lay of the ground and the relation of the terminals to the building wherein the apparatus is installed, that is, whether it is most convenient to attach the lead-in wire at the middle or at one end of the span, although the inverted "L" type is slightly more efficient.

The interception of radio waves by the aerial may be likened to the act of filling a glass of water with a spray nozzle attached to a garden hose. Like the water spray the waves issue from a central

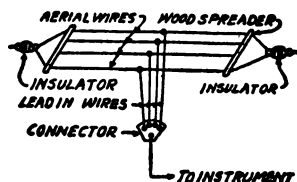

Fig. 87

point in a constant stream, thinning out as the distance increases. If placed close to the nozzle the glass will fill up rapidly and to catch a certain quantity in a given time only a small glass will be required; but if the distance is increased a larger glass becomes necessary. Similarly to obtain the same electric impulse in an antenna system the aerial must be longer if it is located at a greater distance from the transmitting station. This is a fact which, though almost self-evident, is often overlooked. Just as important is the height of the aerial above ground. It is often believed that it is only necessary to get the wire as high as possible

over the surface of the earth. This leads many people, especially among the occupants of tall apartment houses, to place their antennæ on the roof regardless of other structures in the immediate vicinity. That this is not necessarily correct will be understood if one stops to realize that an antenna wire functions as one set of plates of a condenser, the earth forming the other set. Apartment houses, water tanks and high structures generally are built with steel frames which are necessarily grounded. Hence if an aerial is placed, say, two hundred feet over the earth but only within fifteen feet of a water tank, the actual condenser effect—which determines the strength of the signals—is *not* that due to the two hundred, but to the fifteen feet. In such a case the water tank simply becomes the ground, which is thus brought much nearer to the aerial than was intended.

Similarly, trees should be avoided in the immediate vicinity. One of the reasons why reception is always so much better in winter than in summer is due to the fact that during the latter season the sap in the trees makes them so much better conductors. Every tree in the path of the radio impulses thus becomes a short circuit through which part of the wave is caught and returned to earth, whereby the range of transmission is decreased. In winter, on the other hand, the wood, being dry, does not conduct the currents as easily.

It is believed by many that total length of wire employed is the chief factor or that, for instance, a

four wire aerial need be only one-fourth as long as one of but a single wire. This is not the case. Increasing the number of wires does not increase the inductance in direct proportion. But capacity is increased and with it the ability to pick up interferences. Suppose the aerial to be in the vicinity of an electric transmission line: unless it runs at a right angle to it the induction will cause interferences which are four times as great if four wires are employed than with but a single wire, while the reception of radio waves will be only about twice as great. In consequence tuning out such interferences on a multiple aerial is more difficult.

Whenever possible, high tension transmission lines, groups of telephone wires or trolley wires, should always be located at right angles to the aerial. The currents in these wires set up a magnetic field which causes induction in the aerial if the latter is located entirely within that field.

The length of the aerial required depends upon the wavelength that it is desired to receive. In the appendix the wavelength characteristics for various lengths and heights are given. As an average the wire should be from 100 to 120 feet long and as high as it is possible to put it—preferably over 50 feet.

Fig. 88 shows a typical installation suitable for the roof of an apartment house and using two masts. The lead wire should be carried by porcelain cleats over a board securely fastened to the parapet and dropped far enough from the wall as to preclude any possibility of coming in contact with the build-

ing. Entrance to the room is best obtained by inserting a board about 6 inches wide under a window and passing a procelain tube through it to carry the lead-in wire, as shown in Fig. 89.

If the building is flanked by a low building it may be better to drop the aerial diagonally from one roof to the other. In either case the aerial proper must be well insulated, the insulators to be

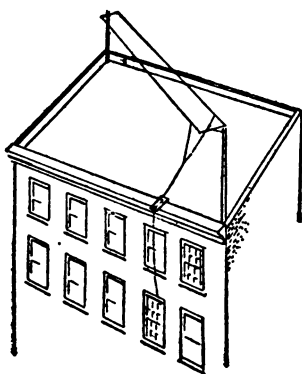

Fig. 88

placed so as to keep the live part of the antenna at least ten to fifteen feet from the points of fastening.

In the country, installations can often be suitably made from the house roof to a barn or garage. Aerials strung between two trees will give good results, provided the trees are far enough apart to allow the full required length of "live" wire and in addition sufficient suspension wire length to bring the insulators outside the greatest periphery of the tree, and avoid the branches.

## LIGHTNING PROTECTION

The question of lightning protection is the bugbear of many an amateur, yet mainly without reason. No fear of any accident need be felt if a few simple precautions are taken. As a matter of fact lightning is less apt to strike an antenna which is properly grounded, than any other object in the

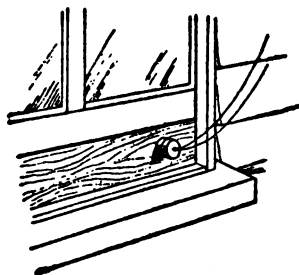

Fig. 89

neighborhood. For an aerial actually serves the same function as a lightning rod.

Lightning is merely a spark discharge between two charged clouds or a cloud and the earth. Every particle of moisture in the air carries an electronic charge of negative electricity, as has been explained at length in chapter three. In the upper reaches of the atmosphere these particles unite and condense, forming clouds. In so doing the individual charges are added together and the potential in the cloud accumulates just as it does in a condenser plate, the air beneath acting as the dielectric. If the

charge becomes great enough to break through the dielectric a spark occurs which relieves the tension until a new cloud combination builds it up again.

Putting up a lightning rod or an antenna is thus equivalent to establishing a path for the current to dissipate itself before the pressure reaches the breaking-down point, and is thus comparable to connecting the plates of a condenser with a very thin wire that will allow the current to pass as quickly as the voltage builds up. In this connection the authors remember some very successful experiments that were carried out in Central Italy some twenty years ago to prevent the many violent thunderstorms prevalent in that region with great damage to the grape crops. The method consisted in sending up a number of huge kites whenever a storm was threatening, connected together by a network of metal wires to collect the air charge and lead it to the ground with safety. Even when no storm was actually in progress the electric tension in the ground wire was so strong that the magnetic field surrounding it caused the hair of the observers to stand up and emit sparks with a crackling noise.

To lead the accumulations of electricity to the earth, the antenna should be grounded upon approach of a threatening cloud. This is best done by a lightning switch which should be placed on the outside of the building and at least 5 inches from the wall. Only a switch specially made for the purpose should be installed, with a very large gap, and on no account should an ordinary small knife



switch be used. One should remember that even the currents that are led down quietly are apt to have a potential of hundreds of thousands of volts, and unless the handle is well insulated and the gap very large a very severe shock may be received. If the thunderstorm is actually in progress, it is in fact best to throw the switch by means of a long attached rope, after having previously disconnected all apparatus from the aerial circuit.

The lightning switch should be connected to a good ground conductor, which may be a water

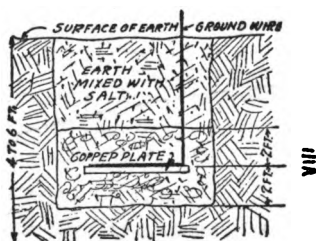

Fig. 90

pipe running outside the house, or a special ground can be made by burying a copper plate to a depth at which the earth is moist. The ground wire should be soldered to the plate. The ground lead should always run as directly as possible and avoid all right angle bends.

In addition to the lightning switch a lightning arrester is often provided. The lightning arrester, several types of which are on the market, consists essentially of a small gap enclosed in a tube across

which the feeble currents of the antenna circuit are unable to break through, but which will offer a very little resistance to the high voltages of atmospheric discharges. The proper way to connect up the antenna, lightning arrester, safety switch and ground is shown in Fig. 91. It should be noted that the lightning arrester, while it prevents the full discharge from entering the house, will not

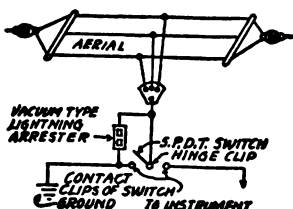

Fig. 91

protect the set from damage as long as it is connected in parallel with it—that is, as long as the switch is not grounded.

The chance of an aerial being struck by lightning is just exactly equal to that of any other spot—no more, and probably somewhat less.

Nevertheless the Board of Fire Underwriters have promulgated a set of rules regarding the installation of exposed receiving aerials, which vary somewhat according to locality. Those in effect in the Metropolitan District around New York City are herewith reproduced:

“Where the antenna is entirely within the building the fire hazard due to Radio signaling appar-

atus for "receiving" only is negligible and its installation requires no special safeguard unless current is taken from the light or power circuits.

The following requirements covering Radio receiving equipment employing aerial wires should be observed:

**FIRST**—The aerial wires should be protected by a lightning arrester of approved type, located outside of the building and enclosed in suitable housing. One side of such lightning arrester shall be connected directly to the antenna lead before the latter enters the building and the other side of the arrester shall connect to the outside ground wire; this outside ground wire leading from the arrester to the earth connection is in addition to, and should in no way be confused with the service ground wire connected to the receiving instrument. It is recommended that an approved single-pole knife switch be installed outside the building in parallel with the lightning arrester in order directly to "ground" the aerial when the apparatus is not in use, and especially during lightning storms.

**SECOND**—Where the conductor leading from the antenna to the receiving instrument does not exceed in conductivity a No. 12 B & S gauge copper wire, the ground conductor may be No. 4 copper wire or equivalent. This ground wire should be carried outside of the building in as direct a line as possible to the earth. In case a satisfactory ground cannot be obtained outside of the building, the ground wire may be brought into the basement or

cellar and connected in an approved manner to the nearest available water pipe. This ground wire must not be connected to gas pipe. Where the ground wire is brought into the building, it should be protected from contact with woodwork by a continuous porcelain tube.

**THIRD**—All Radio installations for “sending” and all “receiving” installations having outside exposed aerial lines for “receiving” or having connection with a light or power circuit, should be approved by certificate from this board.

#### INDOOR ANTENNÆ

Instead of being strung in a straight line the antenna wire can be wound spirally upon a frame of such small dimensions as to make it suitable for installing within the house, thus doing away with the outdoor installation. The loop antenna consists generally of a wooden frame in the shape of a cross, as in Fig. 92 (a), having wooden cleats at the ends of the arms to receive the turns of the wire or the wires can be mounted spirally directly to the arms (b). On account of the lower efficiency of this type a somewhat longer wire is required for good results than with an outdoor aerial. For reception of 360 meter wavelength a good loop should consist of about twelve turns of wire upon a cross so that the length of each side of the square is 4 feet. This will give a length of 192 feet of wire.

A loop aerial should be so mounted that it can

be turned in any direction, or at least it must be oriented so as to present its plane towards the transmitting station. Reception then will be strongest. If the loop is turned the sounds will gradually fade out until they disappear completely as the face of the loop is directed towards the incoming waves. This property is made use of in

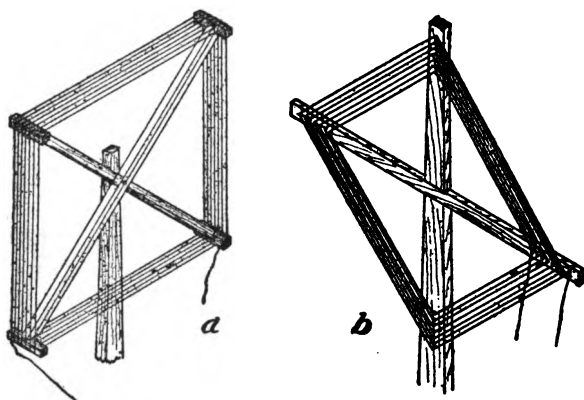

Fig. 92

locating a transmitting station, of which the direction is unknown, as in spotting violators of radio regulations and determining the location of ships at sea. Two stations at some distance apart are necessary, each one finding the direction of the unknown transmitter by means of a loop. The intersection of the directions thus found, when traced on a map, will indicate the location of the station sought.

Figure 93 shows a simple hook-up used with a loop

antenna embodying a condenser for general tuning, a vacuum tube for radio frequency amplification and crystal detector. The impulses received by a

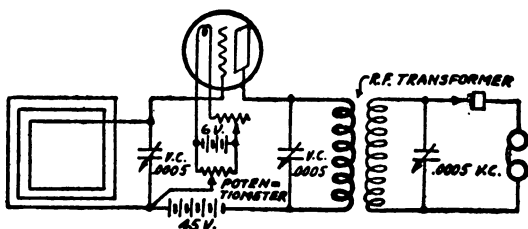

Fig. 93

loop aerial are so weak that amplification is always necessary. Unless the transmitting station is unusually close more than one step may be required.

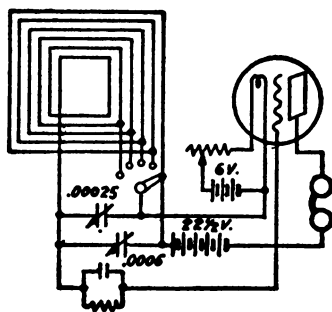

Fig. 94

Another simple connection involves a vacuum tube detector and a spiral antenna in which each individual turn of wire is run to a tap switch. This arrangement shown in Fig. 94 gives a very sensi-

tive tuning range when used with a condenser of small capacity.

#### LIGHT SOCKET ANTENNÆ

Of late, devices have been placed on the market to enable one to utilize the electric light wires entering the house. Such wires act as aerials in picking up radio waves, which are not interfered



Fig. 95

with in any manner by the regular current. A condenser must be interposed between the light wires and the radio set however, which will shut out the light current while allowing the high frequency impulses to go through. The internal wiring of such a device is shown diagrammatically in Fig. 95.

#### GROUND CONNECTION

The ground terminal of the receiving set should be connected to a water pipe or a convenient radiator. It is well to remember that a proper connection is just as important as a well insulated aerial. The best way to make such a connection is to use a special clamp made for this purpose, care having been taken to scrape all paint or rust from the

pipe. Or the following method can be used to insure a good contact :—Scrape the pipe clean for a length of about 2 inches, and wrap a sheet of tin-foil around it. Next wind the ground wire tightly about the tinfoil for six or seven turns and solder the wire and foil together with a generous amount of solder.



## CHAPTER IX

### BATTERIES

#### DRY BATTERIES

To eliminate the batteries and their attendant expense for maintenance and replacement by utilizing the house lighting current is indeed possible, but generally not advisable.

A suitable step-down transformer can be connected to a 110 or 220 volt light socket that will reduce the pressure to the low values required by radio circuits, but results can be obtained only if direct current is supplied from the power house, and this is the case in but a few localities. The alternating current usually supplied is of 60 cycles, giving 120 reversals every second, which are frequent enough not to affect the steadiness of the light in an incandescent bulb, but will cause a very perceptible though low hum in the radio receiver. Even in direct current there is a very slight drop in potential as the brushes pass over the commutator segments that causes a high noise which interferes with reception.

To actuate the receiving set it is best, therefore, to use chemical cells, either so-called *dry batteries* or *storage batteries*.

Whenever two electrical conductors of different material are placed in a chemical solution which reacts with one of the conductors, a difference of potential is created between them, which will cause a current to flow if they are connected to the ends of a circuit. There are many combinations of materials and solutions (called electrolytes) that will produce this result. Thus copper, zinc and sulphuric acid, or carbon and zinc immersed in chromic or other acids.

The familiar dry cell is of this type, though in this case the "dryness" is obtained by use of blotting paper or similar material saturated with the electrolyte. The dry cell of which Fig. 96 shows a cross section consists of a shell of zinc which is lined on the inner side with the saturated absorbent. The zinc forms the negative plate and a rod of carbon in the center of the cell the positive, the space between being filled with a material, the composition of which is usually a trade secret of the manufacturer to act as depolarizer, the function of which is to absorb chemically the hydrogen gas which is liberated on the surface of the zinc by the chemical action. If this depolarization is imperfect or slow it happens that bubbles of gas will collect on the metal and cause a drop of voltage by preventing contact with the metal. When the hydrogen is absorbed the voltage rises again. This causes a fluctuation of the voltage which manifests itself in the form of a peculiar noise in the receiver that is often very puzzling to the list-

ener. It indicates that the battery is not suited to the work or is being drained too rapidly.

The life of a dry cell depends upon the quality of its manufacture and the rate at which the current

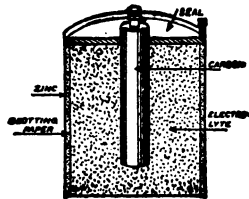

Fig. 96

is being drawn out. The latter can be regulated by the method of wiring to the circuit. Thus if the voltage required by the circuit is 6 volts and each

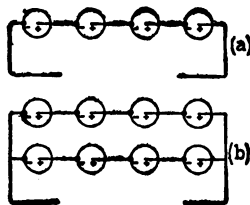

Fig. 97

cell supplies  $1\frac{1}{2}$  volts four cells can be hooked up in series (a in Fig. 97) but they will be discharging at their maximum rate. If on the other hand 8 cells are connected in a combined series and parallel connection (b) each cell will be required to furnish only half as much current as before, but the life of the battery will be considerably more than doubled.

Only batteries especially constructed for the purpose should be purchased. They are supplied with a number of cells all properly connected, allowing a range of voltages from  $22\frac{1}{2}$  volts units to as high as 100 volts. Taps are usually provided in steps of  $1\frac{1}{2}$  volts each. Figure 98 shows such an

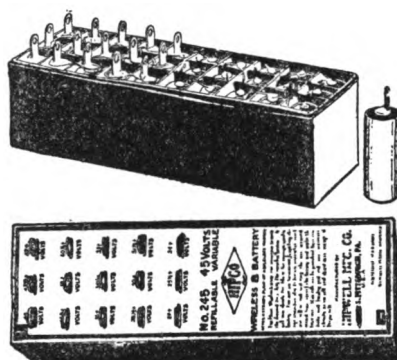

Fig. 98

arrangement, also indicating how the terminals are sometimes passed through the cover of the box and marked so as to enable the operator to connect the required number for any given pressure without any chance of mistake.

### STORAGE BATTERIES

The comparative short life of dry batteries and the variations in voltage that occasionally occur in the best of them have caused a wide adoption of

the storage cell. This type, as anyone knows, merely stores a charge of electricity that has to be replaced from time to time.

The charging and discharging of a storage cell is due to a chemical and electronic action, a discussion of which need not be given here. It suffices to say that the plates consist of lead grids with certain oxides and sulphates of lead pressed into them. These plates are kept a certain distance apart by separators. The electrolyte is dilute sulphuric acid.

The average radio set owner has to rely upon the manufacturer's word and reputation in purchasing his battery, and certain well established trade names are a distinct asset as they generally denote a long experience in construction and satisfactory service. A few notes are here given to insure proper care and a long life to the battery.

1. Batteries should never be dropped or "slammed down." This always causes the chemical to shake loose from the grids and to collect at the bottom of the cell. In time it will rise high enough to touch both sets of plates and thus short-circuit the cell.

2. A battery should be charged as soon as its voltage drops to 1.6 volts per cell. One should remember that current is being used at a fairly high rate, and that the total number of hours of use mounts up very rapidly. A detector tube and one amplifier tube use up about 1 ampere per hour each. Now if the battery is rated at 50 ampere

hours it is theoretically good for 25 hours' service. As a matter of fact the battery should never be allowed to run down completely.

3. Frequent electrolyte tests should be made, and a hydrometer is a most essential part of a battery outfit. The normal full charge reading is 1.280, though a battery can be kept under charge until the specific gravity reaches 1.300 or so. When the hydrometer shows a gravity of 1.100 a new charge should be applied without delay.

Sometimes a voltmeter is connected across the battery terminals and mounted on the panel. This is fairly satisfactory yet not always reliable, as it will show whether the voltage is high enough to operate the set at that particular moment, yet give no indication how long it will last. Sometimes the voltage of a battery is fairly high although the charge is nearly run down and it may take a sudden permanent drop after a short time. The voltage of a fully charged cell is 2.10 volts, which drops to 1.5 upon discharge.

4. Nothing but distilled water should ever be used to replace the electrolyte that has been consumed during use. The acid never disappears, but the water is broken up in the chemical process. If the battery should ever be overturned and the electrolyte spill out it requires a definite process to put matters right again that can be done only by an experienced battery repairman.

As a matter of convenience as well as reliability it is better to have two batteries of small capacity

than one of large capacity. The latter is apt to be very heavy. Also if anything should go wrong it is preferable to have two small units that can be handled or sent away independently of each other.

Storage batteries will give longer service if used intermittently. Hence it is advisable to have two separate units of like capacity connected to the set through a double-pole double-throw switch. Every hour or so the batteries should be alternated.

The charging of storage batteries requires special apparatus to transform the voltage of the power line and to rectify the latter if it supplies alternating current. Such rectifiers and charging units can be used on both "A" and "B" storage batteries. There are generally no parts to wear out and they require little attention. The actual current drawn from the house lighting circuit amounts to very little, therefore making recharging an inexpensive operation. Batteries can be set up and recharged over night.

CHAPTER X  
MISCELLANEOUS APPARATUS  
MEASURING INSTRUMENTS

ACCURATE control of transmitting sets by means of indicating electrical instruments has become firmly established among experienced operators. To insure proper wave radiation the operator at the transmitting station uses exceedingly accurate instruments to guide him. At the receiving end the use of instrument control is also desirable, not only as a means to a more positive adjustment, but because with suitable instruments damage to the tubes can be prevented and the life of the tubes so greatly prolonged that the saving in the cost of tube renewals will soon pay for the cost of the instrument installation.

When electric lighting was in its infancy the line voltage was adjusted by observing the brilliancy of an incandescent lamp located in the power station, but to-day a power house will contain rows upon rows of measuring instruments upon its switchboards, and it would be deemed absurd to gauge the current strength from a single lamp. Yet that is precisely the method by which most radio sets



using vacuum tubes are adjusted—by turning the filament rheostats until the filaments appear to have the proper brilliancy. Because of the fact that the filament is hidden behind the plate and the tube is usually mounted behind the panel, vision control of vacuum tubes is even more difficult and inaccurate than in the case of electric light circuits.

Most people know that the lamps supplying us with light are rated at about 115 volts and that they will unfailingly burn out if a higher voltage is passed through them. On the other hand if the line current should drop to a low value the light-giving quality becomes considerably reduced. Similarly, tubes will burn out if too much current is passed through them or, if the current is insufficient, lose efficiency and give unsatisfactory results.

The vacuum tube is a delicate and sensitive instrument and it operates most effectively at definite values of plate voltage and filament temperature. Without the indications of accurate electrical measuring instruments the operator can only guess at what is really taking place within the tube. In an effort to be careful he may adjust his voltage to too low a value. This will result in poor phone reception—which is likely to be promptly blamed on the broadcasting station. But as adjustments are usually made in a brilliantly lighted room the practice is more common to overheat the filament and “force” the tubes in an effort to secure better results, which reduces the life of the tube without a compensating increase in reception.

As small an increase of 5% over the rated value as determined by the tube manufacturer will, if maintained, reduce the life of the tube to only one-fourth its normal life.

#### METHODS OF FILAMENT CONTROL

There are two general methods of filament current control. Voltmeter control and ammeter control. The voltmeter enables the operator to know the voltage of the current that is passing through the glowing wire and thus to keep it adjusted to any desired value. With the ammeter the amperage is kept constant. After extended experimental investigations in coöperation with the manufacturers of tubes the United States Navy authorities have determined that the average life of a tube with voltage control is three times as long as with amperage control. The former is therefore to be preferred and is being used in all new installations. There is quite an obvious reason for this difference in length of life. As the filament glows it is constantly disintegrating, giving off electrons (which settle upon the inner surface of the glass and cause that brown color so characteristic of old tubes) and as it wastes away and becomes thinner its resistance increases. Now if the same current as measured on an ammeter is forced through the filament (Fig. 99) the temperature constantly increases as time goes on, due to the gradual increase in resistance. The higher tem-

perature hastens disintegration which soon results in the burning out of the filament. If, on the other hand, the voltage is maintained constant by a voltmeter across the filament as in Fig. 100, the current through the filament decreases as the resistance increases. This prevents the heat from

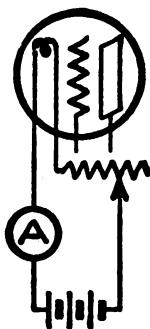

Fig. 99

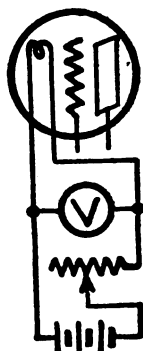

Fig. 100

reaching dangerously high values and the life of the tube is therefore lengthened.

Aside from the great saving in tube life the proper use of both ammeters and voltmeters in the filament circuits also results in greater ease and accuracy in making adjustments. The characteristic curves of various tubes differ even if they come from the same manufacturer and are of the same type, but for any given tube its critical values may be determined once for all and, at subsequent use, it is merely necessary to adjust the filament to its best value and then to proceed with the tuning

adjustments which are thus made independent of tube regulation. An additional very important function of the filament voltmeter is that it shows by its indication the condition of the "A" battery. While not as accurate as the hydrometer test it yet offers constant indication of the general condition.

The plate voltmeter, though not as important on a receiving set as the filament voltmeter, is of great convenience and assists materially in obtaining best results from the set. A glance at the plate voltmeter will tell whether the "B" battery is in fair condition or not, or whether it is properly connected, thereby eliminating the necessity of examining all the connections on the set in case of trouble.

#### CONSTRUCTION OF METERS

Figure 101 illustrates the internal construction of a permanent magnet-and-movable-coil instrument, such as is used in direct current voltmeters, millivoltmeters, ammeters and milliammeters. Essentially the movement consists of the following parts:

1. A permanent magnet having pole pieces on the inside of the two extremities and having a cylindrical core inserted between the pole pieces, permitting a gap of minimum size sufficient to permit the coil to rotate.
2. The moving element, which consists of a

coil wound in accordance with the requirements of the instrument and mounted on jewel bearings so as to rotate freely in the gap between the pole pieces and the core.

3. Two springs attached to the movable coil above and below, and tending to rotate the coil in

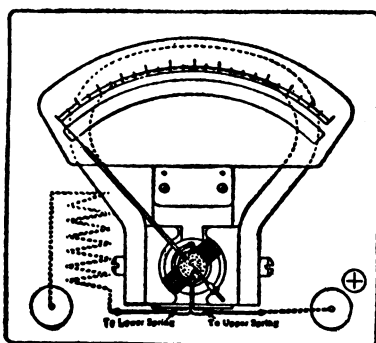

Fig. 101

a counterclockwise direction. They also serve to carry the current from the external circuit through the coil.

4. A pointer rigidly connected to the coil, as shown in the illustration.

5. An external resistance which is necessary in the case of voltmeters (shown to the left of the instrument).

#### HOW METERS INDICATE

The springs produce a torque which tends to keep the pointer on the zero mark of the scale. This torque is in a counterclockwise direction.

The permanent magnet produces a magnetic field between the pole pieces and through the core. When current flows through the coil another magnetic field is established surrounding the coil, its strength being proportional to the magnitude of the current. The two magnetic fields are so related to each other that they produce a torque in a clockwise direction. This torque tends to move the pointer towards the right and when properly counter-balanced by the tension in the springs will indicate volts or amperes on a proper scale.

One notes from the foregoing that there is no essential constructional difference between an ammeter and a voltmeter. Indeed the principle of both is the same and they differ only in the amount of current that is allowed to pass through them. In an ammeter the moving coil is wound with heavy wire, offering no appreciable additional resistance, through which the full current of the circuit is allowed to flow. The deflection of the coil is then proportionate to the amperage in the coil. A voltmeter, on the other hand, measures the potential difference between the terminals of a circuit and is hence always shunted across the source of current. To prevent a short-circuiting effect a very high resistance is inserted, which permits only a negligible amount of current to flow through the instrument. What the needle actually registers is the amperage of this small flow, but its voltage is proportional thereto, as the resistance is a known and fixed quantity.

USING THE INSTRUMENTS

The various adaptations of electrical measuring instruments to vacuum tubes and receiving sets are illustrated in the accompanying hook-up diagrams. An ammeter may be used for filament

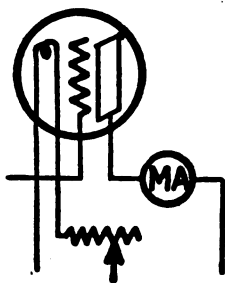

Fig. 102

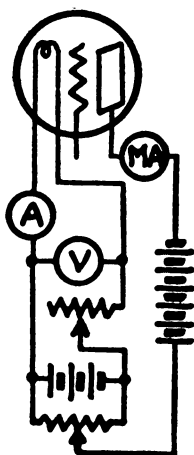

Fig. 103

control or a voltmeter may be substituted therefor with better results, as already stated. Note in Fig. 100 that the voltmeter is connected directly across the filament between the rheostat and the tube. Fig. 102 indicates how a milliammeter should be inserted in the plate circuit.

A very simple hook-up by means of which it is possible to become more familiar with the vacuum tube and its characteristics is shown on Fig. 103. This consists of an ammeter and a voltmeter in the

filament circuit, and a milliammeter in the plate circuit. By varying the filament voltage the magnitude of the current flowing through the filament can be read off directly on the ammeter and the resistance can be computed from Ohm's law. By varying the "B" battery voltage for various filament settings the nature and magnitude of the plate current may be studied.

#### THE COMPLETE RECEIVING SET

A complete set consisting of a detector unit and one stage of amplification is shown in Fig. 104, equipped with all meters which are practical in a

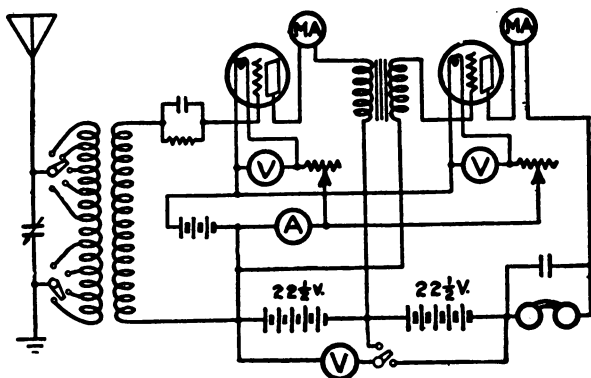

Fig. 104

receiving circuit. It is not essential that the two filament voltmeters be used as shown in the diagram, but in a manner similar to that shown for using the plate voltmeter on either the detector or



amplifying plate, the filament voltmeter may be connected to a switch, so as to indicate the filament voltage in either the detector or amplifier tube.

Receiving set operators who wish to progress with the development of the science will be amply repaid for their efforts if they utilize every possible method for increasing the efficiency of their sets. Years of tedious scientific research by the most eminent men in the electrical profession have resulted in the perfection of the modern direct-indicating measuring instruments and anyone using electricity in some form should avail himself of their work. An accurate indicating instrument is as essential for obtaining good results from a vacuum tube receiving set as for the protection of the huge generators which supply the world with electricity.

#### THE USE OF TELEPHONE JACKS AND PLUGS

The use of telephone jacks in receiving sets has now become standard practice. They provide a convenient and rapid means of shifting the receivers from one stage to another. They can be connected so as to cause the insertion of the plug in any stage to light only those filaments required for that stage of amplification. Removal of the telephone plug can extinguish all filaments and permit their relighting by the mere insertion of the plug without readjustment of the filament rheostats.

Because of this completely automatic lighting and extinguishing of the filaments through the use of proper filament control jacks, the life of the vacuum tubes is greatly increased and the drain on the filament batteries is reduced to a minimum.

In Figure 106 five different types of telephone jacks are illustrated, both in the commercial form

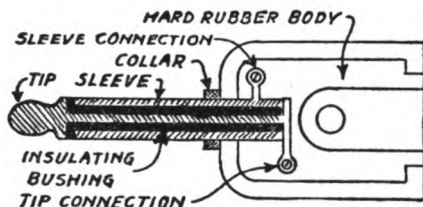

Fig. 105

and also in the conventional manner in which they are represented in wiring diagrams and hook-ups. Before explaining the operation of the jacks it is well to understand the construction of a typical telephone plug. It will be noticed from Figure 105 that there are two distinct connections that can be made through the plug. One through the sleeve of the plug having a connection to the terminal inside of the rubber body, while the other terminal is connected to the tip through the rod passing through the sleeve. The receivers are connected to the two terminals in the body of the plug and the connection to the jack is made through the tip and the sleeve.

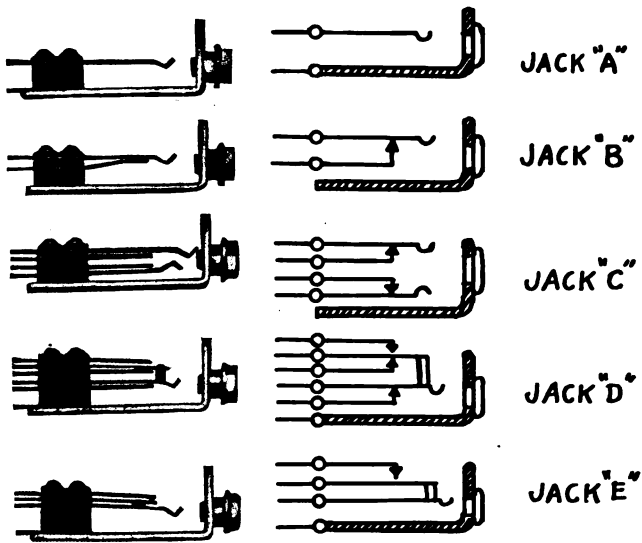

Fig. 106

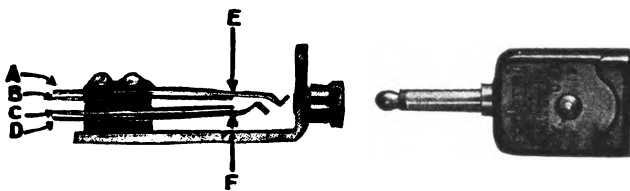

Fig. 107

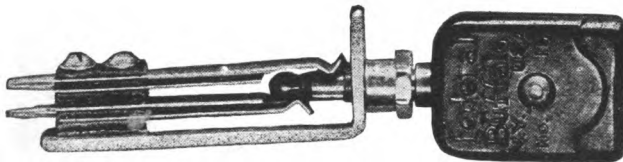

Fig. 108



## DESCRIPTION OF THE JACKS

Jack "A" in Figure 106 is the simplest form made. When the plug is inserted the tip presses against the spring contact, while the sleeve makes contact with the body of the jack. In this way the receivers are connected or disconnected as desired. The use of a jack of this type with a crystal detector set is shown in Fig. 109. Jack "B" is somewhat similar, but here an additional spring makes a contact with the first spring when the plug is out, but when the plug is inserted the tip makes contact with the first spring, and in pressing it back, breaks the contact with the second spring. This jack can be used in plugging into different stages of amplification, but will not operate as a filament control jack. In the convention this additional contact is represented by the arrowhead as being in contact with the top spring. This indicates that when the plug is inserted the contact is broken. Jack "C" has two springs for making contact with the tip and sleeve of the plug. The body of the jack is not used for a connection in this case. Moreover there are two additional springs making contact with the first two when the plug is out. When the plug is inserted these two contacts are broken. Fig. 107 shows the plug and jack. Springs A and B make contact at point E, while springs C and D make contact at point F. Fig. 108 shows the plug inserted in the jack. Spring A no longer makes contact with spring B,

but now makes contact with the sleeve of the plug. The contact between C and D is broken, and D makes contact with the tip of the plug. It will be noticed that the springs are separated by pieces of insulating fibre, preventing any short circuits between the springs. The ends of the springs project and terminate in hooks to which the connecting wires are soldered.

#### FILAMENT CONTROL JACKS

So far the jacks have had a limited use, and have been easy to understand. For filament control in addition to connecting the receivers, a more complex type of jack is needed. The most used of this type is shown as jack "D." It will be noticed that in this type the sleeve of the plug makes contact with the body of the jack while the spring that makes contact with the tip breaks contact with another spring as before when the plug is inserted. In addition, this spring is connected to another spring by means of an insulated spacer, so that this new spring moves with the first, but is not electrically connected to it. This third spring touches another spring when the plug is out, but when the plug is inserted it breaks contact and makes new contact with a fifth spring above. In using this jack, the three lower terminals to the body of the jack and the two springs are used for the receiver connection, while the three upper terminals of the three independent springs are used for filament

control. This jack is used between the detector and stages of amplification, but when we are operating on the last stage of operation, we do not require all the springs and contacts.

In Jack E, the sleeve of the plug connects to the body of the jack. The first spring makes contact

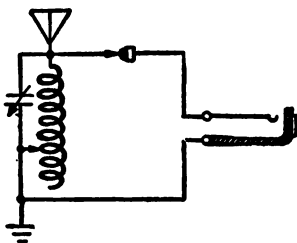

Fig. 109

with the tip as before, but we do not have the other spring for breaking contact. In the same way the insulated spring working with the tip spring makes contact with the one above when the plug is inserted, but does not break contact with another as before.

#### USING THE FILAMENT CONTROL JACKS

Figure 110 is the hook-up diagram for a three-stage audio frequency amplifier with detector using filament control jacks. For the detector and first and second stages of amplification type "D" jacks are used, but for the last stage of amplification the type "E" jack is used. First it will be noticed that the one side of the filament of all four tubes is

connected to the positive terminal of the "A" battery, the other side of the filament after passing through the filament rheostat goes to the second spring of its respective jack. The top springs of all the jacks are connected to the negative terminal of the "A" battery. Therefore, when the plug is inserted in any jack it lights that filament, but the third spring in the detector jack is connected to the second spring in the 1st amplifier jack, the third spring in the 1st amp. jack to the second spring in the 2nd amp. jack, and the third spring in the 2nd amp. jack to the second spring in the 3rd amp. jack. Therefore, when the plug is inserted in the 1st amp. jack, for example, the first and second springs make contact and the filament of the 1st amplifying tube is lighted, and because of the connection to the third spring of the detector jack which makes contact with the second spring of the detector jack, the filament of the detector tube is lighted also. In inserting the plug in the 1st amp. jack the contact between the second and third springs is broken so no current will be fed to the 2nd and 3rd stage tubes. This same is true for all the other stages.

In the 1st, 2nd, and 3rd amp. jacks the insertion of the plug connects the receiver between the plate and the positive terminals of the "B" battery, in the 1st and 2nd it simultaneously breaks the contact to the primary winding of the transformer of the following stage which is connected to the fifth spring of the jack of the preceding stage.



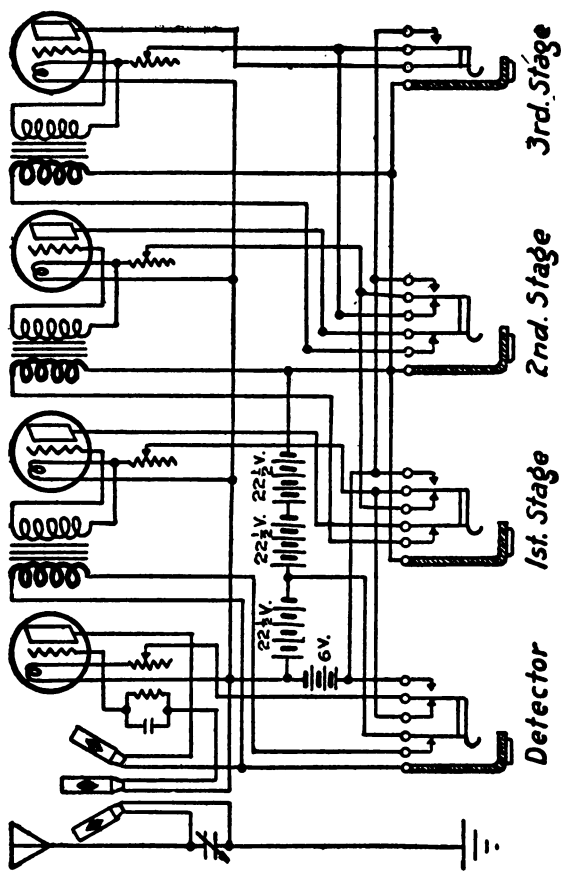

Fig. 110

In the detector jack the plug connects the receivers between the tickler coil and the battery, at the same time breaking the contact to the primary of the transformer of the 1st stage of amplification.

It is quite distinctly shown that the jacks break the circuits between the stages not in use and those that are in operation. Failure to do this would seriously affect the efficiency of the set.

## CHAPTER XI

### “DON'TS”

Don't buy cheap apparatus and expect high-priced results.

Don't buy instruments without considering their adaptability to your circuit.

Don't try to transmit without a license.

Don't handle your set carelessly.

Don't run the aerial wires parallel to power wires.

Don't use smaller than No. 14 Gauge wire for antenna and lead-in.

Don't let the antenna wires touch buildings, trees, etc.

Don't add too many wires to your aerial.

Don't have the wires less than 2 feet apart if possible.

Don't expect as good results with an indoor as with the outside antenna.

Don't forget to insulate your aerial.

Don't try to operate two sets from one antenna.

Don't expect good results with a poor ground connection.

Don't insert condensers in series in the antenna circuit and expect to increase your wavelength.

Don't use unnecessarily long leads.

Don't wind your leads into coils, as is customary with battery connections.

Don't use a poor pair of receivers with a good set.

Don't drop your receivers on a table or floor if you expect to retain the magnetism in the poles.

Don't let every visitor take the covers off and play with the diaphragm.

Don't expect the same results from an amplifying horn that you expect of a loud speaker.

Don't add a loud speaker to a crystal set.

Don't expect too much of a crystal detector.

Don't handle the crystal with fingers.

Don't mount the crystal in lead or solder.

Don't forget that a fixed adjustment on a crystal will not retain its sensitivity permanently.

Don't be afraid to wash the crystal occasionally.

Don't use house lighting current for six volt tubes.

Don't try to operate your tubes without rheostats.

Don't give your filament too much current.

**Don't leave your tickler at maximum with your tube oscillating and generating radio waves.**  
**Don't use plate batteries to light your filaments if you expect them to last.**

**Don't waste time in careless workmanship when assembling a set.**

**Don't drill your panels until you have laid out the location of all the instruments to be mounted on the panel.**

**Don't use wooden or metal panels, unless all instruments are carefully insulated and the panel grounded.**

**Don't mount your instruments too closely together.**

**Don't run all your wires behind the panel neatly parallel to each other. Remember that each wire is surrounded by a magnetic field which may affect its neighbor. Place wires at right angles wherever possible.**

**Don't expect good results with loose connections.**

**Don't make coil windings by guesswork and expect to operate on 360 meters.**

**Don't make poor soldering joints when tapping your coils.**

**Don't handle a variable plate condenser carelessly.**

**Don't neglect to take into consideration that ammeters, voltmeters and milliammeters are an asset to any receiving set.**

Don't experiment with complicated hook-ups until you understand simple ones.

Don't overlook the fact that proper fuses in the filament circuit will save burning out tubes through carelessness.

Don't forget that a hydrometer to test the battery ought to be an important item of your outfit.

Don't allow your storage batteries to become completely discharged.

Don't expect good reception if your batteries are run down.

Don't forget to see that your battery terminal connections are correctly hooked up.

Don't try to tune by guesses.

Don't blame poor reception on static—it may be your own fault.

Don't expect a short-wave set to work as efficiently when loading coils are used for very long wavelengths.

Don't load-up your primary without increasing the wavelength of the secondary.

Don't play with the controls after tuning has been completed.

Don't forget that secondary circuit requires as careful tuning as the primary.

**Don't expect to tune a regenerative set the first time you try it.**

**Don't forget that radio frequency amplification will improve long-distance reception.**





## **APPENDIX**



## APPENDIX I

### RADIO FORMULÆ

The Radio novice has much to learn before he can thoroughly understand the theory and operation of Radio telephony. It is to his advantage to study the operation of his set and to understand just how each piece of apparatus can be used to the best advantage. To do this the proper instrument must be used in each place in the circuit. This means that the capacity, inductance, resistance or any other characteristics must be calculated and located in the right place in the circuit. The following general formulæ are given and where necessary an explanation is added. No explanation of the derivation is given.

Ohms law is given, but one must remember that it does not apply to alternating current.

$$\text{Amperes} = \frac{\text{Volts}}{\text{Ohms}} \quad (1)$$

$$\text{Watts} = \text{Volts} \times \text{Amperes} \quad (2)$$

$$\text{Frequency} = \frac{300,000,000 \text{ meters}}{\text{wavelength}} \quad (3)$$

$$\text{Wavelength} = 1885 \sqrt{C \times L} \quad (4)$$

where

C = capacity in microfarads

L = inductance in microhenries

Resistance in series

$$R = R_1 + R_2 + R_3 \quad (5)$$

Resistance in parallel

$$\frac{1}{R} = \frac{1}{R_1} + \frac{1}{R_2} + \frac{1}{R_3} \quad (6)$$

Capacity of a condenser in micro-microfarads

$$C = .0885 \frac{KS}{t} \quad (7)$$

where

t = thickness of dielectric

S = Surface area in square centimeters

K = dielectric constant

Capacity of condensers in parallel

$$C = C_1 + C_2 + C_3 \quad (8)$$

## Capacity of condensers in series

$$C = \frac{I}{\frac{I}{C_1} + \frac{I}{C_2} + \frac{I}{C_3}} \quad (9)$$

## Voltages in a transformer

$$\frac{E_p}{E_s} = \frac{T_p}{T_s} \quad (10)$$

where

- $E_p$  = voltage in primary
- $E_s$  = voltage in secondary
- $T_p$  = turns in primary
- $T_s$  = turns in secondary

## ANTENNA FORMULÆ

## Watt energy radiated in transmitting

$$WE = \frac{1578 H^2 I^2}{W\lambda^3} \quad (11)$$

where

- $H$  = Height of aerial in meters
- $I$  = Current at base of aerial in amperes
- $\lambda$  = Wavelength of aerial in meters

## Capacitance on antenna in microfarads

$$C = \frac{\lambda^2 - \lambda c^2 \times C'}{\lambda c^2} \quad (12)$$

where

$\lambda$  = natural wavelength of aerial in meters

$\lambda c$  = wavelength with condenser in series

$C'$  = capacity of condenser in series with aerial

## Inductance of an aerial in centimeters

$$L = \frac{\lambda^2}{\lambda i^2 - \lambda^2} \times L' \quad (13)$$

where

$\lambda$  = natural wavelength of aerial in meters

$\lambda i$  = wavelength with inductance in series

$L'$  = Inductance of coil in series with aerial

## COIL FORMULÆ

The amateur occasionally finds that the natural wavelength of his aerial is too high for broadcasting. To reduce the natural wavelength of the antenna a condenser is connected in series in the antenna circuit.

The following formula gives the approximate capacity in microfarads required to reduce the wavelength of the aerial to the desired meters:

$$C = \frac{\lambda^2 \times Ca}{3552 LaCa - \lambda^2} \quad (14)$$

where

$\lambda$  = desired wavelength in meters

$La$  = inductance of the aerial in centimeters

$Ca$  = Capacity of the aerial in microfarads

The inductance of the primary coil in an antenna circuit for a desired wavelength is calculated from the following formula:

$$L = \frac{\lambda^2}{3552 Ca} - \frac{La}{3} \quad (15)$$

where

$\lambda$  = desired wavelength in meters

$Ca$  = capacity of the aerial in microfarads

$La$  = inductance of the aerial in centimeters

If the circuit is to be used for longer wavelengths than that of the antenna with the primary coil, loading coils are inserted in series. The following formula gives the required inductance in centimeters of the loading coils:

$$L = \frac{\lambda^2}{3552 Ca} - \left( \frac{La}{3} + Lp \right) \quad (16)$$

where

$\lambda$  = desired wavelength in meters

$C_a$  = capacity of the antenna in microfarads

$L_a$  = inductance of the antenna in centimeters

$L_p$  = inductance of the primary coil in centimeters

The inductance in centimeters of the secondary coil is calculated as follows:

$$L = \frac{\lambda^2}{3552 C} \quad (17)$$

where

$\lambda$  = desired wavelength in meters

$C$  = capacity of the condenser shunted across secondary coil

The inductance in centimeters of any single layer coil where the details of the winding are given can be figured from the formula:

$$L = \frac{39.47 K r^2 n^2}{l} \quad (18)$$

where

$r$  = radius of coil in centimeters

$n$  = number of turns

$l$  = equivalent length of winding in centimeters

$K$  = variable factor depending on the value of  $\frac{2r}{l}$



## WAVELENGTH FORMULÆ

$$\lambda = 1885 \sqrt{C \times L}$$

with Inductance in series

$$\lambda = 1885 \sqrt{C \times (L_c + L_a)}$$

with Capacity in series

$$\lambda = 1885 \sqrt{L \times \left( \frac{1}{\frac{1}{C_a} \times \frac{1}{C_c}} \right)}$$

with Inductance and Capacity in series

$$\lambda = 1885 \sqrt{(L_c + L_a) \times \left( \frac{1}{\frac{1}{C_a} + \frac{1}{C_c}} \right)}$$

## TABLE II

## DIELECTRIC CONSTANTS

|                     |       |
|---------------------|-------|
| Air.....            | 1.00  |
| Compressed Air..... | 1.004 |
| Manila Paper.....   | 1.50  |
| Paraffine.....      | 2.00  |
| Ebonite.....        | 2.10  |
| India Rubber.....   | 2.30  |
| Hard Rubber.....    | 2.50  |
| Shellac.....        | 2.80  |
| Common Glass.....   | 3.50  |
| Mica.....           | 6.00  |
| Flint Glass.....    | 7.00  |
| Plate Glass.....    | 8.00  |

**TABLE III**  
**HONEYCOMB COIL**  
 Wavelength range

| Meters         | Primary Coil |      |                | Secondary Coil |      |                | Tickler Coil |      |              |
|----------------|--------------|------|----------------|----------------|------|----------------|--------------|------|--------------|
|                | a            | b    | c              | a              | b    | c              | a            | b    | c            |
| 150 to 350     | 35           | .075 | 185 to 515     | 25             | .14  | 130 to 375     | 35           | .075 | 180 to 515   |
| 300 to 700     | 75           | .03  | 330 to 1,030   | 50             | .15  | 240 to 730     | 35           | .075 | 180 to 515   |
| 600 to 1,650   | 150          | 1.3  | 660 to 2,200   | 100            | .6   | 450 to 1,460   | 75           | .3   | 330 to 1,030 |
| 850 to 1,950   | 200          | 2.3  | 930 to 2,850   | 150            | 1.3  | 660 to 2,200   | 100          | .6   | 450 to 1,460 |
| 1,400 to 2,850 | 300          | 6.5  | 1,550 to 4,800 | 250            | 4.5  | 1,300 to 4,000 | 150          | 1.3  | 660 to 2,200 |
| 2,550 to 4,250 | 400          | 11.0 | 2,050 to 6,300 | 300            | 6.5  | 1,550 to 4,800 | 150          | 1.3  | 660 to 2,200 |
| 4,200 to 6,300 | 500          | 20.0 | 3,000 to 8,500 | 400            | 11.0 | 2,050 to 6,300 | 200          | 2.3  | 930 to 2,850 |

.001 Mfd. Variable Condenser in Shunt.

a—Number of Turns.

b—Inductance in Microhenries.

c—Wavelength of Coils.

Table shows the length and turns for different coils, all wound with No. 28 single silk covered wire. The inductance values will be accurate within 5 per cent.:

TABLE IV

## COILS 3 INS. IN DIAMETER

| L = cms.        | Total No.<br>of Turns | Length of<br>Coil in Ins. |
|-----------------|-----------------------|---------------------------|
| 50,000 .....    | 18                    | 0.28                      |
| 100,000 .....   | 27                    | 0.42                      |
| 200,000 .....   | 42                    | 0.64                      |
| 300,000 .....   | 53                    | 0.82                      |
| 400,000 .....   | 64                    | 0.98                      |
| 500,000 .....   | 73                    | 1.13                      |
| 600,000 .....   | 83                    | 1.27                      |
| 700,000 .....   | 92                    | 1.42                      |
| 800,000 .....   | 101                   | 1.55                      |
| 900,000 .....   | 110                   | 1.70                      |
| 1,000,000 ..... | 119                   | 1.83                      |

## COILS 5 INS. IN DIAMETER

|                 |     |      |
|-----------------|-----|------|
| 500,000 .....   | 47  | 0.73 |
| 1,000,000 ..... | 72  | 1.10 |
| 1,500,000 ..... | 94  | 1.44 |
| 2,000,000 ..... | 113 | 1.74 |
| 2,500,000 ..... | 120 | 2.00 |
| 3,000,000 ..... | 147 | 2.26 |
| 3,500,000 ..... | 164 | 2.52 |
| 4,000,000 ..... | 180 | 2.76 |
| 4,500,000 ..... | 195 | 3.00 |
| 5,000,000 ..... | 210 | 3.24 |

## APPENDIX II

### CALCULATION OF TUNING APPARATUS

#### *Term Definitions*

- 1,000 centimeters equal one microhenry.
- 1,000 microhenries equal one millihenry.
- 1,000 millihenries equal one henry.
- 1,000,000 centimeters equal one millihenry
- 1,000,000 microhenries equal one henry.
- 1,000,000,000 centimeters equal one henry.
- 1,000,000 micro-microfarads equal one microfarad.
- 1,000,000 microfarads equal one farad.
- 1,000,000,000 microfarads equal one farad.

Let us start out with the assumption that the antenna, lead-in and ground are already installed, and as is often the case, the installation is restricted to little or no variation. The dimensions then, of the receiving tuning unit for a definite range of wavelengths are items of the utmost importance. At this point one important fact must be considered—you cannot get the same efficiency out of a long range set that you can out of a short one. By that is meant a set designed for a limited range of from

150 to 600 meters will have much better efficiency than one designed for 150 to 3,000 meters or more. Adding too many turns on the primary and secondary coils and then cutting out these turns for the shorter waves is an error continually made by most amateurs and novices. These unused turns of the tuning unit introduce what is called "end turn losses" which distinctly decrease the efficiency. It might be compared to a water supply system in which there are a number of pipelines running out from the main line, but ending in a cap, where the water collects, becomes stagnant and pollutes the main supply.

As an example let us start out with the following:—The antenna is of the inverted "L" type, the flat top being 100 feet long, 60 feet high and composed of a single wire. Let us assume the length of the ground wire, from the ground clamp to the set plus the length of the lead-in from the aerial to the set, is equal to the height of the aerial, 60 feet. It would probably be slightly more if the wires are led around and in through the rooms to the set. Then the total length of the aerial, lead-in and ground wire is 160 feet. To convert this to meters we multiply by 0.3048. This gives us a total length of 48.768 meters. To convert this to the fundamental wavelength, we multiply by 4.2, making the antenna wavelength about 200 meters.

Most broadcasting is sent out on a wavelength of 360 meters. The required inductance of the

coil "L" in Figure III to raise the wavelength of the primary circuit to 360 meters must be calculated.

In addition the secondary circuit must be designed so the induction of the secondary coil "1"

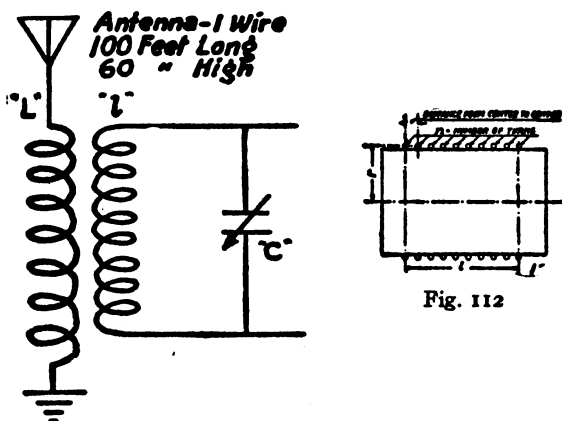

Fig. III

and the capacity of the condenser "C" will give an equivalent wavelength of 360 meters.

#### PRIMARY INDUCTANCE

In Tables V, VI, VII and VIII will be found the inductance and capacity of aerials for various lengths and heights. Table No. VII applies to the inverted "L" type, single wire. The inductance of the aerial in this problem then is 62,100 centimeters and the capacity .0002 microfarads.

The wavelength can also be calculated from the formula:

$$\lambda = 1885 \sqrt{C \times L}$$

where

C = capacity in microfarads

L = inductance in microhenries

$$\lambda = 1885 \sqrt{.0002 \times 62}$$

$$\lambda = 207 \text{ meters}$$

In order to find the required inductance of the coil "L" the following formula is used:

$$L_i = \frac{\lambda^2}{3552 C_c} - \frac{L_a}{3}$$

where

$L_i$  = inductance of the coil "L" in centimeters

W = desired wavelength

$C_c$  = capacity of the antenna in microfarads

$L_a$  = inductance of the antenna in centimeters

Substitute the formula values in order to increase the wavelength of the set to the usual broadcasting range of 360 meters:

$$L_i = \frac{360 \times 360}{3552 \times .0002} - \frac{62,100}{3} = 182,300 - 20,700$$

$$L_i = 161,600 \text{ centimeters}$$

but 1,000 centimeters equal one microhenry, therefore the inductance of the coil "L" should be 162 microhenries.

#### SECONDARY INDUCTANCE

Having found the required inductance of the coil "L" in the primary circuit attention can be



turned to the secondary circuit and find the inductance of the coil "1". The capacity of the condenser "C" need not be very great, in fact it could be dispensed with, but at the same time it has a distinct advantage in tuning, especially in eliminating interference. For a wavelength range up to 600 meters a capacity of .0005 microfarads or less is sufficient.

$$li = \frac{\lambda^2}{3552 Cc}$$

where

$\lambda$  = desired wavelength as before

Cc = capacity of the condenser "C" in microfarads

li = inductance of the secondary coil "1" in centimeters

Substitute the value in the formula:

$$li = \frac{360 \times 360}{3552 \times .0005} = 72,972 \text{ centimeters or} \\ = 73 \text{ microhenries}$$

The dimensions of the primary and secondary coils are 162 and 73 microhenries respectively. These values are for a wavelength of 360 meters. The amateur, however, may desire to increase the range of his set for tuning in wavelengths above these, so sets are usually made with a wavelength range running to 600 meters or more. In this case the maximum wavelength desired is substituted in the calculations instead of 360 meters.

Of course, as the range is increased, there is a corresponding loss in efficiency in the lower wavelengths. For this reason it is advisable to design the set for short wavelengths and have another set of coils for the longer wavelengths. Or, as is often done, loading coils can be added to the primary or antenna circuit, increasing the wavelength of the set. When this is done, the actual inductance of the coil required for increasing the range to any desired wavelength can be calculated by use of the formula as used in the first part of the problem.

#### LOADING COIL

Taking for example in the problem given an antenna wavelength of 200 meters. This is increased to 360 meters by adding the coil "L" of 162 microhenries inductance. To increase the wavelength to 600 meters by adding a loading coil in the antenna circuit, use the following formula:

$$L'i = \frac{\lambda^2}{3552 Cc} - \left( \frac{La}{3} + Li \right)$$

where

$L'i$  = required inductance of the loading coil in centimeters

$\lambda$  = wavelength required

$Cc$  = capacity of the antenna in microfarads

$La$  = inductance of the antenna in centimeters

$Li$  = inductance of the primary coil in centimeters

substituting the proper values:

$$L'i = \frac{600 \times 600}{3552 \times .0002} - \left( \frac{62,100}{3} + 70,516 \right)$$

$$L'i = 506,700 - (20,700 + 161,600) = 324,000 \text{ centimeters.}$$

The inductance of the loading coil should be 324 microhenries.

Honeycomb coils are often used as loading coils, because they can be purchased in various sizes and inductances. Table III shows the number of turns, inductance and wavelength of honeycomb coils. This table will be convenient in getting the proper coil for either the primary, secondary or for loading.

#### INDUCTANCE FORMULA

The formula for computing the inductance of any coil is as follows:

$$L = \frac{39.47K r^2 n^2}{l}$$

where

L = inductance of the coil in centimeters

r = radius of coil in centimeters

n = number of turns

l = equivalent length of coil in centimeters

K = a variable factor depending on the value of  $\frac{2r}{l}$

l = the equivalent length in centimeters = the distance in inches from center to center of wire when wound,  $\times 2.54$

In Figure 112 the dimensions  $r$ ,  $l$ , and  $n$  are indicated. If, for example, the windings are of enameled copper wire, then "1" equals the diameter of the wire in inches  $\times$  the number of turns  $\times$  2.54 (to change it to centimeters). If covered wire is used, the covering must be taken in consideration. Table X gives the number of turns per inch of copper wire with various insulations.

The value of the factor  $K$  for the various values of the fraction  $\frac{2r}{l}$  is given in Table IX.

In using the formula, the radius "r" of the coil is assumed, in the same manner the gauge of the wire with covering and the number of turns are approximated and the values substituted in the formula. The value of the inductance is figured out. The inductance value should check up close enough with the desired value. It may be necessary to go over this two or three times before the correct values are found. The diameter and gauge are usually decided on, and the number of turns can be altered until the inductance value is satisfactory. The inductance usually is left slightly greater as it is well to have a few extra turns in order to allow a slight range in tuning.

#### PRIMARY COIL

The required inductance of the primary coil is 161,600 centimeters. The diameter of the coil can be assumed as 4", that is to say, the wires will be wound on a tube 4" in diameter. The value of

“r” will be 2 inches. The primary winding will be of No. 24 B & S Gauge double cotton-covered copper wire.

No. 24 double cotton-covered wire has 34 turns per inch. About 34 turns for the primary ought to be sufficient.

$$\frac{34}{34} \times 2.54 = 2.54 \text{ centimeters-length of winding}$$

$$\text{therefore } l = 2.54 \text{ cms.}$$

$$r = 2 \text{ inches} \times 2.54 = 5.08 \text{ cms.}$$

$$\frac{2r}{l} = \frac{10.16}{2.54} = 4$$

therefore from Table IX—

$$K = .36$$

Substituting in the formula

$$L = \frac{39.47 \times .36 \times (5.08)^2 \times (34)^2}{2.54}$$

$$L = 167,000 \text{ centimeters}$$

This is slightly more than necessary but allows a turn or two extra. For tuning purposes, taps can be taken off at every fourth turn.

#### SECONDARY COIL

In deciding on the details of the secondary coil, it is necessary to consider the type of coupling that is to be used. Will it be a fixed coupling, loose coupler, or variocoupler? In the fixed coupling where the coils are rigidly mounted the secondary would probably be mounted on the same tube as

the primary. In a loose coupler the secondary must be wound on a tube small enough so it will slide inside the primary tube, preferably with a minimum amount of clearance. The variocoupler necessitates a secondary tube that will rotate inside of the primary, again with the minimum amount of clearance.

The loose coupler has become rather popular, therefore it appears that this type of coupling will be the most logical to use in the problem. The coupling will have no effect on the calculations, but must be considered when the diameter of the secondary coil is decided on. Figuring that the primary tube has a wall thickness of one-eighth of an inch and allowing the same amount for wire thickness and clearance, then the secondary tube should be  $3\frac{1}{2}$  inches in diameter and "r" equals  $1.75 \times 2.54$ , therefore  $r = 4.445$  cms.

In the secondary winding the gauge of the wire should be 26 B & S double cotton covered copper wire. From Table X it will be found that this wire will permit 41 turns per inch. The number of turns in the secondary winding should be about 22.

$$n = 22$$

therefore

$$I = \frac{22}{41} \times 2.54 = 1.36 \text{ cms.}$$

$$\frac{2r}{I} = \frac{88.9}{1.36} = 6.54$$

then from Table IX

$$K = .27$$

Substitute these values in the formula for solution

$$L = \frac{39.47 \times .27 \times (4.445)^2 \times (22)^2}{1.36}$$

$$L = 74,964 \text{ centimeters.}$$

This value is a little greater than the required 73 microhenries, but this will allow an extra turn for tuning.

#### LOADING COIL

In order to raise the wavelength of the primary circuit to 600 meters, it was found necessary to insert an inductance of 324,000 centimeters. The coil can be taken care of by using a honeycomb coil, as explained before, but for the benefit of the amateurs that would like to wind their own loading coil, this inductance will be analyzed also.

The single layer coil wound on a tube will give better results and serve the purpose better than the bank-wound type. The diameter of the tube need not be very large, and for that reason in the problem a diameter of 3 inches will be assumed.

The wire gauge should be about 28 B & S double cotton covered copper wire. From Table X this gauge will give 47 turns per inch.

$$r = 1.5 \times 2.54 = 3.81 \text{ centimeters}$$

About 62 turns of wire should give the approximate result. Then

$$r = \frac{62}{47} \times 2.54 = 3.35 \text{ cms.}$$

$$\frac{2r}{l} = \frac{7.62}{3.35} = 2.27$$

therefore, from Table VII

$$K = .5$$

substituting the values in the formula

$$L = \frac{39.47 \times .5 \times (3.81)^2 \times (62)^2}{3.35}$$

$$L = 338,000 \text{ centimeters.}$$

This value is slightly greater than that required, but the surplus can be taken care of by means of the tapped switch on the primary coil and the variable condenser. The fact should not be overlooked, that in using the variable condensers in either circuit the capacity is changed; therefore the condenser also gives distinct control in tuning to the proper wavelength.

The above values as worked out will be found to be accurate enough for the amateur in determining the best units to purchase or make in assembling his receiving set.

Tables VI and VIII give the values for the "T" type of aerial, Tables V and VII give the values for the inverted "L" type of antenna.



TABLE V

| Height<br>in<br>Feet | HORIZONTAL LENGTH    |                       |                      |                       |                      |                       |                      |                       |                      |                       |                      |                       |                      |                       |                      |                       |
|----------------------|----------------------|-----------------------|----------------------|-----------------------|----------------------|-----------------------|----------------------|-----------------------|----------------------|-----------------------|----------------------|-----------------------|----------------------|-----------------------|----------------------|-----------------------|
|                      | 40                   |                       | 60                   |                       | 80                   |                       | 100                  |                       | 120                  |                       | 140                  |                       | 160                  |                       | 180                  |                       |
|                      | Capacity<br>in Mfds. | Inductance<br>in Cms. | Capacity<br>in Mfds. | Inductance<br>in Cms. | Capacity<br>in Mfds. | Inductance<br>in Cms. | Capacity<br>in Mfds. | Inductance<br>in Cms. | Capacity<br>in Mfds. | Inductance<br>in Cms. | Capacity<br>in Mfds. | Inductance<br>in Cms. | Capacity<br>in Mfds. | Inductance<br>in Cms. | Capacity<br>in Mfds. | Inductance<br>in Cms. |
| 30                   | .00019               | 22400                 | .00025               | 28200                 | .00033               | 34000                 | .00039               | 39800                 | .00046               | 45600                 | .00052               | 51400                 | .00058               | 57200                 | .00064               | 63000                 |
| 40                   | .00019               | 26900                 | .00026               | 35000                 | .00033               | 41100                 | .00039               | 47200                 | .00046               | 53300                 | .00052               | 59400                 | .00058               | 65500                 | .00064               | 71600                 |
| 50                   | .00020               | 35500                 | .00027               | 41000                 | .00034               | 48300                 | .00040               | 54600                 | .00046               | 61000                 | .00052               | 67400                 | .00058               | 73700                 | .00064               | 80100                 |
| 60                   | .00021               | 42200                 | .00028               | 48800                 | .00034               | 55500                 | .00040               | 62100                 | .00046               | 68700                 | .00052               | 75300                 | .00058               | 81900                 | .00064               | 88500                 |
| 70                   | .00023               | 48800                 | .00029               | 55600                 | .00035               | 62400                 | .00041               | 69200                 | .00047               | 75000                 | .00053               | 81800                 | .00059               | 88600                 | .00065               | 96400                 |
| 80                   | .00024               | 55400                 | .00030               | 62400                 | .00036               | 69300                 | .00042               | 76300                 | .00048               | 83300                 | .00054               | 90300                 | .00060               | 97300                 | .00066               | 104200                |
| 90                   | .00026               | 62200                 | .00031               | 69300                 | .00037               | 76400                 | .00043               | 83500                 | .00049               | 90600                 | .00055               | 97700                 | .00061               | 104800                | .00067               | 111900                |
| 100                  | .00027               | 69000                 | .00032               | 76300                 | .00038               | 83500                 | .00044               | 90700                 | .00050               | 98000                 | .00056               | 105200                | .00062               | 112400                | .00068               | 119600                |

FOR INVERTED "L" TYPE AERIAL. 4 STRANDS

TABLE VI

| Height<br>in<br>Feet | HORIZONTAL LENGTH    |                       |                      |                       |                      |                       |                      |                       |                      |                       |                      |                       |                      |                       |                      |                       |
|----------------------|----------------------|-----------------------|----------------------|-----------------------|----------------------|-----------------------|----------------------|-----------------------|----------------------|-----------------------|----------------------|-----------------------|----------------------|-----------------------|----------------------|-----------------------|
|                      | 40                   |                       | 60                   |                       | 80                   |                       | 100                  |                       | 120                  |                       | 140                  |                       | 160                  |                       | 180                  |                       |
|                      | Capacity<br>in Mfds. | Inductance<br>in Cms. | Capacity<br>in Mfds. | Inductance<br>in Cms. | Capacity<br>in Mfds. | Inductance<br>in Cms. | Capacity<br>in Mfds. | Inductance<br>in Cms. | Capacity<br>in Mfds. | Inductance<br>in Cms. | Capacity<br>in Mfds. | Inductance<br>in Cms. | Capacity<br>in Mfds. | Inductance<br>in Cms. | Capacity<br>in Mfds. | Inductance<br>in Cms. |
| 30                   | .00019               | 13500                 | .00025               | 18000                 | .00033               | 16500                 | .00039               | 18000                 | .00046               | 19500                 | .00052               | 21000                 | .00058               | 22400                 | .00064               | 23000                 |
| 40                   | .00019               | 19400                 | .00026               | 21000                 | .00033               | 22600                 | .00039               | 24200                 | .00046               | 25700                 | .00052               | 27300                 | .00058               | 28900                 | .00064               | 30500                 |
| 50                   | .00020               | 25700                 | .00027               | 27400                 | .00034               | 29000                 | .00040               | 30600                 | .00046               | 32200                 | .00052               | 33900                 | .00058               | 35500                 | .00064               | 37200                 |
| 60                   | .00021               | 32100                 | .00028               | 33800                 | .00034               | 35500                 | .00040               | 37100                 | .00046               | 38800                 | .00052               | 40500                 | .00058               | 42200                 | .00064               | 43900                 |
| 70                   | .00023               | 38400                 | .00029               | 40100                 | .00035               | 41900                 | .00041               | 43500                 | .00047               | 45400                 | .00053               | 47000                 | .00059               | 48800                 | .00065               | 50500                 |
| 80                   | .00024               | 44700                 | .00030               | 46500                 | .00036               | 48300                 | .00042               | 49900                 | .00048               | 51900                 | .00054               | 53600                 | .00060               | 55400                 | .00066               | 57200                 |
| 90                   | .00026               | 51400                 | .00031               | 53200                 | .00037               | 55000                 | .00043               | 56600                 | .00049               | 58600                 | .00055               | 60400                 | .00061               | 62200                 | .00067               | 64000                 |
| 100                  | .00027               | 58100                 | .00032               | 59900                 | .00038               | 61700                 | .00044               | 63400                 | .00050               | 65300                 | .00056               | 67200                 | .00062               | 69000                 | .00068               | 70800                 |

FOR "T" TYPE AERIAL, 4 STRANDS

TABLE VII

| Height<br>in<br>Feet | HORIZONTAL LENGTH    |                       |                      |                       |                      |                       |                      |                       |                      |                       |                      |                       |                      |                       |                      |                       |
|----------------------|----------------------|-----------------------|----------------------|-----------------------|----------------------|-----------------------|----------------------|-----------------------|----------------------|-----------------------|----------------------|-----------------------|----------------------|-----------------------|----------------------|-----------------------|
|                      | 40                   |                       | 60                   |                       | 80                   |                       | 100                  |                       | 120                  |                       | 140                  |                       | 160                  |                       | 180                  |                       |
|                      | Capacity<br>in Mfds. | Inductance<br>in Cms. | Capacity<br>in Mfds. | Inductance<br>in Cms. | Capacity<br>in Mfds. | Inductance<br>in Cms. | Capacity<br>in Mfds. | Inductance<br>in Cms. | Capacity<br>in Mfds. | Inductance<br>in Cms. | Capacity<br>in Mfds. | Inductance<br>in Cms. | Capacity<br>in Mfds. | Inductance<br>in Cms. | Capacity<br>in Mfds. | Inductance<br>in Cms. |
| 30                   | .00009               | 22400                 | .00012               | 28200                 | .00016               | 34000                 | .00019               | 39800                 | .00023               | 45600                 | .00025               | 51400                 | .00029               | 57200                 | .00032               | 63000                 |
| 40                   | .00010               | 28900                 | .00013               | 35000                 | .00016               | 41100                 | .00019               | 47200                 | .00023               | 53300                 | .00026               | 59400                 | .00029               | 65500                 | .00032               | 71600                 |
| 50                   | .00010               | 35500                 | .00013               | 41900                 | .00017               | 48300                 | .00020               | 54600                 | .00023               | 61000                 | .00026               | 67400                 | .00029               | 73700                 | .00032               | 80100                 |
| 60                   | .00011               | 42200                 | .00014               | 48800                 | .00017               | 55500                 | .00020               | 62100                 | .00024               | 68700                 | .00027               | 75300                 | .00029               | 81900                 | .00033               | 88500                 |
| 70                   | .00011               | 48800                 | .00014               | 55600                 | .00018               | 62400                 | .00021               | 69200                 | .00024               | 75000                 | .00027               | 82800                 | .00030               | 89600                 | .00033               | 96400                 |
| 80                   | .00012               | 55400                 | .00015               | 62400                 | .00018               | 69300                 | .00021               | 76300                 | .00024               | 83300                 | .00027               | 90300                 | .00030               | 97300                 | .00033               | 104200                |
| 90                   | .00012               | 62200                 | .00015               | 69300                 | .00019               | 76400                 | .00022               | 83500                 | .00025               | 90600                 | .00028               | 97700                 | .00031               | 104800                | .00034               | 111900                |
| 100                  | .00013               | 69000                 | .00016               | 76300                 | .00019               | 83500                 | .00022               | 90700                 | .00025               | 98000                 | .00028               | 105200                | .00032               | 112400                | .00034               | 119600                |

FOR INVERTED "L" TYPE AERIAL—SINGLE WIRE

TABLE VIII

| Height<br>in<br>Feet | HORIZONTAL LENGTH    |                       |                      |                       |                      |                       |                      |                       |                      |                       |                      |                       |                      |                       |                      |                       |
|----------------------|----------------------|-----------------------|----------------------|-----------------------|----------------------|-----------------------|----------------------|-----------------------|----------------------|-----------------------|----------------------|-----------------------|----------------------|-----------------------|----------------------|-----------------------|
|                      | 40                   |                       | 60                   |                       | 80                   |                       | 100                  |                       | 120                  |                       | 140                  |                       | 160                  |                       | 180                  |                       |
|                      | Capacity<br>in Mfds. | Inductance<br>in Cms. | Capacity<br>in Mfds. | Inductance<br>in Cms. | Capacity<br>in Mfds. | Inductance<br>in Cms. | Capacity<br>in Mfds. | Inductance<br>in Cms. | Capacity<br>in Mfds. | Inductance<br>in Cms. | Capacity<br>in Mfds. | Inductance<br>in Cms. | Capacity<br>in Mfds. | Inductance<br>in Cms. | Capacity<br>in Mfds. | Inductance<br>in Cms. |
| 30                   | .00009               | 13500                 | .00013               | 13000                 | .00016               | 16500                 | .00019               | 18000                 | .00023               | 19500                 | .00025               | 21000                 | .00028               | 22400                 | .00031               | 23900                 |
| 40                   | .00009               | 19400                 | .00013               | 21000                 | .00017               | 22600                 | .00019               | 24200                 | .00023               | 25700                 | .00026               | 27300                 | .00029               | 28600                 | .00032               | 30500                 |
| 50                   | .00010               | 25700                 | .00014               | 27400                 | .00017               | 29000                 | .00020               | 30600                 | .00023               | 32200                 | .00026               | 33900                 | .00029               | 35500                 | .00032               | 37200                 |
| 60                   | .00011               | 32100                 | .00014               | 33800                 | .00018               | 35500                 | .00020               | 37100                 | .00024               | 38800                 | .00026               | 40500                 | .00029               | 42200                 | .00033               | 43900                 |
| 70                   | .00011               | 38400                 | .00015               | 40100                 | .00018               | 41900                 | .00021               | 43500                 | .00024               | 45400                 | .00027               | 47000                 | .00030               | 48800                 | .00033               | 50500                 |
| 80                   | .00012               | 44700                 | .00015               | 46500                 | .00019               | 48300                 | .00021               | 49900                 | .00024               | 51900                 | .00027               | 53600                 | .00030               | 55400                 | .00034               | 57200                 |
| 90                   | .00013               | 51400                 | .00016               | 53200                 | .00019               | 55000                 | .00022               | 56600                 | .00025               | 58600                 | .00028               | 60400                 | .00030               | 62200                 | .00034               | 64000                 |
| 100                  | .00014               | 58100                 | .00016               | 59900                 | .00020               | 61700                 | .00022               | 63400                 | .00025               | 65300                 | .00028               | 67200                 | .00031               | 69000                 | .00034               | 70800                 |

FOR "T" TYPE AERIAL—SINGLE WIRE

TABLE IX  
CORRECTION FACTOR—K

| $\frac{2r}{I}$ | K        | $\frac{2r}{I}$ | K        | $\frac{2r}{I}$ | K        | $\frac{2r}{I}$ | K        |
|----------------|----------|----------------|----------|----------------|----------|----------------|----------|
| 0.00           | 1.000000 | 0.40           | 0.849853 | 0.80           | 0.735079 | 2.00           | 0.525510 |
| 0.01           | 0.995769 | 0.41           | 0.846583 | 0.81           | 0.732593 | 2.10           | 0.513701 |
| 0.02           | 0.991562 | 0.42           | 0.843335 | 0.82           | 0.730126 | 2.20           | 0.502472 |
| 0.03           | 0.987381 | 0.43           | 0.840110 | 0.83           | 0.727675 | 2.30           | 0.491782 |
| 0.04           | 0.983224 | 0.44           | 0.836906 | 0.84           | 0.725240 | 2.40           | 0.481591 |
| 0.05           | 0.979092 | 0.45           | 0.833723 | 0.85           | 0.722821 | 2.50           | 0.471865 |
| 0.06           | 0.974985 | 0.46           | 0.830563 | 0.86           | 0.720419 | 2.60           | 0.462573 |
| 0.07           | 0.970903 | 0.47           | 0.827424 | 0.87           | 0.718033 | 2.70           | 0.453686 |
| 0.08           | 0.966847 | 0.48           | 0.824307 | 0.88           | 0.715663 | 2.80           | 0.445177 |
| 0.09           | 0.962815 | 0.49           | 0.821211 | 0.89           | 0.713308 | 2.90           | 0.437023 |
| 0.10           | 0.958807 | 0.50           | 0.818136 | 0.90           | 0.710969 | 3.00           | 0.429199 |
| 0.11           | 0.954825 | 0.51           | 0.815082 | 0.91           | 0.708647 | 3.10           | 0.421687 |
| 0.12           | 0.950868 | 0.52           | 0.812049 | 0.92           | 0.706339 | 3.20           | 0.414468 |
| 0.13           | 0.946935 | 0.53           | 0.809037 | 0.93           | 0.704047 | 3.30           | 0.407524 |
| 0.14           | 0.943025 | 0.54           | 0.806046 | 0.94           | 0.701770 | 3.40           | 0.400840 |
| 0.15           | 0.939141 | 0.55           | 0.803075 | 0.95           | 0.699509 | 3.50           | 0.394401 |
| 0.16           | 0.935284 | 0.56           | 0.800125 | 0.96           | 0.697262 | 3.60           | 0.388192 |
| 0.17           | 0.931450 | 0.57           | 0.797195 | 0.97           | 0.695030 | 3.70           | 0.382203 |
| 0.18           | 0.927639 | 0.58           | 0.794285 | 0.98           | 0.692813 | 3.80           | 0.376421 |
| 0.19           | 0.923854 | 0.59           | 0.791395 | 0.99           | 0.690611 | 3.90           | 0.370834 |
| 0.20           | 0.920093 | 0.60           | 0.788525 | 1.00           | 0.688423 | 4.00           | 0.365433 |
| 0.21           | 0.916356 | 0.61           | 0.785675 | 1.05           | 0.677697 | 4.10           | 0.360206 |
| 0.22           | 0.912643 | 0.62           | 0.782844 | 1.10           | 0.667315 | 4.20           | 0.355147 |
| 0.23           | 0.908954 | 0.63           | 0.780032 | 1.15           | 0.657263 | 4.30           | 0.350249 |
| 0.24           | 0.905290 | 0.64           | 0.777240 | 1.20           | 0.647527 | 4.40           | 0.345503 |
| 0.25           | 0.901649 | 0.65           | 0.774467 | 1.25           | 0.638094 | 4.50           | 0.340898 |
| 0.26           | 0.898033 | 0.66           | 0.771713 | 1.30           | 0.628951 | 4.60           | 0.336431 |
| 0.27           | 0.894440 | 0.67           | 0.768978 | 1.35           | 0.620086 | 4.70           | 0.332098 |
| 0.28           | 0.890871 | 0.68           | 0.766262 | 1.40           | 0.611487 | 4.80           | 0.327890 |
| 0.29           | 0.887325 | 0.69           | 0.763565 | 1.45           | 0.603144 | 4.90           | 0.323800 |
| 0.30           | 0.883803 | 0.70           | 0.760886 | 1.50           | 0.595045 | 5.00           | 0.319825 |
| 0.31           | 0.880305 | 0.71           | 0.758225 | 1.55           | 0.587182 | 5.50           | 0.301504 |
| 0.32           | 0.876829 | 0.72           | 0.755582 | 1.60           | 0.579543 | 6.00           | 0.285410 |
| 0.33           | 0.873377 | 0.73           | 0.752958 | 1.65           | 0.572119 | 6.50           | 0.271146 |
| 0.34           | 0.869948 | 0.74           | 0.750351 | 1.70           | 0.564903 | 7.00           | 0.258406 |
| 0.35           | 0.866542 | 0.75           | 0.747762 | 1.75           | 0.557885 | 7.50           | 0.246949 |
| 0.36           | 0.863158 | 0.76           | 0.745191 | 1.80           | 0.551057 | 8.00           | 0.236582 |
| 0.37           | 0.859799 | 0.77           | 0.742637 | 1.85           | 0.544413 | 8.50           | 0.227152 |
| 0.38           | 0.856461 | 0.78           | 0.740100 | 1.90           | 0.537945 | 9.00           | 0.218532 |
| 0.39           | 0.853146 | 0.79           | 0.737581 | 1.95           | 0.531647 | 9.50           | 0.210618 |

TABLE X

| Turns per Inch of Copper Wire with Various Insulations |        |               |               |             |             |               |             |
|--|--------|---------------|---------------|-------------|-------------|---------------|-------------|
| B. & S. Gauge  | Enamel | Single Cotton | Double Cotton | Single Silk | Double Silk | Cotton Enamel | Silk Enamel |
| 18   | 23     | 21            | 19            | 23          | 22          | 20            | 22          |
| 19   | 26     | 24            | 21            | 26          | 24          | 23            | 24          |
| 20   | 29     | 26            | 23            | 29          | 27          | 25            | 27          |
| 21   | 32     | 29            | 25            | 32          | 30          | 27            | 30          |
| 22   | 37     | 33            | 29            | 36          | 33          | 31            | 34          |
| 23   | 41     | 37            | 32            | 40          | 37          | 34            | 37          |
| 24   | 46     | 40            | 34            | 44          | 41          | 38            | 42          |
| 25   | 51     | 44            | 37            | 49          | 45          | 42            | 46          |
| 26   | 57     | 48            | 41            | 54          | 50          | 46            | 51          |
| 27   | 64     | 54            | 44            | 60          | 54          | 50            | 57          |
| 28   | 74     | 59            | 47            | 67          | 60          | 55            | 63          |
| 29   | 80     | 64            | 50            | 74          | 65          | 60            | 69          |
| 30   | 90     | 70            | 54            | 82          | 71          | 65            | 76          |
| 31   | 101    | 75            | 57            | 90          | 77          | 71            | 84          |
| 32   | 112    | 82            | 60            | 99          | 83          | 77            | 92          |
| 33   | 127    | 88            | 64            | 108         | 90          | 83            | 101         |
| 34   | 141    | 95            | 67            | 119         | 97          | 89            | 110         |
| 35   | 158    | 101           | 71            | 129         | 104         | 95            | 120         |
| 36   | 178    | 108           | 74            | 140         | 111         | 102           | 131         |

**TABLE XI**  
**WIRE DIAMETERS**  
**FOR VARIOUS INSULATIONS IN FRACTIONS OF AN INCH**

| Gauge<br>Number<br>(B. & S.) | Enameled | COTTON COVERED |        |                         | SILK COVERED |        |                         |
|------------------------------|----------|----------------|--------|-------------------------|--------------|--------|-------------------------|
|                              |          | Single         | Double | Single<br>and<br>Enamel | Single       | Double | Single<br>and<br>Enamel |
| 12                           | .0827    | .0858          | .0908  | .0878                   | .0828        | .0848  | .0848                   |
| 13                           | .0738    | .0765          | .0810  | .0785                   | .0740        | .0760  | .0760                   |
| 14                           | .0658    | .0686          | .0731  | .0705                   | .0661        | .0681  | .0680                   |
| 15                           | .0587    | .0616          | .0661  | .0633                   | .0591        | .0611  | .0608                   |
| 16                           | .0523    | .0553          | .0598  | .0569                   | .0528        | .0548  | .0544                   |
| 17                           | .0468    | .0498          | .0543  | .0513                   | .0473        | .0493  | .0488                   |
| 18                           | .0417    | .0448          | .0493  | .0462                   | .0423        | .0443  | .0437                   |
| 19                           | .0372    | .0399          | .0444  | .0413                   | .0374        | .0394  | .0388                   |
| 20                           | .0333    | .0365          | .0410  | .0378                   | .0340        | .0360  | .0353                   |
| 21                           | .0298    | .0325          | .0365  | .0338                   | .0305        | .0325  | .0318                   |
| 22                           | .0266    | .0294          | .0334  | .0306                   | .0274        | .0294  | .0286                   |
| 23                           | .0237    | .0266          | .0306  | .0277                   | .0246        | .0266  | .0257                   |
| 24                           | .0212    | .0241          | .0281  | .0252                   | .0221        | .0241  | .0232                   |
| 25                           | .01895   | .0219          | .0259  | .0229                   | .0199        | .0219  | .0209                   |
| 26                           | .0169    | .0199          | .0239  | .0209                   | .0179        | .0199  | .0189                   |
| 27                           | .01515   | .0182          | .0222  | .0192                   | .0162        | .0182  | .0172                   |
| 28                           | .01355   | .0166          | .0206  | .0175                   | .0146        | .0166  | .0155                   |
| 29                           | .01215   | .0153          | .0193  | .0162                   | .0133        | .0153  | .0142                   |
| 30                           | .01075   | .0140          | .0180  | .0148                   | .0120        | .0140  | .0128                   |
| 31                           | .00965   | .0129          | .0169  | .0137                   | .0109        | .0129  | .0117                   |
| 32                           | .00865   | .0120          | .0160  | .0127                   | .0100        | .0120  | .0107                   |
| 33                           | .00765   | .0111          | .0151  | .0117                   | .0091        | .0111  | .0097                   |
| 34                           | .00685   | .0103          | .0143  | .0109                   | .0083        | .0103  | .0089                   |
| 35                           | .00605   | .0096          | .0136  | .0101                   | .0076        | .0096  | .0081                   |
| 36                           | .00545   | .0090          | .0130  | .0095                   | .0070        | .0090  | .0075                   |
| 37                           | .0049    | .0085          | .0125  | .0089                   | .0065        | .0085  | .0069                   |
| 38                           | .0044    | .0080          | .0120  | .0084                   | .0060        | .0080  | .0064                   |
| 39                           | .0038    | .0075          | .0115  | .0078                   | .0055        | .0075  | .0058                   |
| 40                           | .0034    | .0071          | .0112  | .0074                   | .0051        | .0071  | .0054                   |

TABLE XII  
WAVE LENGTH VALUES

| Inductance<br>Milhenries | CAPACITY IN MICROFARADS |        |        |        |        |        |        |        |        |       |       |       |
|--------------------------|-------------------------|--------|--------|--------|--------|--------|--------|--------|--------|-------|-------|-------|
|                          | .00025                  | .00030 | .00040 | .00050 | .00060 | .00070 | .00080 | .00090 | .00100 |       |       |       |
| 0.02                     | 133                     | 146    | 169    | 188    | 206    | 223    | 238    | 253    | 267    | 283   | 298   | 310   |
| 0.025                    | 149                     | 163    | 188    | 211    | 231    | 249    | 267    | 283    | 298    | 310   | 326   | 346   |
| 0.03                     | 163                     | 179    | 206    | 231    | 253    | 273    | 292    | 310    | 326    | 346   | 377   | 400   |
| 0.04                     | 188                     | 206    | 238    | 267    | 292    | 315    | 337    | 358    | 377    | 400   | 421   | 446   |
| 0.05                     | 211                     | 231    | 267    | 298    | 326    | 353    | 377    | 400    | 421    | 446   | 462   | 486   |
| 0.06                     | 231                     | 253    | 292    | 326    | 358    | 386    | 413    | 438    | 462    | 486   | 506   | 533   |
| 0.07                     | 249                     | 273    | 315    | 353    | 386    | 417    | 446    | 473    | 499    | 525   | 556   | 596   |
| 0.08                     | 267                     | 292    | 337    | 377    | 413    | 446    | 477    | 506    | 533    | 565   | 596   | 633   |
| 0.09                     | 283                     | 310    | 358    | 400    | 438    | 473    | 506    | 536    | 565    | 596   | 633   | 670   |
| 0.10                     | 298                     | 326    | 377    | 421    | 462    | 499    | 533    | 565    | 596    | 633   | 670   | 705   |
| 0.12                     | 326                     | 358    | 413    | 462    | 506    | 546    | 584    | 619    | 653    | 689   | 725   | 760   |
| 0.14                     | 353                     | 386    | 446    | 499    | 546    | 590    | 631    | 674    | 715    | 754   | 793   | 832   |
| 0.16                     | 377                     | 413    | 477    | 533    | 584    | 631    | 674    | 715    | 754    | 793   | 832   | 871   |
| 0.18                     | 400                     | 438    | 506    | 565    | 619    | 669    | 715    | 754    | 793    | 832   | 871   | 910   |
| 0.20                     | 421                     | 462    | 533    | 596    | 653    | 705    | 754    | 793    | 832    | 871   | 910   | 949   |
| 0.25                     | 471                     | 516    | 596    | 666    | 730    | 789    | 843    | 894    | 942    | 997   | 1,032 | 1,066 |
| 0.30                     | 516                     | 566    | 653    | 730    | 800    | 864    | 923    | 979    | 1,032  | 1,066 | 1,100 | 1,134 |
| 0.40                     | 596                     | 653    | 754    | 843    | 923    | 997    | 1,066  | 1,131  | 1,192  | 1,253 | 1,314 | 1,375 |
| 0.50                     | 666                     | 730    | 843    | 942    | 1,032  | 1,115  | 1,192  | 1,264  | 1,333  | 1,400 | 1,460 | 1,520 |
| 0.60                     | 730                     | 800    | 923    | 1,032  | 1,131  | 1,221  | 1,306  | 1,385  | 1,460  | 1,539 | 1,618 | 1,697 |
| 0.70                     | 789                     | 864    | 997    | 1,115  | 1,221  | 1,320  | 1,410  | 1,496  | 1,577  | 1,656 | 1,735 | 1,814 |
| 0.80                     | 843                     | 923    | 1,066  | 1,192  | 1,306  | 1,410  | 1,509  | 1,599  | 1,688  | 1,777 | 1,866 | 1,955 |
| 0.90                     | 894                     | 979    | 1,131  | 1,264  | 1,385  | 1,496  | 1,599  | 1,697  | 1,788  | 1,877 | 1,966 | 2,055 |
| 1.00                     | 942                     | 1,032  | 1,192  | 1,333  | 1,460  | 1,577  | 1,688  | 1,788  | 1,885  | 1,985 | 2,085 | 2,185 |
| 1.20                     | 1,032                   | 1,131  | 1,306  | 1,460  | 1,599  | 1,727  | 1,846  | 1,959  | 2,065  | 2,165 | 2,265 | 2,365 |
| 1.40                     | 1,115                   | 1,221  | 1,410  | 1,577  | 1,727  | 1,866  | 1,995  | 2,116  | 2,230  | 2,345 | 2,460 | 2,575 |



|        |       |        |        |        |        |        |        |        |        |
|--------|-------|--------|--------|--------|--------|--------|--------|--------|--------|
| 1.60   | ..... | 1,306  | 1,509  | 1,686  | 1,846  | 1,995  | 2,133  | 2,262  | 2,384  |
| 1.80   | ..... | 1,264  | 1,599  | 1,788  | 1,959  | 2,116  | 2,262  | 2,399  | 2,529  |
| 2.00   | ..... | 1,333  | 1,666  | 1,885  | 2,065  | 2,230  | 2,384  | 2,529  | 2,665  |
| 2.50   | ..... | 1,490  | 1,632  | 1,885  | 2,108  | 2,308  | 2,665  | 2,827  | 2,980  |
| 3.00   | ..... | 1,632  | 1,788  | 2,065  | 2,380  | 2,529  | 2,732  | 3,097  | 3,264  |
| 4.00   | ..... | 1,885  | 2,065  | 2,384  | 2,665  | 2,920  | 3,154  | 3,576  | 3,770  |
| 5.00   | ..... | 2,108  | 2,308  | 2,665  | 2,980  | 3,264  | 3,770  | 4,000  | 4,214  |
| 6.00   | ..... | 2,308  | 2,529  | 2,920  | 3,264  | 3,576  | 4,129  | 4,379  | 4,617  |
| 7.00   | ..... | 2,493  | 2,732  | 3,154  | 3,526  | 3,863  | 4,172  | 4,460  | 4,731  |
| 8.00   | ..... | 2,665  | 2,920  | 3,372  | 3,770  | 4,129  | 4,460  | 4,731  | 4,987  |
| 9.00   | ..... | 2,827  | 3,097  | 3,576  | 3,998  | 4,379  | 4,731  | 5,057  | 5,331  |
| 10.00  | ..... | 2,980  | 3,264  | 3,770  | 4,214  | 4,617  | 4,987  | 5,331  | 5,654  |
| 12.00  | ..... | 3,264  | 3,576  | 4,129  | 4,617  | 5,057  | 5,462  | 5,840  | 6,192  |
| 14.00  | ..... | 3,526  | 3,863  | 4,460  | 4,987  | 5,462  | 5,900  | 6,306  | 6,752  |
| 16.00  | ..... | 3,770  | 4,129  | 4,768  | 5,331  | 5,840  | 6,306  | 6,752  | 7,152  |
| 18.00  | ..... | 3,998  | 4,379  | 5,057  | 5,654  | 6,192  | 6,693  | 7,152  | 7,539  |
| 20.00  | ..... | 4,214  | 4,617  | 5,331  | 5,960  | 6,529  | 7,052  | 7,539  | 7,996  |
| 25.00  | ..... | 4,713  | 5,161  | 5,960  | 6,663  | 7,299  | 7,885  | 8,429  | 8,940  |
| 30.00  | ..... | 5,161  | 5,659  | 6,529  | 7,299  | 7,996  | 8,637  | 9,194  | 9,740  |
| 40.00  | ..... | 5,960  | 6,529  | 7,539  | 8,429  | 9,233  | 9,973  | 10,660 | 11,310 |
| 50.00  | ..... | 6,663  | 7,299  | 8,429  | 9,423  | 10,320 | 11,150 | 11,920 | 12,640 |
| 60.00  | ..... | 7,299  | 7,996  | 9,233  | 10,320 | 11,310 | 12,210 | 13,060 | 13,850 |
| 70.00  | ..... | 7,885  | 8,637  | 9,973  | 11,150 | 12,210 | 13,200 | 14,100 | 14,960 |
| 80.00  | ..... | 8,429  | 9,233  | 10,660 | 11,920 | 13,060 | 14,100 | 15,090 | 15,770 |
| 90.00  | ..... | 8,940  | 9,794  | 11,310 | 12,640 | 13,850 | 14,960 | 15,990 | 16,960 |
| 100.00 | ..... | 9,423  | 10,320 | 11,920 | 13,330 | 14,600 | 15,770 | 16,860 | 17,880 |
| 120.00 | ..... | 10,320 | 11,310 | 13,060 | 14,600 | 15,990 | 17,270 | 18,460 | 19,590 |
| 140.00 | ..... | 11,150 | 12,210 | 14,100 | 15,770 | 17,270 | 18,660 | 19,950 | 21,160 |
| 160.00 | ..... | 11,920 | 13,060 | 15,090 | 16,860 | 18,460 | 19,950 | 21,330 | 22,620 |
| 180.00 | ..... | 12,640 | 13,850 | 15,990 | 17,880 | 19,590 | 21,160 | 22,620 | 23,990 |
| 200.00 | ..... | 13,330 | 14,600 | 16,860 | 18,850 | 20,650 | 22,300 | 23,840 | 25,290 |

The table shown above is given as an aid to the calculations for wave length. It gives the wave length in meters, when the capacity and inductance are known. In the same sense, the table can be used to get any one of the three values when the other two are known. This will help in eliminating a number of the tiresome calculations necessary in solving the wave length formula.

## APPENDIX III

### HOOK UP DIAGRAMS

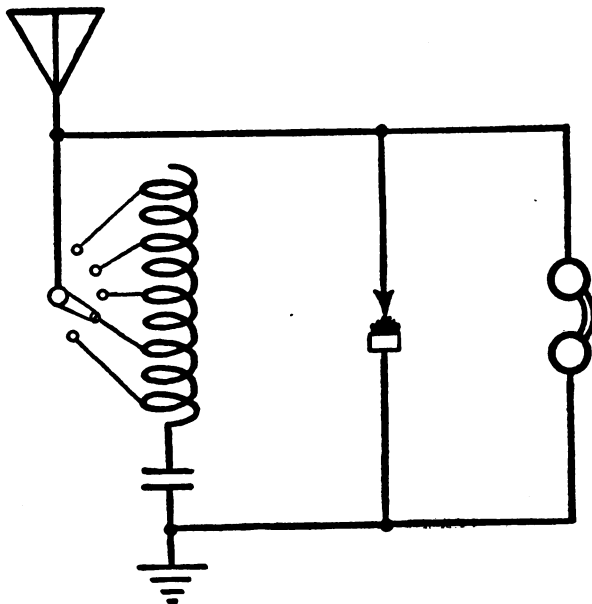

Fig. 113

#### TAPPED TUNING COIL CRYSTAL SET

This simple circuit with a tapped tuning coil and a .001 Mfd. fixed condenser in series will give very good results for local broadcasting. The fixed condenser can be changed to the variable type if more accurate tuning is necessary.

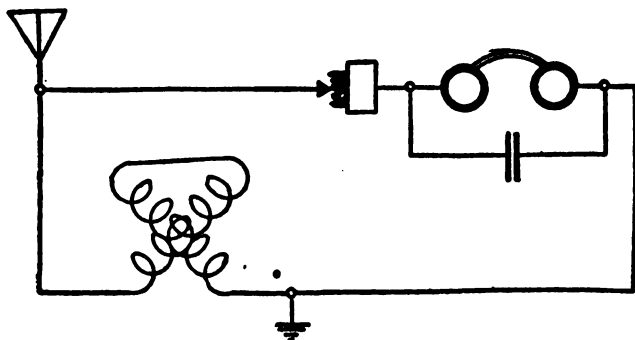

Fig. 114

**VARIOMETER CRYSTAL SET**

In this circuit a variometer is used as the tuning inductance in conjunction with the usual crystal detector hook-up. This type of circuit will interest the amateur who contemplates using his apparatus for a vacuum tube set later on.

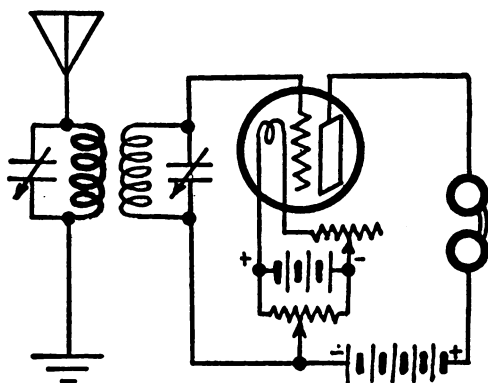

Fig. 115

## TWO CIRCUIT VACUUM TUBE SET

The tuning apparatus of this hook-up is of the fixed coupled type with a set inductance value for primary and secondary circuits. A 43 plate variable condenser is used for tuning the primary for proper wavelength and a 23 plate variable controls the secondary. The calculations of the necessary turns will be found by reference to the appendix. A potentiometer is used to control the grid potential.

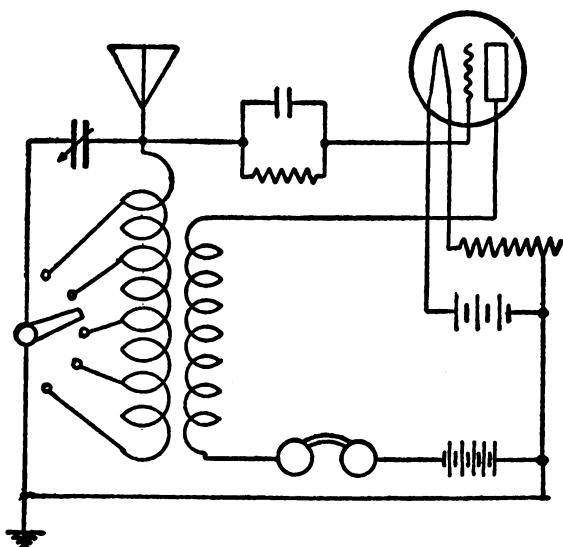

Fig. 116

## REGENERATIVE VARIOCOUPLER CIRCUIT

In this hook-up the primary of the variocoupler is used for both primary and grid circuits while the secondary is used as a tickler coil in the plate circuit. The 43 plate variable condenser tunes the primary circuit.

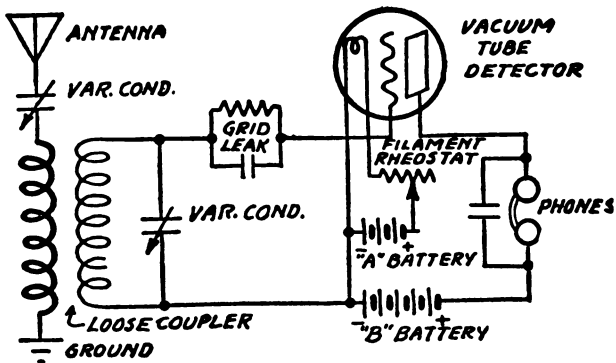

Fig. 117

## TWO CIRCUIT LOOSE COUPLER SET

A variable condenser is connected in series with the primary coil. The secondary controls the grid current. A 43 plate condenser is shunted across the secondary coil.

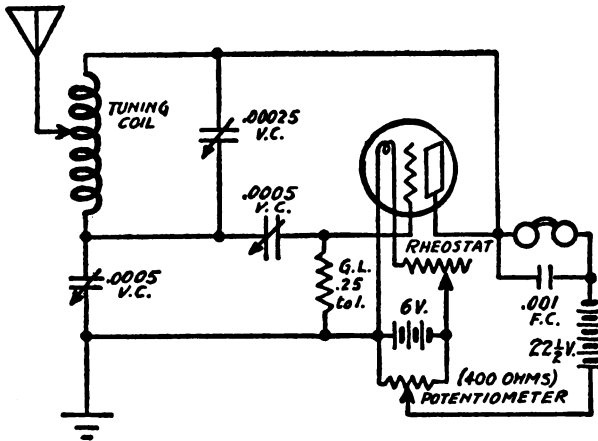

Fig. 118

## AN UNUSUAL REGENERATIVE CIRCUIT

This circuit presents numerous unusual features. A simple tuning coil with a 23 plate variable condenser in series makes up the primary circuit. A feed-back from the free end of the tuning coil is used to the plate circuit. A .00025 Mfd. Variable Condenser is shunted across the tuning coil for control of the feed-back. The grid condenser is also made variable. A 400 ohm potentiometer is shunted across the "A" battery and is used for adjustment of the plate circuit potential.

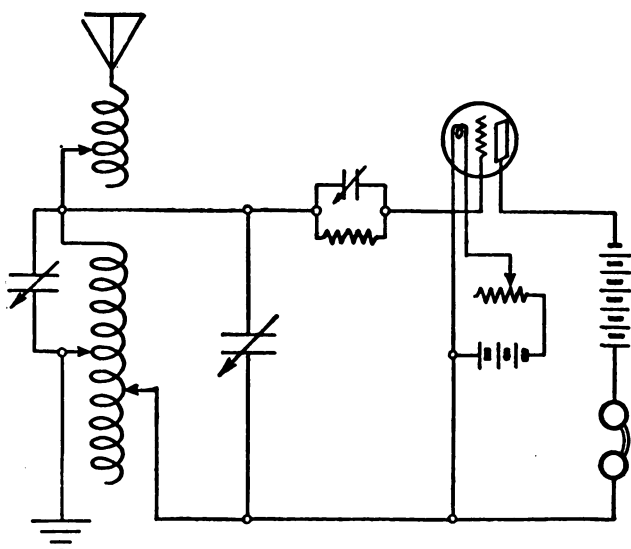

Fig. 119

#### TWO SLIDE TUNER WITH LOADING COIL CIRCUIT

Although this hook-up may appear unusual, it is very simple in form, differing little from the average. The first coil in series with the antenna is a single slide tuner used for loading up or increasing the wavelength of the primary circuit. The regular tuning inductance is a two slide coil. Two 23 plate condensers are used with the primary and grid circuits for more accurate tuning adjustment. The grid condenser can be either fixed or variable as desired. A capacity of .0005 Mfd. is the maximum required.



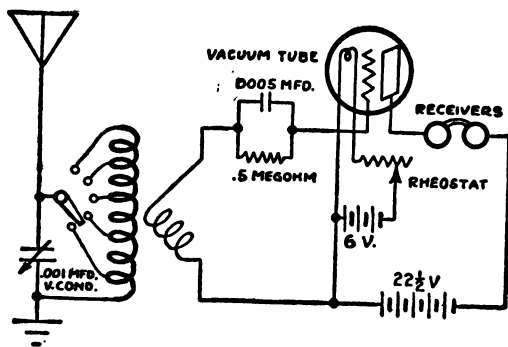

Fig. 120

## VARIOCOUPLER VACUUM TUBE SET

This circuit corresponds to the usual variocoupler variometer circuit with the variometers omitted. The circuit therefore is non-regenerative and does not possess the usual difficulties encountered in tuning. The values are plainly indicated, and require no further description.

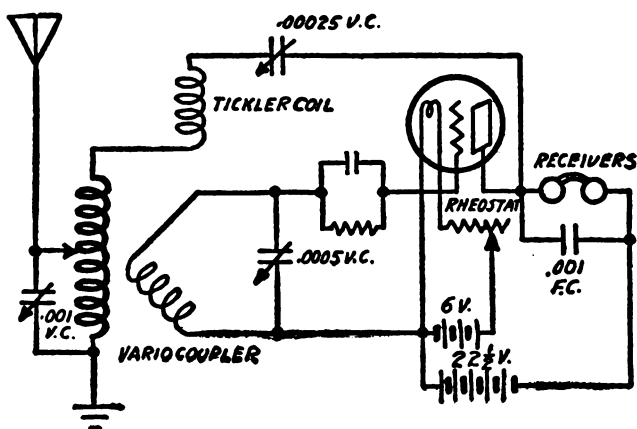

Fig. 121

### VARIOCOUPLER AND TICKLER COIL CIRCUIT

In this circuit the usual variocoupler has a tickler coil rotor added on the side opposite to the usual secondary. This gives a very efficient regenerative circuit that has been used in a number of the manufactured sets. The tickler coil does not consist of more than fifteen to twenty five turns, while the values of the condensers are plainly indicated.

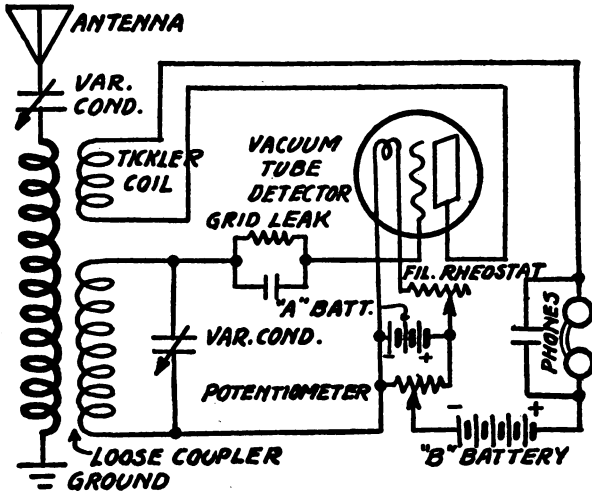

Fig. 122

#### LOOSE COUPLER AND TICKLER COIL CIRCUIT

In this hook-up the tickler coil is added to one end of the loose coupler, giving the benefit of accurate tuning possibilities of the loose coupler in conjunction with the advantages of the feed-back circuit. A 43 plate variable is connected in series in the antenna circuit, and a 23 plate variable is shunted across the secondary. A potentiometer is used across the "A" battery.

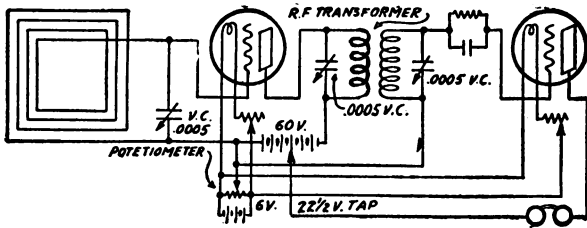

Fig. 123

### RADIO FREQUENCY WITH LOOP ANTENNA

To the amateur who is restricted to loop antenna work, this circuit will appeal. One stage of radio frequency overcomes the handicap of an indoor aerial. A 23 plate variable is used for tuning the loop circuit, while the potentiometer permits accurate control of the grid in both tubes. 60 volts are used on the plate of the amplifier tube, but a 22½ volt tap controls the plate circuit of the detector tube. The usual radio frequency transformer is improved by the use of two 23 plate variable condensers across the primary and secondary circuits, permitting maximum efficiency of the transformer.

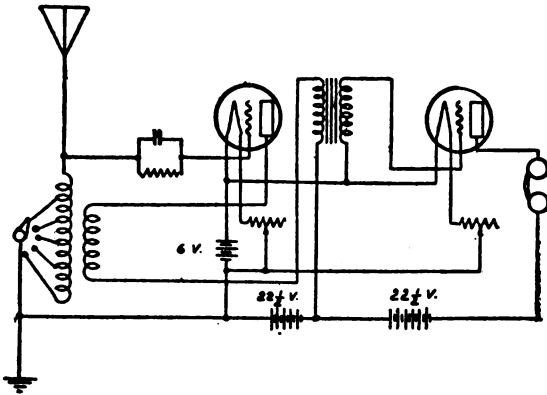

Fig. 124

#### AUDIO FREQUENCY VARIOCOUPLER CIRCUIT

This hook-up is similar to that used in Figure I 16 with the addition of one stage of audio frequency. The primary circuit does not indicate the addition of a variable condenser but this can be added if more accurate tuning is found necessary. An extra  $22\frac{1}{2}$  volt "B" battery is required.

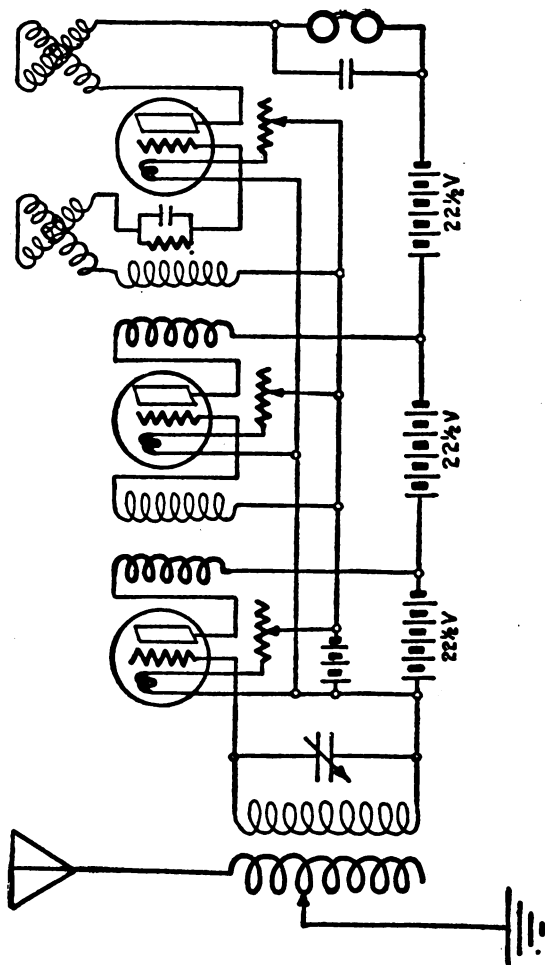

Fig. 125

**TWO STEP RADIO FREQUENCY VARIOCOUPLER AND  
VARIOMETER SET**

This hook-up is primarily designed for long distance reception without the use of loud speakers. The usual variocouplers and variometers are used. A .0005 Mfd. variable condenser is shunted across the secondary of the variocoupler. The transformers are of the radio frequency type designed for wavelength range running from three hundred to five hundred meters. This circuit was primarily intended for short range circuit only.

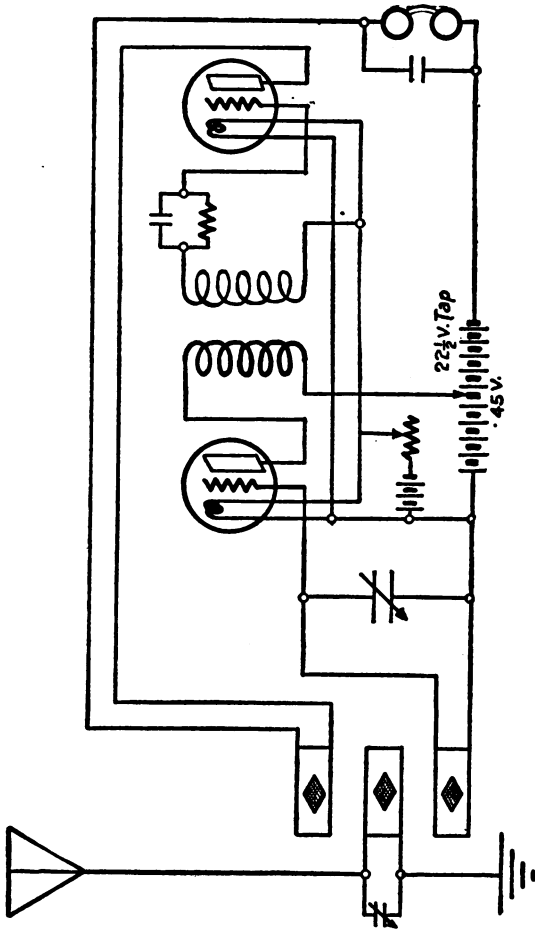

Fig. 126



**ONE STEP RADIO FREQUENCY HONEYCOMB COIL  
CIRCUIT**

This circuit is of the regenerative type for long distance reception covering both short and long wavelength ranges. A 43 plate variable condenser is shunted across the primary coil and a 23 plate variable condenser across the secondary coil. The wavelength range is controlled by the values of the honeycomb coils used but in addition is limited by the radio frequency transformer.

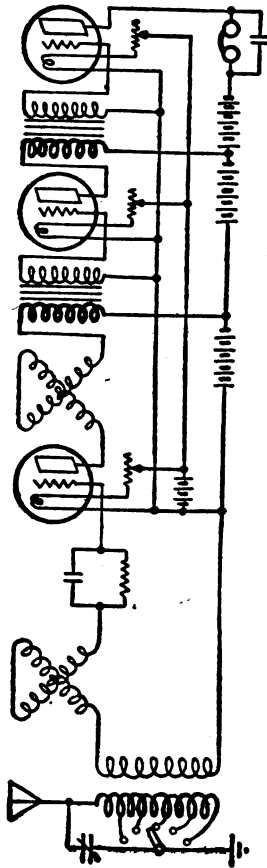

Fig. 127

**TWO STEP AUDIO FREQUENCY VARIOCOUPLER  
VARIOMETER CIRCUIT**

This hook-up is designed for loud reception of local broadcasting, although good results will be obtained for limited long distance work. The use of the variometers classifies it in the regenerative type. A 43 plate variable condenser is shunted across the primary of the variocoupler permitting very close and accurate tuning. Any of the standard audio frequency transformers will operate satisfactorily in this circuit. The plate batteries consist of three  $22\frac{1}{2}$  volt units.

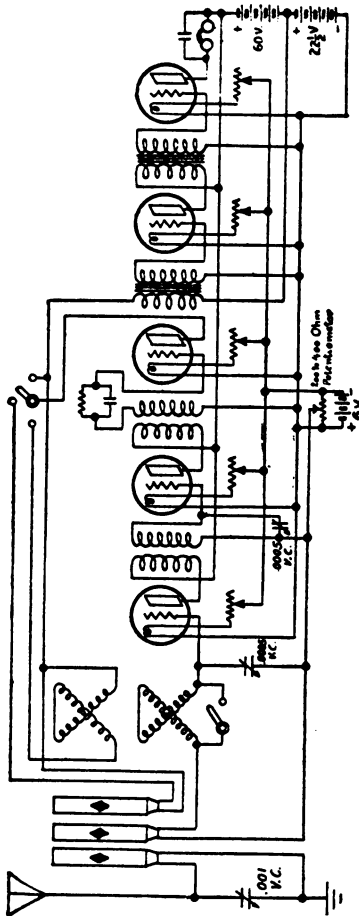

Fig. 128

TWO STEP RADIO FREQUENCY AND TWO STEP AUDIO  
FREQUENCY. LONG AND SHORT RANGE RECEIVER

This hook-up is of peculiar design combining both the advantages of variometers and honeycomb coils in one circuit with two switches to control either type. A potentiometer is shunted across the filament battery and permits accurate control of the grid potential in the first and second R.F. Amplifying tubes. A 43 plate condenser is shunted across the primary and a 23 plate across secondary. The switch on top permits the use of the honeycomb coil as tickler for the variometer. In either case the circuit would be regenerative, or use of either can be eliminated, making the circuit non-regenerative. The grid variometer can be cut out by means of the switch which short circuits the windings. A 23 plate variable condenser is shunted across the secondary of the first R.F. Transformer for control of the secondary winding.

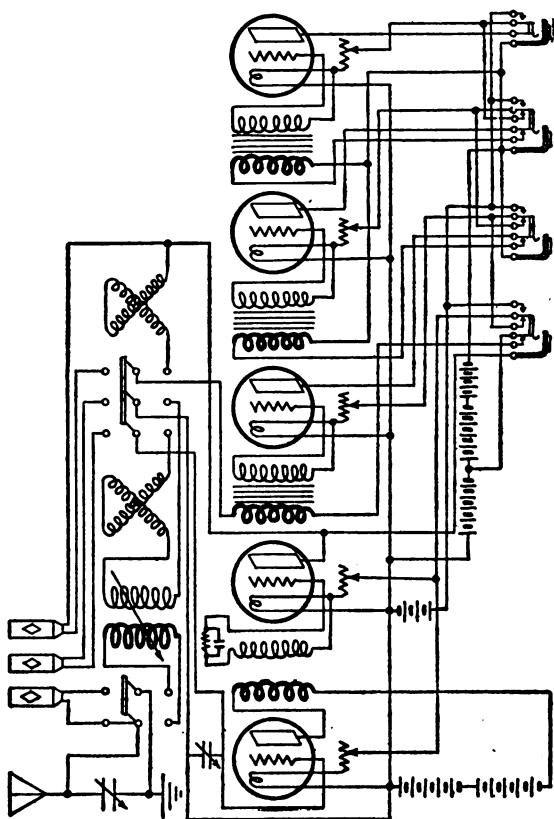

Fig. 129

**ANOTHER LONG AND SHORT RANGE RECEIVING SET**

This hook-up gives a most complete and detailed circuit, utilizing one step of radio frequency detector and three steps of audio frequency, combining the use of filament control jacks in order to control the amplifying stages. At the same time, means are provided for switching in either variometer or variocoupler tuning method or triple honeycomb coils. One two-pole double throw and one three-pole double throw switch is necessary. A 43 plate variable condenser is shunted across the primary in both combinations, likewise a 23 plate condenser across the secondary. Two  $22\frac{1}{2}$  volt or a single 45 volt unit is used for the plate of the first tube. The "A" battery supplies the filament current for all five tubes. Separate rheostats are used for each tube. Three  $22\frac{1}{2}$  volt units are used for the plates in the last four tubes, although the detector tube plate circuit taps in on the first  $22\frac{1}{2}$  volt battery. The connections for the jacks are clearly indicated so that the filament lighting is controlled by the step in which the receivers are plugged in.





## INDEX OF HOOK-UP DIAGRAMS

|   | FIG. | PAGE |
|---|------|------|
| <b>Audio Frequency Amplification</b>  |      |      |
| Inductance coupled . . . . .  | 78   | 119  |
| One-step—Variocoupler tuning . . .  | 124  | 219  |
| Three-step—Plug switching panel   | 110  | 167  |
| Two-step—Variometer grid control . . . . .  | 83   | 124  |
| Two-step—Two-step Radio Frequency Amp . . . . .   | 84   | 125  |
| Two-step—Two-step Rad. Freq. Amp. with Honeycomb or Variometer tuning . . . . .                 | 128  | 226  |
| <b>Crystal Detector sets</b>  |      |      |
| Honeycomb tuning . . . . .  | 69   | 106  |
| One-step Rad. Amp.—Loop antenna . . . . .   | 93   | 142  |
| Tapped coil tuning . . . . .  | 113  | 208  |
| Variometer tuning . . . . .   | 114  | 209  |
| <b>Honeycomb coil sets</b>  |      |      |
| One-step Rad. Freq.—Regenerative . . . . .  | 126  | 222  |
| Three-coil—Aud. Freq. Amp.  | 71   | 108  |
| Three-coil—Two-step Rad. and Two-step Aud. Freq. Amp. with optional Variometer tuning . . . . . | 128  | 226  |

## 232 INDEX OF HOOK-UP DIAGRAMS

|  | FIG. | PAGE |
|--|------|------|
| Honeycomb coil sets— <i>Continued</i>            |      |      |
| Two-coil—Crystal Det.....                        | 69   | 106  |
| Two-coil—Vacuum tube.....                        | 70   | 106  |
| Inductance coupling                              |      |      |
| Impedance coupling.....                          | 81   | 121  |
| Tapped coupling in Aud. Freq.<br>Amp.....        | 78   | 119  |
| Var. Condenser coupling.....                     | 79   | 120  |
| with Variocoupler and Potentio-<br>meter.....    | 52   | 86   |
| Instrument control                               |      |      |
| Set.....   | 104  | 160  |
| Loading coil circuit                             |      |      |
| with Slide tuner.....                            | 119  | 214  |
| Loop Antenna sets                                |      |      |
| Cryst. Det.—One step Rad. Freq.<br>Amp.....      | 93   | 142  |
| One-step Rad. Freq. Amp.....                     | 123  | 218  |
| Vac. Tube—Tapped antenna....                     | 94   | 142  |
| Loose coupler set                                |      |      |
| Simple two-circuit set.....                      | 60   | 98   |
| with Tickler control.....                        | 122  | 217  |
| Plug Control                                     |      |      |
| One-step Rad.—Three-step Audio<br>Freq. Amp..... | 129  | 228  |
| Three-step Aud. Freq. Amp.....                   | 110  | 167  |
| Potentiometer                                    |      |      |
| Radio Frequency Amplification                    |      |      |
| Impedance coupled.....                           | 81   | 121  |
| One-step—Loop Ant.—Cryst. Det.                   | 93   | 142  |

# INDEX OF HOOK-UP DIAGRAMS 233

|  | FIG. | PAGE |
|--|------|------|
| <b>Radio Frequency Amplification—Continued</b>                                     |      |      |
| One-step—Loop Ant.—Vac. Tube<br>Det.....   | 123  | 218  |
| One-step—Regenerative—Honey-<br>comb tuning.....                                   | 126  | 222  |
| Resistance coupled.....  | 77   | 117  |
| Transformer coupled.....   | 76   | 117  |
| Two-step—Variocoupler tuning..   | 82   | 123  |
| Two-step—Two-step Aud. Freq.<br>Amp.....   | 84   | 125  |
| Two-step—Two-step Aud. Freq.<br>Amp. with Variometer or Honey-<br>comb tuning..... | 128  | 226  |
| Two-step—Variometer and Vario-<br>coupler control.....                             | 125  | 221  |
| <br><b>Regenerative circuits</b>   |      |      |
| Slide tuner.....   | 118  | 213  |
| Three-step Aud. Freq. Amp.—<br>Plug control.....                                   | 110  | 167  |
| Two-step Audio Freq.....   | 127  | 225  |
| Variocoupler control.....  | 116  | 211  |
| Variocoupler and tickler circuit..   | 121  | 216  |
| <br><b>Resistance coupling</b>   |      |      |
| in Rad. Freq. Amp.....   | 77   | 118  |
| <br><b>Single circuit Set</b>  |      |      |
| Two-element Vacuum Tube.....   | 35   | 60   |
| <br><b>Three Circuit Set</b>   |      |      |
| Variocoupler and Grid Variometer   | 66   | 103  |

## 234 INDEX OF HOOK-UP DIAGRAMS

|   | FIG. | PAGE |
|---|------|------|
| Transformer coupling                        |      |      |
| Rad. Freq. Amp.....                         | 76   | 117  |
| Two Circuit Set                             |      |      |
| Fixed coupler.....                          | 115  | 210  |
| Loose coupler.....                          | 60   | 98   |
| Loose coupler.....                          | 117  | 212  |
| Two Element Tube set                        |      |      |
| Single slide tuning coil.....               | 35   | 60   |
| Variocoupler                                |      |      |
| One-step Aud. Freq. Amp.....                | 124  | 219  |
| Potentiometer Grid Control.....             | 52   | 85   |
| Regenerative—with Tickler Coil..            | 121  | 216  |
| in Three-circuit set—Grid Variometer.....   | 66   | 103  |
| Two-step Rad. Freq. Amp.....                | 82   | 123  |
| Two-step Rad. Freq.—Variometer control..... | 125  | 221  |
| Simple set.....                             | 120  | 215  |

## GENERAL INDEX

### A

|                               | PAGE |
|-------------------------------|------|
| Ammeter, construction of..... | 156  |
| use of.....                   | 160  |
| Amperes.....                  | 4    |
| Amplification, theory of..... | 114  |
| Amplifying horns.....         | 70   |
| Antenna formula.....          | 179  |
| indoor types.....             | 140  |
| installation.....             | 133  |
| light socket.....             | 143  |
| outdoor types.....            | 130  |
| Atomic Theory.....            | 50   |

### B

|                                   |     |
|-----------------------------------|-----|
| Batteries dry.....                | 146 |
| storage.....                      | 148 |
| Battery charging transformer..... | 145 |
| Book condenser.....               | 80  |
| Brush discharge.....              | 77  |

### C

|                          |     |
|--------------------------|-----|
| Capacity formulæ.....    | 178 |
| Coil fixed coupling..... | 110 |
| honeycomb.....           | 104 |

|                                       | PAGE |
|---------------------------------------|------|
| Coil fixed coupling— <i>Continued</i> |      |
| loading .....                         | 106  |
| loose coupler .....                   | 96   |
| slide .....                           | 93   |
| transformer .....                     | 95   |
| variocoupler .....                    | 99   |
| variometer .....                      | 101  |
| Coil formulæ .....                    | 180  |
| Condenser book .....                  | 80   |
| cone .....                            | 80   |
| fixed .....                           | 77   |
| grid .....                            | 65   |
| sliding .....                         | 79   |
| theory .....                          | 19   |
| variable .....                        | 78   |
| vernier .....                         | 79   |
| Crystal detector .....                | 46   |

## D

|                          |     |
|--------------------------|-----|
| Dalton .....             | 50  |
| Damped waves .....       | 34  |
| De Forest, Dr. ....      | 61  |
| Dielectric .....         | 75  |
| table of constants ..... | 184 |

## E

|                               |    |
|-------------------------------|----|
| Electricity elements of ..... | 3  |
| Electron theory .....         | 49 |

## F

|                |     |
|----------------|-----|
| Farads .....   | 82  |
| Feedback ..... | 110 |

**GENERAL INDEX** **237**

|                               | PAGE |
|-------------------------------|------|
| Fire underwriters' rules..... | 139  |
| Fixed condenser.....          | 77   |
| Fixed coupling.....           | 109  |
| Fleming, Prof.....            | 49   |
| Frequency.....                | 40   |
| formula.....                  | 177  |
| table of.....                 | 45   |

**G**

|                            |        |
|----------------------------|--------|
| Grid (in vacuum tube)..... | 62     |
| Grid leak.....             | 65, 87 |
| condenser.....             | 65, 87 |
| Ground connection.....     | 143    |
| outside.....               | 137    |

**H**

|                      |     |
|----------------------|-----|
| Hertzian waves.....  | 32  |
| Honeycomb coils..... | 104 |
| table of.....        | 185 |

**I**

|                            |     |
|----------------------------|-----|
| Increasing wavelength..... | 111 |
| Inductance.....            | 16  |
| calculation of.....        | 189 |
| magnetic.....              | 13  |
| mechanical.....            | 12  |

**J**

|                             |     |
|-----------------------------|-----|
| Jacks, construction of..... | 163 |
| use of.....                 | 165 |

|                                     | PAGE |
|-------------------------------------|------|
| L                                   |      |
| L type antenna.....                 | 130  |
| Light socket antenna.....           | 143  |
| Lightning.....                      | 135  |
| arrester.....                       | 137  |
| protection rules.....               | 139  |
| switch.....                         | 136  |
| Loading coils.....                  | 107  |
| calculation of.....                 | 192  |
| table of.....                       | 185  |
| Loop antenna.....                   | 140  |
| Loose coupler.....                  | 96   |
| Loud speakers.....                  | 70   |
| magnetic.....                       | 73   |
| microphone.....                     | 73   |
| M                                   |      |
| Magnetism.....                      | 8    |
| Microfarads.....                    | 82   |
| Microphone.....                     | 73   |
| Milliammeters, construction of..... | 156  |
| use of.....                         | 159  |
| Modulation.....                     | 42   |
| O                                   |      |
| Ohm's Law.....                      | 177  |
| Oscillation.....                    | 109  |
| P                                   |      |
| Parallel connection batteries.....  | 5    |
| condensers.....                     | 13   |



# GENERAL INDEX

239

|                             | PAGE |
|-----------------------------|------|
| Plugs, construction of..... | 162  |
| Polarization.....           | 146  |
| Potentiometer.....          | 85   |
| Power tubes.....            | 126  |

## R

|                                    |     |
|------------------------------------|-----|
| Radio frequency amplification..... | 117 |
| Rectification.....                 | 42  |
| Regenerative tuning.....           | 110 |
| Rheostat.....                      | 83  |

## S

|                                  |              |
|----------------------------------|--------------|
| Saturation point.....            | 59           |
| Self inductance.....             | 17           |
| Series connection batteries..... | 5            |
| condensers.....                  | 13           |
| Slide tuning coils.....          | 93           |
| Sliding condenser.....           | 79           |
| Sound waves.....                 | 128          |
| Spiral antenna.....              | 140          |
| Storage batteries.....           | 148          |
| care of.....                     | 149          |
| Symbols used in Radio.....       | Frontispiece |

## T

|                                |     |
|--------------------------------|-----|
| T type antenna.....            | 130 |
| Telephone receivers.....       | 67  |
| operation of.....              | 30  |
| Three circuit hook-up.....     | 102 |
| Three element Vacuum tube..... | 64  |

|                                   | PAGE |
|-----------------------------------|------|
| Transformer.....                  | 95   |
| battery charging.....             | 145  |
| formulae.....                     | 179  |
| Tuning apparatus calculation..... | 188  |
| coils (see Coils, tuning)         |      |
| explanation of.....               | 89   |
| Two circuit hook-up.....          | 98   |
| Two element Vacuum tube.....      | 54   |

## U

|                            |     |
|----------------------------|-----|
| Umbrella type antenna..... | 130 |
| Undamped waves.....        | 39  |

## V

|                                 |     |
|---------------------------------|-----|
| Vacuum tube three element.....  | 64  |
| two element.....                | 54  |
| Variable condenser.....         | 78  |
| Variocoupler.....               | 99  |
| Variometer.....                 | 101 |
| Vernier condenser.....          | 79  |
| rheostat.....                   | 84  |
| Voltmeter, construction of..... | 156 |
| use of.....                     | 160 |
| Volts.....                      | 4   |

## W

|                                |         |
|--------------------------------|---------|
| Wavelength, definition of..... | 40      |
| formulae of.....               | 183     |
| increase of.....               | 111     |
| tables.....                    | 206-207 |
| Wave theory.....               | 24      |

# GENERAL INDEX

241

|                          | PAGE |
|--------------------------|------|
| Waves damped.....        | 34   |
| sound.....               | 28   |
| undamped.....            | 39   |
| Wire diameter table..... | 205  |
| turns table.....         | 204  |



# The Outline of Science

Edited by Prof. J. ARTHUR THOMSON

4 vols. Royal Octavo. Nearly 1000 Illustrations  
Including 40 Large Plates in Color

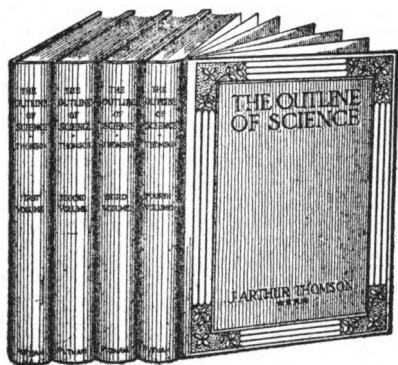

The wonderful story of effort, of advancement, of progress, of accomplishment, and of the evolution of the sciences of today from the earlier conceptions and theories of our ancestors, told

in plain language, free from technical terms.

Here is the story of the progress of Science, of results obtained, conclusions drawn, and facts verified, by the most eminent students in all branches of science. These writers have sought to open up their various subjects, as one might on a walk with a friend, and have succeeded so admirably that the work might be termed Informal Introductions to the Various Departments of Knowledge.

The Editor needs no introduction to Scientific Circles, and no writer of today is capable of a greater gift of luminous expression—always vividly alive, illustrative and suggestive.

**G. P. Putnam's Sons**

New York

London

# Gravitation Versus Relativity

By Charles Lane Poor

Presents for the layman the Einstein theory of relativity and the law of gravitation, explaining wherein they differ. This volume also discusses the so-called proofs of the Einstein theory and shows their weaknesses. Professor Poor, who is head of the Celestial Mechanics Department at Columbia University, has written this book primarily for the man-in-the-street, and its freedom from bewildering technicalities and heavy theorizing makes it a work of more than ordinary value.

---

G. P. Putnam's Sons

New York

London









111

1  
Nile 150

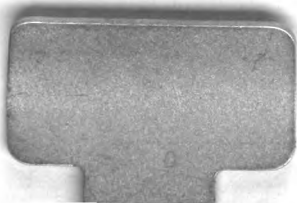

MS. No. 187 H V

