

# Radio receiving for beginners

Rhey T.  
Snodgrass, Victor  
Camp

Eng 4249.22.25



HARVARD  
COLLEGE  
LIBRARY

# **Radio receiving for beginners**

Eng 4249.22.25



HARVARD  
COLLEGE  
LIBRARY

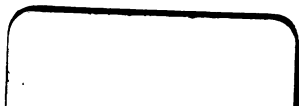

**RADIO RECEIVING  
FOR BEGINNERS**



**THE MACMILLAN COMPANY**  
NEW YORK · BOSTON · CHICAGO · DALLAS  
ATLANTA · SAN FRANCISCO

**MACMILLAN & CO., LIMITED**  
LONDON · BOMBAY · CALCUTTA  
MELBOURNE

**THE MACMILLAN CO. OF CANADA, LTD.**  
TORONTO





Frontispiece



# RADIO RECEIVING

FOR BEGINNERS

BY

RHEY T. SNODGRASS

AND

VICTOR F. CAMP, A.I.R.E.

*New York*

THE MACMILLAN COMPANY

1922

*All rights reserved*

PRINTED IN THE UNITED STATES OF AMERICA

Eng 4249. 22. 25



COPYRIGHT, 1922,  
By THE MACMILLAN COMPANY

Set up and printed. Published April, 1922

Press of  
J. J. Little & Ives Company  
New York, U. S. A.

## HOW CAN I RECEIVE RADIO?

THIS question is on the lips of thousands, perhaps millions, of people. It may be answered in so many ways as to leave one in a hopeless state of bewilderment, for this very new and very fascinating science is most uncanny in its ramifications even at the present time, to say nothing of its almost daily advancement and future possibilities.

On the other hand, your question may be answered quite simply; in a manner which will enable you to begin receiving at once, and to understand the fundamental principles of radio. From that point you may advance as you have time, inclination and means to go into more expensive apparatus.

Radio, particularly radio telephony, is too new to have become "standardized" beyond the elementary operations. On the more advanced questions you will find almost as many opinions as you find expert operators, and you will find good books galore on every phase of the subject.

The present little volume will leave the more

technical and diversified possibilities of radio receiving to be pursued in more exhaustive books, and keep down to the simple answer to your simple question, "How can I receive radio?"

We must necessarily choose between various methods. In so doing it is not claimed that ours is the *ONLY* way. Whether ours is the *BEST* way might open up a never ending argument, but the methods laid down in this book are known to be good, practical, easy to understand, simple to follow, and elastic enough to meet your allowance of time, study and cash outlay.

In the following text you will find reference to some instruments with which you may not be familiar. All of the instruments covered by this book will be found fully described in Chapter IX. We believe this plan is better than to fill the text with interruptive explanations, as some of our readers may not require all of them.

# CONTENTS

CHAPTER	PAGE
I. INTRODUCTION . . . . .	11
Elementary—no previous knowledge of electricity or radio required—popular demand for simple practical instruction—easy to start—simple apparatus will do—range of cost—how to begin receiving at once—no license required for receiving—may purchase complete outfit or separate instruments—same outfit receives both telephone and telegraph signals—telephone easier and more entertaining—broadcasting music, lectures, news, market reports, sports, interviews, church services—important developments by amateurs—open field for experiment—advise start with simple set and build up with experience.	
II. GENERAL PRINCIPLES . . . . .	16
Electro-magnetic waves—where originated—how radiated—made audible or “detected”—how strength of signals is determined—master receiving before transmitting—wide variety of methods—differences of opinion—practical advice to the beginner—antenna necessary for all methods of receiving.	
III. RECEIVING WITH A CRYSTAL DETECTOR . . . . .	23
Efficient for limited range—low cost—simple operation—several sets illustrated—how far it will receive—diagram and details of connections.	
IV. RECEIVING WITH VACUUM TUBES . . . . .	29
The tube defined—its action explained—more sensitive than crystal—gives much wider range—the tube itself an amplifier of signals—necessary	

CHAPTER	PAGE
units—optional units—how to connect and operate—three fundamental radio circuits, primary, secondary and wing—primary including antenna, coupler, antenna condenser, loading inductance, ground, and optional loading coils, inductance or primary variometer—secondary including coupler, condenser, grid of tube, tube-control, grid condenser, with optional variometer—wing circuit including B battery, plate and filament of tube, and phones—wiring instructions and diagrams.	
<b>V. REGENERATIVE RECEIVING . . . . .</b>	<b>42</b>
Possibility of greater range and louder signals—two principal methods—inductive and direct coupling—how strength of signal is increased—instruments illustrated—tickler coil—wing variometer.	
<b>VI. AMPLIFICATION . . . . .</b>	<b>51</b>
Greatly increases range and strength of signals—made possible by vacuum tube—different from detector tube—one, two or three stages—one or two for head phones, two or three with loud speaker—additional units required—how connected and operated—B battery separate or common—two stages ordinarily sufficient.	
<b>VII. CONSTRUCTING THE ANTENNA . . . . .</b>	<b>67</b>
General requirements—desirable conditions—making the most of local situation—several varieties—details of constructing and erecting—how to connect—protective devices—how to avoid interference—directional influence—indoor antenna—loop antenna—avoiding freaks.	
<b>VIII. GENERAL HINTS . . . . .</b>	<b>81</b>
Little things to look out for—results of practical experience—telegraph code.	
<b>IX. DESCRIPTION OF INSTRUMENTS . . . . .</b>	<b>89</b>
Definition, and practical operation of each instrument covered in this book—illustrations showing various types and styles.	

# ILLUSTRATIONS

	PAGE
Frontispiece	
<b>FIGURE</b>	
1 Standard Symbols used in Wiring Diagrams. . . . .	20, 21
2 Wiring Diagrams, Three Crystal Detector Sets, including Test-Buzzer . . . . .	24
3 Crystal Detectors . . . . .	26
4 Crystal Detector Sets . . . . .	26
5 A Vacuum Tube . . . . .	27
6 Diagram showing the Three Elements in the Vacuum Tube, and the Conductive Path of Electrons between the Filament and the Plate . . . . .	30
7 Diagram of simple Vacuum Tube Receiver Set . . . . .	31
8 Diagram of Vacuum Tube Set with Variometer in Secondary Circuit . . . . .	38
9 Diagram of Vacuum Tube Receiver Set, with Secondary Load, and Secondary Condenser in Shunt . . . . .	40
10 Diagram of Vacuum Tube Receiver Set, with Tickler Coil . . . . .	43
11 Diagram of Regenerative Receiver, with Variometer in Wing Circuit . . . . .	45
12 Vacuum Tube Receiver Sets . . . . .	27
13 Receiver Set, Instruments assembled by Amateur . . . . .	48
14 Receiver Sets with two-stage Amplifiers . . . . .	49
15 Diagram of Receiver Set, with one-stage Amplifier using two separate blocks of B Battery . . . . .	53
16 Diagram of Receiver Set, with one-stage Amplifier using common B Battery on both Detector and Amplifier . . . . .	58
17 Diagram of Receiver with two-stage Amplifier, with common B Battery and including Potentiometer and optional Phones or Loud Speaker . . . . .	61

FIGURE	PAGE
18 Diagram of Receiver with two-stage Amplifier, Potentiometer wired so as to effect a Negative Potential on the Grid, and optional Phones or Loud Speaker . . . . .	63
19 A good Type of Aerial for most ordinary conditions	65
20 Various Types of Antenna . . . . .	70
21 Ends of Antenna Wires led together . . . . .	72
22 Ends of Antenna Wires insulated and bonded . .	73
23 Ends of Antenna Wires left free . . . . .	74
24 Various Types of Insulator . . . . .	82
25 "A" Battery . . . . .	82
26 "B" Battery . . . . .	82
27 Condensers—fixed and variable, showing inside of the variable . . . . .	83
28 Grid leak . . . . .	83
29 Lightning Arrester and Lightning switch . . . .	83
30 Types of Loud Speaker . . . . .	90
31 Rheostats . . . . .	91
32 Slide tuner . . . . .	91
33 Potentiometer . . . . .	91
34 Types of Amplifier Transformer . . . . .	91
35 Variometer . . . . .	91
36 Diagram showing operation of Vacuum Tube . .	94
37 Morse International Code . . . . .	96, 97
38 List of common abbreviations in the telegraph code	98
39 Table of Wire Gauges . . . . .	99



**RADIO RECEIVING**  
**FOR BEGINNERS**



# RADIO RECEIVING

## I

### INTRODUCTION

WE assume that you have no previous knowledge or experience in radio work. You wish to learn how you may begin at once to "listen in" on the astounding things which are passing through the air all the time, day and night, right about our heads at this very moment.

Radio is a most fascinating pastime. While its possibilities are so boundless and intricate that the most advanced engineers are only beginning to solve them, you may begin with very simple operations which may be explained in simple terms. Thousands of twelve year old boys, *and girls*, are operating satisfactorily, entertaining their families and friends, while educating themselves. Anyone with common sense can readily grasp the elementary principles and begin receiving at once. After that it is simply a question of

time, study and practice. Every step of the way is most alluring—romantic. One has a constant sense of participating in the performance of magic. Nobody starts receiving and abandons it. One step leads to the next, and you simply cannot let it alone. All the while you are playing with one of the most worth-while developments of the age.

Many of the important steps in the progress of radio have been discovered by amateurs as the result of their own experiments. Indeed, radio may be called the science of the amateur. As this book goes to press there are estimated to be amateur radio stations and residences with receiving outfits in this country to the number of over half a million, and the number is leaping ahead every day. In the United States the laws and restrictions are very favorable to amateurs. This largely accounts for America's outstanding leadership in the development of radio over European countries, where the amateur is too much restricted to develop new ideas and practices. Many an amateur in this country has worked out radio operations and instruments which have led him into a fine professional career. In fact, most of the prominent names in radio are the names of men who began by "playing with radio."

In the United States, at the present moment, no license is required for *receiving* radio tele-

phone or telegraph. You may "listen in" to your heart's content, but a license and inspection *are required* for transmitting either telephone or telegraph. As transmitting is quite a different operation, and one which may be more properly considered after receiving is mastered, the present discussion will be confined to radio receiving, leaving the subject of transmitting to be covered in another volume.

You can begin receiving with very little outlay and very little study. The same apparatus will be used for receiving both telegraph and telephone signals. As telegraph comes in code (dots and dashes) we may consider that the more interesting and certainly the easier operation will be receiving telephone. At the present writing there are large and powerful sending stations located in so many places that practically every point in the United States is within reasonable amateur hearing distance of at least one of them. From these stations most interesting programs are being broadcasted daily, including music, lectures, news bulletins, weather and market reports, church services, interviews with prominent persons, and other features. Besides these larger stations there are many experimental stations and licensed amateur stations constantly sending out interesting matter; all of which you may easily

receive in your own home with a surprising degree of clearness and regularity from the first.

With most of us the question of cost is, to say the least, a factor. You may enter the radio wonderland on an investment of fifteen or twenty dollars, and get fair results within a limited radius. A little larger investment will give a little wider radius and more dependable results. Some one has said that your apparatus should cost a dollar per mile of effective operation, from fifteen up. This should not be taken too literally as an absolute rule, but is a fair indication of cost.

If you have time and a little skill you may effect some economy and gain good experience by making some of the instruments yourself, or you may purchase the instruments separately and assemble and connect them; or you may purchase neat cabinets in wide variety with the instruments self-contained and requiring only proper connections to be made, according to instructions furnished. We will not attempt to choose your instruments for you, but if you have not already selected them, this book will assist you in making a wise selection, and still leave you a wide range of option according to your requirements.

In most of our cities and many villages there is a local amateur radio club. Like everything pertaining to radio, these clubs are growing daily

in numbers and usefulness. Many of them are affiliated with the American Radio Relay League, with headquarters at Hartford, Conn., which is an international amateur organization. It will interest you and help keep you abreast of the newest developments to attend the meetings of your local club. The A. R. R. L., moreover, is instrumental in guiding legislation tending to foster amateur practice and to develop a large group of trained amateurs which has already proved to be a great national asset.

## II

### GENERAL PRINCIPLES

FOR purposes of radio communication, waves of electro-magnetic force are generated, and radiated by the antenna of a transmitting station. As we are now dealing only with radio receiving, we will not here discuss the means by which these waves are created and transmitted through the sending antenna system. The waves vary in length, strength, and certain other characteristics. Wave-length is regulated at the sending station, is measured in meters, and remains fixed regardless of the distance travelled. The power and strength of the waves are dependent upon the equipment of the sending station, and diminish as greater distances are travelled.

While there are several different kinds of waves emitted from the various types of transmitter, we need not here become involved with their differences.

That you may clearly understand the action of electro-magnetic waves, imagine a lake into which a stone is thrown. Waves are created which ra-



diate in all directions. Their size or length is in accordance with the size of the stone and the force with which it is thrown. Just so radio waves radiate, their length and amplitude in all directions are determined by the characteristics of the transmitter, and they are more perceptible near the sending station. They gradually diminish in amplitude—but not in length—as they travel longer distances.

To receive and detect these radiated waves, we must satisfy three requirements:—

1. We must be within the normal range of the transmitting station. (This range is determined by the sensitiveness of our receiving instruments.)
2. We must adjust or “tune” our receiving instruments to the wave-length of the particular transmitting station from which we wish to receive.
3. We must change the electro-magnetic waves into sound waves so as to be heard.

This all applies to receiving either telephone or telegraph signals. The final result in both cases is heard in telephone receivers, the telegraph message coming in a succession of buzzes representing dots and dashes, and the telephone message coming in its original transmitted form of speech,

music or other sounds. We have not yet found a single word to represent all that may be included in the telephone message, so we simply refer to all that is heard in our telephone receivers, whether telegraph or telephone messages, as "signals."

Waves from a spark transmitter will be received on a wider range of adjustment (broader tuning) than those from a station using what is called a continuous-wave transmitter. Stations using the latter are capable of transmitting energy on a sharper tuned wave of a given length and therefore requiring more careful adjustment or tuning at the receiving station to get signals of maximum strength. All telephone transmitting is done with continuous-wave.

Having tuned our instruments to the desired wave-length the next step is to make these waves audible as dots and dashes or as telephone communication. This is accomplished by means of a "detector" and telephone receivers. Should the signal not be sufficiently audible, its strength may be greatly increased within the receiving station by the use of a regenerative receiver, or an amplifier, or both. These will be described in Chapter IX.

The detailed methods of performing these three apparently simple operations, and the combina-

tions of instruments, are almost as numerous as the sands on the shore. You may connect up a very simple outfit so as to give you excellent results. Call in a friend and he will change the entire arrangement, assuring you that you have it all wrong, and "hook up" the same apparatus in some entirely different way. Probably the result will be about as before. Both of you are correct, only employing different methods to reach the same end. So it is among the most experienced amateur and professional operators. They do not agree. Yet, they may get equally good results with a given equipment.

It is this very wide diversity of ways and means and opinions that makes radio so fascinating. A pastime or a game which has been mastered to an exact certainty ceases to be interesting.

After you have made the most elementary beginning, and found how easily you can get good signals, the whole realm is before you, and your own methods or opinions may be as good as Marconi's.

It is not intended in this book to resolve or even enter into all these wide differences of method and opinion. We will not even go so far as to select a "one best" method. But we *will* select a *good* method, and outline a few simple, safe steps for the beginner. If you will follow

Antenna	
Battery	
Test Buzzer	
Condenser, Variable	
Connection of Wires	
Arch - No Connection	
Coupler, Inductive	
Coupler, Variable Inductive	
Crystal Detector	
Grid Leak and Grid Condenser	

FIG. 1.—Standard Symbols Used in Wiring Diagrams.

**Ground**



**Inductance Variable**

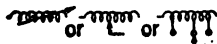

**Inductance**



**Loud Speaker**



**Receivers, Telephone**

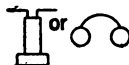

**Resistance Variable**

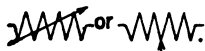

**Switch**



**Transformer, Core**

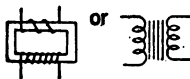

**Vacuum Tube**



**Variometer**



Symbols—(Continued).

them, they will lead out of the bewilderment of divergent opinions and different apparatus, and give immediate and surprising results. After you have this ground work you may branch out to your heart's content.

Every radio receiving or sending station requires an antenna. This usually consists of an aerial of wire and its supports, a rat-tail, lead-in, lightning switch, and a connection with the earth called the "ground." All of these are usually outside the "station" or building, in which the instruments themselves are located. Detailed instructions for constructing and erecting the antenna will be found in Chapter VII.

### III

#### RECEIVING WITH A CRYSTAL DETECTOR

FROM the standpoint of low cost and simplicity of operation, you may find it desirable to begin operations with the simplest possible outfit. This will be a crystal detector set. That is, one in which the detector, or instrument which changes the incoming waves to a form which will become audible in the telephone receivers, employs a piece of mineral crystal. Upon this crystal rests the end of a small piece of fine wire called the cat-whisker. The crystal may be one of several varieties, carborundum, galena, or silicon being chiefly used. In adjusting the detector for receiving, either the crystal or the cat-whisker is moved about until the most sensitive spot is found, which may easily be determined by the sound in the head phones, or by means of a test-buzzer.

This test-buzzer may be a small electric call-buzzer or an electric bell with the hammer removed. When operated by a dry battery, and connected to the ground lead, this test-buzzer

furnishes a constant impulse for testing out the most sensitive position of the crystal. A small switch enables you to throw the buzzer in for

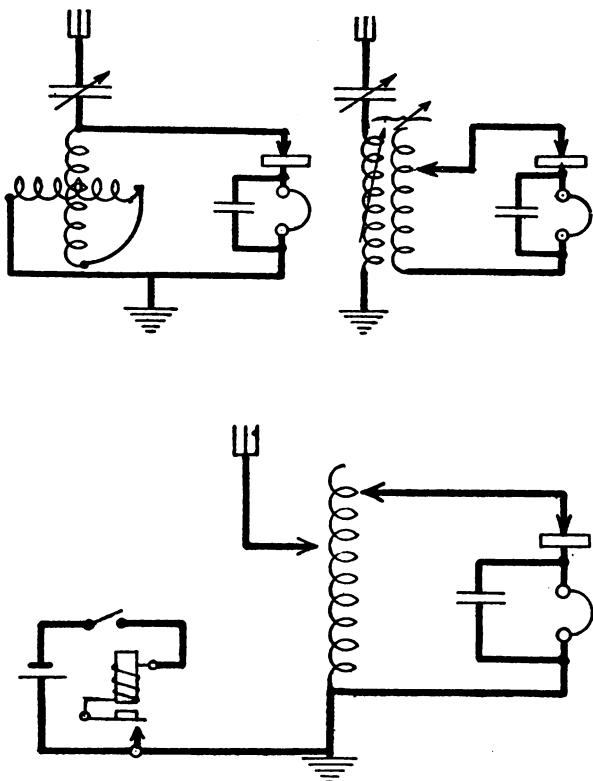

FIG. 2.—Wiring Diagrams, Three Crystal Detector Sets, Including Test-Buzzer.



## CRYSTAL DETECTOR RECEIVING 25

testing, and out again when you are receiving. Figure 2 shows just how to connect the buzzer.

The wire leading to the ground lead is connected to the adjustable contact screw or point on the buzzer interrupter.

It was formerly the custom for amateurs to make or purchase the several parts or elements for a crystal set, and assemble them. Many still prefer to work that way, and it is a pleasant pastime, but we assume that you wish to begin receiving as quickly as possible. Moreover, there have recently been placed upon the market many varieties of complete crystal detector sets ready for operation, many of them in neat cabinets which are handy, compact and good looking. Being made by some of the best known makers of electrical apparatus, they are correctly designed and will probably give the best results obtainable, for the least expenditure and with the least skill and study on the part of the operator.

So, if your beginning is to be made with a crystal set, we would advise purchasing one of these complete sets, and following carefully the accompanying directions for installing and operating it. Such sets are at this writing being offered at prices from \$15.00 to \$50.00 complete. As already explained, they will receive both telephone and telegraph signals.

How far will the crystal set receive? This is one of the first questions asked. It cannot be answered directly and accurately in miles. Several conditions must be reckoned with—your general location, antenna, amount and kind of local interference, strength of the waves you wish to receive and other factors.

Under extraordinarily good conditions, a crystal detector has been known to receive powerful transmission such as the Arlington time signals at a distance of a full thousand miles. On the other hand, in a city, among buildings and obstructions and with many kinds of local interference, an equally good crystal detector set might have difficulty in bringing in the present telephone broadcasting at a distance of twenty miles.

That seems like a very wide difference in operation, and it is. You must bear in mind that radio is advancing by leaps and bounds. Not such revolutionary improvements are being made in crystal detectors, and yet it is possible that before the ink on this page is dry their range may be greatly increased. Buy of a reliable dealer the product of a *reputable manufacturer*, and you will be safe. Several such sets are illustrated. There are many other good ones. If you are within ten or fifteen miles of a broadcasting station, or wish to work with another amateur within a similar

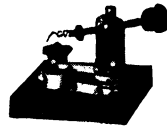

Fig. 3.

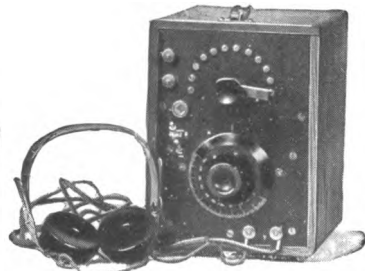
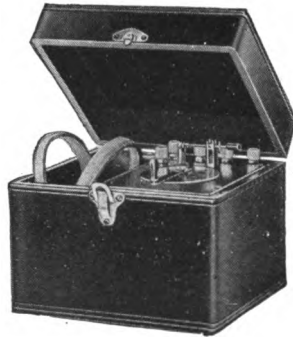
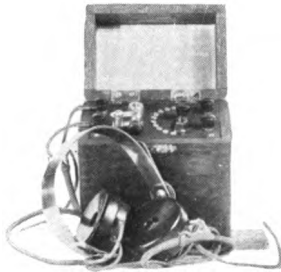

Fig. 4.

FIG. 3.—Crystal Detectors.—FIG. 4.—Crystal Detector Sets.

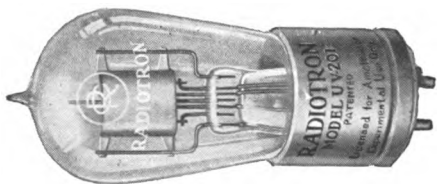
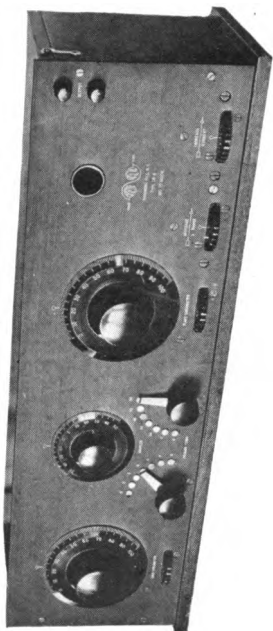
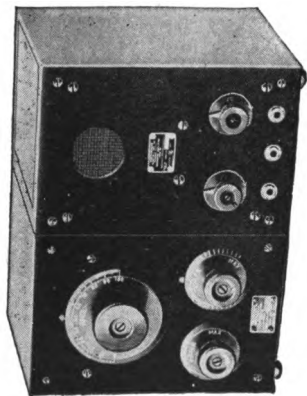

Fig. 12.

Fig. 5.

FIG. 5.—A Vacuum Tube.—FIG. 12.—Vacuum Tube Receiver Sets.

## CRYSTAL DETECTOR RECEIVING 27

range, you may find a crystal set very satisfactory.

While the crystal detector sets come completely wired, and requiring only the outside connections to be made to the binding posts as clearly indicated in the directions, you should know what the set consists of, and how it is wired or "hooked up." There are several methods, three of the best and most usual being shown in Figure 2. One diagram includes the test-buzzer already referred to. This is optional and is not as a rule included with the set, but its usefulness makes it well worth adding.

If you have difficulty in securing a set to suit you, or prefer to make and assemble your own, you should experience no great difficulty in doing so. You can make or buy a suitable coil for an inductance, make or buy a fixed condenser, and buy a complete crystal detector or the necessary mountings. These with a pair of head phones, all connected as shown in Figure 2, will put you in readiness to receive.

The "ground" shown in operating diagrams refers to an inside ground, and not the outside ground which is for protection against lightning. (See Chapter VII.) The wire leading from the instruments to the ground is fastened by means of a small clamp, or else soldered, to a cold water

pipe, steam radiator or some other pipe in the house which you know enters the ground. The cold water pipe is best. A gas pipe will do unless you have combination gas and electric light fixtures, in which case the gas pipe is insulated from the ground.

The phones should be a style designed especially for radio receiving, as ordinary telephone receivers will not respond properly to the weak currents which flow through the radio circuit. Such phones are offered in many varieties and at a wide range of prices. Get a good pair. They will repay you many times over in their greater responsiveness, and are the one instrument which you can carry along through all your stages in the practice of radio receiving.

Detailed directions for making instruments are not within the scope of the present volume, but form a separate subject already well covered by many books and magazines.

## IV

### RECEIVING WITH VACUUM TUBES

IN the search for some device which would detect signals from much greater distances than possible with the crystal detector, the three-element vacuum tube was discovered and developed to its present point of high efficiency.

There are several varieties of vacuum tube, but they all operate, with greater or less efficiency, on the same general principle. Figure 5 shows one such tube. Within the tube are three elements, illustrated in Figure 6, a filament, a grid, and a plate or wing. When in operation the filament is heated by current supplied from a battery. This may be four dry cells connected in series, which will give 6 volts, and would do for very limited use. By far the better plan is to use a 6 volt storage battery, which will easily justify its cost in the long run. A 6 to 10 ohm rheostat regulates the current from this battery, known as the A or filament heating battery.

You will note that the filament has two terminals while the grid and plate each have but one. To the grid terminal is connected a grid con-

denser (sometimes called a "stopping" condenser). The opposite terminal of the grid condenser is connected to the secondary winding of the loose coupler.

The wing terminal of the tube is connected

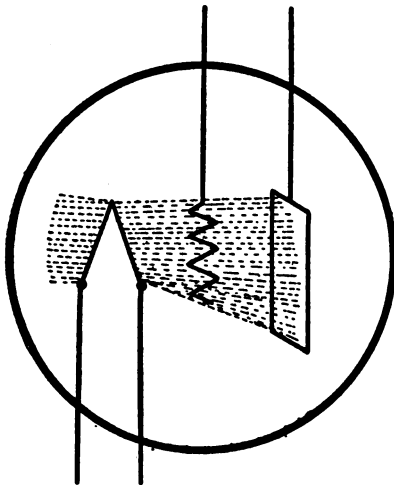

FIG. 6.—Diagram Showing the Three Elements in the Vacuum Tube, and the Conductive Path of Electrons between the Filament and the Plate.

through the telephone receivers, to the positive terminal (marked red or by the + sign) of the B battery. This battery may be secured in blocks containing fifteen flashlight cells already connected in series to give a total of  $22\frac{1}{2}$  volts, but tapped at several points to permit the voltage to



## RECEIVING WITH VACUUM TUBES 31

be regulated to suit the characteristics of the vacuum tube used.

From the negative terminal (marked black or by the — sign) of the B battery, a connection is made to the positive terminal of the A battery. This completes the wing or plate circuit from the plate to the filament. The same terminal of the

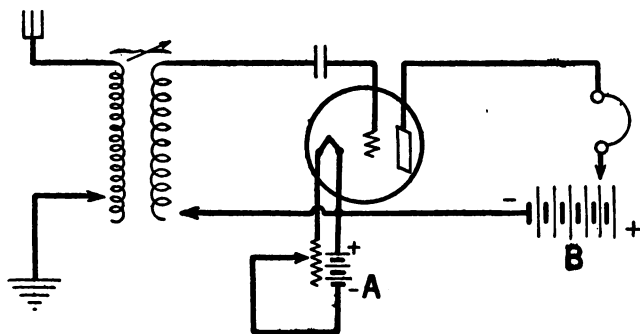

FIG. 7.—Diagram of Simple Vacuum Tube Receiver Set.

filament is also connected to the other end of the secondary inductance (loose coupler) completing the grid or secondary circuit.

In the same diagram you will also note a circuit embracing the antenna, the primary inductance (primary winding of the loose coupler) and the ground.

So we now have three distinct radio circuits,

the primary, secondary, and wing. (The A battery circuit is merely a filament heating circuit.)

Study Figure 7 until you have mastered these three circuits. They are fundamental to an understanding of vacuum tube receiving.

To get a simple understanding of the action of the tube in connection with other instruments, let us go through the operation of "tuning in" a signal.

Incoming energy is collected by the antenna, conducted to the primary of the loose coupler and thence to the ground. Let us assume that the message we wish to receive has a wave-length of 400 meters. This first, or primary circuit, as it is called, is varied by the number of turns of wire actively connected in the primary coil of the coupler. This is called the primary inductance. It is varied at will by a tap switch or a slide contact. Knowing the wave-length range of your receiving set, you can approximate the coarse adjustment or setting for the wave-length you wish to receive, varying the adjustment until the signal is heard.

It is assumed that the secondary has likewise been set to approximately 400 meters. We say approximately, as it will take a little practice and familiarity with your own set to determine the exact point or setting at which signals of a given wave-length will "tune in."

To bring the signal up to the maximum strength a little closer adjustment of both primary and secondary will no doubt be found to advantage.

Varying the number of cells in the B battery, as well as adjusting the rheostat on the A battery, will tend to improve the audibility of the signal.

Now, to get an idea of what is taking place, let us follow through the incoming oscillations to which our set is tuned, and which we are now receiving in the form of audible signals. The antenna circuit, consisting of aerial, primary and ground, is oscillating with the incoming energy, which is of a definite wave-length or frequency. The electric oscillations in the antenna system build up a magnetic field in this system. This magnetic field is stronger in the neighborhood of the primary coil. In order to transfer sufficient energy to the secondary or detector circuit it is necessary to bring the secondary coil near the primary. The distance which separates the two coils will determine the amount of energy which will be transferred from the primary to the secondary. The coils are said to be closely or loosely coupled, according as they are closer together or farther apart.

Now that the energy is in the secondary, which is connected to the grid of the tube, its oscilla-

tions impress a varying charge upon the grid, which, due to the grid's controlling action, causes changes in the current flowing in the plate circuit. As a matter of fact, the variations of current in the plate circuit are greater than the voltage variations in the grid circuit. This is why the vacuum tube is a more sensitive detector than the crystal. In tracing out the circuits in the diagram, you will find an apparent break with no direct connection between plate, grid and filament. One of the characteristics of the tube is that current will pass through the space between the elements in the tube when the filament is heated. In this manner the energy of the B battery flows through the phones to the plate, to the filament and returns to the B battery. This current, unless modulated by the incoming signal which is impressed on the grid as already explained, would flow uninterrupted, and without making audible signals in the phones. But the incoming energy impressed upon the grid varies, and its variations change the resistance in the path between the plate and the filament. This varying resistance causes variations in the current flowing through the phones, for you will note that the plate circuit is composed of B battery, phones, plate and filament. It is these variations in the amount of B battery current permitted to flow through the plate cir-

cuit, which cause the phone diaphragms to vibrate, and so produce audible signals.

Thus the message which was originated at the transmitting station is finally reproduced in our telephones in its original form of dots and dashes, speech, music, or other telephone communication.

If you will study Figure 7 closely and follow the foregoing description, you will find that the action of the three radio circuits is not nearly as complicated as it first appears to be.

While you may purchase, connect, and manipulate a receiving set without reference to this explanation, you will certainly find your work more fascinating and your results much clearer and more dependable if you master what is taking place in the three fundamental radio circuits. The process of "tuning in" will also be accomplished more intelligently and efficiently.

Our explanation thus far has given you one of the simple hook-ups for a tube set. You can improve your results by adding to this elementary set without complicating it to any marked degree, and with little additional expense. For more detailed information about the several instruments mentioned, you may refer to Chapter IX where each is fully described.

For better manipulation and sharper tuning, especially on the shorter wave-lengths, a series

condenser should be placed in the antenna circuit. This is generally one of the standard size variable condensers with a capacity of .001 microfarads, which may mean little to you beyond enabling you to define it. It consists of a number of fixed and movable metal plates; the latter controlled by a small knob and rotating shaft fitted with a pointer or other indicator reading to a dial marked in degrees. This condenser is inserted in series between the antenna and the primary winding of the coupler; that is, one terminal of the condenser being attached to the antenna lead and the other to the primary. In some instances it is placed in the ground lead, but the general practice is as stated.

Such a series condenser will not work well if your antenna is a very short single wire, say about 50 feet, as the condenser shortens the wave-length of the primary circuit.

In general practice the best results will be found when you use one-third to one-half of the condenser's capacity, and balance the circuit by adding or reducing the number of active turns in the primary inductance, in order to effect the sharpest tuning and minimize interference.

As has just been stated, the series condenser in the antenna circuit reduces its wave-length. If you desire to increase wave-length, you may do

so and put the condenser to a different use, by placing it *across* the terminals of your primary inductance. When in this position, at the zero point the increase of wave-length will be negligible, and as you rotate the knob increasing the capacity you increase the wave-length of the primary circuit.

When a condenser (often called "capacity") is used *in series* with the primary (or inductance), they bear a reciprocal relationship to each other. Increasing capacity will require decreasing the inductance, and vice versa, to maintain a given wave-length. Thus you will note we spoke a moment ago of "balancing" the capacity with the inductance.

In complete sets mounted in cabinets, the primary inductance is generally varied by steps including several turns of wire regulated by a tap switch. The finer adjustments in such cases *must* be made with a series condenser. Sometimes this series condenser is built into the cabinet, but it is usually a separate unit.

Figure 8 shows how the series condenser is added to the diagram shown in Figure 7.

In case you wish to increase the wave-length range beyond the normal limits of your receiving set, this can be done, as far as the primary circuit is concerned, by additional inductance in series

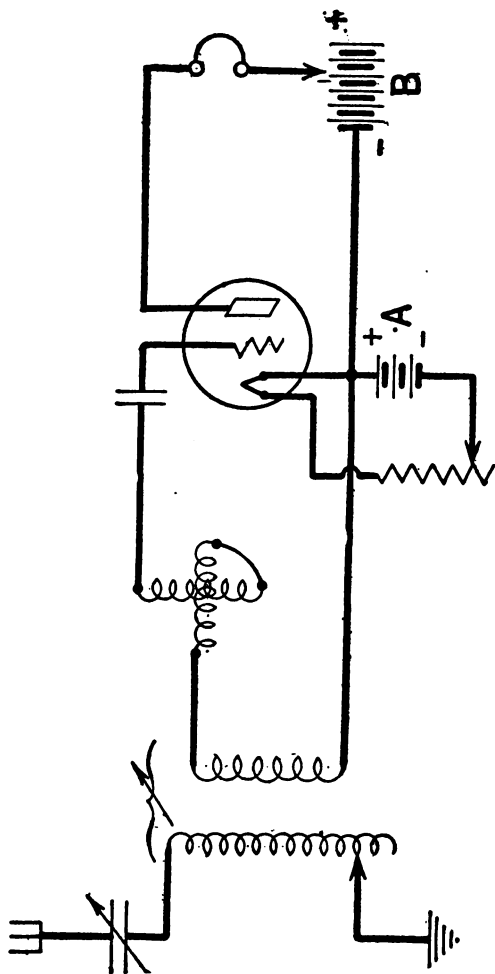

FIG. 8.—Diagram of Vacuum Tube Set with Series Condenser in Primary Circuit, and Variometer in Secondary Circuit.



with the primary circuit. This additional inductance may consist of loading coils, loading inductance, or a variometer. Any of these may be purchased in various sizes, suitable for wave-length ranges to suit your requirements. Should you desire, you can make loading coils by winding insulated wire on fibre or paper tubes, using the "cut-and-try" method to ascertain the size of the tube, and the size and number of turns of wire which work best with your other instruments.

We have already spoken of varying the secondary circuit, so that it may be tuned to the same wave-length as the primary circuit. There are several ways in which this may be done. The original loose coupler of the early days was varied by a tap-switch or by slide contacts. Some of the better and more modern radio sets are built with a fixed amount of inductance which is varied, as to its electrical wave-length, by a condenser across the terminals, or by adding more inductance in the form of a variometer in the secondary circuit. Some sets which are designed to cover a wide range of wave-length have a change-over switch which adds separate "lumps" of inductance, leaving the finer adjustments to be made with the condenser across the secondary terminals. The secondary condenser, when these extra lumps are added, takes a position so that the condenser is in

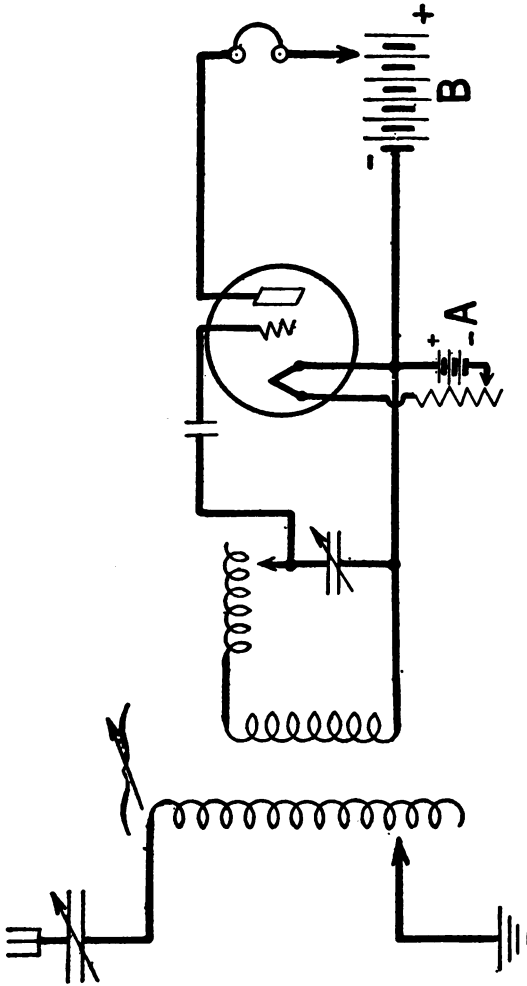

FIG. 9.—Diagram of Vacuum Tube Receiver Set, with Secondary Load, and Secondary Condenser in Shunt.

shunt with both the secondary and secondary load. (See Figure 9.)

On sets employing honey-comb coils, this change will generally be brought about by inserting a different sized secondary coil, of greater or less inductance.

Now with the elementary instruments, connections and adjustments described, you should, with a little practice, be able to receive very satisfactory signals within the possibilities of the vacuum tube set. Your signals, however, can be greatly strengthened, and your receiving radius greatly lengthened, by methods described in the two succeeding chapters.

## V

### REGENERATIVE RECEIVING

It must be borne in mind that the currents in the three radio circuits which we have been discussing are extremely minute. Therefore, any means which can be employed to increase them will tend to strengthen the signals. Experimenters are constantly endeavoring to find means to this end. Although some progress has been made, the future possibilities are wide open to everybody, and form one of the most interesting phases of radio experiment.

One such process, which has already been discovered and well developed, and has greatly advanced radio within a very few years, is the process of regeneration.

Figure 10 shows one method, known as inductive feed-back. A coil is introduced, usually similar to the secondary in diameter, and selected according to the wave-length to be received. It is connected in series with the other elements in the wing circuit. This coil is placed in inductive relation to the secondary of the coupler. The

changes in the current flowing in the wing circuit induce corresponding changes in the secondary circuit, which, when the coils are in proper relationship, greatly add to the strength of the signals being received. This coil is known as a feed-back, or tickler.

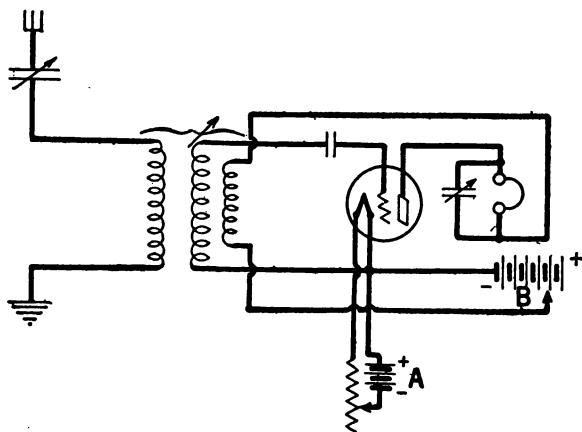

FIG. 10.—Diagram of Vacuum Tube Receiver Set, with Tickler Coil.

In operation the tickler coil is moved, varying its distance from the secondary coil, and so effecting a change in its inductive relation to it. When they are brought too close together a hissing sound will be heard in the phones. When too far apart, the signals will be diminished. The correct position can be found by trial. If there is no

effect when you bring the tickler close to the secondary, you have probably connected the tickler the wrong way, and reversing its polarity (so that the current will flow through the wire in the coil in the opposite direction) will correct it.

Another and more popular system of regeneration is shown in Figure 11. This is known as the tuned wing-circuit regenerator. In this case we do not use a tickler coil, but get the true regenerative effect by inserting a variable inductance into the wing circuit in the form of a variometer. The variometer is used to tune the wing circuit to the same wave-length, or, as it is commonly expressed, in resonance with the secondary circuit. This method offers some advantages. It is capable of extremely fine adjustments and also permits the use of the same instruments for a very wide range of wave-lengths.

You will find that in the wing circuit very delicate adjustments are required. The least amount of excessive inductance will cause a hissing, howling or singing in the phones, which can usually be eliminated by adjusting the variometer so as to reduce the inductance.

When used in the wing circuit, the variometer is not placed close or in inductive relation to the secondary, as was the tickler coil. Sufficient coupling is effected by the capacity between the

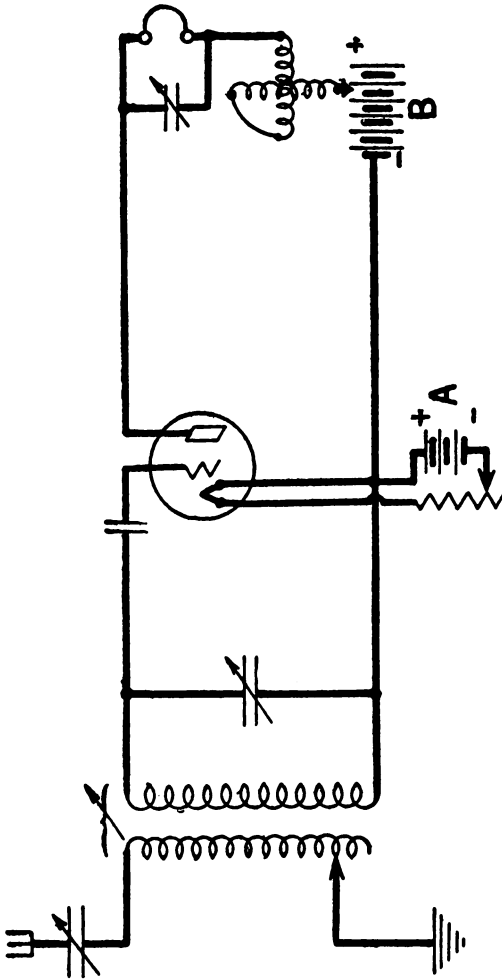

Fig. 11.—Diagram of Regenerative Receiver, with Variometer in Wing Circuit.

elements of the tube, and by the secondary and wing circuits being both connected to a common conductor, the filament line. Because of this coupling, the wing circuit regenerates or feeds back some of its energy into the secondary circuit. This increased energy strengthens the charge upon the grid, and thus in turn produces a stronger action in the tube, which results in louder signals.

In the circuit just described results will be more satisfactory if a small fixed or variable condenser is shunted across the phones.

When you have this regenerative receiving set either purchased or assembled, and hooked up ready to operate, throw your lightning switch (if you have one) so as to connect the instruments with the antenna. Before connecting the A battery, turn the rheostat, which is in series with the filament line, so that at least half of the resistance of the rheostat is in circuit. Now connect the A battery, or as is more convenient, have a switch by which to throw it on, so as to heat the filament. Do not burn the filament to excessive brilliancy. If on lighting the filament, you hear a hissing sound in the phones, reduce the current by adjusting the rheostat until the noise ceases and adjust the amount of B battery.

Turn the wing variometer to zero, or in case



you are using a tickler coil, swing it away from the secondary as far as it will go.

Turn the series condenser to about a third to half capacity, with the primary and secondary closely coupled (in the "pick-up" or "stand-by" position). Now adjust the secondary and primary variations of the coupler (tuner) until signals are heard.

The secondary being slightly more critical than the primary, will usually require a little final adjustment to get signals of maximum strength. At this point it will be well to loosen the coupling between the primary and secondary as much as the signal will permit. With a sliding coupler, this adjustment is the movement of the primary and secondary away from each other. In cabinet sets as usually made today, turning the knob rotates the secondary while the primary remains stationary. The zero point on the dial usually represents a point where the coils have the least coupling.

Now as we have changed the coupling, we have changed the relation of the primary and secondary to each other. Retune the secondary by moving the dial (or slider) very slightly one way or the other. This will bring back the signal strength to approximately the same intensity, or more than

you had before loosening the coupling. The object of loosening the coupling is to reduce interference from other stations on the same or nearly the same wave-length. You can tell only by practice when this is advisable and to what extent it is possible.

The next move will be a slight adjustment of the series condenser, or primary inductance as the case may be, to make sure that you are getting maximum signal strength so far as this adjustment is concerned.

Now adjust the filament current (A battery) and the number of cells actively in circuit in the B battery. Up to a certain point, which you can determine by trial, the more B battery voltage is used, the lower the filament current may be adjusted, which naturally will tend to lengthen the life of the filament. On the other hand, too much B battery will cause hissing in the phones, and will sometimes temporarily paralyze a tube. Some tubes throw off a light blue glow at this time, which is a sure indication of excessive B battery.

After several trials and adjustments of both batteries, and when you are satisfied that you have made the best possible adjustments, your signal is at its maximum strength. You have done everything possible with the simple or non-regenerative receiver.

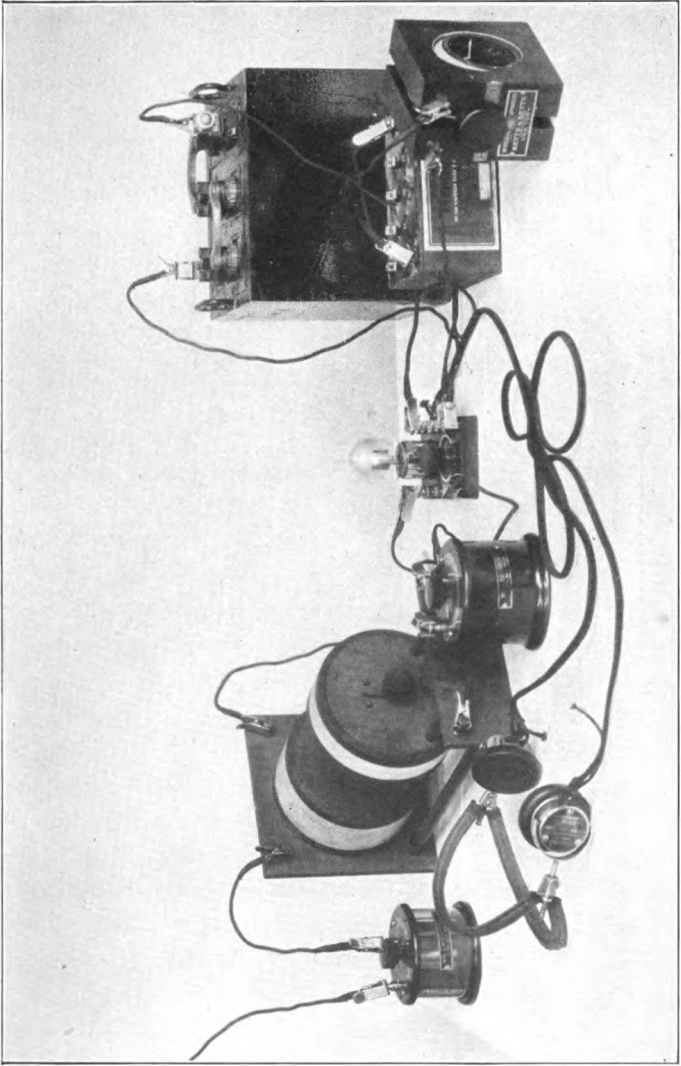

Fig. 13.—Receiver Set, Instruments Assembled by Amateur.

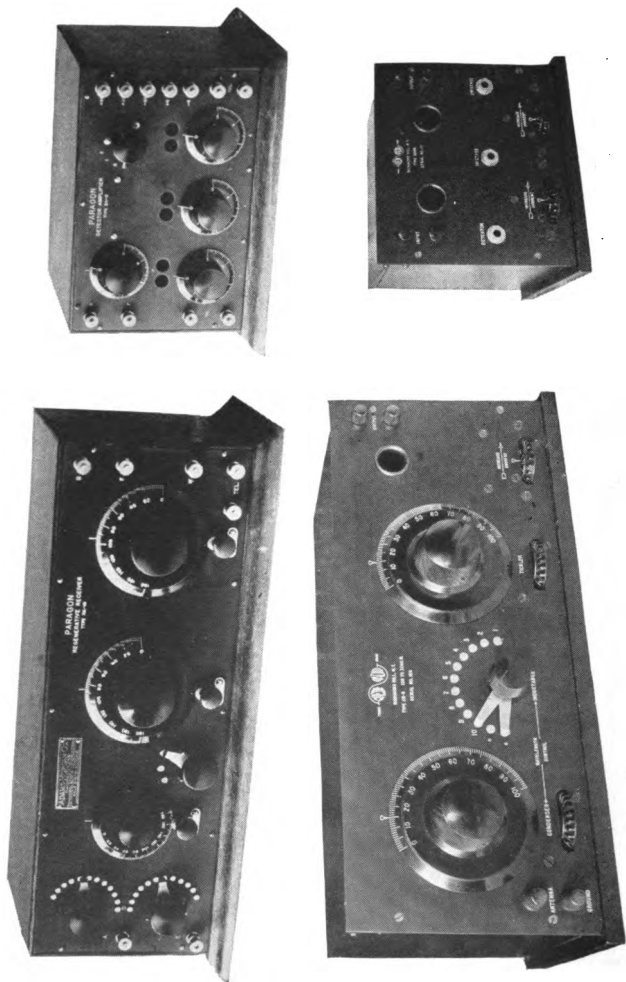

FIG. 14.—Receiver Sets, with two-stage Amplifiers.

With the regenerative set, however, it remains for you to tune the wing circuit. With this adjustment you should note a decided increase in the signal strength, as it will bring into play the regenerative feature of the set.

In the event of a receiver employing a tickler coil, your final adjustment will be to move it gradually toward the secondary coil. The received signal should then show an increase in strength. If you pass the critical point and bring the coil too close, so that a hissing sound is heard in the phones, draw it back gently until the noise ceases.

With the tuned wing circuit regenerative set, with a variometer in the wing circuit as shown in Figure 11, increasing the effective inductance of the variometer will increase the signal strength. Too much inductance will cause a hissing in the phones. When this occurs, drop back a few degrees on the variometer, until the signal is at its maximum strength and of true tone.

This should give a signal strength of from 100 to 200 times the strength of the signal obtainable with a non-regenerative receiver. A signal which you could not hear at all with a non-regenerative receiver will be heard loud and strong with a regenerative receiver.

Now you begin to realize one of the great advantages of a tube set over a crystal set. You

will see further advantages of the tube in the chapter following this one.

Our detailed description of the process of tuning may strike you as rather long. It will pay you, however, to follow it closely and begin your experience with painstaking attention to details. When using a well-designed regenerative receiver, you will be amazed to see what great changes in signal strength are effected by very slight adjustments of the instruments. The most amazing thing of all is that you can take music and other signals "right out of the air." To do this is worth some attention to details. As you become more familiar with your set, you will find it much like riding a bicycle—a bit ticklish at first, but soon becoming second nature.

## VI

### AMPLIFICATION

UP to a certain point, the operation of the receiving set described in the previous chapter is satisfactory and sufficient. It will bring in both telephone and telegraph signals clearly, and receive them at a very much greater distance and in greater volume than the crystal detector. It is but human, however, for us to be unwilling to accept limitations. We want greater distance, we want louder signals, we want the whole family and a roomful of friends to hear.

These things can be accomplished by means of amplification. This requires the addition of a few simple units to our receiving set, varying according to the number of steps or stages of amplification and the number of tubes to be used.

One stage will show a marked increase in the strength of both the telephone and telegraph signals. Two stages will be sufficient for all use including the best telephone signals provided you wish to use only head phones. To produce signals which will fill a moderate sized room you will re-

quire two or possibly three stages and a loud speaker. Under good conditions this last named equipment would supply sufficient volume to fill a church or a public hall. For a large public gathering you will require a special loud speaker designed to produce more volume and capable of carrying more energy than one which you would ordinarily use in the home.

For the addition of one stage to the already complete regenerative receiver as described in Chapter V, you will require an audio frequency transformer, a tube control consisting of socket and rheostat, an amplifier tube, and also one or two additional blocks of B battery. You can purchase a single step amplifier complete, or you may purchase the units and assemble them yourself.

Figure 15 shows the method of connecting. The tube required for amplification varies slightly in construction from the one used as a detector. While either tube can be used for either purpose it is not advisable to do so. In purchasing specify an *amplifier* tube. The principal difference is that the amplifier tube is pumped to a higher vacuum and requires a slightly higher voltage of B battery. In the slang of radio it is termed a "hard" tube.

You will note from the diagram that the amplifier requires a B battery. This is similar to



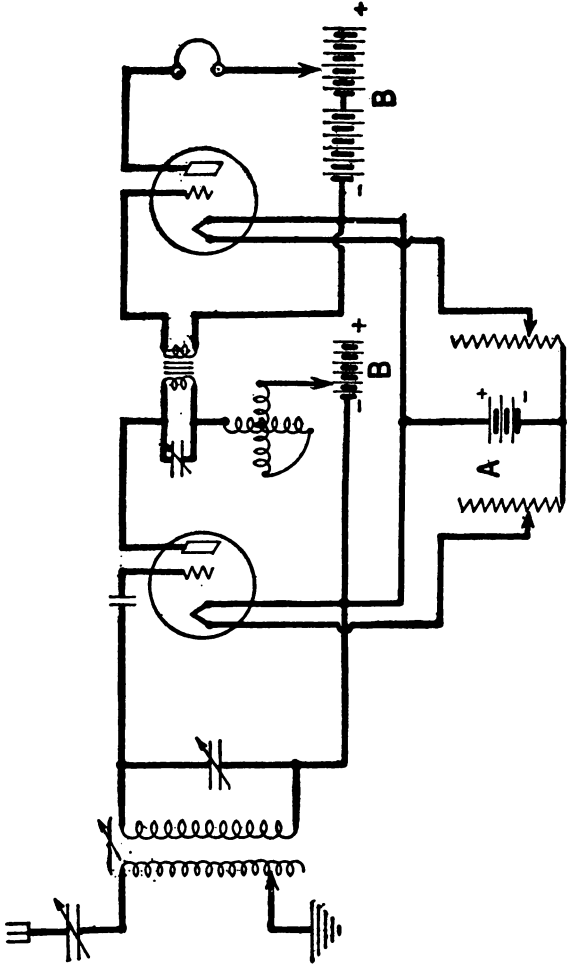

FIG. 15.—Diagram of Receiver Set, with One-Stage Amplifier Using Two Separate Blocks of B Battery.

the B battery used with the detector tube, and similarly connected. But the amplifier tube requires a higher voltage, and you had better start with two blocks of B battery in the amplifier circuit, varying the voltage to suit your particular tube as shown by trial. As a rule the B battery regulation is not as critical on the amplifier tube as on the detector.

Adjust the filament current, which may be supplied by the same storage battery as the detector tube, in the same manner.

You will see in the diagram that no grid condenser is required in the amplifier circuit.

In wiring the amplifier circuit, remove the telephones from the detector and in their place connect the two terminals of the primary of the audio frequency transformer.

Leave your condenser which was shunted across the telephone terminals, so it will now be shunted across the primary of this transformer. You will find the terminals of the transformer usually marked Primary and Secondary or P and S.

For best results, the outside end of the primary winding of the transformer is connected to the *plate* of the detector tube, and the outside end of the secondary winding is connected directly to the *grid* terminal of the amplifier tube. By examin-

ing the transformer closely you can see from which terminals the outside and inside ends of the two windings lead.

From the other secondary terminal, connect to the filament of the amplifier tube as shown in the diagram. Connect the A battery to the filament terminals, placing the rheostat in series with one of the filament wires, in the same manner as was done with the detector tube. Telephones are connected in the wing circuit of the amplifier tube in series with the additional amplifier B battery.

Careful adjustment of the A and B batteries is essential to secure maximum signal strength. In this, like other radio circuits, be careful that your wires are well insulated and all connections well made. The positive terminal of the B battery is *always* connected to the wire leading to the plate—in this case through the phones.

There are a number of different makes of amplifier transformer from which you may choose. For telephonic reception, a transformer whose ratio of secondary turns to primary turns is not greater than 4 or 5 to 1 is generally used.

Thus far we have discussed amplification as if it were always of only one kind. As a matter of fact there are two kinds of amplification, used in radio receiving, quite distinct and not to be con-

fused. Radio frequency amplification builds up the radio energy of the incoming signal *before* it has been rectified or detected.

Audio frequency amplification builds up audible frequency current *after* the signal has been detected. For the present purposes this is the only amplification which should be considered, as radio amplification leads into more apparatus and more complex circuits and is not essential to the ordinary receiving of signals such as the beginner will desire. We mention it here so as to post you wherein the difference lies. The time may come when you wish to experiment with radio frequency amplification, and then it is common practice for the experimenter to use one, two or three stages of audio frequency amplification in addition to his stages of radio frequency amplification. So you see it will be much simpler and very satisfactory for the beginner to master audio frequency amplification up to three stages before attempting to branch out into the more complicated field.

In laying out the diagram for Figure 15 we purposely indicated a B battery of two blocks separate from the detector B battery, to make the whole hook-up easy to grasp. As a matter of fact a common B battery composed of two or three blocks connected in series is ordinarily used in

practice to supply wing voltage to both detector and amplifier tubes. See Figure 16. Most manufacturers of detector and one and two stage amplifier sets, wire their outfits so that the total voltage of the B battery is applied to the amplifier and detector. A variable tap connects at suitable points of the battery, to supply the necessary plate voltage for the detector tube.

While the signals in the telephones will now seem very strong, you may without experience imagine that you have sufficient energy to put in a loud speaker. A word of caution here may avoid disappointment if you expect a loud speaker to reproduce, from the energy you have on hand, in volume sufficient to fill a room and be clearly audible. Bear in mind that head phones may take a feeble signal and make it seem loud, because they are pressed close to your ears. That is exactly what head phones are for. Most loud speakers are in reality only other types of telephone receivers. They cannot be expected to deliver loud signals unless supplied with sufficient energy. One stage of amplification will hardly do this except in rare cases and under conditions which you have no right to count upon.

Cabinet sets are offered by different manufacturers in so many varieties and combinations that no rule should be laid down to govern your prog-

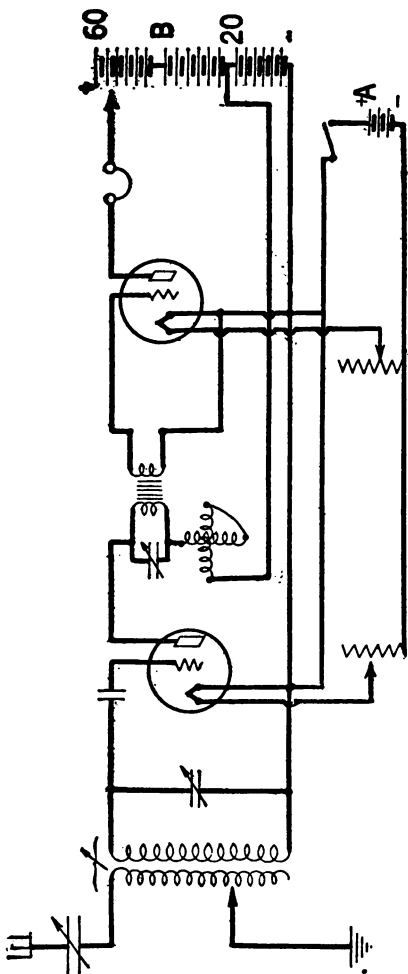

Fig. 16.—Diagram of Receiver Set, with One-Stage Amplifier Using Common B Battery on both Detector and Amplifier.

ress through the several stages of amplification. Some sets come with a detector only, some with a detector and one, two or three stages as the case may be. Separate amplifier cabinets are also furnished, with one and two stages. So, if you have started with a cabinet receiver set, you may simply decide which amplifier cabinet you wish to purchase and connect it up according to the instructions furnished with it. As you add to your set you will do well to purchase all your cabinet units of the same manufacture. Your set will then be more symmetrical in appearance. Besides, each manufacturer makes units which have some relation to each other, and even though the differences may appear slight, your chances of uniformly good results will be better if all your cabinet sets or units have that family relationship.

Even though you are using a cabinet set, however, your interest and pleasure will be greatly increased, and your appetite for experiment will be encouraged, if you understand what is going on inside the cabinet, and such knowledge is still more important if you are purchasing separate units and assembling them yourself. So we are considering the stages of amplification separately, as though you are adding them to your equipment, one stage at a time.

Passing from the first stage to the second, you will require the same additional equipment. That is, a transformer, socket, rheostat and amplifier tube. The same B battery which you already have for the detector and first stage is sufficient also for the second stage, provided you wish to use head phones only. See Figure 17.

Now that you have two stages in operation, there are one or two points worthy of close attention. Keep all wires connecting the instruments as short as possible and avoid parallel wires, especially those leading to grid or plate. At the same time there is such a thing as having the transformers placed too close together, resulting in a howling or whistling sound in the phones. If this is experienced, move the transformers so as to be fully six inches apart, and set at right angles to each other.

A little refinement which you may add if you are assembling the set, and which is included in some of the cabinet sets, is a potentiometer. This is a high resistance, wired in as shown at P in Figure 17. You will note that it is shunted across the A battery line. The terminals from the ends of the resistance are connected to the positive and negative A battery wires. The center terminal, or one connected to the slider, is run to the negative side of the B battery. The potentiometer in ac-



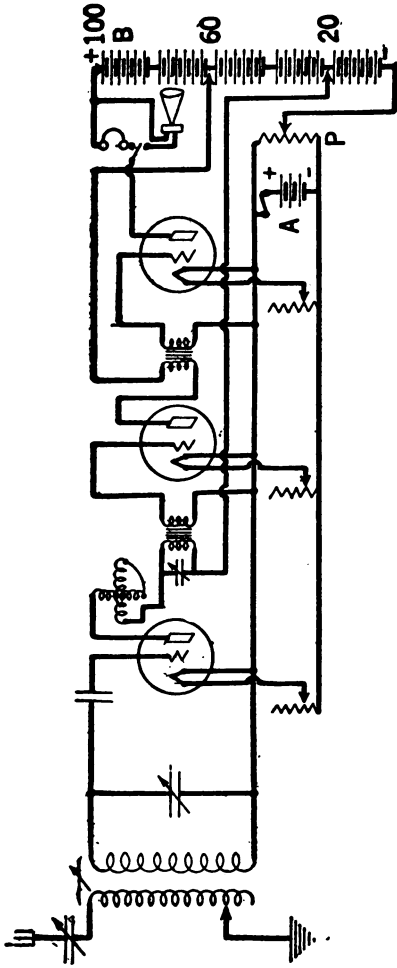

FIG. 17.—Diagram of Receiver with Two-Stage Amplifier, with Common B Battery, and Including Potentiometer and Optional Phones or Loud Speaker.

tion is nothing more or less than a micrometer adjustment of the B battery voltage.

A potentiometer across the A battery line consumes some energy even when the tubes are not in operation, unless you insert a switch to disconnect the A battery from the apparatus when not in use. Such a switch is a convenience anyhow.

Another place where a potentiometer may effectively be used is shown in Figure 18. Here it is connected in a manner that will put a negative potential on the grid of the amplifier tube, tending to further increase the strength of the signal. This will be appreciated particularly when you use a loud speaker, and require the highest possible degree of signal strength.

In using a loud speaker with a two or three stage amplifier, the strength of the signal tends to increase with increased voltage put into the plate circuit of the last stage. Some tubes will stand up to 150 or 200 volts.

For audio frequency amplification, which we are dealing with, two stages are all that will be ordinarily required. It is questionable whether you will care to go beyond this stage, particularly in your early experience.

To the uninitiated, it may seem that if two stages will give good loud signals, three should give still louder. While this is partly true, it is

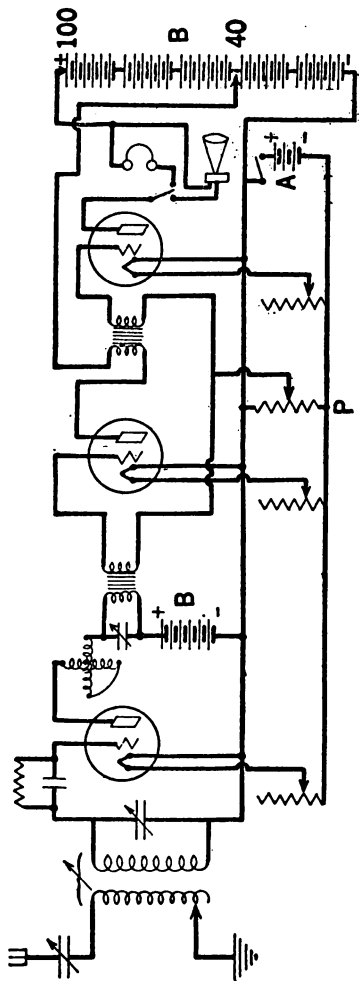

Fig. 18.—Diagram of Receiver with Two-Stage Amplifier, Potentiometer Wired So As to Effect a Negative Potential on the Grid, and Optional Phones or Loud Speaker.

subject to modifications. We must bear in mind that the air is not a clear track for our signals only, but also carries many electrical currents and disturbances. It is also charged at different times with static or atmospheric electricity, which is the outlaw of the air.

In the third stage of amplification, this and other disturbances seem to be magnified out of proportion to the desired signals. Perhaps before this book is very old, means will have been found to correct this. At the present writing, however, we would advise the beginner to content himself with two stages of audio frequency amplification.

In case you desire to use the third stage, taking advantage of the periods of unusually clear atmosphere, to demonstrate the extreme possibilities of volume of signals in your loud speaker, the third stage will require the same additional equipment and be hooked up in the same manner as the second stage was added to the first.

On adding the third stage you may experience noises such as howling, whistling or excessive buzzing. You may be able to stop these noises by making the several adjustments already described. In case these adjustments do not quiet the circuit, you can nearly always do so by using a separate B battery for the detector tube, and

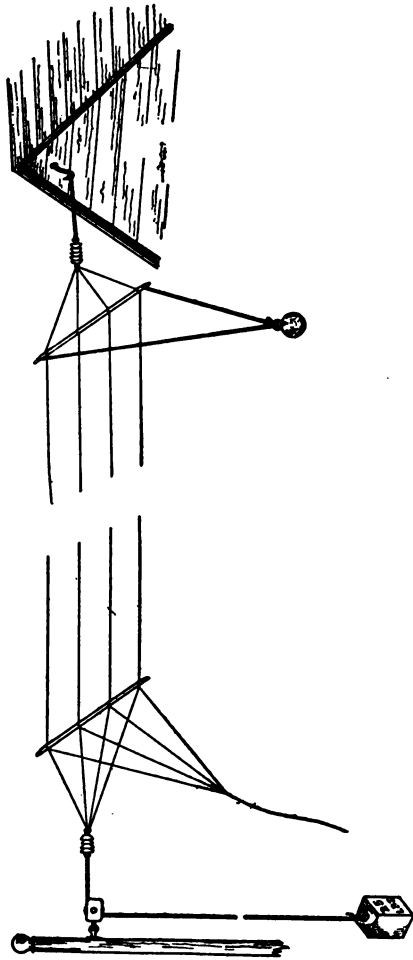

FIG. 19.—A Good Type of Aerial for Most Ordinary Conditions.

hooking the three stage amplifier to a common B battery.

Still another quieting influence will be to place a condenser of large capacity in shunt, that is, connected across the terminals of the amplifier B battery. The condenser generally used for this purpose should be of about 1 or 2 micro-farads capacity. One admirably adapted is the style commonly used in telephone work.

Some experimenters, as a last resort, when experiencing extreme trouble with howling in the amplifier, will connect one terminal of the A battery to the ground lead.

If these suggestions fail to quiet the howling, you had better go back over all connections and adjustments, including varying the amount of B battery, as you have without doubt overlooked some detail of the foregoing instructions.

## VII

### CONSTRUCTING THE ANTENNA

FOR purposes of the foregoing chapters, we have assumed that your antenna has been erected and in operation. This part of your equipment is too vital, however, to be passed over lightly.

If your antenna is already erected, you may read this chapter merely to check up your own work and experience. Possibly you will find details in which you may make improvements and so obtain better results.

If you have not yet constructed the antenna, then you will do well to follow this chapter closely, bearing in mind the great importance of even the little details in giving you the best results.

Before purchasing your antenna materials, look over your situation carefully so as to determine the most advantageous form and position for the aerial. As in other features, opinions differ widely, but you will be safe in following a few general suggestions which have been well proved in practice.

For the aerial, it is of primary importance to have height, length, and freedom from obstructions. Yet there is no absolute formula of measurements which must be followed, and many conditions make every location a law unto itself. It is an advantage to have a clear, unobstructed space about your aerial, particularly in the direction of the station from which you expect principally to receive. As far as possible, keep away from metal smoke-stacks and steel constructed buildings, unless the aerial is swung well above them. If you are on high ground you will not need so great an elevation above ground as would be required for a low-land location. You may find a good line from the top of your house to the top of a barn or neighboring house, or to a flag pole or a mast erected in the yard for the purpose, or to a tree, water tower or other elevated object. If a tree, measure with sufficient slack for swinging in the wind, and measure so that the live wires of the aerial will not extend in among the branches of the tree, but will end well outside, being supported by a rope or wire carefully insulated from the aerial and leading in to the trunk of the tree.

If a chimney will give you increased height, use it. A mast or pole above the house, barn or chimney will improve your final results.



Keep the aerial clear of electric light, telephone, telegraph or other wires. Do not parallel such wires unless you absolutely must, in which case keep as far as possible from them, certainly not less than twenty-five feet. If you must cross such wires, keep well above or below them. Never under any conditions cross your aerial wires over high tension lighting wires, nor fasten the aerial or any of its supports to poles or trees carrying such wires.

Figure 20 illustrates several types of antenna in common use. Everything considered, the inverted L or the T style are to be recommended for beginners, as they are simple to construct and erect, and very efficient. Of course, if you are so situated that you can elevate only one end, you have no choice but to adopt the vertical, or sloping, type and get the greatest elevation possible. In the city many amateurs have found good results from a single wire 100 to 200 feet long, suspended just above the flat roof of an apartment house or office building and supported at both ends sufficiently high to prevent folks from hanging clothes on it. For receiving wave-lengths in the vicinity of 200 meters (amateur sending stations) it will be better to make the combined length of aerial and lead-in about 150 feet if a single wire, and if two or more wires are used,

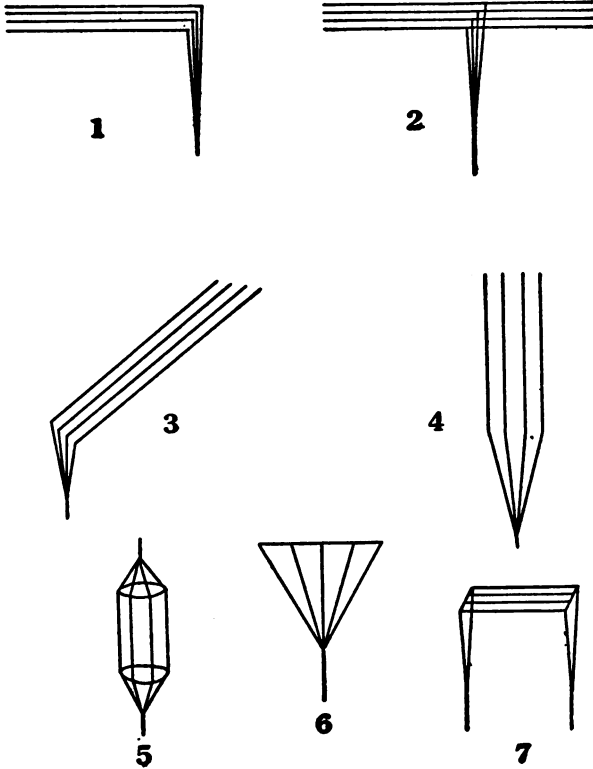

**1** Inverted L

**2** T Type

**3** Sloping

**4** Vertical

**5** Cage

**6** Fan

**7** U Type

**FIG. 20.—Various Types of Aerial.**

about 125 feet. In speaking of the length of the aerial, we refer to the distance between the end insulators, and not the combined length of all the wires in the aerial.

If your station is to be midway between the ends of the aerial you will adopt the T type. In this case the effective length is measured by adding the length of the lead-in, the vertical portion of the aerial and half the length of the flat top, provided the vertical portion is in the exact center of the flat top as it should be.

In general, two or more aerial wires are preferable to a single wire. For average use, including receiving the telephone broadcasting and all amateur signals, an admirable aerial will be of the flat-top or inverted L type, consisting of from two to four wires, in which the total length of aerial and lead-in is not less than 100 feet, nor more than 250 feet.

Contrary to a common misunderstanding, you may take some liberty in the selection of wire for the aerial. Many have the impression that aluminum wire is desirable, but it has the great disadvantage of being difficult to solder, and all joints in the aerial *should* be soldered. Iron wire, whether bare or copper coated, is also to be avoided. Some sort of copper or phosphor bronze wire is much to be preferred. It may be of almost

any size, but the extreme small sizes have hardly sufficient tensile strength to "stay put," and the large sizes are heavy and expensive. The most suitable sizes will be from 14 to 18 gauge B&S.

Phosphor bronze and hard drawn copper wire

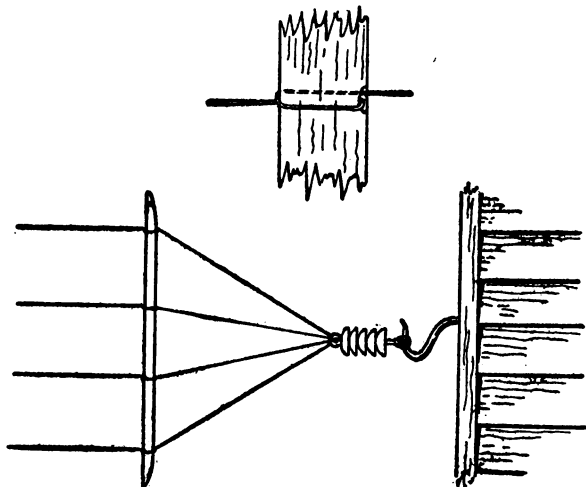

FIG. 21.—Ends of Antenna Wires Led Together.

have good tensile strength and will not stretch appreciably, while soft drawn copper will stretch from six to eighteen inches per hundred feet of length, and must be rigged to make this allowance. Should you have on hand wire which is insulated, you may use it, as the insulation will

not interfere with its operation provided all joints are properly made as explained later.

If you intend using the aerial for transmitting as well as receiving, you will do well to use stranded wire of hard drawn copper or phosphor bronze. This generally comes in the form of a cable made up of seven strands of 21 gauge B&S.

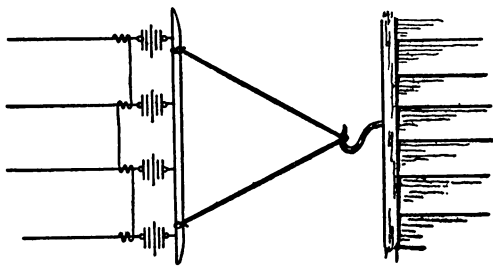

FIG. 22.—Ends of Antenna Wires Insulated and Bonded.

It will be quite necessary for satisfactory transmitting but is not needed for receiving.

In laying out the aerial, care must be taken to make all the wires of the same length. All wires must be thoroughly insulated from supports, and swing so as not to touch any other object. Some authorities advise bonding the antenna wires together at the free end or ends, either by leading them to a common ending in an insulator and soldering them together, as in Figure 21 or else by ending them in separate insulators and join-

ing them with a bond soldered to each wire, as in Figure 22. Others prefer to leave the ends free, as in Figure 23. This is purely a matter of opinion and in either case you will not go wrong.

The rat-tail is formed either by bringing the several antenna wires together and leading them into the station, or in case the antenna wires end in insulators, a separate wire is twisted and

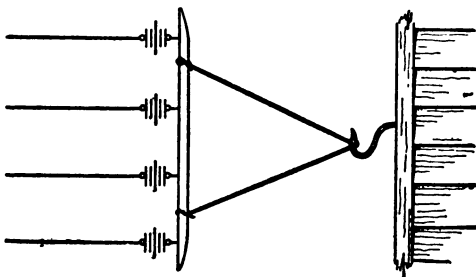

FIG. 23.—Ends of Antenna Wires Left Free.

soldered to each of the antenna wires and led together to form the rat-tail. Bring the wires together for the rat-tail not too abruptly, but let them come together at least several feet from the antenna wires. Solder them securely where they come together.

Do not neglect the soldering of joints. It will save you much trouble and disappointment later on. Every home should have a good soldering outfit anyhow. It is literally worth its weight in

gold. If you once learn the joy of a small electric soldering iron, you will never be without one. While speaking of tools, a good pair of pliers, or several pairs of different sizes, and a pair of side cutting pliers are indispensable.

In carrying the wires into the station, avoid sharp turns, keep the lead-in away from the building and all other objects, and use a good insulator at each support. Where entering the house, a regulation moulded bushing is desirable for receiving and usually required by the underwriters if the station is to transmit. A common porcelain tube will do for a receiving station. Figure 24 shows several kinds of insulators.

For receiving only, the rat-tail may be fastened and soldered to a single lead-in wire. For transmitting, however, the lead-in should be a prolongation of *all* the wires in the rat-tail, and continue with this full set of wires by way of the lightning switch, right up to the instruments, or else to a single wire whose surface is at least equal to the surface of all the antenna wires combined.

To protect against lightning and to comply with the fire regulations the lead-in for a station which is to transmit must be provided with a standard approved lightning switch, placed outside the building, where it can be reached and operated. The rat-tail is connected to the

center (or blade) terminal of the switch. The upper end of the switch is connected to the final lead-in wire (see above for size) which carries right up to the instruments. The lower end of the lightning switch connects with the ground. No. 4 copper wire must be used for this connection. Lead this No. 4 wire to the earth *outside* of the building, supporting it with suitable insulators. The ground itself may be a sheet or plate of copper or zinc at least two feet square, to which the No. 4 wire must be heavily joined and soldered, and the plate buried in the ground deep enough to be in constantly moist earth. Instead of the plate you may drive an iron pipe three or four feet into the ground and securely fasten and solder the No. 4 wire to it.

When operating, throw the switch so as to connect the aerial with the instruments. At all other times, leave the switch connected with the ground.

A lightning switch is not insisted upon in stations for receiving only, but the National Electric Code permits an approved Lightning Arrester with a  $\frac{1}{8}$  inch gap. The atmospheric electricity (lightning) will jump this gap and take the shortest route to the earth.

Where these instructions are followed closely, the antenna becomes in fact a protection, as lightning will follow this metallic course rather



than strike a building or other less conductive object.

When you are ready to build the aerial, measure off a distance on the ground equal to the distance between the proposed aerial supports. It will help greatly if you can drive a stake at each end, or find two posts, trees or other temporary supports between which you can lay out the aerial and put it together ready for erecting.

We will suppose you have chosen an aerial as shown in Figure 19. You will have prepared two spreaders of spruce or other light wood, long enough to keep the wires apart by a distance equal to about one-fiftieth the length of the aerial. The spreaders need not be very thick or heavy. If you care for appearances, taper them neatly and give them two coats of spar varnish or shellac. Drill small holes for the antenna wires to pass through, being careful to have the holes evenly spaced, and parallel.

Lash one of the end insulators to one stake, make an end of your antenna wire fast in this insulator and run out a length of wire to the insulator at the other end, returning so as to make two lengths of wire from insulator to insulator. These will be your two outside wires. Pass them through the outer holes in the spreaders, then halfway around the spreaders and through the

same holes in the same direction, so as to keep the spreaders from slipping. (See Fig. 21.) Be careful to have the length of the two wires the same between the spreaders.

Now put in the two middle wires in the same manner, being careful to draw all four equally taut, so that the whole set of wires will be equal in length and parallel.

Take four pieces of wire long enough to make a good easy rat-tail, or to continue to lightning switch, or into the station as already explained. Twist and solder one to each of the antenna wires close to the spreader on the near end as shown. Carry these four wires gradually together and twist and solder them. At the near end, the rat-tail will keep the aerial from twisting over in the wind. On the free end, suspend some small weight, such as a block of wood or a croquet ball, as shown in the sketch. This will keep the free end from twisting.

You are now ready to erect. The free end may be fastened with wire or rope, or hung in a stout hook or screw-eye. The near end should be hoisted with a block and fall, as illustrated, so that you may take up stretch, or lower for repairs or alterations. A very good plan is to hang a weight on the end of the rope, to give and take

as the weather causes the rope to shrink and stretch.

If your station is to be midway of the length of the aerial, you will select the T type, and all details will be similar, except that the rat-tail must be connected in the exact center of the length between spreaders.

Some operators have had varying success with a loop antenna. This is a four foot loop of No. 16 or 18 gauge B & S insulated wire, wound over a light wooden frame about four feet square, from five to twenty turns of wire being used, and the turns kept about an inch apart. This device has a remarkable directional effect, being fully efficient only when hung vertically and revolved until its plane is in line with the direction of the sending station. This form of antenna is capable of great use and experiment, but the beginner will do well to regard it as one of those interesting things to be taken up after he has mastered the more essential principles and processes. This type of collector is suitable for use only with several stages of amplification, as it collects only a very small amount of energy as compared with the elevated type of antenna.

The writers have secured very good results from an indoor antenna, where a clear stretch of

about fifty feet was available in an attic under a shingle roof. Six wires were fastened to the rafters, spaced three feet apart, and fully insulated.

We frequently hear of bed-springs, window screens, wire fences and other metallic objects being used as antennas. Part of the pleasure of radio is in trying new and odd things, and if you go in for "stunts" you will find no end of them, and learn much in the finding. For the early steps, however, and particularly until you learn to receive both the telegraph and telephone signals with regularity and satisfaction, and read the incoming telegraph code fairly rapidly, we advise you to follow the plans already suggested as being tried, proved and sure of good results.

## VIII

### GENERAL HINTS

**THERE** are many little things you can do, and little points you should know about, in order to make your practice of radio more satisfactory. A very large book would hardly contain all of them. But a few which may be easily understood may well be included here.

The foregoing instructions will, if carefully followed, show you how to master all of the problems ordinarily met during your beginning stage, with the exception of one. That one is "static." It may be termed the general atmospheric electricity, which is abroad all the time in greater or less degree, but not always troublesome. Its most troublesome demonstration is in the form of lightning. During an electric or thunder storm, do not attempt to operate your radio set, and if you have a lightning switch, be sure it stays in the ground position until the disturbance is surely past. At some times static is very bothersome, causing a rattling or grating noise in the phones

which makes the signals themselves almost inaudible or breaks into them with very rude interruptions. If you hear noises in your phones and are not sure whether they come from outside or whether they might be caused by some fault within your set, disconnect the instruments from the lead-in, and place the antenna line in contact with the ground. If the noise ceases, it must have been outside, probably static. If it does not cease, or greatly diminish, it is somewhere within the set.

You will often experience "interference"; that is, the interjection of signals other than those you wish to receive. Careful tuning will eliminate most all ordinary interference from a well-designed receiving set. In general, coupling loosened to the limit, small amount of capacity in the antenna condenser, and balancing with additional inductance, together with other adjustments already described, are your means of tuning out undesirable signals. If you are unfortunate enough to be near a transmitting station whose power and signal strength are many times greater than the more distant signals, for which you are tuned, you are literally "up against" it, until the interference ceases, especially if its wave length is near the one to which you are tuned. Here is your opportunity to experiment and endeavor to

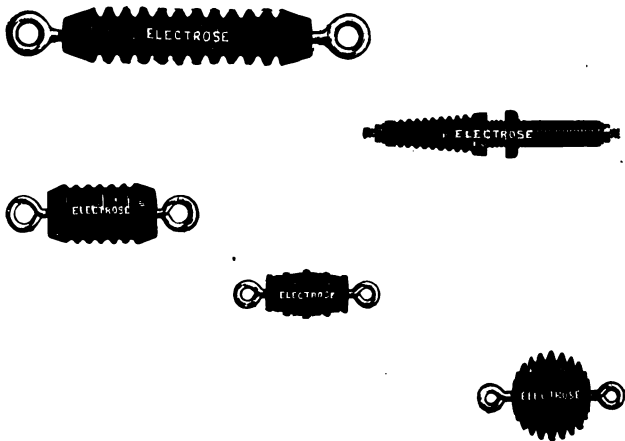

Fig. 24.



Fig. 25.



Fig. 26.

FIG. 24.—Various Types of Insulator.—FIG. 25.—“A” Battery.  
—FIG. 26.—“B” Battery.



Fig. 27.

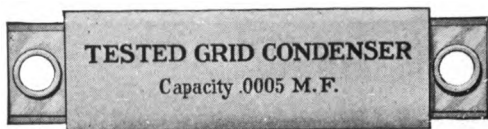

Fig. 28.

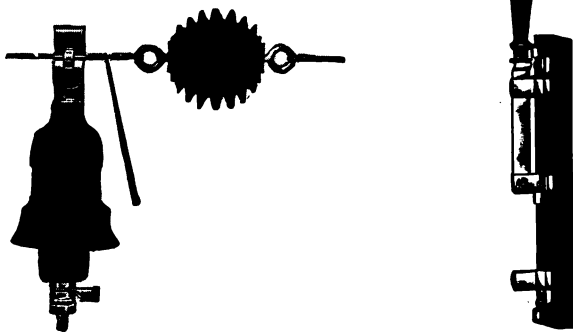

Fig. 29.

FIG. 27.—Condensers, fixed and variable, showing inside of the Variable.—FIG. 28.—Grid Leak.—FIG. 29.—Lightning Arrester and Lightning Switch.



find ways to eliminate interference to a greater degree.

You have noted our references to audio frequency and radio frequency. The term frequency is used in connection with any form of rhythmical motion, denoting the number of movements in a given time. In the case of electrical currents, the unit of time is one second. Audio frequencies are those in which the current makes less than 10,000 movements or cycles per second. Radio frequencies are those above 10,000 cycles per second.

Sometimes a little greater or less capacity across the phones will slightly improve your signals. A variable condenser is admirably adapted to this use, and will require a corresponding adjustment of the wing variometer. In a cabinet set, however, the phone condenser has probably been worked out to a nicety and had best be left alone.

In regulating the amount of capacity, or inductance, or current in the A battery, you will at first be amazed at the great difference effected by a very slight adjustment. Some sets are equipped with micrometer adjustments, as the direct action of the hand will often turn the knobs too far.

Bear in mind the importance of keeping all wires connecting your instruments as short as

possible, particularly the wire leading to the grid.

Avoid parallel wires, as far as you can, as the capacity between them may disturb your adjustments, and if your wires must cross each other, let them do so at right angles and keep them apart.

A whole book could be written about tight connections. Loose ones cause endless trouble. Unless wires are securely and tightly clamped to their proper connections they should be soldered. Often a wire is properly fastened to a binding post but the post itself is loose in its base, or the wire on the under end of it is not properly screwed or soldered down. Make a habit of placing the end of a wire around a binding post or other screw from left to right, so that tightening the screw will not tend to throw the wire out of place.

When "skinning" the ends of insulated wire, be sure to get a good bright metal surface on the wire, scraping it if necessary. For the sake of neatness, you may wrap the ends of the insulation with tape to avoid fraying. Some insulation is made of two layers wound in opposite directions, in which case the ends may be tied in a knot and clipped short, so as to prevent further unwinding.

Pay particular and *frequent* attention to the

terminals of your storage battery. The contacts should be clean and bright. A coat of vaseline will help to keep them so.

Always be sure your B battery is correctly connected, as a wrong connection may result in turning this high voltage loose where it would burn out a tube or do other damage while also exhausting itself.

Do not install your radio instruments in the cellar or other damp places. Moisture will surely harm them and impair their efficiency.

Bear in mind that radio frequency currents are very minute and very sensitive, and must be handled accordingly. Oilcloth acts as a conductor of these minute currents, and should never be used as a cover for your radio table. Use felt, or some sort of cloth, if you wish a cover. Black paint often contains lamp-black which is a conductor and will prevent proper operation of the instruments. Plain wood coated with shellac or varnish is free from this source of trouble.

Electric light wires or extension cords, when within a few feet of your receiving apparatus, will often induce sufficient current to cause an objectional hum, which you will note in your receivers.

All movable contacts, such as switch points and the contacts on a slide tuner, should be kept clean

and bright. If you have a lightning switch, occasionally clean the blade and both sockets, so as to insure a good bright metal contact.

While some cabinet sets come with sockets to hold tubes in a horizontal position, it is preferable to place tubes in a vertical position on account of a possible sagging of the filament within the tube. See that the contact points at the base of the tube are clean and bright, and that the spring contacts in the socket are clean and in good tension.

Your A and B batteries will not last indefinitely. You can tell when the A battery is running down, by the diminished glow in your tubes. You can have it re-charged for a small outlay, or if you have alternating current in your house, a small rectifier will enable you to charge it yourself. If your current is direct, you had best consult your local electrician or the makers or agents of the battery, who will advise you how to charge from direct current. Of course, if you use dry cells for A battery, they can be replaced with new ones. The condition of the B battery should be tested from time to time with a small voltmeter. If each block registers a full  $22\frac{1}{2}$  volts it is still in condition to use. When it falls appreciably below, it should be replaced with a new block.

For many purposes, you will find flexible cord preferable to wire for making connections. Com-

mon lamp-cord will do. In purchasing, get the kind in which the two cords may be separated by untwisting, as some kinds have a woven cover holding the two cords together. To keep the fine wire ends from getting snarled, and to insure a good connection, remove the insulation for half an inch from the end, clean and twist the fine wires together and solder.

Test clips, attached to the two ends of flexible cord, are very handy for temporary or changeable connections. The clips themselves are like a "tie clasp," only larger and stronger. Fasten the ends of the flexible cord to the clips by soldering. Keep a dozen or more of these clip-cords on hand, in various lengths.

If you intend doing anything more than merely buying a set, connecting it, and listening—you should by all means provide yourself with a soldering outfit, and use it freely. Whether of the electric variety or not, you will be surprised to see how easy it is to make fine tight connections. Use soft solder, which comes in small strips. Do *not* use acid, but use rosin or some form of patent flux such as Solderall or Nokorode.

By all means learn the telegraph code. It will open up to you a great many interesting things. With a little study you can readily memorize the code, and then with practice you can read the

telegraph signals as well as the telephone. For practice in listening to the dots and dashes you can get a little buzzer, or make one out of a door bell. Let us emphasize this telegraph business—it will greatly repay you.

Every licensed radio station has a call signal. The official list is published in book form by the government. One book gives the commercial and government stations, and a separate book lists the amateur stations. Each book is sent post paid for fifteen cents. Write to the Superintendent of Documents, Government Printing Office, Washington, D. C.

When you begin to think of transmitting telegraph or telephone, and wish to post yourself regarding the method of procuring the necessary license, such information may be had by addressing the Radio Inspector, Bureau of Navigation, Department of Commerce, Washington, D. C., or you may write to the Radio Inspector of your district. The division by districts is shown in the Call Book.

## IX

### DESCRIPTION OF INSTRUMENTS

IN this Chapter are given more complete descriptions of the principal units mentioned in previous chapters of this book, and their practical operation in the radio circuits already covered. You will do well to pay particular attention to the operation of a vacuum tube, as this is the heart of the radio receiver. It is one of the smallest, yet one of the greatest developments of this highly inventive age.

*"A" Battery:* In all vacuum tubes it is necessary to employ some means to heat the filament to incandescence. This is usually accomplished by means of a battery of dry cells or a storage battery. A battery used for this purpose is known as an A Battery.

*Aerial:* The elevated portion of an antenna.

*Amplifier:* A device for increasing the intensity of signals received. It usually consists of an amplifier transformer, an amplifier Vacuum Tube and socket, a rheostat to control the filament current, and batteries. One such assembly is called a single step or single stage amplifier. Several

such stages may be employed, each stage progressively amplifying the signal. When so connected, the several amplifiers are said to be connected in Cascade.

*Antenna:* That portion of the apparatus which is used to radiate electromagnetic waves from a transmitting station and to collect them at a receiving station. It consists of the aerial and its supports, rat-tail, lead-in, lightning switch and ground connection.

*"B" Battery:* A battery consisting of a number of dry cells in series, used to supply the energy to the wing or plate circuit of vacuum tubes. It may be had in blocks containing a number of cells with taps at convenient points to allow the use of various voltages. These blocks are usually made in units of  $22\frac{1}{2}$  volts.

*Condenser:* A device for collecting and storing electrical energy, consisting of two conducting surfaces placed close together and separated by an insulator called the dielectric. For radio receiving three principal types are used: fixed, adjustable and variable. In a fixed condenser the capacity is not subject to alteration. In an adjustable condenser the capacity can be adjusted by steps. In a variable condenser the capacity can be varied from its minimum to its maximum by infinite degrees.



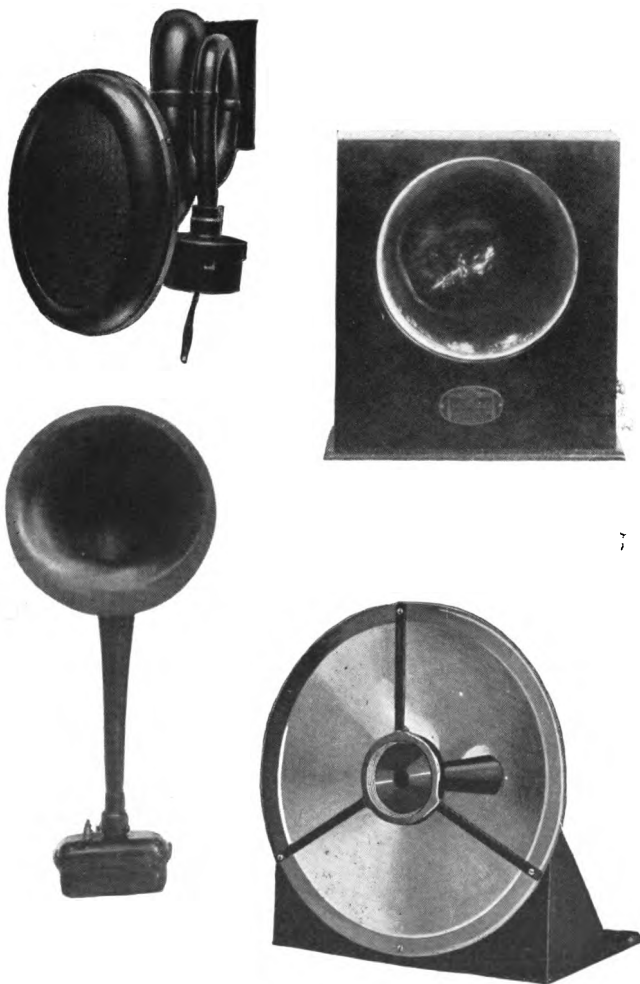

FIG. 30.—Types of Loud Speaker.

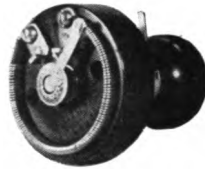

Fig. 31.

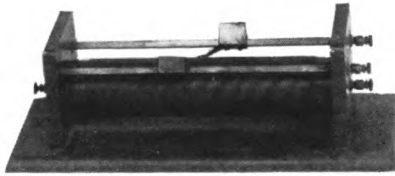

Fig. 32.



Fig. 33.



Fig. 34.

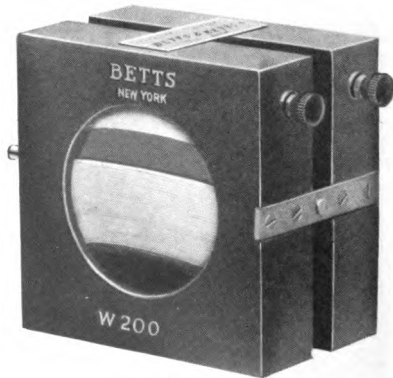

Fig. 35.

FIG. 31.—Rheostats.—FIG. 32.—Slide Tuner.—FIG. 33.—Potentiometer.—FIG. 34.—Types of Amplifier Transformer.—FIG. 35.—Variometer.

## DESCRIPTION OF INSTRUMENTS 91

*Coupler:* A device used to transfer radio frequency energy from one circuit to another by associating portions of these circuits. Same as Variocoupler, or Loose Coupler.

*Crystal Detector:* A form of detector of electrical oscillations employing a mineral crystal which allows electric current to pass more readily in one direction than the other. This changes the incoming signal from an alternating current to a pulsating direct current which will operate the telephone receivers.

*Detector:* A device which connected in a radio receiving circuit changes the incoming energy into a form which can be made audible.

*Grid Leak:* A high resistance path from the grid to the filament of a vacuum tube to allow excessive charges of electricity to pass off the grid.

*Honeycomb Coil:* A type of multiple layer coil so wound that its distributed capacity is at a minimum. These coils are useful where a high value of inductance is desired in a small space.

*Lightning Switch:* A large single pole double throw switch which is used to connect the antenna to the instruments in a radio station or to the ground for protection against lightning. Required for transmitting stations and desirable for receiving stations.

*Loading Inductance:* A coil of wire introduced into a radio circuit to increase its wave-length.

*Loop Antenna:* This device is described in Chapter VII.

*Loud Speaker:* An instrument for making radio signals audible without the use of head telephones. It usually consists of an enlarged form of telephone receiver to which is attached a horn whose acoustic properties still further amplify the signals.

*Potentiometer:* A high resistance with a sliding contact, put in "shunt" across a source of current. Used in vacuum tube receiving circuits to obtain a fine or micrometer variation of the voltage applied to the plate or to the grid.

*Regenerative Receiver:* A type of radio receiver in which the oscillating currents in the plate circuit are caused to feed back and thereby amplify the currents in the grid circuit. This has the effect of amplifying the strength of the signals being received.

*Rheostat:* A resistance for regulating the flow of current in a circuit. Used in radio receiving circuits to regulate the current in the filaments of vacuum tubes.

*Slide Tuner or Tuning Coil:* An inductance coil in which the variations of inductance are obtained by one or more sliding contacts.

## DESCRIPTION OF INSTRUMENTS 93

*Tap Switch or Dial Switch:* A rotary switch making connection with a series of contacts usually arranged in radial form on a panel, wired to inductance or battery so as to vary it by steps.

*Transformer:* An apparatus for changing a current at one voltage into a current of a different voltage. These are termed "step-up" or "step-down" according as they increase or decrease the voltage. The amplifier transformers used in audio frequency amplification are "step-up" transformers.

*Vacuum Tube:* A glass tube from which the air has been exhausted and which contains three elements or electrodes insulated from each other. These elements are known as the Filament, Grid, and Plate (or Wing.) The filament occupies the central portion of the tube and the grid is placed between the filament and the plate.

The filament has two external terminals so that it may be heated by the current from a battery. The other elements have one external terminal each and are required to remain cold.

For convenience in connecting the tube in various circuits it is mounted in a four-prong base with a bayonet lock. This base fits into a standard socket where the proper connections are made to the four prongs by means of spring contacts. When the filament is heated sufficiently it gives

off electrons which form a conductive path between the elements within the tube. This path is conductive in one direction only and therefore the tube has the characteristics of a rectifier and is so used in radio receiving circuits. When a

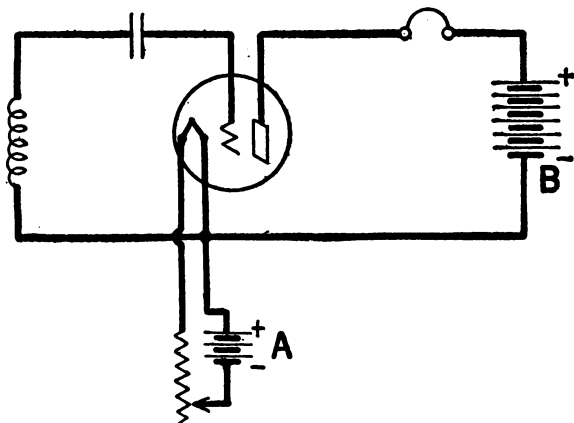

FIG. 35.—Diagram Showing Operation of Vacuum Tube.

current is flowing in this path between the filament and the plate it may be varied by changing the electrical state of the intervening grid. A slight change in the electrical state of the grid will cause a great change in this current. Due to this characteristic the vacuum tube is also used as an amplifier. Figure 35 shows a vacuum tube connected in a circuit which is used merely to

illustrate its operation. The stream of electrons flowing between the filament and the plate, caused by the heating of the filament by the "A" battery, completes the "B" circuit. As has been stated, any change in the electrical state of the grid will cause a change in the current flowing in the "B" circuit. Therefore, if an incoming signal is impressed on the grid its variations will produce correspondingly greater variations in the current flowing in the "B" circuit, which in turn will cause the telephone diaphragms to vibrate and produce audible signals. Due to its amplifying characteristics the vacuum tube is a more sensitive detector than the crystal detector.

A vacuum tube is commonly called a V. T.

*Variometer*: An instrument for producing an infinitely fine variation in the inductance of a circuit in which it is included. It usually consists of a movable coil arranged to rotate within a fixed coil. When the variometer is so adjusted that the current in both coils flows in the same direction the effective inductance of the variometer is greatest. When the movable coil is rotated through an arc of 180 degrees from this position the current flow in the two coils is opposite in direction and the effective inductance of the variometer is at a minimum. Between these two extremes is an infinite possibility of adjustment.

# INTERNATIONAL MORSE CODE

1. A dash is equal to three dots.
2. The space between parts of the same letter is equal to one dot.
3. The space between two letters is equal to three dots.
4. The space between two words is equal to five dots.

A • — — —

B — — — • • •

C — — — • — — — •

D — — — • •

E •

F • • — — — •

G — — — — — •

H • • • • •

I • •

J • — — — — — — — —

K — — — • — — —

L • — — — • •

M — — — — —

N — — — •

O — — — — — — — —

P • — — — — — •

Q — — — — — • — — —

R • — — — •

S • • •

T — — —

U • • — — —

V • • • — — —

W • — — — — —

X — — — • • — — —

Y — — — • — — — — —

Z — — — — — • •

1 • — — — — — — — — — — —

2 • • — — — — — — — —

3 • • • — — — — — — —

4 • • • • — — — — —

5 • • • • •

6 — — — • • • •

7 — — — — — • • •

8 — — — — — — — • •

9 — — — — — — — — — •

0 — — — — — — — — — — —



Period.....	• • • • •
Comma.....	• — • — • —
Interrogation .....	• • — — • •
Exclamation point.....	— — • • — —
Apostrophe.....	• — — — — •
Hyphen.....	— • • • • —
Parenthesis.....	— • — — • —
Double dash.....	— • • • —
Distress Call.....	• • • — — — • • •
Attention call to precede every transmission..	— • — • —
General inquiry call.....	— • — • — — — • —
From (de).....	— • • •
Invitation to transmit (go ahead).....	— • —
Question (please repeat after .....)—inter- rupting long messages.....	• • — — • •
Wait.....	• — • • •
Break (Bk.) (double dash).....	— • • • —
Understand.....	• • • — •
Error.....	• • • • • • •
Received (O. K.).....	• — •
Position report (to precede all position mes- sages).....	— • — •
End of each message (cross).....	• — • — •
Transmission finished (end of work) (conclu- sion of correspondence).....	• • • • • —

## LIST OF ABBREVIATIONS TO BE USED IN RADIO COMMUNICATION

ABBREVIATION.	QUESTION.	ANSWER OR NOTICE.
PRB	Do you wish to communicate by means of the International Signal Code?	I wish to communicate by means of the International Signal Code.
QRA	What ship or coast station is that?	This is .....
QRB	What is your distance?	My distance is ..... degrees.
QRC	What is your true bearing?	My true bearing is ..... degrees.
QRD	Where are you bound for?	I am bound for .....
QRE	Where are you bound from?	I am bound from .....
QRG	What line do you belong to?	I belong to the ..... Line.
QRH	What is your wave length in meters?	My wave length is ..... meters.
QRJ	How many words have you to send?	I have ..... words to send.
QRK	How do you receive me?	I am receiving well.
QRL	Are you receiving badly? Shall I send 20? .....	I am receiving badly. Please send 20.
	* * * * *	* * * * *
QRM	Are you being interfered with?	I am being interfered with.
QRN	Are the atmospherics strong?	Atmospherics are very strong.
QRO	Shall I increase power?	Increase power.
QRP	Shall I decrease power?	Decrease power.
QRQ	Shall I send faster?	Send faster.
QRS	Shall I send slower?	Send slower.
QRT	Shall I stop sending?	Stop sending.
QRU	Have you anything for me?	I have nothing for you.
QRV	Are you ready?	I am ready. All right now.
QRW	Are you busy?	I am busy (or: I am busy with .....). Please do not interfere.
QRX	Shall I stand by?	Stand by. I will call you when required.
QRY	When will be my turn?	Your turn will be No. ....
QRZ	Are my signals weak?	Your signals are weak.
QSA	Are my signals strong?	Your signals are strong.
QSB	Is my tone bad?	The tone is bad.
QSC	Is my spark bad?	The spark is bad.
QSD	Is my spacing bad?	Your spacing is bad.
QSE	What is your time?	My time is .....
QSF	Is transmission to be in alternate order or in series?	Transmission will be in alternate order.
QSG	.....	Transmission will be in series of 5 messages.
QSH	.....	Transmission will be in series of 10 messages.
QSJ	What rate shall I collect for .....	Collect .....
QSK	Is the last radiogram canceled?	The last radiogram is canceled.
QSL	Did you get my receipt?	Please acknowledge.
QSM	What is your true course?	My true course is ..... degrees.
QSN	Are you in communication with land?	I am not in communication with land.
QSO	Are you in communication with any ship or station (or: with .....)?	I am in communication with ..... (through .....
QSP	Shall I inform ..... that you are calling him?	Inform ..... that I am calling him.
QSQ	Is ..... calling me?	You are being called by .....
QSR	Will you forward the radiogram?	I will forward the radiogram.
QST	Have you received the general call?	General call to all stations.
QSU	Please call me when you have finished (or: at ..... o'clock)?	Will call when I have finished.
*QSV	Is public correspondence being handled?	Public correspondence is being handled.
QSW	Shall I increase my spark frequency?	Please do not interfere.
QSX	Shall I decrease my spark frequency?	Increase your spark frequency.
QSY	Shall I send on a wave length of ..... meters?	Decrease your spark frequency.
QSZ	.....	Let us change to the wave length of ..... meters.
QTA	.....	Send each word twice. I have difficulty in receiving you.
	.....	Repeat the last radiogram.

\*Public correspondence is any radio work, official or private, handled on commercial wave lengths. When an abbreviation is followed by a mark of interrogation, it refers to the question indicated for that abbreviation.

## WIRE TABLE

GAUGE. B. & S. No.	DIAMETER. In Inches.	FEET. Per Pound.	POUNDS. Per 1,000 Ft.
0	.324	3.130	319.45
1	.289	3.947	253.34
2	.257	4.977	200.91
3	.229	6.276	159.32
4	.204	7.914	126.35
5	.181	9.979	100.20
6	.162	12.584	79.462
7	.144	15.869	63.013
8	.128	20.009	49.976
9	.114	25.229	39.636
10	.101	31.821	31.426
11	.090	40.120	24.924
12	.080	50.590	19.766
13	.071	63.794	15.674
14	.064	80.441	12.435
15	.057	101.436	9.859
16	.050	127.12	7.819
17	.045	161.29	6.199
18	.040	203.374	4.916
19	.035	256.468	3.899
20	.031	323.399	3.094
21	.028	407.815	2.452
22	.025	514.193	1.945
23	.022	648.452	1.542
24	.020	817.688	1.223
25	.017	1031.038	.969
26	.015	1300.180	.769
27	.014	1689.49	.609
28	.012	2067.364	.483
29	.011	2606.959	.383
30	.010	3287.084	.300
31	.008	4414.49	.241





3 2044 049 156 771