

RADIO PHONE RECEIVING

A PRACTICAL BOOK
FOR EVERYBODY

D. VAN NOSTRAND COMPANY
NEW YORK

From the collection of the

o P^zreⁿL^minger^a
v Library
t p

San Francisco, California
2006

slav4

CP

15-

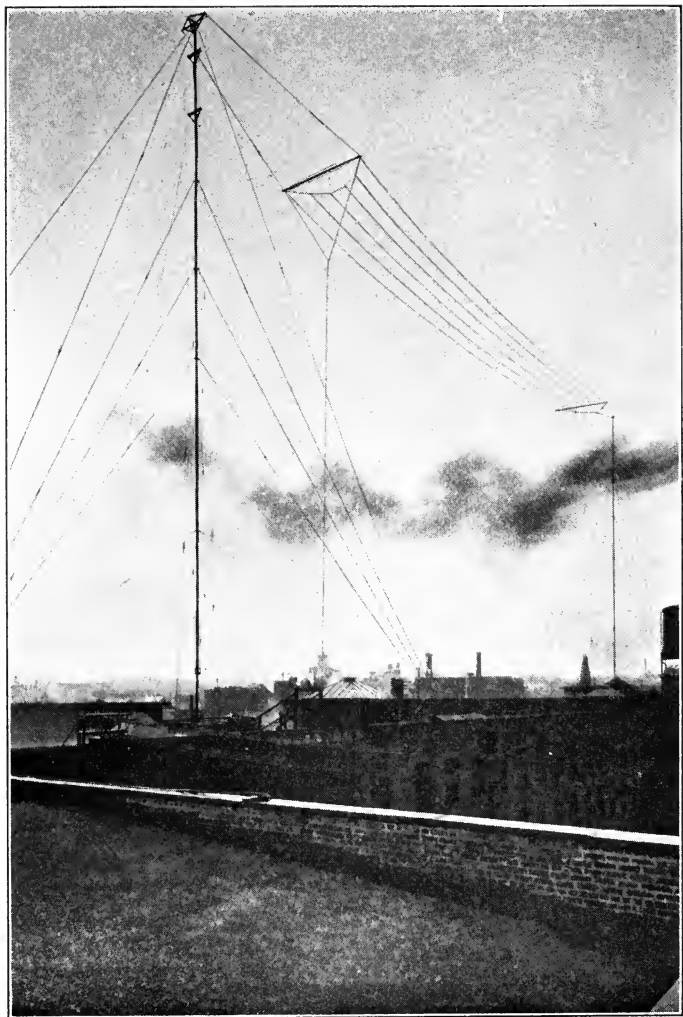

Antenna of the Newark Broadcasting Station.

RADIO PHONE RECEIVING

A PRACTICAL BOOK FOR EVERYBODY

BY

ERICH HAUSMANN, Sc.D., EDITOR

*Professor of Electrical Communication, Polytechnic Institute
of Brooklyn*

ALFRED N. GOLDSMITH, Ph.D.

Professor of Electrical Engineering, College of the City of New York

LOUIS A. HAZELTINE, M.E.

Professor of Electrical Engineering, Stevens Institute of Technology

JOHN V. L. HOGAN

Consulting Engineer; Past-President, Institute of Radio Engineers

JOHN H. MORECROFT, E.E.

Associate Professor of Electrical Engineering, Columbia University

FRANK E. CANAVACIOL, E.E.

Instructor in Electrical Engineering, Polytechnic Institute of Brooklyn

ROBERT D. GIBSON, E.E. AND PAUL C. HOERNEL, E.E.

Engineers, Western Electric Company

WITH AN INTRODUCTION BY

MICHAEL I. PUPIN, Ph.D., Sc.D., LL.D.

Professor of Electro-mechanics, Columbia University



NEW YORK
D. VAN NOSTRAND COMPANY
8 WARREN STREET
1922

COPYRIGHT, 1922

By D. VAN NOSTRAND COMPANY

*All rights reserved, including that of translations into
foreign languages, including the Scandinavian*

PREFACE

The widespread interest in radio telephone communication, which has been aroused during the last year, has created a demand for a book which describes in a simple manner the methods and apparatus used for the reception of radio phone speech and music. The authors of this little volume, experienced both in the practice of the art of radio communication and in its exposition to students and non-technical audiences, have coöperated to meet this demand.

While many of the technical details of the subject are complex, nevertheless a satisfactory understanding of the operation of a radio transmitting and receiving system can be obtained without the use of mathematical formulas and complicated physical concepts. By analogies taken from everyday experience, by using relatively few technical terms, and by repetition of the more important ideas, the authors of the several chapters believe they have completed a logical and coördinated presentation of the subject in a style suitable alike to the layman, the novice and the amateur radio enthusiast. The reader will find distributed through the text a number of practical hints and the answers to questions which often arise in the operation of radio receiving sets. Some of these, of course, may be omitted on a first reading and be referred to later when specific difficulties are experienced.

The editor desires to express his appreciation of suggestions tending toward greater clearness of exposition which he received from his colleague, Professor E. J. Streubel. The editor also wishes to record his appreciation of the encouragement obtained from Mr. C. E. Speirs, Vice-President of D. Van Nostrand Company, whose belief in the need of a non-technical explanation of radio telephony inspired the writing of this book, and of the splendid coöperation of Mr. E. Eichel, of the same company, in preparing the manuscript for the press.

ERICH HAUSMANN

POLYTECHNIC INSTITUTE OF BROOKLYN,
April, 1922.

CONTENTS

	PAGE
INTRODUCTION	1

CHAPTER I

HOW RADIO TELEPHONING IS ACCOMPLISHED

The Nature of the Sound of Speech and Music	7
How Sound Passes from Speaker to Listener, or Audio Telephony	11
Wire Telephony; or How Electric Currents Carry Speech ..	13
What Light Is; or the Electromagnetic Wave	18
Invisible Light and the Radio Wave	20
The Modulation and Control of the Radio Wave	27
Vocal Control or Modulation of the Radio Wave	29
Radio Telephone Reception; or Hearing Changes in the Radio Waves	32
What the Radio Telephone Transmitter Must Accomplish	35
What the Radio Telephone Receiver Must Accomplish	36

CHAPTER II

TUNING THE SIMPLE RECEIVING CIRCUIT

The Antenna as an Electric Circuit	40
The Resistance and Inductance of the Antenna	45
How Tuning Is Accomplished	48
Sharpness of Tuning	51
Practical Methods of Tuning	54

CHAPTER III

RECEIVING THE WAVES BY CRYSTAL DETECTORS

Why a Detector is Necessary to Translate the Waves	58
Characteristics of Crystal Detectors	60
Coupled Circuits	65
Coördination of the Elements of the Detector Circuit	69
Typical Crystal Detector Set	73

	PAGE
Interference	75
Types of Antennas	78

CHAPTER IV

THE VACUUM TUBE

What the Vacuum Tube Is	81
Characteristic Curves of the Three-Electrode Tube	88
Action of the Tube with No Grid Condenser	92
Action of the Tube with Grid Condenser	97
Improvement in Action of Tube by Use of Grid Condenser	102
Possibility of Eliminating Batteries	103
Approximate Ranges of Receivers	105

CHAPTER V

AMPLIFYING THE MUSIC OR SPEECH

The Problem of Amplification	108
The Vacuum-Tube Amplifier	109
The Multi-Stage Amplifier	116
Transforming the Electrical Energy into Sound	120
Suiting the Loud Speaker to Its Audience	124
Concerning the Operation and Care of the Amplifying Equipment	125
Distortion	129

CHAPTER VI

REGENERATIVE AND HETERODYNE RECEPTION

The Several Functions of the Three-Electrode Vacuum Tube	132
Regeneration Without Oscillation for Increasing Response in Telephone	134
Regeneration as a Cause of Oscillation	136
Synchronous Heterodyne Method of Radio-Telephone Reception	139
Non-Synchronous Heterodyne Method of Radio-Telegraph Reception	143
Noises Due to Local Causes in Vacuum-Tube Receivers	146
Interference and Atmospheric Disturbances	150
Radio-Frequency Amplification	155
Super-Heterodyne Method of Reception	160

CHAPTER VII

RADIO TELEPHONE BROADCASTING

	PAGE
What Broadcasting Is	163
The Physical Characteristics of Radio, in Their Relation to Broadcasting	164
Contrast Between Broadcasting and Point-to-Point Systems	166
Radio-Telephone Transmitting Apparatus	168
A Typical Broadcasting Station	171
Essentials of Radio Broadcasting	175
The Extent of Radio Broadcasting	177
The Public Value of Radio Broadcasting	178

INTRODUCTION

BY MICHAEL I. PUPIN, PH.D., Sc.D., LL.D.

Professor of Electro-mechanics, Columbia University;
Fellow, American Institute of Electrical Engineers,
and American Association for the Advancement
of Science.

No art has ever made so rapid a progress as has the Radio Art. Starting about a quarter of a century ago with modest beginnings, employing most elementary means of exciting motions of electricity, it is today one of the most beautifully equipped among the electrical arts. The equipment is the fruit of scientific invention, research, and development achieved during the recent years of the still young life of the Radio Art, and this equipment is so simple that even people with very modest scientific training can handle it effectively. Hence the wonderful success of radio broadcasting.

It is just eighty years since Joseph Henry showed at Princeton, that electrical motions are, under certain conditions, oscillatory, and that the effects of these oscillatory motions are transmitted to a considerable distance. Thirteen years later William Thomson formulated mathematically the conditions for oscillatory electrical motions, showing that electricity in motion overcomes certain reactions which are governed by the same laws as the reactions experienced by the motion of a material mass. The force with which the Radio Art operates is derived from rapid oscillatory motions of electricity.

The work of Henry and Thomson became the subject of many scientific investigations, but none of them were as fruitful as the experiments performed by Professor Heinrich Hertz, first published in 1887. Professor Righi of Bologna was one of the most successful followers of Hertz, and at one time had in his laboratory, as a student in Physics, Guglielmo Marconi. This young Italian found by trial that an electrical oscillator, consisting of an upright wire connected to ground, transmitted electrical motions to a distance beyond that of the ordinary oscillators which were employed ever since the time of Henry; and more than that, he found that another upright wire connected to ground was the best means for detecting these electrical motions at a distance. The means for producing powerful electrical motions, and the means for detecting them at a distance were known, and Marconi employed them. This was the beginning of wireless telegraphy. It was a very modest beginning indeed, and one marvels how Marconi ever managed to persuade the conservative government officials of Great Britain and Italy to pay any attention to his very novel but quite crude method of electrical communication. But a youth's vision and burning enthusiasm are irresistible.

The energy of the electrical motion excited at the sending end in Marconi's grounded upright wire is transmitted into space and along the surface of the earth at a very high rate; hence that motion is like the motion of air excited by the crack of a whip. The writer and others suggested modifications which transformed these explosive electrical motions into more or less damped oscillations. Electrical tuning at the receiving end came into use

about twenty years ago, when the Marconi Company took over the writer's inventions relating to electrical tuning. Selectivity was thus introduced into wireless reception and it eliminated some of the objections to this new form of electrical communication. Rectification of the received electrical oscillations by crystals of asymmetrical conductivity, or by the writer's balanced electrolytic rectifier, was the next advance in the art; these methods laid the foundation to the present splendid method of rectification, without which the modern practice of the Radio Art would be impossible.

The introduction of dynamo-electric machines for generating oscillating electrical forces of a very high pitch was one of the most powerful stimulants to the progress of the Radio Art. This was done about ten years ago by the General Electric Company of Schenectady. Ernst F. W. Alexanderson, the designer of this historical generator, displayed the same burning enthusiasm of youth which Marconi did when the Radio Art was born. The other most powerful impulse came from Lee De Forest's discovery of the audion tube. This vacuum tube, perfected by research work in the laboratories of the General Electric Company and of the Western Electric Company, marks the beginning of the latest and greatest epoch in the Radio Art. Without it many of the most powerful aids in the present practice of the Art would be impossible. Utilizing the feed-back circuit of E. H. Armstrong, the vacuum tube has become a generator of oscillating electrical forces of any desired frequency or pitch, and indeed promises to replace every other type of generator in the Radio Art, and to place that Art upon a founda-

tion never dreamed of by its admirers of several years ago.

These wonderful advances in the Radio Art during very recent years have succeeded in making it a personal servant to everybody who wishes to take advantage of this remarkable service. And who will refuse it?

It will be admitted that intercommunication between persons is one of the most fundamental operations in human life. No method of intercommunication has ever enabled man to reach by his living word thousands and thousands of his fellowmen in many distant places at the same time until the Radio Art arrived. Now it can be done, and it is done. Just imagine a Henry Ward Beecher preaching one of his soul-stirring sermons to thousands and thousands of persons who, like one single congregation, are listening to it in many distant places, in churches and in homes, and anywhere under God's heavenly vault! Is there a poet or a philosopher sufficiently daring to prophesy all the blessings which will be our share when this mode of transmission of the living word is universally adopted? But, will it be adopted? This question will be answered by the countless numbers who have already engaged the service of the Radio Art. The answer will be — yes, if the service is good. But it will be good, just as incandescent electric lighting became good, when people embraced it and made it a part of their daily life.

In a democracy like ours no art can do its utmost which is not supported by the great mass of the plain people; and no art will get that support which does not give in return that service which merits the support. Those who know the Radio Art and have

watched each step in the history of its development feel confident that its scope will become national and be of intense interest to everybody. It will perform faithfully the service which it is destined to perform, and which no other method of intercommunication can perform. The Radio Art is here to supplement the other older arts of communication, not to replace them.

This book intends to tell the simple story of the Radio Art, and its pages are addressed to that very numerous class of people who are not experts, but who are anxious to engage the service of the new Art. If this intention succeeds, the book will gain many new friends for the Radio Art. The support of its friends will soon raise it from its present high level to even a higher level.

CHAPTER I

HOW RADIO TELEPHONING IS ACCOMPLISHED

BY ALFRED N. GOLDSMITH, PH.D.

Professor in Charge of Electrical Engineering, The College of the City of New York; Director of the Research Department, Radio Corporation of America; Secretary and Fellow, Institute of Radio Engineers; Fellow, American Institute of Electrical Engineers.

The Nature of the Sound of Speech and Music.

— It might be expected that a reasonably clear understanding of the operation of a radio telephone transmitting and receiving system would be difficult in view of the complexity and unusual nature of the methods employed. Such is fortunately not the case; and it is believed that, by the use of a few simple analogies based on everyday experience, a satisfactory comprehension of this new and marvelous application of electricity will be readily attained.

Whenever a disturbance of any sort is produced in the air, the air in the neighborhood of the disturbing body is compressed and a wave of compression spreads out in all directions. The air itself, in bulk, does not move outward in every direction; but only a spherical region of compression advances. If one imagines a constantly expanding spherical soap bubble, the surface of which repre-

sents a region where the air is compressed, one has a fair idea of the nature of the sound wave produced, for example, when the hands are clapped together. It is an effect not unlike the spread of the circular ripples in a pond except that the sound wave, traveling in all directions, is spherical instead of circular. In the case of the water ripple, the water does not travel in bulk, but the movement occurs only at the circular region where the water is piled up into the ripple. This is called a travelling wave, and the distance it travels forward each second is its velocity. In the case of the sound waves, the velocity is about one-fifth of a mile a second which, while large, is still readily detectable. This fact is experienced when one watches the operation of a distant pile driver and notes the time which elapses between the arrival of the light waves which indicate the driving of the pile and the arrival of the sound waves which give the sound of the blow. The delay of the sound of thunder after the observation of the flash of lightning is another illustration to show how the velocity of sound may be observed.

When the body which produces a sound wave vibrates to and fro regularly, a series of expanding spheres of compression, one within the other, will be produced in the air, just as a cork bobbing on the water produces a family of expanding concentric ripples. The spheres of compression of the wave at any instant are called wave crests. Half way between the wave crests lie the wave troughs. In the case of the water waves these troughs are depressed as much below the surface of the water as the crests are raised above the surface. With sound waves, the troughs are regions where the air is not com-

pressed but, on the contrary, reduced in pressure, or rarefied.

The way in which sound waves travel from the speaker to the listener is shown in Figure 1. The vocal cords of the speaker vibrate, and start the waves of compression and rarefaction which are shown as expanding spheres in the figure. When these strike the ear drum of the listener, they cause it to vibrate, and as a result, they stimulate the terminals of the auditory nerves and the sensation of sound is produced in the brain of the listener.

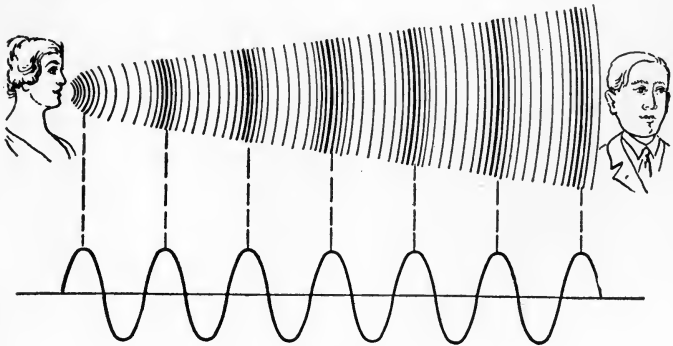

Figure 1

To study the nature of the vibrations of any body which is producing a sound, attach to it a very delicate pen (or its equivalent), and draw a piece of paper rapidly under the pen at right angles to the direction in which the pen is vibrating. The pen will draw on the paper a wavy line which shows just how the vibrating body was moving — whether regularly or irregularly, and whether in a smooth to-and-fro motion such as produces the so-called pure continuous waves or with irregular peaks and de-

pressions in the wavy line. The motion of sounding bodies is often complex. If the little pen could be attached to the vocal cords of a speaker, the wave forms obtained from some of the vowel sounds would give the very complicated curves shown in Plate I. The study of these curves reveals the remarkable ease with which speech is produced and understood. Equally complex in form are the sound waves from the strings of a piano or the reeds or other vibrating parts of musical instruments.

When the wave forms of the sound carry extra peaks and depressions riding on the main wave, as they do in this plate, they are said to have harmonics or overtones. It is just these harmonics of the main wave which give the sound its *quality* and enable the ready distinction of the sound of the flute from the sound of the violin when both are played to the same pitch. These extra peaks and depressions on the wave form naturally correspond to minor condensations and rarefactions in the major sound wave travelling through the air. They are clearly of importance and must be retained if the quality of the sound is not to be destroyed.

One of the most important characteristics of a sound is its frequency. This expresses the number of times per second that the vibrating body which produces the sound swings to-and-fro. The ear cannot hear sounds of all frequencies as musical notes. Very low notes, for example, those of less than twenty cycles, or twenty to-and-fro swings per second, are inaudible, as are also very high notes, such as those above about ten thousand cycles in a second. Some of the notes of the cricket fall above the last-mentioned value, and not every one

can hear them. Frequencies, therefore, below about 10,000 cycles per second are arbitrarily called *audio* frequencies, that is, audible frequencies. Frequencies above 10,000 cycles are termed *radio* frequencies, for reasons which will appear later when the normal frequencies of the radio oscillation are considered. While this division of sounds into audio and radio frequencies is arbitrary, it has proved very convenient.

A knowledge of the wavelength of travelling sound waves, or distance from crest to crest of the wave, is also important. The wavelength diminishes as the frequency of the vibrating source of sound increases, as can be readily determined by observing the length of the ripple produced in a rope fastened at one end to a wall when the hand holding the free end is moved to-and-fro. The faster the hand is moved, the shorter the distance from crest to crest of the resulting ripple or the wavelength. As a matter of fact, the wavelength of the 20-cycle sound is about 50 feet, and of the 10,000 cycle sound only a little more than 1 inch.

How Sound Passes from Speaker to Listener, or Audio Telephony. — As has been pointed out the spreading sound wave goes outward in all directions and is not directed to any particular point. It is truly broadcast, and reaches everyone within the range of the voice of the speaker or the sound of the orchestra. However, it rapidly becomes weaker as it travels over an increasing distance and spreads itself over larger and larger regions, until finally it is impossible to hear at all. There are other causes besides great distance from the speaker which may

make it impossible to hear and understand his words. Thus, some one else may be speaking in the neighborhood of the listener and cause interference, or there may be other irregular noises in the air such as the rustling of leaves, and the sound of city traffic. These latter constitute what might be called atmospheric disturbances. It will be seen that conditions in radio telephone transmission and reception are very similar.

Referring to the lower diagram of Figure 1, which represents the wave form of the sound being produced by the singer or speaker in the upper portion of the figure, it is seen that the crests of the wave shape correspond to the regions of condensation in the actual travelling sound wave, and that the troughs in the wave form correspond to the rarefactions in the actual sound wave. The minor ripples, such as are shown in Plate I, correspond similarly to minor condensations and rarefactions in the travelling sound wave. It is clear that the speaker is releasing a stream of energy; that is, there is a controlled flow of energy outward from him to all his hearers. This energy is not steady in value but is moulded or modulated in the form of the wave as shown.

It is noteworthy that the wave form of a sound is its signature, and is its means of identification. While it is true that the hearer is not conscious of the fact, still it is the delicate and complex form of the waves of sound which enables him to understand or enjoy them — a very important fact. Just as an object is recognized by its shape and colors, so a sound can be identified by its *wave form*, even though it is done unconsciously. The untrained eye

finds difficulty in identifying such sounds as those shown in the plate from their signature, but the ear does not.

The somewhat elaborate term, audio telephony, is used to describe the very ordinary and normal process of one man talking to another through the air by the agency of sound waves, because there is so close a resemblance between this method of carrying speech from one point to another and the method of radio telephony. Audio and radio telephony particularly resemble each other in that in each case there is a flow of energy from the transmitter (speaker) to the receiver (listener) which flow is moulded or modulated into the wave form of the speech or music and is identified by the hearer.

Wire Telephony; or How Electric Currents Carry Speech.—Wire telephony resembles the so-called audio telephony, and also radio telephony, so closely that it is desirable to understand how it is carried on. Furthermore, the instruments used in wire telephony are also employed for very similar purposes in radio telephony.

As is well known, in wire telephony it is an electric current and not the sound itself which flows over the wire. Yet the current must be the agency by which the signature or wave form of the sound is carried to the telephone receiver. The wave form of the sound is impressed on an otherwise steady current by means of the telephone transmitter, which consists essentially of a small quantity of fine carbon grains contained in an enclosed chamber between two plates of carbon. The front or mov-

able plate is connected to a large aluminum diaphragm against which the user speaks. This sheet vibrates in accordance with the wave form of the sound of speech and carries this vibration to the front carbon plate. The result is that the carbon grains in the chamber are compressed or released in accordance with the sound vibrations. It is a peculiar property of such carbon grains that, when they are compressed, they permit an electric current to flow through them quite readily and with but little resistance, while when they are released and therefore lying loosely against each other, they interpose a very considerable resistance to the flow of the current through them and therefore cut down the amount of the current which passes.

The telephone transmitter is, therefore, a sort of electric valve or throttle, much like a valve on a water pipe or like the throttle of a steam or gasoline engine. It is capable of opening up and permitting the full flow of a current through it, or of shutting down either gradually or suddenly and cutting down the current through it. And, best of all, it requires only the feeble sound vibrations of the voice to actuate this electric valve and to control the current satisfactorily. The result is that the otherwise steady current sent through the transmitter will be converted into a variable current having the same wave form as that of speech.

A battery or electric generator of some sort is required to feed the transmitter and to supply the necessary power for the passage of the current over the wire and through the distant receiver. As long as no sound strikes the transmitter, the battery current through the transmitter will not alter in

general. Furthermore the receiver is so arranged that *no sound* is produced when such a *steady* current flows through it.

The receiver will, however, produce sounds whenever the current passing through it *changes*. It consists, in the most common form, of a small thin circular sheet of iron, something like the diaphragm of a phonograph, placed near the ends or pole pieces of an electromagnet. The electromagnet is made of an iron core on which are wound a great number of turns of fine wire through which the incoming current from the telephone line passes. The attractive force of the electromagnet for the diaphragm is directly related to the current passing through its winding. The form of telephone receiver used most generally in radio reception consists of two separate receivers mounted on a headband which holds them to the ears and thus leaves the hands of the user free, for example, to write down the message. In another form of receiver used in radio, namely the loud speaker, the receiver and its horn or other sound-radiating structure are so proportioned and designed that an unusually loud sound is produced which can be conveniently heard at a considerable distance from the receiver.

The simplest, but not most common, system of wire telephony is shown in Figure 2. The current from a dry battery passes through the transmitter and then through the long line to the distant receiver. As long as no sound strikes the transmitter, the current through it and the battery and distant receiver remains practically steady. The receiver remains silent as long as such a direct current flows through it because the diaphragm will not move

when a steady current passes through its attracting electromagnets. If, however, a musical note is sung against the transmitter, the resistance of the carbon grains in the transmitter is periodically changed as the transmitter diaphragm swings to-and-fro, following the wave form of the sound. Thus, instead of having the steady or direct current through the line and receiver, there is established a fluctuating

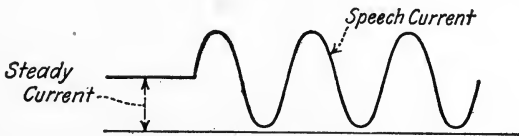
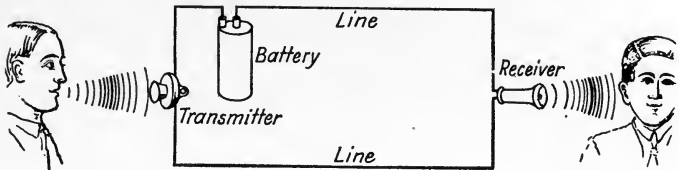

Figure 2

or pulsating current, which causes the receiver diaphragm to swing back and forth in accordance with the wave form of the fluctuations or pulsations of the incoming current. Accordingly, the diaphragm vibrates rapidly and reproduces, more or less accurately, the original sound. The sound produced at the receiver is then heard by the listener holding the receiver to his ear.

It will be noticed that this method of transmission involves moulding or modulating a steady direct current into the form of the speech wave at the transmitter, and that the receiver registers, not the

steady and silent direct current, but the *variations* or ripples which have been added to it and which are the signature of the speech. This process of telephoning by moulding an otherwise silent flow of energy into speech form and then listening, not to the steady and silent flow, but to the changes in the flow is also basic in radio telephony.

In actual wire telephony, as a general thing, a wiring plan like that in Figure 3 is employed. This differs principally in that there are transformers be-

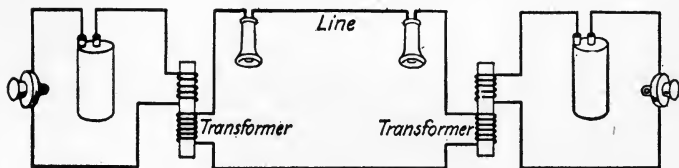

Figure 3

tween each transmitter with its associated battery circuit and the main line wire and receivers. These transformers consist of two coils of wire wound on a single iron core. When the transmitter current passes through its own coil of wire, called the primary, currents are automatically produced in the second coil of wire, called the secondary. These secondary currents represent only the changes in the primary current, and do not contain any steady or direct current. Consequently, there are sent over the long line only the changing currents which resemble the wave form of the original sound. It is to be noted that each of the receivers is connected directly into the line at the terminals.

In this last system of wire telephony, it is possible to talk and listen at the same time at each end, and

one speaker can interrupt the other readily at any time. This is known as duplex telephony, and is the usual and most convenient method. Wire telephony has made wonderful strides proceeding from the above simple beginnings. To-day it is possible to telephone directly from the Catalina Island in the Pacific Ocean to Cuba, a distance of 5,470 miles.

What Light Is; or the Electromagnetic Wave. — From early times there has been much speculation concerning the nature of light. Physically, it has been found that light is a peculiar sort of wave or ripple in a medium or substance of somewhat doubtful existence, namely, the ether. While its existence is uncertain, yet it is helpful for illustrative purposes, such as in the explanation of light waves, to assume that the ether exists.

The light wave resembles the sound wave, previously described, in being an ever-expanding spherical ripple. That is, light is broadcast from an ordinary lamp and sent in all directions for everyone to observe, although it is true that light can be directed more or less sharply in searchlight beams by special optical means.

While light resembles sound in being a spherical expanding wave, it differs from it in the nature of the disturbance which is travelling outward. In the case of sound, the wave consists of alternate expanding spheres of condensation and expansion of the air. For light, however, there are spheres of electric and magnetic forces travelling outward. The increased or reduced pressure in the sound wave will make a very light particle or sheet vibrate to-and-fro as the wave passes that particle. Simi-

larly, though this experiment cannot actually be performed as here described, the light wave would make an excessively small and light magnet vibrate to-and-fro, and would also make an equally light electrically-charged body swing back and forth. Since, therefore, the light wave is an expanding series of spheres of electric and magnetic forces, it is referred to scientifically as an electromagnetic wave.

Light waves travel with an incredibly large velocity, namely, 186,000 miles per second, or the equivalent of seven and a half circlings of the earth in one second. This velocity is also expressed as 300,000 kilometers per second. It may be mentioned that the waves used in radio communication are only a particular sort of light wave, and that they too travel with this amazingly large speed.

Light waves are produced wherever electric charges vibrate. As soon as a quantity of electricity is set swinging to-and-fro, an electromagnetic wave, that is, light of one sort or other, is produced. The simple relation between the wavelength of the light and the frequency of vibration of the electric charges which produce it is the following: Divide three hundred million by the frequency of vibration in cycles per second — the result will be the wavelength of the resulting wave in meters. It will be recalled that the meter is equal to 39.37 inches.

To illustrate the many sorts of electromagnetic waves which are now known, a table of some of these is given below:

X-rays	Yellow light
Ultra-violet light	Orange light
Violet light	Red light
Blue light	Infra-red light
Green light	Radio waves

Those of shortest wavelength and highest frequency appear at the beginning of the table. The waves between the violet and the red are all that can be seen by the human eye, which is a limited instrument in this respect. The X-rays and ultra-violet light can be recorded on the photographic plate. The infra-red rays produce marked heating effects when they fall on solid objects, and can thus be detected. The radio waves can only be detected by special receiving systems to be described later which convert their energy, possibly after a considerable increase in its amount, into sound.

Invisible Light and the Radio Wave. — Electromagnetic waves of a greater wavelength than about 50 meters are used for radio communication. Occasionally waves as short as five or ten meters are used for radio telegraphy in very special cases, but the shortest waves widely used to-day, especially by amateurs, are those around 200 meters. These have a frequency of no less than 1,500,000 cycles per second (sometimes called 1,500 kilocycles per second). This frequency is obtained from the simple rule given above for calculating wavelengths or frequencies. Commercial radio work begins generally with waves around 300 meters for ship communication. The radio waves most widely used in broadcast operation in the United States at present are 360 and 485 meters, which correspond to frequencies of respectively 833,000 and 618,000 cycles. Evidently, the oscillating electric currents which produce these waves must be of extremely high frequency.

As a general rule, for steady and reliable trans-

mission, it is necessary to use the longer waves for dependable work over the larger distances. Thus, for transoceanic radio telegraphy, waves of from 10,000 to 25,000 meters length are in general use. While the broadcast messages are sent on waves about 1,100 feet long, the trans-Atlantic messages are carried by great surges some ten miles in wavelength. Occasionally very short waves can be used for communication over remarkably long distances, as in the case of occasional transoceanic operation by amateur stations. But the general rule prevails that for bridging great distances reliably and by day, the long waves are required, and that considerable power must be available at the radio transmitter.

The first requirement of every system for producing radio waves is necessarily some form of oscillation generator which can produce extremely rapid electrical oscillations, that is, which can cause electrical oscillations in some wire system. As has been pointed out, the frequency of vibration of the electric charges will be as low, comparatively speaking, as 12,000 cycles in each second for the transoceanic stations, and will rise to millions of cycles for the short wave or amateur stations. It is not an easy matter to produce an oscillation generator which will meet these requirements, and also produce what are called smooth continuous waves. Such waves continue without pause or change and, in addition, have exactly the wave form of perfect ripples such as travel along a cord which is swung at one end, the other end being fixed to a wall. The shape of such ripples is briefly described as a sine wave.

Actual oscillation generators for continuous waves at present fall into three main classes: the vacuum tube, the alternator, and the arc. The vacuum tube is the most used at the shorter waves, and exclusively for broadcasting purposes. It is described in detail in Chapters IV to VI. Alternators, which are employed for long distance and high power radio communication, are quite similar in a general way to the alternators which produce ordinary alternating currents, except that they are modified so as to generate currents of much higher frequencies than those customarily used for power supply. The arc, in a form known as the Poulsen arc, is also utilized for generating oscillations for the production of continuous waves, but not at the shorter wave lengths. As a practical proposition, radio telephony below a few thousand meters wave length is today carried on entirely with tube oscillation generators.

The second requirement for the production of the radio waves is a suitable aerial wire system from which the waves can be radiated or flung off into space. In many cases, a connection to the ground itself is required as well. The aerial wires are called an antenna, after the antennas or sensitive feelers of the butterfly. The antenna of a radio transmitting station corresponds broadly to the filament of an electric lamp from which light is being emitted. More strictly, it corresponds to an atom in the incandescent filaments. If our eyes could see the radio waves, as we do see the light waves of the colors of the rainbow, the antenna of a radio transmitting station in operation would be a most impressive and dazzling spectacle. It would appear rather like the blazing filament of a huge lamp from

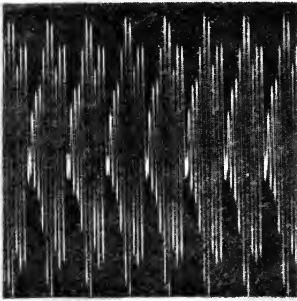

"a" as in "Pay"

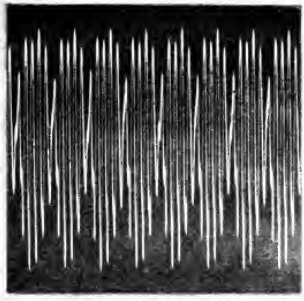

"a" as in "Far"



"ee" as in "Fee"

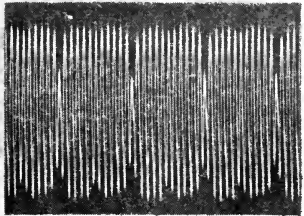

"i" as in "Pine"

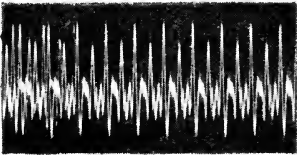

"o" as in "Low"

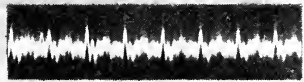

"oo" as in "Moon"

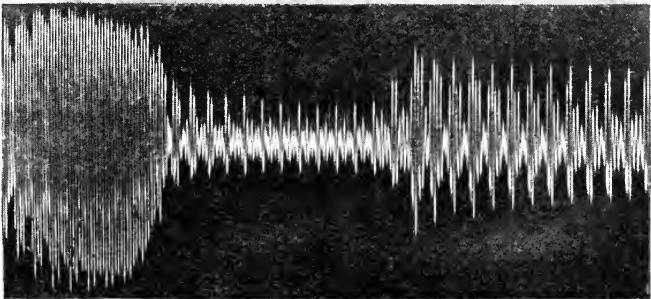

Part of the word "Hello"

Plate I.—The vowel sounds. One inch of width corresponds to a time interval of about one-thirtieth of a second.

which would literally flash the dots and dashes of the Morse code if telegraphic messages were being transmitted, or the much more complicated fluctuations of light corresponding to the wave form of the sounds of speech if radio telephony were being carried on.

In place of the elevated aerial wire systems, messages may sometimes be sent from, or received on, what are known as coil or loop antennas. These are coils of wire of moderate dimensions, and are used because they receive best from certain directions and thus enable cutting out undesired stations from some other direction. Furthermore, their compactness makes them desirable for use inside of buildings and for military purposes. It is a noticeable fact that the steel framework of a building absorbs the radio waves to a considerable extent and therefore make it more difficult to send or receive radio messages with antennas of any sort located within such a building. Radio waves, however, pass without appreciable hindrance through wooden or brick buildings; the metal members of a building being the only serious impediment to their travel.

The distance over which a transmitting station can reliably transmit messages is called its normal range, or simply its range. The distance over which it can transmit under unusually favorable conditions is known as its occasional range. Unfortunately, the occasional range is much greater than the normal and reliable range. Thus, a station which at times may be heard thousands of miles away, may not be dependable over a hundred miles under favorable conditions. This fact should be kept in mind when enthusiastic statements are made as to the distance

at which a transmitting station has been heard. Such occasionally achieved ranges are rather of sporting or personal interest than of engineering or commercial value.

The range of a transmitting station depends on the size of the antenna and the power most available at the station. It may vary from a few miles up to many thousands of miles for the giant transoceanic stations with their long rows of very high towers supporting the antenna wires and the hundreds of kilowatts of available power. The higher the antenna, the greater the range of the station, assuming it to be properly proportioned and efficiently operated.

One of the interesting special effects found in the transmission of the radio waves is that known as freak transmission. This generally occurs at night and in winter, and is evidenced by the sudden remarkable strengthening of the received signal from some very distant and comparatively feeble transmitting station. Indeed, stations which generally cannot be heard at all at a receiving station may in a few moments increase in loudness to such an extent that the signals ring over the entire room. The effect is apparently somewhat similar to that experienced in the well-known whispering galleries in the case of sound. Here sound is carried by reflection from overhead domes in churches, or similar structures, from one point to another with but little loss and with astonishing loudness at the second point. Layers of reflecting material may in such cases be formed in the atmosphere, which guide the radio waves with little loss to their destination through what might be called a radio speaking tube.

While very great distances can occasionally be spanned by freak transmission, this is never a reliable effect, and those who experience it at a receiving station should not be disappointed if they find that they cannot duplicate their finest successes along these lines of long distance reception.

Another somewhat disconcerting effect in radio transmission and reception is fading and swinging. A received signal may in a few seconds fade out completely or else swing up and down in strength in irregular fashion. This occurs at distances beyond the normal range of the transmitting station and cannot be helped. It results from intermittent reflections or absorptions in the atmosphere between the transmitting and the receiving station. At night, in winter, radio telephone broadcasting stations are heard over tremendous distances at times, but they generally fluctuate in strength at the receiving station in such cases. By day and in the summer, when the conditions are less favorable, such stations will not be received at all or only rarely.

Another complication which occurs principally in summer, is *static* or atmospheric disturbances. These are electrical disturbances in the air which, in some way, affect the receiving set and make their presence known by clicks or grinding noises in the telephones. They can be largely reduced, as is done in important transoceanic receiving stations, but require rather complex means. For ordinary reasonable distances from transmitting stations, their effects will not in general be very serious. Similar disturbing noises may result from unshielded electrical apparatus in the neighborhood of the receiving set, such as sparking elevator motors, spark-

ing or irregular grounds on power lines, and sparking buzzers. Such equipment should, therefore, be shielded or modified electrically to avoid these disturbances.

Another form of partial or even total interruption of reception may be caused by station interference. If a powerful, or even feeble, transmitting station in the neighborhood of the receiving station sends a wavelength close to that of the wave to which the receiving station is listening, the former signal may badly interfere with the latter and desired one. The interfering station may send out a so-called harmonic or unauthorized and parasitic short wave from a powerful long wave tube or arc transmitter. The interference is sometimes caused by a special form of receiver (the "heterodyne" receiver described in Chapter VI) oscillating directly into the antenna and therefore acting as a feeble transmitter. Spark transmitting stations for radio telegraphy are the worst offenders in the matter of producing station interference. It is possible for those skilled in the code to identify the interfering station by reading its call letters at the end of the message, without which information any identification is apt to be uncertain without special radio direction-finding apparatus.

To reduce, or often eliminate, station interference, the receiver must be *tuned* to the desired wave, thus shutting out the undesired wavelength as nearly as possible. The process of tuning is more fully described in Chapter II. It will readily be seen that there is a remarkable resemblance between the disturbances which prevent an individual from hearing what some one is saying to him through the air

and the disturbances which prevent the satisfactory reception of radio messages.

The Modulation and Control of the Radio Wave. — It will be remembered from the foregoing that wire telephony is carried out by modulation or moulding of the silent, direct current by means of the telephone transmitter which is therefore a modulator. Radio telephony is similarly carried out by modulating the very high frequency and inaudible electric oscillations by a telephone transmitter so as to give them the wave form of the speech or other sound which is being transmitted. That is, the flow of the unheard high frequency waves in radio telephony corresponds to the flow of the equally silent, direct current in wire telephony. Each of these silent partners in the telephone transmission supplies all the energy of the transmission, but what is actually heard at the receiving end is not the silent carrier current but the *changes* therein which are produced by the modulator and which follow the wave forms of speech. It must be recalled at this point that the frequency of oscillation in the radio waves is so high, as previously explained, that the ear cannot possibly hear the currents produced by a steady radio wave but only the *changes* in such currents when the wave is moulded into speech form.

In Figure 4 is shown the manner in which the high-frequency (radio frequency) oscillations are moulded into speech form. It will be seen that the radio-frequency oscillations are not always of the same width of swing, but that this width, or amplitude, is controlled in speech form through the

direct or indirect agency of a telephone transmitter. A telephone transmitter may be used directly as a modulator, or, if much power is being handled, the telephone transmitter combined with some form of amplifying equipment (to be described below) is

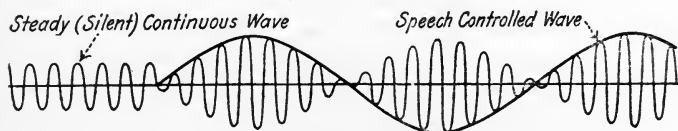

Figure 4

used as a modulator. In any case, it is the electric valve or throttle action over again, as in wire telephony, except that the voice controls the *radio frequency* currents in the antenna instead of *direct* current as in wire telephony.

The modulation system which is used should be distortion-free, that is, the wave form of the controlled outgoing waves should be exactly that of the speech. If it is not, the received sound will differ from the original sound — an unfortunately common state of affairs in ill-designed or carelessly operated stations. If there is distortion, the speech or music will be “tinny,” “muffled,” or otherwise unsatisfactory. Thus the already great distortion inherent in a poor phonograph record may be enhanced by a defective modulation system to an unpleasant extent. On the other hand, it is possible to produce faithful renditions of the most difficult musical selections when modulation is properly carried out.

Furthermore, the modulation should be complete. That is, the troughs of the loudest speech waves

should correspond to a full cut-off of all the wave energy. If there is under-modulation, the speech becomes very faint because the changes in the energy flow of the radiated waves fall below what they might be. If there is over-modulation, the quality of the speech is damaged, particularly for the louder sounds, because the tops and bottoms of the speech waves are flattened out by the excessive control of the modulating system.

The practical processes of modulation involve a flexible and momentary changing of the output of the oscillation generator of the transmitting set, whether tube, alternator, or arc. This may be done by absorbing wave energy momentarily in some circuit controlled by the telephone transmitter, or by pumping in wave energy from some circuit controlled by the telephone transmitter, or by a combination of both of these means.

Vocal Control or Modulation of the Radio Wave. — The process of modulation of the radio wave is the basic and most important element in radio telephony. To accomplish it successfully, there must be available an effective "pick-up" system at the transmitting station whereby the sound of the voice, or of the musical instruments, can be reliably and accurately picked up by a telephone transmitter. The actual arrangements will be described in Chapter VII.

The energy of the sound of the voice or of musical instruments is very small and yet it must control, directly or indirectly, the vastly greater energy of the oscillation generator and of the resulting radio wave. This involves a multiplication of energy

which may be of the order of millions-to-one. Such great multiplication of energy requires unusual amplification of the power of the sound waves of the voice; and the means of amplifying almost invariably employed is the vacuum or electron tube (also known as a *triode*). Vacuum tubes are supplied under a number of trade names such as aeriotron, audion, electron relay, oscillion, pliotron, and radiotron. They all consist of a carefully evacuated glass container in which are enclosed an incandescent filament, a fine grid of wire surrounding the filament, and a plate or cylindrically shaped metal piece surrounding both the filament and the grid. Such tubes will be described further in Chapter IV. They are furnished in various sizes for outputs of different amounts of power ranging from a small fraction of a watt to thousands of watts.

The general arrangements at the transmitting end of every radio telephone system are as given in

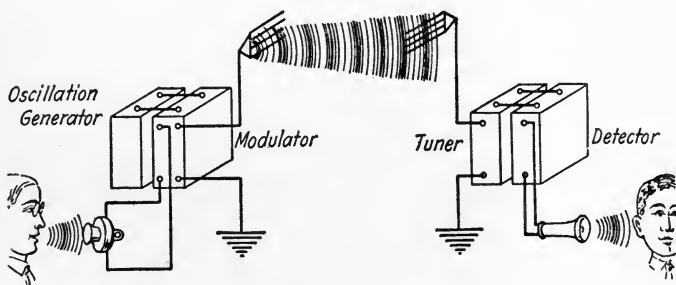

Figure 5

Figure 5. The oscillation generator produces alternating currents of the high frequency necessary to start the radio waves from the antenna. Before the waves are radiated, however, the modulator acts

on the alternating current which produces the waves, and moulds this current into the shape of the sound of the speech or music, after which the modulated wave is flung off by the antenna of the transmitting station. In controlling the output of the oscillation generator by means of the modulator, it has been found that most of the sounds of the human voice in speech lie between about 200 and 2,300 cycles per second in frequency, and that musical sounds cover a range extending downward to lower frequencies and upward to somewhat higher frequencies. Each cycle or wave element of the sound of speech or music is represented by many cycles in the radiated electromagnetic wave which is of much higher frequency.

Thus, for a broadcasting station working on 360 meters wavelength, corresponding to a frequency of 833,000 cycles, there will be 833 cycles of the electromagnetic wave included in *one* cycle of a 1,000-cycle note which has been sung against the transmitter. That is, one cycle of the 1,000-cycle note will be built up of 833 cycles of the high frequency oscillations produced by the oscillation generator. Thus, the reproduction of the 1,000-cycle note can be very close indeed, since the component wavelets of radio frequency come so frequently that they compactly fill the shape of the lower frequency musical sound. If this condition were not fulfilled, that is, if there were not a large number of radio frequency cycles available for each cycle of the audio frequency note, the quality of the speech or music would be injured at the receiving station.

It is not necessary to have the speaker or singer whose voice is to be broadcasted from a radio tele-

phone transmitter actually at the transmitting station. The voice currents can be sent over wire telephone lines from some distant studio to the transmitting station and can there be amplified automatically to control the outgoing wave. This process is called the remote control of a radio telephone transmitter by wire line transfer. This method is serviceable in connection with the broadcasting of theatrical performances without requiring the entire company to travel to the radio station.

Radio Telephone Reception; or Hearing Changes in the Radio Waves. — At first it is difficult to see how the radio telephone waves can be heard at all, even indirectly, since their own frequency is so very high. This frequency runs into hundreds of thousands of cycles or more, and the usual telephone receiver cannot possibly follow such high frequency currents, because the push on the telephone diaphragm during a hundred-thousandth of a second is succeeded by a pull during the next hundred-thousandth of a second, and before the comparatively massive and inert diaphragm has moved appreciably. Consequently, the rapidly succeeding and therefore practically neutralizing pushes and pulls on the diaphragm can produce no perceptible motion. However, no attempt is made to listen to the radio frequency waves at all, but only to *changes* in the wave, that is, variations in their width of swing or amplitude.

It will be recalled that the radio telephone message arrives at the receiving station in the form of a series of changes in the otherwise smooth flow of the radio waves, which latter are themselves silent

and inaudible because their frequency is so far beyond what the ear can hear in the telephone or what the telephone diaphragm can follow. The telephone diaphragm must therefore be contrived to move only according to the variations or changes in the amplitude of the incoming waves.

The method of accomplishing this is primarily through the use of what is known as a *detector* or *rectifier*. The rectifier is a device which permits current to pass through it more readily in one direction than the other. If there are several hundred thousand pushes and pulls on the telephone diaphragm each second, there is no effect produced because the pulls neutralize the pushes before the diaphragm can move. If, however, the received radio frequency current is sent through the rectifier or detector before feeding it to the telephone receiver, the action on the telephone diaphragm is converted into a series of pushes only, producing several hundred thousand mutually assisting pushes per second. The result is that the telephone diaphragm is pushed aside, and stays steadily in its displaced position as long as the waves arrive without change in their amplitude or width of swing. If, now, the amplitude of the waves changes in accordance with the wave form of the original sound which struck the telephone transmitter at the radio transmitting station, the diaphragm will have a push on it which follows these changes in the power of the incident waves and which push, therefore, duplicates the wave form of the original sound. In doing so, the diaphragm will swing back and forth in accordance with the original sound, which will therefore be reproduced at the receiving station.

Figure 5 also illustrates the general arrangement at the receiving station. After passing through the receiving tuner (which will be described later), the radio frequency currents pass through the detector or rectifier on their way to the telephone receivers. They are there rectified as indicated in Figure 6 which shows the current available after passing through the rectifier. The telephone diaphragm, subject to the very frequent and varying pushes

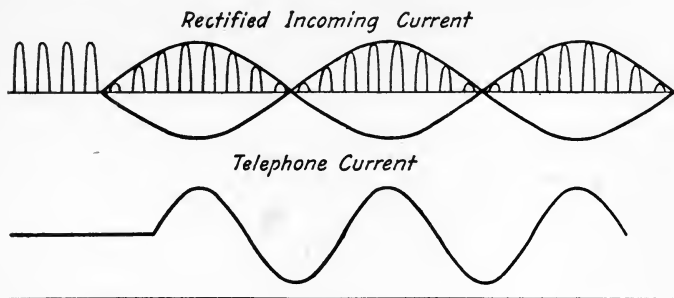

Figure 6

shown in the upper part of the figure will swing back and forth in the manner shown in the lower part, reproducing the original sound at the transmitting station.

There are two principal forms of detectors which are in wide use; these will be considered in detail in Chapters III and IV. The simplest is the crystal detector, which is a contact between a crystal surface and a metal point, or else a contact between two crystal surfaces. The other and more sensitive detector, which is capable of giving louder signals, is the electron tube; it not only partly rectifies the current through it but also amplifies it considerably.

The received radio telephone signals may also be transferred automatically over wire telephone lines. Thus, a radio telephone message received at the radio station may be sent without change over existing wire lines to the telephone of any subscriber for the usual service. This enables persons on ships at sea to talk directly to any wire telephone subscriber on land, which extends the wire line system of the country over all its radio telephone extensions or links.

What the Radio Telephone Transmitter Must Accomplish. — The essential portions of the radio telephone transmitting station and their functions are: a transmitter pick-up system which functions faultlessly, both as to the quality of speech and music, and to supplying the necessary amount of power for modulating the output of the oscillation generator; an oscillation generator which supplies the necessary radio frequency alternating currents with perfect regularity; a modulator which controls the output of the oscillation generator accurately and supplies the modulated alternated currents to the antenna; and an antenna capable of radiating the available power in the form of electromagnetic waves. The dimensions, appearance, and arrangement of these parts will depend on the power of the station and the service which it is to render.

The oscillation generator generally employed in the low and moderate power stations consists of a number of the larger electron tubes and their circuits used as oscillators in the fashion described in detail in Chapters V and VII. They produce smooth alternating currents of very high frequency. Only

generators capable of furnishing such regular currents will enable the radiation of silent continuous waves from the antenna.

The amount of power available in the antenna system of a radio telephone transmitter for present-day practice varies between the wide limits of a few watts and hundreds of kilowatts. A watt, it may be mentioned, is about one one-hundredth of the available mechanical power output of the average man, steadily at work. The kilowatt is one thousand times greater. For a reliable range of a few miles, a transmitter of a few watts power will be suitable, while for a fully reliable range of about 50 miles, as much as 500 watts will be required as the output of the transmitter.

It may be of interest to state that the noisy spark which has so long been associated in the popular mind with radio *telegraphy* has never been employed in its well-known form for radio telephony, and that the apparatus now used in radio telephone transmitting stations employs no sparks and can be made to be practically free from disturbing noises.

What the Radio Telephone Receiver Must Accomplish. — In order to receive the radio telephone messages, an antenna of some sort must be provided. This may be either in the form of elevated wires (and a ground connection as well), or in the form of a coil or loop of wire. The larger the elevated wire system within certain limits, the louder will be the received signal. The coil antennas do not give nearly as loud a signal as the elevated aerial systems, but they have the advantage of being compact and also of being directional. The directional

property enables them to be turned to receive the desired signal most effectively, while reducing to a minimum any undesired signal by rotating the loop to an appropriate position. Generally speaking, an extra amplifier using tubes must be provided with sets using a loop antenna in order to get signals which are the equal of those from an elevated aerial wire system.

The antenna of the receiving station corresponds in a general way in its function to the ear drum for the reception of sound. Just as the sound causes the ear drum to vibrate in unison with the sound, so the electromagnetic waves which carry the radio message start electrical oscillations in the receiving antenna, thus producing high frequency alternating currents closely resembling those which flowed in the antenna at the transmitting station.

The antenna system is always connected to some form of tuning apparatus, which consists of electrical circuits. These enable selecting one particular wavelength for reception, to the more or less complete exclusion of all incoming signals on other wavelengths. This is a great convenience, because it enables the person at the receiving station to tune his receiver to the desired wave (for example, the broadcast wave of 360 meters) and more or less completely to exclude a possible interfering signal on a wavelength of say 600 meters. Thus, the interference from undesired signals can be much reduced by tuning, which is merely the process of adjusting a receiver so that it receives most effectively only some particular wavelength.

Passing out of the tuner, the detector makes the otherwise inaudible radio frequency currents audible

in the telephone receivers by rectifying them, as has already been explained. The general arrangement of these parts of the receiver is shown at the right in Figure 5. In one form or other, the antenna, tuner, detector, and telephone receivers will be found in every radio telephone receiving set.

Some receivers are built to contain tubes which either oscillate continuously or, to put it somewhat vaguely, nearly oscillate. The technical term for such regenerative receivers, when adjusted to the oscillating condition, is *heterodyne receivers*; and, if they contain tubes which amplify very markedly and nearly oscillate, they are called *non-oscillating regenerative receivers*. Both of these types of receivers will be discussed in Chapter VI. They have the advantage that they are very sensitive and give loud signals with high selectivity, particularly when used on poor antennas of small dimensions and on feeble signals from distant transmitters. They may, however, cause electrical oscillations in the receiving station antenna which will produce curious trilling bird-note effects in nearby receiving stations, and which give rise to interference. Indeed, such receivers may act as feeble transmitters, and special measures are required to prevent them from causing interference in other nearby receiving stations.

When unusually loud signals are required, a powerful amplifier containing one or more extra electron tubes is used, the output of the amplifier being fed to a loud speaker. This device is a special form of receiver usually provided with a large horn on the general plan of a megaphone. It produces an intense and powerful signal, but it is necessary to use it with properly designed circuits if distortion

of the speech or music and loss of quality are to be avoided. In fact, the problem of producing excellent quality in a sound loud enough completely to fill a room of large dimensions is much more difficult than that of obtaining a moderately loud sound of excellent quality in ordinary headband telephone receivers.

There are two main types of amplifiers used in receiving sets to enhance the signal strength. One of these types particularly amplifies the unrectified radio frequency current before it reaches the detector, and is known as a radio frequency amplifier. Other amplifiers increase the strength of the rectified currents of lower frequency which have passed the detector and are ready to be fed to the telephone receivers. Such amplifiers are known as audio frequency amplifiers and are widely used. They will be fully discussed in Chapter V.

It is by such means as have been described in this chapter that modern radio telephone broadcasting is being carried out, and is successfully providing entertainment and instruction to an ever-increasing part of the population.

CHAPTER II

TUNING THE SIMPLE RECEIVING CIRCUIT

BY ERICH HAUSMANN, E.E., Sc.D.

Professor of Electrical Communication and Thomas Potts Professor of Physics, Polytechnic Institute of Brooklyn; Fellow, American Institute of Electrical Engineers, and American Association for the Advancement of Science.

The Antenna as an Electric Circuit. — The understanding of how the receiving apparatus of a radio station is made responsive to incoming radio waves requires a knowledge of the properties of electric circuits. An electric circuit is a complete conducting path through which a battery or electric generator can send an electric current. If a battery or a direct-current generator is used that current will be a continuous or direct current, that is, it will flow always in one direction around the circuit. On the other hand, if an alternating-current generator is used the current through the circuit will flow first one way and then the other, the reversals of direction occurring many times in one second.

The number of times that the current flows in one direction during a single second is called the frequency of the current and is expressed in cycles per second. Thus, the current in a radio telephone antenna may have a frequency of one million cycles, which means that in one second there are one million periods during which the current flow takes place in one direction around the circuit, and also an equal

number of intermediate periods during which the current flows in the opposite direction.

The purpose of the generator in the electric circuit is to provide the pressure which causes the current to flow. This electrical pressure, or voltage, is analogous to the hydraulic pressure in a pipe line which causes a liquid to flow through it. The hydraulic counterpart of the alternating-current generator is a reciprocating pump, without valves, which causes water to circulate back and forth in the pipes connected to the pump as illustrated in Figure 7. The generator, which is represented con-

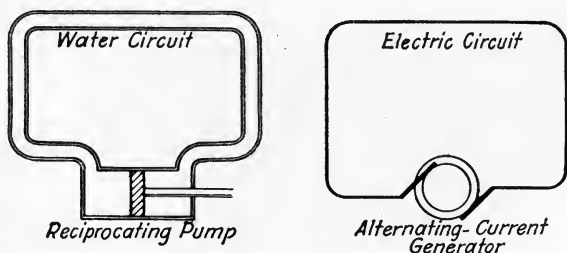

Figure 7

ventionally in the diagram by two circles, consists essentially of a number of wires which are forced to rotate near the poles of electromagnets. The motion of these wires through the magnetic field which surrounds the magnet poles causes a voltage to be induced in the wires, the voltage being in one direction when the wires are passing in front of a north pole and in the opposite direction when passing a south pole. It is this alternating voltage which causes the alternating current to flow in the electric circuit connected to the generator terminals.

Imagine a flexible diaphragm to be placed across the water pipe in its enlarged portion, as shown in Figure 8. As the piston of the pump moves to the left end of its cylinder the diaphragm will be distended to the position indicated by the right-hand dotted line, and the flow of water will cease momentarily. As the piston moves to the right the water will flow in a reversed direction and the diaphragm will return to its center position and then continue in the same direction, ultimately reaching the extreme position indicated by the other dotted line. When moved from its center position the diaphragm is stressed and in this state exerts a pressure on the water. So far as the flow of water in the connecting pipes is concerned, there has been no change; it flows alternately up and down, but the pump in this case must exert a somewhat larger pressure to counteract the pressure of the diaphragm.

The electrical equivalent of the diaphragm in a water pipe is an insulating barrier in an electric circuit, the barrier being formed by two plates, or sets of plates, one on each side of the insulating material. This material may be a gas such as air, or a liquid such as oil, or a solid such as mica. Figure 8 also shows the electric circuit having the insulating barrier, or condenser, as it is called. Just as the diaphragm did not interrupt the alternating flow of water in the hydraulic circuit, so the condenser will not interrupt the flow of alternating current in the electric circuit. On the other hand, the continuous flow of water would be interrupted by the diaphragm, and likewise the flow of a continuous or direct current would be interrupted by the condenser.

The air or other insulating medium between the plates of the condenser is stressed electrically, or charged, and this charge corresponds to the elastic stress in the diaphragm. The property of the insulating barrier or condenser by virtue of which an electrical stress or charge can be established is called capacitance; it is comparable with the elasticity of

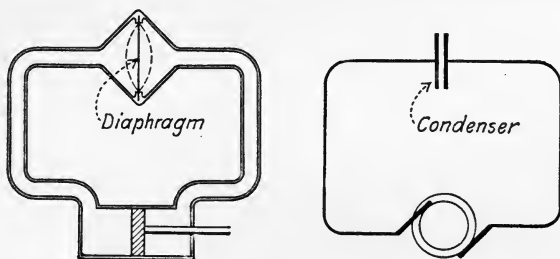

Figure 8

the diaphragm. This property is also termed electrostatic capacity. Naturally the capacitance of a condenser depends upon its size; the larger the area of the insulating material between the plates and the thinner that material the larger will be the capacitance.

The variable condensers used in radio receiving circuits have two sets of parallel metal plates, one stationary and the other movable, the plates of the latter set being arranged to move between but not touch the plates of the other set in order to vary the capacitance. When the plates of one set are entirely within the spaces of the other set, then the capacitance of the condenser as measured between the two sets of plates is a maximum. Usually the plates are semi-circular, and the movable set is rotatable by

means of a shaft through the center; with this construction the capacitance is almost directly proportional to the angular movement.

The antenna of a radio receiving station usually consists of one wire or a set of wires supported some distance above the ground, and connected to the ground through some form of receiving instrument. While this arrangement does not resemble the condenser just described, the antenna circuit nevertheless possesses capacitance, for the overhead wires and the surface of the earth act as the two plates of a condenser, and the air between them is the medium which is electrically stressed whenever currents surge up and down the antenna. Figure 9 illustrates the

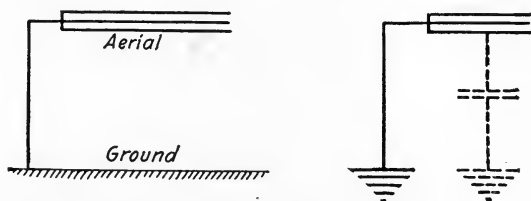

Figure 9

antenna circuit and also includes a sketch at the right in which the capacitance of the antenna is represented by a condenser. The antenna is, therefore, a complete alternating-current circuit, and such a current will flow in it if a source of alternating voltage is introduced.

If the lower end of the antenna is not grounded, or the ground connection is poor, the antenna capacitance will be small and little energy will be absorbed from the radio waves. Where dry soil is encountered, the lower end of the antenna is often

connected to a network of wires laid on the ground directly beneath the aerial wires and this network, or counterpoise, may even be insulated from the ground. This arrangement provides the necessary surface to act with the aerial wires as a condenser. In general practice the ground itself is used instead of the counterpoise, the connection being made by pipes or by metal bodies sunk into moist soil.

On ships, metal parts, such as the steel hull, form the ground, the water also acting as a part of it. With aircraft, the aerial conductor sometimes trails behind or sometimes is mounted rigidly; and the engine, stays, and other metal parts form the counterpoise.

The Resistance and Inductance of the Antenna. — The antenna of a radio receiving station extends into the ether in order that energy may be received from radio waves which are transmitted through that medium. This transfer of energy occurs through the development of a voltage in the antenna by the radio wave in very much the same manner as voltage is induced in the wires of an alternating-current generator when the wires pass through its magnetic fields. The induced voltage in the antenna is a very minute one of alternating character, and the alternating current which it produces in that circuit is extremely small. Naturally the electrical conditions of the antenna should be such as to result in the development of currents as large as possible.

The conducting material of the antenna circuit presents a certain amount of opposition to the flow of electric current, in the same way that a pipe

carrying water presents opposition through friction. This opposition, or resistance, to an electric current, depends upon the length and size of the wire in the circuit, and also upon its material. The longer the wire and the smaller its diameter the larger will be its electrical resistance. Copper, copper-clad iron, or phosphor bronze wire from 0.06 to 0.10 inch in diameter is often used for the aerial and lead-in conductors of the antenna.

All electrical devices have more or less resistance, the amount of that resistance being expressed in terms of a unit of measurement called the ohm. Thus, a telephone receiver may have a resistance of 1500 ohms, while a rheostat (for vacuum-tube filaments) may have a resistance of 7 ohms. If two devices are connected in a circuit to a battery so that the current must first pass through one before passing through the other, the devices are in series and their total resistance is the sum of their individual resistances.

If a current detecting device is introduced into the antenna circuit for the purpose of receiving the radio signals, its resistance will add to the resistance of the antenna itself. The detecting device should, therefore, have a low resistance so that the current will not be unduly diminished. Methods will be described later for detecting the current without inserting the detector in series with the antenna.

Experiment shows that the strength of current in the antenna circuit thus far described can be increased by inserting a few turns of wire wound around an insulating tube, the individual turns being separated from each other. Of course, such a coil of wire increases somewhat the electrical re-

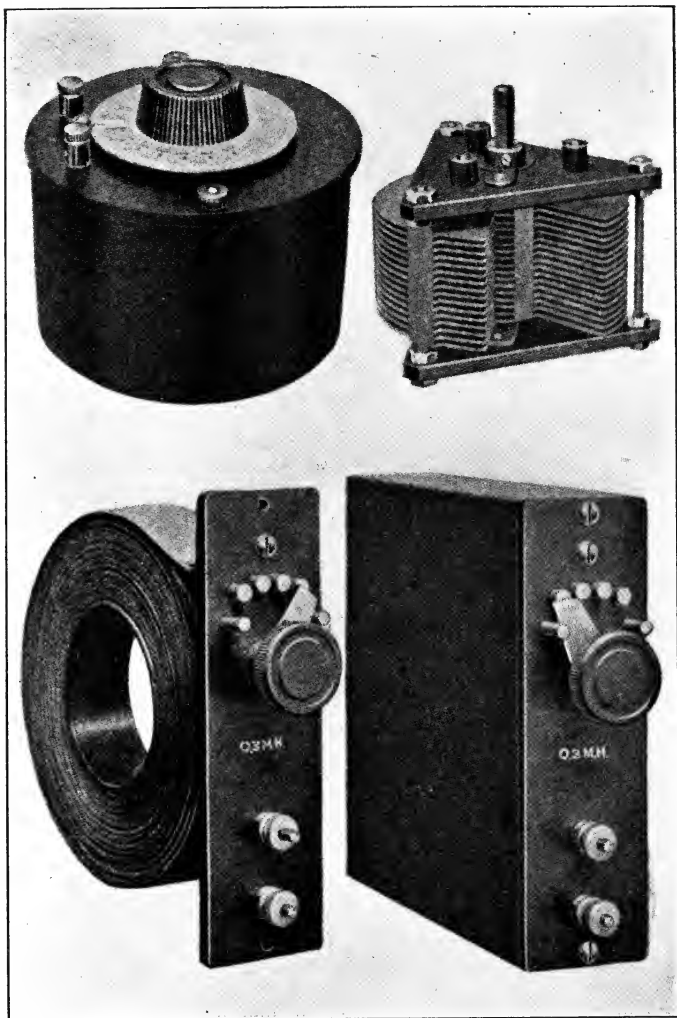

Plate II.—Above: Variable air condenser (maximum capacitance is 1.0 millimicrofarad); below: Four-step inductance coil (total inductance is 0.3 millihenry); *General Radio Co.*



sistance of the antenna, but the effect of this increase is small compared with the advantage gained. The coil is like an electromagnet, except that it has no iron core, and is surrounded by a magnetic field whenever a current flows through it. The larger the number of turns the larger this magnetic field will be, and the greater the amount of energy which can be stored in that field. The direction of the magnetic field around the coil is indicated in Figure 10 by the

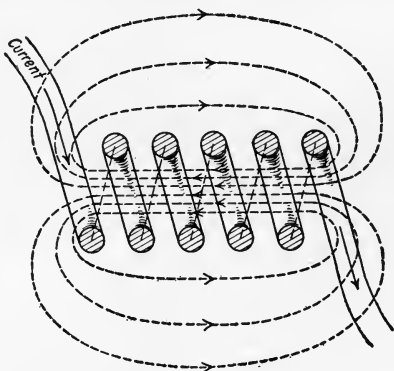

Figure 10

dotted lines, the coil being shown in cross-section. The direction of the field will be reversed when the current in the coil flows in the opposite direction.

The property of a coil or other portion of an electric circuit which enables it to store energy in its magnetic field is called inductance. While all current-carrying circuits are surrounded by magnetic fields, some are weak and the inductance of the circuit is said to be small, while other fields are powerful and the corresponding inductance is large. The inductance of a long single-layer coil having 100

turns of wire wound rather close together on a cylindrical tube is a little more than twice the inductance of a coil having half that many turns of the same wire similarly wound on the same tube. If the coil is of the more efficient type having a diameter two or three times its axial length, reducing the number of turns to one half will lower the inductance perhaps to one-third the original value.

How Tuning is Accomplished. — A tuning fork when given a single sharp blow will be set in vibration and consequently emit a sound of a definite pitch. The energy that has been given to it by the mechanical impulse is gradually dissipated by friction, but the musical note of the fork always maintains the same pitch. If the motion of the fork during its vibration is examined closely, it will be observed that the prongs move from their center position bb' , Figure 11, to cc' , then through bb' to

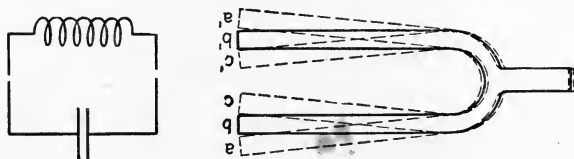

Figure 11

aa' , back to cc' , and so on. While passing through the center position, bb' , the energy possessed by the fork is all motional or kinetic energy, and while the prongs are momentarily at rest at their extreme positions, aa' or cc' , the energy is all in the form of an elastic stress, also termed potential energy. Thus the fork, during its vibration, continually transfers

energy from one form to the other, from potential to kinetic and back again to potential energy during one complete vibration. The rate of this energy transfer depends upon the material and dimensions of the fork; the longer and thinner the prongs the slower will be the rate of vibration and the lower the pitch of the sound emitted.

It is well known that a tuning fork may be set in vibration by the sound waves from a similar fork located some distance away. In this case the slight impulses of the air particles transmitting the sound wave acting upon the fork are exactly timed to correspond with its natural rate of oscillation, and strong vibrations are set up. This sympathetic vibration or resonance will occur only if the two forks have exactly the same pitch.

Electric circuits may also satisfy the conditions of vibrating bodies in that energy may be transferred from one form to another. The inductance of the circuit stores the motional or kinetic energy in the form of a magnetic field, and the capacitance of the circuit stores the potential energy in the form of an electric stress in the air between the condenser plates. Such a circuit, Figure 11, may be said to have a natural frequency of vibration, just as the tuning fork has a natural frequency or pitch. So the radio antenna, having capacitance with respect to ground and also inductance, has a definite natural frequency of oscillation. When this frequency is exactly suited to that of the radio waves which are to be received, they will set up oscillations in the antenna to the maximum extent and loud signals result; this condition is called electrical resonance.

Just as a tuning fork may have its vibration rate

altered by loading its prongs with weights, so also may an electric circuit have its natural frequency changed by loading it with inductance, that is, by adding turns to the coil in its circuit. In order to produce the maximum response in an antenna circuit, therefore, the number of turns of the coil is varied by moving a sliding contact. This process of variation is called tuning, and the coil is known as a slide-wire tuner. If the natural frequency of a receiving antenna is 1,000,000 cycles, that antenna will be most responsive to radio waves having a length of 300 meters. This result is obtained by dividing the frequency of the circuit into the velocity of the radio waves, namely, 300,000,000 meters per second. By increasing the inductance of the antenna its natural frequency will be lowered; in consequence it will be tuned for greater wavelengths.

Inductance is measured in units termed the henry, the millihenry (one one-thousandth of a henry or 0.001 henry), and the microhenry (one one-millionth of a henry or 0.000001 henry).

The tuning of a circuit may also be accomplished by varying its capacitance. Adding wire to the antenna, for example, will increase its capacitance. Increasing the capacitance of a circuit has the same effect on its natural wavelength as increasing its inductance. In fact, the product of the capacitance and the inductance of the circuit must have a definite value.

Capacitance is measured in units called the microfarad, the millimicrofarad (one one-thousandth of a microfarad or 0.001 microfarad), and the micro-microfarad (one one-millionth of a microfarad or 0.000001 microfarad).

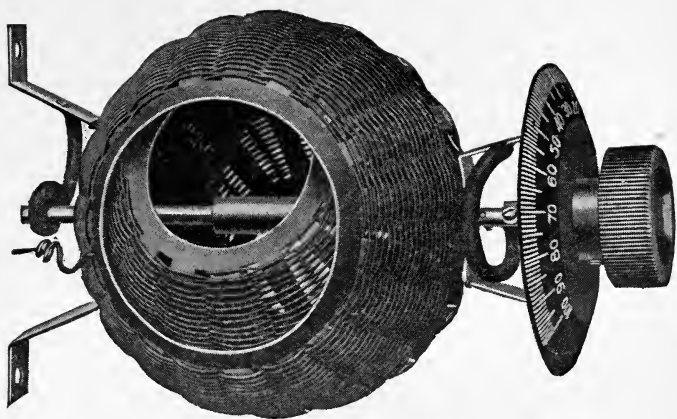

Plate III.— Above; "Basketball" variometer; *American Radio & Research Corporation*. Below: "Honey-comb" coils; *De Forest Radio Telephone & Telegraph Company*.

The capacitance of an air condenser having two sets of semicircular plates $3\frac{1}{2}$ inches in diameter, with 16 plates in each set, and having a separation of $\frac{1}{32}$ inch between plates of opposite sets, will have a maximum value of 1 millimicrofarad.

If a coil having an inductance of 0.052 millihenry is used with an aerial having a capacitance to ground of 700 micromicrofarads, the natural frequency of that circuit will be 833,000 cycles, and the wavelength to which it is most responsive will be 360 meters. In other words, radio waves of that length will establish alternating currents in the antenna circuit, the maximum current being that having a frequency of 833,000 cycles. Should either the capacitance or the inductance be quadrupled, the corresponding wavelength would only be doubled. Again, should the capacitance or inductance (or their product) be reduced to one-quarter of their initial value, the wavelength would be halved. Expressed technically, the wavelength in meters is equal to 1885 times the square root of the product of the capacitance in microfarads and the inductance in microhenrys.

Sharpness of Tuning. — In tuning a radio circuit it will be observed that small changes in the inductance or in the capacitance of the circuit greatly influence the strength of the current received. The effect is illustrated by the curve in Figure 12, which shows the value of the current received from a 360-meter wave when the antenna is tuned for various wavelengths. The shape of this so-called resonance curve indicates that the current strength falls off rapidly as the wave length to which the

antenna is tuned deviates from the length of the incoming radio waves. In the diagram the current at resonance, which occurs at 360 meters, is marked 100 units on an arbitrary scale. Should the wave-

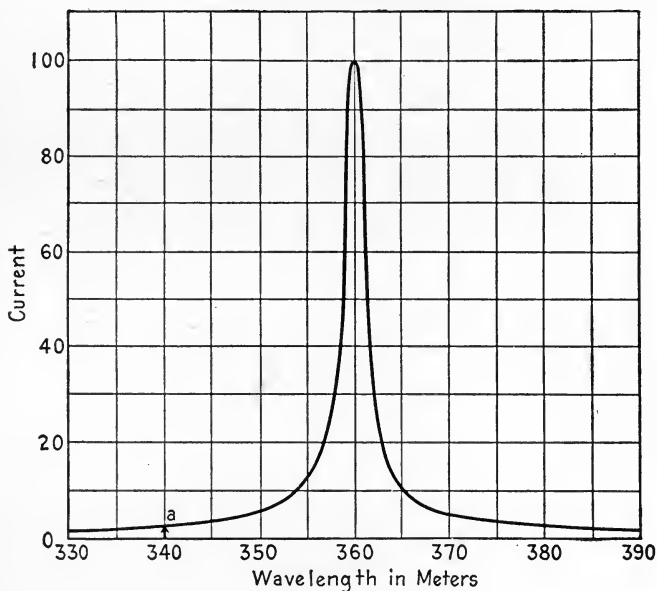

Figure 12

length to which the antenna is tuned be raised to 370 meters or lowered to 350 meters, the current received from the 360-meter wave would be reduced to about 6 units.

Now suppose two stations are transmitting, one at 340 and the other at 360 meters. If the receiving antenna just considered is tuned to receive the 340-meter wave, there would also be received the 360-meter wave at 3 per cent of its maximum intensity, as shown at *a* in the figure, thereby causing

interference. If the curve were narrower the interference would evidently be reduced, and the tuning would be termed sharp.

The sharpness of tuning is determined by the resistance of the circuit; the lower the resistance the sharper will be the resonance curve and the larger will be the received current. This is shown in Figure 13, in which curve *A* is the same as the curve of

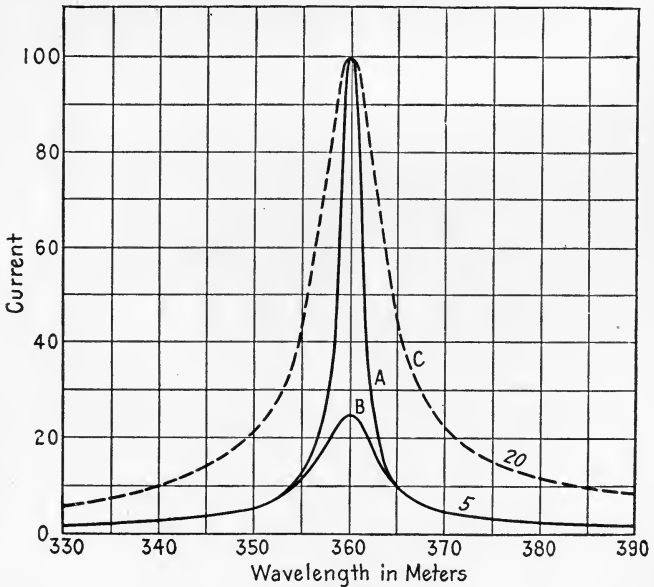

Figure 13

Figure 12 and shows the current in a circuit having a resistance of 5 ohms and an inductance of 0.3 millihenry, and curve *B* shows the current variation in the same circuit when the resistance is 20 ohms. To display more closely the broad tuning of the high-resistance circuit, the vertical scale of curve *B*

may be increased fourfold so as to bring the current at resonance up to the 100 mark; this magnified curve *C* is seen to be much wider than curve *A*. Thus, the higher the resistance of the circuit, the broader the tuning, and vice versa.

Practical Methods of Tuning. — The tuning of a circuit is affected by varying either its inductance or its capacitance, or both. The practical methods of adjusting these quantities must permit of quick and convenient operation, and the arrangements must also accommodate fine adjustments.

The simplest form of a tuning coil is a cylindrical winding of wire, the inductance of which is varied by increasing or decreasing the number of turns of the coil by means of a sliding contact, or sometimes two sliding contacts. Such a solenoid, while very easy to construct, has several objectionable characteristics. If the sliding contact touches two turns at the same time, a turn of wire is short-circuited and the current induced in it will be large and will act in opposition to the rest of the coil, thereby reducing the inductance unduly. This effect is observed by a disappearance of the received signals when the slider is moved slightly in either direction from a setting which yields strong signals. When only a small part of the entire winding of a tuning coil is used, the unused part or "dead end" nevertheless has voltage induced in it which causes a current to circulate through the distributed capacitance, and causes a reaction upon the used part, increasing its effective resistance. This effect is minimized by short-circuiting certain inactive portions of the winding.

The total inductance of a single-layer tuning coil, having 200 turns of No. 24 B. & S. gage (diameter = 0.020 inch) single silk covered copper wire closely wound on an insulating tube 4 inches in diameter and 5 inches long, is 2.6 millihenrys. The same number of turns of this wire wound on a tube 3 inches in diameter would result in an inductance of 1.6 millihenrys.

Consider a coil of wire to be composed of two parts, one part being wound on a cylindrical tube sufficiently smaller in diameter than the other to permit of its rotation inside of the outer cylindrical winding. These two parts are shown in Figure 14

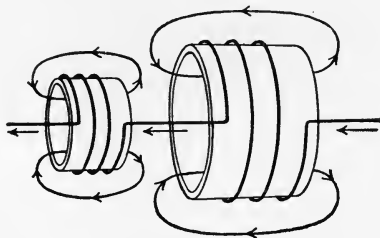

Figure 14

side by side for the sake of clearness. If the two parts are placed, one inside the other, so that the turns of both carry current in the same direction, the magnetic field will be greatest and the inductance will be a maximum. If the inner coil is rotated through half a revolution so that its magnetic field opposes that of the outer one, the resulting field will be small and the inductance of the coils will be small. Thus by changing the relative polarity of the two coils the inductance can be varied over a considerable range. Such an arrangement, called a

variometer, permits of fine gradations of the inductance, is compact, and has a constant resistance. However, for small inductance values its resistance is relatively higher than with a slide-wire tuner.

Even if the antenna is devoid of a tuning coil or variometer, it still has some inductance due to its ability to develop a magnetic field around the wires which compose the antenna. This inductance, together with the fixed capacity of the aerial wires with respect to ground, determines the natural wavelength of the circuit. This natural wavelength in the case of the ordinary inverted L type of antenna is usually from 4 to 5 times the sum of the length and height of the aerial wires, the measurement being in meters (1 meter = 3.3 feet).

In order to tune the antenna to wave lengths shorter than its natural wavelength, a condenser may be inserted in series with the antenna near its base. This so-called short-wave condenser used in receiving antennas is usually of the variable type. The smaller the capacitance of this condenser, the lower will be the wavelength; this wavelength can be reduced down to almost half of the natural wavelength of the antenna in this manner.

The effect of introducing a short-wave condenser in the antenna circuit, as well as the effect of increasing the inductance of that circuit by introducing a tuning coil or variometer, is shown in Figure 15. The natural wavelength of the circuit is 200 meters. Curve *A* shows the decrease in wavelength as the series capacitance is lessened, and *B* shows the increase in wavelength as the loading of the circuit is increased, the connection schemes being similarly lettered. These connection diagrams in-

indicate how a variable condenser and a variable inductance are usually represented; the absence of the arrow would show that the quantity is fixed.

At high frequencies the small capacitance between various portions of a coil of wire are of considerable importance. A coil alone may constitute a complete oscillating circuit by virtue of this so-called distrib-

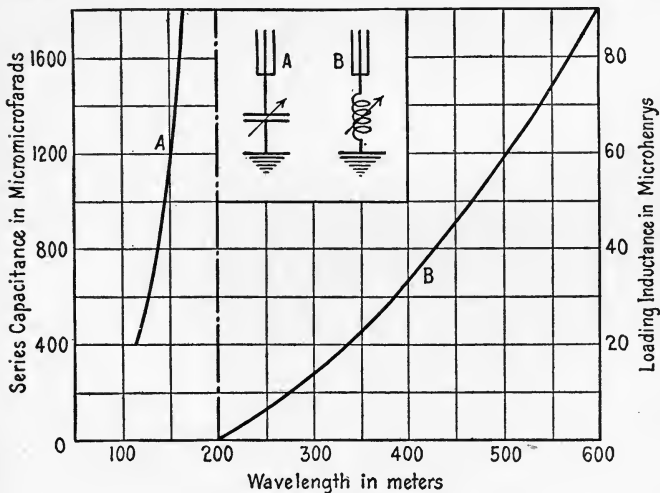

Figure 15

uted capacitance, even when the terminals of the coil are open. The dead-end turns of a tuning coil, for example, affect the energy loss and the frequency of resonance of its circuit. The reduction of coil capacitance is accomplished by special windings so designed that the voltage between adjacent portions is small. Multilayer coils of appropriate construction have relatively low distributed capacitance and small eddy-current loss, and are used extensively in radio circuits.

CHAPTER III

RECEIVING THE WAVES BY CRYSTAL DETECTORS

BY FRANK E. CANAVACIOL, E.E.

Instructor in Electrical Engineering, Polytechnic
Institute of Brooklyn.

Why a Detector is Necessary to Translate the Waves. — It has been shown in Chapter I that the currents flowing in the antenna circuit, corresponding to the speech or music sent from the transmitting station, are very complex. For example, the received current corresponding to the sound of "o" as in *low* is shown in Figure 16. This sound is composed of a series of surges of high frequency, perhaps reaching a thousand or more in number during the single wave of sound shown. The envelope of this curve, indicated by the dotted line, is the form of current which would produce this same sound in a telephone receiver. Therefore it is necessary to change these high-frequency oscillations into current variations similar to the envelope.

The metal diaphragm of the telephone receiver used in wire telephony is subjected to pulls which change in accordance with the current variations. The diaphragm vibrates as a consequence, and so produces sound. In the case of the radio telephone, attempts to apply this principle directly will bring out those difficulties which make the use of a de-

detector imperative. The first of these is, that a current of the frequency usually found in radio antennas cannot readily be sent through a telephone receiver, because the thousands of turns of very fine wire which constitute the active part of the electromagnet that operates the diaphragm, choke back such currents. Another difficulty lies in the diaphragm itself. Were it possible to pass such high-frequency currents through the windings just men-

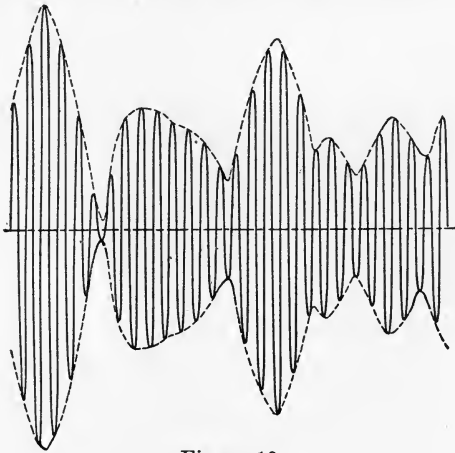

Figure 16

tioned, it would be necessary to supply a diaphragm which could respond to the resulting impulses. Such a diaphragm would be impracticable because it would have to be almost weightless. The lightest diaphragms produced can respond to frequencies of only a relatively few thousand cycles per second. Still a third obstacle is found in the human ear itself. The ear of the average person will respond to vibrations not higher than about 20,000 cycles

per second. It follows then that, were all the mechanical and electrical difficulties surmounted, the insensitiveness of the ear would still prevent the reception of such radio signals. It is evident then that the high-frequency currents must be so changed or transformed that they may readily pass through the telephone and affect the diaphragm at such frequencies as are audible to the ear. This may be accomplished by means of a detector; there are two forms: the crystal and the vacuum-tube detector. Each of these has its particular field of utility, so that both are extensively used to-day.

Characteristics of Crystal Detectors. — A crystal detector ordinarily consists of a mineral crystal, set in a suitable cup or clamping device. Contact is made with the crystal by means of a sharp steel or bronze wire. The crystal is set in an easily fusible metal such as solder or Wood's metal.

The operation of all crystal detectors is based upon uni-directional or one-way conductivity. If the wire be brought into contact with an appropriate spot on the surface of the crystal, currents will traverse the device in one direction far more easily than in the other. The direction or value of maximum current is unimportant. It is the *difference* in the two currents which determines how well or how poorly the crystal operates. It has been assumed above that the wire makes contact with the crystal at an appropriate spot.

If now the wire be shifted at random so as to make contact at another spot on the same crystal, it is likely that poor operation will result. Let it be assumed that such is the case. At such a point it

might be found that the current flowing as a result of a given voltage in one direction may be as large or even larger than before. But, when the voltage is reversed, the current might continue at about the same value. The difference between the two currents would be small and the operation consequently poor. Since a crystal has good and bad spots, the point of contact of the wire must be varied until satisfactory operation results. A good sample of crystal will have many good spots, whereas a poor sample will contain relatively few, which are then naturally difficult to locate.

Of the different crystals used for radio detection, galena or lead sulphide is probably the most

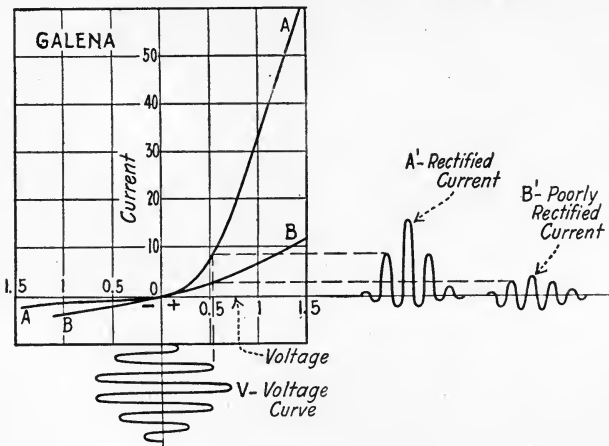

Figure 17

common. The characteristic curves of this crystal are given in Figure 17. Curve A represents operation at a good spot, while B shows the operation at a poor one on the same crystal. In this figure, the

voltage across the crystal is measured along the horizontal line; while the currents which flow through the crystal as a result of these voltages, are measured along the vertical axis. Curve *A* shows that at the particular spot on the crystal surface at which the curve was taken, a difference of electric pressure of one volt in one direction causes a current flow of 32 units, while the same voltage in the opposite direction produces a current flow of only 2 units, or a difference of 30 units. At the spot represented by curve *B*, the two currents for the same voltage are 7 and 4 units and the change of current but three units.

Should a crystal be placed in circuit with a simple antenna, as shown in Figure 18, the voltage

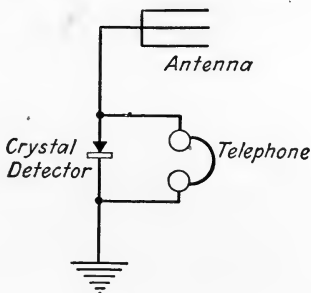

Figure 18

across it would vary according to the voltage induced in the antenna. Let these voltage variations be combined with curve *A* of Figure 17 and be represented by the waves *V*. The resulting current flowing through the crystal will then be as shown by curve *A'*. In this case the negative, or pulses below the horizontal axis, have been practically obliterated.

ated. This process is termed *rectification* because now the current flows practically in one direction. It is evident that the greater the difference in the conductivity of the crystal to voltages in opposite directions, the more perfect the rectification would be. Should the conductivity to negative voltages be zero, the rectification would be complete. On the other hand, if the voltage V is applied to curve B , rectification will be very incomplete, as shown at B' . The operation of galena may be regarded as characteristic of all crystals requiring no external battery. Lensite, cerusite, and silicon are of this class.

Another class of crystals, of which carborundum is typical, requires the use of an external battery for proper operation. Figure 19 shows the characteris-

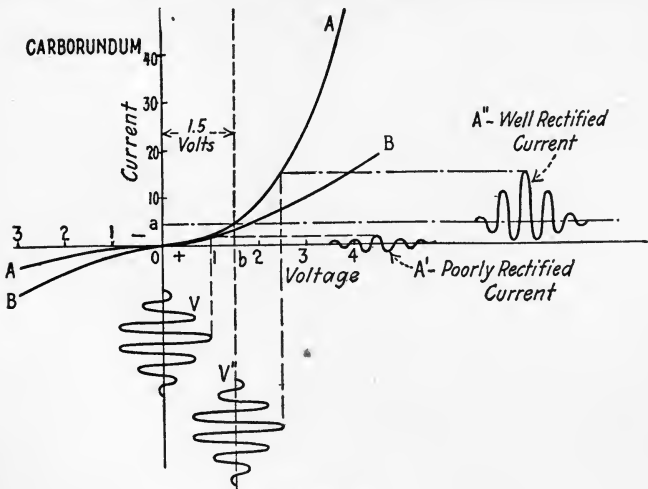

Figure 19

tics of carborundum. As before, curve A shows operation at a good spot, while B shows operation at

a poor one. A consideration of the former curve shows that if voltages impressed across the crystal vary from zero as a starting point through a small range on either side, the difference in the conductivity will not be marked. Applying the voltage curve V to curve A , there results the current curve A' , which indicates poor rectification. If now a battery of 1.5 volts be placed across the crystal, with due regard to polarity, the effect will be the same as though the current or vertical axis were shifted to the point of maximum curvature of line A . When the variations of voltage, represented by curve V , are impressed upon the crystal, the actual voltage would be shown by V'' and the current resulting, on a basis of curve A , would be curve A'' . Under these conditions the rectification is quite satisfactory. The polarizing voltage Ob , in this case 1.5 volts, varies for different samples of the crystal from 1 to 2 volts. However, the rectified currents in the case of carborundum for a given voltage change are materially smaller than those for galena. For this reason, galena is considered more sensitive than carborundum. The hard surface of the latter, however, makes its adjustment more permanent. In the case of galena, the soft surface is easily burned and the wire jarred out of adjustment.

A third class of crystal detectors is that in which two crystals are used instead of a crystal and wire. Perikon, a trade name for the zincite-chalcopyrite detector, chosen to illustrate this class, has characteristics shown in Figure 20. Curve A again indicates operation at a favorable point, and B operation at a poor one. It will be seen that these two curves do not differ materially, so that this detector is

admirably suited for conditions where jarring of the device is inevitable. Such crystals are frequently used on shipboard and for portable receiving stations.

The operation of crystals in conjunction with simple antennas may give rise to some difficulties. These may require changes in the antenna circuit.

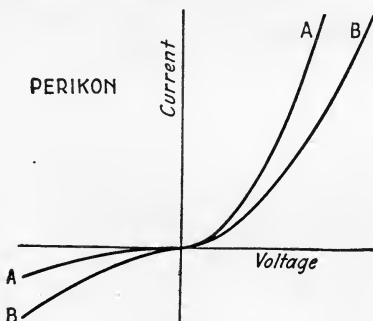

Figure 20

Coupled Circuits. — While the radio circuits considered so far have been simple, this type is not usually employed in receiving devices where best selectivity is desired. The simplest possible circuit would have the crystal detector placed in it as indicated in Figure 18. Such a circuit is objectionable because of the high electrical resistance of the detector. As was shown in the preceding chapter, the resistance radically limits the flow of current and it imparts very poor selective or tuning qualities to the circuit. This circuit is never used in practice. However, modifications of it are extensively used, and, although they render good service under certain conditions, they frequently retain some of the poor tuning qualities of the circuit of Figure 18.

By removing the detector resistance from the antenna circuit, the characteristic or resonance curve shown as *A* in Figure 21 will change to *B*. Under this condition tuning is said to be sharp; so that interference is greatly reduced. Assuming two sending stations to be in operation on neighboring wavelengths, as indicated at *o* and *c*. With a simple receiving antenna tuned to wavelength *o*, the strength of signal desired will be *oa* and that of the

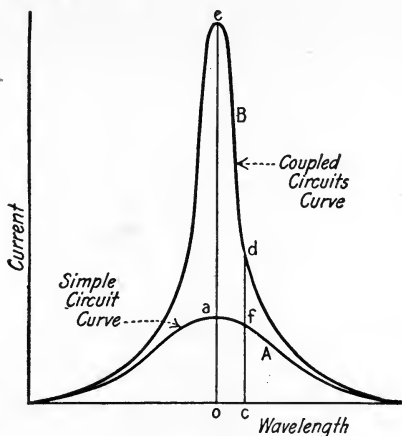

Figure 21

undesired wavelength will be *cf*; however, with the coupled-circuit antenna the corresponding strengths of signal will be *oe* and *cd*. Thus the interfering station has a lesser effect with coupled circuits than with the simple antenna circuit.

With coupled circuits the position occupied by the crystal and telephones in the simple circuit, Figure 18, is taken by a primary coil *P*, shown in Figure 22. Near *P* is placed coaxially a second coil *S*, similar but usually smaller in size than *P*. As currents flow

through P , magnetic fields will be established through the coil as shown by the dotted lines. These magnetic lines represent energy which may be collected by the secondary coil S . The closer S is to P , the greater will be the field from P which affects S ; consequently, the closer S is to P , the greater will be the transfer of energy. Also, the greater the number of turns of S , the greater will be the voltage induced in it. The secondary coil may also be

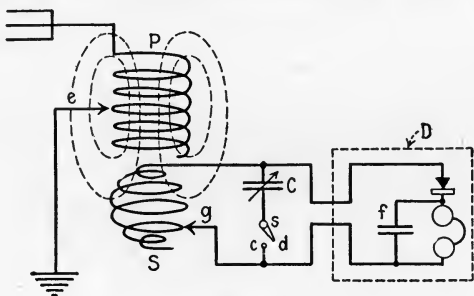

Figure 22

mounted so as to be capable of rotation about an axis perpendicular to that of P . In such case, S will be most affected by P when the axes of the two coils coincide. The least effect is produced when the axis of coil S is at right angles to that of P .

As not all the lines of force from P are intercepted by S , only a portion of the energy in P is transferred to it. For this reason the circuit associated with coil S should be so arranged as to absorb this power to the best advantage. This is accomplished by inserting a variable condenser such as C in the circuit. By reference to Chapter II, it may be seen that the circuit consisting of S and C is an oscillatory one by virtue of its inductance S and its capacitance C ,

both of which may be varied to bring this secondary circuit into tune or resonance with the primary or antenna circuit. By so doing the current in this circuit will be a maximum.

If the listener desires to tune his set to receive radio messages he moves switch s to the position d , and places the coil S in the closest possible relation to P ; this is termed "close coupling." The slider e is moved slowly along the coil P , thereby tuning the antenna to different wavelengths successively. Let it be assumed that at a given position of e , two or more stations are heard, and that the message of one be of interest to the listener. The slide e is moved to that position at which the desired signals are heard loudest. Switch s is then closed at c , after which C and slider g are varied until the interfering signals are excluded. This will probably result only after the coil S has been moved considerably away from P . The amount of necessary "loosening" of the coupling between the two coils will depend upon how nearly the wavelength of the interfering station approaches that of the desired one. The nearer these two wavelengths are to each other, the "looser" must the coupling be. The effect of loosening the coupling is to make the curve of Figure 21 sharper.

The coupling described above is known as *inductive coupling*, and utilizes the magnetic field to transfer the power from the primary to the secondary circuit. In another method of bringing two circuits into mutual electrical relation the static field or the electric lines of force between the plates of a condenser are used. An example of such coupling is shown at the left in Figure 23. Still a third

method is shown at the right of the same figure. This is known as *conductive coupling*. This method is frequently used, and, by proper manipulation, yields very satisfactory results.

It has been shown that the simple circuit has very poor tuning qualities due to its high resistance. By coupling the circuits the tuning is greatly improved.

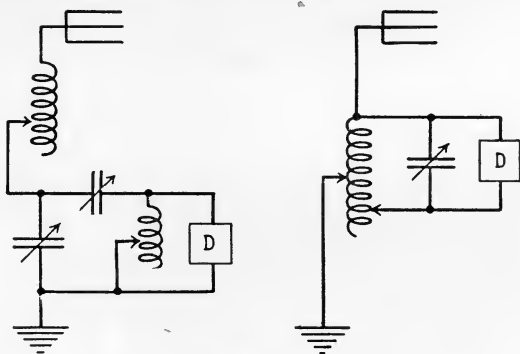

Figure 23

For this reason all receiving devices which must operate through interference, use coupled circuits.

Coördination of the Elements of the Detector Circuit. — It will be recalled that the operation of a crystal detector is fundamentally that of a rectifier of alternating currents. Curve *A'* of Figure 17 shows the result of applying an alternating voltage to such a crystal. Although the currents are now practically rectified, they still retain their high frequency character; that is, although the currents now flow only in one direction, still they vary at the same frequency that they did before rectification. The same problem of before, namely that of making high

frequency variations audible is still present. This may be solved, however, by the use of a pair of telephones and a condenser.

If the circuit $S-C$ of Figure 22 is tuned to the desired signals, the oscillatory current which flows through the condenser C is accompanied by a corresponding difference of voltage across the condenser. When the detector and telephones are placed in the circuit as shown, this difference of voltage is transferred to that circuit also. Let this voltage be represented by a curve such as V of Figure 17. The current flowing through the crystal will then be shown by curve A' of the same figure. Since this current cannot pass through the telephones, on account of their great inductance, it takes the path through the condenser, f , of Figure 22. As each current pulse is transmitted through this condenser, it places a charge on the plates. This charge will be proportional to the area included by the outline of the individual pulse and the horizontal axis. As the telephones are placed directly across the condenser, this charge readily leaks off through them, thereby giving rise to a current. The shape of the curve of this current is similar to that of the envelope of the individual pulses in the detector current. Thus, by means of the detector and the condenser f , the telephones are made to operate as do telephones in wire telephony.

Now and then a crystal detector set is found in which the condenser f is missing. If there really were no capacitance in the circuit, the high-frequency currents would find no suitable path, as the impedance of the circuit is almost infinite to such high frequencies. In this case no operation would

result. Actually, however, the circuit will operate, although poorly. A close consideration of the telephones will explain this. The leads of the telephones are close together for a length of several feet. They then may be considered as constituting the two plates of a condenser. Also, between the turns in the winding of the telephones such condenser action occurs. It will then be seen that even if the condenser be omitted, a certain amount of capacitance will still be distributed along the circuit of the telephones which acts in place of condenser f , and so permits operation. As this capacitance is slight, the operation is poorer than if the condenser had been used.

The telephone of the radio receiver consists of a permanent magnet, around each pole of which is wound a bobbin of wire. The greater the number of turns in each of these bobbins, the more sensitive will the telephones be. In good telephone sets, the number of turns reaches many thousands, and the wire used is necessarily very fine; as a result the resistance of the sets is high. The resistance of the telephones may be taken as an indication of the number of turns on the bobbins, and consequently of the relative sensitivity of the telephones. It should be borne in mind that although the resistance may be such an indicator, it need not be so under all conditions. Unscrupulous manufacturers have used German silver wire instead of copper wire for the bobbins, resulting in a high resistance with a relatively small number of turns. Of course, such telephones are worthless.

The coils on the the bobbin carry all the current that flows through the telephone set. In order

that the effect of this current may be proportional to the current, the permanent magnet mentioned above is inserted. The iron diaphragm is placed over the poles of this magnet, and held in position by means of the cover and the action of the poles. Should a current pass through the coils of the bobbins, the pull of the poles on the diaphragm will be varied. This variation causes the vibration of the diaphragm and the consequent production of sound. Figure 24 illustrates this type of telephone.

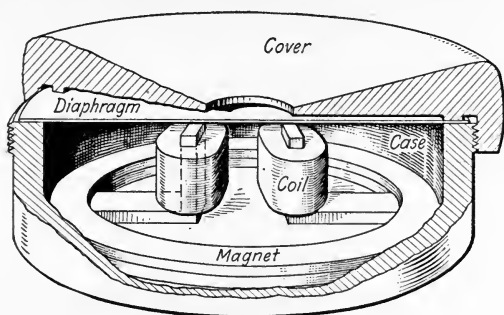

Figure 24

The operation of the type of telephone just described is satisfactory in most cases. Where an extraordinary degree of sensitivity is desired, however, this type fails, because of the rigidity of the relatively-heavy metal diaphragm. This objection has been overcome in the Baldwin telephone, which is shown in Figure 25. The permanent magnet and bobbins are similar to those used in the ordinary receiver. The lever-diaphragm, *a*, of iron, is pivoted at the center and so placed with respect to the poles *pp*, that no force is brought to bear upon it when no current flows. This diaphragm acts as a lever in

that it actuates member *l*, rigidly attached to one end. This member is also anchored at its other end to the mica diaphragm *m*, which is the producer of the sounds. As the currents flow through the bobbins *bb*, the lever-diaphragm vibrates about its center point, thereby operating the mica diaphragm. This type of receiver is not only more

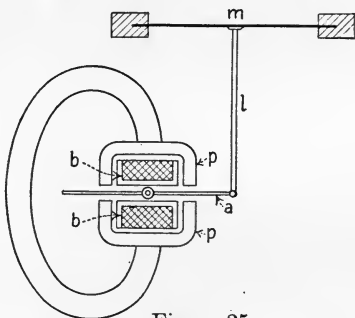

Figure 25

sensitive than the ordinary one, but also better because of the purity of the sounds produced. This is due in great measure to the lack of metallic ring in the tones emitted.

Typical Crystal Detector Set. — Figure 26 illustrates the wiring diagram of a crystal detector set which, although elaborate, will afford good tuning qualities, and respond to a wide range of wavelengths. It will be noted that the antenna circuit includes the primary coil and a short-wave variable condenser. The coil *P* consists of 60 turns of wire wound upon a cylindrical tube about 3 inches in diameter. A tap is carried out at every tenth turn, as indicated. By moving the switch, *A*, to include more turns in the circuit, the wavelength of the antenna is

increased; a decrease in the number of turns decreases the wavelength. Similarly, when the capacitance of the condenser B is increased, the wavelength is increased, and vice versa. By manipulating P and B simultaneously very fine tuning of the

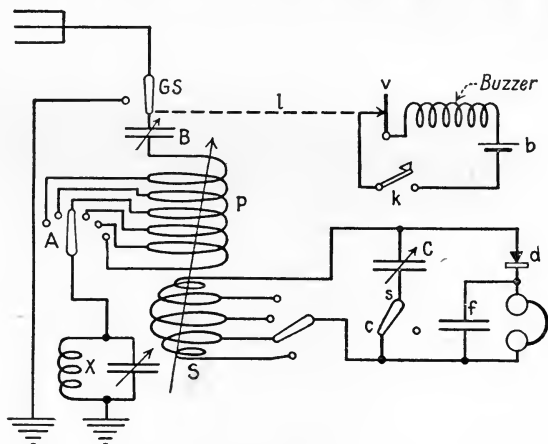

Figure 26

antenna circuit is possible. The maximum capacitance of B is 0.0005 microfarads.

The secondary circuit consists of another inductance S , also consisting of 60 turns of wire, and a variable condenser C . The coil S is wound on spherical mounting placed near one end of the cylinder supporting P . The coil S is so arranged that its axis may be shifted from coincidence with the axis of P , to a position displaced 90 degrees from it, thus varying the coupling from a maximum to a minimum. To facilitate tuning, the coil S is tapped at every 15 turns and the taps are brought out to a suitable switch. The condenser C is similar to condenser B , and may be inserted in the secondary cir-

cuit or omitted therefrom by means of switch *s*. The telephones, which should have a resistance of about 3000 ohms, are placed in circuit with the detector and the fixed blocking condenser *f*, as shown in the diagram. Condenser *f* should have a capacitance of 0.002 microfarads. The detector *d* may be either a galena or a silicon crystal.

In order to find a sensitive position on the crystal, a small buzzer is often employed. The circuit of this buzzer also is shown in Figure 26; the letters *b* and *k* signify respectively the battery and the key. A lead, *l*, is taken from one side of the vibrator *V*, and attached to the antenna or ground terminal of the set. With *k* closed, the surface of the crystal is explored until buzzing in the head telephones indicates a sensitive spot.

Tuning of this set is accomplished in a manner similar to the one described above. The only difference in this case is that for each setting of the switch *A*, the condenser *B* is varied throughout its entire range.

The above receiving device gave excellent results when connected to a two-wire, inverted L type antenna, having a height of 20 feet and a length for the horizontal portion of 50 feet. Care must be taken not to omit the antenna grounding switch *GS*, since a good grounding switch affords protection against lightning, while a poor switch or the total absence of one introduces a lightning hazard.

Interference. — Perhaps the most annoying feature of radio telephony and telegraphy is interference by outside stations or sources. In some cases, this interference may be removed while in others,

it must be endured. Interference may be subdivided into three distinct classes. In the first may be included all interference resulting from poor tuning either at the transmitting or receiving stations, or at both. The second class includes all disturbances due to the close proximity of high-power spark stations and power lines. The third class results from static discharges and the sparking of electrical machinery such as motors, elevators and trolley cars.

Disturbances included in the first class are the result of poorly designed receiving or transmitting stations. The fundamental fault in these cases lies in the broad resonance curve of the station.

When a receiving station having such a characteristic listens to a transmitting station, and a third station begins transmitting, both stations will be heard almost equally well. An attempt at tuning out the disturbance will help very little. The only remedy then is to rewind the coil so as to present as little resistance to the oscillating circuit as possible and also to reduce the coupling still further. Should the receiving apparatus be well constructed, interference may be introduced by a third station also. Assume the receiver to be tuned to the properly-designed and operated sending station, and that a second sending station starts transmitting at some wavelength different from that being employed by the two stations mentioned.

If the second transmitter has a broad resonance curve, it will not transmit at only one wavelength, but will do so over a considerable range of wavelengths. The result will be that the two stations first mentioned will be interfered with if their wavelength is included in the range covered by the

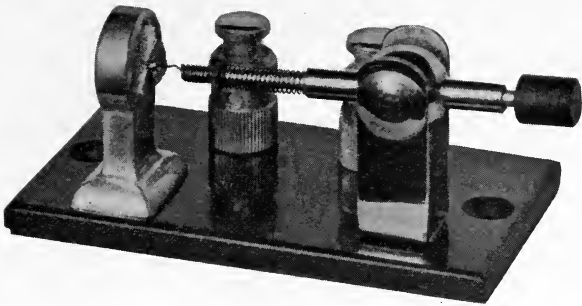

Plate IV.— Above: Crystal detector; *Wireless Specialty Apparatus Company*. Below: “Aeriola, Jr.,” crystal-detector receiving set; *Westinghouse Electric & Manufacturing Co.*

offending station. The only means of removing this annoyance is tactfully to inform the offender, who in all probability will be anxious to improve the tuning qualities of his transmitting apparatus.

Interference resulting from high-power spark telegraph stations situated close to the receiving station may be eliminated by inserting an absorption circuit at the base of the antenna. This circuit is shown as *X* in Figure 26. In order to suppress a disturbing station, this absorption circuit is tuned until the interference is blotted out. Thereafter the antenna is tuned to the desired station; the rest of the tuning being continued as previously outlined. This method of interference elimination is very effective in dealing with disturbances from nearby alternating-current power lines.

The third class of disturbances usually includes those due to atmospheric conditions. The so-called static disturbance is due to static discharges from the clouds or moisture in the air, through the antenna, to the earth; it is most frequently experienced during the summer. As the particles of moisture in the atmosphere are moved about by currents of air, they pick up free charges of electricity which are always present. Under favorable conditions, a cloud may gather enough charges so that the aggregate will produce a flash of lightning. If a cloud or group of charged moisture particles passes over an antenna, the charges held on the cloud will attract opposite charges in the ground. These charges rise by means of the antenna and their resulting motion through the antenna will constitute a momentary current, the flow of which will be indicated in the telephones by the familiar crackling sound.

Types of Antennas. — It has been shown that ether waves induce voltages in an antenna circuit. The higher the antenna, the greater will be this voltage. Although much has been said about the directional effect of the receiving antenna, the fact is that with T, inverted L or other antennas which are normally used in radio reception, signals are received with practically equal facility from all directions. It is true that if the horizontal portion of an inverted L antenna is extended to a length many times (for example 20 times) the height, some directional discrimination may be observed. Such arrangements are relatively rare in present-day practice.

The location of an antenna affects its operation somewhat. As an antenna receives its power from the ether waves, care should be exercised to choose a location relatively free from conducting structures, such as the steel in steel buildings, or metal roofs, or trees. All these devices act as antennas and absorb power. Since their size is far greater than the size of the wire antenna, they will absorb most of the energy of the ether waves, leaving little, if any, for the wire antenna to draw upon. The T, inverted L and fan type antennas are usually set outdoors.

A type of antenna now rapidly growing in popularity is the coil or loop. This device, on account of its small size is usually erected indoors. Its use, although frequently limited to vacuum-tube sets involving amplification, may be extended to crystal sets when the range of transmission is small.

The directional properties of the loop are very marked, the device receiving best in a direction coincident with its vertical plane. Because of this

fact, and the ease with which its plane may be changed, the loop antenna is used almost exclusively for direction finding. To find the position of a sending station, two loops, one at each of two different receiving stations, are required. Let one of the receiving stations be located at x in Figure 27A. As the signals are heard, the loop at that station is shifted into the direction of maximum sound. This direction is plotted on a suitable map as the line aa . The station sought must be located along this line. The loop antenna at station y is similarly turned to

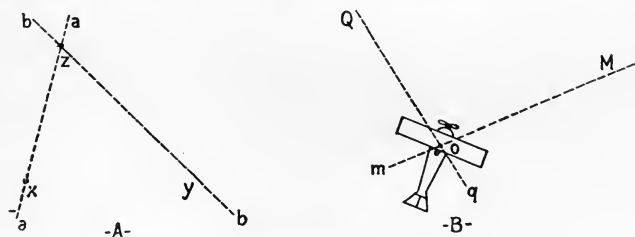

Figure 27

the direction of maximum response. At y it is found that the station in question lies along the line bb . Since the station to be located must lie along both of the lines aa and bb , it must be located at their intersection z .

The loop is also used to determine the position of moving receiving stations, such as ships or airplanes. In this case signals are received from two stations, the locations of which are known. In an airplane, the loop antenna may be mounted between a pair of wing struts. The pilot maneuvers his craft until the loudest signals are heard from one of the stations referred to. The direction of the plane, and consequently that of the coil, yielding the loudest

signals, is plotted as the line Qq in Figure 27B, wherein Q represents the position on a map of the station from which the signals have been received. The position of the plane is varied again so as to receive signals from the second station M . The direction of maximum response in the telephones is plotted as Mm . The position of the plane must then be that of the intersection O of the two lines.

CHAPTER IV

THE VACUUM TUBE

BY JOHN H. MORECROFT, E.E.

Associate Professor of Electrical Engineering, Columbia University; Fellow, American Institute of Electrical Engineers.

What the Vacuum Tube Is. — The vacuum tube is a small glass vessel, much like a small electric lamp, evacuated so as to be nearly free from gas, with three metallic terminals, or electrodes, inside. That is about all that one can see in these small vacuum tubes which constitute the heart of many modern radio receiving outfits, but one who is acquainted with the history of its development during the last twenty years, will recognize in the same little tube one of the most important advances in the realm of Physics. Besides being of immeasurable importance to the radio engineer, this small tube with its three electrodes will shortly be a necessity to practically every scientific worker, no matter what his field. Nearly all scientific problems involve the action of electric currents and the vacuum tube permits the study of these currents to an accuracy thousands of times greater than has hitherto been possible.

Tungsten, which is the metal used for the filament of most vacuum tubes, is extremely hard, and is one

of the most dense of metals. But to the scientist this metal, like all other solid bodies, is spongy and porous in nature, being made up of an extraordinarily large number of atoms or molecules. These atoms consist of a nucleus, or positively charged portion, around which are placed many electrons, these electrons being individual negative electric charges. The size, mass, and charge of an electron are accurately known from the results of experimental measurement; moreover, the electron is the same in size, charge, and nature, no matter from what kind of an atom it is taken.

The atoms of all bodies consist of positive nuclei, surrounded by different groupings of electrons, the different groupings of electrons differentiating the elements from each other. In most substances all the electrons are held firmly to the atom, but in metals it seems that one electron, at least, is free to leave the atom and wander around among the other atoms. It is these free electrons which, by their concerted motion, or drift, through the conductor constitute the electric current in that conductor.

The atoms, as well as the free electrons, of a metal are continually in violent agitation, having a haphazard to-and-fro motion at a speed of several hundred feet per second; if the metal is heated this to-and-fro motion rapidly increases. With very high temperatures the atoms move so rapidly that some of them (those having the highest speed) actually jump away from the rest of the atoms. The metal is then said to be evaporating, a phenomenon which occurs in every tungsten lamp. The evaporated tungsten condenses on the inside of the glass bulb and gradually blackens it.

About 1900, Richardson predicted, entirely from theoretical reasoning, that if a metal were sufficiently heated electrons would evaporate from it, and that these evaporated electrons would be the same no matter from what metal they were obtained. He performed a series of experiments which confirmed his theoretical conclusions. Other experimenters, however, obtained contradictory results, so for some years the validity of Richardson's theory was in dispute and it was not until about 1912 that the idea of the evaporation of electrons from hot bodies was completely established. This theory leads to the important conclusion that electrons can freely leave the surface of a hot metal but cannot leave the surface of a cold metal to any appreciable extent. The word "cold" in this sense is a relative one; any metal below a dull red heat is cold in the sense of the word as here used.

In the early days of the carbon incandescent lamp, Edison noted a phenomenon which could not be explained at that time. A metal plate was sealed inside the lamp bulb between the two sides of the filament, the plate being entirely insulated from the filament itself. When the outside terminal of the plate was connected to the positive terminal of the filament through a galvanometer, a current was observed to flow, whereas, if the connection was made to the negative terminal of the filament, no current could be detected. It is now known that this action is due to the fact that when the plate was made positive (by connecting it to the positive end of the filament) the electrons which were evaporating from the incandescent filament were attracted to the plate and so set up a current; whereas, when

the plate was connected to the negative end of the filament it was made negative, and so it repelled the electrons which were being evaporated, thus no current could flow. It is to be remembered that the electrons could not get off the plate to flow to the filament because the plate was a cold metal from which electrons cannot escape.

It will be noticed in Figure 28 that there is a hot filament and a cold plate in the same evacuated

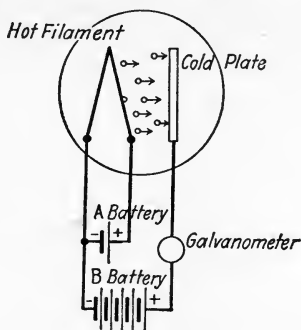

Figure 28

vessel. If the plate be made positive with respect to the hot filament, the electrons evaporating from the filament will be attracted to the plate. They enter the plate and then flow through the connecting wires, through the galvanometer and battery, back to the filament, from which they again evaporate and continue their course. If now the battery in the plate circuit be reversed, making the plate negative with respect to the filament, the electrons will be repelled by the plate and so reënter the filament; for this connection therefore, there is no current in the plate circuit. The two-electrode tube, as this is called, is thus a rectifier, permitting the flow of

current in one direction only. As such, it evidently has about the same characteristics as the crystal detector and it was used to some extent in the place of a crystal in the early days of radio communication. It was called the Fleming valve, after the investigator who showed the applicability of the tube to radio reception.

Soon after Fleming showed the use of the two-electrode tube in radio, De Forest conceived the idea of introducing a third electrode into the tube, this third electrode being in the form of a metallic mesh of some form or other, past which the electrons must go on their way from the filament to the plate. This third electrode, which he named the grid, was to serve as a control of the flow of the electrons to the plate. The introduction of this grid into the vacuum tube was probably the most important single step which has been made in the advancement of the art of radio communication. It opened up tremendous possibilities for increasing the sensitiveness of the receiving apparatus used in radio signalling, and made possible practically all the uses to which the modern vacuum tube is put.

By making the grid alternately positive and negative, the amount of current flowing from the hot filament to the plate can be increased and decreased, the grid itself taking practically no power, but serving as a gate-valve controlling the plate current.

The early tube as built by De Forest and called the audion, was a very sensitive detector of radio signals but was rather erratic in its behavior, for it was found to work well one day and poorly the next. There were many actions which took place in the tube for which there was no plausible explanation,

but which are known to have been due to the effect of the various gases left in the tube after the rather imperfect evacuation to which the early tubes were subjected.

About 1912 the research laboratories of two of the largest electrical companies in America took up the intensive study of the three-electrode tube, bringing to bear on the problem tremendous material resources and large staffs of highly trained experimenters. The processes of evacuation were greatly improved, a complete study of the action of the various gases on electron evaporation was carried out, the effects of gases absorbed in the metal of the electrodes and the glass walls of the tube were taken up, and the tubes soon became dependable and reproducible in their characteristics. They were first used as telephone repeaters in long distance lines, and during the war were intensively developed and used in radio communication systems.

The work referred to above was carried out by research physicists who left nothing to chance, but analyzed each peculiar property of the tube; principal among these workers were Langmuir and van der Bijl. From the results of their work, it is now possible to calculate the proper proportions of a vacuum tube to fit it to any particular work, and know that it will fit its requirements.

Most of the tubes available today use tungsten wire for the hot electrode from which the electrons are made to evaporate. Tungsten is used because of the high temperature at which the metal itself begins to evaporate; plenty of electron emission may be obtained at temperatures sufficiently low to give the filament a reasonably long life (1000 hours).



Plate V.—Above: Vacuum tube for detection; below: Tube socket and filament rheostat; *Radio Corporation of America.*

Another type of hot electrode is made of a thin, narrow platinum ribbon to which has been cemented a thin coating of certain oxides. It was first shown by Wehnelt that an oxide coating so changed the conditions at the surface of a metal that it gave off electrons freely at temperatures much lower than would be required if the pure metal itself were used. These oxide-coated filaments require about half as much power to evaporate in a given time the same number of electrons as do filaments of pure metals like tungsten, and they are especially suitable for detecting and amplifying tubes.

Tubes for use in radio circuits must be thoroughly evacuated or else they are likely to be erratic in their behavior. This evacuation process involves not merely pumping out most of the air which is in the glass bulb but taking most of it out of the metallic parts and inside walls of the glass bulb itself. Due to the recent invention of special vacuum pumps, the tubes may now be more thoroughly freed from air than was commercially feasible in the earlier tubes. While the tube is connected to the pumps, it is thoroughly heated, the metallic parts at a white heat and the glass bulb as hot as it will stand without collapsing. This heating process drives out most of the gas which has been soaked up in the glass and tungsten, and then the pumps carry it off.

In certain types of detector tubes, called gas tubes, or soft tubes, a small amount of gas is introduced. Such tubes require more careful adjustment to get good results, but when the proper conditions have been reached, these tubes are somewhat more sensitive for detectors than the highly evacuated ones.

It should be remembered, when thinking of vacuum tubes as not containing any gas, that with the highest vacuum commercially obtainable today, there are still left in the tube one hundred million molecules of gas per cubic centimeter of space.

Characteristic Curves of the Three-Electrode Tube. — The hot electrode is generally a filament of tungsten, heated by passing an electric current through it. The battery used for this purpose is generally a storage battery of two or three cells, but in some especially small tubes a smaller current at a lower voltage is used and in these a six-inch dry cell suffices for lighting the filament. The filament battery is frequently referred to as the A battery. It is advisable to have a rheostat in series with the filament to regulate its current, as the voltage of the A battery changes with discharge.

To attract the electrons sufficiently to the plate in the ordinary tube its voltage must be kept about twenty volts positive with respect to the filament. Small dry cells serve well for this purpose, fifteen of them in series being generally used, giving 22.5 volts when first put in service. This voltage falls off with continued use and when the voltage has fallen to 15 volts the cells should be discarded for new ones. The life of these plate batteries is about a year in normal use, but if they are completely imbedded in a wax, such as paraffine, they sometimes last as long as two years. This battery is usually referred to as the B battery.

As the electrons pass from the filament to the plate they have to go through the interstices of the grid; this path permits the grid to control the rate

at which electrons are able to get to the plate. If the grid is made positive with respect to the filament, the plate current is increased and if it is made negative the plate current is decreased. If the grid is held at constant potential and the plate voltage is varied, the plate current will vary in a similar manner, but the grid voltage is much more effective in controlling the plate current than is the plate

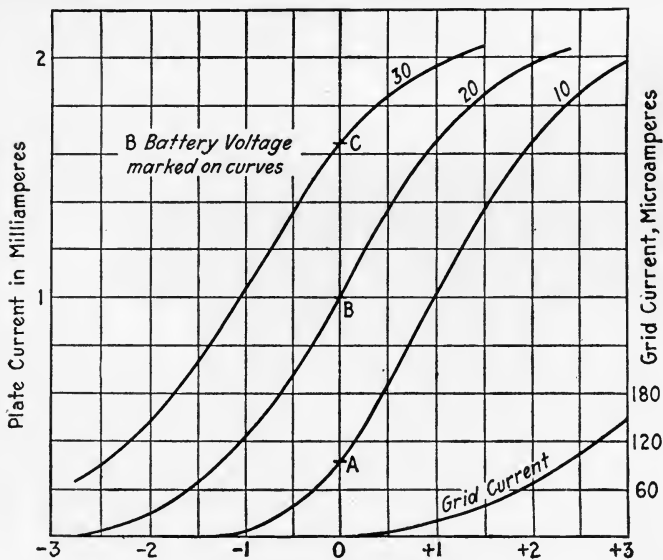

Figure 29 Grid Voltage

voltage. In the average tube used in receiving sets, increasing the potential of the grid one volt will produce as much increase in plate current as will be brought about by increasing the plate voltage by five to ten volts.

In Figure 29 are shown typical curves for an ordinary detector or amplifier tube for three values

of plate voltage. The plate currents for zero grid voltage are A , B and C for plate voltages of 10, 20 and 30 volts respectively. It will be seen that as the grid voltage is made more positive (or less negative) the plate current will increase rapidly until the curve starts to turn over and become horizontal at the higher grid potentials.

From the picture of the vacuum tube so far presented, it will be evident that the space between the filament and plate is full of electrons, some of them on their way over to the plate and others falling back into the filament from which they have been evaporated. These electrons, in the space between the filament and plate make up the *space charge* of the tube. This space charge is all negative electricity and so repels other electrons being evaporated from the filament, thus tending to push them back into the filament from which they have just come. Due to this action, the plate does not receive all of the electrons which evaporate, many of them falling back into the filament.

The action of the grid in controlling the amount of the plate current is most accurately explained from the standpoint of space charge; a negative grid assists the space charge in limiting the plate current and a positive grid tends to neutralize the effect of the space charge, thus permitting more of the electrons to get to the plate.

It will be noticed in Figure 29 that there is apparently a limit to the amount of plate current which can flow through a given tube with a certain filament temperature; all the plate current curves flatten over for the higher grid voltages. This limit of the plate current is due to the limited number

of electrons being evaporated from the filament. As the plate or grid voltage increases, the plate current increases, taking a greater and greater fraction of the electrons evaporated until at a certain value of voltage all of the electrons evaporated are drawn over to the plate; further increase in grid or plate voltage cannot increase the plate current.

This limiting value of plate current is called saturation current. It depends altogether upon the temperature of the filament, increasing very rapidly for temperatures above a certain value (white heat for tungsten, and dull red heat for oxide-coated filaments). The temperature of the filament must always be sufficiently high so that the normal plate and grid voltages do not cause saturation current to flow; were such the case the grid could not control the plate current and so the tube would be inoperative.

In Figure 29 is also shown one grid current curve, this one corresponding to twenty volts on the plate; the other plate voltages give very nearly the same grid current curves. It will be noticed that the grid current is very much smaller than the plate current and that for negative grid potential, the grid current is zero; when the grid voltage reverses the grid current cannot reverse, as electrons cannot leave the grid, it being cold.

The filament should never be operated with the filament current greater than necessary, because the tungsten itself evaporates rapidly as the metal is brought to dazzling white heat and the life of the filament (and hence the tube) is very much decreased at the higher temperatures. A detector tube operated at normal filament current should have a useful life of at least one thousand hours.

In a tungsten filament tube, highly evacuated, excessive plate voltage is not likely to do harm, but practically nothing is gained by using a voltage in excess of that for which the tube is rated, and sometimes the higher voltage makes its operation as a detector poorer. If the tube is a soft one, having appreciable gas in it, or the filament is an oxide-coated one, excessive plate voltage is likely to cause ionization (electrical break-down) of the gas contained in the tube. Ionization is accompanied by a pale blue glow in the tube. When ionized, the tube will generally not detect; to eliminate the condition of ionization, the plate voltage must be reduced sufficiently before the tube will function properly.

Action of the Tube with No Grid Condenser. — As shown in the discussion of the crystal rectifier, a detecting device must so act that when a high-fre-

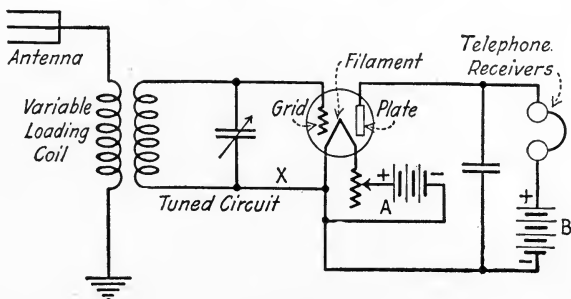

Figure 30

quency voltage, of varying amplitude, is impressed upon it, the current in the telephone will follow the variations of amplitude of the high-frequency current. The arrangement of the three-electrode tube when being used as a detector is that shown in

Figure 30, when no condenser is used in series with the grid. While high-frequency currents of variable amplitude flow in the closed tuned circuit coupled to the antenna the current flowing through the B battery, telephones, and plate-to-filament circuit of the tube follows the fluctuations of amplitude of the current in the tuned circuit.

In Figure 31 is reproduced part of the curve of Figure 29. When no signal is coming in, the grid

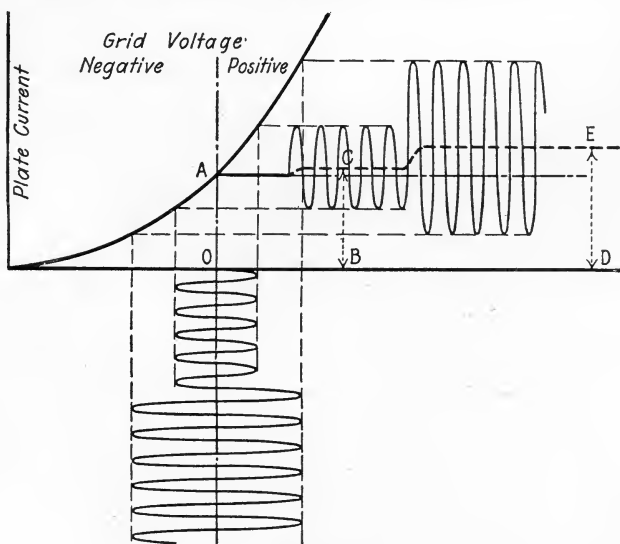

Figure 31

voltage stays at zero and the plate current (likewise the telephone current) remains at the value OA . If now an alternating voltage is impressed between the grid and filament, the plate current must alternately increase and decrease, the amount of variation depending upon the amplitude of voltage

impressed on the grid. In Figure 31 it is assumed that a small alternating voltage is impressed on the grid for a few cycles and that then the voltage is increased to about twice its value. The variation in grid voltage and the corresponding change in plate current are as shown in the diagram. With no voltage impressed on the grid, the plate current has the value OA , with the small voltage impressed on the grid it is BC , and with the larger voltage it is DE . Thus it is seen that the average value of the plate current follows the amplitude of the grid voltage. If suitable adjustments are made, the average plate current may, on the other hand, be decreased with increasing grid voltage, instead of increased as shown in Figure 31.

The rectifying action of a three-electrode tube is considerably improved if the high-frequency fluctuations in the plate current do not have to pass through the high reactance of the telephone receivers. If the telephone is shunted by a condenser of about five millimicrofarads capacitance, the shunt path will offer but little reactance to the flow of the radio-frequency fluctuations of the plate current. To the low-frequency fluctuations of plate current, that is, to the changes in average value of plate current as the amplitude of the grid voltage varies, this by-pass condenser will offer such a high reactance that practically all of the low-frequency current will flow through the telephones, as it should.

From inspection of Figure 29, it is evident that as the grid potential goes positive, the grid takes current. This current will decrease the signal strength somewhat from its possible value and will also decrease the selectivity of the circuit.

To overcome the difficulties mentioned above, it is advisable to introduce an extra voltage in the circuit in such a fashion that even when the signal voltage has its maximum positive value the grid potential is still negative and so takes no current. One small dry cell connected in the circuit as indicated at *X*, Figure 30, will accomplish this result. The cell must be so connected in the circuit that the grid becomes negative with respect to the filament, where the tuned circuit is connected to it.

Even for the shortest possible sound, there are a great many air vibrations and the form of these vibrations is generally very complex. In Figure 32 is shown the form of grid voltage, and resulting plate current, for a very small interval of time, perhaps 0.0001 second. If the apparatus at the radio-telephone transmitting station is working properly the amplitude of the high-frequency voltage impressed on the grid of the receiving tube represents the form of the sound wave at the transmitting station, which is to be repeated at the receiving station. By properly using the curves of Figure 31, the average plate current for such a grid voltage may be found, as was done in Figure 31. This is shown in Figure 32 directly under the grid voltage curve; it is similar in form to the envelope of the grid voltage and hence will produce in the telephone receiver a sound similar to that used to send the signal.

When no grid condenser is used it is just possible that the filament current and plate voltage of the receiving tube may be of such values as to produce no rectification, hence no detection. Thus, if the average potential of the grid is zero (no bias battery

used) and the tube is operating on the 20-volt curve of Figure 29 it may be seen that the increase of plate current when the grid swings positive is just the same as the decrease when the grid swings negative; such a variation of plate current causes no change in the average value and hence no rectification, or detection, is produced. To avoid this condition the grid potential must be of such a value,

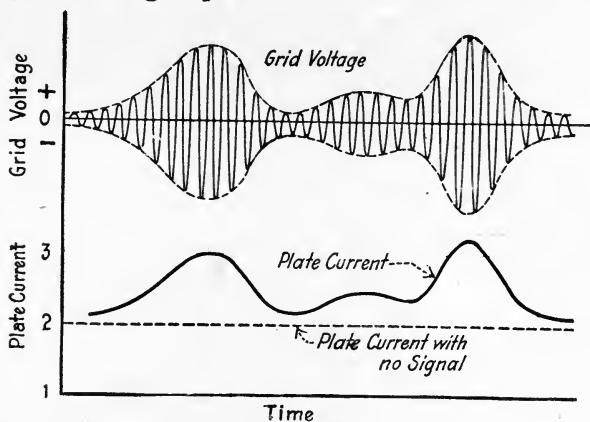

Figure 32

with no signal coming in, that the plate current will fluctuate, when a signal does come in, over a curved part of its characteristic, instead of a straight part as was assumed in the above analysis.

Some detector tubes have sufficient gas in them to permit the ionization of the gas to play an important part in the detector action. In these gas tubes, generally called soft tubes, it is necessary to have such a connection of the plate battery that the potential of the plate may be quite closely regulated. This is frequently done by connecting a resistance

across the A battery and connecting the plate circuit to the filament circuit by sliding a contact on this resistance. In such a case the plate voltage is varied by connecting in that number of cells as gives the best detection, the sliding contact being in about the middle of the resistance. The position of the sliding contact is then varied until the signal strength is a maximum. This adjustment gives a voltage on the plate nearly enough to produce ionization with no signal coming in; the signal voltage, acting on the grid, will then be able to produce a large change in plate current by starting the ionization of the gas.

Action of the Tube with Grid Condenser.— When a grid condenser is used the connection scheme is as shown in Figure 33; the local tuned circuit

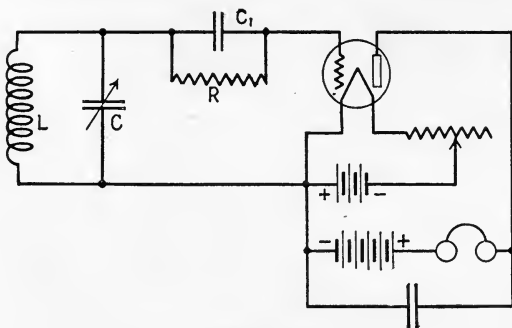

Figure 33

L - C is the same as before but the grid is now connected to this circuit through condenser C , this being called the grid condenser. Around this condenser is shunted a high resistance R , called the grid leak.

It will be noticed that with this connection scheme the positive terminal of the filament has been made

the common, whereas when using no grid condenser the negative terminal was made the common junction (compare with Figure 30). The detecting of the average tube is about twice as good when using the positive terminal as the common junction as when the negative terminal is so used, this improvement being due to the shape of the grid current-grid potential curve.

Referring to Figure 34, assume that with no signal coming, the grid potential is at *A*; somewhat positive with respect to the negative end of the fla-

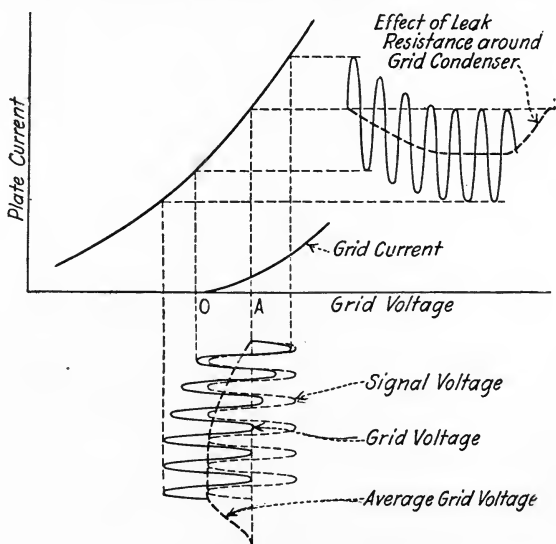

Figure 34

ment. Suppose a sine-wave signal voltage impressed on the grid by the *L-C* circuit of Figure 33, this being represented in Figure 34 by the dotted line marked signal voltage. The grid starts to fluctuate

positively and negatively to equal amounts about its normal potential A . But when it swings positive the increase in grid current is much greater than the decrease in grid current when the grid swings equally in the negative direction. This action results in an accumulation of electrons on the grid, which accumulation gradually decreases the average value of the grid potential as the signal is maintained. The grid potential will finally be negative with respect to its normal value by an amount practically equal to the amplitude of the signal voltage.

In Figure 34 the actual grid voltage and the average grid voltage are indicated; it may be seen that the average value of the grid potential decreases by an amount nearly equal to the amplitude of the signal voltage. If the signal voltage increases or decreases the average grid potential is correspondingly depressed or raised.

As the plate current must follow the fluctuations in grid potential according to the form of the characteristic curve of the tube, it is evident that the plate current will have the form shown in Figure 34; the average plate current must follow the variation in the value of the average grid potential and so will have the form shown. The amount of decrease in the average plate current depends upon the amplitude of the signal voltage, being nearly proportional to it.

It is to be noted that (1) with no grid condenser, rectification may take place by either an increase or decrease in the average value of plate current, according as the lower or upper curved portion of the plate current curve is used, for rectification;

(2) with grid condenser rectification is always accomplished by decrease in plate current with increase in signal voltage, irrespective of what part of the plate current curve is used.

The accumulation of electrons on the grid, explained above, would maintain the grid at a negative potential unless means were provided for letting them leak off; this is accomplished by shunting the grid condenser with a high resistance. At the same time that the electrons are tending to accumulate on the grid, they are also leaking back to the filament through this resistance. The value of the leak resistance must be sufficient to permit a rapid discharge of the accumulated electrons if the signal voltage is suddenly stopped.

With the detector ordinarily available and for frequencies ordinarily used in radio telephony, a grid condenser of about 200 micromicrofarads and a grid leak of about a million ohms are suitable; for certain other tubes the writer, using one-quarter of this value of capacitance and four times the value of resistance mentioned, obtained somewhat better results.

The accurate theory of the action of vacuum tubes shows that it is advisable to use as large a condenser as possible and as high a leak resistance as possible. It will be found, however, that for faithful detection the product of the capacitance in micromicrofarads and the resistance in millions of ohms must not exceed about 200. If a larger value of this product is used, the quality of the speech will probably be much impaired, the consonants being suppressed more than the vowel sounds, resulting in "dummy" quality of speech because the charge on

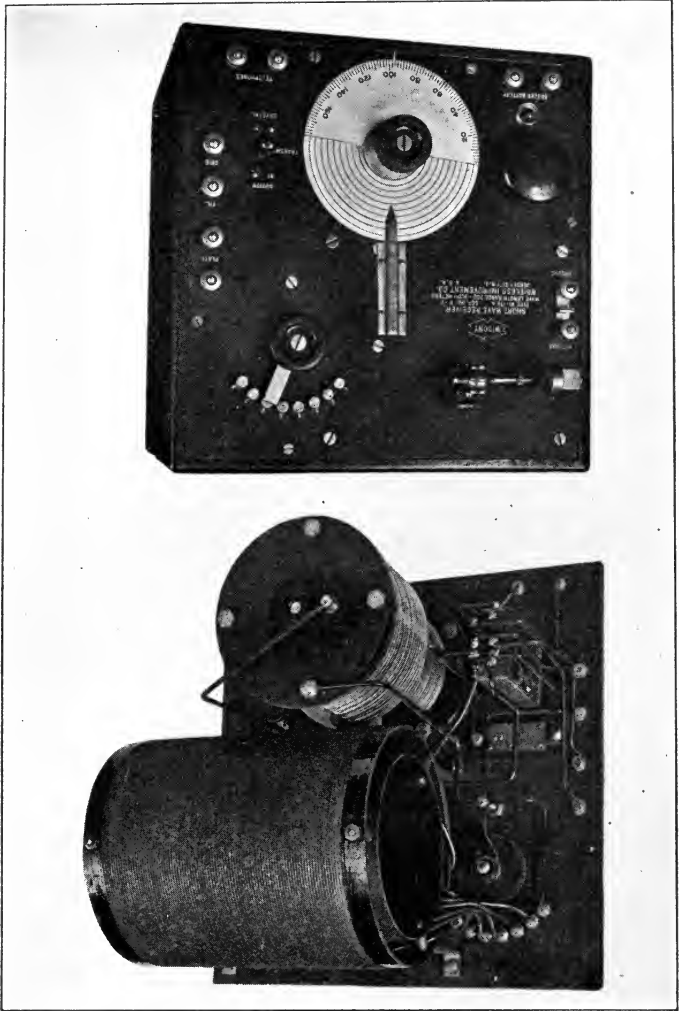
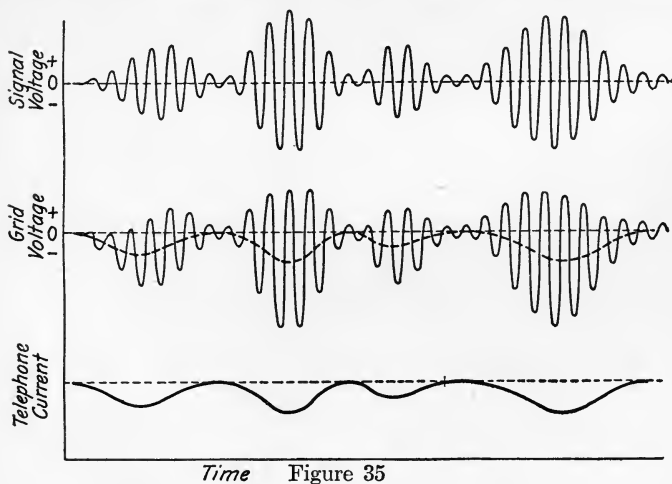

Plate VI.—Vacuum-tube receiving set (exterior and interior);
Wireless Improvement Company.

the grid does not leak off rapidly enough at high audio frequencies.

The foregoing analysis shows that if the form of voltage impressed on the grid by the signal is given, the form of plate current may be at once plotted; the two curves might be as shown in Figure 35.



A very small interval of time is shown, perhaps 0.001 second. The signal voltage will have for its envelope the form of the sound wave at the transmitter station; the average grid potential will fall and rise with the amplitude of the signal voltage and so will the average plate current, which is the current flowing through the telephone receivers. As the sound given off by the receivers has the form of the current flowing through them, it follows that the sound emitted by the receivers is the same as the sound actuating the radio-telephone transmitting station.

Improvement in Action of Tube by Use of Grid Condenser.—The average tube will prove more sensitive with a grid condenser than without one, the gain in sensitiveness, however, varying considerably with wavelength and with different tubes. In the type of tube used by the Signal Corps for detector, the establishment of a certain strength of signal in the telephones required about three times as much high-frequency voltage on the grid as when a suitable grid condenser and leak were used. Using a good telephone receiver (one which requires about 0.05 microampere for an audible signal) it was found that with a grid condenser about 0.01 volt of high-frequency signal must be impressed between the grid and filament to produce an audible signal, in a very quiet room. Without a grid condenser about 0.03 volt was necessary.

It will be noticed from Figure 31, that if the normal value of plate current, with no signal being received, happens to lie on the straight part of the plate current curve, there is no change in the average value of the plate current when a signal is impressed on the grid. It is the change in average value which gives the audible signal in the telephones, hence such an adjustment would not permit detection. The normal plate current must be on a curved portion of the characteristic curve. When using a grid condenser, a signal always produces a decrease in the average value of the plate current, no matter on what part of the characteristic curve the normal plate current happens to lie; the certainty of signal detection is greater than if no condenser is used.

Possibility of Eliminating Batteries. — The filament of a detector tube in general requires a storage battery; if several tubes are used (as in an amplifier) a storage battery is practically always necessary. Some of the smallest vacuum tubes will operate satisfactorily on dry cells. The plate circuit is nearly always excited by a battery of small dry cells, which will last, on the average, about one year.

Storage batteries have to be continually recharged and the dry cells have to be occasionally renewed. The charging of storage batteries is generally bothersome or expensive. Since the average house is furnished with alternating-current power, which cannot be directly used for charging batteries, a charging outfit of some kind must be installed. The ideal receiving outfit is evidently one which will function properly by merely connecting it with the house-lighting circuit; this is at present possible in the more expensive and intricate sets and probably will be adopted for all those receiving sets which rival the higher priced phonographs in price.

In an alternating-current circuit the voltage and current are continually changing their values, and are changing their direction, say, sixty times a second. If a filament is lighted from an alternating-current supply circuit (dry cells being used for the plate circuit), radio-telephone signals will be received but will be accompanied by a powerful humming noise which has a complex pitch of sixty and one hundred and twenty vibrations per second. This is due to the continual change and reversal of current through the filament.

If it is attempted to use the alternating-current supply for the plate, with no special arrangement

of circuit or apparatus, the receiver signal will be unintelligible; during half the time no signal at all is received, due to the reversed polarity of the plate and during the other half of the cycle the signal is received with a wide range of intensity, due to the varying value of the plate voltage.

When using an alternating-current supply, the troubles mentioned above can be reasonably well overcome provided sufficient extra apparatus is installed to change the alternating-current plate circuit supply into an essentially constant direct-current supply. This can be done by the use of two extra vacuum tubes, of the two-electrode type, in combination with sufficient inductance and capacitance. The difficulty of lighting the filament by alternating current may be overcome by making a special connection to the filament circuit.

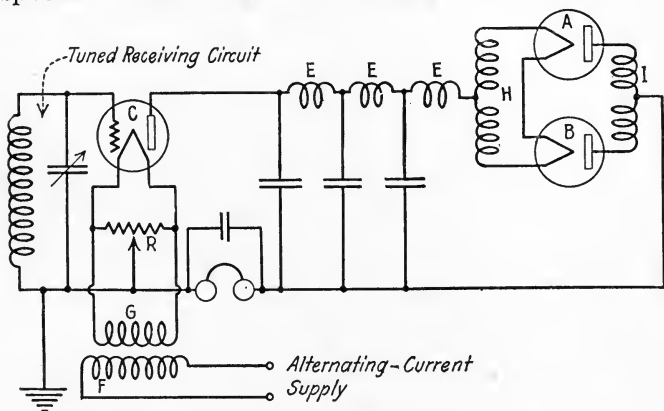

Figure 36

The equipment required for using an alternating-current supply is complicated and expensive; it may be arranged as indicated in Figure 36. Herein

A and *B* are two-electrode tubes used as rectifiers; they permit the flow of current in one direction only. The detector tube is shown at *C*; its filament is lighted from a transformer winding *G*, and the tuned receiving circuit is connected to the filament circuit at a movable contact on a rheostat *R* connected across the filament terminals. The filaments of the rectifiers are also lighted from a transformer coil *H*, which at its middle point is connected to the plate of the detector tube through some choke coils *E*. The plates of the rectifiers are connected to another transformer winding *I* which is connected at its middle point to the rest of the circuit as shown in the diagram. The three transformer coils *G*, *H*, and *I* are on the same core but are completely insulated from each other; the primary coil of the transformer *F*, having the proper number of turns, may be connected to the house power supply. While this scheme is perfectly possible the extra cost of tubes, coils, condensers, etc., makes it suitable only for the more expensive receiving sets.

Approximate Ranges of Receivers.— Many people have the impression that stations sending out the longer waves may be heard at great distances, because of the greater wavelength used. This does not follow directly, at least to the extent usually supposed. It seems to be fairly well established, by experiment, that long waves do travel with somewhat less attenuation than short ones but there is no experimental evidence which shows how much better the long waves are propagated than the short ones. Recently, low-powered stations sending out 200-meter waves have been successful occasion-

ally in trans-Atlantic communication, a result previously thought impossible.

The principal reason that the longer-wave stations are heard at greater distances is that they are high-powered stations; it is difficult to send out large amounts of power at the shorter wavelengths because of the necessarily small antennas used at the short waves.

There is apparently much difference in signal strength at different seasons of the year; signals between the same pair of stations, with the apparatus at the stations in apparently the same condition regarding sensitiveness, show a variation in strength as much as three to one, the stronger signals being received in the winter time. It has been suggested that the summer foliage absorbs a considerable amount of energy from the travelling waves.

There is also a pronounced difference between day and night transmission; signals will generally travel much farther at night than during the day, but transmission at night is likely to be more variable than that during the day. It is during the night that most long distance records for transmission are made. The foregoing variations in transmission range are more accentuated with the shorter waves.

During the winter months there is not much disturbance in the receiver circuit due to atmospheric discharges so that comparatively weak signals can be readily received; the same strength of signal in the summer months will be unreadable because of the irregular hissing and crackling noise in the telephones due to atmospheric disturbances. This interfering noise in the telephones greatly affects the

distance over which communication is possible; although the signal may be just as strong in the summer as in the winter, it may be easily readable at one time and even inaudible at another.

With a broadcasting station sending out one kilowatt of power, a tube detector such as has been described should give a readable signal at a distance of fifty to one hundred miles; this distance will naturally depend largely upon how good an antenna is used at the receiving station, how well it is grounded, etc.

It will be noted that distances greatly in excess of this are reported, but generally a tube receiver is not used in the simple way described in this chapter. By adding another coil and properly coupling the plate and grid circuits of the tube a regenerative action is obtained (described in Chapter VI), which may increase the sensitiveness of the receiver a hundred times in the hands of a skillful operator. Also, it is to be remembered that amplifiers are generally used in the best receiving sets and these greatly increase the possible distance of communication. The writer has many times copied signals in his laboratory (using only one tube in the receiver circuit) from stations several thousand miles away.

CHAPTER V

AMPLIFYING THE MUSIC OR SPEECH

BY

ROBERT D. GIBSON, E.E., AND PAUL C. HOERNEL, E.E.

Engineers, Research Laboratories of the American Telephone and Telegraph Company and The Western Electric Company.

The Problem of Amplification.—The problem of magnification presents itself in a number of different ways. The deaf make use of ear trumpets, the near-sighted use glasses, the mechanic employs levers to magnify motions or forces, the artist uses the pantograph to enlarge both dimensions of a picture at the same time, many use lenses in reading glasses or microscopes to enlarge areas. An electrical transformer may be thought of as a magnifier; it may either magnify the voltage or the current, but cannot magnify both simultaneously. Since the product of the voltage and the current is a measure of power, the transformer may be considered either a voltage or a current magnifier, but not a power magnifier.

The problem of amplifying the music or speech received by radio is much more complex than any of the above mentioned methods of magnification. The amount of sound produced by a telephone receiver is proportional to the electrical power expended therein. The electrical magnifier used in

connection with a radio receiver must then amplify power; that is, more music or speech in the form of electrical energy must be received from the device than is supplied to it.

Assuming that such a power-amplifying device is available, the problem is how shall it be introduced into the circuit of the radio receiver. It may be inserted between the antenna and the detector, thus amplifying the original radio wave, or the device may be inserted in the circuit after the radio waves have been detected and transformed into electrical waves of an audible frequency. The former scheme is known as radio-frequency amplification, the latter as audio-frequency amplification. The audio-frequency method is the most widely used form of amplification for radio-telephone reception.

The Vacuum-Tube Amplifier.—The device which is universally employed as the magnifier of the music or speech received by radio is the vacuum tube, the general properties of which have been outlined in Chapter IV. The vacuum tube is fundamentally an amplifier whether it be used as a detector, modulator or oscillator; some of its inherent amplifying properties always come into play.

The circuit of the vacuum tube used as an amplifier is illustrated in Figure 37. The rectified waves of voltage from the detector which constitute the received radio signals, are applied to the amplifier between points *A* and *B* of the amplifier circuit. The effect of these waves upon the plate current of the vacuum tube may be illustrated by the following experiment. If an electrical pressure of one volt is applied between *A* and *B*, making *A* negative with

respect to *B*, the meter will indicate, say, 8.3 milliamperes of plate current. By changing the voltage between *A* and *B* and reading the meter each time, many values of plate current under various condi-

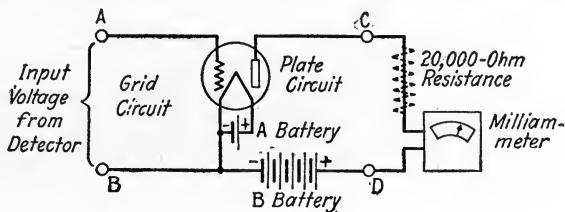

Figure 37

tions of input voltage can be obtained. These values can be plotted as shown in Figure 38, where the horizontal axis indicates the voltage between the input terminals *A* and *B* (Figure 37) of the amplifier. The vertical scale shows the plate current in milliamperes. The plate current was 8.3 milliamperes when the terminal *A* was 1 volt negative with respect to *B*; this condition is shown by point *D* on the graph. In a similar manner point *C* is located at 12.3 milliamperes when the voltage between *A* and *B* is zero. By plotting several points in this manner and connecting them all by a smooth line a curve is obtained which shows the relation between the input voltage to the amplifier and the plate current. A straight line graph would indicate a uniform relation between these two variable quantities; since the line just plotted, however, is curved, the relation between input voltage and plate current is not uniform.

If 20,000 ohms resistance is inserted in series with the meter as shown in Figure 37 and readings are

again taken as before, the graph will be more nearly straight, in fact it will be exactly straight over a certain range. This curve is shown in Figure 38 as the heavy line. While the plate current in this case is never as great as in the first case where no

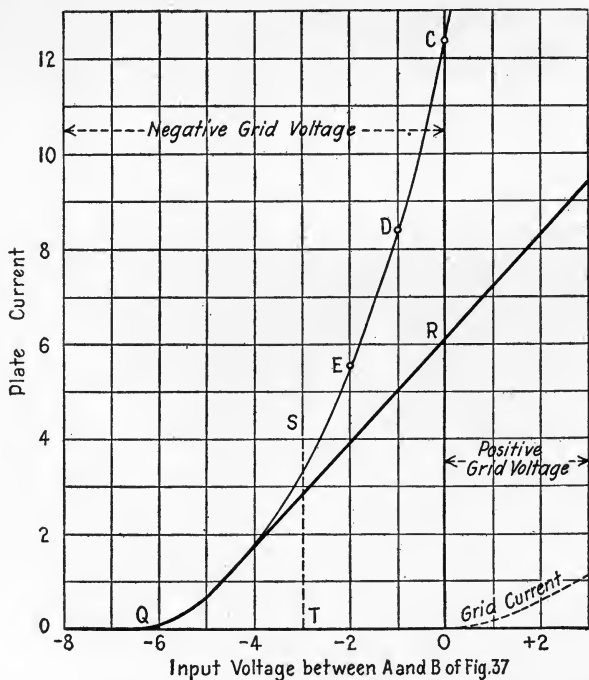

Figure 38

resistance was used, the relation between input voltage and plate current is a uniform one. This means that the amplification produced will not be distorted. It is evident then, that a vacuum tube used with a low resistance in its plate circuit will not reproduce

current variations uniformly proportional to its input voltage, while a tube with a high resistance in its plate circuit will produce plate currents which vary uniformly with respect to the input voltage variations. In the first case the amplifier would distort the signals, and in the second case using resistance in the plate circuit it would amplify without distortion.

The dotted line in Figure 38 indicates how a current will flow in the grid circuit whenever the grid becomes positive, thereby attracting electrons. As the positive voltage on the grid increases, the curve shows how the grid current will increase. This grid current neutralizes the effect of the positive voltage on the grid, a condition which causes distortion of the input voltage. The tube draws current whenever it has a positive grid. If voltage variations are applied to the grid so that the grid becomes alternately positive and negative, spurts of current will be sent around the grid circuit each time the grid is positive. This current will act as a load upon the positive input variations. The effect is then similar to the dimming of lights in the household when a toaster, flat-iron or other heavy load is repeatedly switched on and off. Assume that the detector furnishes the amplifier in question with a voltage which varies equally positive and negative. These variations will not be equally effective upon the grid since there is a dimming effect of the positive variation. The grid then receives not a uniform but a distorted alternating input.

To prevent the grid becoming positive at any time, a constant negative voltage may be applied as shown in Figure 39 by means of a battery, known as the

grid bias or C battery, with its negative pole connected to the grid. The voltage introduced by the C battery may be altered if desired; the correct value can be found by the following procedure: It will be seen that the heavy curve of Figure 38 is nearly straight between the points *Q* and *R*, the limits of distortionless operation. If a vertical line *ST* is drawn through the midpoint of the curve *QR*, this line will meet the horizontal voltage axis at the point marked -3 volts, which is the correct amount of C battery voltage for the tube in question.

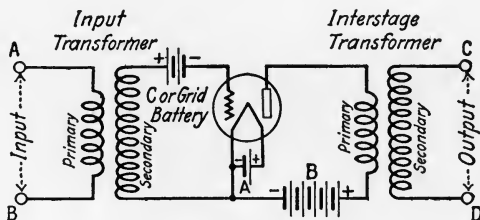

Figure 39

The incoming variations from the detector will cause the grid potential to oscillate equally on both sides of the line *ST* falling within the limits of distortionless operation as indicated by the letters *Q* and *R* unless these variations are too great. It will readily be seen that if the C battery voltage is other than -3 volts, the incoming wave may overreach one of these limiting points.

Figure 40 shows the effect on the plate current of the incoming wave when the voltage of the C battery is -3 volts. The incoming wave may oscillate from -2 to -4 volts about the axis -3 volts. The output voltage wave *CD* produced thereby has the

same shape as the incoming wave and is symmetrical about its axis XY because the characteristic curve is straight between points E and F . $C'D'$ shows the corresponding output current wave, which is also symmetrical. The proper value of C voltage is seen to be -3 volts for distortionless operation of the amplifier under consideration.

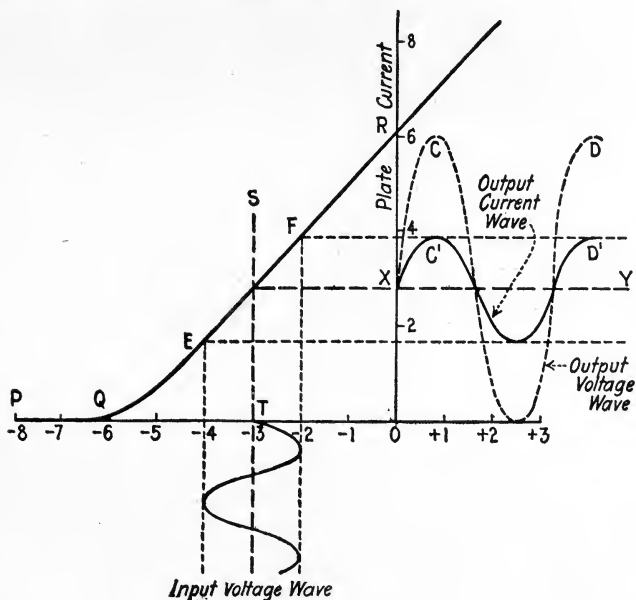

Figure 40

If the grid battery voltage is increased to -6 volts, the incoming wave will then vary, say, from -5 to -7 volts symmetrically about an axis of -6 volts. The negative input voltage variation will have no effect upon the output or plate current, as seen from the shape of the curve PQE of Figure

40. The output current wave will then have only an upper lobe, the lower being replaced by a straight horizontal line. This is a condition where great distortion will be introduced by the amplifier.

The minute waves of voltage produced by the detector are usually insufficient to swing the amplifier grid voltage over anything like the range referred to. In order to magnify the variable output voltage of the detector an electrical input transformer may be used as shown in Figure 39. This transformer should be designed to step up the variation in voltage of the rectified signal. In such a transformer the secondary winding contains many times the number of turns of the primary winding. Transformers have been designed to step up the voltage efficiently as much as ten times.

In the tube itself this magnified voltage impressed upon the grid controls a considerable amount of power in the plate circuit. It has already been explained how the plate current is made to fluctuate under the influence of the grid. Due to the amplifying properties of the vacuum tube the variations in grid voltage produce from 5 to 30 times this variation in the plate circuit. That is, a one volt variation on the grid produces an effective variation of the plate voltage of from 5 to 30 volts. Such tubes are said to have amplification constants ranging from 5 to 30.

If the meter and the 20,000 ohm resistance in the plate circuit shown in Figure 37 are replaced by a high-resistance telephone receiver, a much louder response will be obtained than if the receivers were actuated by the energy of the detector alone. This vacuum tube with its associated equipment consti-

tutes a single stage of amplification. In place of the telephone receiver a voltage magnifying transformer may be introduced at this point to convert the current variations in the plate circuit into large voltage variations, which in turn may be impressed upon the grid of a second amplifying tube. This transformer is shown as the interstage transformer in Figure 39.

The Multi-Stage Amplifier. — It may be found that a single stage does not sufficiently amplify the music or speech. Multi-stage amplification must then be resorted to. Figure 41 shows a two-stage amplifier circuit. The operation of the second stage is similar to that of the first. The grid of the second tube, however, is subject to much greater voltage variations than the grid of the first tube, producing correspondingly greater fluctuations in the output circuit, and hence a greater response is obtained in the telephone receivers.

The extent to which the voltage variation on the grid of the second tube may be increased over that impressed upon the first is represented graphically in the lower portion of the figure. Let the vertical lines represent the relative magnitudes of the voltage variations in the particular portions of the circuit shown immediately above. In this case the input transformer magnifies the voltage from the detector three times, which voltage in turn produces a five-fold variation in the plate circuit of the first vacuum tube. The output or interstage transformer magnifies this variation three times, making the voltage variation on the grid of the second tube forty-five times as great as the initial voltage. The

voltage impressed on the second grid is amplified five times in passing through the second tube, making the effect in the plate circuit of the second tube 225 times that of the detector. However, the maxi-

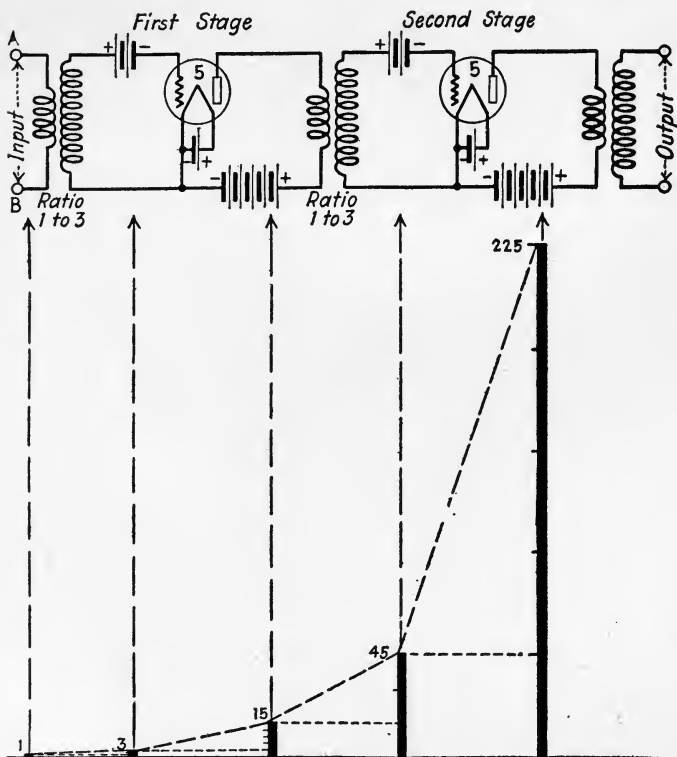

Figure 41

imum energy output is obtained from the amplifier when only half of this voltage is applied to the load. These ratios are assumed for purposes of illustration but actually depend upon the types of transformers

and tubes used. Transformers have been constructed with ratios as high as 10 to 1, and some tubes will amplify 30 times.

A third stage of amplification may be added in a similar manner. However, a three-stage amplifier requires delicate adjustments in order to be effective, and is not to be recommended except when extreme amplification is desired.

A type of circuit which is coming into favor is known as the push-pull amplifier. Figure 42 shows the application of such a device as the second stage

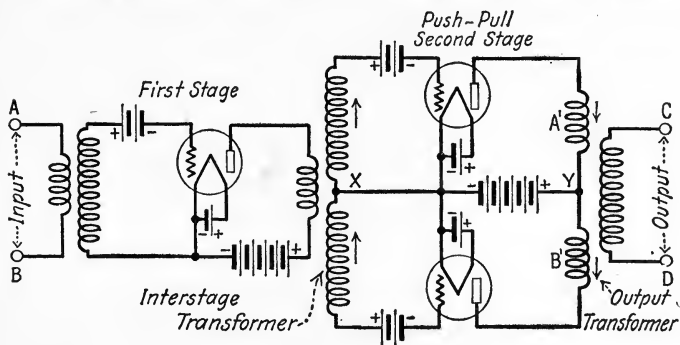

Figure 42

of an amplifier, in which position it is generally used. The push-pull circuit employs a pair of similar tubes each connected in circuit in a manner like that of a single-stage amplifier. The grids of these tubes, however, have impressed upon them only one-half the voltage variations that would be impressed upon the grid of a single tube in this position, that is, the input voltage is divided equally between the two tubes. The outputs of the balanced tubes, however, are additive in effect since the two

windings A' and B' of the output transformer are wound in the proper manner to add their effects. Thus, it is permissible to utilize twice as large input voltage variations as with a single tube, and hence obtain correspondingly larger outputs. As shown in the figure, coupling transformers are used which are constructed so that a connection can be made to the midpoints of primary and secondary windings, X and Y .

In the multi-stage amplifiers described above, the separate stages have been coupled together by means of interstage or voltage amplifying transformers. There are two other methods of coupling which may be used. Figure 43 shows a simple circuit which

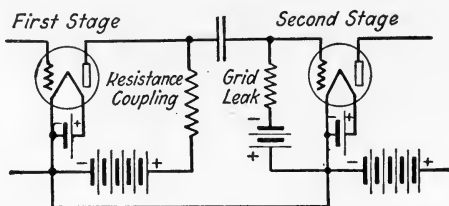

Figure 43

has a high resistance (10,000 to 50,000 ohms) in place of a transformer. The function of this resistance is to pass on or repeat the voltage variations of the first stage to the grid of the second-stage tube. A condenser is inserted in the second-stage grid circuit to prevent the steady plate voltage of the first stage from affecting the grid of the succeeding stage. The rapid variations of voltage in the plate circuit are transmitted through this condenser to the grid of the succeeding stage.

The resistance type of coupling does not step up the voltage variations as in the case of the inter-stage transformer. The chief objection, however, is that the resistance absorbs a large part of the voltage supplied by the plate battery. To compensate for this absorption the plate battery voltage must be made from two to four times the value normally employed.

Another type of coupling which operates upon the same principle as the resistance coupling makes use of a choke coil in place of the resistance. This coil consists of a great many turns of wire wound upon an iron core. The resistance of such a coil to the steady plate current is small, but the rapid variations in voltage from the first stage cannot pass through it and are transferred to the grid of the second tube. This method of coupling has the disadvantage of the resistance coupling in that the voltage variations are not amplified between stages. The low resistance of the choke coil to the plate current, however, enables the use of the normal plate battery.

Transforming the Electrical Energy into Sound. — After having sufficiently amplified the music or speech, which is still in the form of inaudible electric vibrations, the problem is to convert this energy into sound efficiently. Mention has already been made of the telephone receiver which will perform this function. It is often desired that several persons listen to the music or speech, in which case the inconvenience of using several pairs of telephone receivers makes this procedure impractical. For this purpose loud speaking telephone

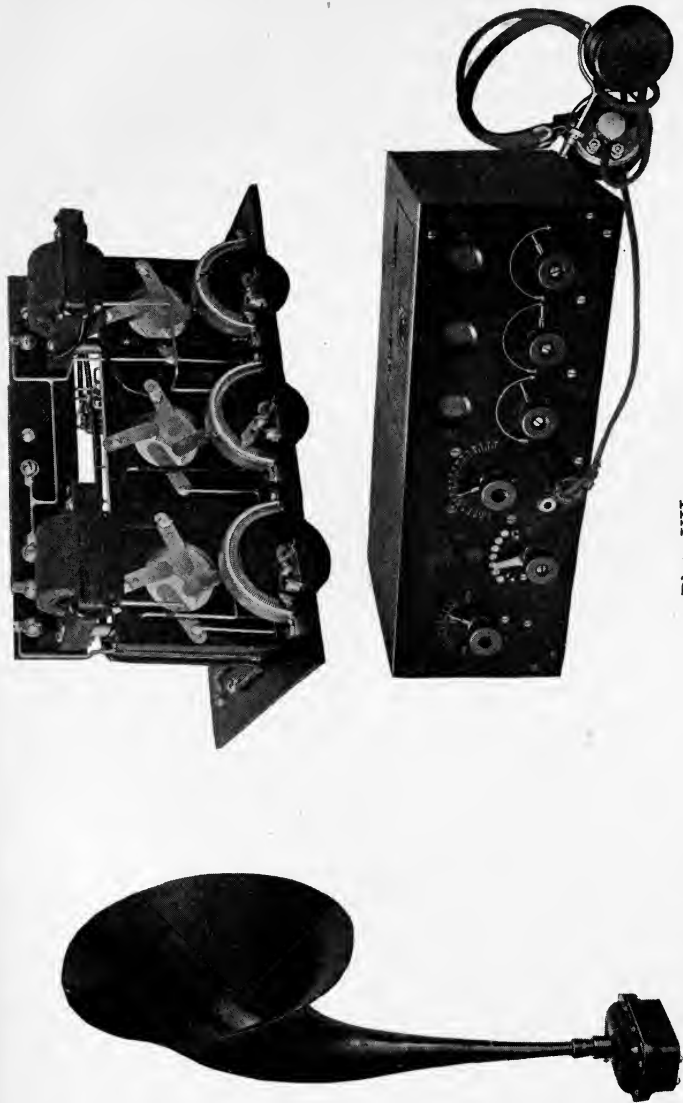

Plate VII.

Left: Loud speaking receiver; *Western Electric Company*. Above: Interior view of amplifier; *A. H. Grebe & Co.* Below: Vacuum-tube receiving set with two-stage amplifier; *John Firth*.



receivers have been designed which will convert considerable amounts of electrical energy into sound without distortion. Such a loud speaking receiver consists essentially of a powerful permanent magnet, a coil to carry the amplified telephone current received from the last stage of an amplifier, a soft iron armature which can move in the field of the magnet in accordance with the current variations in the coil, and a flexible diaphragm fastened to the armature

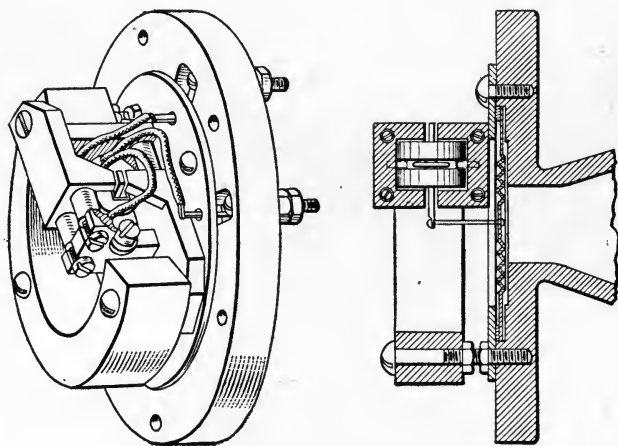

Figure 44

by means of a lever, so that its motion may be made greater than that of the armature. The moving elements of the receiver should be so designed that they will translate not only the necessary frequencies for intelligible speech, but also all those frequencies ranging from 200 to 4000 cycles which occur in music. The construction of a typical loud speaking telephone receiver is illustrated in Figure 44.

It must be remembered that a receiver of this type designed to carry relatively large amounts of power requires considerable energy to actuate it. It cannot, therefore, be used in place of a high-resistance telephone receiver in the detector circuit where the available energy is small. Loud speaking receivers have been designed to absorb as much as 25 watts of energy, which is as much as is necessary to light an ordinary electric light bulb.

Telephone head receivers not primarily intended for loud speaker work, have been developed upon the above principle and are capable of producing relatively loud sounds with small electrical inputs. These receivers can be used as loud speakers where only small amounts of energy are available, such as in the detector circuit or in the output circuit of single-stage amplifiers.

There are two common methods of transferring the energy from the amplifying equipment to a loud speaker. At the left of Figure 45 is shown

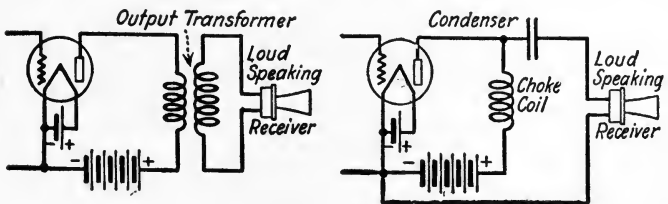

Figure 45

the connection of a special output transformer used to supply maximum current to the loud speaker. In this case, the output transformer is a current magnifying device. At the right of Figure 45 use is made of a choke coil through which

the steady plate current is supplied. The characteristics of this choke coil are such as not to permit the rapid current variations of the speech or music in the plate circuit to pass through it, but to transfer them directly through the condenser of large capacity to the loud speaker. The application of a special output transformer in connecting a push-pull amplifier circuit to a loud speaker is shown in Figure 42. In the above schemes the actual direct current normally flowing in the plate circuit is not passed through the loud speaking receiver, for if it were allowed to do so, it would tend to distort the music or speech.

The action of the loud speaker referred to is illustrated by the windlass analogy shown in Figure 46.

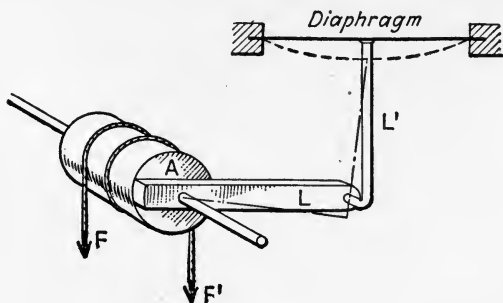

Figure 46

The alternate application of the equal forces F , F' , which may be assumed to correspond to the currents in the loud speaker coils, will cause the drum or armature A to be rocked back and forth. This motion is transferred to the diaphragm by the lever arrangement LL' . A steady current flowing through the loud speaker coils will be equivalent to the

application of only one force, say F' , thus tending to bias or pull the diaphragm down as indicated by the dotted line.

Suiting the Loud Speaker to Its Audience. — The megaphone is the most familiar form of sound projector. In the megaphone, sound waves coming from the speaker, instead of spreading out in all directions from the mouth as they normally would, are limited by the walls of the horn. The wave emerging from the wide end has all the energy of the voice and thus produces a much more intense effect directly ahead. The megaphone directs the sound to a greater or less extent in a given direction. Considerable increase in sound can thus be obtained by using a megaphone or horn in conjunction with an ordinary telephone receiver. While this arrangement may prove satisfactory for supplying small amounts of sound, it is entirely inadequate when large amounts are desired.

In designing a horn it is necessary to make the coupling between the loud speaker and the horn itself, sturdy, to withstand the excessive pressure variations in the air which occur at this point. This is accomplished in some cases by means of a special cast metal throat, or by covering the small end of the horn with some compound to deaden any tendency to vibrate.

Wood has been extensively employed in the construction of horns and is to be recommended where exceptionally fine quality is desired. These horns should be of firm construction and free from vibration. The shape of the horns or projectors may vary, depending upon where they are to be used

and upon the practicability of construction. One type of horn, which derives its name from the Morning-Glory, because of its similar shape, is used where it is desired to project the music or speech throughout an entire room of considerable size. This type, however, is bulky and cumbersome for home use. Another type which requires much less space for mounting is the so-called ventilator type. Because of the difficulty of constructing these horns of wood they are usually made of metal or composition material. For use in large auditoriums and out-of-doors, projectors have been constructed of wood ten feet in length with a rectangular cross-section. This type of horn has marked directional characteristics; but by placing several of them so that they radiate from a common center, it is possible to distribute the sound uniformly over a large area. With this horn and a loud speaking receiver as previously described, loaded to its full capacity, music has been distinctly heard almost four miles from the projector.

Concerning the Operation and Care of the Amplifying Equipment. — There are three distinct batteries which must be used with the amplifying equipment, the A or filament supply battery, the B or plate battery and the C or grid biasing battery.

The most common source of power supply to light the filament is a six-volt storage battery. Figure 47 shows a circuit of a storage battery used in connection with a single tube. In the figure, *R* is a rheostat or variable resistance of six to ten ohms which enables the brilliancy of the filament to be varied. The filaments should be operated at the rated tem-

perature. When operated below this temperature there will in general be a decrease in the amplification, and when operated above normal temperature the life of the filament will be materially shortened. When several tubes are used, the filaments may be connected in parallel, as shown also in Figure 47. In this case a rheostat is used in connection with each filament so that the brilliancy of each may be independently controlled. Oftentimes a battery

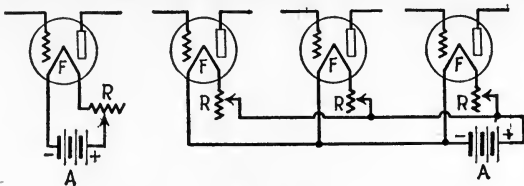

Figure 47

of 24 or 32 volts is the only available supply, in which case the filaments may be connected in series and all controlled by a common rheostat. The disadvantage in this latter scheme is the lack of independent control of the filament brilliancy. When storage batteries are to be used, it is recommended that some convenient home charging equipment be obtained to avoid the disappointment of having the battery run low in the midst of a concert by radio telephone.

The voltage of the B or plate battery to be used is dependent upon the type of tube employed and the amount of power it is desired to obtain from the amplifying equipment; this voltage may vary from 40 to 200 volts. Figure 48 shows the method of supplying plate battery voltage to both a choke coil and an interstage transformer in a two-stage

amplifier circuit. A resistance type of coupling may be substituted for the choke coil.

It will be found that the plate voltage to be used is not the same for each tube, but is dependent largely upon the voltage variations impressed upon the grid of each tube. Hence, the correct plate voltage on the second stage will in general be from two to three times as large as the voltage on the first stage, and similarly the plate voltage on the third stage will be greater than that of the second.

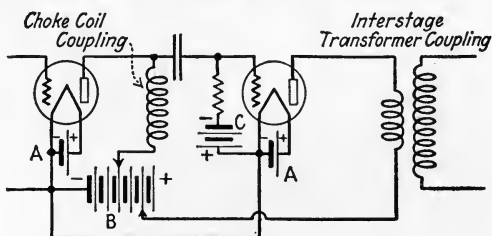

Figure 48

Instead of employing storage batteries and dry cells for supplying the filament and plate potentials, use may be made of a generator which will supply two voltages, a filament voltage of 12 volts and a plate voltage of 150 volts. The machine may be driven by the ordinary direct- or alternating-current house-lighting supply. In connection with this machine it is necessary to employ a special electrical filter which will smooth out any variations in voltage that might introduce noise into the amplifiers.

The grid biasing battery usually consists of a number of small flashlight-type dry cells. Figure 49(a) shows how these are placed in circuit. Since these cells do not supply current but merely maintain the grid negative with respect to the filament,

their life may be considered to be the shelf-life, which is from six to nine months. The amount of the grid bias voltage must also be varied, as has been shown, in accordance with the variation of impressed grid voltage. Values of grid bias potentials of from 1.5 to 20 volts are common. Figure 49(b) shows how the bias voltage may be supplied to the grid of a

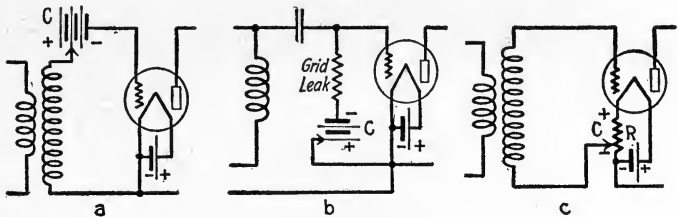

Figure 49

resistance- or inductance-coupled amplifier. In place of using a C battery, it is often sufficient, when only desirous of obtaining a small negative potential on the grid, to make use of the voltage drop in the filament circuit, as shown in Figure 49 (c). Herein R is a small resistance of from one to three ohms placed in the filament circuit. Normally, when no resistance is used in this circuit and the voltage across the filament is, say 5 volts, the bias voltage upon the grid may be, say 2.5 volts. If a greater bias voltage is desired the sliding contact is moved to utilize the greater voltage drop across the resistance. When more than six or eight volts are required by the grid, dry cells must be used.

Figure 50 shows in schematic form a typical three-stage amplifier with associated detector equipment. The detected or audio-frequency currents pass

through the primary input transformer T_1 and produce amplified potential variations upon the grid of the first stage of the amplifier; they then pass from stage to stage as has already been outlined.

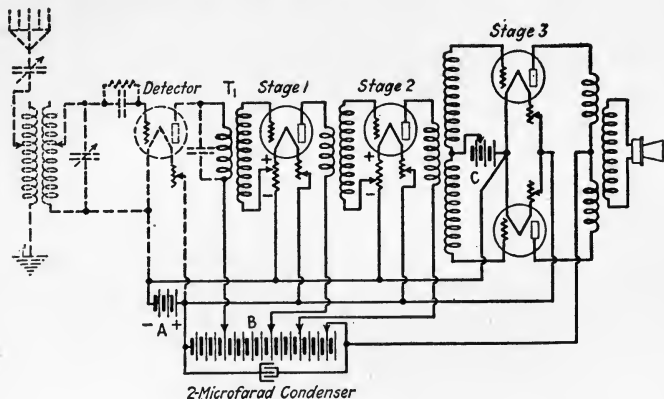

Figure 50

Distortion. — If distortion is experienced it is well to keep the following points in mind: (1) The energy entering the input transformer of an amplifier must not be distorted for if it is the amplifier will accentuate the distorted input and poor results will be obtained. (2) All the transformers used in connection with amplifiers must give sufficient voltage step up, and must be efficient in passing all frequencies from about 200 to 4000 cycles per second which are necessary for the production of good quality music. (3) The A, B and C batteries should be of the proper voltage as previously explained, and the voltages should be steady for otherwise slight variations will be amplified and produce harsh sounds in the receivers or horn. (4) The vacuum

tubes should be of the amplifier type; some tubes make good detectors but are poor amplifiers. (5) The loud speaking receiver and its associated equipment should introduce as little distortion as possible.

It may be found that when power is supplied to the amplifier a shrill tone is heard in the receivers or loud speaker, which may be so strong as to make radio reception impossible. This effect is due to the fact that somewhere in the amplifier circuit the voltage variations on the output side of a tube are transferred by induction to the input or grid circuit of the same or preceding tube. This variation on a grid is then amplified and fed back, resulting in singing or howling. A great deal of the tendency of amplifiers to sing or howl may be eliminated by properly locating the parts of apparatus. Particular care should be taken not to locate the transformers in too close a relation to one another, and an effort should be made to make the leads from the inter-stage transformers to the grids of the tubes as short as possible. In some cases the total length of these leads can be reduced to 4 or 5 inches. Whenever possible the cores and cases of the transformers, and the tube sockets, and the positive terminal of the filament battery should be grounded. If the B battery contains sufficient resistance common to the plate circuits any slight variations in current therein will produce sufficient drop to affect the grids of the preceding tubes and thereby create a tendency to sing. By shunting the B battery with a 2 microfarad condenser, the tendency of the amplifier to howl will be reduced.

In using three stages of amplification, the tendency to howl will be especially great because of the

great amplification obtained. Efforts to reduce this singing have been made by putting each tube and its associated transformer in a special metallic compartment which is grounded. This practice is known as shielding. By taking particular care in shielding so as to prevent the amplified energy from being fed back into the input circuit, it is possible to construct a three-stage amplifier that will be comparatively free from howling.

CHAPTER VI

REGENERATIVE AND HETERODYNE RECEPTION

BY L. A. HAZELTINE, M.E.

Professor of Electrical Engineering, Stevens Institute of Technology; Fellow, American Institute of Electrical Engineers, and Institute of Radio Engineers.

The Several Functions of the Three-Electrode Vacuum Tube. — The physical action in the three-electrode vacuum tube, or triode, was discussed in Chapter IV, and it was shown that it serves a dual purpose in receiving. Like the crystal detector, it *rectifies* a received radio oscillation, so that an audible response will be produced in a telephone receiver; but it goes further than the crystal — it simultaneously *amplifies* the response. This amplification comes from the fact that the tube does not merely change the form of the received radio energy, like the crystal, but it utilizes the received energy to control a local source of energy — the battery in the plate circuit. It is the energy from the battery that directly produces the telephone response and this is much greater than the received radio energy.

A very important extension of the fundamental amplifying action of three-electrode vacuum tubes was discovered and developed by Major E. H. Armstrong between 1912 and 1914. This is the use of

an amplified oscillation to reinforce the original oscillation, and is called *regeneration*.

Regeneration may be employed directly to reinforce a received radio oscillation. It has, however, another application, that of *producing sustained oscillations* even in the absence of an impressed oscillation; for if the regenerative effect is strong enough it will automatically build up an oscillation in the tube circuits and will maintain this indefinitely by the energy derived from the battery in the plate circuit. Such regenerative oscillation is employed in radio-telephone transmission, as described in the following chapter, and constitutes the only method now available for producing the very high frequencies commonly used in radio-telephone transmitting over moderate distances. Regenerative oscillation, as will be shown, is employed also in several of the most effective modes of radio reception.

Thus, the three-electrode vacuum tube has four distinct functions as applied to radio receiving. It rectifies, amplifies directly, amplifies by regeneration, and oscillates by regeneration. These functions may be served by different tubes or, if desired, all by the same tube simultaneously.

In Chapter V, it was shown how vacuum tubes could be employed for their amplifying action alone, to increase the loudness of the received music or speech. It was there mentioned that this amplification could be applied either before or after the rectification of the received oscillation; and the latter, or audio-frequency amplification, was discussed in detail. The amplification of the received oscillation before rectification, or radio-frequency

amplification, and a special system of amplification that avoids some of the limitations both of audio-frequency amplification and of simple radio-frequency amplification will be described later.

Regeneration Without Oscillation for Increasing Response in Telephone. — Consider the details of regenerative reception by reference to Figure 51, which is identical with Figure 30, except for the presence of the “tickler coil.” In both figures, when an oscillation is impressed by a passing wave, the current in the plate circuit will have a radio-frequency pulsation in addition to the audio-frequency pulsation that actuates the telephone receiver (see Figure 32); or, what is the equivalent,

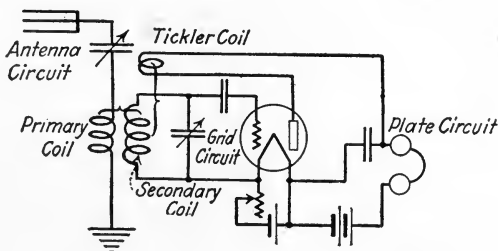

Figure 51

there is present in the plate circuit a radio-frequency current superposed on the audio-frequency current and on the direct current. No use is made of this radio-frequency plate current in the circuits of Chapter IV; but in Figure 51 the radio-frequency plate current flows through the tickler coil and so induces a radio-frequency voltage in the secondary coil coupled therewith. If these coils have the right

relative polarity, the voltage induced in the secondary coil will reinforce the radio oscillation in the grid circuit. This reinforced oscillation is in turn amplified by the tube, increasing the radio-frequency current through the tickler coil and further reinforcing the oscillation in the grid circuit. Thus the regenerative effect of the tickler coil is cumulative; and, by carefully adjusting its coupling with the secondary coil, the oscillation may be built up to a strength many times greater than it would have without regeneration. The result is, of course, that the response in the telephone receiver is increased correspondingly.

Any circuit that gives regeneration is called a *feed-back circuit*, from the fact that oscillating energy is fed back from the plate circuit to the grid circuit. There are several simple forms of feed-back circuit, as devised by Armstrong. The two most commonly used in radio receivers are the "tickler circuit" of Figure 51 and the "tuned plate" arrangement, which is like Figure 51 except that the tickler coil is replaced by a coil of adjustable inductance (the so-called variometer) that is not usually coupled with the secondary coil. In this case the inherent capacitance between the grid and the plate is relied on for coupling. The choice among different forms of feed-back circuit is primarily one of convenience in design and use.

If the relative polarity of the tickler coil and the secondary coil in Figure 51 were wrong, the radio-frequency plate current would weaken the oscillation instead of strengthening it. The weakening would be the greater, the closer the coupling between these coils. This affords an experimental

check of the correctness of the coil polarity in an existing receiver. This check, however, will be uncertain if the plate circuit is inherently nearly in tune with the received oscillation; for then regeneration may occur with either polarity or without any coupling between the coils, as referred to in the preceding paragraph.

In general, the strength of a received oscillation from a given transmitting station is limited by two effects: first by the electrical *resistance* of the circuit, which consumes energy when current flows; and second by the *reactive* effect of coils and condensers. The reactive effect of a coil is opposite to that of a condenser and one is made to balance the other by tuning. The effect of resistance, however, can be balanced only by a source of energy; regeneration, which supplies energy to an oscillation, may be considered as balancing out resistance. By starting with a loose coupling between the tickler coil and the secondary coil in Figure 51 and gradually tightening the coupling, more and more of the resistance of the oscillating circuit will be balanced out. As the remaining resistance approaches zero, the oscillation will be rapidly strengthened, provided the tuning is very good. The resistance cannot, however, be permanently reduced below zero in this way, for before that can happen a local oscillation will be started, as described in the following paragraphs.

Regeneration as a Cause of Oscillation. — Suppose that in the circuit just considered no oscillation is being received; but suppose that a very slight electrical disturbance momentarily occurs in



Plate VIII.—Regenerative short-wave receiving set (exterior and interior); *A. H. Grebe & Company.*

the grid circuit. This disturbance will result in a weak oscillation whose frequency is that to which the grid circuit is tuned, as determined by the values of the capacitance and the inductance. This oscillation will be amplified in the plate circuit, just as would a radio oscillation received through the antenna. And, just as described above for a received oscillation, the oscillating current in the plate circuit will flow through the tickler coil and will induce a like voltage in the secondary coil tending to reinforce the weak oscillation. If this induced voltage is insufficient to maintain the oscillation against the resistance of the grid circuit, the oscillation will gradually die out. On the other hand, if the induced voltage is more than sufficient to maintain the oscillation, this will be strengthened and will gradually build up.

The disturbance necessary to initiate an oscillation in a regenerative circuit may be supplied by the closing of a circuit, by a passing wave, or by an accidental irregularity in the electron emission of the tube. It must be borne in mind that only the least possible disturbance is required, just as the least possible disturbance will upset a perfectly balanced but unstable body.

The steeper the characteristic curve of the tube (Figure 29) the greater will be the regenerative tendency. As an oscillation builds up, the mean slope of the curve over the operating range ultimately decreases, the curve flattening out at one or both ends. Hence the oscillation strength does not increase without limit, but stops increasing when the voltage induced in the secondary coil by the current in the tickler coil is just sufficient to balance

the voltage used up in resistance, or, in other words, when the power fed back from the plate circuit to the grid circuit just balances the oscillating power consumed in resistance.

Under usual conditions the regenerative tendency increases with the tightness of coupling between the tickler and secondary coils. Starting with loose coupling and gradually tightening it at first will result in no oscillation; then at a certain coupling an oscillation will automatically start, and as the coupling is further tightened the oscillation becomes stronger.

In general high resistance and high capacitance of an oscillating circuit tend to make oscillation more difficult, while high inductances are favorable to oscillation. Looseness of coupling between the main oscillating circuit and any other circuit to which the oscillation is extended (as from the secondary circuit to the antenna circuit in Figure 51) favors oscillation, for it keeps down the loss of energy in the second circuit. The steepness of the characteristic curve of a tube usually increases with the filament heating and with the voltage of the plate battery; so the tendency to oscillate is correspondingly improved.

In certain tubes not having a very high vacuum, oscillation can sometimes be produced without the employment of regeneration. This effect accompanies a downwardly sloping characteristic curve of grid current and potential, which represents a negative resistance. It is usually difficult to control, is often transitory, and has never come into general application.

Synchronous Heterodyne Method of Radio-Telephone Reception.— Ordinary radio detectors operate much more efficiently with strong impressed oscillations than with weak oscillations. Thus, if an impressed oscillation is halved in intensity, the response is reduced, not to one half, but to *one quarter*. This very undesirable result can be obviated by combining the received radio oscillation with a local oscillation and impressing the combined oscillation on the detector, as shown in the following paragraphs. This advantage in the use of a local oscillation seems to have been first appreciated by Dr. F. K. Vreeland about 1906, in connection primarily with his work on the electrostatic telephone; it was independently discovered and introduced into radio practice about 1913 by John V. L. Hogan. Previously, however (about 1905), R. A. Fessenden had proposed the use of a local oscillation, specifically for the production of beats, as explained later. The name *heterodyne*, introduced by Fessenden, is here used for any method of reception in which a local oscillation is combined with a signal oscillation.

The principle of heterodyne radio-telephone reception will be explained by means of Figures 52 and 53, which pertain to a vacuum-tube detector without a grid condenser. In the former is shown the characteristic curve of the tube; below it is represented the curve of grid potential plotted against time on the supposition that the received oscillation is suddenly impressed and remains constant in intensity; and at the right is the corresponding curve of plate current against time. The telephone current with received oscillation, which is the average value of

the plate current with received oscillation, is seen to be greater than the plate and telephone current with no oscillation. That is, this received oscillation causes a sudden small increase in the telephone current; this constitutes the rectifying action of the tube. Of course, in actual radio-telephone reception the intensity of the oscillation varies gradually, as modulated by the voice at the transmitter, and the telephone current varies gradually to correspond. The sudden jump in Figure 52 is assumed for simplicity of discussion.

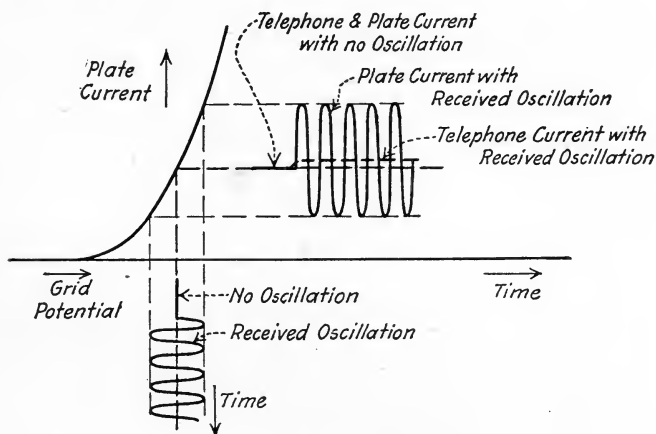

Figure 52

In Figure 53, a relatively strong local oscillation is present at all times and combines with the received oscillation as soon as this is impressed, giving the curve of grid potential against time shown below the characteristic curve. The corresponding curve of plate current is shown at the right. As in Figure 52, the telephone current is the average of the plate current, and is seen to take a much larger jump

than before, when the received oscillation is suddenly impressed. Study of the figures will show that this is due to the greater change of slope over the working range of the characteristic curve in Figure 53 than in Figure 52 — that is, the tube is a more efficient rectifier when a local oscillation is present. In practice the local oscillation is much stronger relative to the received oscillation than represented in Figure 53 and the consequent improvement in telephone response is correspondingly greater. This improvement, however, cannot be increased without limit, for the characteristic curve ultimately straightens out (or reverses its curvature) at both ends, particularly when the telephone receiver imposes a considerable load. When the tube is used with a grid condenser, or when a crystal detector is used, the action of a local oscillation is broadly the same as that described above, the details only differing.

To attain the advantage described in connection with Figure 53, the circuit of Figure 51 may be employed, with the tickler coupling adjusted to produce a local oscillation. If, then, the circuit is carefully tuned to the frequency of the received oscillation, the two oscillations will have the same frequency and will pull into synchronism, so that they will rise and fall together, as in Figure 53. This automatic synchronising action is somewhat similar to that between two alternating-current generators connected in the same electrical system; for they also tend to pull into synchronism and have their voltages rise and fall together.

If the received oscillation is very weak, the synchronizing action will be correspondingly weak and

the circuit will have to be very carefully tuned. On the other hand, a strong received oscillation will pull the local oscillation into synchronism even when the circuit is appreciably out of tune. This is true because the tube will tend to oscillate as

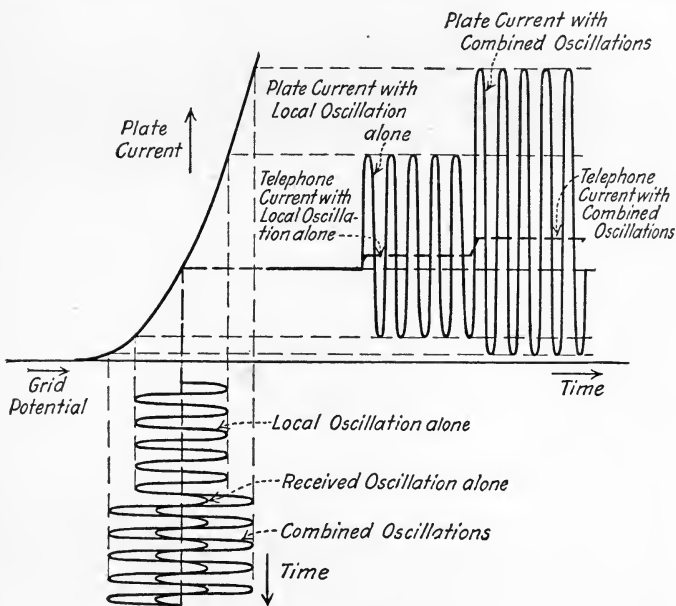

Figure 53

strongly as conditions will permit, and an oscillation assisted by the received oscillation will be stronger than a local oscillation unassisted, provided the received oscillation is not called upon to make up for too much mis-tuning.

When a circuit such as that of Figure 51 is employed for synchronous heterodyne reception, the tube is also serving regeneratively to amplify the

received oscillation. This regenerative amplification will not be so effective when the local oscillation is strong, as when it is weak or absent; for with a strong local oscillation, the mean slope of the characteristic curve will be lowered by a greater amount when the received oscillation is added. Thus, in practice, the telephone response is found to be loudest when the feed-back is adjusted to a point but slightly beyond that barely producing a local oscillation.

In a synchronous heterodyne system such as that of Figure 51, the tube is thus serving simultaneously all of the four functions mentioned at the beginning of this chapter — rectification, direct amplification, regenerative amplification, and oscillation. All of these functions combine to produce and strengthen the response in the telephone receiver. This system is sometimes called the “zero-beat” method, on account of the absence of the “beats” which occur in the non-synchronous heterodyne method described below.

Non-Synchronous Heterodyne Method of Radio-Telegraph Reception. — In radio telegraphy employing unmodulated continuous waves, no response would be heard in the telephone of a receiving set operated as described previously, except possibly weak clicks at the beginning and end of each dot and dash. To produce an audible tone it is necessary periodically to interrupt or modulate the received oscillation. The best method of accomplishing this result is by combining the received oscillation with a non-synchronous local oscillation, as originally proposed by Fessenden.

In Figure 54 are shown curves of voltage plotted against time for the received oscillation, the local oscillation, and their sum. The received oscillation is supposed to have a frequency of 10,000 cycles per second and the local oscillation a frequency of 9,000 cycles. The combined oscillation then *beats* at a rate of 1,000 cycles per second, which is the difference between the two frequencies of oscillation. This

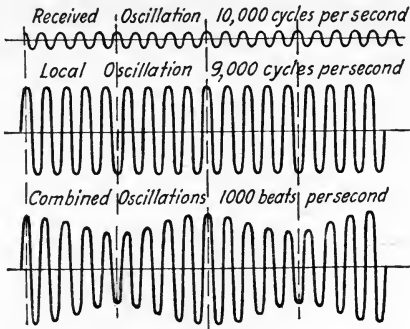

Figure 54

condition prevails because the received oscillation alternately adds to and subtracts from the local oscillation, repeating its effect every time it gains a whole cycle.

It is immaterial whether the received oscillation or the local oscillation has the higher frequency. Thus the local oscillation in Figure 54 might equally well have had a frequency of 11,000 cycles per second. The beats would still have been at the rate of 1,000 cycles as this is the difference between 11,000 and 10,000 cycles.

Thus the result of combining two oscillations of slightly different frequencies is an oscillation modulated at the difference between these frequencies,

the so-called beat frequency. When this modulated oscillation (as the lowest curve of Figure 54) is impressed on a rectifying detector, a current will be produced having the beat frequency and capable of actuating a telephone receiver. If the beat frequency is within the audible range, the telephone receiver will emit a pure musical note having a pitch corresponding to the beat frequency.

. A continuous-wave radio telegraph signal may be received with the circuit arrangement of Figure 51, the tickler coupling being adjusted for oscillation. The tube is then serving simultaneously as a local oscillator and as a regeneratively amplifying detector; this is called the *self-heterodyne method* of reception. With relatively low-frequency signal oscillations, the circuit must be considerably mistuned to give a beat note of suitable pitch; for the frequency of the local oscillation is always that for which the circuit is tuned. In this case, it is particularly desirable to employ a separate tube having its own regenerative circuit to produce the local oscillation, which is then impressed on the circuit of the detector tube through suitable coupling; this is called the *separate heterodyne method* of reception.

The radio frequencies employed in practice, especially those within the range of ordinary radio-telephone broadcasting, are much higher than those above. Thus, a received oscillation might have a frequency of 1,000,000 cycles per second (corresponding to a wavelength of 300 meters) and the local oscillation 999,000 cycles, giving a beat frequency of 1000 cycles. If the local oscillation is changed to 998,000 cycles (that is, only by one tenth of one per

cent.), the beat frequency becomes 2,000 cycles per second; this is double its previous value and corresponds to a change in note of one octave. Further, if the local oscillation is changed to 980,000 cycles (by about two per cent.), the beat frequency becomes 20,000 cycles per second, which is above the range of the human ear.

In operating a radio-telephone receiver with an oscillating detector tube, beats will be heard if the local oscillation is somewhat out of tune with the received oscillation, giving a nearly pure whistling note, in spite of the voice modulation of the transmitter. If the tuning is gradually varied from one side of synchronism to the other, a very high note will first appear; this will fall in pitch until it suddenly disappears and is replaced by the music or speech being transmitted; then the music or speech is lost again and the whistling note reappears with a low pitch, which rises until the limit of audibility is passed. As indicated in the preceding paragraph, all of these changes take place within a narrow range of local frequency and sometimes can be heard only if the tuning adjustment is moved very slowly. The sudden appearance and disappearance of the music or speech correspond respectively to the pulling in and dropping out of synchronism of the local oscillation with the received oscillation.

Noises Due to Local Causes in Vacuum-Tube Receivers. — In operating an oscillating receiver, it is sometimes noticed that when the regenerative effect is too strong a disturbance is produced which is evidenced in the telephone receiver by a regular succession of clicks, a "rattle" or a "squeal." This

effect occurs only when the tube is used with a grid condenser. It is caused by a periodic starting and stopping of the oscillation. The details of the action are about as follows:

When the oscillation first starts it causes the grid to acquire a negative charge, just as would a received signal, in accordance with the explanation given in connection with Figure 34. As the grid grows more negative, the regenerative effect of the tube is weakened and finally ceases, the oscillation then dying out. The grid and the grid condenser then gradually discharge through the grid leak; and when the potential of the grid rises sufficiently to restore the regenerative effect of the tube, the oscillation builds up once more. This action occurs over and over again. If it is slow enough, each new oscillation results in a click in the telephone receiver; if it is more rapid, the clicks merge into a rattle; if still more rapid the rattle reaches a musical pitch and becomes a squeal; and ultimately the oscillations may succeed one another so rapidly that the effect is above the limit of audibility. High values of capacitance in the grid condenser and of resistance in the grid leak show down the rate at which the oscillations are produced.

To obviate the disturbing effects just described, the regeneration should be reduced, as by loosening the tickler coupling in Figure 51. When this leaves the system in too critical a state, a lower resistance for the grid leak will tend toward establishing stability.

In receivers used with audio-frequency amplifiers, squeals or howls may result from coupling between successive stages, as described in Chapter V.

This effect would be present whether or not the detector tube is oscillating. Occasionally an oscillating receiver will howl due to a combination of radio-frequency and audio-frequency oscillations; these cases are exceptional and occur only when the grid circuit includes a coil of very high inductance.

Irregular noises in the telephone receiver, such as clicks and scratches, may be due to local causes, as loose connections, a run-down battery, irregularities in the electron emission of the tube, and mechanical vibration of the tube. Such effects are most conspicuous when amplifiers are employed.

During the adjustment of an oscillating receiver certain clicks are heard in the telephone which throw light on the operation. When an oscillation builds up or dies down, a change occurs in the plate current, which, if sufficiently rapid, will affect the telephone. Thus, to tell whether a tube is oscillating, quickly weaken or strengthen its regeneration (as by tightening the tickler coupling); a click or "thud" indicates the stop or start of an oscillation, or, more rarely, a sudden change in strength of oscillation. A surer method is to short-circuit the coil in the oscillating circuit, whereupon the oscillation will die down so rapidly as to produce a never-failing click. Often, simply touching the finger to a binding post in the oscillating circuit, will give a click indicative of oscillation; but weak clicks are sometimes thus produced even when the tube is not oscillating.

When the tuning of the antenna circuit in a receiver such as that of Figure 51 is continuously varied, two successive clicks are sometimes heard. The first represents the stopping of the oscillation as the antenna circuit approaches resonance with the grid

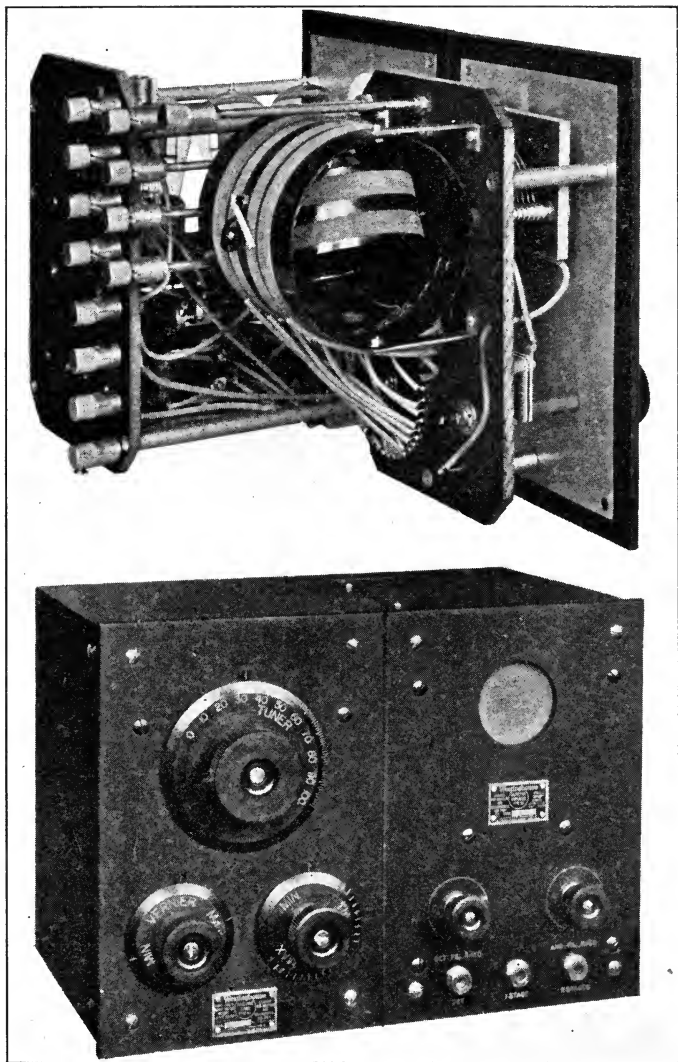

Plate IX.—Regenerative tuner, detector and amplifier (exterior and interior); *Westinghouse Electric & Mfg. Co.*

circuit, while the second represents the re-starting of the oscillation after resonance is passed. The regeneration should be increased so as to bring the points where the clicks are heard nearer and nearer together, until finally the clicks cease. The adjustment of the antenna circuit for resonance with the secondary circuit can thus be determined quite accurately, as lying between the points where clicks are heard.

Sometimes, only a single click (or "tweet," at longer wavelengths) is heard when the antenna tuning is varied as described in the preceding paragraph. This is caused by a jump in the frequency of oscillation as the antenna circuit becomes resonant with the grid circuit, and occurs only when the coupling is not very loose. This click will be found to occur at different points when the antenna tuning is varied in opposite senses. The true resonant point is between these two. In radio-telephone reception, the coupling should be loosened until the resonant click just disappears; at this coupling the synchronizing action and the freedom from distortion of the music or speech should be most favorable.

Touching the electric circuit, or simply moving the hand near an oscillating receiver or near the aerial system, will sometimes throw the local oscillation out of synchronism with the received oscillation and will interrupt the music or speech and replace it by a whistling beat note. This effect is due to variations in capacitance in the oscillating circuit; for the body acts as a conductor at ground potential. The trouble can be obviated in the design of a receiver by enclosing it in a metal case or shield, with the addition of electrical filters (if this refinement

is necessary) in the leads to external apparatus, such as the batteries and the telephone receivers. Frequently, however, reasonably satisfactory results are attained simply by arranging the apparatus so that the parts nearest the adjusting knobs are nearly at ground potential for the oscillation.

Interference and Atmospheric Disturbances. —

In modern radio communication the limitation to the distance that can be covered satisfactorily by a given transmitting station is imposed entirely by the inability of the receiving station to distinguish a signal, or music or speech, from disturbing noises from other transmitting stations and from "atmospherics." Weakness of the received oscillation by itself is not a limitation, for this can be amplified as much as desired. But disturbances are amplified as well.

In radio telegraphy trained operators can read incoming signals even when these are almost obscured by atmospherics or by powerful interfering signals. But in radio telephony, especially in the broadcasting of music, tolerable service requires that such disturbances be so reduced as to be barely noticeable.

The most difficult disturbance to be coped with is that due to nature — the so-called static, stray or atmospheric; for there is no possible control over its source. In fact, the sources of atmospherics are not at present completely known. Some are undoubtedly due to electromagnetic waves radiated by lightning flashes, which are large-scale spark discharges like those practically employed in spark radio transmitters. Others are due to gradual charg-

ing of the antenna from electric charges in the air, such as are carried by snowflakes, followed by sudden discharges through sparks between plates of the antenna series condenser; this is the true static and is rather easily eliminated by shunting the antenna condenser by a high-resistance coil to permit a gradual discharge. But much of the atmospheric disturbance is due to distant causes, perhaps having their seat in the upper layers of the atmosphere or even outside the earth's atmosphere.

Next to atmospheric, the most serious source of disturbance in radio-telephone reception is usually interference from spark radio-telegraph transmitters, or from other transmitters of oscillations that are abruptly started or terminated. Such oscillations act impulsively on receiving antennas and set up local oscillations even when the receiver is considerably out of tune with the transmitting station. Transmitting methods employing the spark or its equivalent are gradually being supplanted by methods employing generators of continuous oscillations, such as the vacuum tube. Their complete elimination will greatly extend the possibilities of radio-telephony.

Radio-telephone transmitters frequently interfere with one another, even when their wavelengths are not exactly the same. The modulation of the transmitter oscillation by the voice prevents sharp tuning of the receiver. The reason for this is that a modulated oscillation may be considered as consisting of the original oscillation, called the carrier, with the addition of two series of oscillations, called side bands, one having frequencies lower than that of the carrier, the other having frequencies higher than

that of the carrier. Each side band covers a range of frequencies beginning about two hundred cycles per second away from the carrier frequency and ending about three thousand cycles away, these values of frequency (200 to 3000) embracing the frequencies noticeably present in the voice and in music. Thus, if a carrier oscillation has a frequency of 1,000,000 cycles per second, the modulated oscillation will include in addition frequencies from about 997,000 to 999,800 cycles and from about 1,000,200 to 1,003,000 cycles per second. The corresponding wavelengths are included between 299 meters (corresponding to 1,003,000 cycles) and 301 meters (corresponding to 997,000 cycles) instead of being confined to 300 meters (1,000,000 cycles). This range of 2 meters is narrow, but conditions are much worse at lower carrier frequencies. For example, a carrier oscillation of 100,000 cycles per second, or of 3000 meters wavelength, will be accompanied by side bands extending from about 97,000 cycles (3100 meters) to about 103,000 cycles (2900 meters), thus embracing 200 meters. To avoid interference between radio-telephone stations there should be some margin of safety between the extreme frequencies in their modulated waves; thus their wavelengths should differ by more than 2 meters and 200 meters in the respective examples just given. It is possible (though not at present common practice) to eliminate one of the side bands, thus halving the band of frequencies included in the modulated wave which is transmitted, and doubling the number of radio-telephone transmitting stations that can operate simultaneously without interference.

Radio-telegraph transmitting stations employing

continuous waves and using the best methods of operation will ordinarily cause interference only with oscillating receivers, and then only when the difference between the frequencies of the transmitter and receiver is within the audible range. However, the best methods of operation are not always employed. The frequency of the oscillation may vary considerably as the transmitting key is manipulated, either purposely between dots and dashes, or accidentally when the oscillation builds up and dies down. The frequency may also vary due to accidental changes in the transmitting circuits, such as the swinging of an antenna in the wind. These frequency changes can be eliminated by the use of a so-called "master oscillator," which generates oscillations without interruption, for subsequent amplification and manipulation. Again, the oscillator may not be perfectly regular in its operation and may produce so-called "mush" in the receiver — a common fault of arc oscillators. Finally, the oscillator may produce an impure oscillation containing harmonics — that is, components having frequencies which are multiples of the fundamental frequency; this defect can be remedied by the use of loosely-coupled oscillating circuits in the transmitter.

Even when a continuous-wave transmitter gives a perfectly steady oscillation without harmonics, interference is sometimes caused in oscillating receivers tuned to quite different frequencies. Such interference is evidenced as the whistling note characteristic of beat reception. It has two possible origins: first, the transmitted oscillation may combine with a harmonic of the receiver oscillation to give audible beats (this requires that the trans-

mitter have a shorter wavelength than the receiver); and second, two continuous-wave stations may be transmitting with frequencies so near together that the beats between them will be produced in receivers and will be within the audible range.

Oscillating receivers will act as weak continuous-wave transmitters if the oscillation can reach the antenna. Single-circuit receivers, in which the main oscillating circuit is the antenna circuit, are particular offenders in this regard. These oscillations, though weak, are common causes of interference in receiving radio-telephone broadcasting; for many receivers in a given locality will be tuned to the same wavelength. If one of these receivers is oscillating and its tuning is being adjusted, its frequency will be varying around the value for which the other receivers are tuned, and these will pick up the oscillation and give the characteristic whistling beat note. Receiving stations employing loop or coil aerials radiate too little power to be ordinarily objectionable. To prevent radiation from receiving antennas, a radio-frequency amplifier may be used between the oscillating circuit and the antenna, and the latter left untuned. A coupled receiver, as in Figure 51, with very loose coupling will radiate only weakly.

A type of interference that is sometimes experienced is from neighboring electric power lines or from certain electrical processes having spark discharges, as X-ray outfits, electrical precipitators and ignition systems. Interference from power lines may be caused by induction and lie within the audible frequency range. The spark-discharge processes act as small spark-transmitting systems and may radiate electric waves as from an antenna.

The reduction or elimination of interference may be brought about at its source or at the receiver. In the former case it is accomplished by the substitution of better transmitting methods in the interfering stations, or by shielding apparatus which radiates waves only incidentally. The most elementary method of reducing interference at the receiver is by simple tuning, but to be generally effective this must be supplemented by careful arrangement and design of the receiving system. To attain high selectivity, the receiver should permit of sharp tuning, and this requires low resistances relative to the inductances in the oscillating circuits. As crystal detectors introduce much more resistance than vacuum tubes, they reduce selectivity. Several loosely-coupled tuned circuits through which the received oscillation passes successively (as the antenna and secondary circuits of Figure 51) increase selectivity. In general, an oscillating receiver is more selective than a non-oscillating one. Special circuit arrangements, of more or less complication, have been devised which increase selectivity; one of these will be discussed later. The coil aerial is more selective than the antenna, both because its resistance is the lower relative to the inductance, and because it permits of directional selectivity by its rotation about a vertical axis.

Radio-Frequency Amplification.—In receivers not employing the heterodyne method, amplification of the received radio oscillation prior to rectification would be much more effective than amplification subsequent to rectification, provided that the same degree of amplification could be attained. The reason for this fact may be illustrated by an example.

Consider a weak oscillation to be impressed directly on the grid circuit of a detector tube, and assume the rectified current through the telephone to be one unit under this condition. If an audio-frequency amplifier giving a voltage amplification of 10 times is now interposed between the detector tube and the telephone, the telephone current will be 10 units. On the other hand, if a radio-frequency amplifier had been interposed between the antenna circuit and the detector tube and had given the same voltage amplification of 10 times, the detector tube would not only have had 10 times as much voltage to rectify, but it would also have been ten times as efficient a rectifier; hence the telephone current would have been 100 units, or 10 times as great as before. The reason for the improved efficiency of rectification with the higher voltage is the curvature of the characteristic of the tube, as explained in connection with Figures 52 and 53.

Another advantage of radio-frequency over audio-frequency amplification lies in the fact that disturbing noises, such as are due to variations in the batteries, are not amplified to so great an extent; for these disturbances are usually at a relatively slow rate and are not so effectively transmitted through an amplifier designed for radio-frequency currents. On this account it is practicable to use many stages of radio-frequency amplification; whereas audio-frequency amplification is not usually applicable in more than two or three stages.

The most serious limitation to the use of radio-frequency amplifiers is the effect of the capacitances of the vacuum tubes, coupling apparatus and connecting wires. This is particularly true at short

wavelengths (very high frequencies), for the effect of capacitance increases directly with frequency. At the very high frequencies used for telephone broadcasting, these capacitances act almost as short-circuits for the radio-frequency currents. The vacuum tubes in most common use in this country have relatively high capacitances and are with difficulty employed in short-wave amplifiers. In England low-capacitance tubes are widely and successfully employed in multi-stage radio-frequency amplifiers.

The successive stages of a multi-stage amplifier may be coupled by transformers, by resistance, or by reactance coils (often termed choke coils), as described and illustrated in the preceding chapter. Resistance coupling is illustrated also by the amplifier *A* in Figure 55. When transformers are em-

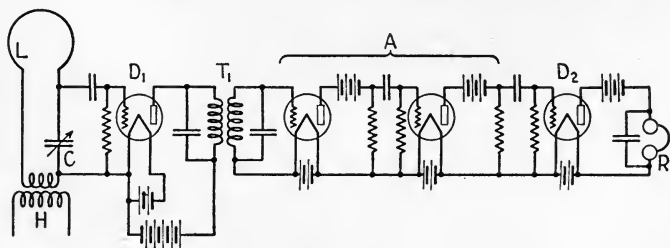

Figure 55

ployed, only a slight stepping up of voltage is generally feasible, on account of capacitance effects. Hence transformers do not offer such advantage over resistance or reactance coupling as they do in audio-frequency amplifiers. The inability to step up voltage between stages, together with the partial short-circuiting by capacitance, makes the ampli-

cation per tube less than in audio-frequency amplifiers; so more stages are needed in radio-frequency amplifiers to give the same over-all amplification.

The effect of tube capacitance can be practically neutralized by employing transformers or coupling reactances that are *tuned* to the frequency of the incoming oscillations. The tuning may be made very broad, so as to amplify over a considerable range in frequency without the necessity for adjustment, or it may be made sharp so as to increase selectivity. Sharply-tuned transformers between stages may be given a considerable step-up ratio, thus reducing the number of stages required.

Radio-frequency amplifiers, particularly those for very high frequencies, generally exhibit marked regenerative properties due to inherent capacitance coupling between stages. Unless care is taken to minimize these coupling capacitances by separating the circuits and surrounding them with metal shields, the regenerative effect will produce a strong continuous oscillation that will interfere with the amplification.

The most powerful regeneration in multi-stage amplifiers is that due to the feeding back of oscillating energy directly from the output circuit to the input circuit, that is, from the plate of the last tube to the grid of the first one. On account of the successive amplifications, the energy thus available for feed-back is enormously greater than in a regenerative circuit having only a single tube, as in Figure 51. Moreover, such feeding back of energy in a multi-stage amplifier can occur even when no inductance is present in the circuit, that is, when using resistance coupling only. The reason for this con-

dition is that the voltage is reversed in phase in successive stages, and, therefore, after passing through two stages it again has its original phase and is available for direct application to the input. A very small resistance coupling between certain tubes may result in undesired oscillation; consequently it is preferable to employ separate batteries, or, if this is not feasible, to take care to minimize the resistance of the common battery and connections.

To control the regeneration in a multistage amplifier, one may adjust either the feed-back coupling or the effective resistance of the circuit. The former method is employed in a scheme developed by the French during the Great War, in which the plate of one of the later tubes is coupled through small capacitances to the grids of two successive tubes of earlier stages. The coupling to one grid gives positive regeneration, or strengthening of the oscillation by feed-back of energy, while that to the other grid gives negative regeneration, or weakening of the oscillation by withdrawal of energy, on account of the phase reversal. The two couplings are adjusted together to give the desired net regeneration. The method of adjusting the effective resistance of the circuit is employed in a scheme developed by the British, also during the same period, in which the grids of all tubes are made slightly positive in potential (by a potentiometer rheostat connected in parallel with the filament) so that the grid circuit in each tube becomes somewhat conducting. The more positive the grids become, the less will be the tendency for oscillation. Adjustment of the filament current and of the plate voltage will also affect the regeneration, just as with a single tube.

Radio-frequency and audio-frequency amplifiers may be employed together in the same receiver, to give the greatest possible amplification. A special arrangement of circuits allows the same vacuum tubes to be employed successively for both amplifications. This arrangement was used by the French during the War and had the advantage of requiring fewer tubes, causing less drain on the batteries.

Super-Heterodyne Method of Reception. — The difficulty of designing and constructing radio-frequency amplifiers for very high frequencies, as mentioned above, led Armstrong to devise a method of amplification called the *super-heterodyne*.

A typical circuit for applying the super-heterodyne method is that of Figure 55. Here L represents a coil aerial, H is a coil connected to a vacuum-tube oscillator, D_1 is a vacuum-tube detector, T_1 is a tuned high-frequency transformer, A is a multi-stage high-frequency amplifier (four or more stages are used in practice, in place of the two shown), and D_2 is a second vacuum-tube detector. The principle of operation consists in combining the local oscillation from H with the oscillation received in L to produce beats *which are of a frequency above audibility* but of course below the frequency of the received signal, in then rectifying the beating oscillation by D_1 , in next amplifying this rectified beat oscillation in A , and in finally rectifying the amplified oscillation in D_2 so as to reproduce the music or speech in the telephone receiver R . This may be made clearer by an example:

Suppose that the received oscillation has a frequency of 1,000,000 cycles per second (wavelength

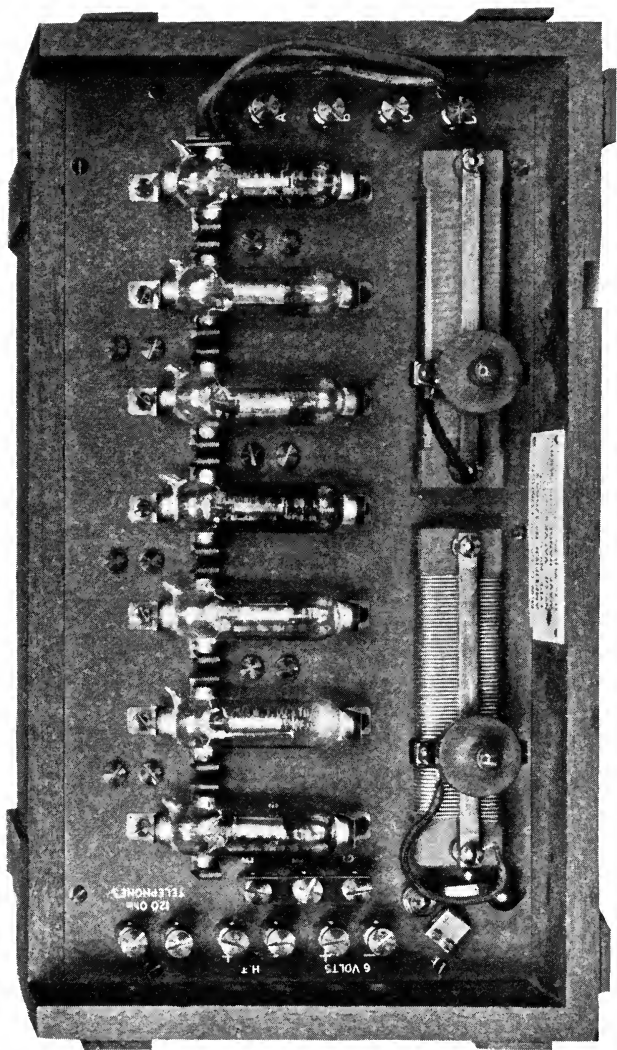

Plate X. — Radio-frequency amplifier (five stages), detector, and audio-frequency amplifier (one stage);
Marconi's Wireless Telegraph Company, Ltd.

of 300 meters). Then the local oscillation of H may be adjusted to a frequency of 1,050,000 cycles, producing beats at a rate of 50,000 per second. When this beating oscillation is rectified by D_1 , there is produced in the plate circuit an oscillation having a frequency of 50,000 cycles. Both the primary and secondary circuit of T_1 are tuned to this 50,000-cycle frequency. The 50,000-cycle oscillation is then amplified in the successive stages of A and is finally impressed on D_2 . Now the original received oscillation had been modulated by the music or speech at the transmitter. The beating oscillation retains this modulation, as will the 50,000-cycle oscillation in passing through the amplifier. Hence the second detector D_2 receives a modulated 50,000-cycle oscillation, which is rectified to produce a modulated direct current through the telephone receiver. The music or speech heard will, therefore, faithfully follow that which does the modulating at the transmitting station.

The primary purpose of the system just described is to permit the employment of the multi-stage amplifier A designed for a frequency (such as 50,000 cycles per second) that avoids, on the one hand, the limitations of a radio-frequency amplifier for the received oscillation frequency (such as 1,000,000 cycles) and, on the other hand, the limitations of a multi-stage audio-frequency amplifier. The limitations to amplification at the frequency of the received oscillation lie in the exaggerated effects of capacitance at this very high frequency. The limitations to amplification at audio frequency lie in the simultaneous amplification of battery noises and other audio-frequency disturbances.

The super-heterodyne system has, however, another very important advantage — that of high selectivity between received oscillations of nearly the same frequency. Suppose that the circuit of Figure 55 is receiving an oscillation of 1,000,000 cycles and that there is interference from a received oscillation of 1,005,000 cycles, that is, differing in frequency by only one-half per cent. and thus incapable of being tuned out directly. If the local oscillation has a frequency of 1,050,000 cycles, it will produce beats with the two incoming oscillations at a rate of $(1,050,000 - 1,000,000 =)$ 50,000 and $(1,050,000 - 1,005,000 =)$ 45,000 per second respectively. But frequencies of 50,000 and 45,000 cycles per second differ by 10 per cent and may be selected readily by tuning. This is the purpose of the tuned transformer T_1 .

It will not do in radio-telephone reception to have the tuning of T_1 too sharp; for as explained previously, the received oscillation has one or two side bands extending about 3000 cycles per second from the carrier. The transformer T_1 must also be capable of efficiently transmitting oscillations extending about 3000 cycles from the beat frequency (that is, from 50,000 to 53,000 cycles per second in the example chosen, if only one side band is transmitted, and from 47,000 to 53,000, if both side bands are transmitted). Circuits known as band filters, invented by Dr. G. A. Campbell, and now regularly applied in wire telephony, have the property of efficiently transmitting all oscillations within a given band of frequencies and of excluding all other oscillations. Such band filters may find application in place of the tuned transformer.

CHAPTER VII

RADIO TELEPHONE BROADCASTING

BY JOHN V. L. HOGAN

Consulting Engineer; Fellow and Past-President, Institute of Radio Engineers; Member, American Institute of Electrical Engineers.

What Broadcasting Is. — Every radio message, whether in the dots and dashes of the Morse code or in spoken words, is sent broadcast in all directions from the transmitting station. This has been true of all wireless communication since the days of the pioneer work of Marconi and Fessenden, some twenty-five years ago. Thus, there is no technical distinction between what goes on in broadcast radio telephony, as it is known today, and the wireless telephone operations of a few years ago. On the other hand, there is a vast practical difference between the two.

Broadcasting of the present time uses the well-established technology of radio signalling, but applies it in an entirely novel way. Since the broadcast radio is a public service, it must be so operated as to appeal to the interest of large numbers of listeners, considered collectively. Therefore, instead of spreading through the ether of space a series of communications from some certain individuals to some certain others, and possessing only an individual meaning or appeal, the broadcasting trans-

mitter must radiate a comprehensive program of music, news, educational and informative speeches, stories and even religious services.

Wherever there is a radio-telephone station sending out, on regular and well-known schedules, material of general public value, there exists broadcasting as it is now recognized. If such a transmitter is favorably located, as for instance in or near a great city, there will be tens of thousands of listeners to every word radiated. So the speech of man may be made to reach an audience of tremendous numbers, scattered far over the land, in a way which no communication system other than radio could make possible.

The Physical Characteristics of Radio, in Their Relation to Broadcasting.— It has been pointed out that the electromagnetic waves which are shot off by a radio transmitting antenna pass out from it in all directions. The greater part of the energy of these waves remains comparatively near the surface of the earth, but expands radially outward from the sending station. Receivers located at points equally distant from the radiating aerial will receive signals of nearly the same strength, regardless of their direction; the waves pass over seawater with less loss of energy per mile of travel than over land, and over some types of land more easily than over others. Nevertheless, a receiver 50 miles north of the station "WJZ" at Newark, N. J., for example, will receive speech and music with very nearly the same intensity as will a similar receiver located 50 miles east, south or west of Newark. The radio waves spread out approximately in ever-

widening circles, as indicated by Figure 56 where the radial arrows point out the directions of wave-motion originating at Newark. The intensity of the radiated wave becomes less and less as it passes out from the sending station, as is suggested by the de-

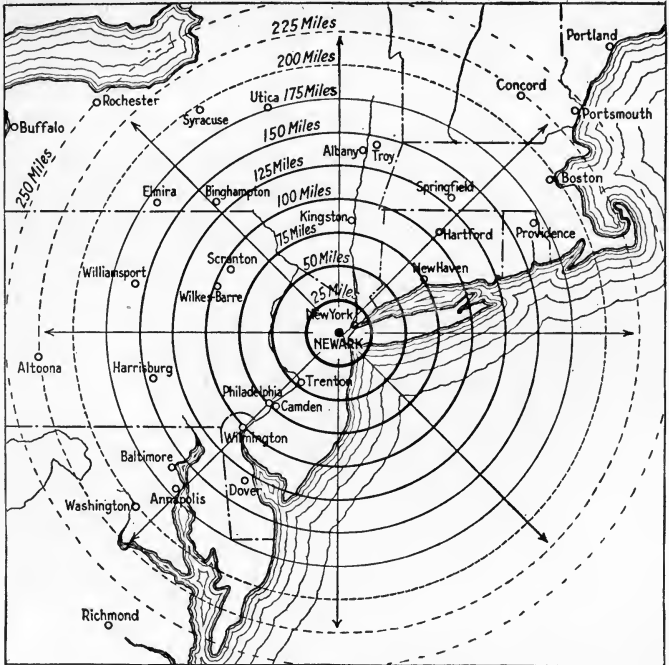

Figure 56

creasing width of the circles in the figure. The speed of the waves is very nearly that of light, about 186,000 miles per second; consequently the signals reach a point 100 miles away in a trifle over one two-thousandth of a second after they leave the point of origin.

Radio waves are evidently just the thing for broadcasting; they spread out nearly equally in all directions, and in fact they refuse to be confined to a narrow or directed path from one sending station to a single receiving station. For years, inventors have attempted to project radio waves directly toward a receiving station which it was desired to reach, but all endeavors to confine the waves to a path somewhat resembling a beam of light have failed. If this result is ever secured, point-to-point radio transmission will be carried on with greater economy and secrecy than is practical today. In the meantime, the persistently non-secret, wide-spreading qualities of wireless radiation make the system ideal for broadcast operations.

Contrast Between Broadcasting and Point-to-Point Systems. — Until about November, 1920, the only substantial uses of radio were for signaling between pairs of stations. In general, there was on hand a message to be forwarded from one place to some particular person at another place; the sending station called and established communication with the station of destination, and then transmitted the message in question. That this message was heard simultaneously by a hundred other receivers was considered merely a wasteful incident which was unfortunate but unavoidable. True enough, the broadcasting character of the radio waves was partially utilized; for any one radio station might communicate with any other within range, regardless of direction, and a call sent out from shore would reach a desired ship far out on the high seas even though her location were unknown. But for point-to-point

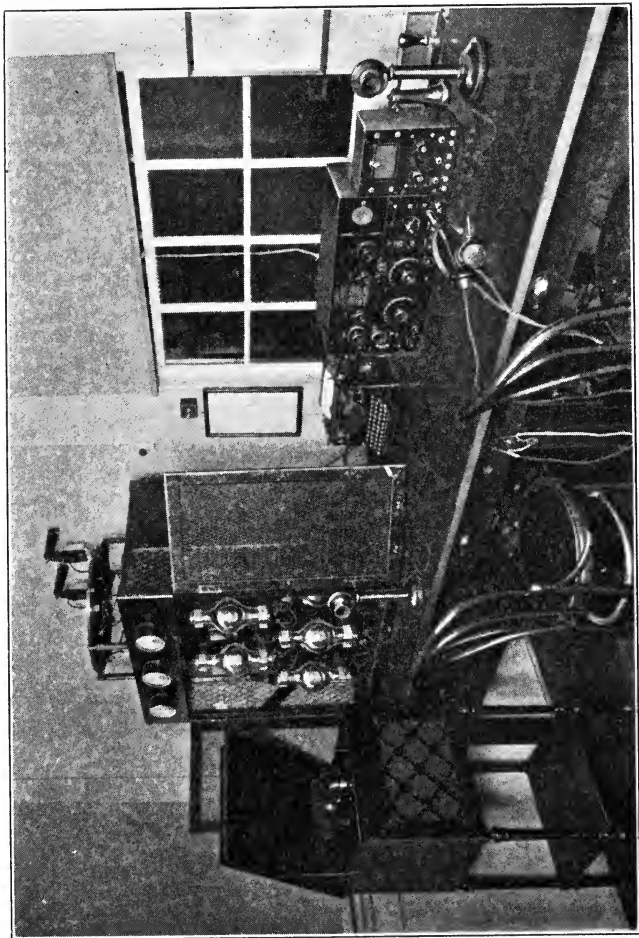

Plate XI.—Apparatus Room of the Newark Broadcasting Station,
Westinghouse Electric & Mfg. Co.



working, such as in the important trans-oceanic systems, the spreading out of the waves was obviously a disadvantage. Only in a few types of work was the wide distribution of signals valuable; these were: first, in sending SOS or distress calls, where aid was wanted from any or all listening stations; second, in sending time signals and weather reports (a true broadcasting activity); and third, in transmitting a general order to a fleet of naval or commercial vessels.

It had been proposed to take advantage of the inherent form of radio wave propagation for distributing news despatches simultaneously from a central station to outlying agencies or newspapers, as an economy over the use of wire lines for the same purpose. This plan was never adopted by the news services, however, and it remained for the Westinghouse company to inaugurate public radio-telephone broadcasting by transmitting the 1920 election returns from the East Pittsburgh station and following this with the daily concerts which have since been maintained. Broadcasting has now become so firmly established as a utility, and has proved itself to be of such great value, that the general tendency seems to be toward using radio chiefly for general or widespread communication, and for signaling to, from and between ships, aircraft and isolated points on land, while insisting upon utilization of wire lines for normal point-to-point working. There exists only a somewhat restricted number of radio-frequencies or wavelengths suitable for independent use as non-interfering communication channels; and it is obvious that each of these has a far greater economic value when used for broadcast transmission

reaching thousands of listeners than when limited to conveying a specific message for some one person.

Radio-Telephone Transmitting Apparatus. — The apparatus used to send forth into space the electromagnetic waves which carry speech or musical vibrations in any radio-telephone sending system, consists of three essential parts. The first of these is a radio-frequency *generator*, which will produce uninterrupted constant-amplitude alternating current of exceedingly high frequency. The second is a *modulator*, which will control the amplitude of this alternating current and vary it in strict accordance with the sound vibrations to be transmitted. The third is the *radiator* or antenna system, which will aid in converting the sound-modulated radio-frequency currents impressed upon it into corresponding electromagnetic waves in the ether of space.

In the first experimental radio telephone, built by Professor R. A. Fessenden about 1904, the generator was of the high-frequency spark type illustrated in Figure 57. A special high-speed rotary spark gap

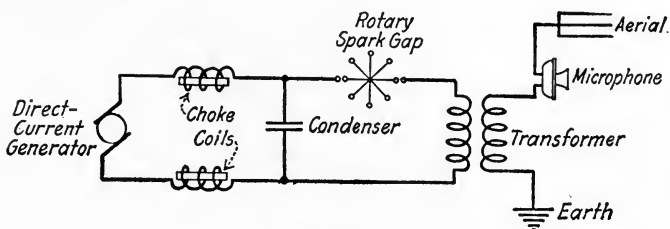

Figure 57

discharged the condenser some 5,000 to 10,000 times per second, the charge being renewed from the high

voltage generator shown. Since the condenser discharges passed through a low-resistance circuit including the transformer primary, each spark produced a train of radio-frequency oscillations. These oscillations were transferred inductively to the antenna circuit, where their strength was controlled by voice waves acting on the microphone transmitter. Although the waves radiated were not perfectly continuous, they were substantially so, their interruptions or amplitude variations occurring so rapidly that speech of quite good quality could be transmitted. Using an apparatus of this sort the writer, in 1912 or thereabout, transmitted radio-telephone speech over 100 miles to a station using a simple crystal receiver, with less than one ampere of radio-frequency current in the transmitting antenna circuit.

About 1906, the spark generator of Figure 57 was replaced by a dynamo capable of generating a sustained alternating current of some 80,000 cycles frequency. Such an alternating current, when flowing in an aerial wire system, will cause the radiation of electromagnetic waves of perfectly constant maximum amplitude and having a wavelength of 3750 meters (almost exactly ten times the length of the broadcasting radio-telephone waves used today). This first radio-frequency alternator was designed by E. F. W. Alexanderson, under the guidance of Professor Fessenden, was built by the General Electric Company, and was the forerunner of the powerful Alexanderson alternators of today. This early machine was splendidly executed mechanically and electrically and was capable of generating approximately one kilowatt of radio-frequency power. It

gave excellent results in the radio-telephone transmitter circuit illustrated in Figure 58. With this arrangement speech and music were transmitted from the National Electric Signaling Company's experimental station at Brant Rock, Mass., first a distance of 12 miles to Plymouth, Mass., and in 1907 a distance of 200 miles to Jamaica, L. I.

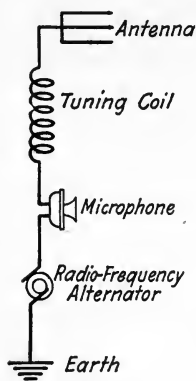

Figure 58

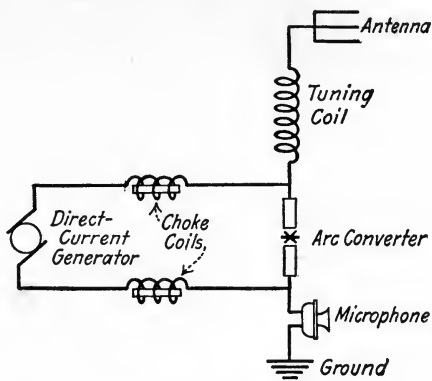

Figure 59

The third type of radio-telephone transmitter, historically speaking, utilized as its high-frequency generator the arc converter invented by Poulsen. The simple circuit is shown in Fig. 59. Direct current supplied to an arc drawn between copper and carbon electrodes, in an atmosphere of hydrogen gas, was transformed into somewhat irregular but practically continuous radio-frequency currents in the antenna circuit. The strength of these currents was controlled in accordance with the sound waves impinging upon the transmitter microphone connected, as before; between the aerial and ground. Arc apparatus of this type could be operated at



Plate XII.—Radiotron transmitting tube; *Radio Corporation of America.*



wavelengths shorter than those feasible for the direct generation system of Figure 58; but because of irregularities in the converter, causing unavoidable noises in the speech and music transmitted, this type of sender has practically dropped from view.

The advent of the oscillating audion or three-electrode vacuum tube, based mainly upon the work of De Forest and Armstrong, changed entirely the complexion of short-wave radio telephony, such as is used in broadcasting. The tube oscillator provided an inexpensive, essentially dependable, and uniformly operating generator of alternating currents of the highest radio-frequencies, as well as a valuable control-amplifier or modulator by means of which the constant-amplitude oscillations could conveniently be shaped in conformance with sound waves. Such tube generators and controllers have been widely adopted in the broadcasting service.

A Typical Broadcasting Station. — It may be interesting to examine in some detail the equipment of a central radio-telephone station, such as that at Newark, N. J., so widely known by its official call letters "WJZ." Here the aerial is supported between two 120-foot steel masts mounted on the roof of the Westinghouse factory, thus placing the flat-top or horizontal portion of the antenna some 200 feet above the ground level. The aerial itself consists of six wires strung between two 20-foot spreaders about 150 feet apart, down-leads being dropped from the northwest end to the radio station below and from the southeast end to a "multiple" tuning coil. These downleads are in cage or cylindrical form. Directly below the antenna, and 12

feet from the roof level, is mounted a multiple wire counterpoise or artificial earth connection, of the type which has been found exceedingly effective in short-wave transmission.

The radio apparatus is contained within a small house built on the roof of the factory. As shown in Plate XII, a bench along one side of the room carries the transmitter, a receiver, and the switching and signaling systems, as well as a standard microphone for operation of the radio outfit. Special "pick-up" transmitters are also provided for the sending out of phonograph music, but ordinarily this radio room serves only as a control station, the speech and music to be broadcast coming in by wire from the Studio on the main floor of the factory building.

The Newark radio transmitter is of the so-called plate modulation or Heising type, a simplified diagram of which is shown in Figure 60. This dia-

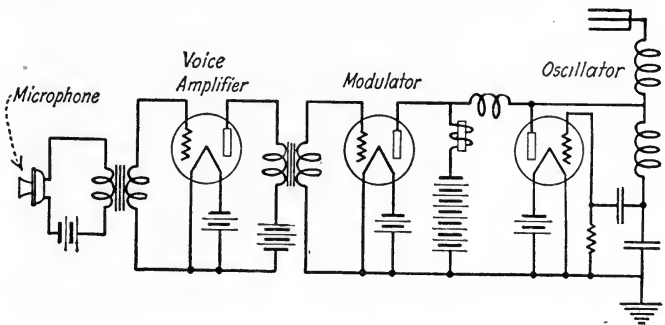

Figure 60

gram does not represent in detail the complicated connections used at "WJZ," but is fully illustrative of the principles involved. A microphone trans-



Plate XIII. — Luella Melius singing at the Newark Broadcasting Station
(Westinghouse photograph).

mitter is shown at the left; sound vibrations acting on its diaphragm create corresponding electrical variations in the battery and transformer circuit immediately associated with the transmitter. These electrical variations, which constitute an audio-frequency alternating current as described in the earlier chapters, pass through the voice amplifier tube-system as shown. Here they are greatly intensified, and, in their strengthened (but otherwise identical) form, carried into the modulator tube-system. The three large vacuum tubes shown across the lower half of the transmitter panel, in the photograph of the Newark radio room, comprise the modulator system. The function of the modulators is to shape or control the radio-frequency currents in the antenna system so that they will carry the variations of the sound waves which reach the microphone.

At the right of Figure 60 is illustrated a typical regenerative vacuum tube oscillating system, including the antenna and ground (or counterpoise) circuit. At Newark, the two upper tubes, shown in Plate XII, are the oscillators, which, by the well-known feed-back circuit action, produce in the antenna a uniform, constant-amplitude alternating current of 833,000 cycles per second. This radio-frequency current in the aerial system causes the radiation of the 360-meter electromagnetic waves used in the broadcast service.

The simplest way to consider the action of the modulator tubes in this type of transmitter is to look upon them as variable voice-controlled resistances which rob the oscillating system of energy. When the modulator tubes have high resistance, the

oscillators generate radio-frequency current at practically maximum intensity. When the microphone system, through the action of the voice or music, lowers the resistance of the modulator tubes it is evident that energy will be drawn from (or by-passed around) the generating system and that the oscillations will be weakened. At intermediate values of resistance, the oscillations will take corresponding intermediate intensities; thus the antenna currents, and necessarily, therefore, the radiated waves, are controlled in amplitude so that they reproduce exactly the initial sound waves.

As can easily be imagined, the vacuum tubes used for generation and modulation must be much larger than those common in receiving sets. Although the internal structure consists of the familiar filament, plate and grid systems, the whole arrangement is much enlarged. In Plate XIII one form of such large amplifying or transmitting tube is shown; such an audion is about 5 inches in diameter by 14 inches long, and operates under a 2000-volt potential in the plate circuit.

The pick-up microphone transmitter of Figure 60 need not be in the radio room. At Newark there is provided a special telephone line leading downstairs to the Studio, where several phonographs, an orchestrelle organ and a duo-art reproducing piano are installed. Two views of the Studio are given in Plates XIV and XV. In the former is seen the special cylindrical pick-up transmitter which is substituted for the microphone to give a more perfect reproduction of music; and in the other there appears a phonetron or wide-angle pick-up which not only gives especially good reproduction of music, but



Plate XIV.—Lydia Lipkovska singing at the Newark Broadcasting Station (Westinghouse photograph).

is desirable for transmission of chorus singing, orchestras and other ensemble music.

At the left of the Studio is a panel-board carrying signal lights, control switches and telephone circuit connections. At the beginning of a program, the operator in the radio room on the roof starts the transmitter and immediately transfers the controls to the Studio. Here the announcer, having been signalled by a flashing light that all is ready, takes up the work; using whichever transmitter he desires, he names for the radio audience the artist about to perform and the selection to be transmitted, and switches the appropriate pick-up into circuit. Then the concert begins; like the announcements, the music travels by wire to the radio room, thence to the antenna, and, radiating outward in all directions, to the thousands of receiving stations which are listening every evening.

Essentials of Radio Broadcasting.—The first radio-telephone broadcasting consisted mainly of news items and phonograph music. Soon the scope of the programs was extended to include vocal and instrumental music transmitted directly by the performing artists instead of from records. Speeches and lectures on a variety of subjects were introduced and the re-transmission of Naval Observatory time signals marking exact noon and 10 P.M. Eastern Standard Time was added. These time signals are received on 2500-meter wavelength at the broadcasting station, by radio from Arlington, Va., and relayed out again on the 360-meter radio-telephone wave.

It is not easy to forecast the further developments in programs. Without doubt, the listening stations

in any zone will soon be able to pick up both afternoon and evening concerts of ambitious scope; moreover, the Department of Commerce indicates that additional wave-frequencies or broadcasting channels will be opened up before long. It will thus become possible for the central stations to provide simultaneous programs of different character; a receiving operator may then select, for example, light music, classical music or news bulletins, merely by changing the tuning of his receiving instrument to pick out the particular wavelength which carries the sounds he wishes to hear.

Many people have asked — “Why did not radio-telephone broadcasting attain several years ago the position which it has now reached as a public service?” The answer seems to be that, although the technology of present-day radio communication is not very different from that of, say, three years ago, there is now a great difference in the organization of the service. The factors which appear to have been of the greatest importance in the rise of broadcasting to its present popularity are:

1. The programs transmitted are of so high an aesthetic quality as to make a general recreational and educational appeal.

2. The technical character of the broadcast transmission is such as to permit, in the home, reproduction of speech and music having purity and clarity surpassing that of the phonograph.

3. Programs are sent out daily, in all parts of the country, on well established and previously announced time schedules.

4. Inexpensive and easily operated receiving apparatus of high efficiency is now available.

It appears that these four points were first brought together in the fall of 1920. Quite obviously the addition of a fifth item, namely, the simultaneous transmission of programs of varying characters on different wavelengths, will introduce the element of choice or selection by the listener and will give still further impetus to the growth of broadcast radio-telephony.

The Extent of Radio Broadcasting. — The manner in which radio has been taken up by the American public at large is almost incredible. In March, 1922, Secretary Hoover, of the U. S. Department of Commerce, said that although only 50,000 radio transmitters and receivers were in use in the United States a year before, it was reasonable to place the current number at 600,000 outfits. In cities where broadcasting stations have been established, there are several radio receivers in use in every city block. Instruments suitable for listening to the broadcast entertainments are being manufactured and sold, by a large number of companies, at a total rate which is reasonably estimated to be in excess of 100,000 sets per month. This means more than 1,500,000 radio receivers in use at the end of 1922.

Central broadcasting stations are in operation at Springfield, Mass., Schenectady, N. Y., Newark, N. J., Pittsburgh, Pa., Chicago, Ill., Detroit, Mich., on the west coast, and at various intermediate points. The best-known of these plants operate on daily schedules; other installations are being started on a similar basis. Most of the stations have a normal range of several hundred miles and are heard thousands of miles under favorable conditions; conse-

quently, there is no place in the country where radio-telephone broadcasting may not be heard at times and even frequently. The number of points where a moderately good receiver will be unable to intercept nightly programs is rapidly decreasing to the vanishing point, if, indeed, any such places remain today. Broadcasting is already nearly, if not quite, a national utility.

The Public Value of Radio Broadcasting. — How can one appraise the worth of the broadcast radio-telephone service? How does its value now compare with that which it will have one year or five years hence? These are questions worthy of study; their answers, at the moment, can hardly be more than groped for.

In the radio telephone we have an instrument whose potentialities are amazing. Already it brings amusement and cheer to the hospitals, church services to the home-bound, and entertainment and news to the isolated. From the radio telephone, those who desire recreation can secure the endless variety of an ever-renewed library of phonograph records, yet they are spared any expense beyond the initial cost of their receiving instruments. Listeners whose interest inclines in other directions may take advantage of the health lectures being transmitted by government stations, or the training in foreign languages which some of the universities propose. Stock market bulletins, crop reports, play-by-play descriptions of athletic contests; all are sent broadcast by radio. For the future, we may expect that the service will provide any and every type of information or entertainment which can be transmitted by telephone

and which will be of common interest to any substantial number of listeners.

Increased efficiency of communication always makes for the elimination of geographical differences. It tends toward greater national and even international harmony. Increased facilities for widespread dissemination of educational matter invariably aid in advancing the national average of intellectual attainment. Increased distribution of the finer products of the musical art inevitably stimulates popular appreciation of and sensitiveness to the less materialistic aspects of living. Increased familiarity with the exact phenomena of science necessarily tends to produce a much needed keenness of perception and power of logical reasoning. Radio-telephone broadcasting works in all four of these directions; aside from its immediate and obvious utility, it possesses an inherent cultural value which is well-nigh immeasurable. At the same time it serves us all by providing information and amusement which we can secure so easily and so quickly in no other way, and it has already been rewarded by a most unusual degree of public appreciation.

OTHER BOOKS BY THE SAME AUTHORS

ALFRED N. GOLDSMITH

Radio Telephony

250 Pages. 225 Illustrations. Postpaid, \$2.50

JOHN H. MORECROFT

Principles of Radio Communication

945 Pages. 785 Illustrations. Postpaid, \$7.50

Continuous and Alternating Current Machinery

465 Pages. 285 Illustrations. Postpaid, \$2.75

A Laboratory Manual of Alternating Currents

260 Pages. 175 Illustrations. Postpaid, \$2.80

A Short Course in the Testing of Electrical Machinery (with F. W. Hehre)

230 Pages. 110 Illustrations. Postpaid, \$3.00

ERICH HAUSMANN

Telegraph Engineering

405 Pages. 195 Illustrations. Postpaid, \$3.00

Dynamo Electric Machinery

About 500 Pages. In Press.

Electric Traction and Transmission Engineering (with S. Sheldon)

305 Pages. 125 Illustrations. Postpaid, \$3.00

Physical Laboratory Experiments for Engineering Students (with S. Sheldon)

135 Pages. 40 Illustrations. Postpaid, \$1.50

Lessons in Practical Electricity (with C. W. Swoope)

625 Pages. 485 Illustrations. Postpaid, \$2.50

A Complete Electrical Course

for home study giving in plain language a logical presentation of the essentials of practical electricity simple enough for beginners and yet accurate enough for experts. For a complete exposition of modern theory and practice read

SWOOPE'S LESSONS IN Practical Electricity

Sixteenth Edition, Rewritten, Revised and Enlarged

BY HARRY NOYES STILLMAN

Late Instructor at the Spring Garden Institute, Philadelphia

AND

ERICH HAUSMANN, E. E., Sc.D.

*Professor of Physics at the Polytechnic Institute of Brooklyn
and fellow of the American Institute of Electrical Engineers*

630 Pages $5\frac{1}{2} \times 7\frac{1}{2}$ **488 PICTURES** **31 Chapters**

CONTENTS: Magnets. Magnetism. Voltaic Electricity. Primary Cells. Resistance. Effects Produced by the Electric Current. Measurement of Current. Ohm's Law. Series and Parallel Battery Connections. Practical Application of Ohm's Law. Electrical Work and Power. Storage Batteries. Electromagnetism. Electromagnets. Electrodynamics. Galvanometers. Ammeters and Voltmeters. Wattmeters and Watt-Hour Meters. Measurement of Resistance. Electrical Development of Heat. Electromagnetic Induction. Practical applications of Electromagnetic Induction-Telephony. Principles of Dynamo-Electric Machines. Armatures. Direct-Current Generators. Direct-Current Motors. Electric Lighting. Alternating Currents. Alternating-Current Apparatus and Machinery. Alternating-Current Motors. Radio Signaling :: :: :: :: :: **\$2.50**

D. Van Nostrand Company

Publishers and Booksellers

8 WARREN ST. NEW YORK

The
**Literature of Engineering
and the Industries**

¶ On our shelves is the most complete stock of engineering, scientific, technical and industrial books in the United States. A large number of these we publish and for an ever increasing number we are the sole agents.

¶ *All inquiries are cheerfully and carefully answered and complete catalogs as well as special lists are sent free on request.*



D. Van Nostrand Company
PUBLISHERS AND BOOKSELLERS
8 WARREN STREET NEW YORK

