

THE WILEY TECHNICAL SERIES
FOR
VOCATIONAL AND INDUSTRIAL SCHOOLS

EDITED BY
JOSEPH M. JAMESON
GIRARD COLLEGE

PRINTING

A TEXTBOOK FOR PRINTERS' APPRENTICES,
CONTINUATION CLASSES, AND FOR
GENERAL USE IN SCHOOLS



BY

FRANK S. HENRY

INSTRUCTOR IN PRINTING
PHILADELPHIA TRADES SCHOOL

FIRST EDITION

NEW YORK

JOHN WILEY & SONS, INC.
LONDON: CHAPMAN & HALL, LIMITED

1917

nd

Copyright, 1917
BY
FRANK S. HENRY



U.S. GOVERNMENT PRINTING OFFICE

PREFACE

ACCORDING to the Census of 1910, printing ranked sixth among the important industries of the United States, with an invested capital of \$588,000,000, and offering employment to over 258,000 persons. Since that time it has been steadily advancing. The printing business today is replete with labor- and time-saving devices, and is being conducted on the basis of both expediency and efficiency. All well-equipped and properly conducted printing establishments have installed cost systems, and, by the use of time-stamping devices, are keeping accurate account of the time that employees spend on their jobs.

While, in many respects, these changes have been of advantage to the employer, they have been to the detriment of the apprentice. Formerly it was the custom to put an apprentice in the care of some competent workman. In the course of four years the journeyman was supposed to impart to the apprentice a full, working knowledge of the trade. Today the journeyman is practically working against time; he cannot train an apprentice and still make a creditable showing, consequently the average apprentice is simply drifting along, picking up what knowledge he can. If he is apt, he may learn to perform certain operations of the trade by imitation, usually without knowing why. This lamentable condition does not exist in every office, it is true, but it is prevalent enough to demand attention. Employers are beginning to realize that in striving for efficiency in production they have been neglecting a still more vital factor—that of training efficient help.

With the idea of formulating some definite plan for the training of apprentices, the United Typothetæ of America in 1911 appointed an apprenticeship committee to investigate the matter. This resulted in the establishment of a permanent committee. It was realized that if apprentices were to be uniformly trained a series of textbooks was necessary. The committee has in preparation sixty-four books, fully covering every phase of printing. This will undoubtedly be a valuable library of technology. The price of the complete series, however, will debar it from everyday use in the schoolroom.

When the author first undertook the teaching of printing at the Philadelphia Trades School, he was handicapped by the lack of a textbook. There were many excellent books on the subject of printing, but none, so far as he knew, compiled especially for school use. At the present time the local unions throughout the jurisdiction of the International Typographical Union are collaborating with the various local typothetæ, and endeavoring to establish continuation schools for printers' apprentices in all the large centers throughout the United States. This means, naturally, an increasing demand for a practicable medium of instruction in the trade, and relying upon an experience of twenty-five years of actual practice in the shop, in every position from apprentice to superintendent, coupled with five years of teaching, the author has attempted to supply this need.

In the preparation of the manuscript, the author has kept in mind the fact that he is addressing the boy who knows nothing of the subject. The aim has been to explain fully, yet succinctly, the fundamental principles underlying the various processes. To the initiated the attention given to details at times may seem unnecessary. In the more advanced processes, however, it is hoped that even the practical man may find helpful suggestions.

It is manifestly impossible in a book of this size to cover every point and phase of printing. An attempt has been made, therefore, to present clearly and simply only those essentials

of the subject on which both teacher and student may build, and in this way to keep the book brief enough to meet the requirements of a practicable text and of a size conveniently to be carried in the pocket.

It has been an inspiration to the author in his work as a teacher to look back to his apprenticeship days, when he was singularly fortunate in being trained by a skilled workman, and he takes this opportunity of expressing his gratitude to Mr. James H. Sterrett for guidance during that formative period. Acknowledgment is also due to Mr. T. Grow Taylor for kind advice and helpful suggestion when the author took up the study of proofreading, and also for his kindness in critically reading the manuscript of the chapter on Proofreading.

The author acknowledges his indebtedness to Mr. Frederic W. Goudy and Mr. Frank J. Milon for revision of some of the text and to the following firms for the loan of cuts and other material used in illustrating the book: American Type Founders Co., Bullock Manufacturing Assoc., Challenge Machinery Co., Chandler & Price Co., Golding Manufacturing Co., Hamilton Manufacturing Co., Horace Hacker & Co., H. A. Hempel, Keystone Type Foundry, Lanston Monotype Machine Co., Mergenthaler Linotype Co., Miller Saw-Trimmed Co., Morgan & Wilcox Mfg. Co., H. B. Rouse & Co., Star Tool Manufacturing Co., Wm. H. Sylvester & Son, John Thomson Press Co., Vandercook Press, and Wickersham Quoin Co.

FRANK S. HENRY.

PHILADELPHIA,
APRIL, 1917.



CONTENTS

	PAGE
PREFACE.....	iii
INTRODUCTION.....	xi

CHAPTER I

COMPOSITION—TYPE, SPACES, AND LEADS.....	I
--	---

Lay of the case.—The b, d, q, and p.—Kerned letters.—The point system.—The new and the old system.—Table I.—The em of the body.—The pica em.—Sizes of spaces.—Thickness of spaces.—Table II.—The three-point space of eight-point.—Point-thick spaces.—Point-line.—Point-set.—Legibility.—Leading.—Linotype slugs as spacing material.

CHAPTER II

COMPOSITION—SETTING PLAIN MATTER.....	13
---------------------------------------	----

Making up a stick.—The composing-rule.—Setting type.—Justifying a line.—Uniform spacing.—Rules for spacing.—Emptying the stick.—How to use the galley.—Tying up a job.

CHAPTER III

TAKING A PROOF, CORRECTING THE JOB, AND RETURNING TYPE TO CASE.....	23
---	----

Placing a job on the stone.—Pulling a proof.—Proofs in colors.—Galley-press.—Press-proofs.—The Washington Hand-press.—The Poco Proof-press.—The Potter Proof-press.—The Vandercook Proof-press.—Correcting the job.—Pulling a revise.—Saving cord for future use.—Making up pages.—Cleaning type.—Cleaning rules.—Distributing type.—Putting away leads and furniture.

CHAPTER IV

TYPE CALCULATIONS.....	36
------------------------	----

How much will it make?—What size type shall I use?—Determining the number of ems in composed matter.—Determining the value of composed type.—Table III.—Determining weight of type by measurement.—Determining the amount of leads to a page.

	PAGE
CHAPTER V	
PROOFREADING	44
<p>Requirements for proofreading.—Proofreaders' marks.—Table IV.—Order of procedure in proofreading.—Punctuation.—Marks of punctuation.—Use of the comma.—The dash.—The semicolon.—The colon.—The period.—The hyphen.—The apostrophe.—Quotation marks.—The interrogation mark.—The exclamation mark.—Parentheses.—Brackets.—Division of words.—Compound words.—Capitalization.—Printing-office style.</p>	
CHAPTER VI	
TYPE FACES	73
<p>General classification. — Text. — Gothic. — Roman. — Italic. — Script.—Old-style.—Modern.—The serif.—Old-style and modern serifs.—Other groups.—Cheltenham Oldstyle.—Clearface.—Type families.—“ Pi ” as an aid to type study.—Comparison of serifs.—Swash letters.</p>	
CHAPTER VII	
JOB COMPOSITION	84
<p>General survey of the field.—The layout man.—Fundamental principles.—Optical center.—Balance.—Harmony.—Tone.—Contrast.—Appropriateness.—Grouping.—Mass grouping.—Panel grouping.—Proportion.—Table of proportions.—Table V.—Standardizing proportions.—Borders and ornaments.—Initials.—Shape harmony.—Selecting the salient features of a job.—Improving a job.—Spacing job type.—Letter-spacing.—The square effect.—Selection of rule for a job.—Aligning rule with type.—Side-face or chamfered rule.—Mitered corners.—To obtain perfect joints in tables.—Skeletonizing.—Setting a register job.—Allowing for squeeze.—Concluding hints.</p>	
CHAPTER VIII	
SETTING A JOB	116
<p>The order-blank.—Analysis of copy.—Size type to be used.—Position on the sheet.—Layouts.—Specimens.</p>	

CHAPTER IX

	PAGE
SETTING TABLES AND OTHER INTRICATE MATTER.....	141

Ability required.—Jobs containing rules.—The Typotabular System.—Hand-set ruled blanks.—Wax-engraving.—Monotype method of setting rule work.—Casting off a table.—Three-point spaces of eight-point.—Point-thick spaces.—Line-up of figures.—Setting more than one column in a single measure.—Blank-book headings.—Setting and registering type to horizontal lines.—Running type around cuts.—Setting type in circles.—Algebra, genealogies, and pedigrees.

CHAPTER X

LOCKING UP FORMS.....	163
-----------------------	-----

General principles.—Quoins.—Locking up a form.—Bearers.—Gudgeons.—Locking up register jobs.—Locking-quoins.—Jobs with rules.—Allowance for squeeze.—Troublesome corners.—Squaring the form.—Wooden furniture.—Riding of forms.

CHAPTER XI

IMPOSITION.....	176
-----------------	-----

Placing pages on the imposing-stone.—Hand- and machine-folding.—Margins.—Determining margins.—Determining the lay of a form.—Various parts of a form.—Imposing the form.—Pages out of center.—Making up to the paper.—Lay of forms: the four; the eight; the twelve; the sixteen; the twenty; the twenty-four.—Folders.—Machine-fold.—Signatures.—Insetting.—Press-points.—Other forms.—Proper lay of lengthwise forms.—Folding heavy paper.—Chases.

CHAPTER XII

CUTTING-TOOLS FOR PRINTERS.....	197
---------------------------------	-----

Miller Saw-Trimmer.—The lead-cutter.—Mitering-machines.—The upright machine.—Trimming material.—The burr on rule.—Trimming to gauge.—Cutting to multiples of a point.—Cutting very small pieces of rule.—Type "fitting" on a mitering-machine.—Type-high machines.—Care of machines.

CHAPTER XIII

	PAGE
COMPOSING-MACHINES	209

Economy of machine composition.—The Linotype.—The Monotype.—Mounting illustrations in machine-set composition.—Non-distribution.—The Intertype.—Type-casting machines.

CHAPTER XIV

PRESSWORK	220
-----------------	-----

Platen presses.—The bed.—The platen.—The draw-sheet.—The grippers.—Roller-bearers.—Rollers.—Oiling the press.—Shrinking of furniture.—Impression.—The tympan.—Inserting the form.—Make-ready.—Overlaying.—Guides.—Feeding a press.—Drying the sheets.—Slipsheeting.—Envelopes.—Opening and closing envelopes.—Frisket.—Registering.—Slurring of rule jobs.—Embossing.—Perforating.—Scoring.—Cutting and slitting.—Printing, cutting, scoring, and perforating *in* one operation.—Printing a two-color register job by the aid of a frisket.—Washing up.—Removing hard ink from rollers and press.—Safety devices.

CHAPTER XV

PRINTING-INK	252
--------------------	-----

Composition.—Pigments.—The vehicle.—The drier.—Pressroom temperature and humidity.—Adapting ink to stock.—How to remedy ink troubles.—Dopes.—Mixing ink.—Mixing tints and shades.—Duotone inks.—Halftones.—Three-color process work.—Process inks.

CHAPTER XVI

PAPER	262
-------------	-----

Origin.—The fiber.—Pulp.—The beater.—The refining-engine.—The paper-making machine.—Hand-made paper.—Book papers.—Flat papers.—Sizes of paper.—The ream.—Weights of paper.—Relative weights.—The Lakeside System.—Designating paper according to a substance number.—Table VI.—Envelope sizes.—Table VII.—Figuring and cutting stock.

GLOSSARY	281
----------------	-----

INTRODUCTION

A PRIZE was recently offered by "The Inland Printer" for the best answer to the question, "What is a Printer?" Anyone who has made a study of printing will realize how difficult it is to define the term. Printing, as a process of making impressions in or leaving marks upon a surface, is of great antiquity. There are still extant many clay tablets, waxed surfaces, scratched leaves, engraved wood-blocks, and other devices that serve as guideposts to mark the advance of printing from humble beginnings to the numerous and complex methods of today.

The average layman has but little idea of the immensity of the field of printing and of its importance to modern civilization, including, as it properly does, not only the printed word, and the illustrations that are the necessary adjuncts, but also the textile field—the printing of cloth for garments, of floor coverings, wall-paper, tapestries, etc. The average typographic printer also has but a faint conception of the numerous ways in which his texts are illustrated.

In general, there are three fundamental principles involved in printing: from raised surfaces (letterpress), from plane surfaces (lithographic), and from sunken or engraved surfaces (intaglio). Taking them in the inverse order, intaglio printing embraces steelplate, copperplate, and photogravure; lithographic printing covers all those processes based on the selective properties of a prepared surface for greasy ink and water, and includes lithography, zincography, and collotype; letterpress is the printing done from raised surfaces, such as type, halftone plates, zinc-etchings, woodcuts, etc.

Each of these methods has its own special sphere, but there are numerous points of contact. Letterpress is by far the most important; and the most important branch of letterpress is typography. This treatise is devoted to typographic printing, but, as stated in the preface, it makes no pretense of fully covering the subject. The student of typography is urged to acquire at least a smattering of the various other ways in which things are printed. He will certainly have a broader and better conception of his own branch of the work. He should also have a general knowledge of all the trades allied to his own, such as typefounding, electrotyping, paper-making, etc. Teachers of printing should take their students on shop visits, and see that they get first-hand information on these topics.

To the uninitiated, the setting of type seems the simplest of mechanical operations. Apparently, all that is necessary is for one to know the lay of the case; the operation of placing the type in the stick is assumed to be so simple that even a child should do it. If this were all there is to typesetting, there would be no need for schools of printing. The student soon learns, however, that he must possess considerable special knowledge and skill before he can be considered a good compositor.

The boy who makes the greatest strides in printing is he who has attained at least the eighth grade in public school, and has a fair knowledge of punctuation, capitalization, spelling, and the division of words. If he is to be a job compositor he should have a predilection toward art. He should possess mechanical ability. Above all, he should be studious, for he will find that if he is to advance in his chosen field he must be continually studying to keep pace with progress.

A boy who does not possess these requisites had better not undertake the work. There are entirely too many men of mediocre ability in the business now, much to the annoyance of employers. It is to be regretted that such men do not strive to improve their earning capacity by judicious study. There is constant demand for men of ability.

The student who takes up printing as his life's work is strongly urged to make a study of every branch of the craft. He will find much valuable material in the various books on printing to be found in the public libraries. He is especially urged to consult the current numbers of the various magazines devoted to printing and make a special study of the reset specimens, and also follow the department in "The Inland Printer" devoted to apprentices. He should also gather together those pieces of printed matter that impress him as being either very good or very bad, and take up with his instructor the question why they appear good or bad. Much useful information may be acquired in this way.

The instructor should show samples of good and bad printing and tell why they are good or bad.

Layout work should be a strong feature of the course of instruction, as it offers the instructor endless opportunity to criticise, and point the right road. It also affords the student excellent practice.

As an aid to the study of type faces, the student should carefully read the specimen-books issued by the various type-founders. He should also take up hand-lettering, and make a study of historic ornament.



PRINTING

CHAPTER I

COMPOSITION—TYPE, SPACES, AND LEADS

1. Lay of the Case.—Owing to the general use of type-setting machines, very little plain or straight matter is now set by hand. For this reason the pair of cases, formerly very much in vogue, is now seldom used. Nearly all job type is kept in dust-proof cabinets (Fig. 1), and the **California job case** is rapidly supplanting other forms. In Fig. 2 is shown the lay of the two styles of cases. The arrangement of the capitals and of the lower-case letters is the same for all styles of cases. A study of the figure shows that the lower-case letters most frequently used are grouped about the center of the case. The capitals run alphabetically, with the exception of the J and the U.

The quickest way for a student to familiarize himself with the lay of the case is to draw a diagram of it and locate on the diagram all letters in their proper places. A printed diagram carried in the pocket and studied at odd moments, is also a splendid aid. Setting the following sentence, which contains every one of the letters of the alphabet, will give practice in locating the boxes:

“The quick brown fox jumps over the lazy dog.”

2. The b, d, q, and p.—Inasmuch as type is cast in reverse, students have trouble at first in reading type and in distin-

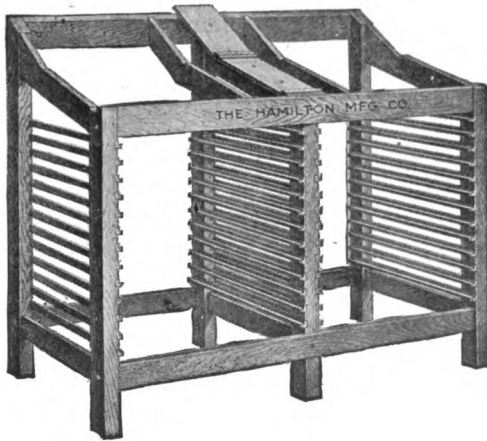

Old Style of Composing-frame.

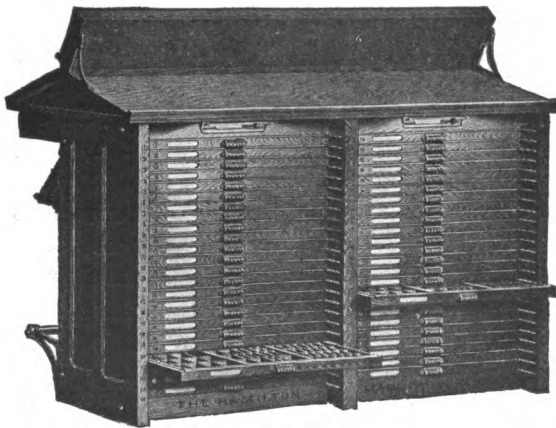

New Style of Composing-cabinet.

FIG. 1.

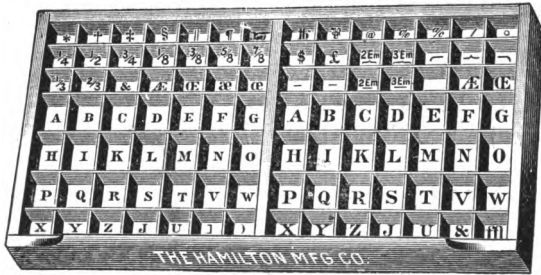

Upper Case.

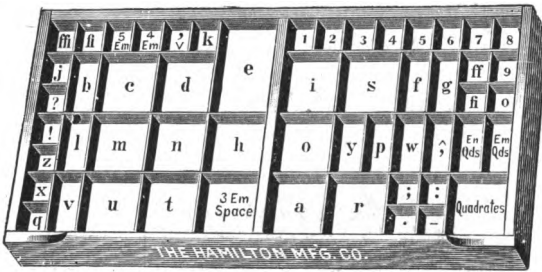

Lower Case.
A PAIR OF CASES.

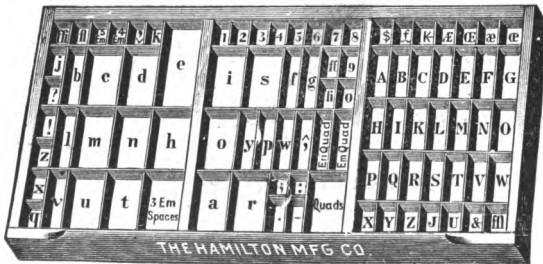

California Job Case.

FIG. 2.—Showing Lay of Cases.

guishing certain lower-case letters. In reading type, the stick should not be turned upside down, but should be held just as in setting type. To distinguish between the b and d, and the p and q, observe that the round parts of the b and d face each other when held over their respective boxes, and that the round parts of the q and p face the opposite way, or toward their respective boxes.

3. Kerned Letters.—When a letter is cast in such position that the face projects over the side of the body, it is said to be *kerned*. The lower-case f and j are both kerned. With some faces of type, if we were to place an i, l, or f beside the f, the projecting part of the letter would very likely be broken off. To prevent this, such combinations of letters are cast on one body, and these are known to printers as *logotypes*. The correct name for them, however, is *ligatures*. We have the following combinations: fi, fl, ff, ffi, and ffl. Some roman letters are cast without kerns. Nearly all italic fonts have some kerned letters. The characters *ct* and *st*, found in some fonts, are ligatures.

4. The Point System.—Some time prior to the year 1450 Gutenberg invented the casting of metal type in molds. As the art of printing advanced, many new sizes were cast, but no attempt was made to cast them with a uniform gradation in size, and it was difficult to build up one size of body to equal another; that is, *justify* them.

To obviate this, Fournier, in 1737, advocated a method of casting type according to some unit. The size known as *pica* was in use in various countries in Europe, and was considered a standard size. Taking the pica as a base he divided it into twelve equal parts, each of which he called a *point*. He chose one-twelfth of a pica as the unit because there existed five sizes of type between pica and nonpareil. As *nonpareil* was just half the size of pica, this made the succession of sizes seven, eight, nine, ten, and eleven point, any one of which could be justified with another by the use of material made to the same unit.

This plan of Fournier's was an excellent one, but it involved so much expense in the changing of type molds that typefounders hesitated to adopt it. In the year 1878 the foundry of Marder, Luse & Co., of Chicago, was destroyed by fire. When it was rebuilt the firm changed over to the point system. This was the beginning of the point system in America. The United States Typefounders' Association finally adopted it in 1887. It is the only system in use in first-class offices today.

While pica has always been considered a *standard* size, it has never been of a *uniform* size. It has varied in different countries, and even among typefounders in the same country. Tests of pica sizes have demonstrated that they varied from $70\frac{1}{2}$ to 75 picas to the English foot of twelve inches. The American pica runs about three points over 72 lines to the foot. Its actual measurement is 0.16608 of an inch. One-twelfth of this, or one point, is, therefore, 0.01384 of an inch.

It is popularly supposed that six picas equal one inch. This is approximately so, but not absolutely, for six picas measure but .99648 of an inch.

Fig. 3 shows the increase in thickness, by points, from one to twelve.

1 point = 0.01384 inch.

1 pica = 0.16608 inch.

FIG. 3.—Showing Increase in Thickness, by Points, from One to Twelve.

5. The New and the Old System.—In Table I is given the name of each type size under the old system of nomenclature and the size nearest to it under the Point System. Nonpareil, brevier, and pica, and their multiples, are the only ones that remained the same size under the new system.

TABLE I.—TYPE SYSTEMS

Size. New System.	Name, Old System.	Size. New System.	Name, Old System.
3 -point	Excelsior	18-point—3-line	Nonpareil, or Great Primer
3½-point	Brilliant*	20-point—2-line	Long Primer, or Paragon
4 -point	Semi-Brevier	22-point—2-line	Small Pica
4½-point	Diamond	24-point—2-line	Pica
5 -point	Pearl	28-point—2-line	English
5½-point	Agate	30-point—5-line	Nonpareil
6 -point	Nonpareil	36-point—3-line	Pica, or Double Great Primer
7 -point	Minion	42-point—7-line	Nonpareil
8 -point	Brevier	48-point—4-line	Pica, or Canon
9 -point	Bourgeois	54-point—9-line	Nonpareil
10 -point	Long Primer	60-point—5-line	Pica
11 -point	Small Pica	72-point—6-line	Pica
12 -point	Pica		
14 -point—2-line	Minion, or English		
16 -point—2-line	Brevier, or Columbian		

6. The Em of the Body.—When calculating the amount of type contained in any piece of composed matter, it is measured up in *ems*, and this em, or unit, is the *em of the body*. The square of each size of type is called the em of that body. Thus, the em of six-point is six points square; the em of eight-point is eight points square; and so on. In Fig. 4 is shown the actual size of the em in the various points.



FIG. 4.—Actual Sizes of the Em.

7. The Pica Em.—The size known as pica had been in use in various European countries for many years prior to the inven-

* There seems to be a diversity of opinion regarding the point size of Brilliant. De Vinne gives it as 4-point. Brilliant actually measured about $3\frac{5}{8}$ points. When the MacKellar, Smiths & Jordan Company adopted the Point System they cast Brilliant on a $3\frac{1}{2}$ -point body. Four-point they called Semi-Brevier.

tion of the point system, and its size varied slightly in different countries. It has, however, always been considered the unit of length.

In order to facilitate the work in a composing-room, leads, slugs, rules, and furniture are used in standard lengths. These lengths are designated in ems, and the em is the *pica em*. Thus, when a lead twenty-four ems long is spoken of, twenty-four pica ems is meant. If furniture is spoken of as four by twenty, what is meant is that its width is equal to four pica ems, and its length is equal to twenty pica ems.

If a pica-gauge is not at hand when measuring material, we may approximate its size by measuring it in inches, and assuming that there are six picas to an inch.

It is very essential for the apprentice to remember that all accessory material in a printing-office is graduated in pica ems.

When material is either cast or cut to even multiples of pica it is called *labor-saving*, and should never be cut or altered in any manner.

8. Sizes of Spaces.—The spacing material that usually accompanies a font of type consists of one-, two-, and three-em quads, an en quad, three-, four-, and five-em spaces, and a hair-space. The *em quad* is the square of the body of the type: that is, it is just as wide as it is thick. The *two-* and *three-em quads* are respectively two and three times as wide as they are thick. An *en quad* is one-half of an em, a *three-em space* (frequently called a *thick-space*) is one-third of an em, a *four-em space* is one-fourth of an em, and a *five-em space* is one-fifth of an em in thickness. The *hair-space* varies in the number to an em. It is approximately one point thick for the smaller sizes of type and two points thick for the larger sizes. In ten-point it is one-ninth of an em. Fig. 5 shows the different sizes of quads and spaces of ten-point type.



FIG. 5.—Quads and Spaces of Ten-point Type.

9. **Thickness of Spaces.**—Table II shows the actual thickness of all the various spaces and combinations of spaces, in sizes from twelve-point to six-point. Beginning with a five-em space and running down a column, we find that certain combinations show a gradual increase in thickness. It is by combining spaces of different thicknesses that the space between words is increased or decreased. It is, therefore, important that the student memorize the first five combinations, as they are continually being used when justifying lines.

TABLE II.—THICKNESS OF SPACES

Fractions of an em.	Combination of Spaces.	12-pt.	11-pt.	10-pt.	9-pt.	8-pt.	7-pt.	6-pt.	Variation between Sizes.
$\frac{1}{5}$	5	$2\frac{2}{5}$	$2\frac{1}{5}$	2	$1\frac{4}{5}$	$1\frac{3}{5}$	$1\frac{2}{5}$	$1\frac{1}{5}$	$\frac{1}{5}$
$\frac{1}{4}$	4	3	$2\frac{3}{4}$	$2\frac{1}{2}$	$2\frac{1}{4}$	2	$1\frac{3}{4}$	$1\frac{1}{2}$	$\frac{1}{4}$
$\frac{1}{3}$	3	4	$3\frac{2}{3}$	$3\frac{1}{3}$	3	$2\frac{2}{3}$	$2\frac{1}{3}$	2	$\frac{1}{3}$
$\frac{2}{5}$	5, 5	$4\frac{4}{5}$	$4\frac{3}{5}$	4	$3\frac{4}{5}$	$3\frac{3}{5}$	$2\frac{4}{5}$	$2\frac{3}{5}$	$\frac{2}{5}$
$\frac{1}{2} + \frac{1}{4}$	5, 4	$5\frac{3}{4}$	$4\frac{11}{10}$	$4\frac{1}{2}$	$4\frac{1}{4}$	$3\frac{3}{4}$	$3\frac{2}{4}$	$2\frac{1}{2}$	$\frac{3}{10}$
$\frac{1}{2}$	en (4, 4)	6	$5\frac{1}{2}$	5	$4\frac{1}{2}$	4	$3\frac{1}{2}$	3	$\frac{1}{2}$
$\frac{1}{2} + \frac{1}{3}$	5, 3	$6\frac{2}{3}$	$5\frac{11}{6}$	$5\frac{1}{3}$	$4\frac{2}{3}$	$4\frac{1}{6}$	$3\frac{1}{3}$	$3\frac{1}{3}$	$\frac{1}{6}$
$\frac{1}{4} + \frac{1}{3}$	4, 3	7	$6\frac{1}{2}$	$5\frac{5}{6}$	$5\frac{1}{4}$	$4\frac{2}{3}$	$4\frac{1}{2}$	$3\frac{1}{2}$	$\frac{1}{12}$
$\frac{2}{3}$	5, 5, 5	$7\frac{1}{3}$	$6\frac{2}{3}$	6	$5\frac{2}{3}$	$4\frac{2}{3}$	$4\frac{1}{3}$	$3\frac{2}{3}$	$\frac{2}{3}$
$\frac{2}{5} + \frac{1}{4}$	5, 5, 4	$7\frac{4}{5}$	$7\frac{3}{10}$	$6\frac{1}{2}$	$5\frac{1}{2}$	$4\frac{1}{2}$	$4\frac{1}{2}$	$3\frac{1}{2}$	$\frac{1}{10}$
$\frac{2}{3}$	3, 3	8	$7\frac{1}{3}$	$6\frac{2}{3}$	6	$5\frac{1}{3}$	$4\frac{2}{3}$	4	$\frac{2}{3}$
$\frac{1}{2} + \frac{1}{5}$	en, 5	$8\frac{2}{5}$	$7\frac{7}{10}$	7	$6\frac{3}{10}$	$5\frac{3}{5}$	$4\frac{4}{10}$	$4\frac{1}{5}$	$\frac{1}{10}$
$\frac{1}{3} + \frac{2}{5}$	3, 5, 5	$8\frac{4}{5}$	$8\frac{1}{15}$	$7\frac{1}{3}$	$6\frac{2}{3}$	$5\frac{1}{3}$	$5\frac{1}{5}$	$4\frac{4}{5}$	$\frac{1}{15}$
$\frac{1}{2} + \frac{1}{4}$	en, 4	9	$8\frac{1}{4}$	$7\frac{1}{2}$	$6\frac{3}{4}$	6	$5\frac{1}{4}$	$4\frac{1}{2}$	$\frac{1}{4}$
$\frac{1}{3} + \frac{1}{4} + \frac{1}{5}$	3, 4, 5	$9\frac{2}{15}$	$8\frac{7}{10}$	$7\frac{5}{6}$	$7\frac{1}{10}$	$6\frac{1}{5}$	$5\frac{2}{5}$	$4\frac{1}{10}$	$\frac{1}{30}$
$\frac{1}{5}$	5, 5, 5, 5	$9\frac{4}{5}$	$8\frac{4}{5}$	8	$7\frac{4}{5}$	$6\frac{4}{5}$	$5\frac{4}{5}$	$4\frac{4}{5}$	$\frac{4}{5}$
$\frac{1}{2} + \frac{1}{3}$	en, 3	10	$9\frac{1}{2}$	$8\frac{1}{2}$	$7\frac{1}{2}$	$6\frac{2}{3}$	$5\frac{2}{3}$	5	$\frac{1}{3}$
$\frac{2}{5} + \frac{1}{4}$	5, 5, 5, 4	$10\frac{1}{5}$	$9\frac{7}{10}$	$8\frac{1}{2}$	$7\frac{3}{10}$	$6\frac{2}{5}$	$5\frac{2}{5}$	$5\frac{1}{10}$	$\frac{1}{10}$
$\frac{2}{3} + \frac{1}{5}$	3, 3, 5	$10\frac{2}{3}$	$9\frac{8}{15}$	$8\frac{2}{3}$	$7\frac{4}{5}$	$6\frac{1}{5}$	$6\frac{1}{5}$	$5\frac{1}{3}$	$\frac{1}{15}$
$\frac{1}{2} + \frac{2}{5}$	en, 5, 5	$10\frac{4}{5}$	$9\frac{9}{10}$	9	$8\frac{1}{10}$	$7\frac{1}{5}$	$6\frac{3}{10}$	$5\frac{2}{5}$	$\frac{1}{10}$
$\frac{2}{5} + \frac{1}{4}$	3, 3, 4	11	$10\frac{1}{2}$	$9\frac{1}{2}$	$8\frac{1}{4}$	$7\frac{1}{3}$	$6\frac{5}{12}$	$5\frac{1}{2}$	$\frac{1}{12}$
$\frac{2}{3} + \frac{1}{3}$	5, 5, 5, 3	$11\frac{1}{3}$	$10\frac{2}{3}$	$9\frac{1}{3}$	$8\frac{2}{3}$	$7\frac{2}{3}$	$6\frac{1}{3}$	$5\frac{2}{3}$	$\frac{1}{3}$
$\frac{1}{2} + \frac{1}{5} + \frac{1}{4}$	en, 5, 4	$11\frac{2}{5}$	$10\frac{9}{10}$	$9\frac{1}{2}$	$8\frac{1}{2}$	$7\frac{3}{5}$	$6\frac{2}{5}$	$5\frac{7}{10}$	$\frac{1}{10}$
$\frac{1}{3} + \frac{1}{4} + \frac{2}{5}$	3, 4, 5, 5	$11\frac{4}{5}$	$10\frac{4}{5}$	$9\frac{4}{5}$	$8\frac{1}{2}$	$7\frac{1}{3}$	$6\frac{2}{3}$	$5\frac{8}{10}$	$\frac{2}{10}$
em	em	12	11	10	9	8	7	6	1

10. The Three-point Space of Eight-point.—By reference to Table II it will be seen that the en quad of eight-point is four points thick and the four-em space two points thick. Typefounders are now casting an eight-point space that is three points thick. This size is midway between the en quad and the four-em space. It is extremely useful in tabular matter, as all columns can be made up to multiples of points. In columns of pica widths the lines become self-justifying; *i.e.*, always take a certain number of figures and certain even spaces to fill the line. For example, suppose a table with columns two picas wide, four figures in each column. An en quad each side of the figures will just fill the measure. If there are six figures in a column and the column is three picas wide, twelve points will be required to fill the measure. Four three-point spaces, two on each side of the figures, will make up the required twelve points. If the measure is two and one-half picas wide, one three-point space on each side of the six figures will justify the line.

11. Point-thick Spaces.—A survey of Table II also reveals the fact that certain spaces are exact multiples of points in thickness. That is, some are one point thick, some two points, some three points, etc. These spaces can frequently be used when justifying one size of type with another. Fig. 6 illustrates the method.

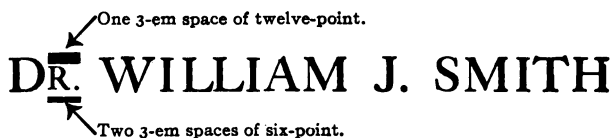

FIG. 6.—Showing Method of Justifying Type by the Use of Point-thick Spaces.

12. Point-line.—Before the advent of the point system, type sizes were not even multiples of each other. If it was desired to justify one size of type with another it was sometimes necessary to use cardboard or thick paper as well as leads.

Nowadays, all sizes are multiples of each other, and can readily be justified by the use of materials based on points. Moreover, the face of type is cast in such position on the body that it can be lined up by the use of material based on points. This is known as *point-line*.

13. Point-set.—One typefoundry made the experiment of casting type so that each letter or character was some multiple of a point, the idea being that after the line was composed a certain number of points in thickness would be necessary to fill the line. The spaces were cast in multiples of points so as to readily fill the line. This plan was an excellent one so long as the type was new, but just as soon as the type got dirty the lines were no longer self-justifying. The Monotype System is based on a unit system, but it is a perfect success because the composed type is always new.

14. Legibility.—One of the essential things in printed matter is that it be legible. This requires that the space between words be modified to suit certain conditions. Widely leaded matter requires more space between words than solid matter. When matter is opened up between lines by the insertion of strips of metal, called *leads*, it is said to be *leaded*. When the leads are omitted the matter is said to be *solid*.

If straight matter, either solid or single-leaded, is being set, three-em spaces should be put between words; if the matter is double-leaded, en quads should be used between words. To have much space between lines and very little between words makes the line look like a streak across the page. When setting display lines, or lines that stand alone, the space between words should be governed by the width of the type face. Extended type requires wider spacing than condensed type. Lines in capitals require wider spacing than those in lower-case. In fact, every line should be spaced with the idea of rendering it legible.

15. Leading.—When setting leaded matter always put the leads in while setting. If the matter is being set in a wide measure and there are no leads wide enough for the purpose, it

becomes necessary to double-up leads—that is, to use two pieces that will just fill the measure. In doing this do not use pieces of equal length; if this is done, the halves of the job may slide on one another. The proper way is to use a long and a short piece, alternating them in the stick as in Fig. 7.

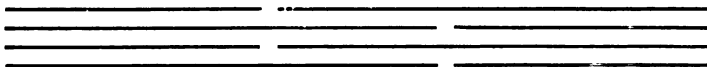

FIG. 7.—The Proper Way to Double-up Leads.

If compelled to double-up leads, do not take from the lead-rack all the leads there are of any one size. Remember that various combinations of sizes will equal the length that you need. Do not rob the lead-rack; you may need the material on your next job.

16. Linotype Slugs as Spacing Material.—If linotype slugs are used as spacing material, be careful not to place the side with the ribs on against the type, or the type will be loose and drop out.

QUESTIONS ON CHAPTER I

1. Why are lower-case letters scattered about the case instead of being placed in alphabetical order?
2. Name a sentence containing every letter in the English alphabet.
3. How can you differentiate between *b* and *d*, and between *p* and *q*?
4. What is a ligature? Why is it necessary to have them?
5. What is a kerned letter?
6. What is the Point System?
7. Who invented the Point System?
8. How many years elapsed before the Point System was finally adopted?
9. What decimal part of an inch is one point?
10. How many picas to one inch (approximately)?
11. How many picas to one foot (approximately)?
12. Name the type sizes under the old system that correspond with the point sizes of the new system, beginning with 5-point and ending with 12-point.
13. What is an em quad?

14. How do we measure composed type ?
15. What size em is used as a unit for measurement of length ?
16. What is labor-saving material ?
17. Name the different sizes of spaces that accompany the average font of type.
18. What is a thick-space ?
19. How many sizes of quads accompany a font of 12-point type ?
20. Figure out the actual thickness, in points, of the following spaces: a three-em space of 12-point; two five-em spaces of 10-point; an en quad of 8-point; two three-em spaces of 6-point.
21. Which is the thicker, an en quad and a three-em space of 12-point or an en quad and two five-em spaces of 10-point ?
22. If you needed an en quad of the size of type you were setting, and there was none in the case, what combination of spaces would you substitute ?
23. Explain the advantages of having an 8-point three-point space instead of the ordinary thick-space.
24. What do you understand by "point-line" ?
25. Explain "point-set."
26. Explain "legibility" as applied to composed type, and tell what we should do to conserve it.
27. Explain "leaded matter" and "solid matter."
28. How should leads be placed when doubling-up ?

CHAPTER II

COMPOSITION—SETTING PLAIN MATTER

17. Making up a Stick.—Having learned the lay of the case and the fundamental principles of spacing and leading, the student is now prepared to take up the actual setting of type. The first step is to set the stick to a measure. This is technically known as *making up a stick*.

Several different kinds of composing-sticks are illustrated in Fig. 8. If one of the graduated kinds is used, it is simply

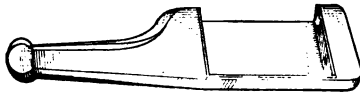

The first composing-sticks were one-measure, and made of wood. The illustration shows a stick about four hundred years old, now in the Typographic Library and Museum in Jersey City.

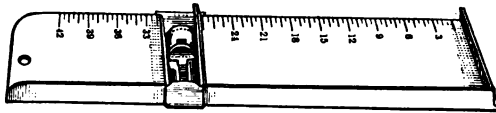

Star.

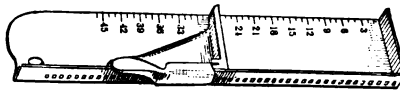

Rouse.



Yankee.

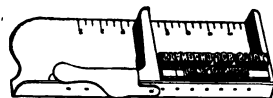

Standard.

FIG. 8.—Composing-sticks.

necessary to set the measure desired to the size indicated on the stick and clamp the knee in position. If the stick be one of the older forms, and not graduated, it is necessary to make it up to some absolute unit. Students are prone to pick up leads, rules, furniture, or whatever may be at hand, and use them as units of length for making up the stick. This is a very un-

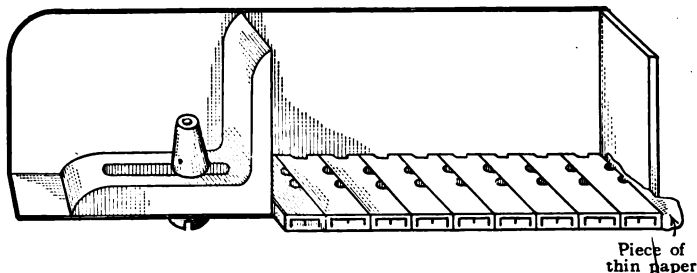

FIG. 9.—Proper Method of Making up a Non-graduated Composing-stick.

certain method, and should not be allowed. The best method is to use capital letters of some twenty-four-point or thirty-six-point type, placing them bodywise in the stick (see Fig. 9), and inserting a piece of *thin* paper at the end of the line so that if leads are used they will not bind.

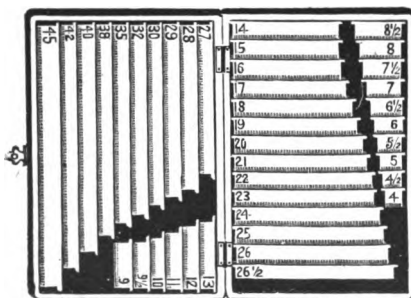

FIG. 10.—A Set of Composing-rules.

18. The Composing-rule.—As it is almost impossible to set one line of type on top of another in a composing-stick, com-

positors provide themselves with *composing-rules*, shown in Fig. 10. These may be purchased in sets, varying in length from four to forty-five picas. They are provided with little ears at each end so as to be readily lifted out of the stick after each line is set.

Equally efficient ones may be made from odds and ends of discarded brass rule by cutting and filing to the forms shown in Fig. 11.

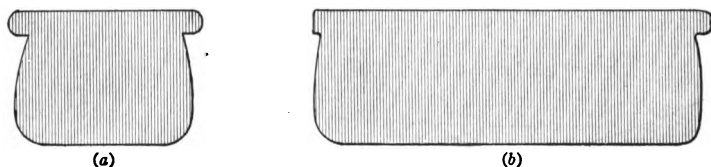

FIG. 11.—Composing-rules Made from Brass Rule.

The form shown at (b) is more easily removed from the stick, but cannot be used in sizes much below nine ems of pica.

19. Setting Type.—With the copy on the stand before him, and with his stick and rule in hand, the student should read his copy carefully, noting particularly the capitalization, spelling, and punctuation. Read a few words at a time, and set up the letters in proper order, beginning at the left-hand side of the stick. Type is to be set nick up in the stick. When setting type look at the letter as it lies in the case, noting the position of the nick, and in picking it up turn it so that it comes nick up in the stick. *Do not look at the letter after you have picked it up*, but look for the nick of the next letter while you are placing the first one in the stick. Cultivate this habit from the start, for on it depends your future speed as a typesetter. No attention need be paid to placing spaces and quads nick up. Some spaces are cast without nicks.

In order to keep the line under perfect control while being composed, the thumb of the left hand is always held against the last letter of the line (Fig. 12), the end of the thumb being slightly raised as each letter is put into the stick. If the type

is being set solid or single-leaded, use a 3-em space between the words. Continue setting until you have placed in the line all the words possible. If the final word on the line cannot be gotten in, and it is a word of more than one syllable, it may be divided. If the line does not exactly fill the measure, it is necessary to increase the spacing between words until the line is tight enough to stand alone when pushed up from the bottom of the stick. This is called *justifying* the line. Before doing this, however, the line should be read for errors, and any found corrected. At the same time the thumb should be passed a few

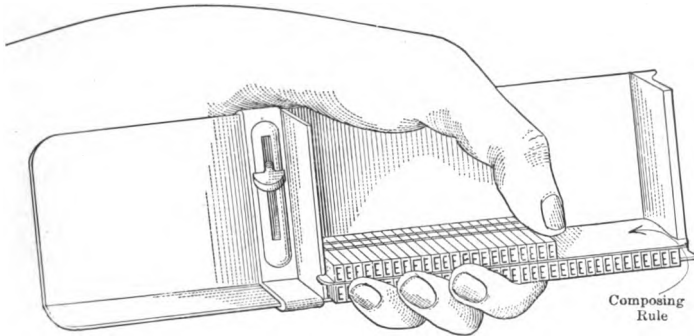

FIG. 12.—Correct Way of Holding Composing-stick in the Hand While Setting Type.

times across the body of the type to ascertain if type of a larger or smaller size has been placed in the line.

20. Justifying a Line.—After all corrections are made, the line should be spaced to fill the measure. Every line must be accurately spaced. If one line is longer than the rest, it will bear off the furniture used in locking up the form, and the type will be loose, in which event it will drop out, or, worse still, will pull out on the press and cause some damage. *Accurate and uniform spacing is absolutely essential.* When justifying, the expert compositor notes how much space is required to fill the line, and, from experience, knows how much to put between .

words. The student can acquire the same skill by measuring how much the line is short, then counting the number of places requiring spaces, and putting in enough to fill the line. For example, suppose that a line is short—apparently two ems. We measure the space with a two-em quad and find that it just fills the line. We then count the number of places between words and find that we have ten places. The ten spaces must be increased by a total amount equal to a two-em quad. A five-em space is one-fifth of an em. Ten five-em spaces equal two ems. Therefore one five-em space added to each space in the line will just fill the measure. Again, suppose that the line only lacks one-half or one-third of an em of being full. In this event, we must find some combination of thin spaces that we may substitute for the three-em spaces ordinarily used between words. We look along the line and note where the combination of two tall, straight letters come together in the line. This is where we should always begin to increase the spacing in the line.

21. Uniform Spacing.—If a line has spaces of uniform thickness between words, it will not appear to be uniformly spaced. If it contains words beginning or ending in tall, straight letters, there will appear to be less space between them than between rounded letters like o, c, and e, or after sloping letters like v, y, w, or a comma. It should always be our object to make the line *appear* uniformly spaced. To accomplish this we should, if possible, have a little more space between the high letters than at other places. The rule, therefore, is: "*If necessary to increase spacing to fill a line, do so by increasing the space alongside of straight letters; if necessary to decrease the space to get a word in a line, decrease the space after sloping letters or between rounded letters.*" Of course, if necessary to increase or decrease at every place throughout the line, we must do so, but in doing so we must endeavor to have the spacing appear uniform.

22. Rules for Spacing.—We should endeavor at all times to have enough words in the last line of a paragraph to more than cover the indentation of the next paragraph. If the last line of a

paragraph lacks one em of being full, space the line to full length. Never have less than one em as a blank or quad line at the end of a paragraph. If the last line of a paragraph is short one em or more, do not space it out to full length; the paragraph will be more distinct if the line is short. However, do not sacrifice the appearance of the spacing in order to make a line shorter. If possible, have the space between words in the last line of a paragraph the same as in the line preceding it.

When spacing a line endeavor to have equal space each side of small words.

Put a thin space (usually a five-em space) before a colon, a semicolon, an interrogation mark, and an exclamation mark. Place an en quad after these marks if they occur in a sentence. If the interrogation mark or the exclamation mark ends a sentence, place an em quad after it.

In all lines of type that contain quads and spaces, place the spaces alongside of the type, where they may readily be found. Scattering spaces among the quads in a line is a fruitful source of dirty quad-boxes.

While spacing is an extremely important matter, and may make or mar the printed page, it is inadvisable to leave out marks of punctuation or to make improper divisions of words to obtain uniform spacing.

23. Emptying the Stick.—Continue setting until the stick is nearly filled with type. Place the composing-rule between the bottom of the matter and the stick, and have a lead or two at the top, so as to obtain a firm grip on the matter. Place the stick on the case or on a galley and remove the type with a rolling motion. Fig. 13 illustrates this better than words can describe it. Care must be taken to place the balls of the thumbs, and not the tips, at the top of the type or the matter will crumple up and go to “pi.” As the matter is withdrawn from the bottom of the stick, gradually slide the balls of the thumbs down on the type, thus obtaining a firmer hold, at the same time placing the middle finger of each hand firmly against the ends of the matter. *Do not unfasten the stick to remove the lines.*

24. How to Use the Galley.—Having removed the type from the stick, place it on the galley as shown in Fig. 14. Never

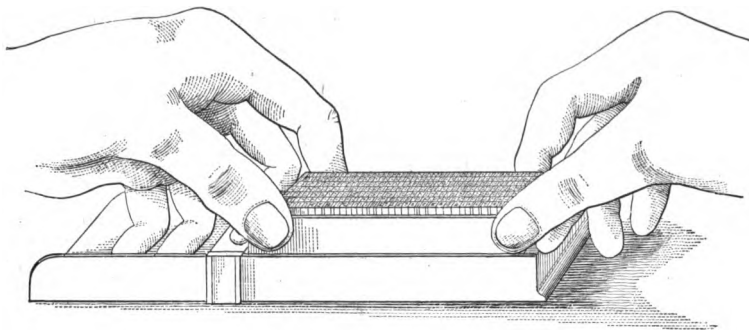

FIG. 13.—Emptying a Stickful of Type.

place it on a galley in any other way. Always stand as shown in Fig. 15 when correcting or making up a job.

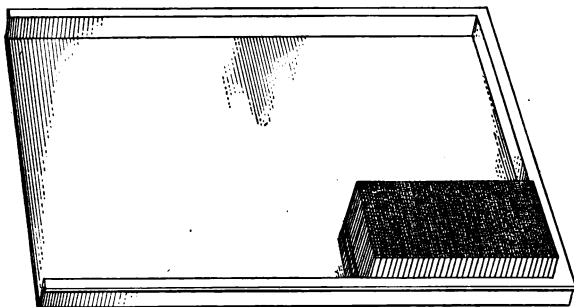

FIG. 14.—Proper Way to Place a Job on a Galley.

25. Tying up a Job.—When the type is set and placed on the galley, the next step is to tie up the job. The very best cord for this purpose is that known to the twine trade as Seine No. 12. When tying up a job, begin at the upper left-hand corner, and, holding about one-half inch of the cord between the thumb and index-finger of the left hand, pass the cord once

around the job and cross the cord over the first layer as in Fig. 16 (a). This will hold it fast to the corner. Wind on two or

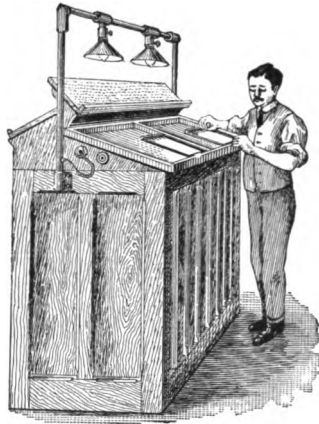

FIG. 15.—Correct Way to Work at the Composing-stand.

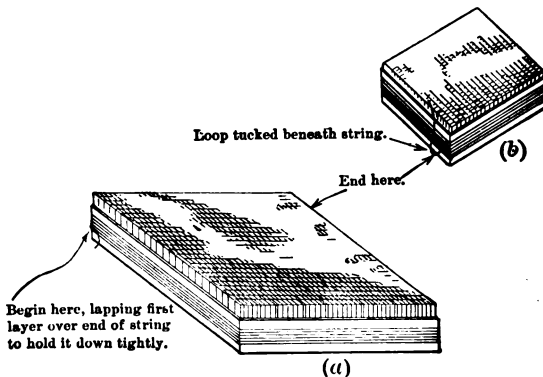

FIG. 16.—Showing How a Job Should Be Tied Up.

three layers, then move the job away from the corner of the galley and push the string down on the type. Do this carefully. Continue winding until five or six layers have been put

on. If the cord is of sufficient length, finish the winding at the upper right-hand corner, and tuck it in, as shown in Fig. 16 (b). Keep a firm hold on the job while tying it up, and be sure that the cord is taut at all times. Do not cross one layer of cord

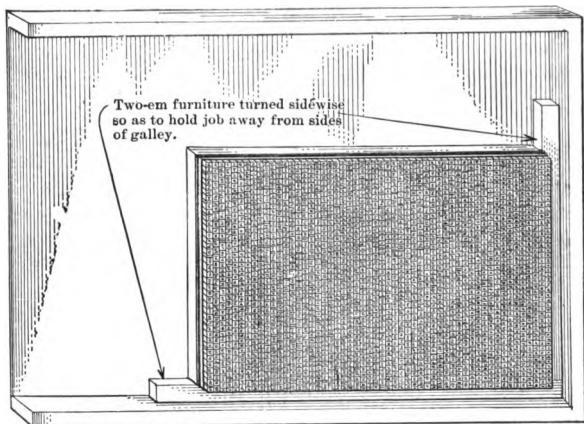

FIG. 17.—Showing How a Bulky Job Should Be Handled.

over the other, as it will catch under the other layers when being removed and very likely put the job "off its feet."

If the job is too bulky to be pushed away from the corner of the galley while being tied, it should be arranged as shown in Fig. 17, using two-em furniture turned sidewise.

QUESTIONS ON CHAPTER II

1. What is a composing-stick? How should it be held in the hand?
2. How should a composing-stick be set to measure?
3. What is a composing-rule? Why is it necessary to use one?
4. What is the purpose of having a "nick" on one side of a type?
5. How should type be placed in the stick?
6. What special habit should you cultivate as an aid to rapid typesetting?
7. What name is given to the act of spacing a line to full length?
8. What method have you for determining when a line is accurately set to the measure?

9. What trouble is apt to be caused if one line is longer than its neighbors ?

10. What method have you for determining how much additional space to put between words when you are justifying a line ?

11. If you were setting double-leaded or triple-leaded matter would you use a single thick-space between words ? Give reasons for your answer.

12. Should words that stand alone on a page have more or less space between them than when run in with other matter ?

13. Why is accurate spacing more desirable than uniform spacing ?

14. Why is accurate justification so essential ?

15. How should a stick be emptied ?

16. Describe how you would proceed to tie up a medium-size page. If the page were a large one how would you proceed ?

CHAPTER III

TAKING A PROOF, CORRECTING THE JOB, AND RETURNING TYPE TO CASE

26. Placing a Job on the Stone.—It is obvious that if any grit should get beneath the type it will cause it to punch through the paper when pulling a proof. Every effort should be made to prevent such an occurrence. Before sliding the type from the galley to the stone, be sure that the stone is clean.

27. Pulling a Proof.—Before pulling a proof, the job should be made level by the use of the *form-planer* (Fig. 18), which is placed on the job and given a few light taps with a mallet. Ink the job with a hand-roller or brayer, being careful not to have too much ink on the roller. Then take a sheet of proof-paper,* hold it at diametrically opposite corners, allowing it to sag slightly in the middle, and place it carefully on the job. Do this by allowing the middle to touch the form first, gradually lowering the corners. Do not let the paper slip or drag over the form, or the sheet will be smeared. Now take the *proof-planer* (which is the same as a form-planer, but with the face covered with felt) in the left hand, place it *steadily* and *firmly*, face down, on the paper, and strike it a fairly sharp tap with the mallet. Raise the proof-planer slowly and with a tilting motion, and move it to a new position. Go over the job in this way until every part has been impressed on the paper. Whether or not the proof is likely to be a good one can be judged from the impression in the paper. If it appears weak at any point, go over that part again. Remove the sheet by raising it at opposite corners.

* A paper known as French Folio is frequently used, though the author prefers "Dry Proof Paper." The latter has a glossy side that is especially adapted for the work.

The secret of obtaining a good beaten proof is in the manner of placing the proof-planer on the form, and in removing it. If the planer slides, slips, or jumps when it is struck, it is apt to move the paper and spoil the proof. Hold it down firmly. If it is raised suddenly to move it to a new position, it will create a suction and raise the paper from the type, thus spoiling the proof. Tilting the planer when raising it helps to avoid this.

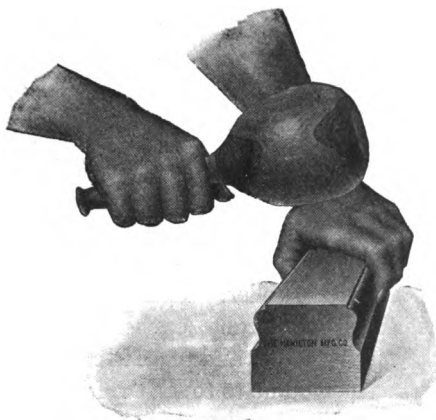

FIG. 18.—Method of Holding and Tapping a Form-planer.

28. Proofs in Colors.—If a proof of a job is required to be submitted in colors, such proof may be secured with comparative ease provided there is no overlapping of the colors. Suppose, for example, that a proof is to be pulled in two colors—the main body of the job in black with a few touches of red. Ink the whole job with black ink. With a clean rag wipe off the black ink from those parts that are to be in red and, with the aid of a small piece of roller composition, re-ink them with red ink. If the lines are so close that they cannot be cleaned and re-inked without touching the others, they can be raised slightly above the surrounding surface by the use of a bodkin.

After the whole job is properly inked, the proof may be pulled as already explained.

29. Galley-press.—Straight matter is usually placed on long galleys and proofs pulled on a *galley-press*. This is a frame-work surmounted by a flat bed, on the sides of which are raised tracks on which rolls a solid iron roller covered with felt. The frame contains a bin or cupboard for the accommodation of proof-paper. Fig. 19.

To obtain a proof on a galley-press the galley containing the type is placed on the flat bed, the type is inked with a brayer,

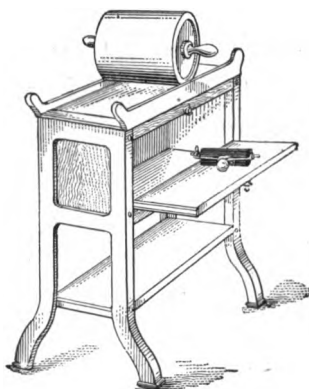

FIG. 19.—Galley-press.

a sheet of paper is placed on the type, and the roller is run over the face of the type. Owing to the fact that the roller frequently squeezes the type into the paper, the paper is apt to slip over the face of the type and smear the proof. This can be avoided by holding the paper tightly against the roller and rolling them together over the face of the type. Care should be taken to see that the galley has not too thick a bottom, for if the impression is too heavy there is no way of altering it. If the impression is too light, a thin cardboard or a sheet or two of manila paper under the galley will correct the fault. The press is intended only for galleys of type, not for small jobs.

30. Press-proofs.—In large offices proofs of jobs are usually pulled on *proof-presses*. There are many devices for this purpose. Some are worked on the plan of a cylinder press, inking the form and carrying the sheet through automatically. In others, the form is first inked and then the mechanism set in

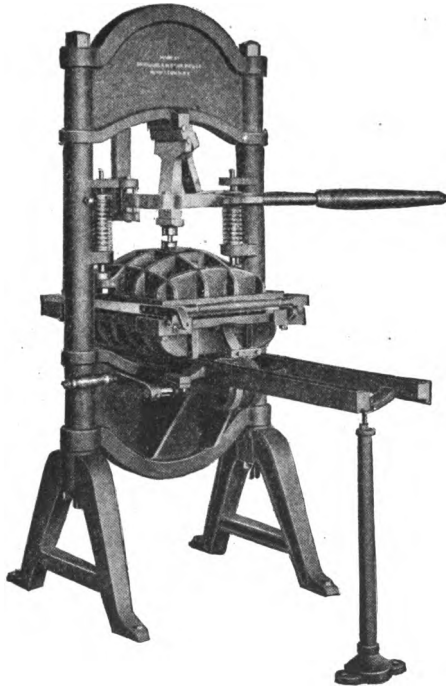

FIG. 20.—Washington Hand-press.

motion to obtain the impression. When jobs are too large to go on a proof-press, they are placed on the stone and proofs beaten off with a proof-planer. When proving book forms, where the pages are laid in pairs, the two pages which are back to back should be proved on one sheet, and the sheets then folded into book form.

31. The Washington Hand-press.—This is a familiar type of proof-press, wherein the form is inked, covered with a sheet of proof-paper, the tympan lowered, and the bed moved under the impression-plate. A hand-lever exerts a downward motion and gives the impression. The bed is then withdrawn, the tympan lifted, and the sheet removed. (Fig. 20.)

32. The Poco Proof-press.—This press consists of a bed and a cylinder racked to move in unison. The form is placed on the bed, inked with a brayer, a sheet of proof-paper placed on the form, and the cylinder and form rolled into contact by

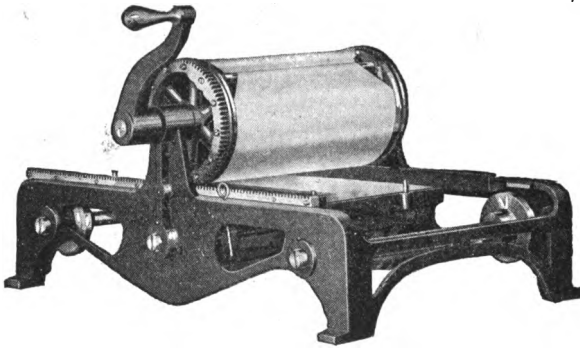

FIG. 21.—The Poco Proof-press.

the aid of a crank. The bed need not be returned for the next proof, as it can be worked from both ends. (Fig. 21.) If desired, the sheet may be slipped under a rod that acts as a gripper, and the sheet run around the cylinder.

33. The Potter Proof-press.—There are several types of this press on the market, some of them having automatic inking devices. In this press the cylinder rotates in stationary bearings, the bed moving forward and backward, as in an ordinary cylinder press. Grippers hold the sheet to the cylinder while the impression is being taken. An impression-trip is provided so that the cylinder may be raised and the bed returned to its original position without touching the cylinder. (Fig. 22.)

34. **The Vandercook Proof-press.**—This is an automatic, self-inking, cylinder proof-press (Fig. 23). The sheet may be



FIG. 22.—The Potter Proof-press.

laid on the type and the cylinder run over it, or the sheet may be fed to the grippers on the cylinder. In this make of press the

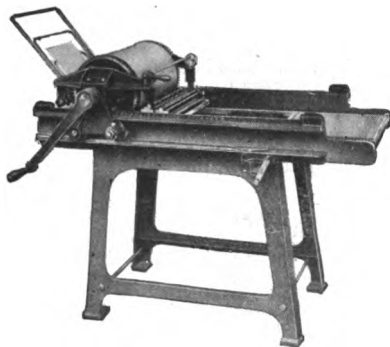

FIG. 23.—The Vandercook Proof-press.

bed is stationary and the cylinder rolls over the form. At the end of the stroke the cylinder is automatically raised so that it may be returned without soiling the tympan.

35. Correcting the Job.—When a good proof is secured, it is sent to the proofreader to be read, after which it is returned to the compositor for correction. If there are but few errors, and the letters to be substituted for those in the job are of the same thickness, the job may be corrected on the stone. If they are not of the same thickness—and this is usually the case—the job must be placed on a galley, the string removed, each line taken up again in the stick, the error corrected, and the line accurately respaced.

If it is necessary to overrun a few lines in making corrections, turn them around on the galley, so that the beginnings of the

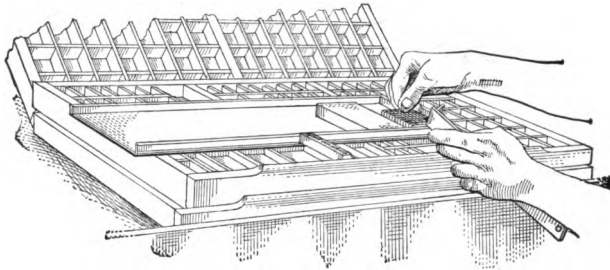

FIG. 24.—Overrunning Type.

lines are away from the edge of the galley. It is then possible to take off a few words at a time from the beginning of a line and reassemble the matter in the stick. See Fig. 24. It is very much easier and quicker to overrun matter in this way than to put down the stick and take up each line individually.

Another, and perhaps equally good way, is to spread the lines out on a long galley, so that the type matter reads consecutively, being sure to place a space at the end of each line unless the last word has been divided, in which case the hyphen should be removed. The matter may now be measured off with the composing-rule into line lengths, and each line taken up individually and justified.

Always hold the stick in the hand while spacing lines. Never try to correct one line in a stick after you have started to set another. Do not place the stick on the stand and attempt to pull out the spaces with tweezers. Hold the stick in the hand, remove the last letter in the line so as to loosen it, then proceed with the correction.

It is absolutely impossible to accurately space a line unless it is placed in a stick. Attempts to correct jobs on a galley or stone have entailed a greater loss of time in locking up than any other one thing. If a single line be longer than its fellows, it will prevent them from being locked tightly. Every line should be of uniform length. Time will be saved by doing the work right in the first place.

36. Pulling a Revise.—After the job is corrected, another proof, called a *revise*, is pulled. This is sent to the proof-reader along with the first proof. If the corrections have not all been made, it is again returned to the compositor. If they have been properly made, the last proof is sent to the author.

37. Saving Cord for Future Use.—When a job is untied, the cord should be carefully folded for future use. This should be done as illustrated in Fig. 25.

38. Making Up Pages.—Straight matter, whether it be hand-set, monotyped, or linotyped, is assembled on long galleys. After proofs are pulled and the type corrected, the matter is ready to be made up into pages. In this proceed as follows: make a gauge of a piece of cardboard, lead, or reglet by marking the exact length the type-face of the page is to be. With this gauge *cast off* the matter into pages, inserting a small piece of cardboard or lead to show the separation of the pages. In this way go over all the matter. It will very likely happen that the matter does not separate nicely into pages, and it may have to be recast into better form.

There are many things to be kept in mind when making up pages. Never have a single break-line at the top of a page or beneath a cut. If possible, never have a paragraph with a side-

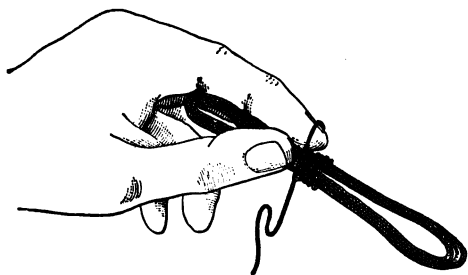

Last wrap of binding-layer looped over left index-finger.

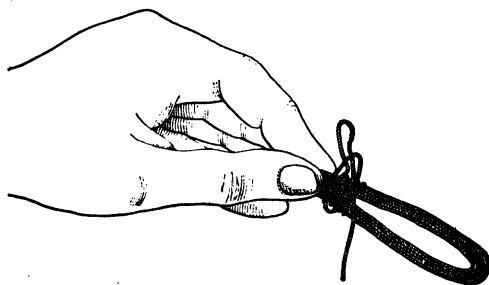

Loop in strand slipped through last binding-loop.



Loop slipped through last binding-layer and drawn tightly.

FIG. 25.—Illustrating Method of Tying Cord for Future Use.

heading on the last line of a page—carry it over to the top of the next page. Try to avoid having headings near the bottom; frequently a little rearrangement of the matter will obviate this. If the last part of the matter does not fill a page, the balance of the page should be left blank. If possible, have the last page at least one-third full of type. If the *cast-off* leaves but two or three lines on the last page, it is better to have the few previous pages each a line long than to put these few lines in a page by themselves. If there is a running head with a folio, the folio should be placed on the outside of the page; *i.e.*, to the left of a left-hand page, to the right of a right-hand page. If the folio be simply a figure or numeral, it may be either at the head or foot of the page. A folio at the foot, however, presents the better appearance.

39. Cleaning Type.—After the type has been printed from, and before it is distributed, it should be thoroughly cleaned. If this is not done the type will, in time, become so dirty that it is almost impossible to keep a line on its feet. This condition should not be permitted to occur. If a form comes from press in a dirty condition, it should be taken apart, each page tied up *loosely*, and then the type put to soak overnight in a pan of lye-water of medium strength. In the morning it should be removed and scrubbed with a brush, then *thoroughly rinsed* under a tap. To accomplish this it may be necessary to put the pages on a metal (not wooden) galley, untie them, and let the water get in between the letters.

40. Cleaning Rules.—The directions given above for cleaning type also apply to cleaning brass rules. If dirty rules are soaked overnight in weak lye-water, in the morning they may be rinsed under a tap and wiped clean with a rag. It frequently happens, however, that rules are not properly cared for, and it becomes necessary for the compositor to clean a piece before it can be used. The usual method in such cases is to flood the rule with benzine or other detergent and rub it on the stone. A much better way is to provide a piece of strawboard and saturate it with the detergent and rub the rule on it. Rubbing

the rule on the stone is very apt to round off the ends or face of the rule; with the strawboard this will be obviated. Border units that have become encrusted with ink can be cleaned in the same way.

41. Distributing Type.—Returning the letters to their proper places is called *distribution*. If the type is all of one size and kind, place it on a metal (not wooden) galley and wet it with clean water, using a sponge for the purpose. Wetting type accomplishes two apparently opposite things: it causes it to come apart and also to stick together. If the type is gummed fast from an aggregation of ink, dirt, etc., the water

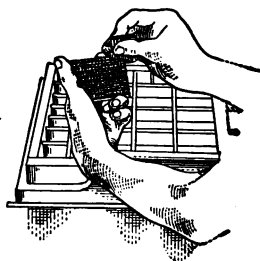

FIG. 26.—How Type Should Be Held in the Hand while Distributing.

will loosen it; if it has a tendency to fall apart it will cause it to adhere.

Fig. 26 shows how type should be held in the hand while distributing it. The novice is advised to begin by taking a few lines at a time, for if he should drop any type, as frequently happens, he will have less type to pick out of the case. As he increases in skill he may take larger amounts.

Hold the type nick up, and begin at the right-hand end of the line. Take off a whole word, separate the letters, one by one, and place them in their respective boxes. The method of separating the letters is shown in Fig. 27. The type is held against the thumb by the index-finger, and the middle finger tilts the letter from beneath the index-finger. At the same time, the two fingers are moved backward and forward over the thumb,

thus constantly advancing the first letter so that it will escape from beneath the index-finger. Proceed in this manner until all the type has been returned to the case.

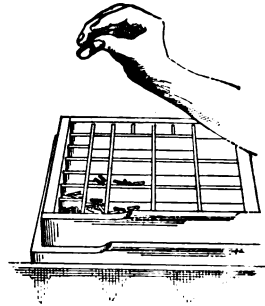
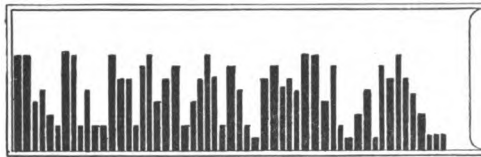
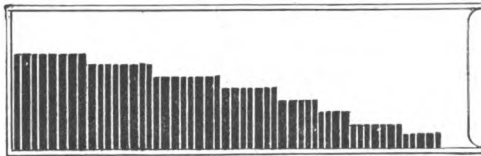

FIG. 27.—Separating Individual Letters While Distributing.

If the matter to be distributed is a job containing display lines, all the lines of the same size and kind of type should be



Leads and slugs as placed on the galley.



Leads and slugs after rearrangement.

FIG. 28.—Sorting Leads and Slugs.

grouped together on the galley and carried to the cabinet where they belong. This avoids useless walking back and forth. Job

type should be held in the hand and distributed as described under plain matter.

Do not drop or throw type into the case; place it in carefully, as it is easily battered.

42. Putting Away Leads and Furniture.—After all the type in a job has been distributed, return the furniture and leads to their proper places. If there is more than one size of leads used in the job, or if it is your duty in the office to put away leads, proceed as in Fig. 28. Stand them on end, as shown, then go through the lot, picking out first the largest size, and rearrange them as shown. They are now graduated as to size. Take up each lot of like size and measure it with a gauge. If it is of a labor-saving length put it in its proper box. All bastard lengths should be kept in a separate place. Consult the foreman and ascertain his wishes regarding them.

QUESTIONS ON CHAPTER III

1. What special care should you exercise when placing a job on the imposing-stone? Why?
2. Describe the pulling of a hand-proof.
3. How would you avoid the tendency of the proof-planer to lift the sheet while pulling a hand-proof?
4. Describe the method of inking a job when a proof is to be pulled in two colors.
5. Is it advisable to make corrections in lines of type without placing them in a stick?
6. What is a revise?
7. Demonstrate the proper method of tying up string for future use.
8. How should straight matter be cast off prior to being made up into pages?
9. Name some things that are to be avoided when making up pages.
10. How should type be cleaned? What happens when type becomes very dirty?
11. How should brass rule be cleaned? Why is it so essential?
12. How should type be held in the hand while distributing?
13. Why do we wet type before distributing?
14. Show by the use of your fingers just how the types are separated during the act of distributing.
15. How should leads and slugs be sorted?



CHAPTER IV

TYPE CALCULATIONS

43. How Much Will It Make?—It is frequently necessary to determine how much matter a certain piece of copy will make when it is set in type. This may readily be calculated. The first step is to approximate the number of words in the copy. This is accomplished by multiplying the number of lines in the copy by the average number of words in a line. In averaging the number of words in a line assume that a word of seven letters is a normal word; call two small words one and a very large word two. If it be manuscript copy we may have to go over it all, unless it runs fairly uniform. With type-written copy, which is more uniform, and easier to calculate, find the average number of words per line, multiply by the number of lines to get the number of words per page, then multiply this by the number of pages to get the total number of words in copy.

Having determined the number of words in copy, set a line of the type to be used, and find the average number of words to a line. Dividing the number of words in copy by the number in one type line will give the number of lines the matter will make in type. For example, if the copy contains 10,656 words and the type runs eight words to a line, then

$$\frac{10,656}{8} = 1332, \text{ the number of lines of type.}$$

If we wish to determine how many inches the matter will make after it is set, we can do so by changing the dimensions from ems to points, and then to inches. Count 72 points to the inch. Multiply the size of the body of the type by the number

of lines to change the dimensions to points, then divide by 72 to change to inches. In the example given above, if the type were ten-point, there would be

$$\frac{10 \times 1332}{72} = 186\frac{1}{3} \text{ inches.}$$

If the job were set in eight-point, and contained 1200 lines, then the matter would be $133\frac{1}{3}$ inches long. Thus,

$$\frac{8 \times 1200}{72} = 133\frac{1}{3} \text{ inches.}$$

If the matter is to be monotyped, and the copy is typewritten, it may be easily calculated. It has been found that fifty-three typewriter characters always equal twenty-five set ems. Therefore, approximate the number of characters in the typewritten copy, counting spaces between words as characters, divide by fifty-three and multiply by twenty-five. Thus, if the copy contains 10,722 characters, it will make 5058 set ems.

$$\frac{10,722 \times 25}{53} = 5058 \text{ set ems.}$$

The same result may be obtained by multiplying the number of typewriter characters by the constant .4717. This constant is obtained by dividing 25 by 53.

$$\frac{25}{53} = .4717$$

$$.4717 \times 10,722 = 5058 \text{ set ems.}$$

$$\frac{10,722 \times .4717}{53} = 5058 \text{ set ems.}$$

44. What Size Type Shall I Use?—If it is desired to fill a certain space with a certain piece of copy, the size type to be

used may be determined as follows: first calculate the number of words in the copy, as explained in the preceding section. Next try a line of the size type estimated to be of the proper size. Then count the number of words to one line of type, determine how many lines may be gotten into the allotted space and multiply these two factors together to obtain the total number of words. If the number is slightly greater than the number in the copy, the right size of type has been chosen. If the number of words in the copy is greater than the type will accommodate, a smaller size type must be used. If the number of words in the copy be less, use a larger size type.

If the calculations show that one size of type is too small and the next size larger is too large, the matter may frequently be made to fit the space by setting it in the smaller size type and leading with either one-point or two-point leads.

To determine how many lines of any size type may be gotten into a given space, determine the size of the space in inches, multiply by 72 to change dimensions to points, and divide by the size of the body of the type. For example, the number of lines of ten-point type that can be gotten into six inches is found thus:

$$\frac{6 \times 72}{10} = 43.2 \text{ lines.}$$

Ignore the two-tenths, and count on forty-three lines. If ten-point runs ten words to a line, 432 words may be placed in the six-inch space; if it runs six words to a line, only 258 words will go in the six inches.

45. Determining the Number of Ems in Composed Matter.—When type is set without display lines, as in books, magazines, and newspapers, it is known as *straight matter*. If the compositor is working by the piece he is paid for his work according to the number of ems that it contains. To determine the contents in ems it is customary to measure the matter with a type-gauge, and thus find its width and length in ems of the type in which it is set. Multiplying the number of ems

in width by the number of ems in length will show the total number of ems.

If a type-gauge is not at hand, the same result may be secured by using a rule graduated in inches. Count seventy-two points to an inch. To determine the number of ems multiply the number of inches by seventy-two and divide by the em of the body. Do this both for the width and the length, and then multiply the one by the other.

Example.—Suppose a piece of matter set in eight-point is four inches wide by twenty inches long. Then,

$$\frac{4 \times 72}{8} = \frac{288}{8} = 36 \text{ ems wide,}$$

$$\frac{20 \times 72}{8} = \frac{1440}{8} = 180 \text{ ems long,}$$

$$36 \times 180 = 6480 \text{ ems.}$$

Sometimes the length of a line of type will exceed an even number of ems of the size in which it is set. If this excess be less than half an em, it is not considered; if it be half an em or more, it is counted as a full em. Never make calculations in fractions of an em.

When lines of type have leads between them the matter is said to be *leaded*, when leads are omitted it is said to be *solid*. Piece-workers prefer to set leaded matter, because they get paid for the *area* that the matter covers, and not for the actual number of lines set.

46. Determining the Value of Composed Type.—To determine the value of composed type, point off the number of ems into thousandths, and multiply by the rate per thousand. For example, to find how much the matter of the preceding problem would be worth at forty cents per thousand, $6.480 \times 40 \text{ cents} = \2.59 .

Some printers sell composition on a square-inch basis. That is, they measure the area of the composed matter and charge

for it at so much per square inch. Table III shows the selling rate per square inch for various sizes of type at various rates per thousand.

TABLE III.—RATES PER SQUARE INCH FOR COMPUTING VALUE OF COMPOSED TYPE

The value of composition per square inch in all sizes of type, from 4½-point to 12-point, at 60c., 55c., 70c., 75c., 80c., 85c., 90c., 95c., \$1.00, \$1.05, and \$1.10 per 1000 ems. A type-gauge is not always at hand, but foot-rules are plentiful.

Price per 1000 ems.	60c.	65c.	70c.	75c.	80c.	85c.	90c.	95c.	\$1.00	\$1.05	\$1.10
4½-point...	.1536	.1664	.1792	.192	.2048	.2176	.2304	.2432	.256	.2688	.2816
5-point...	.1244	.1348	.1452	.1555	.1659	.1763	.1866	.197	.2074	.2177	.2281
5½-point...	.1028	.1114	.12	.1285	.137	.1456	.1542	.1628	.1714	.1799	.1885
6-point...	.0864	.0936	.1008	.108	.1152	.1224	.1296	.1368	.144	.1512	.1584
7-point...	.0635	.0688	.0741	.0794	.0846	.0899	.0952	.1005	.1058	.1111	.1164
8-point...	.0486	.0527	.0567	.0608	.0648	.0688	.0729	.077	.081	.085	.0891
9-point...	.0384	.0416	.0448	.048	.0512	.0544	.0576	.0608	.064	.0672	.0704
10-point...	.0311	.0337	.0363	.0389	.0415	.0441	.0467	.0492	.0518	.0544	.057
11-point...	.0257	.0278	.03	.0321	.0343	.0364	.0386	.0407	.0428	.045	.0476
12-point...	.0216	.0234	.0252	.027	.0288	.0306	.0324	.0342	.036	.0378	.03913

EXAMPLE. A page measuring 4½×6 would contain 27 square inches, if set in 8-point type and figured at 90c. per 1000 ems, multiply by .0729, as per table, and the correct result is \$1.97. If any other rate is required, use the corresponding figures.

This square-inch method is based on the rate per thousand ems. To find the cost of one square inch of any size type, divide the price per thousand by 1000 to find the cost of one em, then multiply by the number of ems in one square inch. As there are seventy-two points in one linear inch, there are 5184 square points (72×72) in one square inch. Divide this factor by the number of square points in the size of the body of the type being measured.

Example 1. What is the square-inch rate for eight-point type at sixty cents per thousand?

An eight-point em is square, therefore it contains sixty-four square points (8×8). $5184 \div 64 = 81$ ems to the square inch. At sixty cents per thousand $60 \times 81 \div 1000 = \0.0486 per square inch.

Example 2. What is the square-inch rate for ten-point type at seventy-two cents per thousand?

$$10 \times 10 = 100 \text{ square points in one em;}$$

$$5184 \div 100 = 51.84 \text{ ems per square inch.}$$

$$72 \times 51.84 \div 1000 = \$0.0373 \text{ per square inch.}$$

47. Determining Weight of Type by Measurement.—

One square inch of type weighs, approximately, one-quarter of a pound. To find the weight of any composed page of type either multiply the number of square inches by one-fourth or divide by four.

Type matter is usually set to some measure in picas. To avoid calculating in fractions of an inch, it is sometimes easier to determine the size of the page in picas. There are thirty-six pica ems in one square inch, or 144 in four square inches. Picas may therefore be changed to pounds by dividing by 144.

Example. How many pounds of type in one page of this book? Size of page, 22×38 picas. If worked on the square-inch basis, change the picas to inches, thus: $22 \text{ picas} = 3\frac{2}{3} \text{ inches}$; $38 \text{ picas} = 6\frac{1}{3} \text{ inches}$. Then $3\frac{2}{3} \times 6\frac{1}{3} = 23\frac{2}{9}$.

$$23\frac{2}{9} \div 4 = 5.8 \text{ pounds.}$$

On the pica basis, $22 \times 38 \div 144 = 5.8$ pounds.

48. Determining the Amount of Leads to a Page.—Two-point leads run about 144 inches to the pound; three-point leads, 96 inches; and one-point, 288 inches. As there are six picas to the inch, if each of these factors be multiplied by six, new divisors are obtained based on picas. To avoid fractions it is easier to work on a pica basis. For two-point leads divide by 864; for three-point, 576; for one-point, 1728.

Example. How many pounds of two-point leads in a page of this book? Twenty-two picas wide, thirty-seven leads to the page; $22 \times 37 \div 864 = .94$ pound, or about 15 ounces.

$$\frac{22 \times 37}{864} = .94 \text{ lb.}$$

$$\begin{array}{r} \text{II} \\ 22 \times 37 \times 16 \\ \hline 864 \\ \hline 54 \\ 27 \end{array} = 15\frac{3}{4} \text{ oz.}$$

PROBLEMS ON CHAPTER IV

1. If copy contains 10,000 words, and we can get eight words in a line of type, how many lines will it make?
2. Copy consists of ten pages of manuscript averaging thirty lines to a page and eight words to a line, how many lines of type will it make if we can get ten words in a line?
3. If we wish to prepare copy so that it will fill a certain space, and we determine that the size type we wish to use runs nine words to a line, how many words should we write to fill ninety lines?
4. How many lines of each of the following sizes of type can be gotten into a page six inches long: 6-point, 7-point, 8-point, 9-point, 10-point, 11-point, 12-point?
5. How many ems of 9-point in a page 4×7 inches?
6. How many ems of 10-point in a line 25 picas long?
7. A page set in 8-point, solid, contains 54 lines, if it is 24 picas wide how many ems does it contain?
8. What decimal part of an inch is six picas?
9. If you measured a piece of furniture with a foot-rule and found it to be $6\frac{1}{2}$ inches long, what would you say its length was in picas?
10. How many picas in $\frac{3}{4}$ inch?
11. How many ems of 9-point in $\frac{3}{4}$ inch?
12. If copy contains 690 words, what size type would you use to fill a space 4×7 inches, if you found on trial that 10-point averaged seven words to a line, 9-point averaged nine words, and 8-point eleven words?
13. If the copy in Problem 12 contains but 600 words what size type could you use, and how would you make it fit the space?
14. How many pounds of type in a page 4×7 inches?
15. If a type page is 26 picas wide and 30 picas long how much does it weigh?
16. If a page of 8-point type is 30 picas wide and 63 lines long, how much does it weigh?

17. If we were to lead the page in Problem 16 with 2-point leads how much would it weigh ?

18. Two-point leads are put up at the typefoundry in packages containing ten pounds. If the strips are twenty-four inches long, how many are there in a package ?

19. Determine the number of ems per square inch for each of the following sizes of type : 6-point, 7-point, 8-point, 9-point, 10-point, 11-point, and 12-point.

20. How many strips in a pound of 3-point leads ?

21. How many pounds of 2-point leads will be required to lead a piece of 10-point matter, if the latter is 23 picas wide and 20 inches long ?

22. What is the selling rate per square inch for 6-point type, if it is based on forty cents per thousand ?

23. Some monotyped matter was found to contain 12,675 ems, how many typewritten characters were there in the copy ?

24. If the carrying capacity of a floor in a printing office is 1008 pounds per square foot, how many pages 3×6 inches in size can be piled on a space 12 inches square ?

25. Type is frequently stacked in layers with cardboard between each layer. If we ignore the weight of the cardboard, what will be the weight on a square foot of floor space if we have eighteen layers of type ?

CHAPTER V

PROOFREADING *

49. Requirements for Proofreading.—It has been said that anyone who possesses a thorough knowledge of grammar, etymology, syntax, and orthography is qualified to read proof. This may cover seventy-five per cent of the knowledge required of a proofreader; the other twenty-five per cent consisting of a knowledge of indentions, make-up, wrong fonts, and numerous other things embraced under the term "style of the office." Employers much prefer to have as proofreaders men who have

* **NOTE.**—Teachers are urged to make proofreading a strong feature of their courses in printing. The author has been doing this ever since he took charge of the printing course at the Philadelphia Trades School, and he finds that it affords abundant opportunity to speak on many topics connected with the trade. All of the lessons have some bearing on printing or an allied subject, and thereby serve a twofold purpose. Errors are purposely introduced and then commented upon. These include spelling, punctuation, syntax, grammatical construction, improper divisions, transposed lines, typographical errors, bad make-up, bad spacing, etc.

The author's plan of handling this subject is to give each boy in the class a printed copy of the lesson and have him mark such errors as he can detect. After each boy has completed the reading of his proof, the boys exchange papers and prepare to check up each other's corrections. Each boy then reads a paragraph aloud. As he proceeds, the errors are taken up in turn and commented on, and proper usage described. The subject matter of the text frequently comes in for explanation and discussion. In this way much valuable information is imparted that would not otherwise come before the class.

Errors of commission in punctuation are held against the boy just the same as errors of omission, for it has been found that students mark in and mark out, *ad libitum*, in the hope that nothing is being overlooked. A student does not learn anything from such an indiscriminate placing of punctuation marks. He should be taught to use them correctly.

had considerable experience at the case. These men, being familiar with the methods of the trade, are more apt to detect errors than those whose training has been in language construction alone.

Proofreaders should keep in mind that each author has his own style of writing, and that, if the author has made his meaning clear without violating the rules of grammar, it is not their province to alter the construction. If, however, an author has disarranged his words, and befogged, rather than clarified, his exposition, it is clearly the proofreader's duty to suggest change.

50. Proofreaders' Marks.—The marks commonly used in proofreading are shown in Table IV. These should be studied until their meaning and use are clearly understood. Page 48 shows a marked proof and page 49 the same corrected.

The first few marks in Table IV, showing underlining of words, are used particularly in the preparation of copy. Three lines drawn beneath a word signify that it is to be set in capitals; two lines, that it is to be set in small capitals; one straight line, in italic; one wavy line, in boldface. Use of other proofreaders' marks will usually be clear from a careful examination of the table and of the accompanying sample of corrected proof. Particular attention is called, however, to the use of the *dele mark*, *∫*. This mark is encountered in various forms, for proofreaders do not all make it alike. All forms, however, have the same meaning; that is, take out, or remove, whatever has been marked. Its use should be restricted to the marking out of words or characters that are to be taken out entirely. When one character is to be substituted for another there is no need to use the dele mark. If the character to be removed is a hyphen in a compound word, and the two parts are to be united, use a ligature above and below the dele to show that the words are to be brought together. If the hyphen is to be taken out of a compound word and two separate words used, substitute a space mark (∗) for the hyphen.

TABLE IV.—SYMBOLS EMPLOYED IN PROOFREADING

Caps. or ≡	Put in <u>capitals</u> .
S.C. or ≡	Put in <u>SMALL CAPITALS</u> .
l.c.	Put in <u>LOWER CASE</u> .
ital. or <i>some</i>	Put in <u>roman</u> type.
bold or <i>some</i>	Put in <u>italic</u> type.
<i>uf</i>	Put in <u>bold face</u> type.
<i>ta</i>	Wrong font: character of wrong size or style.
<i>to</i>	Transpose.
<i>to</i>	Dele: take <u>out</u> .
<i>o</i>	Letter <u>reversed</u> —turn.
[or Flush	[Carry to the left.
] or Flush] Carry to the right.
x	<u>o</u> perfect letter—correct.
↓	Space show <u>between</u> words—shove down.
□ or ¶	Indent.
#	Put in space.
<i>Close up</i>	Close up—no space.
<i>Bad spacing</i>	Bad spacing; space more evenly.
<i>Straighten crooked line</i>	Straighten crooked line.
<i>Restore or return words crossed out</i>	Restore <u>or return</u> words crossed out.
<i>Print (æ, fi, etc.) as a logotype</i>	Print (æ, fi, etc.) as a logotype.
<i>Period. Always make a circle around the dot, so that the period will not be mistaken for a comma or a blemish in the paper</i>	Period. Always make a circle around the dot, so that the period will not be mistaken for a comma or a blemish in the paper.
^	Signifies comma.
∩	Signifies apostrophe.
∪	Quotation marks.
∩	Signifies hyphen.
⊙	Signifies colon.
;	Signifies semicolon.
—	Signifies one em dash.
—	Signifies two em dash.
?	Signifies interrogation point.
!	Signifies exclamation mark.
^	Signifies caret.
∩	Signifies superior character.
∪	Signifies inferior character.
[]	Inclose in brackets.
()	Inclose in parentheses.
and	Use character <u>and</u> .
¶	Make a new paragraph.
No ¶	Not a paragraph; run in.
Out — see copy	Words are omitted from, or in <u>copy</u> .
POK	Query to author. Add explanation.

Another particularly important mark is “. . .” or “stet.” Stet is derived from the Latin, and means “let it stand”; that is, do not remove the part marked out. Authors frequently mark out passages from their manuscripts by drawing lines through them. If they decide later to retain the passages thus marked out, they do not attempt to erase the marks, but simply mark the passage “stet.” Proofreaders also use this mark when they have inadvertently marked out the wrong word.

The comma and the apostrophe should be differently designated on proof, for, if no distinction is made, an error may result. A mark over a comma signifies that a comma is intended; if the mark is beneath, it signifies an apostrophe.

As other rules of good practice, attention is called to the following:

Always make a hyphen with a double stroke, thus, =, so that every slip of the pencil will not be mistaken for a hyphen.

Always use a caret (^) when anything is to be inserted in a line, and always make the mark at the bottom of the line.

A line drawn through a capital letter in copy means that it is to be set in lower-case.

A ring drawn around a contraction, an abbreviation, or an ampersand (&) means “spell it out.”

When marking a proof put all the errors that are to the left of the center in the left-hand margin and all to the right of the center in the right-hand margin. Place them directly opposite the line in which they occur and in the order in which they occur. To be sure of having room for this purpose, the first error on the left of the line should be placed some little distance from the text, the first one on the right should be close to the text. *Do not draw lines from the errors to the corrections*, for that would entail a useless waste of time in tracing the corrections, and there is likelihood of error if the lines cross or touch each other. Moreover, such lines mar the appearance of the proof.

Views and Practices Regarding Apprentices

10 = point
O.S. Ant.
caps.

No. 4—By WILLIAM H. SEED
From The Inland Printer for April, 1916

1/3 Ital. / 2

S.C. "Boys are a nuisance," were his first words, and it was perfectly clear that the remarks apply here which I have made about other offices where no academic training is received by the apprentices. de

"How would you regard a proposal," I said, "to send boys to school half a day in order to have them instructed in those subjects which would be calculated to give them more interest in their work? I mean such subjects as grammar and composition, arithmetic, with special reference to casting up and soon, designing the history and theory of printing, and so forth." 2

"Would the courses be arranged so that some boys could attend in the morning and some in the afternoon, so as not to leave the office without boys?" he asked. I have always noticed that foremen do not want to be short of boys, much as they proclaim them to be a nuisance. 3

"I suppose so," I replied. The foreman pondered for a few moments over what was evidently a new idea to him, and at length he said, "I think it would be an excellent idea." C

The key to his sudden conversion to an idea which I expected him to oppose was clearly to be seen. It would make the boys interested in their work, that was everything to him, and it is a valuable point to be kept in mind by the advocates of academic training for apprentices. Put the idea forward without explanation and you arouse a storm of opposition, or at ~~mea~~ least with indifference; but make it clear that you are really going to make better boys, because they will be more interested in their work, and the "bow-wows" are changed to "hear-hears." One might think it sufficiently clear that this is the object of all suggested academic training for printers, but it is not clear to those merely to make the trade more exclusive; to "do something who have not thought of it. You are supposed to desire for the boys" out of pure philanthropy, as one might clothe and feed them were it necessary, or as one might give them bean feasts out of pure good nature. 4 rom. I. l. h

↓
?
*
ffi
w/o
□
w.f.
tr.
*
tr.
=

2
3
C
O) #
! / X
I. l.
4
rom.
I. l.
h

VIEWS AND PRACTICES REGARDING APPRENTICES

No. 4—By WILLIAM H. SEED

From *The Inland Printer* for April, 1916

"Boys are a nuisance," were his first words, and it was perfectly clear that the remarks apply here which I have made about other offices where no academic training is received by the apprentices.

"How would you regard a proposal," I said, "to send boys to school half a day in order to have them instructed in those subjects which would be calculated to give them more interest in their work? I mean such subjects as grammar and composition, arithmetic, with special reference to casting up and so on, designing, the history and theory of printing, and so forth."

"Would the courses be arranged so that some boys could attend in the morning and some in the afternoon, so as not to leave the office without boys?" he asked. (I have always noticed that foremen do not want to be short of boys, much as they proclaim them to be a nuisance.)

"I suppose so," I replied.

The foreman pondered for a few moments over what was evidently a new idea to him, and at length he said, "I think it would be an excellent idea."

The key to his sudden conversion to an idea which I expected him to oppose was clearly to be seen. It would make the boys interested in their work! That was everything to him, and it is a valuable point to be kept in mind by the advocates of academic training for apprentices. Put the idea forward without explanation and you arouse a storm of opposition, or at least meet with indifference; but make it clear that you are really going to make better boys, because they will be more interested in their work, and the "bow-wows" are changed to "hear-hears." One might think it sufficiently clear that this is the object of all suggested academic training for printers, but it is not clear to those who have not thought of it. You are supposed to desire merely to make the trade more exclusive; to "do something for the boys" out of pure philanthropy, as one might clothe and feed them were it necessary, or as one might give them bean feasts out of pure good nature.

51. Order of Procedure in Proofreading.—As a first step in reading a proof, it is advisable to line up the paragraphs. To do this draw a faint pencil-line down the proof, using the first lines of the paragraphs as a guide. Any inequality of indention will be detected at once. Next go down the ends of all the lines and verify the divisions of words; that is, make sure that they have been properly divided and that the remainder of each word is at the beginning of the next line. See that all headings and subheads (also running titles, folios, and signatures of paged proofs) are correct. See that the numberings of chapters, sections, etc., are consistent and consecutive. Glance over the proof to see if any glaring errors are noticeable. These things having been disposed of, the mind is free for concentration on the text. Read and analyze each statement made by the author. Endeavor to grasp his full meaning. If he or the compositor has failed to put in the necessary marks of punctuation, it is the proofreader's duty to do so. This is where the compositor has a chance to show his knowledge and skill. If the compositor understands punctuation he will have inserted the proper marks. True, the proofreader may not agree with him, and some may be altered or removed.

Now that the bulk of straight matter is set on machines, employers find it to their advantage to have copy revised by the proofreader before setting. This obviates resetting matter for corrections.

52. Punctuation.—The question of punctuation is one on which there is great diversity of opinion. Some authors and proofreaders cut their sentences up into short, jerky clauses; others omit all points so long as the words are logically connected. The author prefers the latter practice, and would here call attention to the increasing extent to which it is becoming established. Just as a clear, flowing stream is the most refreshing from which to drink, so is clear, flowing language the most refreshing to the mind, whether it be written or spoken.

Proofreaders should be very careful not to alter an author's *style* of writing. Any sentence that gives the reader a correct

conception of the author's meaning may be said to be properly punctuated. Words which do not give the correct sense when read are either wrongly used or improperly punctuated, and some change should be made. Usually, it is not the proof-reader's privilege to alter copy; it is his *duty*, however, to call attention to anything that may seem to him to be wrong. Such a notation on a proof is called a query.

53. Marks of Punctuation.—The following are the usual marks of punctuation: the comma (,), the dash (—), the semicolon (;), the colon (:), the period or full-point (.), the hyphen (-), the apostrophe ('), the interrogation mark (?), the exclamation mark (!), brackets [], and parentheses ().

54. Use of the Comma (,).—The Century Dictionary states that the comma is “used to indicate the smallest interruption in continuity of thought or grammatical construction, the marking of which contributes to clearness.” The following examples show some uses of the comma:

1. Before a conjunction introducing an antithetical clause.

Any man can be a printer merely by calling himself one, and there is no one who would dare challenge his assertion.

2. After a participial clause, especially if it explains the main clause.

Being out of “sorts,” we were unable to finish the job.

Figuratively speaking, this man combines two or more individuals working in harmony.

3. When the conjunction is omitted between words, phrases, or clauses.

That job is fearfully, wonderfully put together.

4. After a word or clause independently beginning a sentence.

Fortunately, some boys who start out to become printers soon realize their mistake.

Shorn of all its verbiage, efficiency is nothing more than getting a thing done with the least possible friction in the least possible time.

5. After each of a series of words or clauses, and when words are used in pairs.

Third, the ordinary routine of business and society has developed a myriad of forms, such as the letterhead and wedding announcement, the street-car transfer and laundry-list, the blank form, the time-table, and the telephone directory.

6. To separate proper nouns belonging to different individuals or places.

To George, Henry seemed a mystery.

To America, Europe looks for peace proposals.

7. After a vocative expression.

Mr. President, I feel highly honored, etc.

8. Between two independent clauses joined with a conjunction.

Many of us are prone to give advice as to what not to do, and yet we fail to offer a constructive idea of what should be done.

9. After adjectives where two or more coming together qualify the same noun, but not between the last adjective and the noun.

The question of tone values is entirely in the hands of the photoengraver, who can give you a strong, solid impression, or a gray, weak, uninteresting picture.

10. When an adjective qualifies the succeeding adjective do not use the comma.

For best results use a strong bright red.

He is a weak old man.

11. Restrictive clauses do not take the comma, because the statement is restricted to that particular subject. There is great difference of meaning between the following statements:

The color, which is complementary, should be preferred.

The color which is complementary should be preferred.

12. Always use a comma before the conjunction that joins the last of a series of nouns, adjectives, or participles to the preceding ones.

Meanwhile, in addition to Gutenberg's single process, two others have developed, giving us three fundamental processes: typography (relief), intaglio (incised), and lithography (plane), besides die-stamping and embossing.

Tom, Dick, and Harry have gone to school.

If we omit the comma after Dick, the sentence reads as if we are telling Tom that Dick and Harry have gone to school.

Here is a sentence that recently appeared in print:

I think it is high time we realized that there are other occupations for the blind besides making brooms, caning chairs, weaving and tuning pianos.

Of course, the idea of weaving a piano is so ridiculous that the meaning cannot be misconstrued, but the sentence is very apt to be misread.

Here is another: "Seashore chairs, invalids' chairs and go-carts." Of course, it does not mean invalids' go-carts, even though it says so. A comma after "chairs" would have avoided all likelihood of mistake.

Many educators persist in teaching the omission of the comma before the conjunction, contending that the conjunction takes the place of the comma. The function of a comma is to *separate* words or phrases, while that of the conjunction is to *join* them together. It is obvious that the conjunction cannot fulfill this dual role. If those who advocate the omission of the comma were to spend a year or two at the proof-desk and had occasion to note how frequently the sense of an article may be misconstrued when the comma is omitted, the author is confident that they would insist on its use. When it is used there is never any doubt as to the meaning of the sentence; if omitted, the sentence is sometimes ambiguous.

A department-store advertising manager who always insisted on the omission of the comma frequently went into print with

monstrosities in his endeavors to make his meaning clear. At one time he was giving a list of the color combinations that were to be had in handkerchiefs. He stated that they were in "combinations of black-and-white, blue-and-white and pink-and-white." Owing to the fact that he omitted the comma before the last group in the series, he resorted to the use of the hyphens. Had he used the comma, the hyphens would not have been necessary.

Of course, this was not so bad. His meaning was clear. But one day he ran into a new combination of colors, and this was the result: "We have them in black-and-white, blue-and-white, pink-and-white and navy blue-and-nile green-and-white."

Another noteworthy shortcoming of this particular man was that he usually knew when to join two words together as a compound adjective, but he did not know that at other times they could be used as separate words. Consequently, he had gotten into the habit of using certain combinations of words always in the compound form.

55. The Dash (—).—A dash indicates a pause slightly longer than that called for by a comma. Its various uses are covered in the following:

1. To indicate a sudden change in thought.

If his judgment is in error—well, "there's no money in the printing business, anyway!"

2. To denote faltering speech.

I—ah—well—no; I don't think so.

3. To point off a parenthetical clause.

The plate is perishable—sensitive to atmospheric conditions—but the cost of making it is not great.

4. To separate an explanatory word or clause from the original statement.

From the time that printing was invented there has been a decline of the printer's regard for that for which printing was designed—language.

5. Between a sidehead and the text, and after the word "Note" in a footnote.

(See general use throughout this book.)

NOTE.—Use a dash after the word "Note."

6. Before the words "Continued" and "Concluded."

"How We Got Our Alphabet."—Continued.

"Printing as a Fine Art."—Concluded.

7. To repeat by way of emphasis.

Your catalogue takes the place of your salesman—your catalogue is your salesman.

8. Before a credit at the end of a quoted article.

"Here we are face to face with a new and difficult problem—new and difficult, that is, in the sense that . . ."—*Manual of Style, University of Chicago Press.*

9. Writers who are not confident of the proper marks of punctuation make frequent use of the dash. Advertisers sometimes use the dash to string together a series of disjointed, forceful phrases that are logically but not syntactically connected.

10. Do not use a dash after a formal address to a letter; a colon is the proper mark. (See under "Colon.") The frequency with which stenographers use both the colon and the dash leads one to suppose that such is the practice taught in business colleges.

11. Besides the one-em dash, whose uses have been exemplified, en dashes and two-em dashes are also used.

Use an en dash to stand for "to" in words or numbers.

January–March, 1917. Pages 39–48. Winter of 1915–16.

A compound word set in capitals should have an en dash instead of a hyphen.

THE ADLER–JONES CONTROVERSY.

Use a two-em dash to show omission of part of a name.

Mrs. K ——— will soon return.

56. The Semicolon (;).—The pause indicated by a semicolon is slightly longer than that after a comma or a dash. The semicolon finds its use mostly in complex sentences.

1. When a sentence opens with an introductory clause, the succeeding clauses should be separated with semicolons, especially if the latter contain commas.

The following are the officers for the ensuing year: Wilbur Smith, President, of Philadelphia, Pa.; Theodore Mabie, Vice-President, of Newark, N. J.; Harold Parseval, Secretary-Treasurer, of Blissville, N. Y.

2. When successive clauses of a compound sentence are not joined by conjunctions, use the semicolon.

Standing matter is job insurance; it is the cure for that great evil, the transient customer; it is the printer's best argument for repeat orders.

3. In Scripture references, to separate passages containing chapters.

Gen. 4:6-13, 15, 19; 5:18.

4. The semicolon should be placed outside of the quotation marks, unless a part of the quotation.

"If a task is once begun, never leave it till it's done"; writes Phœbe Carey.

57. The Colon (:).—The colon denotes a longer pause than that after a semicolon. Its uses are illustrated below.

1. After the salutation of a letter.

William F. Smith & Co.,

GENTLEMEN:

We are in receipt of your letter of the eighth instant, etc.

MY DEAR MR. WILSON:

2. On title-pages, where the location precedes the name of the publisher in the same line.

New York: John Wiley & Sons, Inc.

3. After the introductory clause of a complex sentence.

Edward L. Thorndike, of Teachers College, Columbia University, says: "To the five-year-old a page of print is an indefinite smear of black specks on a white ground; to his teacher it is a definite series of letters and words; to the printer it is not only that, but also ten-point type."

4. Between minutes and seconds in time designations, and between chapter and verse in Scripture passages.

He is in the 2 : 10 class. (See "Period" for time-tables, etc.)
St. John 10 : 13-15; 12 : 9-16.

If a colon and the closing marks of a quotation should come together, place the colon inside of the quotation marks if it is a part of the quotation; if it is part of the sentence in which the quotation occurs, place it outside of the quotation marks.

58. The Period (.).—The period denotes a full pause, and is used at the end of every sentence unless the sentence be in the form of an exclamation or an interrogation. Other uses of the period are:

1. To denote an abbreviation or a contraction. A contraction is sometimes denoted by the use of an apostrophe. (See Apostrophe.) Never use both marks at the same time.

Dr. (Doctor); Wm. (William); Pa. (Pennsylvania); Co. (Company); Inc. (Incorporated).

2. After Roman numerals and Arabic figures when used in indexes or in the numbering of paragraphs throughout the text, but not if standing alone.

See numbered paragraphs throughout this book.

I. Composition.....	13
II. Presswork.....	49
III. Color work.....	123

3. To separate dollars from cents.

\$1.79

\$17.25

\$975.60

4. In time-tables to separate hours from minutes.

9.12 A.M.

12.49 P. M.

(In time-tables P. M. hours are usually designated in heavier type.)

5. To indicate that what follows the point is expressed decimally.

3.1416

.7854

.5%

6. Names which have been shortened and which are used as nicknames do not take the period.

Sam, Ben, Rob, Will, Fred, Phil, etc.

7. To show an omission of words in an extract, use three or four periods with en quads between them.

Some one has held that "Typography . . . ought to be like a sheet of flawless crystal, so clear that you can gaze through it without ever being conscious that it is there;"

59. The Hyphen (-).—The use of the hyphen is illustrated below.

1. In dictionaries, to separate words into syllables.

in-com-pat-i-ble

rev-o-lu-tion

2. To show that the word at the end of the line has been divided.

(See the various divisions throughout the text.)

3. To show that two or more words are to be joined together and used as a single term.

So-called printer.

Three-year-old child.

Modern printing-presses.

(See also under "Compound Words.")

60. The Apostrophe (').—The apostrophe was primarily used to indicate the omission of one or more letters from a word. It is no longer restricted to such use, but is now employed for other purposes.

1. To denote the omission of letters.

I'll, for *I will*.
Don't, for *do not*
It's, for *it is*.

2. To denote possessive case.

William's hat.
Adams's bakery.

3. To indicate the plural of figures or letters.

He had ten 3's and twelve A's.

4. To denote a contraction.

Dep't, for *department*. Sec'y, for *secretary*.

61. Quotation Marks (" ").—The usual method of quoting is to use two inverted commas at the beginning of a citation and two apostrophes at the end. Some latter-day fonts, of which Bodoni is a type, have a character specially cast for the opening mark of quotation. (See page 60.)

When one quotation includes another, the second one should have single marks instead of double. If still a third occurs, this should be double.

When a copied article consists of more than one paragraph, the closing quotation mark should be placed at the end of the last paragraph only. The opening quotation mark, however, should be used at the beginning of each quoted paragraph to show that it is a continuation of the citation. *Do not* close the quotation at the end of each paragraph.

Periods and commas always go inside of the quotation marks; the other marks of punctuation go inside if the marks are a

part of the quotation, outside if they are used as punctuation of the sentence.

1. To show the exact words used by an author.

It is high time that a printer should be able to see more than "a definite series of letters and words."

(This paragraph is set in Bodoni to show the special quotation marks.)

2. Double and single quotations.

Everett R. Currier, in speaking of Will Bradley and his influence on modern typography, has this to say: "His revival of the forgotten practice of letter-spacing has proved a wasteful and pernicious innovation—wasteful on account of the time consumed in inserting space between letters (where it is not needed), pernicious because it gave 'art' compositors a new plaything, and only served to enlarge the hole through which, as employing printers unanimously agreed, the profits from the other departments leaked."

3. Names of books, magazines, poems, and works of art, also the titles of papers, articles, etc.

Have you read Gress's "Art and Practice of Typography"?

He read an interesting paper on "Present-day Tendencies in Typography."

4. To designate unusual, technical, or ironical words or phrases.

If the layout of the job doesn't look "right"—why doesn't it?

When printing one ink over another we sometimes have trouble because the second ink refuses to "take" over the first.

Gutenberg would have been more than human to have foreseen the evolution of his little "cider-press" into the gigantic rotary of the twentieth century.

62. Interrogation Mark (?).—The interrogation mark is said to be a corruption of the first and last letters of the Latin word *Quaestio*, a question, placed one above the other; thus, $\overset{Q}{\underset{O}{}}$.

1. It is used in asking a direct question.

But why is this a pleasing division? Why not some other distribution of space?

How much of this wasted time do you think is charged under the head of "distribution"?

2. After each question in a compound sentence.

How much would it make if set in eight-point type? in nine-point? in ten-point?

3. As a query, expressing doubt.

Gutenberg invented printing from movable types at Mentz (?) about 1440.

63. Exclamation Mark (!). This mark probably owes its origin to the Latin word *Io*, joy, one letter being written over the other; as $\overset{I}{o}$.

1. It is used to denote surprise, emotion, or an outcry.

Oh! How you startled me!

"Help! help!" he cried.

Ah, what a tangled web we weave!

O that I had the wings of an eagle!

2. After interjections, used independently or in sentences.

Oh! Ah! Ouch!

Before the live and the strong flies an angel, crying, "On! On!"

3. After an invocation or command.

Speed our republic, O Father on high!

Still, O my Country, while we may, look back!

Halt! Who goes there?

"Forward, the Light Brigade!

Charge for the guns!" he said."

64. Parentheses ().—When an author wishes to offer an explanation of something which has been said but which is not an essential part of the text, the words are enclosed in parentheses.

The Romans wrote with an iron pen or stylus (whence our word style) on waxen surfaces smoothed over wood.

The lower-case letters, or minuscules (this word, like majuscles, is accented on the second syllable), and the script we use now demand attention.

65. Brackets [].—When one parenthesis occurs inside of another, brackets are used to designate the inner one. This frequently occurs in legal citations, but, inasmuch as nearly every office has its own style, no examples will be given.

1. Matter that is introduced into the text by some one other than the writer should be enclosed with brackets.

As an example of the misuse of the term complementary, I quote from an otherwise excellent article on the use of color on cover stocks: "As the lowering of all colors results in black, and the lightening of all colors results in white, then black and white are the two friendly mediums for purposes of separation [so far, so good; but he adds], as they are complementary [sic] to all colors."

It will be observed that the hyphen [meaning the hyphen in compounds] is less frequently used than in former editions.

2. In reports of speeches, to enclose words explanatory of the emotions of the audience.

While woman may never be elected to Congress, she will continue to be the "speaker of the house." [Laughter.]

3. For folios and to enclose lines designating where articles are continued on or from.

[32]

[Continued on page 132]

[Continued from page 76]

[To be continued]

66. Division of Words.—There is great diversity of opinion among authors and proofreaders regarding the division of words. Some follow the American plan of dividing according to pronunciation, some the English plan of dividing according to derivation. It is a matter of extreme regret that grammarians have not agreed on some definite plan, so that the ordinary layman might feel assured that he is following good usage.

In offering the following rules the author is well aware that the matter is but briefly covered. When in doubt, consult a good dictionary.

1. Words should be divided according to syllables; a syllable being a succession of letters to represent one sound.

con-ster-na-tion

syl-lab-i-ca-tion

2. If the word is one containing a single-vowel syllable preceding the last syllable, divide the word preferably on the vowel, carrying over the last syllable. If it has two vowels, retain both.

mechani-cal, *not* mechan-ical.

approxi-mate, *not* approx-imate.

differentia-tion, *not* differenti-ation.

3. If the last syllable of a word contains but two letters, do not carry it to the next line. If there is room for the hyphen there is usually room for the last two letters.

vocifer-ously, *not* vociferous-ly.

4. In dividing present participles the *ing* should be carried over. If the consonant is doubled on adding the suffix, carry over the second consonant.

smok-ing

din-ing

drum-ming

drink-ing

sit-ting

swim-ming

express-ing (here the consonant has not been doubled; it is part of the original word).

5. Divide a compound word into its elemental words rather than on syllables, unless spacing would be sacrificed to accomplish it.

composing-room, *not* compos-ing-room.

6. Words which have been compounded of two words, and which, from usage, have coalesced into one, should preferably be divided into their original elements.

school-master *is better than* schoolmas-ter.

semi-annual *is better than* semian-nual.

under-estimate *is better than* underes-timate.

7. *Able* and *ible* are always to be considered as the final syllable, and carried over.

consider-able

indestruct-ible

8. Words of one syllable cannot be divided, nor can the plurals of singular nouns even though pronounced as if they were words of two syllables.

horse, horses

inch, inches

fox, foxes

9. The addition of the past tense to verbs of one syllable does not add a syllable. Such words cannot be divided.

drown, drowned

slap, slapped

push, pushed

10. No English word ever begins with an x or ends with a j; therefore, in dividing words containing these letters always keep the x on the upper line and j on the lower.

parox-ysm

pre-judice

The word *prejudice* is an exception to the rule of dividing according to pronunciation. The accent is on the *prej*. The word is from the Latin *pre judice*, to judge in advance, and is used in this form in all legal documents.

11. If the first syllable of a word contains but one letter, do not divide it on the first syllable; carry over the letter.

E-gypt a-mong a-float a-shore

12. When there is a distinction made in the pronunciation of a word to denote its part of speech, the word should be divided according to pronunciation.

pro-gress (v.) prog-ress (n.)
 pro-duce (v.) prod-uce (n.)

13. Never have more than two divisions of words at the ends of contiguous lines.

67. Compound Words.—A compound word is one that is composed of two or more words joined together to express a single idea. The word indicating the idea may be a noun, as in naming a thing, or an adjective, describing the thing named. Sometimes the words are joined together as one word with a hyphen, sometimes without. Just when to use the hyphen and when not is one of the baffling questions for both compositor and proofreader.

Much has been written on this subject, but there is no unanimity of opinion, even among experts. The most comprehensive article that the author has read is embodied in the Standard Dictionary, and is printed on pages 30 and 31 (edition of 1913). It is from the pen of F. Horace Teall, who has also written a book entitled "The Compounding of English Words."

While rules may vary slightly in printing offices, the following may be said to prevail.

1. When joining two nouns together to name an object, and the idea expressed by the object is in the nature of a container, use the hyphen.

hat-box paper-box (a box to hold papers)
 pill-box oil-can

2. When two words are arbitrarily joined together to name an object, they no longer stand in their original relation. Such nouns do not take the hyphen.

bluebell	drumfish	turnkey	steamboat
blackbird	bedroom	redcoat	draftsman
lighthouse	bondman	railroad	goldsmith
blackberry	headache	sailboat	bath tub

3. When joining a participle to a noun to make a new noun, use the hyphen.

sitting-room	printing-press
smoking-room	sewing-machine
gambling-house	boiling-point

4. When two words are joined together to form an adjective preceding a noun, use the hyphen.

still-life studies	so-called magician
high-grade goods	above-named rules
week-old baby	much-used phrase

5. Adverbs that qualify adjectives preceding nouns do not take the hyphen. They do not become part of the adjective, but retain their use as adverbs.

richly dressed woman	freshly picked bouquet
newly married couple	highly prized book

6. Usually (but not invariably), compound nouns are written without the hyphen if either of the words contains but one syllable, with the hyphen if it contains two, as separate words if it contains three or more.

inkman	ink-maker	ink manufacturer
sawmill	powder-mill	chocolate mill
notebook	pocket-book	reference book
icehouse	power-house	business house
pressroom	composing-room	recitation room

7. The present-day tendency is to omit the hyphen in

today	tonight	tomorrow
-------	---------	----------

8. Vice, ex, elect, and general, when part of a title, should be joined to the chief noun with a hyphen.

Vice-President Marshall	the President-elect
ex-President Roosevelt	the postmaster-general

9. It frequently happens that after words have been in use for some time, and we have become fairly familiar with their construction, they change in form, the hyphen finally being dropped.

bookkeeper	proofreader	earmark
newspaper	bloodshed	muskmelon
keyboard	saleslady	shipmate
typewriter	whalebone	yardstick

10. Latin prepositions prefixed to a word do not usually take the hyphen.

antedate	international	postscript
antiseptic	subcutaneous	superfine

11. When two or more compound words have one part in common, that part is omitted from all but the last word, the omission in each case being designated by a hyphen.

The boxes were full of one-, two-, and three-em quads.
 Those tools are used by gold- and silversmiths.

68. Capitalization.—While there are some slight differences of opinion among proofreaders regarding capitalization, the following rules may be considered as meeting the requirements of the average office.

1. Every sentence should begin with a capital.

(See sentences throughout this book.)

2. Every line of poetry should begin with a capital.

Yes, words may sound alike, yet have
 Dissimilar meanings, maybe:
 How different is a weak old man
 From just a week-old baby!

3. All proper nouns and most adjectives derived from proper nouns should begin with a capital.

America	England	France
American	English	French

4. Verbs derived from proper nouns should begin with a lower-case letter.

americanized	boycott
fletcherized	macadamized

5. Nouns or pronouns that designate any member of the Christian Trinity should be capitalized.

Providence (the Deity)	Holy Ghost
Him (God or Christ)	Sun of Righteousness

6. Capitalize the names of states, counties, cities, streets, and parks.

Pennsylvania	Second Street	Zoological Gardens
New York	Fairmount Park	Central Park
Wilkes-Barre	Trenton	Monroe County

7. Capitalize the names of churches, organizations, clubs, societies, and buildings.

First Baptist Church	Pennsylvania Railroad
Daughters of the Revolution	Woolworth Building
Philobiblion Club	Hotel Metropole
Board of Public Education	Girard College
Union League	Philadelphia Rapid Transit Co.

8. Capitalize all geographical names and divisions.

Atlantic Ocean	the Horn	Rocky Mountains
Gulf of Mexico	the West	Rio Grande
Keystone State	Occident	Delaware River
Cape May	Orient	the Peninsula
Straits of Gibraltar	North Pole	Western Hemisphere

9. Capitalize the various epochs, important events, holidays, treaties, acts, and bills.

Middle Ages	Declaration of Independence	Hay Treaty
Renaissance	Fifteenth Amendment	Stamp Act
Revolution	the Civil War	Magna Charta
Memorial Day	Thanksgiving Day	Fourth of July

10. Capitalize titles and academic degrees.

President Wilson	Prince of Wales
the President (of the U. S.)	Joseph Smith, D.D., LL.D.
Rear-Admiral Dewey	Philip Guernsey, M.D., Ph.D.

11. Capitalize the word "city" only when part of the corporate title.

Twin City	Jersey City
I shall sue the City of Philadelphia.	
The city of Philadelphia covers an area of 132.7 square miles.	

12. Capitalize the titles of books, papers, magazines, articles, etc.

The Inland Printer	The American Printer
The House of the Seven Gables.	
The Graphic Arts and Crafts Year-Book.	
Photogravures and Their Value to the Commercial World.	
Printing Instruction in the Public Schools.	

13. Capitalize the seasons only when they are personified.

The poet speaks of Winter, with his icy blasts.	
Then comes Summer, clad in her garb of green.	
We have had a severe winter.	
I met him last summer.	

14. Always capitalize the pronoun "I" and the interjection "O."

69. Printing-office Style.—The journeyman printer who migrates from one office to another soon learns that there is no uniform style existing in all offices. In offering the following

list the author feels that he is presenting the usage of the best printing houses.

Omit periods from headings and at the ends of display lines, unless denoting an abbreviation.

Do not use periods after Roman numerals. They are not abbreviations.

The abbreviation lb. for pounds comes from the Latin *libra*, the plural of which is *librae*. Therefore, lb. should stand as the proper abbreviation for both singular and plural.

Do not use spaces between initials in abbreviated titles. M.D., Ph.D., A.B., LL.D.

Never use the word "river" in names containing the word Rio; Rio means river. Rio Grande, not Rio Grande River.

Never use the word "mountains" in words containing the word Sierra; Sierra means a saw-like range of mountains. Sierra Nevada, not Sierra Nevada Mountains.

The word *Saviour*, meaning Jesus Christ, should be spelled with a "u"; if it has any other meaning, make it lower-case and do not use the "u."

All singular nouns in the possessive case take the apostrophe and s: Jones's wagon, Smith's store. All plural nouns ending in s take the apostrophe after the s: boys' clothing, girls' shoes. If the plural is not made by adding s, but by changing the form, then add the apostrophe and s: men's hats, children's toys. If the singular possessive ends in s, and the succeeding word begins with s, or where there is a succession of s sounds, then the possessive does not take the s: for conscience' sake, for Jesus' sake, for goodness' sake.

Never allow a succession of the same word at the end of more than two lines. If a series of small words occurs at the ends of successive lines, and gives the effect of the words standing apart from the text, break up this succession by driving over an occasional word. In some offices the rule is to prevent more than two punctuation marks of any kind from coming in succession. If much time and labor would be entailed in preventing this, it is better to save the time and pass the marks.

A.M. and P.M. look best when set in small capitals. If there are no small capitals to the font, put them in capitals if the line is capitalized, in lower-case if the line is in lower-case. If the abbreviations are in capitals do not use a space between the A. and the M., but use a thin space between the P. and the M. This latter is to keep the period closer to the P than to the M. If the abbreviations are in lower-case, leave out the space.

Per cent, the contraction for the Latin *per centum*, is now a fully anglicized term. The modern tendency is to leave off the period. Another decade may witness the full coalescence of the two words, for the beginning is already in evidence. Percent is just as good a word as percentage, and is frequently found in print.

The short "and," or ampersand, had its origin in the old Latin manuscripts. The Latin for "and" is *et*, an early form being written *Et*. By a process of evolution, the early scribes developed it into the ligature *Et*. To-day we have many beautiful forms of this character, but they are only suited to job composition, and should not be used in ordinary book work. The ampersand should be used only in firm names, as Straw-bridge & Clothier, Wanamaker & Brown.

It is the rule in many offices to spell out all numbers under one hundred, and put in figures all over one hundred. If the text is full of numbers it is better to put them all in figures.

Amounts of five or more figures take the comma: 12,622, 272,976. Amounts of four figures do not take the comma, unless in column formation, when the comma should be used to keep them uniform with amounts of five figures.

When using a dollar mark at the head of a column of amounts place the mark alongside of the figure on the first line in the dollar column. If there is no figure in the dollar column, use a cipher. When the column has been totaled, add the dollar mark to the total amount. *Do not use the mark on each line.*

While rules for indenting paragraphs may differ in printing offices, it is conceded that indenting according to the following will produce a pleasing appearance: for measures up to and

including eighteen ems of pica, indent one em of the body in which the type is set; for nineteen to twenty-four ems pica, one and a half ems of the body; from twenty-five to thirty ems pica, two ems of the body. This applies to sizes from eight- to twelve-point. Larger sizes take less space, smaller sizes take more.

Indent poetry according to rhyme. If a few short lines occur, they should hang in about three ems.

My country! 'tis of thee,
Sweet land of liberty,
Of thee I sing!
Land where my fathers died!
Land of the pilgrims' pride!
From every mountain side
Let freedom ring!

BIBLIOGRAPHY

- Punctuation*, by F. Horace Teall.
The Compounding of English Words, by F. Horace Teall.
Correct Composition, by Theodore L. De Vinne.
Proofreading and Punctuation, by A. M. Smith.
Manual of Style, The University of Chicago Press.
Article on compounding of words, *Standard Dictionary* (1913 ed.),
pp. xxx, xxxi.

CHAPTER VI

TYPE FACES

70. General Classification.—Before proceeding to a study of job composition, it is very essential that the student learn something of the general characteristics of job faces. The first impression that one receives when set adrift in a large printing office is that he will never be able to differentiate the various type faces. The task is really not such a difficult one, after all. As a matter of fact, every type face comes under one of five general headings—text, gothic, roman, italic, or script.

71. Text.—At the time of the invention of printing from movable types, the first letters cast were imitations of the hand-lettering then prevalent in the monasteries. This style of type is now known as *text* or *black-letter*. Most authorities agree that it really should be called *gothic*, doubtless owing to its

This line is set in

24-Point Cloister Black

possessing those pointed characteristics so prevalent in Gothic architecture. The same authorities also contend that the type face known as gothic should be called *black letter*. It is called “sans-serif” by some English founders.

The term black-letter is derived from the fact that when the letter is printed in mass formation, the whole tone is black. The early manuscripts were not set off in paragraphs, but the break in thought was designated by an ornament. There were no break-lines throughout the text.

As the text letter has come to us from ecclesiastical sources, it seems to be the most logical letter to use for such purposes.

72. Gothic.—Our present-day gothic bears a very strong resemblance to the letter used by the ancient Romans on their stamps and coins. Such letters are devoid of serifs.

This line is set in

12-PT. LINING GOTHIC No. 45

73. Roman.—The Roman alphabet was evolved from the Phœnician and Greek alphabets, and originally consisted of capital letters only. The small or lower-case letters are corruptions of the capitals, and came into use during the eighth century.

The Roman style of lettering was used by the Latin scribes in preparing manuscripts, and by the stone-cutters for inscriptions on buildings and tablets. It is much used in present-day architecture, and the V, the old form of the capital U, is still in evidence.

This line is set in

22-Point Old-Style

This line is set in

24-Pt. Bodoni

The first successful roman type face was cut by Nicolas Jenson, at Venice, in 1471. This has served as a model for later productions. Books printed by Jenson in 1470 do not contain the letters J, U, and W, these characters being added to the alphabet several years later. Where the force of w was required, two v's were set side by side. This does not often occur in Latin. The old form of the cap U was V, and from this was derived the double U, or W.

The fact that the letters J and U are not alphabetically arranged in our cap cases would seem to signify that the cap case has undergone no change in arrangement since the days of Jenson. Also that the W was added before the J and U.

74. Italic.—The slanting or italic letter (so named in honor of Italy) was introduced by Aldus Manutius. It was patterned after the handwriting of Petrarch, an Italian poet.

When italic type was first made there were no capitals to the fonts, so roman capitals were used with italic lower-case.

This line is set in

18-Point Old-Style Italic

75. Script.—Script types also owe their origin to imitations of handwriting. This style of letter is restricted to printing that is of a social nature.

This line is set in

24-Point Bank Script

76. Old-style.—Roman type faces are subdivided into *old-style* and *modern*. Old-style faces were in vogue from 1469 until 1783, their strong, bold, rugged characteristics being especially adapted to the rough, hand-made papers then in use. They were displaced in public favor for awhile, but have gradually come back. At the present time they are again in demand, and the major portion of our most artistic productions are in this face of type.

Not only are old-style faces in favor among typographers, but artists in hand-lettering are producing many beautiful examples to grace our typographical journals. Frederic W. Goudy, of New York, has designed many noteworthy faces, and quite a few of them have been cast in type. Mr. Goudy has made a special study of the old masters.

SENATUS · POPULUSQUE ·
 ROMANUS · DIVO · TITO ·
 DIVI · VESPASIANI · F · VES ·
 18 POINT FORUM TITLE [PATENTED]

WHEN THE DECLARATION
 of Independence was under consid-
 eration by Congress, there were two
 18 POINT NO 2. KENNERLEY

FOURSCORE & SEVEN Years
 ago our fathers brought forth on this
 continent a new nation, conceived in
 18 POINT NO. 2 KENNERLEY ITALIC

Type Faces Designed by Frederic W. Goudy.

Where maximum of legibility is required, old-style faces will be found superior to modern. This is due to the fact that the minor elements (hair-lines, so called), are heavier in the old-style design.

The chief difference in modern and old-style (or "old-face," as it is commonly called in England) lies in the matter of *proportion*, both being substantially the same in form. In old-style there is greater variety in the widths of individual letters, the thickening of the curves in the round letters not being in the center of the curves as in the modern, but above and below the center according as it occurs on the right or left. These curves are not geometrical, but carefully considered quantities, giving a character to the letters which no mechanical construction can possibly impart.

77. Modern.—In 1783 Bodoni designed the modern roman. It was welcomed by printers as an innovation, and it marked the end of three centuries of old-style monotony. While old-style has regained favor for display work, the modern roman is still used for newspapers, dictionaries, encyclopædias, and scientific books.

This line is set in Bodoni

This line is set in Scotch-face Roman

Specimens of Modern Type Faces.

78. The Serif.—It will be observed that the letters in three of the five groups into which type faces have been divided have small projections at the top and bottom of the letters. These projections are known as *serifs*. See Fig. 29, which also shows

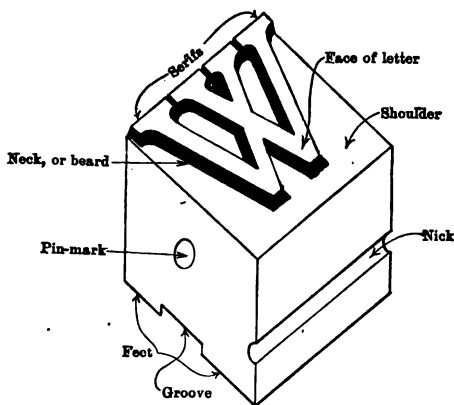

FIG. 29.—Showing the Various Parts of a Type.

the various parts of a type. Authorities claim that the serif probably had its origin in the necessities of the old stone-cutters, who could not cut a V-shaped letter in stone and still have the ends clearly defined. To admit light into the dark recesses, a sloping chisel-cut was made, thus adding the serif. This addi-

tion of the serif not only made the letter more readable, but gave a distinct characteristic to it. A study of type faces reveals the fact that the serif is really the dominating feature of the letter, and that one type face can be turned into another, simply by altering the shape of the serif.

In an extremely masterful article, printed in "The Graphic Arts" for March, 1911, Henry Lewis Bullen showed how he had set a line of gothic type of normal weight of line and width of body and had it photographed. He had ten prints made from this model. To each of these models a different serif was added, thereby producing ten entirely different faces of type. The student is urged to read this article, for the author believes it to be a most valuable contribution toward the study of type faces.

79. Old-style and Modern Serifs.—That the student may readily perceive the difference in the two forms, the old-style and modern serifs are here compared.

A B C D E F G H I J K
 L M N O P Q R S T
 U V W X Y Z
 a b c d e f g h i j k l m
 n o p q r s t u v
 w x y z

Fourteen-point Caslon Old-style.

A B C D E F G H I J K
 L M N O P Q R S T
 U V W X Y Z
 a b c d e f g h i j k l m
 n o p q r s t u v
 w x y z

Fourteen-point Bodoni

Observe that in the old-style the serifs are all oblique or sloping, whereas in the modern they are all straight and lighter in weight. Note that all terminations are oval in the old-style and round in the modern. It will be seen that the finials in the a's and t's of the old-style turn out, while the modern ones turn up. The capital E's and T's of both groups are radically different. These are but a few of the distinguishing features. The student should critically contrast these two faces and note their differences. See also Fig. 30.

Owing to the fact that these two roman letters have radically different characteristics, it is considered bad

typography to use them both in one type composition.

Old-style and modern letters are cut in both roman and italic.

80. Other Groups.—Mr. Bullen further subdivides roman letters into two groups—*Display Types* and what he calls *Publicity Types*. The first includes all so-called fancy or ornamental letters and such faces as antiques, ionics, latins, job faces, etc., which are unsuited for setting in page form. The second includes Cheltenham, Della Robbia, Pabst Oldstyle*, and Bewick Roman, and are those letters unsuited for book work, but very appropriate for books of luxury and for commercial publicity.

81. Cheltenham Oldstyle.—At this writing, typefounders seem to be vying with each other in the production of letters of the publicity group. Cheltenham Oldstyle was one of the first to be produced. Just why the word Oldstyle was added to the name is conjectural, for the letter is lacking in the strongest of the old-style characteristics—it has straight instead of



Caslon Old-style,
1727

Bodoni Modern,
1818

FIG. 30.—Showing Differences in
Old-Style and Modern Serifs

* The term "old-style" is used in three different ways by typefounders—Old Style, Old-style, and Oldstyle. The American Type Founders Company uses Oldstyle as one word, consequently in naming their products the name is so given. The author prefers old-style.

sloping serifs. The form of the serif is well worthy of study. Fig. 31 shows a capital R. Notice the rounded ends and also the rounded brackets of the serifs.

R

FIG. 31.—A Capital R of Thirty-six-point Cheltenham.

This paragraph has been set in Cheltenham to show the long ascenders so characteristic of this family group.

82. Clearface.—From time to time experiments have been made to ascertain just what features of a type face were strongly conducive to legibility; the object of these experiments being to incorporate these features in one type face and produce a letter of maximum legibility.

Such an attempt on the part of L. B. Benton and his son Morris has resulted in the production of the type face known as Clearface. A comparison of this letter, which is an old-style, with other old-style types shows many advantages in its favor. In so far as possible, each lower-case letter has been cast so as to present an equal amount of white space on each side, and the letters a and s have been opened up so as to introduce white space and make them more legible. The general effect of Clearface is that it presents a uniform amount of white throughout the line. The resultant legibility is particularly noticeable in the smaller sizes.

This line is set in Ten-point Clearface

83. Type Families.—It has not been many years since the average piece of job composition contained a multitude of in-harmonious type faces. This was due, in part, to the fact that type designs did not run the whole gamut of form from an extremely condensed letter up to an extremely extended one. The necessity for typographical "hash" no longer exists, for type faces are now cast in "families." That is, the facial char-

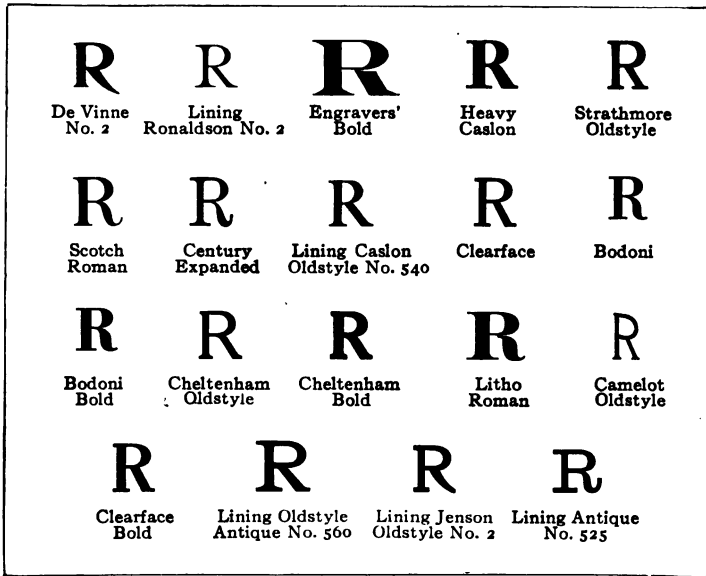

Specimens of type faces cast by American Type Founders Company.

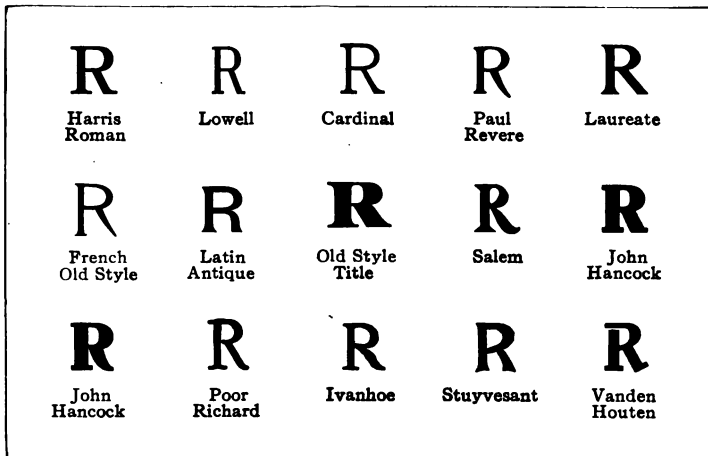

Specimens of type faces cast by Keystone Type Foundry.

FIG. 32.—Comparison of Type Faces.

acteristics of the letter prevail throughout all the different sizes and forms. Consult any typefounder's specimen-book and examine the family groups.

84. "Pi" as an Aid to Type Study.—The average compositor is rather prone to toss into the quad-box the occasional *wrong font* that he finds misplaced in a case. Not only does this litter the case, but it keeps that particular *sort* out of its useful and proper place. The sorting of *pi* is a valuable aid to the study of type faces, for in the process of locating the letters the student may have to analyze every type face in the office. Do not leave wrong fonts in a case; put them where they belong.

85. Comparison of Serifs.—On page 81, Fig. 32, will be found a number of letters showing different forms of serifs. Make a comparison of them, and endeavor to pick out those possessing old-style features. Note that it is the formation of the serif, the shape and inclination of the final stroke, and the relative thickness of the major and minor elements that give each letter its distinctive characteristics.

Pick out those of modern form.

86. Swash Letter.—Quite a number of the latter-day fonts of italic type have capital letters with ornamental projections. These are known as *swash letters*.

A k R G z M

QUESTIONS ON CHAPTER VI

1. Name the five different headings under one of which each type face must fall.
2. Describe the main characteristics of each of the five groups.
3. How can you distinguish old-style from modern?
4. Why was italic type so called?
5. Is gothic type properly named?

6. Why was script type so called ?
7. When and by whom was modern roman first cut ?
8. What noteworthy features can you point out in the specimens of Bodoni and Scotch Roman shown on page 77 ?
9. Is your favorite newspaper printed in old-style or modern ?
10. Is the text of this book printed in old-style or modern ?
11. What is a serif ?
12. What influence has a serif on the appearance of a type face ?
13. What is the supposed origin of the serif ?
14. What are the predominating features of Cheltenham Oldstyle ?
15. Why is Clearface so called, and what object did its inventors hope to attain ?
16. What do you understand by a type "family" ?
17. What advantages are to be derived from sorting "pi" ?
18. Set up a line of cap E's of 24-point light-face gothic, spacing the letters $\frac{1}{2}$ inch apart. Add serifs of different kinds to these samples and note how different faces are produced.

CHAPTER VII

JOB COMPOSITION

87. General Survey of the Field.—Job composition is that branch of typesetting which embraces the assembling and arranging of display letters. It calls for considerable knowledge and skill on the part of the compositor, and in return offers splendid opportunities to men of artistic temperament. There is a strong fascination about the work, and the accomplishment of a perfect piece of printing affords much satisfaction.

Skill of no mean order is required to analyze a piece of manuscript and from such analysis to plan and work up into type a piece of composition pleasing in form, nicely grouped, properly spaced, and with all its elements in perfect harmony as regards type, color, mass, and appropriateness. This is the ability that every compositor should possess. That every compositor does not possess it, however, is evidenced by the fact that in many large printing offices an expert known as a *layout man* is employed to do all the planning, leaving the actual setting of the type to the ordinary workman.

88. The Layout Man.—It is the duty of the layout man, the “typotect” (typographical architect), to prepare a plan of the job (known as a layout), and show thereon just what groupings are to be made, and what kind and sizes of type are to be used. The typotect is usually the best-paid man in the office, and the student is urged to try to measure up to the requirements of the typotect’s job, and not be satisfied with being simply a workman of mediocre ability. Of course, this means constant study, but it also means time well spent, for increased opportunity and better remuneration are bound to follow.

89. Fundamental Principles.—Before proceeding with the actual setting of a job, it is essential that the student should have some knowledge of the fundamental principles underlying correct composition. These principles are discussed under these subject-headings: Optical Center, Balance, Harmony, Tone, Contrast, Appropriateness, Grouping, and Proportion.

90. Optical Center.—It is conceded by all artists that the optical center of a composition is not at the geometrical center, but is slightly above it. Anything placed in the exact center of a page has the appearance of being below the center. This is an optical illusion. A familiar example of optical illusion is seen in the letter *s*. The upper bowl of the letter is smaller than the lower, yet they appear to be the same size. If the *s* is inverted so that the larger part is on top, the discrepancy is quickly noted.

Two eminent typographers are at variance regarding the optical center of a page. Gress says it is three-ninths of the distance from the top, Trezise says three-eighths. The author favors three-eighths. (See Panel Grouping.)

91. Balance.—According to the law of levers, a heavy weight on a short arm can be balanced by a light weight on a long arm. The balancing of type groups on a page or in a piece of composition follows the same law. If the groups around the optical center of the page are arranged in such manner that the size or apparent mass-weight of each group is inversely proportional to the distance from the optical center, the composition will be properly balanced. Figs. 33 and 34 show two pages, one properly the other improperly balanced.

It will be observed that the upper group in Fig. 33 is apparently about five times as heavy as the lower group, therefore the lower group is placed five times as far away from the optical center. This same principle of balance prevails in every piece of composition regardless of size or shape. When a mass is placed out of the center it requires something diametrically opposite to balance it.

MONEY ISLAND
YACHT CLUB

Annual Regatta
July 8, 1916

Music and Refreshments
at the Club House during the evening
Everybody invited

FIG. 34.—Type Too Large for Page. Lines too long. Not enough margin alongside of Annual Regatta. Too close to top and bottom.

MONEY ISLAND
YACHT CLUB

Annual Regatta
July 8, 1916

Music and Refreshments
at the Club House during the evening
Everybody invited

FIG. 33.—Well Balanced and Well Grouped. Main subject matter arranged around the optical center.

92. Harmony.—The Century Dictionary defines harmony as “any arrangement or combination of related parts or elements that is consistent or is esthetically pleasing; agreement of particulars according to some standard of consistency or of the esthetic judgment; an accordant, agreeable, or suitable conjunction or assemblage of details.” All the various harmonies (shape, tone, color, etc.) spoken of in printing conform to these definitions. When there are no discordant elements in a piece of composition there is perfect harmony. Harmony should be uppermost in the mind when planning a job.

Owing to the radical difference in the characteristics of old-style and modern roman type faces, these two styles should never be used in one piece of type composition. They do not harmonize. If a compositor adheres to one type family in setting a job, he is bound to have perfect harmony in type faces.

While text letters and gothics are of radically different cut, they may frequently be used together in a pleasing manner; especially if the text letter be used as the main, strong line of the job, and the gothic be subdued.

93. Tone.—All type, rules, border, and ornamentation in a job should be uniform in tone. That is, if the general effect of the job is heavy in tone, then the rules, border, and ornaments should be heavy; if the general effect is gray, then the rules, etc., should be gray; if very light in tone, then everything should be light. Figs. 35 and 36 illustrate this point. In Figs. 37 and 38 the type lines have been transposed, thus showing how a job may be spoiled by a lack of tone harmony.

94. Contrast.—The major portion of present-day printing has to do with advertising. In all advertising the object is to call attention to certain articles which are for sale. Each advertiser has his own idea as to how the subject matter should be placed before the reader in order to influence the sale. Many advertising campaigns have been dismal failures because the advertising matter has not been properly presented. All large business concerns employ advertising men who plan and prepare copy for the printer. In numerous cases, however, adver-

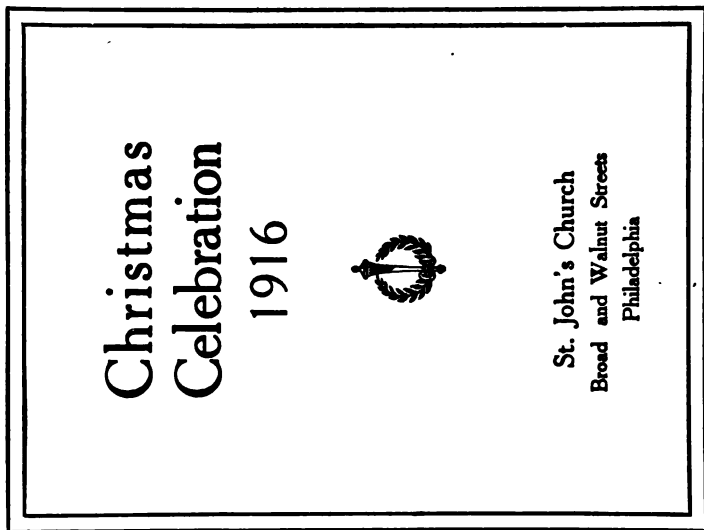

FIG. 36.—Type and Border in Harmony, but Type not as Appropriate as in Fig. 35.

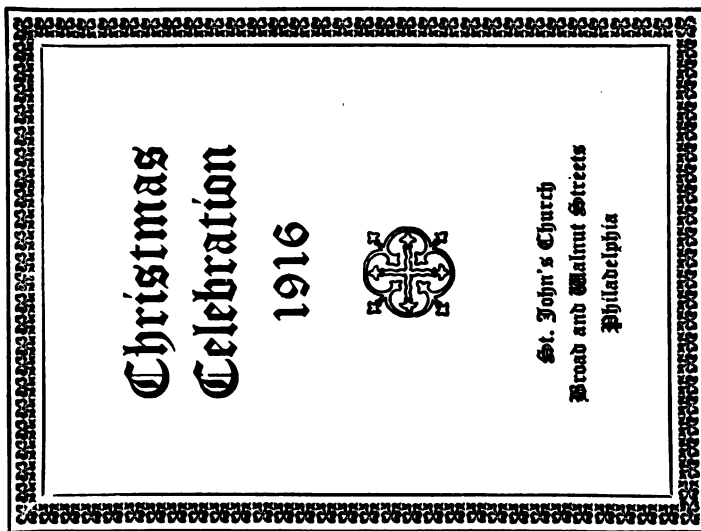
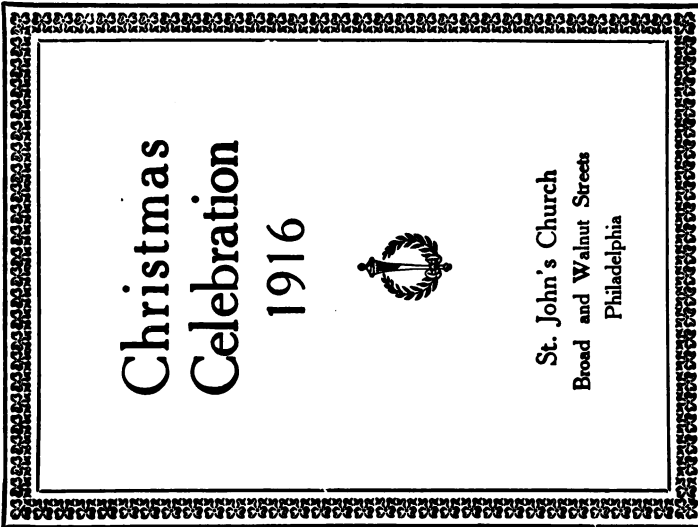
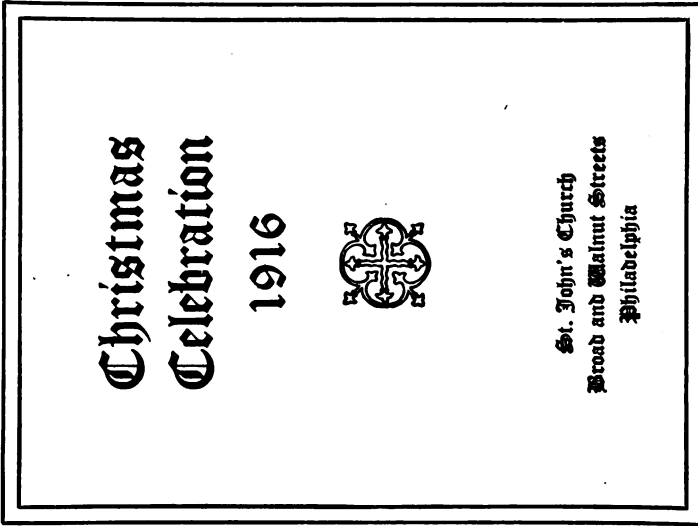

FIG. 35.—Type and Border in Harmony, with Type Especially Appropriate to Subject.



Figs. 37 and 38.—Type and Borders do not Harmonize Either in Tone or Structure.

tising matter reaches the printer in manuscript form, and he must analyze and plan his own job.

In every well-displayed piece of printing there is one item that stands out above all others. This is the main display line. It stands out by virtue of *contrast*. It is either bigger or bolder than the rest of the job; sometimes it is both. Compositors frequently make the mistake of having their lines too nearly uniform in size to obtain contrast. A single line standing alone in a large, white space is very obtrusive. If surrounded with type matter of its own size it becomes lost. Display matter is usually at its best when surrounded by white space. *Do not crowd the matter.*

When planning a job, the compositor should endeavor to display it in type sizes that bear a true relation to the importance of the matter. In Fig. 33, which is a well-balanced job, it will be seen that the relative importance of the parts of the subject matter has been brought out in this way.

Black ink on white paper affords the strongest possible contrast. If contrast is desired with colored ink on colored paper, heavier faced type must frequently be used to obtain it. The compositor should consider stock and ink when planning his job.

95. Appropriateness.—Appropriateness is the *sine qua non* of correct composition. No matter how well grouped or well balanced the job, no matter how perfect it may be in all its other elements, if it is not appropriate to the subject it is a failure for the purpose intended. There are certain things in typography that may be called unwritten laws. One of the most important of these is that the type used in a job should be appropriate to the subject. Heavy-faced types are appropriate in printed matter for the iron and steel industry, but extremely out of place in millinery advertising. The latter requires dainty, light-faced types.

There is a series of display faces, called by Bullen "Publicity Types," that are extremely useful for advertising purposes. There is also another group adapted to *editions de luxe*. (See Section 80, page 79.)

Inasmuch as text letters are of ecclesiastical origin, they are always appropriate in printing that is to be used for church purposes.

96. Grouping.—Many composers make the mistake of sprawling their jobs all over the page, the subject matter thereby lacking cohesion. This is radically wrong. In planning a piece of composition the copy should be analyzed and the various elements separated into units or groups. Figs. 39 and 40 show two examples of grouping; they require no comment.

97. Panel Grouping.—According to Trezise, in planning a panel grouping consisting of two parts the page should be divided into eighths, apportioning three-eighths to the upper panel and five-eighths to the lower panel (see Fig. 41), because, as he says, “the small part is to the large part as the large part is to the whole; thus producing an exact ratio.”*

The ratio three to five does not fulfil the rule given. Three is not to five as five is to eight; but

$$3 : 5 :: 5 : 8\frac{1}{3}$$

$$\frac{5 \times 5}{3} = 8\frac{1}{3}$$

In fact, the factors of a *true* proportion are incommensurable. A close approximation, however may be had by assuming high factors for the ratio.

$$a : b :: b : a + b \quad a + b = 8$$

$$\text{assume, } 89 : 144 :: x : 8$$

$$\text{solving, } \frac{89 \times 8}{144} = 4\frac{9}{8} \quad \text{as } x = b, b = 4\frac{9}{8}$$

$$\text{therefore } 3\frac{4}{2} : 4\frac{9}{8} :: 4\frac{9}{8} : 8$$

* See “The Graphic Arts and Crafts Year-Book for 1913-1914,”
Typography, page 33.

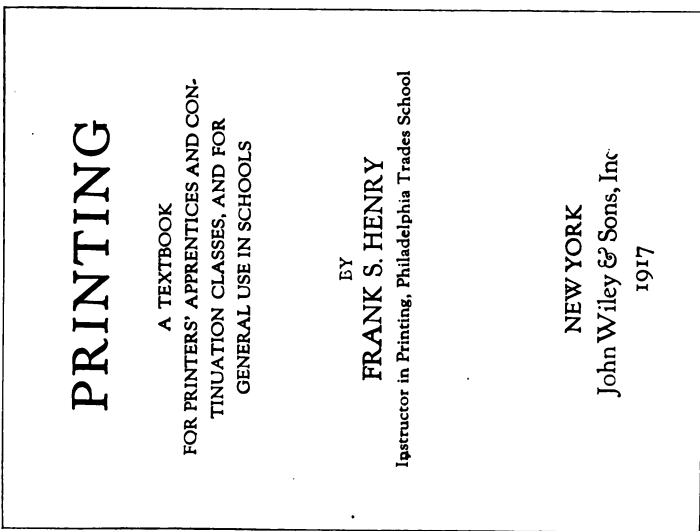

FIG. 39.—A Well-balanced Page.

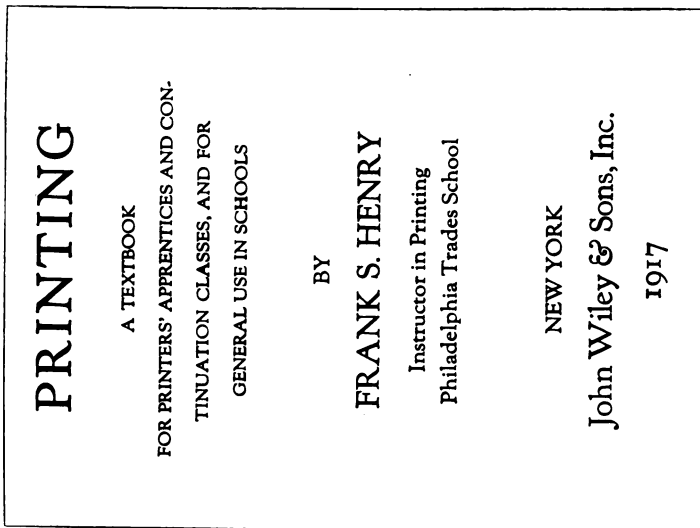

FIG. 40.—Sprawled All Over the Page.

PRINTING *as a*

Means *of* Education

Excerpts from a copyrighted article by Miss KATHARINE M. STILLWELL, in "The Inland Printer" for June, 1916.

FOUR and a half years ago there were in use only fifty-seven school printing outfits in the United States. Today over nine hundred teachers are teaching printing in as many schools and shops. The value of their equipment runs into thousands of dollars, and the marvelous response, both in numbers and in enthusiasm, which greeted the call for this organization testifies, as nothing else could, to the educational interest in this subject.

It is well, I think, that we should pause in this point in our progress, for this occasion marks a stage in our history, and consider what this phenomenal growth means. How much of it is the result of the popular cry for trade schools, vocational training, and industrial education? What part, if any, is due to the inherent educational value that lies in the subject itself?

FIG. 41.—Panel Grouping.

Showing use of 3-point bevel-face rule. The bevels have been placed toward each other, leaving the 1-point face outward in each case. Inside and outside miters have been used in making the corners. The upper panels are approximately three-eighths of the length of the page.

This gives $3\frac{4}{7}$ parts to the upper panel and $4\frac{2}{3}$ to the lower. If the dimensions were in inches this would place the dividing-line four points lower than three inches.

Inasmuch as true art is not based on mathematical accuracy, the dimensions given by Trezise are sufficiently close, but they are not in *exact* proportion.

This ratio is the so-called "golden ratio" of Greek art.

98. Mass Grouping.—In planning groupings it is sometimes found that a small, dark mass must be balanced against a large; gray mass. In such cases, the placing of these masses should follow the law of levers, each group being considered according to its apparent mass-weight, and correspondingly balanced around the optical center.

99. Proportion.—There is a variance of opinion among typographers as to what constitutes a true proportion in a type page; that is, what relation the width of the type should bear to the length. Some say that the width should be to the length as eight is to twelve. Others say that the diagonal should be twice the width. The pages of this book follow the last named. They are twenty-two picas wide and forty-four picas diagonally from the folio to the other corner. If it is desired to determine how long any page should be to conform to the diagonal method, the length may be found by multiplying the width in picas by 1.7321. $22 \times 1.7321 = 38.1$ picas, the length of this page.

A display of high-class printed matter was made in Philadelphia recently at which the samples were all chosen as models of their kind. The author made quite an extended search to find whether any uniformity of relation between width and length of the printed area was shown, but could find none. A search through the Philadelphia Public Library revealed the same lack of uniformity. It is undoubtedly true that art can never be reduced to mathematical proportions. There are some shapes and forms, however, that always afford pleasing proportions, and the more nearly we conform to those shapes the more certain we are of success. Occasionally some expert typographer will apparently violate all the rules of art and

produce a pleasing result. No one but a true artist can do it, and the average man is advised not to attempt it.

100. Table of Proportions.—It is evident from a study of the subject of type proportions just given that typographers have not agreed on any standard. This brings up the question, Is it possible to formulate a table of good proportions?

It is conceded that when a page is narrow its length can bear a greater ratio to its width than when the page is broad. This being the case, why not arrange proportions according to a gradually varying ratio—say in multiples of five? Taking this as a basis, and using multiplying factors that decrease for each five picas increase in width, and arranging them in quarter ems of pica, Table V is obtained.

TABLE V.—RELATION OF WIDTHS AND LENGTHS

Multi- plying Factor 1.8		Multi- plying Factor 1.75		Multi- plying Factor 1.7		Multi- plying Factor 1.6		Multi- plying Factor 1.5		Multi- plying Factor 1.4		Multi- plying Factor 1.3		Multi- plying Factor 1.2	
Width.	Length.	Width.	Length.	Width.	Length.	Width.	Length.	Width.	Length.	Width.	Length.	Width.	Length.	Width.	Length.
10	18.00	15	26.25	20	34.00	25	40.00	30	45.00	35	49.00	40	52.00	45	54.00
11	19.75	16	27.50	21	35.00	26	41.00	31	45.75	36	49.75	41	52.50	46	54.25
12	21.50	17	29.00	22	36.00	27	42.00	32	46.50	37	50.50	42	53.00	47	54.45
13	23.00	18	30.50	23	37.25	28	43.00	33	47.25	38	51.00	43	53.50	48	54.65
14	24.75	19	32.25	24	38.75	29	44.00	34	48.00	39	51.50	44	53.75	49	54.85

In the preparation of this table the length at the head of each column was determined by multiplying its width by the multiplying factor, then the intermediate length between that and the succeeding column was divided into five parts, in the nearest measure to quarter ems. This was done for all columns except the last, where a slight variation was made in order that a fifty-pica width would come out fifty-five picas long. This should prove close enough for all practical purposes.

Fig. 42 is a graphic representation of the resultant proportions. The dimensions are in picas, but the diagram is slightly less than half size. The figures down the left-hand side show the differences in picas between the different lengths.

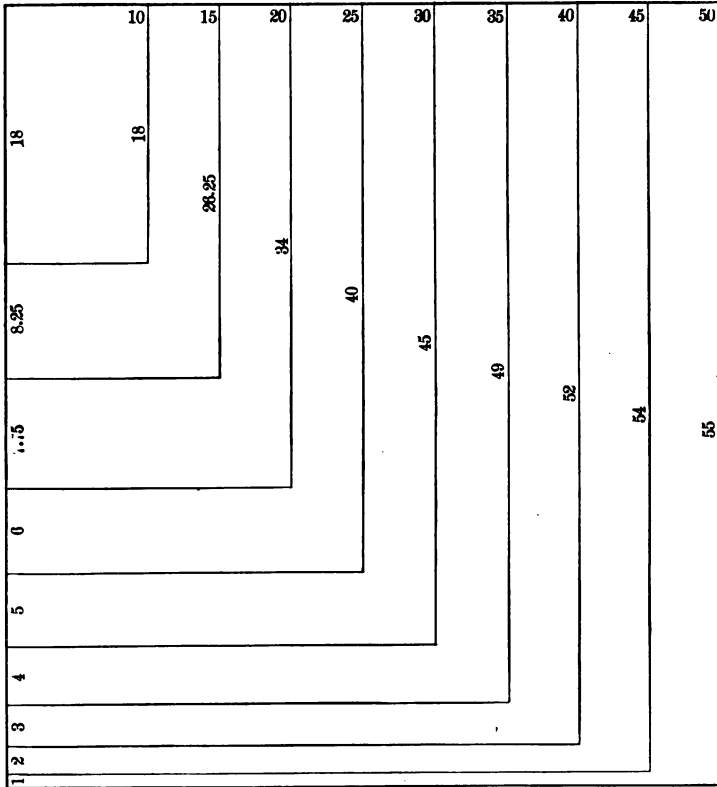

FIG. 42.—Graphic Representation of Proportions.

101. Standardizing Proportions.—Mr. W. R. Colton, in the January 20, 1916, issue of "The American Printer," has an interesting article on standardizing proportions for the size of the *paper* (not type) used in books and other printed matter.

He points out the fact that four different oblongs have, from time to time, been in use by printers. He presents them mathematically and algebraically as follows:

Printers' Oblong, 57.73%, or $3a^2 = b^2$;

Regular Oblong, $66\frac{2}{3}\%$, or $1\frac{1}{2}a = b$;

Golden Oblong, 61.8%, or $a : b :: b : a + b$;

Hypotenuse Oblong, 70.71%, or $2a^2 = b^2$.

The percentage given with each means that the width is to the length as the percentage given is to 100.

He calls attention to the fact that with the Hypotenuse Oblong the ratio is not changed by folding. That is, if we take a sheet of paper of any size whatever and have its width 70.71 per cent of its length, and fold the sheet in half, its dimensions still bear the same ratio—70.71 to 100. No matter how many times the sheet is folded, the same ratio of width to length remains.

While the folding of the sheet does not affect the proportion, just as soon as the page is uniformly trimmed (say $\frac{1}{4}$ or $\frac{1}{8}$ inch all around), it no longer possesses the same proportion. If it is desired to retain the proportion 70.71 to 100, the page must be specially trimmed to properly computed amounts for the width and length respectively.

The process of determining the percentages given above or of determining actual dimensions when percentages are not known, all involve extraction of square root. This process frequently consumes considerable time, and is not to be recommended for shop practice. The giving of the proportions on a percentage basis is a step in advance, but even percentage is confusing to some people.

In the teaching of mathematics to printers' apprentices, the author has worked out many problems involving well-proportioned pages, and has evolved a simple method of determining

them. If it is once determined what length any oblong should have in relation to its width, the length divided by the width gives a *multiplying factor*, or constant, from which the correct length for any given width is quickly found by simply multiplying the width by the multiplying factor to obtain the length.

The following are the multiplying factors for the different oblongs:

Printers' Oblong, 1.7321;

Regular Oblong, 1.5;

Golden Oblong, 1.6181;

Hypotenuse Oblong, 1.4142.

With a width of six inches the lengths are therefore:

Printers' Oblong, $6'' \times 1.7321 = 10.3926''$ long;

Regular Oblong, $6'' \times 1.5 = 9''$ long;

Golden Oblong, $6'' \times 1.6181 = 9.7086''$ long;

Hypotenuse Oblong, $6'' \times 1.4142 = 8.4852''$ long.

102. Borders and Ornaments.—There is diversity of opinion regarding the use of a border on a page. Some contend that printed matter requires no embellishment; that the text, be it body type or display, serves its purpose better if unornamented. The extreme simplicity of some jobs gives them a dignity that would be marred by embellishment. Again, there are others that have been made beautiful, appealing, and forceful by *judicious* ornamentation. But, beware of over-elaboration. A title-page or booklet cover containing but few lines usually looks better if placed within a border, which serves, in a sense, to hold the job together.

Our ideas of ornamentation are evidently a heritage, for the hand-written books of the early scribes were profusely ornamented. The tendency toward ornamentation seems to become

marked at recurring periods of varying length, each of which reaches a period of delirium, only to be followed by a decadence until a point of extreme simplicity is reached. The keynote of modern composition is simplicity; the day of over-elaborate ornamentation has undoubtedly passed.

Ornamentation to be effective must be in perfect harmony with the rest of the job. It must match the job in tone and shape, and be appropriate to the subject. If the general configuration (type, spacing, grouping) of the job is square, a square ornament offers the best shape harmony; if it be irregular in outline, a rounded or pyramid form is better. Pyramid ornaments usually look better if inverted.

103. Initials.—An initial may be considered as part of the ornamentation of a job, and should conform to all the rules given under that subject. If the text and initial are in one color, they should harmonize in tone and general conformation. If the initial is to be printed in a different color, it may advantageously be a little heavier; the tone, however, being conserved by a judicious use of color.

The word of which the initial is a part should be set in capitals. If it is a word of less than three letters, the next word should also be in caps. If the first word is part of a name or title, the whole name or title should be in caps.

If the initial is the article *A* or the interjection *O*, the second word should be in caps, and there should be a space between the words.

It is customary to have the same amount of white space along the side of an initial as at the bottom. In order to accomplish this the text must be set to conform to the shape or outline of the letter. The subjoined examples and explanations cover the matter in detail.

LETTERS like the capital *A* and the capital *L* should be mortised to accommodate the balance of the word so that there will not be an unsightly gap between the initial letter and the balance of the word.

ALTHOUGH the capital A is mortised when it is a part of the first word of the paragraph, there is no occasion for doing so if the paragraph begins with the article A.

A PARAGRAPH that begins with the single letter A requires space between the initial and the succeeding word; moreover, the second word should be all in capitals. This paragraph shows how the matter should be set.

WHEN the letter W is used as an initial there is no need to indent the lines that run beside it, because the slope of the letter affords sufficient white space to present a pleasing appearance.

IF THE paragraph begins with a two-letter word, it is customary in most offices to capitalize the second word. If the first word is a proper noun, capitalize the whole name.

FOR initial letters that contain enough white space on the body of the type there is no need to allot any extra space when running lines around them. There should always be enough matter to surround the initial.

ENDEAVOR at all times to have an equal amount of white space around an initial. Just how much will depend on the amount of space left beneath the initial. The letter T contains enough white space on the body to avoid any necessity for additional space in the line.

THE initial should line up with the top of the balance of the word. If possible, use an initial that is a multiple of the body size, so as to avoid too great an amount of white space beneath the letter.



THIS initial occupies the full body of the letter. It is, therefore, necessary to indent the lines that run around it so as to present a uniform amount of white space. When the initial is an even multiple of the body size, the right amount of space is easily determined.



GHOSE initials that are surrounded with filigree work should be so placed that the balance of the word lines up with the top of the initial. Just how much indention should be given to the type lines will depend entirely on the appearance of the background. In general, dark backgrounds require more space than light ones.

104. Shape Harmony.—The exigencies of the work and the office equipment sometimes compel a compositor to use type that is unsuitable. When he is unrestricted, however, he should endeavor to have the shape of his type harmonize with the shape of his job. A long, narrow job looks well if set in condensed type; a broad job can stand an extended letter. Never use extended type in narrow measures, or condensed type in wide measures, unless compelled to do so to make the matter fit the space.

105. Selecting the Salient Features of a Job.—If the copy comes in the form of manuscript, and no layout is given, the compositor should go over it and pick out those features admitting of best display. In planning the work he should have in mind the fact that the job must possess all the requisites of balance, harmony, and appropriateness. It should be pleasing in all its groups, and each item should be given the prominence due its importance.

For office stationery, the usual order of importance is first the name, then the business, then the address. This order does not always prevail, however; some customers preferring to have other items of importance given more prominent display.

If the job be advertising matter, the main features for display are usually designated by the customer, the groupings and the selection of type being left to the compositor. Successful treatment of such a job is the crucial test of his skill. There may be a dozen different ways in which the job *could* be set, nearly all of them yielding pleasing results. If the job is to be a complete success, however, its various elements must harmonize in tone, be well balanced, nicely grouped, and the display must have enough white space around it to cause it to stand out distinctly.

106. Improving a Job.—It frequently happens that, after a compositor has pulled the proof of a job, the result falls short of his expectations. In such case he may find on careful study of the proof that a change (sometimes a very slight one) in the spacing will greatly improve its appearance. The insertion or removal of even one point between lines will sometimes improve the work. Cultivate the habit of analyzing your work with a view to improving it.

Occasionally a job that is extremely ordinary looking in black ink on white paper can be improved by printing it on colored paper with some harmonizing ink.

107. Spacing Job Type.—The spacing of lines in solid matter has been pretty thoroughly treated under Spacing, page 17. In spacing job type each line is a problem by itself. Lines standing alone, with plenty of white space around them, need more space between words than when surrounded by other matter. Extended letters require more space than normal or condensed ones. Lines in capitals require more space between words than do lines set in lower-case.

When spacing lines in capitals, where the letters are straight, like M and N, more space should be used than when the letters are sloping or open, like A, L, W, and Y. Such letters show some white space, and this should be considered when spacing the line.

108. Letter-spacing.—It frequently happens in setting lines in capitals that certain combinations of letters, like A and

T, A and V, etc., occur, and the space between the letters lacks uniformity. To obviate this, letter-spacing may be employed to improve the appearance, or the letters may be shaved and "fitted" together. The following examples will illustrate:

This line shows the type just as set from the case.

HIGHLAND AVALON

Here is shown the same line letter-spaced to make the space between the letters uniform with the space between the V and A in "Avalon."

HIGHLAND AVALON

In the following line the V and the A's in "Avalon" have been shaved off and closed up and the balance of the line letter-spaced to show uniformity in "fit."

HIGHLAND AVALON

At different times typefounders have cast type with mortices so that when certain letters come together they will dovetail. The line below shows how this is done.

WAVERLEY TALES

Unmortised

WAVERLEY TALES

Mortised

109. The Square Effect.—Sometimes in setting a job the lines are so nearly of uniform length that there is not enough variation to give a pleasing grouping. In this event it is advis-

able to letter-space the lines and make them all of the same length, thus producing a square effect. Some compositors, actuated solely by artistic motives, leave off all marks of punctuation and make improper divisions of words to accomplish this purpose, but such practice is not to be commended.

110. Selection of Rule for a Job.—Inasmuch as rule may be considered as part of the ornamentation of a job, all that has been said about harmony, tone, appropriateness, etc., prevails in the selection of rule for a job.

Rule is the name given to the material used for printing lines of various lengths and widths. It is type-high, and comes in a variety of faces. It varies in width of face from a hair-line to upward of a pica. For many years it was obtainable only in brass, but of late both the Linotype and Monotype companies have added to their machines attachments for producing leads and slugs and also rules of various kinds. The product of the linotype machine is restricted to six-inch lengths. If longer lengths are needed, two or more pieces must be placed end to end. The monotype machine can produce leads, slugs, and rule of any length. A two-point rule six hundred feet long has been cast. The latest device on the machine will cut the material to any length from one inch to twenty-five inches.

As may be inferred from a consideration of the alloy of which it is composed, *lead rule* is not as serviceable as brass. If rule is to be in constant use, it should be of brass. If it is to be thrown away, and new and perfect material used on every job, lead rule answers the purpose.

Brass rule is made from strips of metal rolled to absolute thickness between agate rollers. These strips come to the type-founder a little over type-high. To prepare them for use the bottom of the strip is first dressed off with a plane and made smooth and level. Before the face is put on the rule a line is scratched along its side near one edge in order to designate which edge is to be the top. When using face-rule (the same on both edges), always keep it face side up. Using it indis-

criminally will finally result in the rule being battered on both sides.

By far the greater part of the rule in use today is of brass. A study of a typefounder's specimen-book will reveal an infinite variety of sizes and kinds. A few faces are shown in Fig. 43.

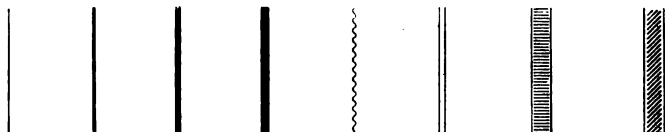

FIG. 43.—Specimens of Brass Rule.

III. Aligning Rules with Type.—When using rule and type in combination, it is important to have the rule in *perfect* alignment with the bottom of the type face. The face of the rule should also harmonize; that is, a light-face rule should be used with light-face type, and a heavier rule with heavy-face type.

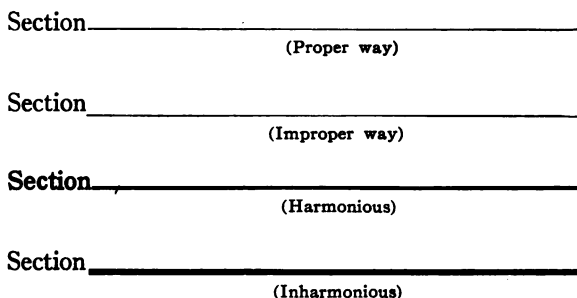

FIG. 44.—Showing Proper and Improper Way of Using Rule with Type

When rules are run the full width of the job the type lines are frequently printed above them instead of being justified with them. This results in a great saving of time, and avoids the frequent necessity of cutting rules to fit the space.

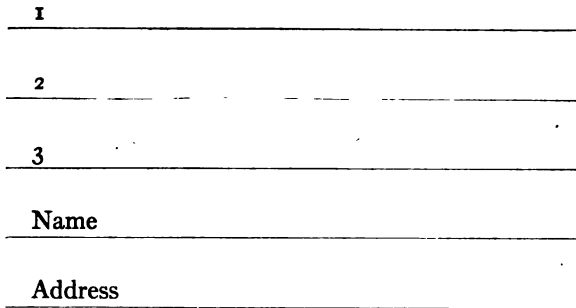

FIG. 45.—Another Method of Using Rules with Type.

When using two or more pieces of rule side by side, and the lengths are made up of more than one piece, never have the joints all in line. See below.

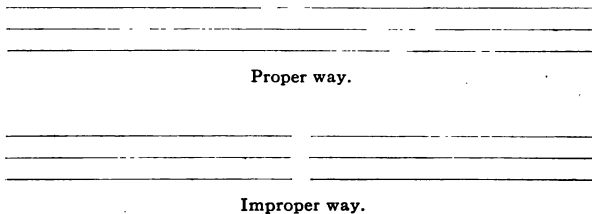

FIG. 46.—Proper and Improper Way of Doubling-up Rule.

112. Side-face or Chamfered Rule.—An extremely useful rule, but one that seems to puzzle some compositors, is the three-point side-face rule shown in Fig. 47. The face of the rule is not in the center but along one side of the rule. While inside and outside miters come with a full font of the rule, they are not needed to make a perfect corner. The rule is especially adapted to panel work, either single or double. Being on three-point body, it makes up to even multiples of pica. If, for any reason, it is desirable to have a piece three points more or

less than an even em, putting an inside and an outside miter together will produce it. (Fig. 48.)

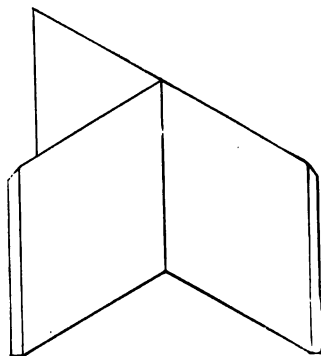

FIG. 47.—Showing How Three-point Side-face Rule Should be Butted to Make a Perfect Joint.

Placing one end of a piece of rule against the side of another piece produces a perfect joint. The face shown is adapted

FIG. 48.—Method of Joining an Inside and Outside Miter.

to many uses in job work. An example of its use is shown in Fig. 41.

113. Mitered Corners.—When using parallel rule or a center-face rule, it is necessary to miter it to produce a perfect joint at a corner. If the rule be a full-face rule, it is not necessary to miter it, for the corner can be “butted.”

Occasionally a job comes into the office and the size specified for the rule is not a regular multiple of picas. If the job is to be printed from type, it is necessary to cut the rule to the size designated. Never cut labor-saving rule for this purpose. If the job is to be electrotyped, labor-saving rules may be used with the corners lapped as shown in Fig. 49, and the electrotyper can cut off the projections after the plate is made. Either

side-face or full-face rule can be used for this purpose, but not center-face, for the face of the latter cannot be brought against the end of the rule.

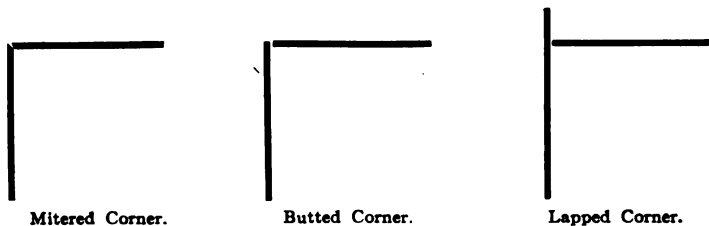

Corners have been left open a little to show how they are joined.

FIG. 49.—Showing Three Methods of Joining Rule.

Instructions for mitering rule are given under "How to Use the Mitering-machine," page 203.

114. To Obtain Perfect Joints in Tables.—Figs. 50 and 51 show two tables, the first with imperfect joints the other with perfect joints. The first one was set in columns and the rules inserted while setting. Owing to the fact that the column rules have shoulders on each side, the cross-rules cannot fit up against them. The second was made up into two sections and both

No.	1	2	3	4	5	6	7	8	9	10	11	12

FIG. 50.—Usual Form of Hand-set Table, showing Imperfect Junction of Rules.

No.	1	2	3	4	5	6	7	8	9	10	11	12

FIG. 51.—Showing Same Job as Fig. 50, but as it Appears when Printed in Two Impressions. See Fig. 98.

printed at the same time. The sheet was turned end for end and printed a second time. This printed one section over the other, thus producing perfect joints. Inasmuch as both sections are printed at the same time the procedure does not entail any extra time in running the job, but it does produce perfect joints. Moreover, there is a great saving in time when setting the job, for the lines are all set full width instead of in narrow columns.

If the job is so large that both sections cannot be worked in the same form, it is still advisable to set the job in this way and make two forms of it, especially if there are but few impressions needed, for the saving in composition will usually offset the cost of the extra presswork. This is sometimes called the wax-engraving effect.

115. Skeletonizing.—When a job is to be printed in more than one color, and there is no overlapping of the colors, it should first be set up complete, and then taken apart and made up into separate forms. If any of the colors overlap, it is physically impossible to put both colors in one form, so the overlapping color is made up into another form. The taking apart and making up into separate forms for colors is known as *skeletonizing*.

The customary way of handling a two-color form is to set the job as if it were to be all in one color and have the proof approved. When ready to skeletonize, pull a proof on *dry* paper to be used as a gauge for determining the correct position of the lines, then put the job on a galley and proceed to make it into two parts of equal size. How this is to be done will depend entirely on how the second color was originally placed. If a few lines are to be in a separate color, take out the lines, one at a time, beginning with the one nearest the top, and put in its place material of the same body size. Put the line on a galley, and place enough material above it to make it come in exactly the same position that it occupied in the original page. Go down the page to the next line, doing the same as before. In this way take out all the lines, substituting material of the proper size. If this has been properly done, the size of the original page will not have been altered. The other page should now be spaced so that the lines come in the same position as in the original job. Use the dry proof as a guide for determining this.

If the job is a complicated one, and has words scattered throughout the text, it will be necessary to proceed in a different manner. For example, suppose the job is to be printed in red and black, and that the words in red are scattered among the lines of type. It does not make any difference how many separate words or items are to be removed from any one line, the method is always the same. Place the line in a composing-stick, remove the first word in red and substitute quads and spaces for the word, thus justifying the line. Then take out the next word in red, and rejustify the line, continuing in this way to the end.

The final result will be a line with material substituted for the words that are to go in red. It is now necessary to get these words in a separate line by themselves and in the same position that they occupied in the original line. To accomplish this raise the material that has been substituted for the first word so that quads may be placed between the left-hand side of the stick and the spacing material. Put in quads and spaces,

and justify them accurately. Now put in the word. Next raise the material substituted for the second word, and fill in the space between the first word and the second spacing material. Justify this. Now put in the second word, and fill up the balance of the line with quads and spaces, and so on to the end. If this has been properly done, the result is a line containing the words in red, each of which will be in the same position that it occupied in the original line. Fig. 52 illustrates

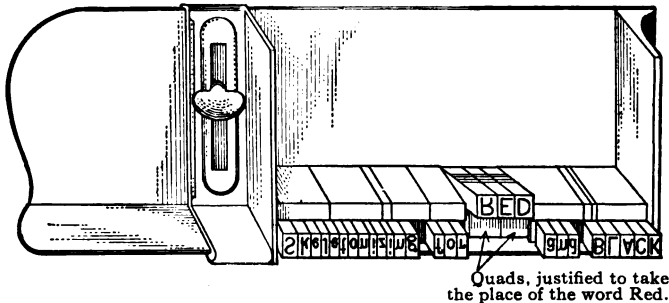

FIG. 52.—Showing Method of Skeletonizing a Line for Two Colors.

the method even better than words can describe it. If desired, the first word could be justified in position before the second is removed.

Having skeletonized the line, replace the original line, and place the other one on another galley. After all the individual lines have been skeletonized, assemble them in proper order and space out the job as in the original page, using the dry proof as a gauge.

If the job is to be electrotyped, there is no need to skeletonize it, if the colors do not overlap. When sending the form to the electrotyper, mark on the proof what parts are to be in each color. The electrotyper will take two casts from the form, and either block out in the wax or rout away the parts not needed in each form. If an electrotyped job is to be printed in red, the electrotype should be nickel-plated, as copper usually has a deleterious effect on red inks, destroying the color and luster.

116. Setting a Register Job.—It is evident from the description given in Section 115, that some of the lines in the job may have to be moved to put them into register, more especially if they are widely scattered. When putting together a form that may have to be moved, do not insert solid blocks of furniture, but be sure to have some leads and slugs between each group so that the lines may be readily moved without seeking new material.

117. Allowing for Squeeze.—Nearly every piece of type composition is made up of a great number of individual units. Such a combination is almost certain to be springy, and each job possesses a certain amount of "give." When making up a job, especially if enclosed with a border, press it together by hand, using considerable force, and when it seems to meet perfectly at the corners, add a two-point lead "for squeeze." When the job is locked up, these two points will be just about right for a perfect lockup. If the job is very long or very springy, additional "squeeze" should be allowed for.

118. Concluding Hints.—All type is (or should be) cast on the point system, consequently each size of type is a multiple of another, and can be justified with it by the use of point material. Before putting the material together be assured that it is of the right thickness and of the proper length, that it is not battered, bent, twisted, dished, nicked, burred, or in any wise mutilated. Make sure that the material is perfect in every respect. If it is not, discard it. The trouble that it may cause would doubtless be more expensive than the cost of the material. If the defect can be easily remedied, do so.

Do not use leads that are too short for the measure; they are always troublesome.

When doubling-up leads (placing them end to end), be careful not to use leads of different thickness.

Burred quads are a frequent cause of trouble, and are hard to detect when in a form, especially if the burr is near the bottom. Burrs on type or rule may easily be removed with a flat file.

When using a border made up of small units have a six- or twelve-point slug alongside of the border. If possible, do not allow any break in the line of units to come directly in line with a break in the material surrounding it. If you do, the material will very likely slip or bind. (Fig. 53.)

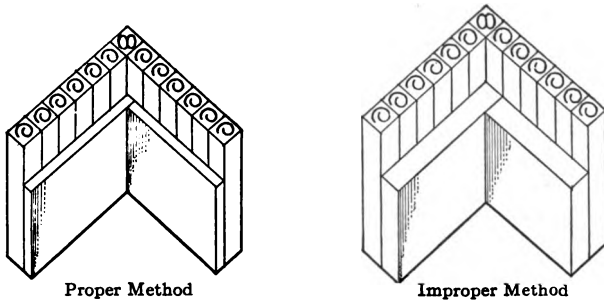

FIG. 53.—Proper and Improper Method of Placing Slugs inside of Border Units.

Owing to the fact that letters used as initials are not always an even number of picas wide, the lines alongside of the initials are not always an even number of picas long. If the matter is leaded it is not always necessary to cut leads to fit the resultant space. Unless compelled to run the type right up against the initial, place enough material alongside of the initial to bring the remaining space to even picas. Do this for all the lines except the first, which should be close to the initial. Occasionally, if the space is a multiple of points, the use of point-thick spaces alongside of a pica-length lead will just be the right length.

The following spaces are each two points thick and may be used with two-point leads: five-em space of ten-point, four-em space of eight-point, and three-em space of six-point. By using a lead and some combination of these three spaces we can generally find a multiple to fit the space. With these, lengths may be built up in multiples of two points. For example: suppose that the resultant space beside an initial should prove to be twenty-one ems and three points. Place a three-point

lead alongside of the initial and leave twenty-one ems as the measure for setting the type. If it is absolutely necessary to set the type right against the initial, and the leads must be absolutely full length, then cut leads to fit. If the leads may be one point short of full length, make up a combination to equal twenty-one picas and two points. A twenty-em lead, one four-em space of eight-point, and one three-em space of six-point will suffice. Twenty ems plus fourteen points equal twenty-one ems and two points.

QUESTIONS ON CHAPTER VII

1. What are the duties of a typotect ?
2. Where is the optical center of a page ?
3. What do you understand by "harmony" in a piece of type composition ?
4. Why should a mixture of old-style and modern roman type faces be avoided ?
5. Explain "tone" as applied to a page of type.
6. Explain "contrast," and tell how it is obtained in a piece of composition.
7. What do you understand by "appropriateness" ?
8. Explain the fundamental principles of type grouping.
9. What do you understand by "proportion" ?
10. Name the four oblongs in use by printers at different times.
11. How is the multiplying factor, or constant, for the different oblongs obtained ?
12. What rules govern the use of borders and ornaments ?
13. Explain how type matter should be run around initial letters.
14. Why is it inadvisable to use condensed type in wide measures and extended type in narrow measures ?
15. What special things should be kept in mind when analyzing copy preparatory to setting a job ?
16. If after setting a job it did not meet your expectations, how would you proceed to alter or improve it ?
17. Should a uniform amount of space always be placed between words in a line ? If not, why not ?
18. What is "letter-spacing," and why is it used ?
19. When the lines in a job are nearly all of the same length, why is it desirable to make them all of equal length ?
20. Name the different materials of which rule is composed.

21. Explain the relative merits of lead rule and brass rule.
22. What is face-rule ?
23. Name the kinds of rule with which you are familiar.
24. How should rule be aligned with type ?
25. When lengths of rule are made up of two or more pieces, how should the joints be arranged ?
26. What is a mitered corner ?
27. What is a lapped corner ?
28. Explain how perfect joints may be obtained in a table consisting of horizontal and vertical lines.
29. What do you understand by skeletonizing a form ?
30. Describe how you would skeletonize a form for two colors if the second color consisted of full lines only. How would you proceed if the second color consisted of words scattered throughout the job ?
31. What special provisions are to be made when setting a register job ?
32. Why is it necessary to allow for squeeze ?
33. Why is it inadvisable to use leads that are too short for the measure ?
34. When doubling-up leads, how should they be placed together ?
Tell why.
35. When making up a border consisting of twelve-point units, why should we use a six-point slug instead of a twelve-point slug alongside of the border units ?
36. Explain how type set to a bastard measure may be leaded by using labor-saving leads and point-thick spaces.

CHAPTER VIII

SETTING A JOB

119. The Order-blank.—Nearly every printing office has a different style of order-blank. Fig. 54 shows one that has been in successful operation. All the data regarding composition, presswork, binding, and delivery is written out in full, so that there can be no doubt about any part of the work. The compositor is chiefly concerned about the size of the job, the purpose for which it is intended, the color and nature of the stock, and the color of the ink.

Referring to the order-blank, we find that it calls for a letter-head, $8\frac{1}{2} \times 11$ inches. So that there may never be any doubt as to which way the type is to be set, the width is always given first. The type is, therefore, to be set the $8\frac{1}{2}$ -inch way.

The letterhead is to be printed in bronze blue ink on light blue paper. It is business stationery for a book house. Work of this nature and with this combination of colors always looks well when set in some old-style type face of medium weight. Cloister, Cheltenham, Kennerley, or some letter of about equal weight, would look well. Cloister is chosen for illustration, mainly because it is a new letter, and quite the vogue.

The copy is manuscript, and reads as follows: F. A. Williams, President; C. W. Brown, Vice-President; John Adams, Secretary-Treasurer. F. A. Williams & Co., Historical, Educational, Scientific, Art, and Law Books, 1217 Printing House Square, Philadelphia, Pa.

120. Analysis of the Copy.—A brief analysis of this copy reveals the fact that it can be grouped satisfactorily in several different ways. To obtain a proper conception of the finished

ORDER No.
7228

READ CAREFULLY

NO JOB to be SET or SENT to
PRESS WITHOUT an ORDER

Date July 19, 1916

For F. A. Williams & Co.

Address 1217 Printing House Square

Quantity 1000 Title of Job Philadelphia

Description Letterhead

Printed at top

CUSTOMER'S ORDER NO.
2217

COMPOSITION	PRESSWORK
STYLE <u>Gloister</u>	COLOR INK <u>Bronze blue</u>
SIZE <u>8 1/2 x 11 inches</u>	COVER
ELECTROS	NO. OF FORMS
PROOF WANTED <u>7/21/16</u>	IMPRESSIONS <u>one</u>
PROOF SENT OUT	REMARKS:
REVISION SENT OUT	
PROOF RETURNED	
SENT TO PRESS	

Stock Woronoco Bond, Azure ORDERED FROM

Cover 17 x 22 - 20 ORDERED FROM

Cut Stock Size 8 1/2 x 11 Cut Cover Size _____ Ruling _____ Tablets No

Shipping Directions By messenger, before
7/26/16

AMOUNT CHARGED
DATE BILLED

Date of Delivery

Order Received By B. S.

FIG. 54.—A Typical Order-blank.

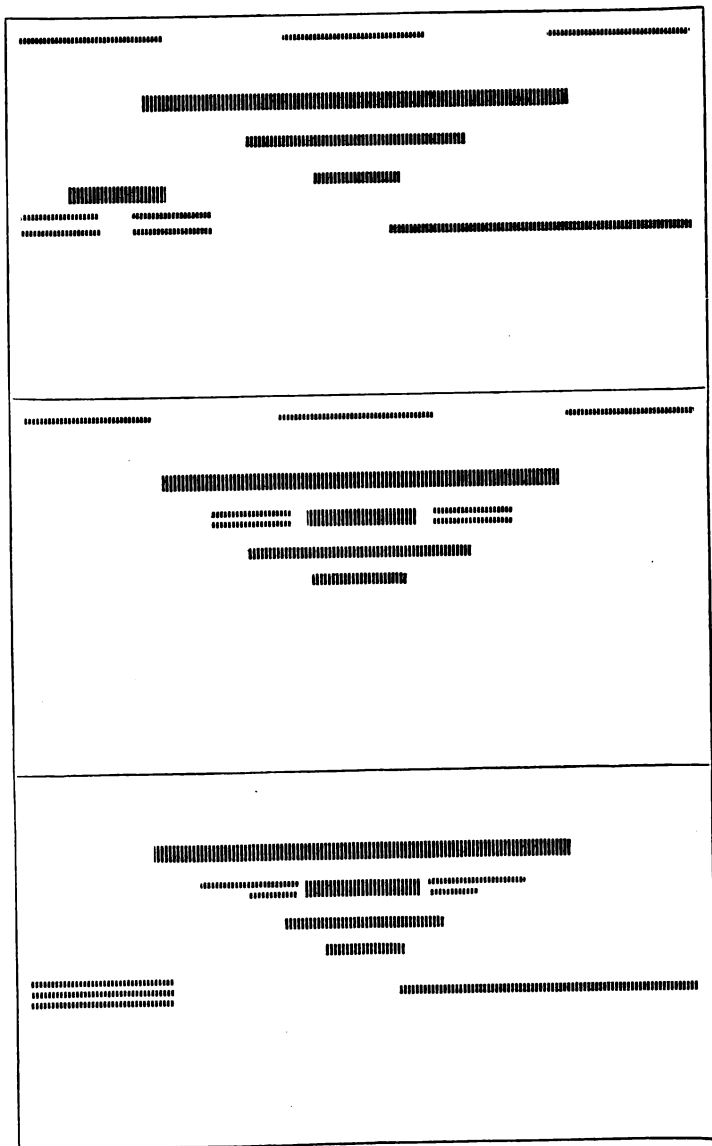

FIG. 55.—Suggested Groupings for Letterhead.

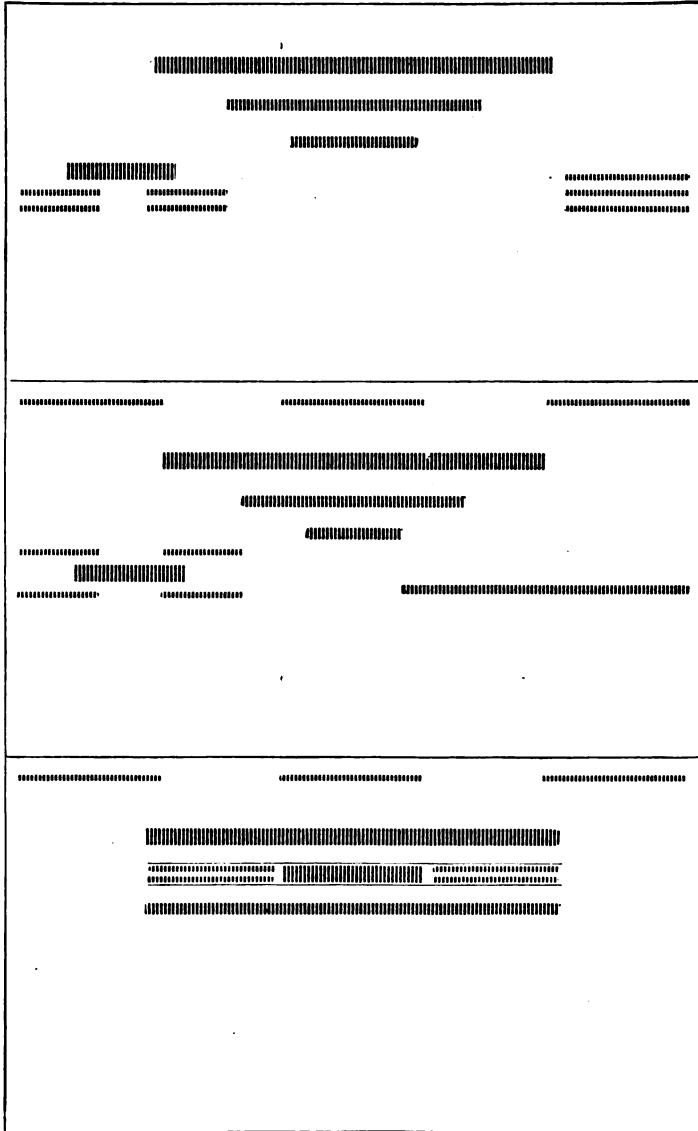

FIG. 56.—Suggested Groupings for Letterhead.

appearance of the job a *layout* is first made in the form of a few rough pencil sketches on paper $8\frac{1}{2}$ inches wide. See Figs. 55 and 56. When making pencil sketches always use paper of the exact size of the job, for you will thereby get a better idea of its appearance when put into type. When you sketch a line, approximate both its type size and its length. Do not sketch long lines to fill up a space when you know that the type selected will not run that long. You may in this way sketch a well-

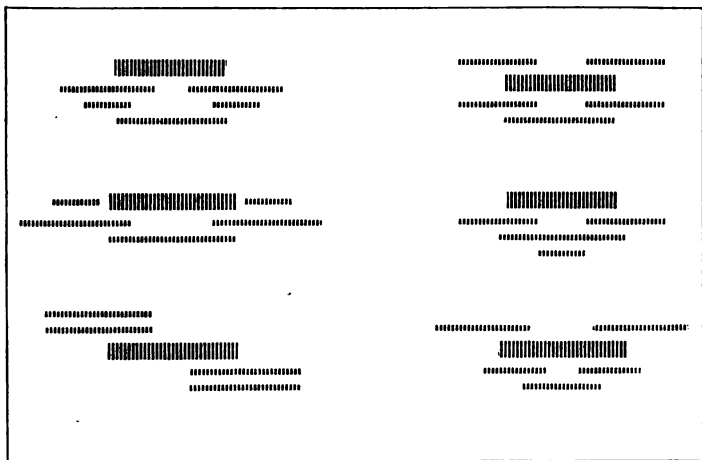

FIG. 57.—Other Groupings for the Word “Books” and its Qualifying Adjectives.

balanced layout, but you obtain no idea of the appearance of the finished job.

From your rough sketches select the one that to you seems the most pleasing. Suppose this to be the one that features the word “Books,” on the left-hand side. There are at least a half-dozen different groupings to be made of these words, see Fig. 57. Assume for the purposes of the present discussion that Number 2 is finally selected; the compositor is now ready to put the job into type.

There is ample space on the letterhead, so there is no need to crowd the matter. The main line should fall about seven-eighths of an inch from the top, and the list of officers from one-fourth to three-eighths of an inch. The side margins should be about one-half inch on each side. This will leave the measure forty-five picas.

Set the body of the heading to forty-five picas. The word "Books" and its qualifying adjectives should be set in a smaller measure, so that it may be leaded out or placed in any position without interfering with the date line. Even if there were no date line it would be advisable to set this in a narrow measure to avoid using up a quantity of small material.

The featuring of the word "Books" also gives opportunity to put this word in some contrasting color, if the customer is willing to pay the price of a two-color job.

121. Size Type to be Used.—Unless advised to the contrary, it is safe to assume that the following is the order of importance for display lines—name, business, and address. Following this schedule for the letterhead, twenty-four point type may be selected for the name, fourteen-point for the word "Books," and twelve-point for the address. Six-point is large enough for the officers' names, and also for the adjectives around the word "Books." There is sufficient contrast in size in such a selection to secure the proper relative importance. Moreover, the fact that the lines are not crowded tends to set them off to advantage.

122. Position on the Sheet.—When planning for the position of the main line on a letterhead the compositor should be governed entirely by the grouping and the amount of material on the heading. A heading that contains but a few lines, and those short ones, can usually stand more space than can one that contains much matter and whose lines are long. If there is a line across the extreme top, three-eighths of an inch from the edge is about the right distance, and seven-eighths of an inch is about right for the main line. There is no absolute

A diagram showing the layout for a statement on ruled stock. It consists of a large rectangular frame containing several horizontal lines of varying lengths, representing the ruled lines of the stock. A small rectangular box is positioned on the left side, near the bottom of the main frame.

FIG. 58.—Layout for a Statement on Ruled Stock.

A diagram showing the layout for a statement for Outlook Envelope on unruled stock. It consists of a large rectangular frame containing several horizontal lines of varying lengths, representing the ruled lines of the stock. A small rectangular box is positioned on the left side, near the bottom of the main frame. Below the main frame is a large, rounded rectangular shape, representing the Outlook Envelope.

FIG. 59.—Layout for Statement for Outlook Envelope on Unruled Stock.

<p>F. A. WILLIAMS, Pres. C. W. BROWN, Vice-Pres. JOHN ADAMS, Sec.-Treas.</p>			
<p>STATEMENT</p>			
<p>_____ 191__</p>			
<p>M _____</p>			
<p>_____</p>			
<p>IN ACCOUNT WITH</p>			
<p>F. A. WILLIAMS & CO.</p>			
<p>BOOKS</p>		<p>1217 Printing House Sq., Philadelphia, Pa.</p>	
<p>FIG. 60.—Statement set According to Layout in Fig. 58.</p>			
<p>F. A. WILLIAMS, Pres. C. W. BROWN, Vice-Pres. JOHN ADAMS, Sec.-Treas.</p>			
<p>F. A. WILLIAMS & CO.</p>			
<p>1217 Printing House Square</p>			
<p>BOOKS</p>		<p>Philadelphia, Pennsylvania.</p>	
<p>STATEMENT OF ACCOUNT OF</p>			
<p></p>			
<p>FIG. 61.—Statement Set According to Layout in Fig. 59.</p>			

rule for this, but a study of well-balanced letterheads shows this to be good practice.

123. Layouts.—Figs. 58 and 59 show two layouts for a statement heading, one for a ruled sheet the other for an outlook envelope. Figs. 60 and 61 show them in type. When planning a job for an outlook envelope, remember that the line separating the heading from the body of the job serves as a guide for folding the sheet so that it will fit the envelope. Be sure to place it in the proper position. As nearly all office stationery is now written on a typewriter, if guide-lines are used for the address they should be the distance apart of two typewriter lines. It is much better, however, to omit them. When setting billheads, if there are printed lines alongside of the outlook, they should be so positioned that they may be typewritten at the same time that the address is written. See Fig. 62.

F. A. WILLIAMS & CO.

Books of All Kinds

1217 PRINTING HOUSE SQUARE

PHILADELPHIA

FIG. 63.—An Envelope Corner.

Figs. 63, 64, and 65 show settings of an envelope corner, a business card, and a label. It is frequently advisable to keep all the office stationery of a firm in harmony, and for that reason one style of type has been used throughout. Frequently the label will appear to better advantage if set in bolder type.

Before undertaking the setting of any job the copy should be analyzed, and a layout roughly sketched so as to get some idea of the finished product.

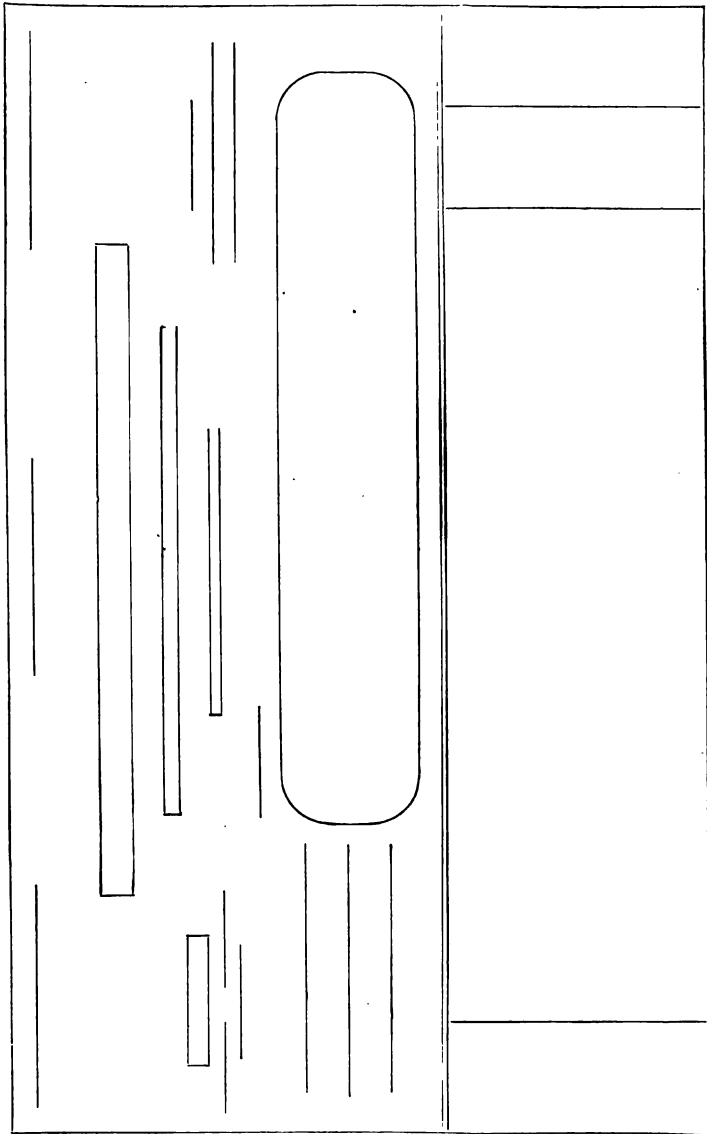

FIG. 62.—Layout for an Outlook Billhead.

F. A. WILLIAMS & CO.

1217 PRINTING HOUSE SQUARE
PHILADELPHIA

REPRESENTED BY
JAMES B. SMEDLEY

BOOKS

FIG. 64.—A Business Card.

for _____

Via _____

from

F. A. WILLIAMS & CO.

1217 PRINTING HOUSE SQUARE

BOOKS **PHILADELPHIA**

FIG. 65.—A Label.

124. Specimens.—The specimens on the following pages have been chosen for criticism, and their merits or demerits pointed out. The student should follow closely the criticisms and the reset specimens given in the current numbers of the various typographical magazines, and especially the department devoted to apprentices in "The Inland Printer." He will find therein much helpful suggestion.

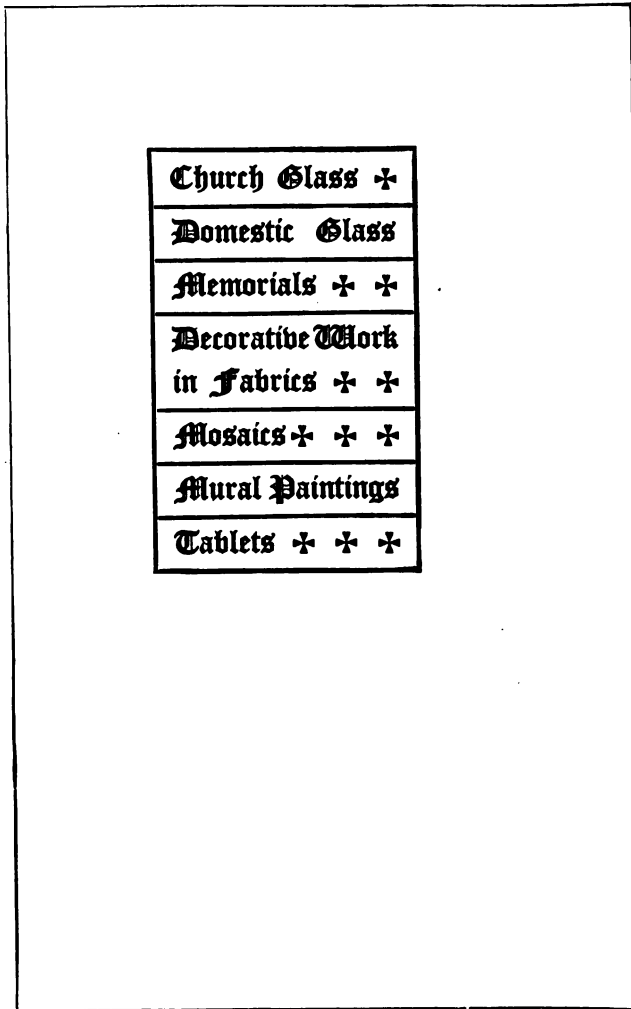

FIG. 66.—Cover for a Book of Testimonials. Neat, dainty, appropriate.

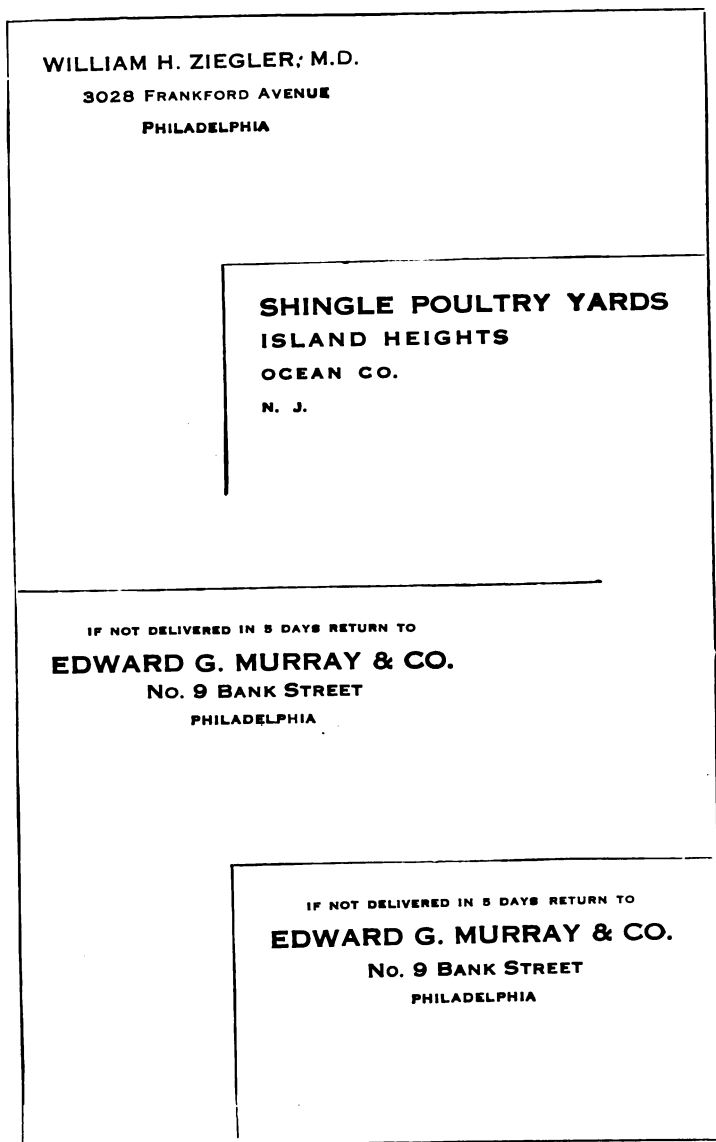

FIG. 67.—Envelope Corners.

No. 1. A professional envelope. No. 2. Unusual, but effective. No. 3. Improperly spaced. No. 4. Respacing of No. 3.

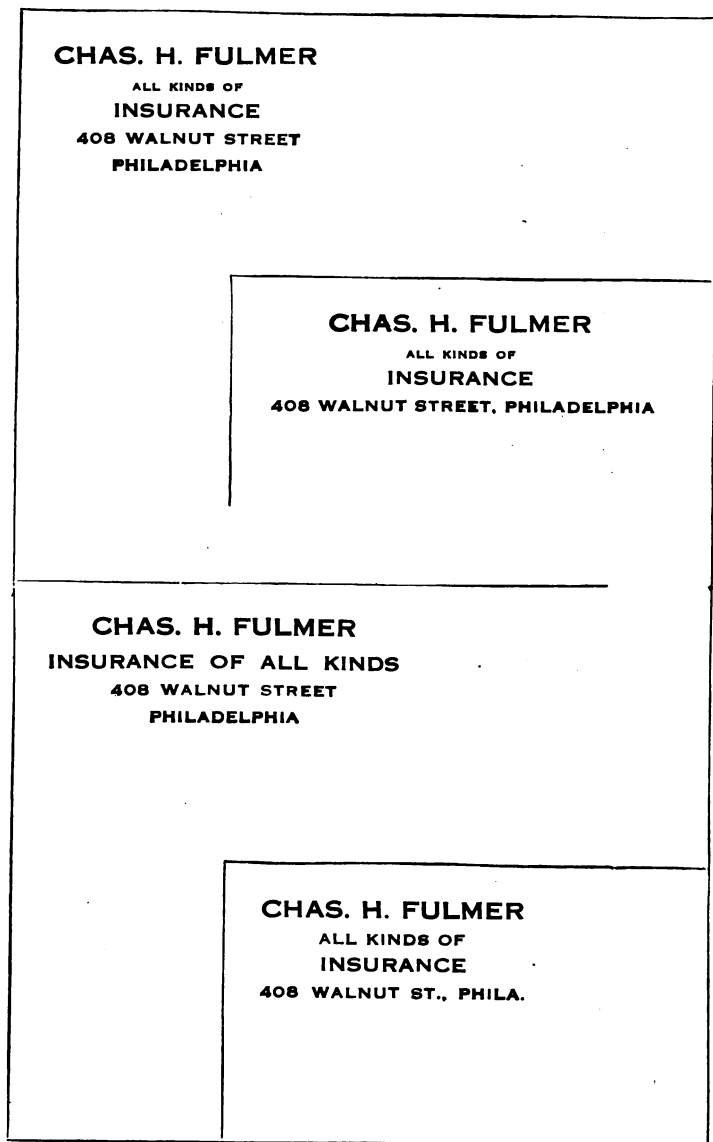

FIG. 68.—Envelope Corners.

No. 1. As originally set. Too many short lines to make a pleasing group.
Nos. 2, 3, and 4 show resettings.

STATEMENTS RENDERED MONTHLY

2018 CHESTNUT STREET
PHILADELPHIA, _____ 191

M _____

SAMUEL D. RISLEY, M.D.

FOR PROFESSIONAL SERVICES

\$ _____

RECEIVED PAYMENT

CONSULTING HOURS
9 A.M.—1 P.M.
AND BY APPOINTMENT

FIG. 69.—A Professional Statement.

**DR. BEN CLARK GILE
HAS REMOVED FROM 1728 CHESTNUT STREET TO
2018 CHESTNUT STREET**

**OFFICE HOURS: 8 TO 12 A.M.
OTHERS BY APPOINTMENT**

**WILLIAM A. GRAY
THOMAS E. COGAN**

**ANNOUNCE THE REMOVAL OF THEIR LAW OFFICES
FROM 1011 CHESTNUT STREET TO
WEST END TRUST BUILDING
BROAD ABOVE CHESTNUT STREET, WEST SIDE
ROOMS 809, 810, 811**

BOTH TELEPHONES

AUGUST 1, 1917

FIG. 70.—Professional Removal Notices.



THE PHILADELPHIA
CLUB OF PRINTING
HOUSE CRAFTSMEN

KUGLER'S
May Twelfth, Nineteen-ten

What we eat

✠
PUREE MONGOL SOUP
Olives
Radishes

✠
PLANKED SHAD
Parisienne Potatoes

✠
FILET OF BEEF
Mushrooms
Potatoes
String Beans

✠
Neapolitan Ice Cream
Cakes
Coffee



CLUB TOAST

Tune: "Auld Lang Syne"

Now here's a toast to our new band
Ye Typos tried and true;
And here's success to men who stand
By each whate'er we do.
Together banish what is old
Then bring up what is new;
If each will find he's of one mind
And the whole not ruled by few.

FIG. 71.—Unique Treatment of a Menu.

Showing front cover and one inside page. The beauty of the original cannot be shown in black and white. The cover was in brown ink on onyx paper, and the circle was embossed. The inside page was in black and red on white antique paper.



“**H**IS lamp am I
To shine where He shall say:
And lamps are not for sunny rooms,
Nor for the light of day:
But for dark places of the earth,
Where shame and wrong and crime have birth;
Or for the murky twilight gray,
Where wandering sheep have gone astray;
Or where the light of faith grows dim
And souls are groping after Him;
And sometimes, a flame,
Clear shining through the night,
So bright we do not see the lamp,
But only see the light,
So may I shine—His light the flame—
That men may glorify His name.”

FIG. 72.—A Motto Card.

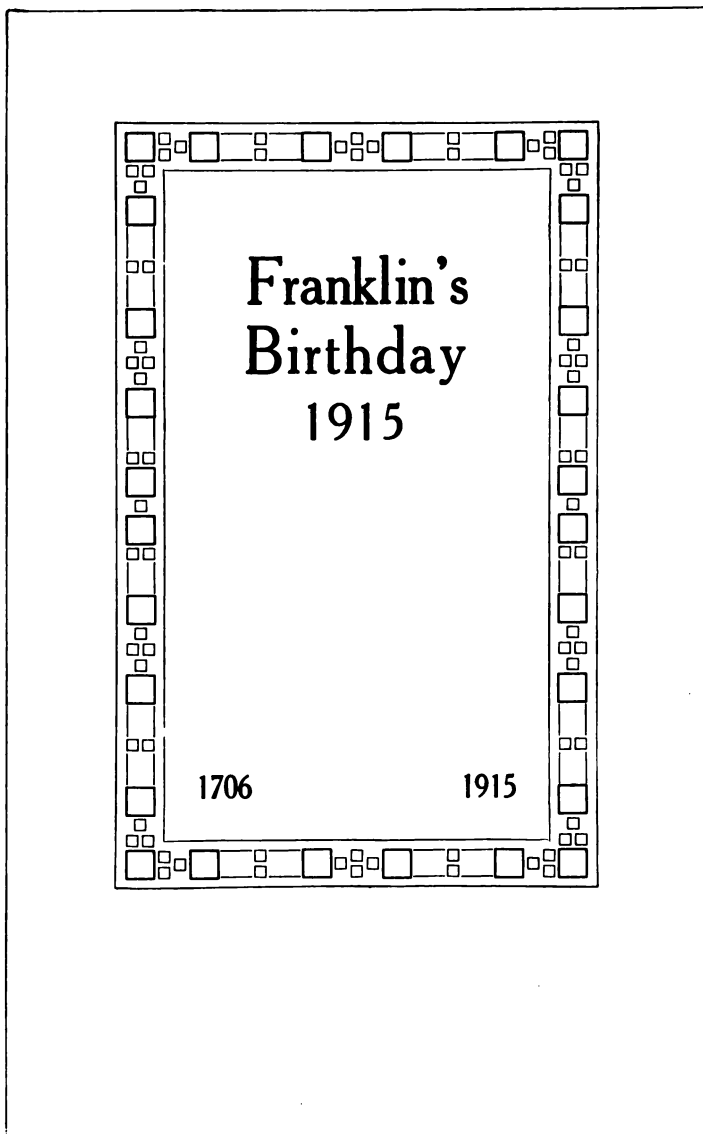

FIG. 73.—Plain, Dignified Cover for an Invitation.

Original with blind embossed border, and with type in olive green, on fabric-finished deckel-edged paper. Type in Pabst, which is symbolic of Franklin's time.

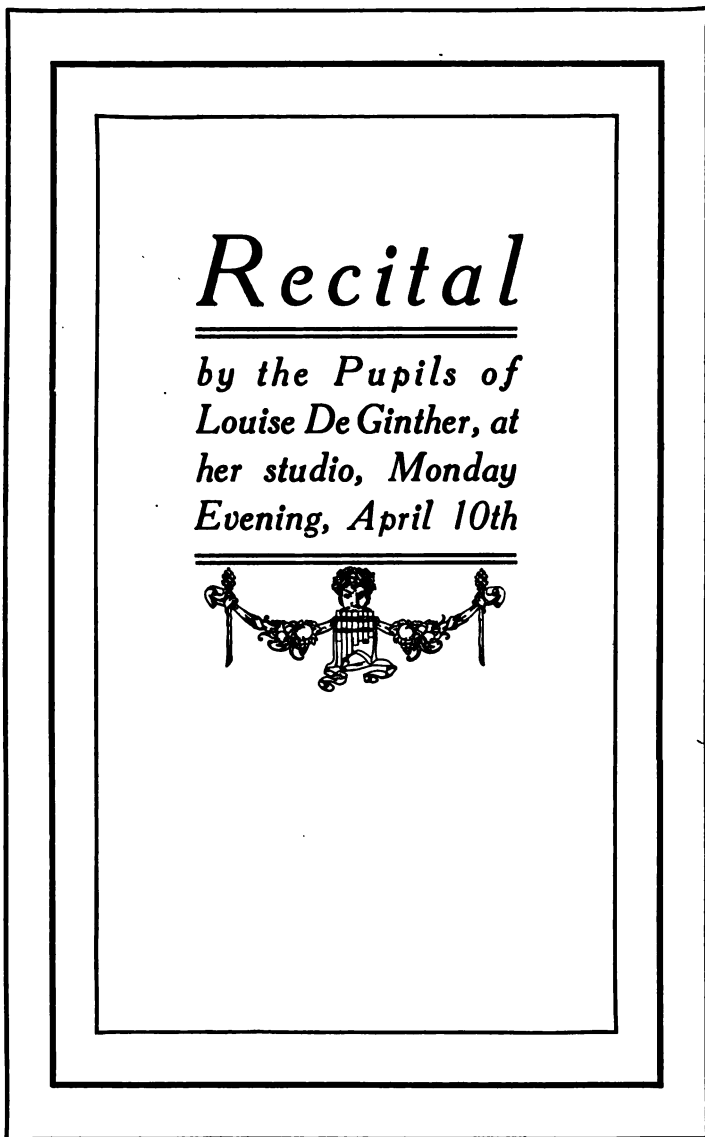

FIG. 74.—A Well-balanced Page.

Type and ornament especially appropriate. Shape of the job is in harmony with the shape of the page. Contrast this with the job on page 136.

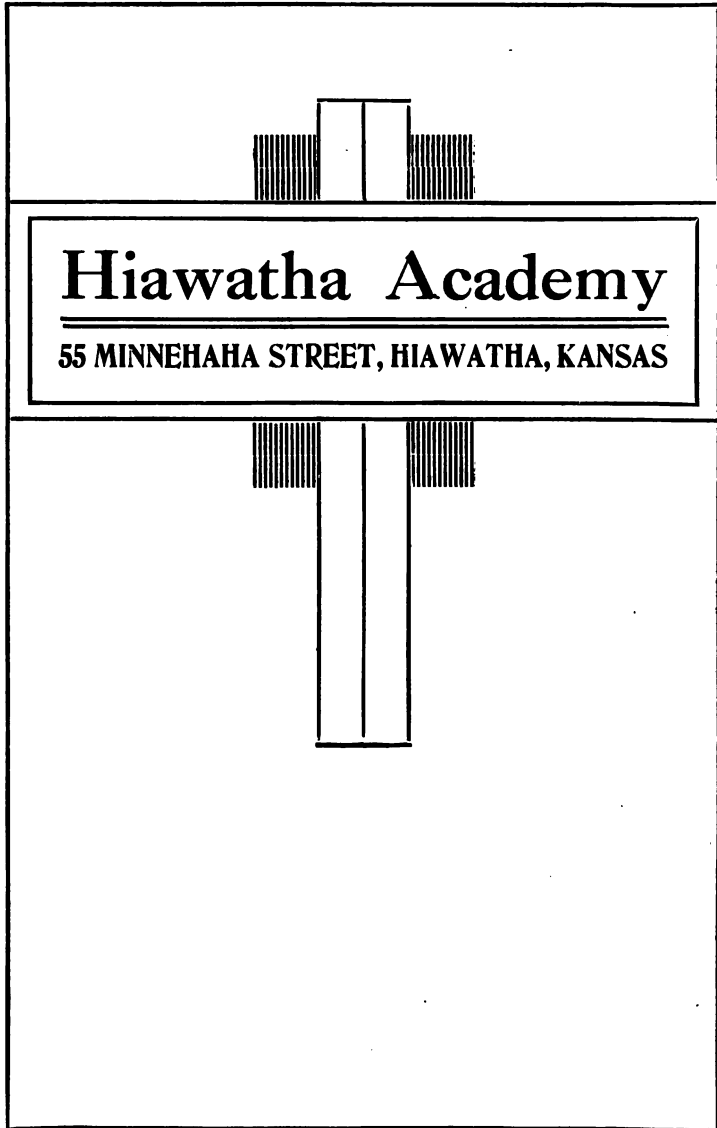

FIG. 75.—The shape of this job is not in harmony with the shape of the page. Contrast it with the resetting on opposite page, and also with job on page 135.

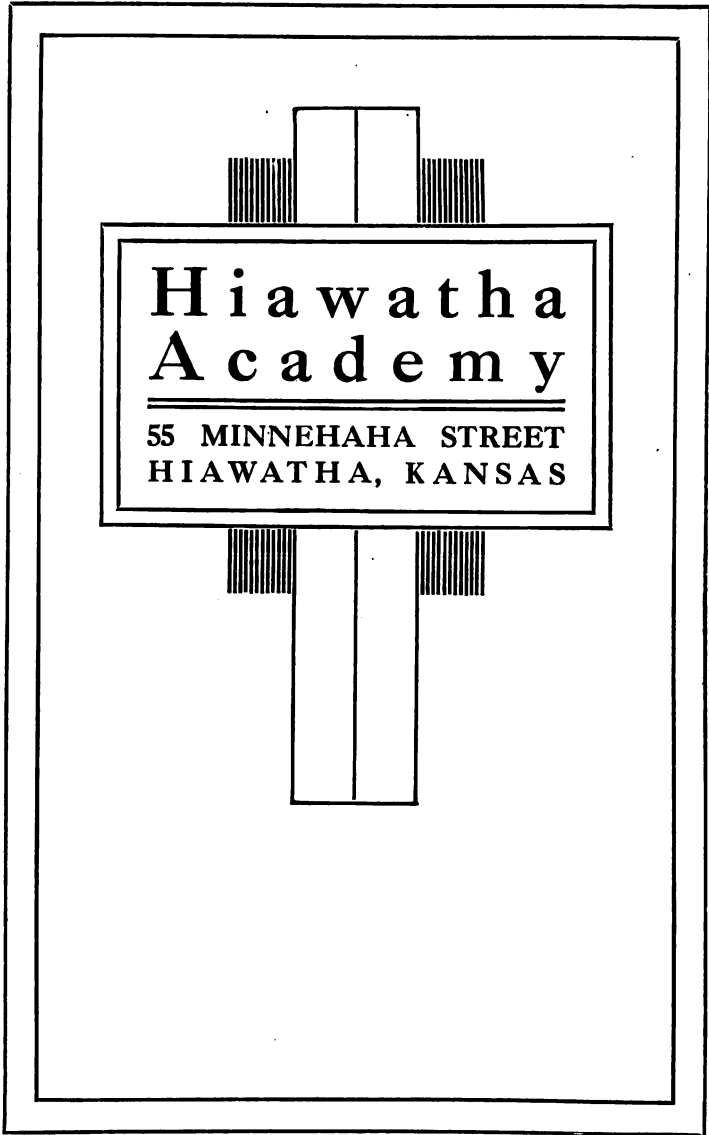

FIG. 76.—The double-rule border here gives the page a finished appearance. The shape of the job conforms to the shape of the page, thereby producing shape harmony.

PROCEEDINGS

OF THE SEVENTEENTH ANNUAL
MEETING OF THE MINNESOTA
TRADE ASSOCIATION, HELD IN
MINNEAPOLIS, JUNE 17-18-19, 1909



FIG. 77.—An Unbalanced Page.

The general effect of the mass of matter is above the optical center. There is not enough margin between the rule border and the job. See opposite page.

PROCEEDINGS

OF THE SEVENTEENTH ANNUAL
MEETING OF THE MINNESOTA
TRADE ASSOCIATION, HELD IN
MINNEAPOLIS, JUNE 17-18-19, 1909



FIG. 78.—A Well-balanced Page.

Type matter with plenty of white space around it is always much easier to read than when jammed against a border. Contrast this with job on opposite page.

QUESTIONS ON CHAPTER VIII

1. How do we determine from an order-blank which way the type matter is to be set?
2. What is the usual order of importance in a piece of office stationery?
3. What is a layout?
4. Why should layouts always be drawn full size?
5. What is an outlook envelope?
6. What advantages are there in using an outlook envelope?
7. What special care is necessary in setting a job to be enclosed in an outlook envelope?
8. If the top line of a letterhead is a subordinate one, at what distance from the top of the sheet is it usually placed?
9. At what distance from the top of a letter sheet is the main line usually placed?
10. If a letterhead is made up of short lines grouped around a center, should it have more or less top margin than one consisting of long lines similarly grouped?

CHAPTER IX

SETTING TABLES AND OTHER INTRICATE MATTER

125. Ability Required.—It has already been stated that one who aspires to be a really good job compositor should possess both mechanical ability and artistic taste. Unfortunately, many engaged in the printing business do not possess these requirements. Some are artists, but can not put a job together so that it will “lift”; others are capable of work that is perfect mechanically but lack the artistic touch. In setting tabular matter there is greater need for mechanical skill than for art training. Here, if anywhere, the work must be mechanically perfect. The artisan must be thorough in his work, must possess ingenuity, and must be able to determine at a glance the best way to set a particular job, for hardly any two are exactly alike.

126. Jobs Containing Rules.—Fig. 79 illustrates a job made up of rules with a heading to each column. If there are but a few sheets to be printed, it is sometimes cheaper to have them ruled by a paper-ruler, and then print in the headings. If a great number are required, the job should be electrotyped and more than one sheet printed at a time. Electrotypes may be obtained from a type form or from a wax-engraving. There are three methods of getting the form into type—by the Typotabular System, by monotyping, and by the regular method of hand setting.

127. The Typotabular System.—The American Type Founders Company has devised a plan for composing tabular or blank work which is called the Typotabular System. This system consists essentially of special type, rules, and a mass of units called *typotabular squares*, cast on six-point body, the top

NAME	RATE	DATE	BY WHOM SENT

(a) Hand Set.

NAME	RATE	DATE	BY WHOM SENT

(b) Monotype.

NAME	RATE	DATE	BY WHOM SENT

(c) Typotabular System.

NAME	RATE	DATE	BY WHOM SENT

(d) Wax-engraving.

FIG. 79.—Showing a Rule Job by Different Methods of Setting.

of each square being in the form of a four-sided pyramid. When these units are assembled, V-shaped channels are formed into which rules can easily be slipped. The lengths of the horizontal rules are all multiples of six points. Any distance desired between the lines can readily be obtained by combinations of rules of different thickness, one-, two-, three-, and four-point side-bevel rule being used. By using two-point parallel rule or one-point center-face rule between the columns, the horizontal rules come so close to the vertical rules that the slight gap is scarcely perceptible. The type used in this system is cast to unit width so as to be self-spacing.

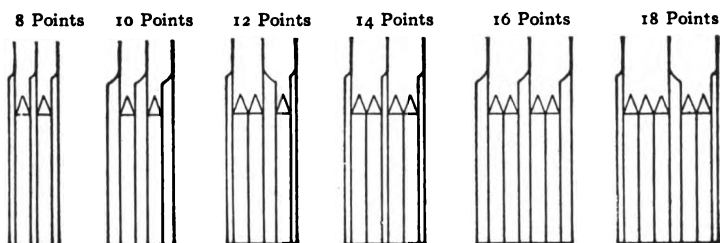

Showing use of rules of different thickness with Typotabular units.

The diagram, beginning with 8 points, shows graduation by 2 points, viz.: 8, 10, 12, 14, 16, and 18 points, by the use of 2- and 4-point side-face rules. If intermediate ruling is necessary, 7, 13, 19, 25, 31 points, etc., can be made with 1-point rule, and 9, 12, 15, 18, 21, 24, 27, 30, 33, etc., can be made with 3-point side-face rule.

FIG. 80.—Typotabular Method of Securing Definite Number of Points Between Lines.

When two-point center-face rule is used between columns in tables, the gap is distinctly noticeable. When head rules abut column rules, side-bevel rules should be used, so that the face of the head rule will join the end of the column rule.

128. Hand-set Ruled Blanks.—The first step in setting a ruled blank is to examine the copy and cast it off in column form, allotting a size nearest to that shown in copy, but making its width a multiple of six points. Mark each column width on the copy. Total the widths of the columns and the rules between

to determine the full width of the table. If too much has been allotted, reduce the width of a column, choosing the one for reduction whose heading would seem to indicate that but little space is required. If a column must be enlarged, place the extra space where it can be used to advantage. After the width is determined, count the number of lines desired, and note the length that the table is to be. Allot a certain depth for the heading, and divide the balance of the length of the table by the number of lines required. This will give the desired space between lines.

If the office is equipped with the different thicknesses of side-bevel rule mentioned under the Typotabular System, the job can be put together by using these rules and regular six-

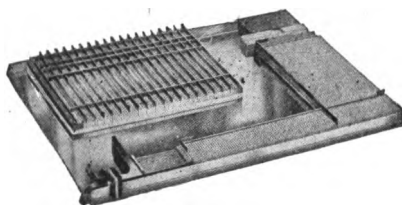

FIG. 81.—A Typotabular Job Ready to Slide onto the Stone.

point or twelve-point quads, as required. In fact, the method is practically the same as The Typotabular System, the only advantage possessed by the latter being that the units are always in mass formation and that the V-shaped channels aid in the insertion of rules. The table can, therefore, be put together in much less time. If the office is not so equipped (and this is usually the case), the space required must be made up by utilizing such material as is at hand. This is usually two-point rule and the average run of quads.

If very much of this ruled work is done the office should be equipped with Stephens's Multio-Hexset Quadrats. A full outfit of these consists of lengths from six-point to seventy-two-point (varying by six points), in thickness from six-point to

thirty-six-point (varying by six points). They may be obtained with either square or chamfered edges. The chamfered edges facilitate the insertion of rules. These quads are kept in a special case, with each size and kind in a row. When composing a table, a full-length row of the right size and thickness may be taken from the case and placed on the galley. This saves all of the time usually spent in assembling an infinite number of individual quads and spaces. After the job is completed the rules are removed and the rows of quads replaced in the case. There is thus a saving of time both in composition and distribution.

In setting the job shown in Fig. 79 the first operation was to approximate the space on the copy, and then cast off the job by allowing eight picas for the first column, three and one-half picas for the second column, four picas for the third column, and six picas for the fourth column. This combination, with the three two-point vertical rules, makes up to twenty-two picas, the width of the page. Allow one-quarter inch spaces between lines; eighteen points are approximately one-quarter of an inch. If the space could be slightly greater than one-quarter of an inch, the setting could be simplified by using eighteen-point quads and one-point rules. If the space cannot be any greater, sixteen points must be put between two-point rules.

When planning a job, the compositor should always endeavor to put it together with the smallest number of units, and to use material that is self-spacing to the measure. Do not use material that must be justified to some pica length if some other material will fill the space without justifying. For example, in the first column material is desired that is sixteen points thick and eight picas long, but a combination of eleven-point and five-point to make up sixteen should not be used as each line would have to be justified with spaces. Nor would nine-point and seven-point be used, for the same reason. Two lines of eight-point would fill the space without justifying. If this material is scarce, ten-point and six-point quads will fill the space properly, but the ten-point lines will need justifying.

Twelve-point quads and two two-point leads will also suffice. If nothing but quads are used in one column, and a combination of quads and leads in another, it frequently happens that the column containing leads is longer than the other. This is evidently due to the fact that leads are not as accurately made as quads, and consequently run a little thicker than they should.

The job shown in Fig. 79 may be set by making up a stick to twenty-one and a half ems and setting the job straight cross. Use eight-point quads throughout. Eight picas (96 points) equal twelve eight-point ems; three and one-half picas (42 points) equal five ems and a four-em space; four picas (48 points) equal six ems, and six picas (72 points) equal nine ems. Set the first line by putting in twelve ems of eight-point, then five ems and a four-em space, then six ems, then nine ems. This will just fill the line. Set as many lines as may be required for the whole job. Place them on a galley. Now set the headings, but make up the stick to the different measures required. Place the headings in position at the top of the columns, slip in the column rules of proper length, and proceed to insert the horizontal rules. Begin at the bottom of the first column. Put a rule at the bottom to support the quads. Place the first rule between the second and third rows of quads, the second rule between the fourth and fifth rows, and so on up the column. This will give sixteen points between each two-point rule. After the first column is completed, proceed with the second in the same manner; then finish the third and fourth columns. Place a bevel-face rule at the head and foot of the job, with the bevel turned outward in both cases. If the columns are slightly too long or too short, the discrepancy can be adjusted by altering the space in the heading. Allow at least two points for "squeeze."

129. Wax-engraving.—An excellent imitation of rule work, and one which produces perfect joints, is obtained by a process known as *wax-engraving*. A metal plate is first coated with a thin layer of wax. This plate is then placed in a ruling-machine and lines of the proper width of face are ruled in the wax,

cutting through to the metal. If any lettering is required, the type is set up and pressed into the wax, down to the metal. After the work is approved, the wax part of the plate is built up, then dusted with plumbago, and an electrotype made and mounted.

Most of the diagrams and outline illustrations in this volume were made by this method. A rough sketch is furnished the artist, and the size is designated. He then sketches the design in the wax and submits it for approval. After it is approved the plate is finished and mounted, as described above.

130. Monotype Method of Setting Rule Work.—Fig. 79 (b) shows a rule job set complete by the Monotype system. The job was keyboarded exactly as shown, and the specimen composed on the caster. This is just as it came from the machine, without any attempt being made to fix the joints. Close inspection reveals the fact that it is built up of individual characters.

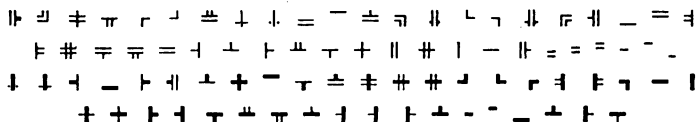

FIG. 82.—Characters used in Composing Jobs by the Monotype Method.

Every character is on a six-point unit, there being no long pieces of rule in the job. The blank spaces are made up of six-point em quads.

131. Casting Off a Table.—Fig. 83 shows a table set in eight-point, solid. The manuscript reached the printer without any designation for column size. The width of the whole table was given. Examination of the copy showed that the greatest number of figures was five, therefore there was ample room to make each column three picas wide. This accommodated a one-em quad on each side of the column of figures, and made the columns self-spacing. There are five columns three picas wide, which necessitated five two-point rules. This left six picas for

the first column, plus two points. The matter in the first column was set six ems wide. After this column was in type, a two-point rule was put alongside it and the other five columns proceeded with. Inasmuch as there were no words

TABLE GIVING STOCK NUMBERS FOR DIFFERENT STYLES OF REFRIGERATORS

Name.	Style A.	Style B.	Style C.	Style D.	Style E.
Arctic.....	10221	11332	12443	13554	14665
Frigid.....	4328	4429	4530	4640	4750
Ice-saver.....	1722	1822	1922	2022	2122
King.....	14267	14268	14269	14270	14271
Sterling.....	3621	3721	3821	3921	4021
	6 ems	3 ems	3 ems	3 ems	3 ems

FIG. 83.—Showing how a Table may be Made Self-spacing and Set in a Wide Measure instead of in Single, Narrow Columns.

among the figures, and it was simply a line-up of figures, the five columns three picas wide were set all at one time in a fifteen-em measure. First an em quad was put in, then the five figures, then two one-em quads (not one two-em quad, for a rule was finally to go between the two one-em quads), then five more

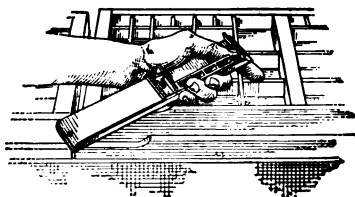

FIG. 84.—Best Way to Make up a Stick to a Narrow Measure.

figures, then two more one-em quads, and so on across the measure. All the lines were set in this way, until the table was completed. This left a dividing-line between the rows of one-em quads. The headings for the columns were set in a three-em measure. As it was impossible to get the thumb in the

bottom of a stick made up to three picas, it was found advisable to make up the stick as shown in Fig. 84, by using a two-em piece of metal furniture, leaving a space three ems wide between it and the end of the stick. Always follow this plan when setting type in narrow measures.

After the headings were all set and properly placed and spaced, a two-point rule of proper length was slipped between each row of one-em quads. This separated the type into columns. It was now found that the table was two points short of full width. This amount was added to the first column. The rule under the heading was made eighty-six points wide (seven picas and two points). A two-point lead was placed beside the heading and one between the type and rule below the heading. The top and bottom rules were added and the table completed.

When type is new the composed matter usually comes out according to calculation. If the type in the table shown had been old and dirty, there is a strong possibility that the two points additional would not have been required in the first column. One point might have been sufficient. When the additional space to be added to a table is very slight, or there is a great number of columns, compositors sometimes place *thin* pieces of paper each side of the column rules.

Table III, page 40, shows another type of work. Here the columns are narrow and there is so much to be gotten into the table that the columns cannot be made to multiples of pica. In this event make up to the figures. The figures are on en body, therefore make the width some multiple of the en, and use the en leader as a decimal point (one period on an en body). This makes the whole job self-spacing. Each line can be set straight across in a wide measure, and the vertical rules slipped into place after the table is set. Of course, when columns are not set to pica widths, labor-saving rules cannot be used under the headings, and rules of proper width must be cut to fit.

Whenever it is possible to do so, always set tables with narrow columns in this manner. They can be set in half the time that

it takes to compose them in narrow measures and then put them together.

When *leaders* are used they should run the full width of the column. (See "Glossary" for explanation of leader.)

132. Three-point Spaces of Eight-point.—Every font of eight-point type that is used for setting tables should be equipped with spaces three points thick instead of the ordinary thick-spaces. This gives a range of spaces varying by one point. The four-em space is two points thick, the thick-space will be three points thick, and the en quad is four points thick. By combining a thick space and a four-em five points are obtained, two thick spaces equal six points, and en quad and a thick-space equal seven points, and two en quads equal eight points. If the matter is being set in a measure made up to picas, and the type fills all but six points of the measure, a three-point space each side will just fill it. In fact, the use of the three-point space practically makes eight-point type self-spacing to pica measures.

133. Point-thick Spaces.—It is sometimes necessary to set a table leaded instead of solid. If the columns are wide and an even number of picas, ordinary labor-saving leads should be used. If the columns are very narrow and it would be necessary to cut a great number of short leads, it is better to double-up spaces of the proper size and thickness. The five-em space of ten-point is two points thick, the four-em space of eight-point is two points thick, and the three-em space of six-point is two points thick. By using these in combination, a spac^q of the proper width can usually be made up. In fact, if the job is to be leaded, this must be taken into consideration in casting off the job and, if possible, a measure chosen that will be some multiple of these spaces. From these three spaces, by using them singly or in combination, the following widths in points can be obtained: six, eight, ten, twelve, fourteen, sixteen, eighteen, twenty, twenty-two, twenty-four, twenty-six, twenty-eight, thirty, thirty-six, etc. If the space required between lines is three points, a great number of combinations may be built up by using the four-em space of twelve-point, the three-em space

of nine-point, the three-point space of eight-point, and the en quad of six-point. If four points between lines is required, the thick-space of twelve-point, the en quad of eight-point, and the three-em space of six-point may be used; two of the last-named, of course, being required.

The student should make a study of the inter-relation of spaces. Quads and spaces of one size of type can frequently be used with another size when there is a scarcity of material. A two-em quad of pica is the same size as an en quad of twenty-four point. A three-em quad of eight-point is the same size as a three-em space of twenty-four point. A three-em quad of pica is the same as a three-em space of thirty-six point. A two-em quad of eighteen-point is the same as an en quad of thirty-six point. A three-em quad of six-point equals a three-em space of eighteen-point. A two-em quad of nine-point equals an en quad of eighteen-point.

The list given has not exhausted the number by any means; it is merely suggestive. It serves, however, to illustrate the advantages of the point system.

134. Line-up of Figures.—The printer is occasionally furnished copy in which the matter seems to be in tabular form, but with the rules omitted. In other words, the copy is simply a line-up of figures. In cases of this kind there is no need to cast off the job into columns of any specified size. Set one full line of the type with the figures in approximately uniform position. If possible, have an even number of ems between each column, using quads for this purpose. Set all the lines straight across, making the figures line up in column form.

Type Size.	No. of Ems per Square Inch.	Rate per Square inch at 40 Cents per Thousand Ems.
6-point	144	.0576
8-point	81	.0324
10-point	51.84	.0207
12-point	36	.0144

FIG. 85.—Showing a Line-up of Figures.

135. Setting More Than One Column in a Single Measure.

—Matter that contains two or three columns, consisting simply of a line-up of material, can frequently be set more expeditiously and accurately in one measure than in narrow measures and then assembled; especially is this the case if the matter be leaded. The matter below is a sample of such composition.

BRIEF LIST OF ARTICLES FOUND IN THE COMPOSING-ROOM

Bodkin	Proof-press
Composing-stick	Quoins
Furniture	Quoin-key
Galley-rack	Reglet
Composing-stone	Type-gauge
Mallet	Tweezers

FIG. 86.—Showing a Line-up in Two Columns Set in One Measure.

Of course, if there is a possibility of alteration, and consequent overrunning after the job is set, it is better to set leaded matter in separate columns. But if there is no likelihood of change, it is advisable to set it as shown.

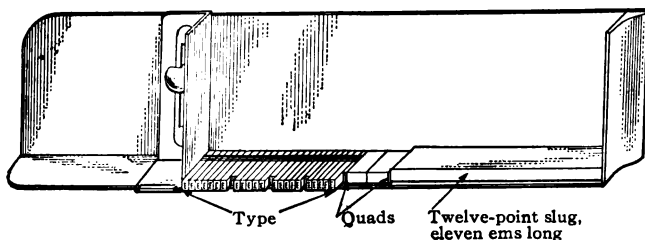

FIG. 87.—Setting Type in Two Columns in One Measure by the Use of a Twelve-point Slug.

Fig. 87 illustrates how this was done. The full measure is twenty-two ems. Each column is to be eleven ems wide. Obtain a slug or a piece of six-point or twelve-point rule eleven ems long. Set the type and put in a few quads until the line is about half filled. Put in the slug and justify the line. Remove

the slug, set the balance of the line, and justify it. Proceed in the same manner for all the lines.

Any number of columns can be set in this manner, by using slugs of a length that will leave each column of proper width.

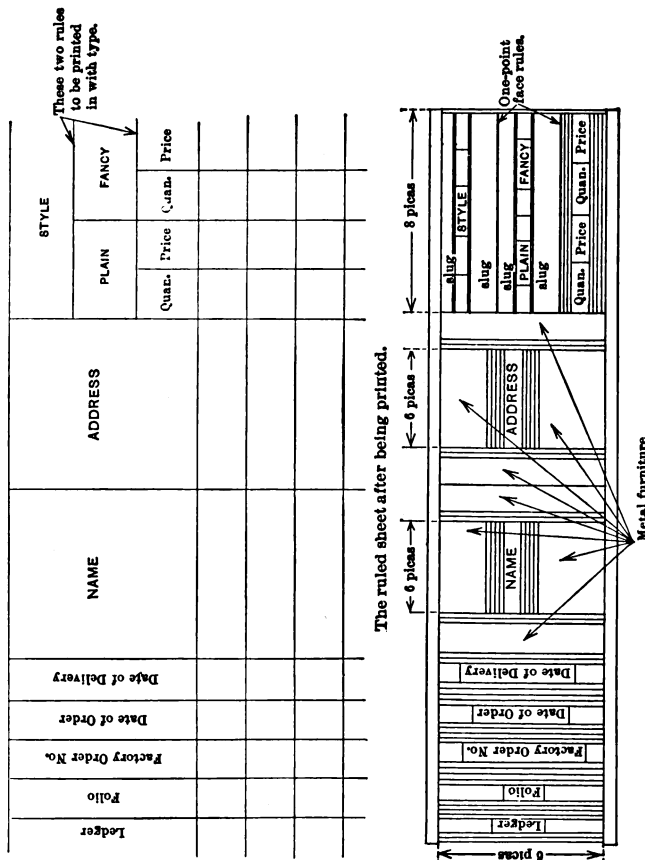

FIG. 88.—An Intricate Form of Blank-book Heading

136. Blank-book Headings.—Fig. 88 illustrates a rather intricate form of blank-book heading, and shows how it has been put together. If possible, always obtain a ruled sheet of a job before setting it. The secret of success in setting blank-

book headings is in allowing ample space for moving the type to fit the ruling. Every job should be put together in such a way that it can readily be moved *in every direction*. Many a compositor has come to grief because he did not allow for moving the type when the job is on press. If possible, cast off the columns to picas, so as to use labor-saving material; but do not do so if it brings the columns too close together. Better cut a few bastard leads while setting a job than run the risk of wasting time fixing it on press. If the columns are so close that there is a space of but six or eight points between them, it is better to make up the required amount with three or four leads than to have a single piece of material, for if the column needs moving the single piece will have to be removed and its equivalent made up of several pieces and inserted in its stead. It is better to put in that material when setting the job and avoid the necessity for change while on press.

The type in narrow columns should read *up* the sheet. Where a heading crosses two columns, the rule beneath it is sometimes printed in, as it is expensive and rather difficult to strike it in on a ruling-machine.

The best way to handle blank-book headings is to cut a section of the ruled sheet and place it in the composing-stick and set the type to fit the ruling, bearing in mind that ample allowance must be made for moving. If a sheet of the job is not available, mark off the columns on a narrow strip of paper, using the pattern sheet as a guide. The job may be set in sections, and then assembled on a galley. If a job only covers half a sheet, there is no need to set it full width of the sheet. It is advisable, however, to set it to a measure of which you have plenty of material; say forty, fifty, or sixty picas. This will save time and trouble when locking up the job for press.

137. Setting and Registering Type to Horizontal Lines.—When setting a column of type matter to be registered on horizontal ruled lines, make up your measure to the nearest pica size. See that you have plenty of leads before beginning the work. If leads of the size chosen are scarce, use a size that is

plentiful. Better to set it slightly wider than to cut material. If the column be a narrow one with nothing but figures in it, and you have plenty of room on the sheet, there is no need to set it in a narrow measure. It is unhandy to set type in a narrow measure and time can be saved by making the measure to a convenient width. Moreover, there is greater likelihood of having leads of the wider measure. If the job is in eight-point, or in some other size that is a multiple of pica, set the measure to eight, ten, twelve, or some other *even* number of picas. The figures will then be self-spacing. Make an approximation of the amount of space required between the lines and put in the leads while setting.

After the column is complete, use a sheet of the ruled stock for registering. This can be tacked to the side of a brass-lined wooden-rim galley, or it may be held in the hands. It is more convenient to tack it to the galley, as both hands are then left free. Get the first line of the type in register with the first ruled line on the sheet. Insert the required amount of space between the lines to make them all strike on the ruled lines. If the sheet is not ruled on the point system, it may be necessary to use cardboard between the lines to make them register. Usually, one-point leads will bring the lines sufficiently close for the purpose. After the horizontal lines are in register, if there is a heading, it should be put into register, and the column material moved so that the type lines will fall three or four points above the ruled lines. If there is an abundance of room between lines, it might even go more; but it should never be less than two points.

138. Running Type around Cuts.—The Monotype and Linotype methods of running type around cuts are described in Section 188. The method by which it is done by hand is here given.

When the cut is a perfect rectangle the job is comparatively simple. If the matter is leaded, arrange to have the type of some pica width, so as to use labor-saving leads. Just how much material is to be placed between the type and the cut will

depend on the amount of white space on the cut. There should be at least one pica of white space around the cut. If there is no white margin, all the space must be placed between the cut and the type. If there is an abundance of white space on the cut, the type may frequently be run almost up to it. Never place the type matter against the cut, but have at least a two-point lead between so that the ends of the lines of type will not press into the wood and prevent the job from locking up properly.

If, in arranging to have the type matter set to a pica width, it is found that one pica size allows too much, the difficulty can be overcome by setting the type to the larger size and indenting each line sufficiently to make the margin of the proper size.

If the cut is irregular in shape, and the type must conform to the outline of the cut, the job becomes a complicated one. Each job is a problem in itself, and the method of setting calls for an exercise of ingenuity on the part of the compositor. Fig. 89 shows a job irregular in outline, and the following description tells how it is to be put together.

Pull a proof of the cut, and draw a line around it, about one pica away from the edge, following the irregularity of its outline, to show where the type matter is to begin. Cut the paper to the width of the type page. Hold the proof to the light and mark the outline of both the cut and the type on the back. Cut the proof into pieces that will just fit the stick. Put the marked sheet in the bottom of the stick and set the type on top of it, using the marked outline as a guide. Set the full lines straight across, inserting leads if the matter is leaded. Where the matter begins to run down the side of the cut, place enough quads and spaces in the stick to make up a blank space where the cut is to go and begin the type at the pencil-line. Where the margin comes between the cut and the type put a one-em quad beside the type. This will be needed when the cut is put in position. Set as much as can be gotten in the line, and justify it by *spacing between the words*. Set the stickful in

this manner, making the type matter fit the penciled outline. Empty the stickful on the galley, put in the second half of the proof, and proceed with the balance. When the matter is assembled on the galley, there will be a blank space in the type matter made up of quads and conforming to the outline of the cut.

If the matter is to be electrotyped, and the original cut is to be inserted in the electrotype plate, there is no need to place it in the page with the type. If the job is to be printed from type or the cut must be placed beside the type, continue as

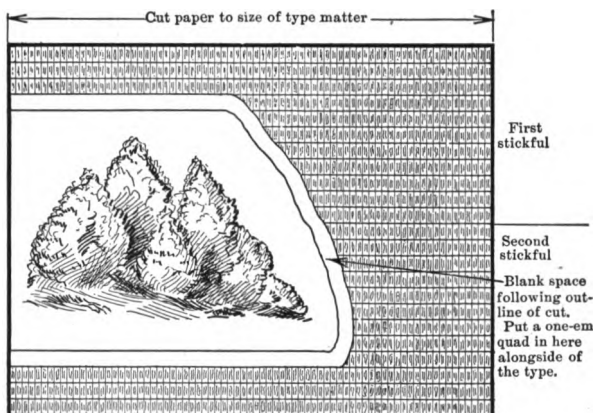

FIG. 89.—Showing How Type Should be Run Around a Cut Irregular in Outline.

follows: place the type on a galley as shown in Fig. 90, with the head of the job toward the left-hand side. Put furniture around it and lock it up. Cut out the proof of the cut close to its edge. Place this upside down on the type matter and mark the outline of the cut on the quads with a lead-pencil. As it is physically impossible to curve a lead to fit such outlines, in cases of this kind the type must come up against the cut. If the matter is solid the quads enclosed in the penciled outline may now be removed and the cut inserted. If the matter is leaded, the leads between the lines that are alongside of the cut must be shortened. They must be long enough to prevent the

letters from dropping down on the ends, but not long enough to bind. Obtain enough pieces of odd lengths (do not cut labor-saving material), mark the size that each is to be cut, making each long enough to reach from the cut to the end of the line, take them to the lead-cutter, and cut them all to proper size. If the lead-cutter is right beside you, they may be marked and cut one at a time, but do not waste time running a foot-race between the job and the lead-cutter. Remove a full-length lead and substitute one of proper length. This will leave all the quads loose except the one-em quads beside the type matter.

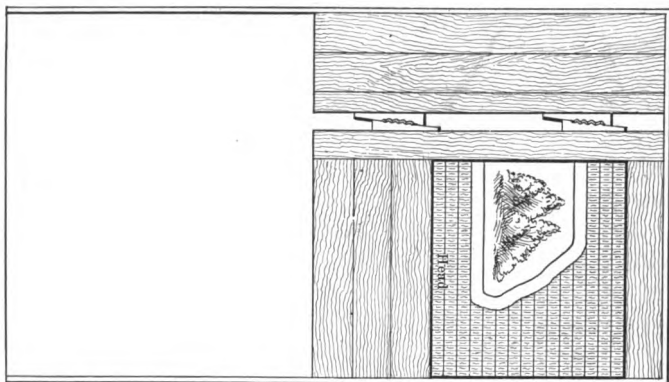

FIG. 90.—Type Matter as It Appears on the Galley after Insertion of the Cut.

Remove the loose quads and spaces. Slip the cut into place and put enough material above and below to justify it to page length. Now *carefully* place enough space between each em quad and the type to justify the line. If the em quad strikes the cut at an angle, and has a tendency to wedge the line out of plumb, insert a smaller size quad, and see that the pressure is exerted against the end of the line not against the side of the quad. The job is now complete. Place furniture all around it, so as to support the sides, and tie it up.

139. Setting Type in Circles.—Below are shown two forms of circles—a label and a job that was cut out after printing.

The printing of the latter is described on page 246. When type is to be placed in a circle made of brass rule the inside of the circle must be lined with leads or a slug to keep the type away from the rule. First determine the margin inside the rule and curve the material to fit. To do this cut a strip of stiff paper and curve it inside the rule. Mark the length that the lead or slug is to be. Cut it to size. If the office is not equipped with a curving-machine, the lead or slug may readily be curved by bending it around a mallet-handle or a shaft on a printing-press, care being taken not to bend it on the bias. Try the curve



FIG. 91.—Type Set in Circles.

inside the rule. If too long, cut it carefully so as to make a perfect fit.

There are two ways of placing a line around a circle. One is a tentative or rule-of-thumb method, the other an accurate one of determining the exact distance around the circle, setting the line in a stick, fastening it with gummed paper, and then curving it into place. The latter has a distinct advantage over the former in that the type is held in proper place and position. The former is the older and more frequently used method.

In the first method, after the circle is lined, determine what type is to be used, set it out of the case into a stick, with spaces between words. Place the type inside the circle, curving it to fit. When about three-fourths of the line is in place, it will be

necessary to curve a lead to fit inside so as to hold the line in position, leaving the lead slightly longer than it will be when finished. When the lead is in place, finish the line of type, leaving it a loose fit. Expand the inside curved lead, mark the correct length, cut it to size, and force it into place. If there is room, a second curved lead should be forced into place for the sake of stability.

Next set the horizontal lines, cutting leads to fit. Use slugs wherever possible, as they are firmer. When everything is in place and fitting loosely, first justify the horizontal type lines lengthwise, then force in enough material above and below the horizontal lines to wedge the inside tightly. Lastly, force enough space in the curved line to tighten it. Do not attempt to tighten the curved line until the inside is firm, or the curve may be forced out of shape.

The second method is the same as the first except that the curved line is assembled as follows: cut a piece of stiff paper to fit inside the lining of the rule. Determine what size type is to be used. The paper shows the outside diameter of the line; it is necessary to find the inside diameter. The circumference of every circle is 3.1416 times its diameter. As the line runs all the way around the circle, the inside diameter will be less than the outside by twice the body size of the type. To find the inside diameter when the outside is known, multiply twice the body size in points by 3.1416 to obtain the number of points *less* that the inside is to be. Measure off this number of points on the stiff paper, and cut it to size. Make up a stick to this measure, set and justify the line, but have a space at one end of the line. Now glue a piece of heavy manila paper to the bottom of the type. One or two thicknesses of gummed manila binding-paper is useful for this purpose. When the glue has firmly set, the line can be curved into position in the circle, and will fit it perfectly, each letter being held in perfect position radially. The balance of the circle should be finished as already described.

The circular job, Fig. 91, shows a cutout for a tally-card. It was mounted on a pin in the center so that it could be rotated

and each design brought into view through a hole in the mounting. It was very important that each design should be equidistant from the center, and that the central point should be printed. The first step was to cut a circular hole in an old electrotype block. This was lined with a slug and the characters assembled about the circle, uniform space being placed between them. A slug was curved to fit inside of the characters. A square block of wood was placed inside the circle and the job was justified by jamming material tightly at all points. The characters were now forced tightly into place. A proof was pulled, and the center of the circle determined. An electrotype tack was driven into the block, leaving the head

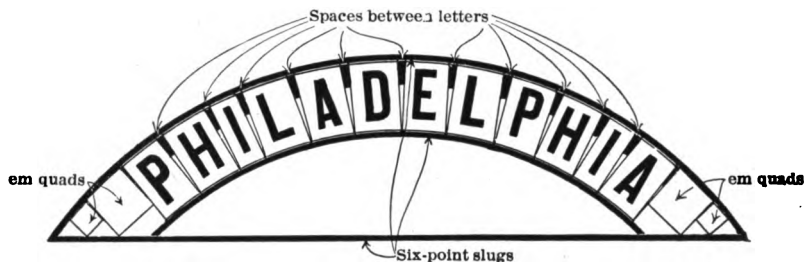

FIG. 92.—Showing How a Curved Line Should be Held in Position with Spaces.

of the tack level with the face of the type. The head was then filed to a blunt point. A proof was pulled, and the center tested with a pair of calipers. It was slightly out of center, but was bent into position with pincers.

When setting letters in a curve, the tops of the letters are spread apart while the bottoms are close together; the larger the letters, the broader the gap. In order to keep the letters equidistant, it is sometimes necessary to put spaces of a smaller size at the tops of the letters. (See Fig. 92.)

140. Algebra, Genealogies, and Pedigrees.—These represent the most difficult forms of all type composition. This treatise is too elementary to undertake to explain this intricate

work. The student will not be qualified to undertake it until he has mastered perfect justification in some of its simpler forms. He should, however, read the chapter on "Difficult Composition," in DeVinne's "Modern Book Composition," pages 171 to 230, and get an insight into the subject.

QUESTIONS ON CHAPTER IX

1. What is the Typotabular System, and how is it used ?
2. Explain how a hand-set ruled blank should be cast off.
3. What are Multio-Hexset Quadrats, and how are they used ?
4. What is a wax-engraving, and how is it made ?
5. Explain the Monotype system of setting rule work.
6. How should a stick be made up when setting type in narrow measures ?
7. Will the fact that type is new or old make any difference in the casting-off of a table ? If so, explain why.
8. Name the advantages derived by the use of three-point spaces of eight-point.
9. What do you understand by point-thick spaces ?
10. Tell what spaces or quads may be used as quads or spaces of another size.
11. What do you understand by a line-up of figures or type ?
12. Explain what method you would pursue in setting more than one column in a single measure.
13. How should blank-book headings be set ?
14. Explain how you would proceed to make a column of type matter register with the horizontal lines on a ruled sheet.
15. Is there any advantage in setting type to a narrow measure if it is possible to set it wider ?
16. Secure a piece of printed matter containing type run around a cut, and describe in full just how you would set the job.
17. Describe a method of running type around a cut that is irregular in outline.
18. Describe how you would set a round label containing circular and horizontal type lines.
19. How would you bend leads and slugs into circular form if a bending-machine was not available ?
20. Why is it necessary to place spaces between letters at the top of some curved lines ?

CHAPTER X

LOCKING UP FORMS

141. General Principles.—Many old-time printers, evidently under the impression that any old thing is good enough, are in the habit of building up their forms as shown in Fig. 93. This pyramid style of placing furniture is wrong. Contrast Fig. 93 with Fig. 94. Notice that the only bearing the furniture

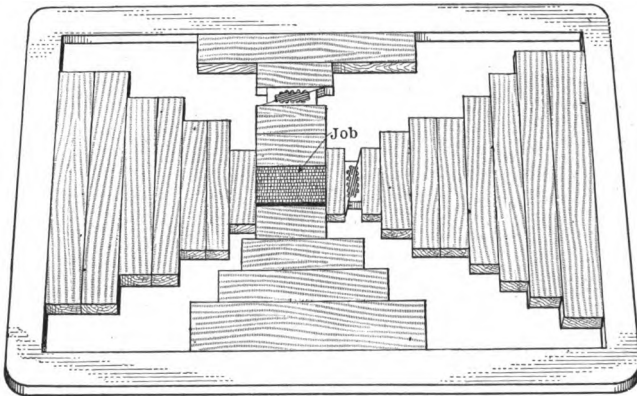

FIG. 93.—Improper Way to Lock up a Form.

in Fig. 93 has is alongside of the short end of the job. A form put together in this manner is very apt to work loose and pull out on press. When locked up in the proper way, as shown in Fig. 94, both job and furniture are being locked up at the same time and there is no likelihood whatever of the job working loose or pulling out.

Fig. 96 shows another form properly locked up. The job, as originally set, was not the same length as the wooden furniture used in locking it up. It took but a few moments to add enough material to make it full length.

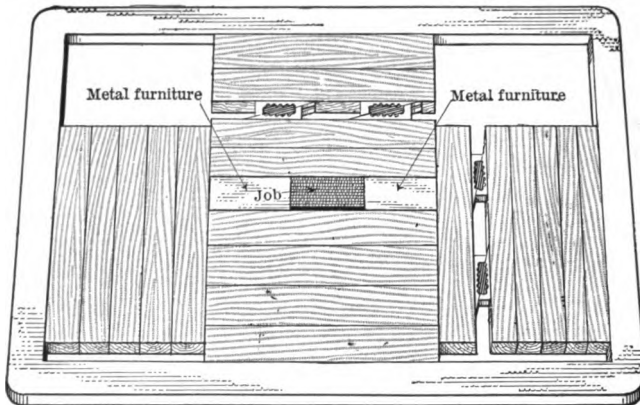

FIG. 94.—Proper Way to Lock up a Form.

142. **Quoins.**—Wedge-shaped devices, known as *quoins*, are used for locking up forms. For many years wooden quoins

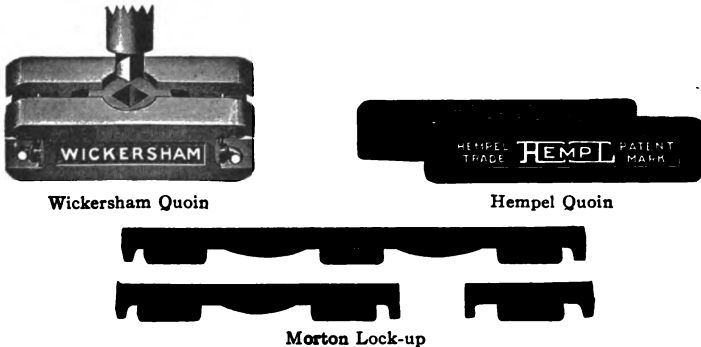

FIG. 95.—Some Standard Forms of Iron Quoins.

were the only kinds in use, being driven together with a shooting-stick. Then came iron quoins, locked with a key. Today

there are quoins for every imaginable purpose. Fig. 95 illustrates a few.

143. Locking up a Form.—In general, jobs are locked up in certain ways for convenience in handling the sheet or to secure better rolling of the form. Jobs containing rules are usually placed in the chase in such a way that the rollers do not strike the ends of the rules. (See Section 216 for method of preventing perforating-rules from cutting the rollers.) Inasmuch as it is more convenient to have the guides on the left-hand side of the tympan, jobs are usually locked up head to the left. There are special cases, however, when this is not done. Letterheads that contain but few lines are usually locked up head down. Envelope corners may be either head or foot down if the envelopes are not opened (*i.e.*, the flap turned up), always foot down if the envelope is opened.

It is always advisable to lock up a form so that the pressman can read the printed matter on the draw-sheet while running the press, for by so doing errors are frequently detected.

Fig. 96 shows how a letterhead should be locked up. It has been placed head down in order to get a better roll. The job has been set forty-five picas wide, and it is nine ems deep. Put fifty-em furniture above and below, as shown. Add a piece of metal furniture 5×10 to build job out to fifty ems. Place enough material at the bottom of the job (one pica in this case) to build the job out to ten ems. Use nothing but fifty-em furniture, arranging the same in a neat manner. Do not have the furniture all zigzag; a good compositor is neat in everything that he does.

After the furniture is in place, put in the quoins. They should be arranged as shown in the figure. Note that the points of the quoins alongside of the form are pointing toward the lower left-hand corner. This is the point toward which you wish to drive the form. If the quoins are placed in the reverse position, they will be driving against the quoins on the other side.

Having placed the quoins in proper position, lock up the form tight enough to lift. Stand it on edge, and remove all

dirt and grit from the bottom, using either the hand or a brush. Also brush the stone, if it seems dirty. Replace the form on the stone, loosen the quoins, arrange the furniture neatly, and push the quoins together as tightly as possible with the fingers. Then plane the form with a planer and mallet; first rubbing your hand across the face of the planer to remove anything that may have adhered to it, and which would very likely batter the type.

The word *plane* means to make level. That is why the form is planed—to make it level. To see some men planing a form

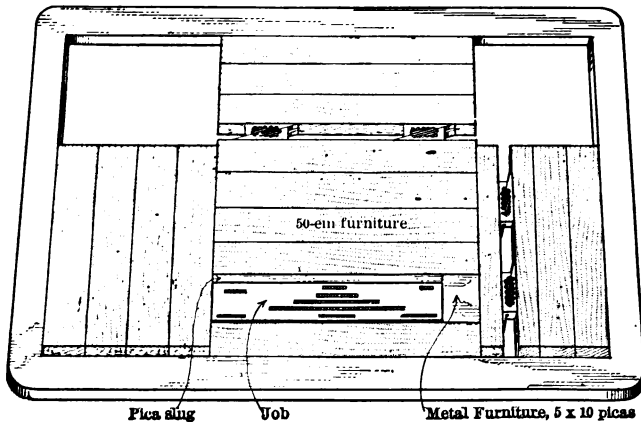

FIG. 96.—Proper Way to Lock up a Letterhead.

you might think that planing meant to drive the form into the stone. It requires but a very light tap of the mallet on the planer to drive down any letters that may be projecting. Do not drag or slide the planer over the form, but lift it when moving it from point to point over the form. If you slide it, any type that may be sticking up is apt to be broken off. When you replace the planer on the stone (or, better, a shelf provided for it) *do not lay it on its face*, as it is apt to pick up grit.

Every form possesses two dimensions—length and width. Every form also possesses a certain amount of “give” or “springiness.” The way in which it has the greatest amount of give is the side that should be tightened first. In the letterhead in Fig. 96 we should start at the top and tighten the quoins a little with the key. This will remove the greater part of the spring. Then tighten the quoins on the side a little; then the top; then the side. In this way go over the quoins until the form is “tight enough.” This can only be learned by experience. When the form is so tight that the letters cannot be pushed out by a fairly good pressure of the fingers, it is tight enough. Do not exert extreme pressure in locking up, for it is comparatively easy to break a cast-iron chase.

After the form is locked up, raise it above the stone by placing something under *one* edge, and try to push down the letters. After the whole form has been gone over in this manner, stand it up on one edge and rub the hand across the bottom of the form. If any letters are loose and have been pushed down, they will be detected. Do not drop the form flat on the stone after trying it for loose letters and before rubbing the hand across the bottom, as this would push the letters back in place. See that everything is tight before sending a form to press.

144. Bearers.—In many offices it is customary to use *bearers* in job-press forms, the popular belief being that they prevent the rollers from bearing too hard on the form. A brief inspection of rollers that have been run on bearers will prove that the bearers do not bear off the rollers, but that they actually sink into them. Bearers are useful only under certain conditions.

145. Gudgeons.—In all types of job printing-presses the rollers are moved up and down across the face of the type. On each end of the roller-stock is a wheel, known as a *gudgeon*, that rolls on a track at the side of the press. This track should project 0.918 inch (type-high) from the bed of the press. The gudgeon should be *exactly* of the same diameter as the roller. The roller-stock should be keyed to the gudgeon.

When these perfect conditions prevail, if the rollers are not bearing firmly enough on the form, all that is necessary is to put a few sheets of paper back of the form; if the rollers are bearing too firmly on the form, glue a strip of cardboard on the track. In the Victoria Press the rollers are raised or lowered by moving the whole track with an adjusting-screw.

If the rollers and gudgeons are not exactly of the same diameter, the one of greater diameter will roll farther than the other. For example, suppose that the circumference of the roller is six inches and that of the gudgeons only five and one-half inches, what becomes of the other half inch? The gudgeons in rolling are rotating the rollers, both making one revolution in the same period of time; the circumference of the roller, however, moving six inches while the gudgeons only move five and one-half inches. That half inch is gained in the five and one-half inches, the roller sliding over the form instead of rolling. The same thing will happen if the rollers are smaller than the gudgeons. In this event, it will slip in the opposite direction. *The contact of the roller on the form should be a rolling contact, not a sliding one.*

If the roller is sliding instead of rolling, it will fill up the type, and produce smeary prints. It will also wear out the roller-pins, which finally break, leaving the roller free to revolve in the gudgeons.

It is only when rollers are loose in the gudgeons that it is advisable to use roller-bearers, as they will cause the rollers to roll over the form and not drag; but *they will not bear off the rollers from the form.*

There are adaptable and adjustable gudgeons on the market, so devised that the pressman may always have them of proper diameter for his rollers.

146. Locking Up Register Jobs.—While there are devices made especially for registering jobs without unlocking the forms, every office is not equipped with such devices. When imposing a form that may have to be moved to get it into register, always place about six two-point leads at the side away from the quoins. Then, if it is necessary to move the job, it can be done without

disturbing the furniture. If the form be made up of plates, use leads or furniture at each of the four corners, as shown in Fig. 97. This will permit of twisting the plates if necessary.

When a register job is first locked up for press, a chalk-mark should be made across each quoin in such a way that it marks the quoin and the furniture that it abuts. Every time the form is unlocked and a change made, exactly the same amount of material should be put back into the form, and the quoins and furniture put into their original positions. When the quoins

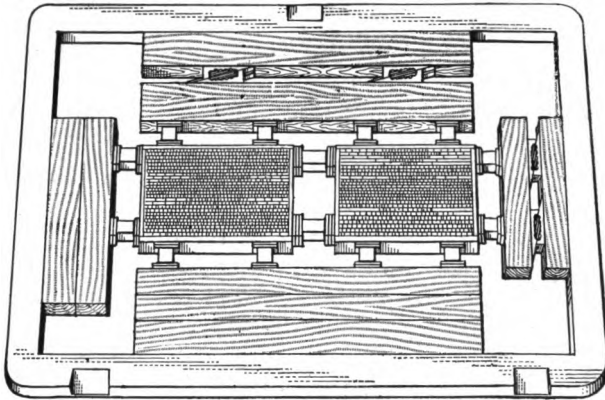

FIG. 97.—Method of Locking up a Form so that it May be Easily Moved.

are tightened, the chalk-marks will all come into perfect alignment. When this occurs the form is locked up exactly as it was in the first instance. In no other way can you be assured that such is the case. It is a very easy matter to exert more force at one time than at another.

147. Locking-quoins.—There are several *locking-quoins* on the market, operated with a spring-actuated catch that engages in a rack on the quoin. After the quoin is tightened the catch is released, when it engages in the rack, and the quoin is locked. It is impossible for the quoin to slip.

When running register jobs, pressmen frequently resort to the expedient of plugging the quoins with a wad of moistened paper, which, when dry, holds them firmly in place.

148. Jobs with Rules.—Jobs containing rules should, if possible, be locked up in such a way that the rollers will not strike against the ends of sharp rules, for they may cut the rollers. Forms are frequently locked up at an angle, using wedge-shaped furniture, to prevent any cutting of the rollers.

Perforating-rule that is locked up with a job and imposed so that it is vertical in the chase, should run off the sheet, and should have a two-point or three-point face-rule at the top and bottom. This will prevent the rule from cutting the rollers. The marking of the tympan may be prevented by the use of a frisket. (See Section 212.)

Fig. 98 shows the proper method of locking up the two sections of the rule job shown in Fig. 51 on page 109. The guide-edge is marked. Observe that the top and bottom horizontal rules are printed in the form with the vertical rules. This should always be done. It prevents the rollers from striking the sharp ends, and also guarantees a perfect joint. If the sheet does vary a little it will not show a gap between the vertical and horizontal rules, as it undoubtedly would do if all the vertical rules were in one section and all the horizontal ones were in the other.

149. Allowance for Squeeze.—It is almost impossible for a compositor to set a job inside of a border and squeeze it together so tightly that it will look all right on the galley and still make a perfect joint when locked up. Some allowance must be made for squeeze. If the job contains many lines of type and much spacing material, it will have more springiness than if put together with considerable solid furniture. The job should be squeezed together as tightly as possible and then about two points more put in to allow for squeeze. If very springy, allow four points.

150. Troublesome Corners.—When locking up a job with a rule border, make a perfect fit of the corner away from the

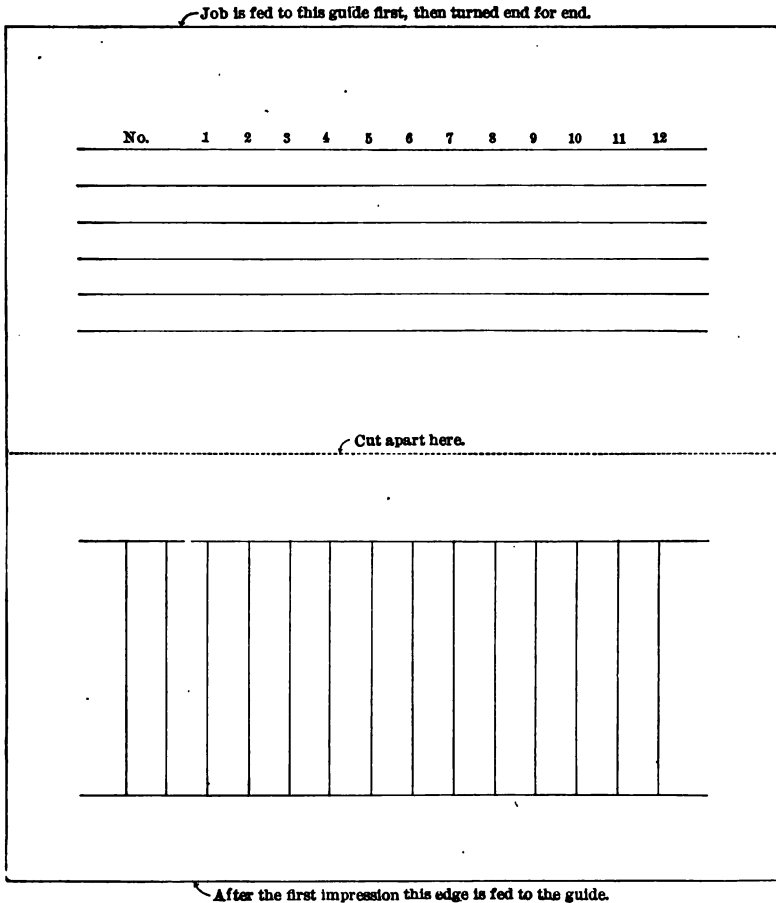

FIG. 98.—Showing Lock-up of a Rule Form in Two Sections, to be Printed at One Time. When the sheet is turned end for end the two sections will overlap, thus producing two copies.

quoins by pushing the rules together with a piece of wooden furniture. Never use a bodkin for this purpose, as it may batter the end of the rule and prevent a perfect joint. Now lock up the form carefully until all the corners come together perfectly. Use a try-square to see if the ends and sides are at right angles.

If a corner should prove a little refractory and persist in gaping open, a little beeswax melted into the joint by the heat of a lighted match may overcome the difficulty. After the wax hardens, trim off the surplus. Tinfoil placed in the open joint, and the surplus trimmed off, has also proved effective.

151. Squaring the Form.—Every form with a border, or which has rules, either horizontal or vertical, or any element whatever that would mar the appearance of the work if it was not at right angles with the sides of the paper, should be tested with a try-square before sending the form to press. This will frequently save a useless waste of time in the pressroom, for, if the job is not square, it will be returned to the composing-room for correction. Learn to do things correctly. It is the doing of the little things correctly that constitutes perfection.

152. Wooden Furniture.—No matter how carefully wooden furniture is kept, it will shrink, and some of it will warp. Warped furniture is fit only for kindling-wood. Throw it away; it invites trouble, and wastes time.

When using wooden furniture to make up forms for cylinder presses be sure that the pieces are all of the same width. Some pieces shrink so badly as to be unfit for this purpose. They are all right for job forms, but are not to be relied on for making up margins.

Four-em wooden furniture has a groove running the length of one side: this is the top, use it this side up. It is almost, *but not quite*, square. Therefore if turned on its side it does not measure four picas.

Never use water on wooden furniture.

153. Riding of Forms.—When locking up a small form, it will sometimes be noticed that it has a tendency to “ride”—

that is, the pressure causes the matter to bulge up in the center. Unlock the form and see if anything has dropped down between the type and the furniture. If the cause is not discovered in this way, take out a few of the pieces of furniture and place them side by side on the stone and see if a gap is visible between them *at the bottom*. See Fig. 99. Sometimes the furniture is slightly wider at one point than at another. If this proves to be the case, either insert other furniture, or turn one or two of the sloping pieces upside down, when they will counteract the slope of the others, and the form will lock up without riding.

The riding of forms on cylinder presses is also a frequent cause of trouble. This is usually due to the fact that the

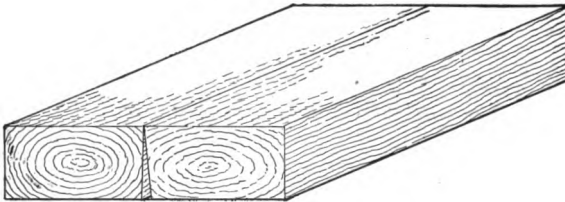

FIG. 99.—Showing Two Pieces of Warped Wooden Furniture. When pressure is applied by the quoins the furniture will ride.

material is wider at the top than at the bottom. In locking up, the form is slightly raised. As the cylinder goes over the form, the type is slightly raised. As the cylinder goes over the form, the type is slightly raised, but not the furniture. After the cylinder has passed, the type comes up again, and brings the furniture with it. This continues until the furniture is high enough to be inked by the rollers and leave an impression on the sheet, thus spoiling the sheet.

To overcome this trouble, unlock the form and see if anything is binding. If not, then examine the furniture, and reverse a few pieces as directed above. If this does not correct the trouble, cut long strips of thin cardboard about one pica wide and drop them down alongside of the material that is riding. This will usually rectify the trouble. As a last resort,

pressmen are sometimes compelled to drive small nails into the furniture to keep other material from riding.

QUESTIONS ON CHAPTER X

1. Describe the proper way to lock up a form.
2. Why is the pyramid style an improper way of locking up a form ?
3. What is the meaning of the word " Quoin " ?
4. Name the different quoins with which you are familiar.
5. Explain the action of a quoin.
6. How should quoins be placed in a form ?
7. When locking up a job containing rules, how should the job be placed in the form ?
8. Why should a job be so placed in a chase that the pressman can read the printed matter on the tympan ?
9. Why should a planer never be dragged over the face of a form ?
10. Why should a planer never be laid on its face ?
11. Why is it important to begin to tighten the quoins in a form at some specified place ?
12. What will happen if the tightening of quoins is not begun at the right place ?
13. How would you test a form to make sure that it is tight ?
14. What is a roller-bearer ? Of what use is it ?
15. What is a gudgeon ?
16. Explain fully why it is so important to have rollers and gudgeons of *exactly* the same diameter.
17. If the rollers were pressing too heavily on the form, how would you overcome the difficulty ?
18. If the rollers and form were not in contact, how would you bring them together ?
19. How should register jobs be locked up ?
20. If the corners of a rule job did not come together, how would you rectify the matter ?
21. What expedient do pressmen sometimes resort to to prevent quoins from slipping ?
22. Why is it important to make a chalk-mark across quoins and furniture after a register job is locked up for press ?
23. When a rule job consisting of horizontal and vertical rules is made up into two forms, why is it important to have the top and bottom horizontal rules placed with the vertical rules ?
24. What do you understand by " allowance for squeeze " ?

25. What difficulties are likely to be encountered if warped wooden furniture is used in making up a form ?

26. Why is four-em wooden furniture marked with a groove along one side ?

27. Which is better for making up margins in forms, wooden or metal furniture ? Tell why.

28. If a form was "riding" on press, what would you surmise was causing the trouble ?

CHAPTER XI

IMPOSITION

154. Placing Pages on the Imposing-stone.—Imposition is the name given to that branch of printing which has to do with the proper placing of pages on the imposing-stone so that when the pages are printed on the sheet, and the sheet folded, the pages of the book will open out consecutively. A moment's thought will reveal the fact that the pages cannot be laid out on the stone side by side in regular sequence and be in proper position for a folded sheet. Pages that back each other must be at opposite parts of the form.

There are two ways of getting the proper pages to back up. First, by printing a form on one side of the sheet then turning it over and backing it up with the same form. This is called a "work-and-turn form." The sheet is cut in half, furnishing two copies. Second, by printing a certain number of pages on one side of the sheet then backing it up with another form. This is called working "sheetwise," and requires two forms to produce one printed sheet.

If a sheet of paper (say 9×12 inches) is folded once (to 6×9 inches) it will make two leaves, or four pages. If it is desired to bind up a number of pages into a book, either by sewing or by stitching through the back (saddle-stitched), the number of pages in a form must be in multiples of four. That is to say, the form must consist of four, eight, twelve, sixteen, twenty, twenty-four, thirty-two, sixty-four, or more pages.

If the job is to be wired through the side other combinations of pages may be made up, but such combinations are so unusual that a description would tend to confuse rather than aid the beginner.

Inserts consisting of single leaves are glued into sewed books, but they may be wired into books that are stitched on the side.

155. Hand- and Machine-folding.—The first question asked by the compositor when he is given a form to impose should be whether the sheet is to be hand-folded or machine-folded, because the lay of form for hand-folding is not the same as for machine-folding, nor is the lay for machine-folding the same for all machines. If but a few hundred copies are to be furnished, it is a foregone conclusion that the job is to be folded by hand; if a great number of copies are required, it is equally certain that the job will be folded on a machine. If there is a question as to what machine is to be used, the compositor should consult the bookbinder.

156. Margins.—Whenever two or more pages are printed together, the question of margins must be taken into consideration. If the job to be imposed is a circular, and the sheet is simply to be cut apart, and not to be bound and trimmed, the margins will be made up to the finished size. If the sheets are to be trimmed after printing, allowance must be made for trimming. The majority of books are trimmed around three sides—top, front, and bottom. One-quarter inch is a fair allowance for trim, but this is not always possible. It is frequently necessary to do with less in order to get a job out of a sheet of paper of stock size.

157. Determining Margins.—Fig. 100 shows the proper method of determining margins. Assuming that two pages are to be printed, that the finished size is to be six inches, and that the pages are of the same size, the distance from the edge of one page to the edge of the other page should be made just six inches. If the job is a circular, fold a sheet of the stock in half, and make the distance between the edges the same as the folded sheet. (Fig. 101.) When the guides are properly set, each page will be in the center.

If the pages are of unequal size, mark off the center of each page, and make all necessary measurements from the centers instead of from edge to edge. (Fig. 102.)

158. Determining the Lay of a Form.—While diagrams are usually available for reference, so that the compositor may

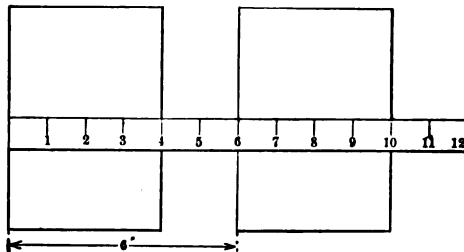

FIG. 100.—Making up Margins to Given Dimensions.

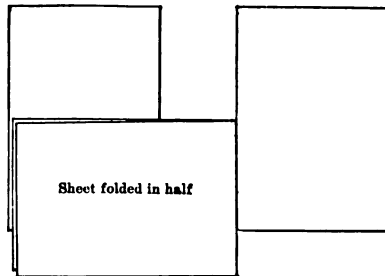

FIG. 101.—Making up Margins to Half of Sheet.

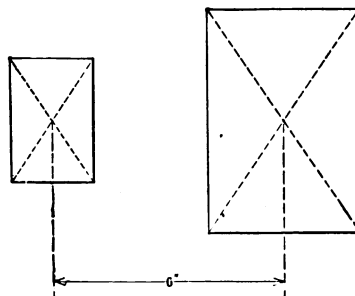

FIG. 102.—Determining Margins when Pages are of Unequal Size.

verify his work, it is advisable that he should know how to mark a dummy form and determine the lay of the pages. Inasmuch

as the type is in reverse of the printed sheet, it follows that pages printed to the right of the sheet must be imposed to the left of the form. To determine the lay of a sixteen-page form, fold a sheet of paper, say 8×12 inches, over and over as shown

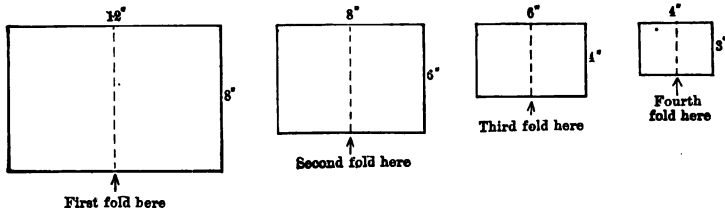

FIG. 103.—Showing Successive Foldings to Produce a Dummy.

in Fig. 103 until finally the size 2×3 inches is obtained. This will produce a dummy form.

As the form is to be worked and turned, folios are to be marked on only one side of the sheet. To get the folios on the

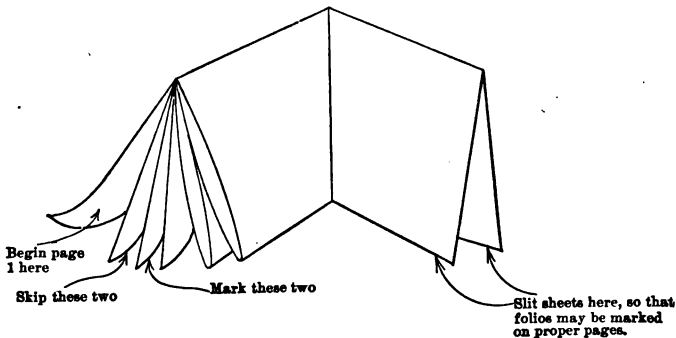

FIG. 104.—Showing a Folded Dummy with Proper Places to Mark Folios.

dummy so as to show the proper position on the stone, mark page 1 on the inside of the first leaf—in reality, what would be page 2 of a printed sheet. See Fig. 104. On what would be page 3 mark folio 2. Now skip the next two pages, for they will be on the other side of the sheet when it is opened out. Now

mark pages 3 and 4; then skip two pages and mark the next two. In this way go through the dummy, skipping two pages, marking the next two. After the first eight have been marked, it will be found that the folded leaves will have to be slit at the lower corners so that the folios may be marked in proper positions. Mark them.

Now open out the sheet. If the marking has been properly done, the folios will all be on one side of the sheet, and in the positions in which the pages should be placed on the stone.

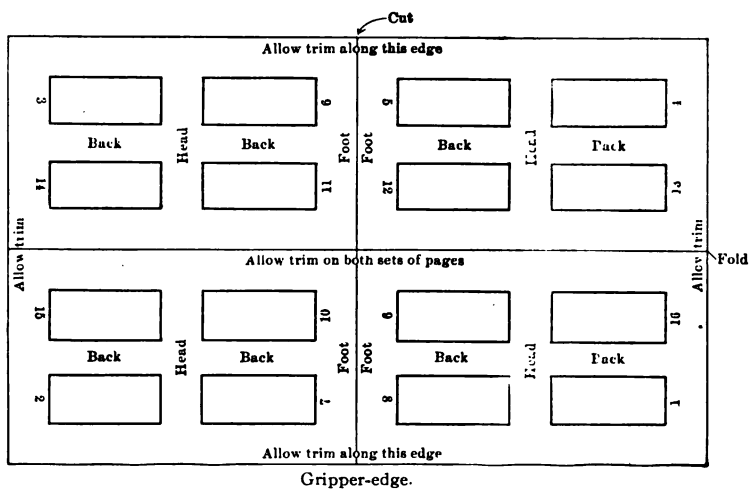

FIG. 105.—Diagram Showing Various Parts of a Form.

Compare with the lay of the form shown in Fig. 105. The lay of any form may be determined in this way.

Some compositors fold the sheet as described, and instead of marking the pages by beginning on the first inside page (page 2), they begin on the outside on page 1, and, marking two and skipping two, go through the dummy. This places the pages as they will be printed on the sheet, not as they should be on the stone. The first method is to be preferred, as it is sometimes puzzling to reverse the pages from the printed sheet.

If the job is to be folded on a machine, it is better to obtain a dummy from the binder, for some of the forms have to be laid inside out.

159. Various Parts of a Form.—In order that the terms used in imposition may be fully comprehended, Fig. 105 and the accompanying explanation are here given. The form shown is a regular sixteen, and is to be folded by hand.

The point marked *cut* is where the sheet will be cut apart, thus making two copies.

The point marked *fold* is where the first fold will be made.

Trim is to be allowed in every place but the *back*, which is to be made up to the trimmed size.

It will be observed that the pages are all imposed *head to head* and *foot to foot*. This is imperative; they will not fold properly if placed in any other way.

The *gripper-edge* is the edge fed to the *guides*. As the sheet will be turned right and left on the press, the same edge always comes to the *grippers*, which are the fingers that hold the sheet to the cylinder.

The page numbers are called **folios**.

Notice that pages 1 and 16, 2 and 15, 3 and 14, 4 and 13, etc., come back to back. Notice, also, that the sum of the folios of each of these pairs totals 17, which is one more than the total number of pages. This prevails for every kind of form where the pages are bound into a book. If it were a 32-page form, and the folios ran from 1 to 32, each pair of pages would total 33.

The form shown is a *work-and-turn form*. If these same pages were to be worked in two forms (*sheetwise*), the pages would be imposed exactly as shown, but the right half would constitute one form and the left half the other. If worked sheetwise the right-hand edge becomes the gripper-edge for the right half of the form, and the left-hand edge becomes the gripper-edge for the left half of the form. This seems almost obvious, for page 2 must back up page 1, consequently the edges named must be run to the guides. The lowest folio in any form should be run toward the grippers.

If a sheetwise form is being imposed, the pages which go in each half of the form may be determined by placing the entire number in a row and cancelling each alternate two, beginning with page 2: thus

1 2 3 4 5 6 7 8 9 10 11 12 13 14 15 16

From this we determine that pages 1, 4, 5, 8, 9, 12, 13, and 16 go in one form, and pages 2, 3, 6, 7, 10, 11, 14, and 15 go in the other. Compare with Fig. 105.

It will be noticed that the two center pages of the form (8 and 9) come head to head with the two outside pages (1 and 16). This prevails in all forms, regardless of the number of pages. (See Fig. 106.)

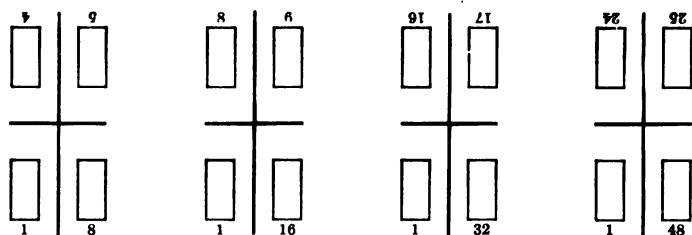

FIG. 106.—Showing How the Inside and Outside Pages of Various Forms Come Together.

In every pair of pages, if the foot of each page is toward you, the uneven folio is always to the left; if the heads are toward you, the uneven folio is on the right. (See Fig. 106.)

160. Imposing the Form.—The sixteen-page form is a convenient one to use as an illustration of the proper method of imposing forms, and the statements which follow apply to such a form.

Before placing the pages on the stone, see that it is perfectly clean. Arrange the pages as shown in Fig. 107. Obtain a *chase* (see Section 172) large enough to enclose the form and

still allow room for the quoins. If the chase is one that just fits the bed of the press, make certain that the type does not come outside of the *dead-line* on the press. There is a line marked on the bed of every cylinder press, known as the *dead-line* or *gripper-line*. If the form is placed too close to the edge of the chase and comes beyond the *dead-line*, the grippers will strike the type and batter it, and perhaps mash the grippers. Every pressman has (or should have) a *gripper-gauge*. The

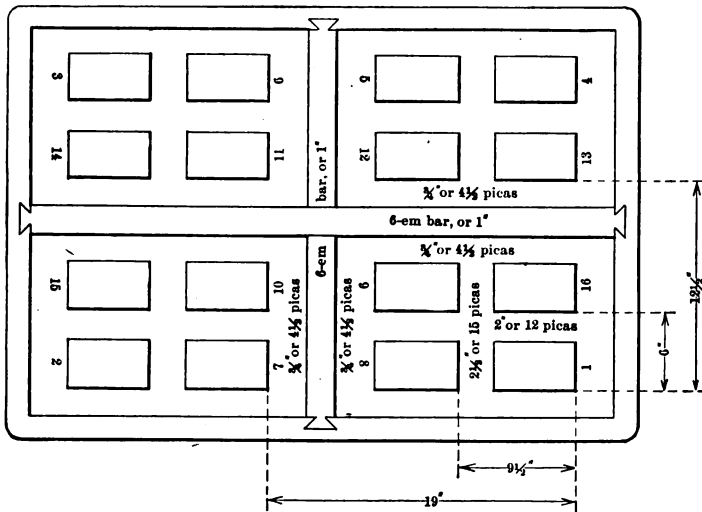

FIG. 107.—Diagram Showing Make-up of a Form.

type must be placed far enough from the edge of the chase to avoid hitting the grippers. To accomplish this it is sometimes necessary to place the type nearer to the long bar on one side than on the other. Determine the proper distance with the *gripper-gauge*.

The top of every cylinder chase is marked in some way to distinguish it. If the chase has shifting bars, it is important to know the top, because the bars are always put in from the top. They slide into dovetail mortices, and taper from top to bottom.

When removing a bar, always tap on it from the bottom. To strike it on the top would wedge it more firmly into the mortice.

When chase-bars become loose from constant shifting, it is sometimes necessary to turn the chase upside down to prevent the bars from "riding," or working up.

Where much locking up of cylinder forms is done, the office is equipped with an abundance of furniture of various widths and lengths, so that combinations of any size may readily be made. If the office is not so equipped, the compositor is compelled to use whatever labor-saving material may be at hand, or else cut material to fit. Each form may, therefore, become an individual problem.

Either metal or wooden furniture may be used. Metal is accurate, but heavy; wood is light in weight, but unreliable for width, as it is liable to shrink. If wood is used, each combination should be tested before being placed in position.

Wooden furniture has less tendency to "ride" than metal. If wooden furniture is used, care should be exercised about the four-em pieces. The groove is on the top of the furniture. It will not measure four ems if turned on its side.

After the pages are properly laid, and the chase placed around them, the amount of space necessary in the back should be determined.

Assume for the sake of illustration that this job of sixteen pages is to be printed on a sheet 25×38 inches, that it will be trimmed to 6×9 inches, and that the pages of type measure 4×7 inches. The sheet after printing and folding, and before trimming, will measure $6\frac{1}{4} \times 9\frac{1}{2}$ inches. This will allow one-quarter of an inch trim on the top, front, and bottom.

Begin at page 1 and measure from the left-hand edge of page 1 to the left-hand edge of page 16. Make the distance six inches. The type is four inches wide, so a combination of material will be needed to make up to two inches, or twelve picas. The page is seven inches long, therefore, the material to be used in the backs must not be less than forty-two picas long. It should be longer. If fifty-em pieces are the nearest

you have, use them. Make up eight sets of the combinations twelve picas wide, and place one set in each back throughout the form.

Next, make the distance from the foot of page 1 to the head of page 8 exactly nine and one-half inches. This will leave two and one-half inches, or fifteen picas, as the distance between heads. The width of the page is four inches, or twenty-four picas. Make up eight combinations of metal furniture 23×15 picas. Furniture twenty-three picas wide is used so that the pages will not bind. Place the material in the eight heads throughout the form.

Now measure from the left-hand side of page 1 to the left-hand side of page 13. This should be twelve and one-half inches, or just half the sheet. This will leave two and one-half inches, or fifteen picas, between pages 16 and 13. Deduct the width of the bar (let us assume that it is one inch, or six picas), and place one-half of the remaining amount on each side of the bar. This will be three-quarters of an inch, or four and one-half picas. Do not place metal furniture alongside of the bar; use a six-point reglet along with the four-em furniture.

Next measure from the foot of page 1 to the foot of page 7. This should measure nineteen inches, just one-half of the sheet. The same amount of material will be needed here as alongside of the other bar—four and one-half picas. Put a 4×23 -em piece at the foot of each page and a six-point reglet on each side of the bar. If there should be folios at the bottom of the pages near the short bar, do not measure to the folio, but to the last line of the page. Let the folios go into the margin.

All the material has now been placed inside the form. Place wooden furniture along the outer sides of the pages and wooden furniture at the foot of each outside page. Place one pair of quoins at the foot of each page, and two pairs on the side of each page. Remove the strings from the four pages in one quarter-section of the chase, beginning at the page nearest the center. Finish one quarter-section before proceeding to the next. As the string is removed from each page, close the furni-

ture around it and push it toward the center of the chase. Wind the string carefully, as described in Section 37, unless the strings are to be returned to the maker-up for immediate use.*

After all the strings have been removed, and the pages pushed toward the center, place enough wooden furniture between the quoins and the chase to just fill the space. Look across the heads of the pages and see if they line up. If not, put in enough material to make them do so. A long straight-edge is an excellent thing for this purpose, but be sure that the two end pages are both of the proper length before testing.

The quoins should be placed so as to drive toward the bars. (See Figs. 94, 96, and 97.) Force the quoins together as tightly as possible with the fingers, plane the form, and tighten the quoins with a key. Do not tighten each quoin to the full limit at once, however, but go over the whole form, beginning at the bottoms of the pages, tightening each one a little at a time, until the whole form is tightly locked up. To lock a quoin to full limit at once would have a strong tendency to "spring" the bar. *Do not plane the form after it is locked up.* The lock-up may be tested by propping up one side of the form and trying to push the letters down with the fingers.

If a proof of the form is required, lock the form just tightly enough to prevent the letters from pulling out, and then proceed to beat off the proof as described in Section 27. Each pair of pages lying back to back throughout the form should be proved on a single sheet. Then when the proofs are lifted they may be folded together like a book.

161. Pages Out of Center.—The description just given was for pages centered on the sheet. Quite a number of our best typographical productions are imposed out of the center. Some typographers make the head and back margins the same and allot fifty per cent more margin on the outside of a page than in the back, and one hundred per cent more at the foot than at the

* If tie-up slugs have been used, there is no need to remove the strings; but allowance for the slugs must be made in the amount of material used between the pages.

head. This means that if the margin of the page is four picas at back and head, it will be six picas on the outside and eight picas at the bottom. As each back margin is four picas the distance between backs will be eight picas. If one-quarter inch is allowed for trim, then the distance between heads must be eleven picas—eight picas for the two margins and three picas (one-half inch) for trim. After the head and back margins are in place, make the distance from page 1 to page 7 equal to one-half the sheet, then make the distance from page 1 to page 13 one-half the sheet, as described in the next section. The balance of the form is made up as described in Section 160.

The relation of margins for pages out of the center is not the same in every office, but the method described is the proper one for imposing pages with unequal margins.

162. Making Up to the Paper.—Order-blanks sometimes specify the trimmed size, and state that the form is to be made up to the paper. In this event, make up the back to the trimmed size, then fold the sheet in half, each way, and measure from page 1 to page 13 for the narrow way, and from page 1 to page 7 for the long way. Put enough material each side of the bars to just equal the size of the folded sheet.

163. Lay of Forms.—As has been said, forms come in multiples of four. Diagrams of the four, eight, twelve, twenty, and twenty-four are, therefore, given in Figs. 108-114. The sixteen has already been fully explained. See also Fig. 116. The lay of a form containing any number of pages may be determined as described in Section 158, or the student may consult some more pretentious book.

Figs. 108 and 109, showing various methods of laying the **four** and the **eight**, are so obvious as not to require any detailed explanation. It will be observed that the long four is the same as the square four except that pages 2 and 3 have been swung around to come side by side instead of being head to head. The same thing prevails in the square eight and the long eight. The halves of the square eight are side by side instead of foot to foot as in the long eight.

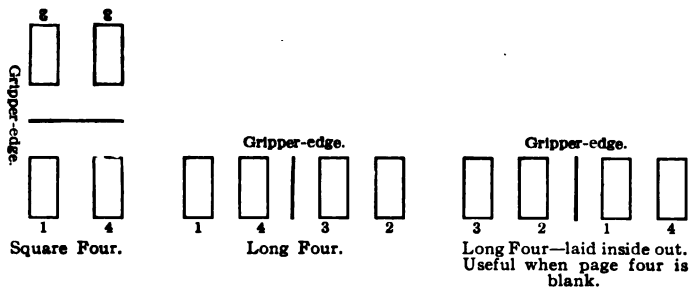

FIG. 108.—Three Ways of Laying a Four-page Form.

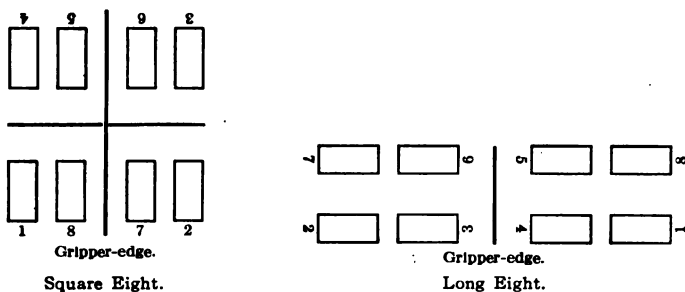

FIG. 109.—The Square Eight and the Long Eight.

The Twelve.—There are several ways of imposing the twelve. It may be laid so as to fold without cutting, or it may be printed and then cut apart before folding, one section insetting the other. Fig. 110 shows a regular twelve. This sheet is folded over and over. There should be folding-marks between pages 2 and 5, and the sheet should be folded a little bit scant of the mark to avoid crimping the edge of the sheet when making the second fold. When the twelve is imposed as shown in Fig. 112 it may be cut apart and folded as a four and an eight, the eight insetting the four, or it may be folded without cutting, both outside fours being folded out instead of in. The disadvantage of this arrangement is that the sheet must be turned for the second fold; it has the advantage, however, of avoiding the crimping of the edge of the sheet.

It will be noticed that in Figs. 110, 111, and 112 the same four pages always come side by side in the rows, the only dif-

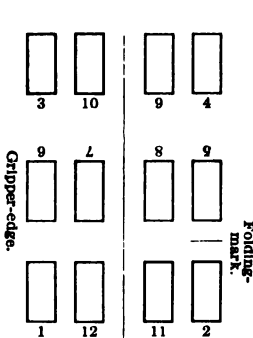

FIG. 110.—Regular Twelve, Folded Over and Over.

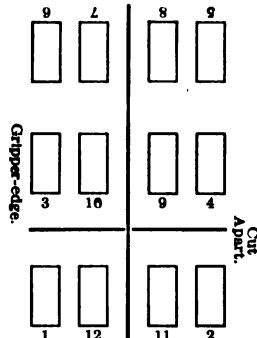

FIG. 111.—Twelve Pages Worked as an Eight and a Four, the Eight to Inset the Four.

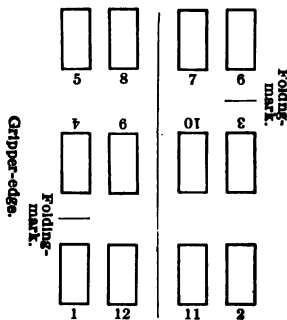

FIG. 112.—A Form of Twelve.

This may be folded without cutting, or it may be cut apart and folded as two forms, the eight inseting the four.

ference being in the positions of the rows. Inasmuch as the forms work and turn (*tumble*, see Section 164), and are then cut

apart, the two halves in each form could be reversed and still back up properly. In fact, any form whatever can have its halves reversed if they back each other.

The Twenty.—Fig. 113 shows two ways of imposing the twenty.

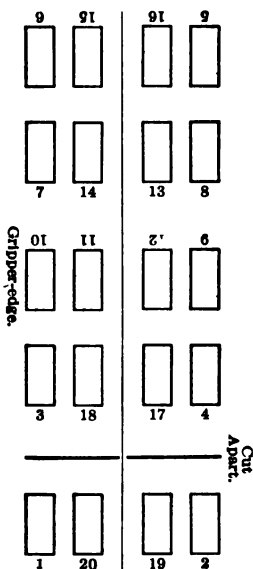

Twenty-page Form.

To be cut apart and folded as two separate forms, the sixteen inseting the four. The sheet must be tumbled.

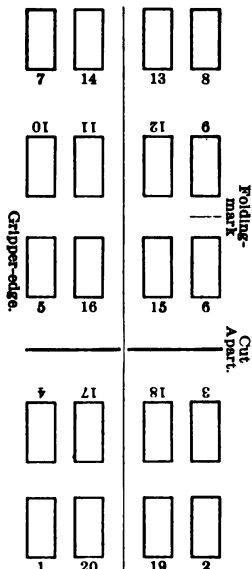

Twenty-page Form.

To be cut apart and folded separately, the twelve inseting the eight. The sheet must be tumbled.

FIG. 113.—Two Ways of Imposing a Twenty-page Form.

The Twenty-four.—There are many ways of imposing the twenty-four. One arrangement is shown in Fig. 114.

164. Folders.—Fig. 115 shows the lay of a six-page and a twelve-page folder. This type of folder is sometimes called a "cat-step" or "pull-out" folder. It may consist of any number of pages—four, six, eight, ten, twelve, etc. They are all laid

in exactly the same manner. Beginning with page 1 in the lower left-hand corner, make page 2 back it up head to head, then run consecutively across the top from left to right, come into the

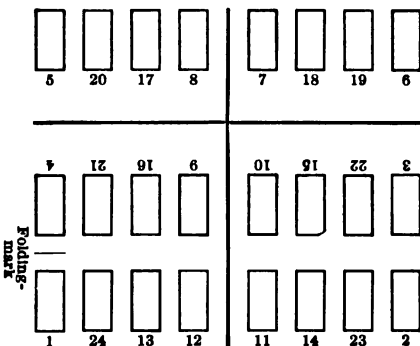

FIG. 114.—A Twenty-four, Without Cutting.

bottom row at the right, and finish consecutively from right to left. This brings the last page alongside of page 1.

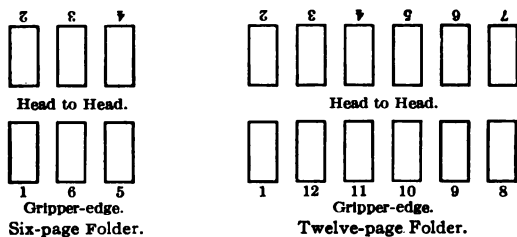

FIG. 115.—Showing the Lay of Cat-step Folders.

The folders cut apart between heads, the printed sheets being folded over and over. As there is no trim allowed, the sheets must be very accurately cut. The margins between pages should be made up to the folded size.

In backing up a form of this kind the sheet is turned over from top to bottom, not from right to left. This method of

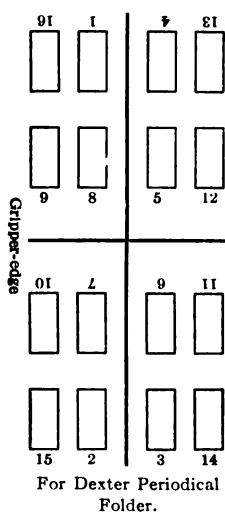
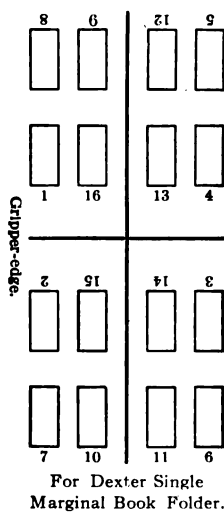
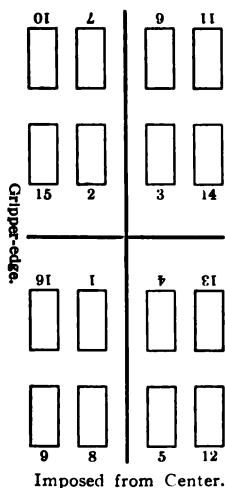
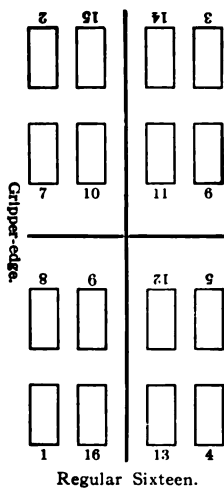

FIG. 116.—Four Ways of Imposing a Sixteen-page Form.

Notice that the four pages in each quarter-section never change position in regard to each other, even though the whole quarter-section changes position in the form.

turning a sheet is called "tumbling." These folders *must* be tumbled. But in making up other forms never plan for a tumbled sheet if it can be avoided, for any variation in the size of a sheet will put the pages out of register.

165. Machine-fold.—Folding-machines do not all perform their work in exactly the same way. It is frequently necessary to consult the binder and have him mark a sheet for folding. Nearly all machines require the forms to be laid inside out. A work-and-turn 16-page form can be laid in four different ways and still fold correctly. See Fig. 116.

166. Signatures.—After a book has been printed the sheets are folded, gathered, and bound. Each sheet makes one section of the book, and is called a *signature*. On the first page of each section there is a small figure, also called a signature, placed there as a guide to the binder in collating the sections, each section being numbered consecutively. If each section in a book contains sixteen pages, a small figure will sometimes be found on pages 17, 33, 49, 65, etc., throughout the book.

Sometimes in collating a book the bookbinder may gather two sheets instead of one, or may misplace some of the signatures. To obviate this, marks are frequently printed in the backs between the two outside pages of a form. This is done with a heavy rule, which is placed in a new position for each form. When the signatures are collated they resemble Fig. 117.

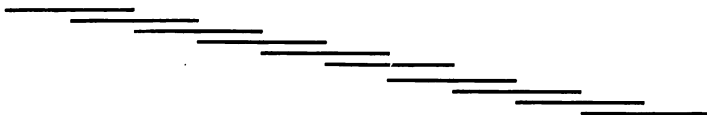

FIG. 117.—Diagram Showing Collating-marks on Backs of Signatures.

If a signature is missing, misplaced, or duplicated the error can be detected at a glance.

167. Insetting.—Forms are sometimes imposed so that after a sheet is printed and cut apart one part will inset the other. For example, a twelve-page form may consist of an

eight-page form and a four-page; a twenty-page form may consist of a sixteen and a four or a twelve and an eight; a twenty-four may consist of a sixteen and an eight. Whenever forms are imposed in this way, arrange to have the larger form inset the smaller; it is easier for the binder.

168. Press-points.—On some folding-machines the sheets are fed to points as a guide for correct margins. When these are required, the press-points are screwed into wooden furniture in the form and arranged to make a strong mark in the head margin. They are usually placed fifteen inches apart—seven and one-half inches each way from the center of the first fold. Get the proper place and distance from the binder.

169. Other Forms.—It is *not* to be understood that the various forms given in this chapter are the only ones capable of being properly folded. There are many, many others. Forms up to 128 pages are not uncommon. Forms are frequently worked *two-on*: that is, two sets of the same pages are printed in one form and so arranged that after folding and binding two complete copies are obtained, thus cutting down the cost of binding. Manufacturers of folding-machines issue diagrams showing the various forms capable of being folded on their machines.

170. Proper Lay of Lengthwise Forms.—When type pages or illustrations are imposed so that they run lengthwise of the page of the book, they should read *up* the page. This will place the head of the printed matter to the left-hand side of the page. This follows for both right-hand and left-hand pages.

171. Folding Heavy Paper.—If a job is being printed on heavy paper, it is inadvisable to have the signatures made up of a great number of pages, for heavy paper has a tendency to crimp and break where the backs join the heads. Better print the form as two signatures, one insetting the other.

172. Chases.—Fig. 118 shows an ordinary book chase and a McGreal Combination Chase. The McGreal chase is an especially ingenious arrangement. As will be seen, the chase is made up of separate bars. These bars come in lengths from

four to sixty-two inches, all interchangeable, so that with a few assorted sizes a printer can make up a chase that will just fit his

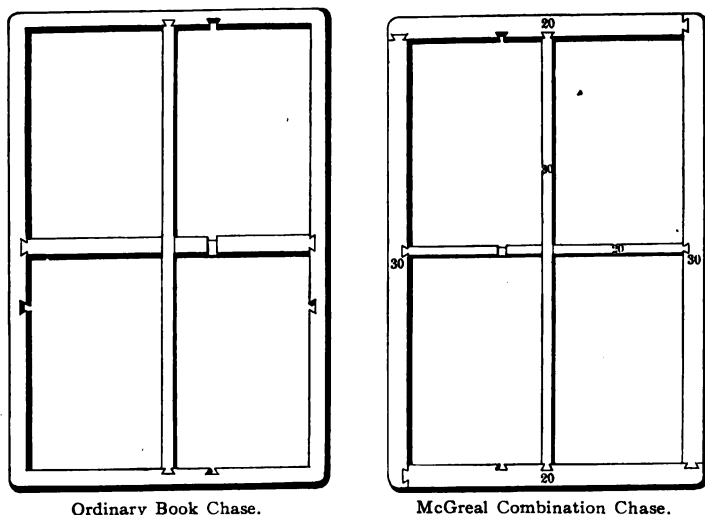

FIG. 118.—Two Types of Book Chases.

form, thereby obtaining a better lock-up than would be the case if the chase was out of all proportion to the size of the job.

QUESTIONS ON CHAPTER XI

1. What do you understand by "imposition" ?
2. Why are forms usually made up so as to be in multiples of four ?
3. What is a work-and-turn form ?
4. What is a sheetwise form ?
5. What is an insert ?
6. What do you understand by saddle-stitched ?
7. Why is it important to know whether a job is to be folded by hand or by machine before the form is imposed ?
8. What do you understand by margin ?
9. On how many sides of a page of a book is trim usually allowed ?
10. Why is it that a book requires trimming and a circular does not ?

11. How would you determine the back margin between two pages if they were of equal size ? if of unequal size ?
12. What do you understand by making up to the paper ?
13. Describe how you would determine the lay of a form by folding and marking a dummy.
14. Name the various parts of a form.
15. Can you think of some reason why the two middle pages and the two outside pages of every form always come head to head ?
16. When imposing a pair of pages with the foot of each page toward you, is the uneven folio to the left or to the right ?
17. What is a chase ?
18. How are chase-bars inserted, from the top or the bottom ?
19. How should chase-bars be removed ? What will happen if they are forced in the wrong direction ?
20. Name the relative advantages and disadvantages of metal and wooden furniture.
21. Draw a diagram of a 16-page form showing the pages in proper position for hand-folding. Mark all the different parts of the form, and show the quoins in proper position.
22. Why should we begin with the quoins at the bottom of pages when locking up a form ?
23. Why is it wrong to plane a form after it is locked up ?
24. When beating off a proof of a form, what advantage is there in having each pair of pages on a single sheet ?
25. What is a cat-step or pull-out folder ? Why is it not laid the same as other folders ?
26. What is a signature ?
27. What expedient is sometimes resorted to to insure accuracy in collating signatures ?
28. What is insetting ?
29. What are press-points ? Why are they used ?
30. How should lengthwise pages read, up or down the page ?
31. What is the disadvantage in having a great number of pages printed on a heavy sheet of paper, and folding up as one form ?
32. What advantages does the McGreal Combination Chase possess over the ordinary kind ?

CHAPTER XII

CUTTING-TOOLS FOR PRINTERS

173. Miller Saw-Trimmer.—The great slogan of the day is “efficiency,” and inventors are vying with each other in every branch of the printing business to produce tools that will curtail labor and increase output. Whereas, a decade ago a printer was compelled to send to an electrotyper for the various odd jobs of sawing, cutting, trimming, mortising, beveling, routing, and dressing up material, nearly every large office now has a single machine that will do all of these things. The Miller Saw-Trimmer (Fig. 119) is a pioneer in this class of tools.

Any printer owning a machine of the above type is no longer under the necessity of cutting leads, slugs, and rules singly on the lead-cutter. These things may be cut in bulk, and they leave the machine accurately and perfectly cut, and there is no necessity for further dressing up before using. Typefounders cut all their material with metal-slitting saws.

174. The Lead-cutter.—No office is complete without a lead-cutter. It is the most useful piece of mechanism about the office, and at the same time the most abused. Fig. 120 shows the American Lead- and Rule-cutter. As its name implies, it is for cutting leads and rules. Leads are cut on the front of the machine, slugs and rules on the back. There is a limit to the

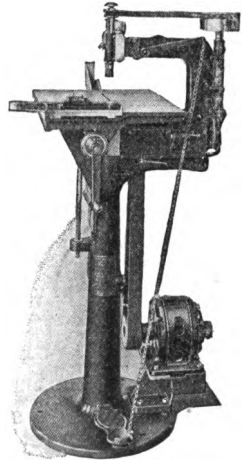

FIG. 119.—Miller
Saw-Trimmer.

amount of stress that can be put on any piece of mechanism. Therefore the directions here given for using the lead-cutter will be devoted more to what *not* to do than to what to do. The actual method of setting and using the cutter is obvious, but the author has seen so many foolish things done on a lead-cutter, both by apprentices and journeymen, that he must sound a warning.

Do not try to cut steel rule on a lead-cutter: use a three-cornered file for such work, and dress the piece to size and perfect finish with a flat file. Remember that the machine is a *lead-cutter*, not a steel cutter. Remember, also, that mitering-machines are not to be used for this purpose.

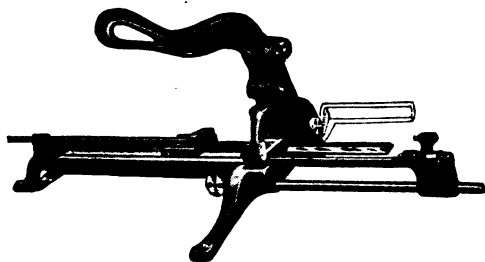

FIG. 120.—American Lead- and Rule-cutter.

Never try to cut more than one lead at a time. If you do, you will bend the ends of the leads, and they will be unfit for use. If, when cutting a single lead, the end is crimped or dished, it is a sign that the knife needs adjusting.

Never cut slugs on the front of the machine, you can get a better leverage on the back.

Never attempt to cut a slug thicker than twelve points, unless the machine is built for heavy service. In fact, twelve-point slugs may be too thick for some cutters. Do not rely on your judgment; ask some experienced workman.

Linotype slugs, which are usually softer than regular slugs, may be cut on the average cutter if not above twelve points. If much of this work is done, however, a special slug-cutter should

be provided. These are built on the same principle as a lead-cutter, but are very strongly made. (Fig. 121.)

The blank parts of linotype slugs are but slightly lower than the face of the type. If the type matter is very open, the rollers will touch the slugs and they will print on the sheets. To obviate this it is frequently necessary to cut the slugs away so that they will not print. This is sometimes done on a lead-cutter, sometimes with a coarse file. If much linotype work is done it will pay to have a Barber Low-slug Trimmer for this purpose.

Rule up to four points thick may safely be cut on a lead-cutter. The operation will very likely dish the ends, so it is

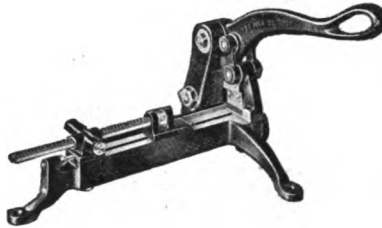

FIG. 121.—Rouse or American Slug-cutter.

advisable to cut the rule a few points longer than actually needed and then dress it to size on the mitering-machine.

It is sometimes necessary to cut pieces of leads to some point-size other than multiples of pica. Some machines have gauges, graduated to points, that can be set to accomplish this purpose. If the machine does not possess this device, any regular type of machine may be made to do the same thing. Suppose a number of pieces thirty-four points long are wanted: make up some combination of spaces and quads to equal thirty-four points. Set the gauge at any pica measure (say twenty ems). Put the combination of spaces and quads *against* the gauge, insert a piece of lead (not labor-saving) about eighteen ems long and cut off the end of the lead. Now remove the quads and spaces, push the lead back *against* the gauge, and use the lead for a new

gauge. The distance between the end of the lead and the knife is now just thirty-four points. Any size lead can be cut in this way.

175. Mitering-machine.—Mitering a rule is cutting the end of it to a bevel so that when a right and a left miter are joined together they will produce a corner with a certain angle. If a ninety-degree corner is desired, both miters must be at an angle of forty-five degrees. Various forms of mitering-machines have from time to time been devised for this purpose; some practicable, some impracticable. For many years two different types of machines remained in public favor—the horizontal and the vertical. The horizontal is known as the “Mitchell Mitering-machine.” It has gradually been supplanted by the vertical or upright type, and is no longer manufactured.

The proper miter on a Mitchell machine is secured by the use of a knife ground to the proper bevel, a set of knives accompanying each machine. On the upright machine, however, there is but one knife, and the proper miter is secured by shifting the gauge-bar around the arc of a circle. The base of the gauge-bar has a hole in it and is provided with a pin which may be slipped into holes in the bed-plate. When the hole in the gauge-bar comes in line with a hole in the bed-plate and the pin slipped into place the machine is accurately set to miter to a certain bevel. The holes in the bed-plate are numbered. If rule for a four-sided border is desired the pin is slipped into hole No. 4. This will produce rules of the proper miter. If a six-sided border is desired, the pin is slipped into hole No. 6; and so on. There are two sets of numbered holes, so as to produce right and left miters. There is thus provided a quick means of obtaining angles without making calculations.

The Mitchell machine is especially useful in cutting apart or mitering thick rule, and for mortising letters. The upright machine is useful only for mitering and for dressing material to size. The material must first be cut apart. Leads, slugs up to ten-point, and rule up to four-point may be cut apart on a lead-cutter. Rule thicker than four-point should be cut with a

hacksaw and dressed to size on the upright machine. Twelve-point brass rule is about the limit that should be attempted. The author has dressed up eighteen-point rule, but it was a hard job.

176. The Upright Machine.—In this type of machine (Fig. 122) the knife is secured to a knife-holder, which is moved up and down by hand in two slots milled in the body of the machine. The slots are wider than the guides on the knife-holder, so as to allow some play sidewise. This is important.

When using the machine, the knife-holder should be moved to the right, then raised to its highest point, then moved to the

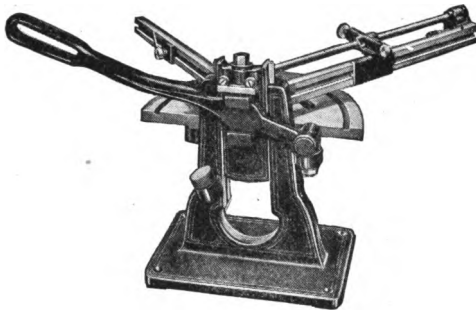

FIG. 122.—Rouse Mitering-machine.

left, and forced down to make the cut. The amount taken off at each cut is determined by the "set" of the knife; that is, the distance it projects from the knife-holder. One-half a point (about 0.007 inch) is about right. Hardly any two machines are set the same as this. It is a matter of individual preference.

It will readily be seen that each change in the "set" of the knife will alter the length to which the material will be cut, unless the gauge is adjusted to meet the set of the knife. So far as the author is aware, there is not a machine on the market containing this essential feature. For this reason the compositor is warned against relying on any machine possessing a

“set” gauge. It was doubtless all right when it left the manufacturer, but someone may have altered the “set” of the knife. Test it. The machine illustrated in Fig. 122 has an adjustment for setting the gauge to multiples of points, but it has no means of first adjusting the gauge accurately to pica distances from the cutting-edge of the knife.

When using the machine do not slip the gauge into a pica notch and proceed to cut the material to size. Someone may have moved the point-adjustment a point or two; perhaps the knife is not set so that the distance between gauge and knife-edge is exactly to picas. Test the knife-setting before using the machine.

To reset a knife so that the *gauge* will be accurate, slip the gauge into a pica notch, place a tested piece of labor-saving rule the same length as the measure of the gauge against the gauge-bar, and set the knife to the rule. To do this, place the knife loosely in position in the knife-holder, raise it until the knife is in line with the middle of the end of the rule, hold the knife-holder firmly against the left-hand side of the machine by pressing against it with your body, adjust the knife against the end of the rule, and clamp it securely in position.

177. Trimming Material.—If the job in hand is simply one of trimming to get straight ends, there is no need to set the gauge. When using the machine, however, there are several important things to be kept in mind.

The proper method of operating the knife is to swing the handle to the right, raise it to full height, move it to the left, and make the down stroke firm and steady. At the same time press the material against the knife-holder and hold it firmly alongside of the gauge-bar. Continue cutting until sufficient material has been removed. When bringing the knife up for a new stroke, be careful not to rub the knife against the material. To do so may rub a burr on the top of it.

178. The Burr on Rule.—Nearly all mitering-machines leave a burr on brass rule. After finishing the trimming, turn the rule on end, bottom toward the knife, and trim off the burr.

If the rule is to be trimmed on both ends, be sure to trim off the burr on the first end before trimming the other. If you do not, the burr will tilt one end of the rule and the other end will be trimmed at an angle. Compositors who are in the habit of producing rules trimmed on the bias always blame it on the machine, never on themselves. *Remember the burr.*

179. Trimming to Gauge.—When a number of pieces of

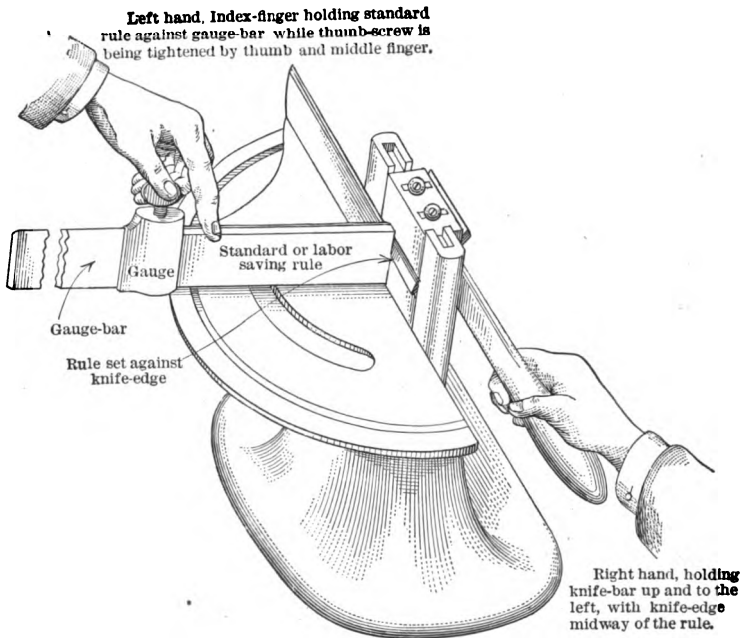

FIG. 123.

rule are to be cut and trimmed to the same size, cut the strips apart on the lead-cutter, leaving them long enough to allow for trim on each end, for the lead-cutter may possibly "dish" the rule or bend the face of it. Cut enough for the whole job. Take the strips to the mitering-machine and proceed to dress up one end of each rule, being careful to remove the burr.

Now set the gauge. To do this correctly obtain a piece of labor-saving rule (test it to insure accuracy), place it against the gauge-bar, raise the knife-holder high enough to bring the knife to about the center of the labor-saving rule (see Fig. 123); while holding the knife-holder firmly to the left, press the rule against the knife-edge, move the gauge against the rule, and clamp the gauge in position.

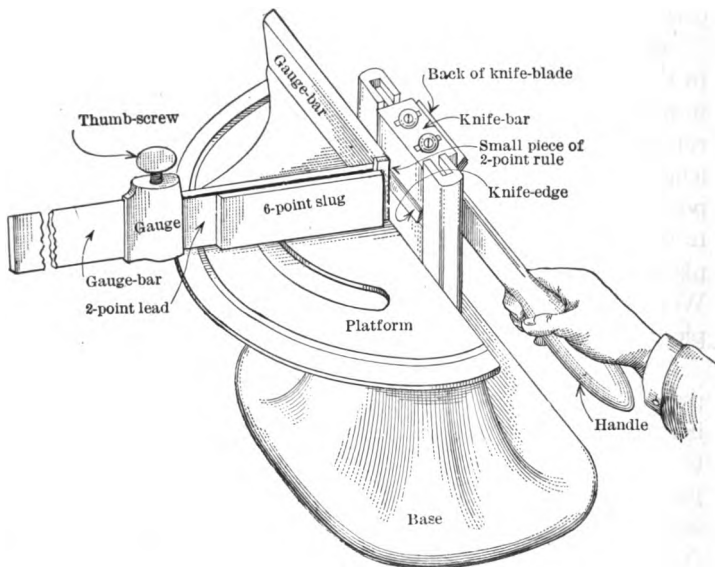

FIG. 124.—Dressing up a Small Piece of Rule on a Mitering-Machine.

The distance between knife-edge and gauge is now *exactly* the same as the length of the rule. Do not make the mistake of placing the rule against the body of the knife-holder instead of the knife-edge when setting the gauge; if you do, the rules will be the thickness of one cut shorter than the sample.

When a rule is now placed against the gauge it will be seen why it is necessary to have some play sidewise in the upright

slots, for the rule is longer than the measure. Hold the rule down against the base and back against the gauge, and continue cutting until no more material can be removed. Stand the rule on its end and remove the burr.

Be very careful not to strike the rule on the up stroke. If you do it will trip the rule and jam the corner against the gauge, thus battering the face of the rule and spoiling the piece. A piece of rule with a bias end or a battered corner will not make a perfect joint. Both defects can be avoided with a little care.

180. Cutting to Multiples of a Point.—If a piece of rule is to be cut to some multiple of points, set the gauge accurately to picas, and place enough material between the gauge and the rule that is to be trimmed so that the rule will be the right length when finished. For example, suppose that a rule two points less than ten picas is wanted. Set the gauge accurately to ten picas, put a space two points thick in front of the gauge, place the rule against the space, and proceed with the cutting. When the rule is finished it will be two points less than ten picas.

181. Cutting Very Small Pieces of Rule.—When cutting a piece of rule that is so short that there is not enough space between the gauge and the knife for the insertion of the fingers to hold the rule, set the gauge to a wider measure and use a piece of rule of the same thickness as the piece being cut. This will act as a gauge. The distance between the end of this rule (which we will call the “gauge-rule”) and the knife-edge is the size to which the rule will be cut. Set the gauge in the same manner as described in Section 179.

The author has cut pieces as small as six points. It is almost impossible to hold extremely small pieces in position with the fingers. They may be easily held, however, by placing a six-point slug in front of the rule and the “gauge-rule” and pressing them both against the gauge-bar. (See Fig. 124.)

182. Type “Fitting” on a Mitering-machine.—The process of mortising or bevelling letters so that one may overlap another is known as “fitting.”

Side mortices in initials or for fitting letters are best made on a Miller Saw-Trimmer. (See Fig. 125.) If a Mitchell machine is available it will also be found useful.

This is how the A, V, and A, in AVALON, on page 103, were cut and fitted.



FIG. 125.—Letters Mortised to Fit.

The upright machine is sometimes used for this purpose, but the letters are cut on an angle. (See Fig. 126.)

This is not as good a way as the first, for pressure on the ends of the line is apt to wedge the line out of alignment. It is usually done only when a Miller or a Mitchell machine is not available. The printer who lacks a mitering-machine can



FIG. 126.—Letters Mitered to Fit.

accomplish the same result with a coarse file. It is a laborious task, however, and requires considerable skill to make a perfect job.

183. Type-high Machines.—Owing to the fact that the printing-plates furnished to the printer are frequently above type-high (0.018 inch), many printers have found it advisable to instal *type-high machines*. These are devices for dressing off the bottom of plates. There are several machines on the market, and they accomplish the work by filing, dressing off with knives, or by the use of rotary cutting-tools.

When type and plates are worked in one form, it is very essential that they be all of one height. The use of type-high

machines saves a lot of time on make-ready in the pressroom. A form of plates that are either above or below type-high will be rapidly worn out if run on a cylinder press.

184. Care of Machines.—The care of all cutting-tools in a composing-room should be entrusted to one man, whose duty it should be to keep them clean, well oiled, and the cutting-edges always sharp. A sharp tool saves unnecessary strain and wear on the mechanism; and by being a pleasure to the user is conducive to better work. Tool-blocks for use in sharpening the knife usually accompany the upright mitering-machine. By placing the knife against the sloping side of this device and rubbing them both over the face of a good emery or carborundum stone, a new edge will be put on the knife, and at just the right bevel. When edging a cutting-tool, endeavor to maintain the original bevel, for that is the proper angle for perfect service.

QUESTIONS ON CHAPTER XII

1. Name some of the things that may be done on the Miller Saw-Trimner.
2. How should steel rule be cut apart and dressed to size?
3. How many leads may be safely and accurately cut apart at the same time on a lead-cutter?
4. What would you surmise was wrong with a lead-cutter that crimped or dished the end of a lead or rule?
5. Why is it inadvisable to cut thick slugs or rules on an ordinary lead-cutter?
6. If you needed some leads eighteen picas and three points long how would you cut them to size on a lead-cutter that had a gauge that was only adjustable to picas?
7. Describe how you would secure leads of the following lengths on the machine spoken of in Question 6: 118 points, 122 points, 94 points, 98 points, and 37 points.
8. How would you cut apart a thick rule or slug if a special machine was not available?
9. What is a miter?
10. Why are right and left miters necessary?
11. How are the proper miters secured on the Mitchell machine? on the upright machine?

12. Describe how you would set the gauge and how you would operate the upright mitering-machine. Tell what each particular move is intended to accomplish or to avoid.

13. Why should the "set" of the knife on an upright mitering-machine always be the same as when the machine left the manufacturer?

14. Describe the resetting of a knife so that the pica-gauge will be accurate.

15. Why is it so important to remove the burr from the ends of brass rule?

16. Why is it necessary to have some sidewise play for the knife-holder in the upright slots?

17. What will happen if a rule is tripped on the up stroke of the knife-holder?

18. If a mitering-machine did not possess a point-adjustment, how would you cut rule to a multiple of points?

19. Describe a method of cutting very small pieces of rule.

20. What do you understand by type-fitting?

21. Describe the different ways of fitting type.

22. Which is the better way of fitting type, by mitering or by mortising? Give your reasons.

23. What is a type-high machine?

24. Why is it important to have all printing surfaces in a form exactly type-high?

25. Of what use is the tool-block that usually accompanies an upright mitering-machine?

26. Why is it advisable to place one man in charge of all the cutting-tools in a composing-room?

CHAPTER XIII

COMPOSING-MACHINES

185. Economy of Machine Composition.—While every branch of the printing business is showing wonderful progress, in none is the stride more rapid than in the field of composing-machines. It has not been such a great number of years since men laughed at the idea of being able to set type by machinery. Today it is an established fact; in fact, so firmly is it established that the statement may be safely ventured that there is very little, if any, straight matter now being set by hand. From the standpoint of economy, any piece of matter containing upward of three thousand ems can be composed cheaper on a machine than by hand. Moreover, the printer is not only buying composition but material from which to print, so that there is no wear on his own material.

There have been quite a number of machines invented to set foundry type, among them the Rogers, Thorne, and Simplex, but the superior efficiency of the machines that both compose and make the type, either singly or on a slug, has resulted in their being almost supplanted. The major portion of straight matter to-day is either monotypes or linotypes. Each method has its votaries, and for certain reasons each is better adapted to specific purposes.

186. The Linotype.—The Linotype machine (Fig. 127) so called because it casts a "line o' type," or slug, was invented by Ottmar Mergenthaler, in 1885. The machine consists essentially of a *magazine* containing brass matrices, in one side of which two characters have been punched; a *keyboard*, connected with the magazine by a rod, pawl, and verge, so that one matrix may be released at a time by simply touching a button on the

keyboard; an *assembling device*, to carry the matrices into the stick, so that the operator can gauge his lines; wedge-shaped *space-bands*, so constructed that when inserted between words they may be expanded and the line justified; and a *device to carry the composed line* over to the casting mechanism, where

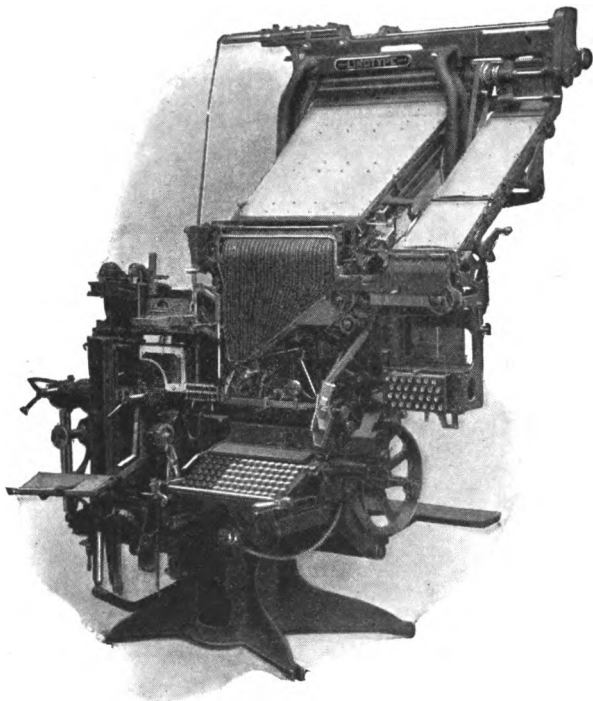

FIG. 127.—Linotype No. 17.

the line is justified, and the matrices held against the mold-disk, while metal is being forced into the mold from the melting-pot, and the line cast. After the line is cast the matrices are withdrawn from against the mold-disk, an arm comes down from the top of the machine, the matrices are slipped onto the arm, the arm is raised, and the matrices are pushed off onto the dis-

tributing-bar, where they are carried forward by a worm. Each matrix has a key-way, so arranged that the matrix can only slip from the distributing-bar when it gets over its own place in the magazine. In this way the matrices are automatically returned to the magazine ready to be used again.

The operator of a Linotype composes the matrices and controls the casting mechanism. If errors occur, it is necessary to reset the whole line, perhaps several lines, in order to correct them. The machine is specially adapted to newspaper work, for the slugs can be handled with less care than is required in handling type matter composed of individual letters.

Each matrix in a magazine is stamped with a certain character or letter of the alphabet, but in two different faces of type. As the matrix is being assembled in the composing-stick, it is possible, by the use of a special device, to bring either face into alignment, thereby setting two different faces of type in one line.

The early type of machines contained but one magazine, and could make slugs of but one size, unless the mold was changed. Of the later styles, the No. 9 has four magazines, and can cast eight different faces, all the operations of change being made by the operator simply by moving a few levers; and that, too, without leaving his seat at the keyboard.

Even though the Linotype casts solid slugs, still it is possible to compose tables on the machine. This is done by the use of special matrices, which cast small lugs in the slug so that pieces of triangular brass rule can be put into position and the lugs crimped about the rule. Another way is to make saw-cuts in the slugs in proper position and then force pieces of brass rule into these cuts.

Tabular work may also be done by cutting the slugs to column width and using rules between the columns.

The very latest method is by the use of the Auto-Mat Tabulator, a device consisting of a matrix with two movable jaws, so arranged that in casting a rule a triangular orifice is left in it, into which a triangular rule can be slipped, thus making a perfect joint in the rule.

While the Linotype is frequently used for setting newspapers, it must not to be inferred that it is useful only for this work; there is an increasing abundance of high-class magazine and book work being produced.

187. The Monotype.—The Monotype, so called because its product consists of separate letters, was invented by Tolbert Lanston, in 1887. A complete outfit for composing type consists of two separate parts—a *keyboard* (Fig. 128) and a *casting-*

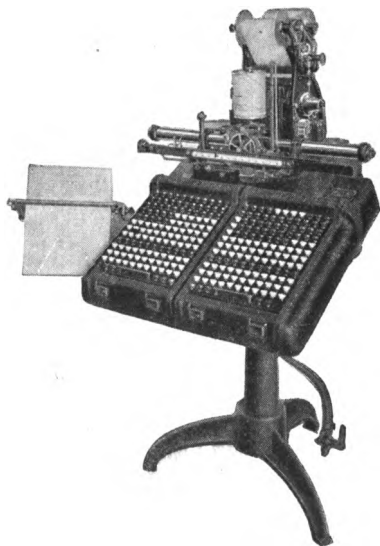

FIG. 128.—Monotype Keyboard.

machine (Fig. 129). The connecting-link between the two machines is a ribbon of paper in which holes have been punched (somewhat on the order of a music-roll), the holes automatically controlling the casting device, so that whatever character was touched on the keyboard will be cast on the casting-machine. It also automatically casts spaces of just the right thickness so that after the line is composed it exactly fits the measure to which it was set. The casting-machine automatically makes

the type and spaces and composes the lines, moving each line forward so that the next may come into proper position.

The successful operation of the Monotype system is due to the fact that each character is cast on some predetermined width, or unit. The Monotype unit is one-eighteenth of the cap M of the font. When a line is to be composed it is only necessary to know the width (set-size) of the face of the font,

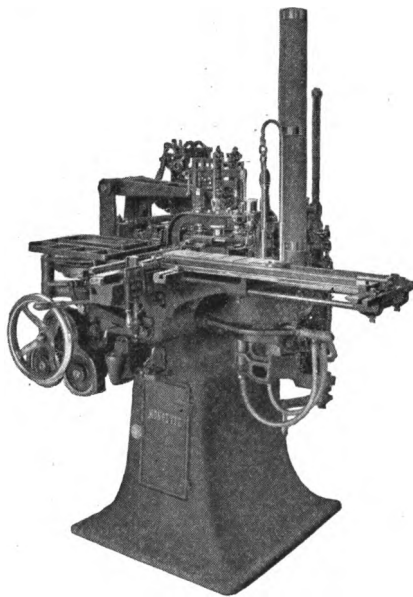

FIG. 129.—Monotype Casting-machine.

and the length of the line. When these matters have been decided it is simply necessary to consult a chart (for these calculations have been made and charted) and set the indicator to a certain number of units. This indicator shows how many units of the kind of type we wish to use may be gotten into a line of the width we wish to set.

When a key is touched on the keyboard the indicator moves to the right a number of units equal to the width of the letter

struck. When the next key is touched the indicator moves that number of units. In this way the full width of the space is used up, until there is not sufficient space to get in any more words, after which it is necessary to space the line.

At the top of the keyboard there is a cylindrical device called a *justifying-scale*. When nearing the end of the line, as the line is being composed, each time a letter is struck the cylinder moves a number of units equal to that letter; each time a normal space is touched a pointer moves up one step on the justifying-scale. After the line is completed, the pointer on the justifying-scale shows which justifying-keys must be struck to punch holes that will set the space-setting mechanism on the caster.

At first thought it seems almost impossible to strike a space and afterward determine its size. When we realize that the ribbon is run into the casting-machine backward, the matter becomes quite clear, for the first thing that happens on the casting-machine is the last thing that was done on the keyboard—the space-setting mechanism is set to size. This is done with a pair of accurate wedges, the setting of which adds the required amount to the normal wedge. Once the space-casting mechanism is set for a line each space emerges from the caster exactly of the same width.

There are two hundred and twenty-five matrices in a matrix-case (Fig. 130) on the caster, each controlled by a key on the keyboard. There are fifteen rows with fifteen characters in each row. The rows in one direction are called *unit rows*, and the fifteen characters in each unit row are always cast on the same width of body. When the matrix-case moves into any unit position the mold is set automatically so that the letter cast is on a body of the proper width. If the matrix-case moves to eighteen-unit position, the mold opens to that width; if the matrix-case moves to nine-unit position, the mold-opening is nine units wide, etc.

Owing to the fact that Monotype is all cast of unit width, it is practically self-spacing, and therefore specially adapted to

tabular work (Fig. 131). It is mathematically accurate, and all lines are absolutely of the same length. Tabular matter can be composed in column form and delivered on the galley ready for the insertion of the rules.

The use of special characters in the matrix-case permits of setting units which, when assembled, look exactly like work composed of brass rule. (See Fig. 79(b) and Fig. 82.)

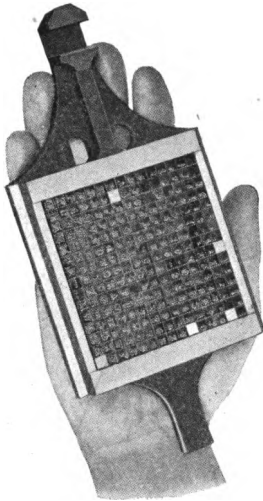

FIG. 130.—Monotype Matrix-case.

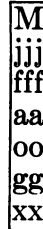

FIG. 131.—Illustrating the Relation between Characters of the Same Font: Thus, M (18-unit Character) is the same Width as *Three* j's or f's (6-unit Characters), or *two* a's, o's, g's, or x's (9-unit Characters).

It is also possible to compose and cast a large face on a small body by supporting the overhanging part with plain quads or with slugs made on the Monotype. Faces as large as sixty-point can be cast on bodies as small as twelve-point.

188. Mounting Illustrations in Machine-set Composition.

—There was a time when it was absolutely necessary to run type matter around the blocks on which illustrations were mounted. That necessity no longer exists.

The Monotype Company was the first in the field with a method of mounting illustrations directly on the composed material. To do this it is necessary to know just what part of the page is to be covered with type and what part with illustration. This is determined by the use of a *layout-sheet*. The quads are of such height that a plate eleven points thick when mounted on the quads will be exactly type-high. After the



FIG. 132.—Showing Monotype Method of Mounting Cut Directly on Quads, and also Form and Use of Tie-up Slugs.

proof is finally passed the plate is cemented to the quads. (Fig. 132.)

The Linotype Company's method is to prepare a layout-sheet, then set the lines of type of the proper length to go around the illustration. After the whole page is in type the slugs are lined up along the inside and the blank parts of the slugs routed away to the proper depth so as to form a level base for the plate. After the slugs are reassembled the plate is placed in position and nailed fast to the slugs. (Fig. 133.)

189. Non-distribution.—While the product of the Monotype machine may be distributed into cases, and then set by

hand, it is becoming more and more evident that such procedure is inadvisable. There are two reasons for this: first, it is better to have new material on each job; second, it costs money to pick a job apart and then distribute the type. Doing away with the necessity for distribution is the order of the day, and the next decade will doubtless witness many radical changes

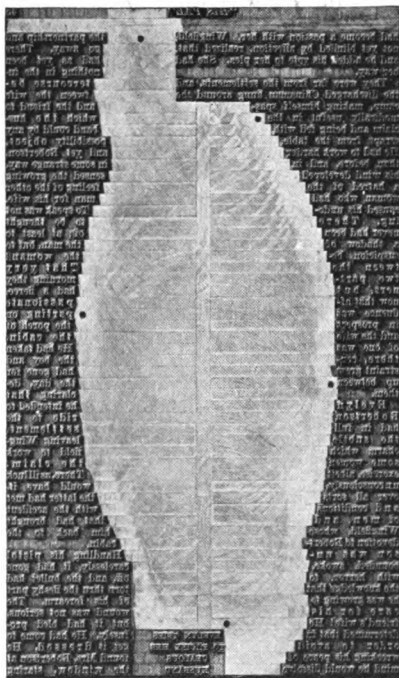

FIG. 133.—Linotype Slugs Routed Ready for Mounting Illustration.

in the production of composed type. Even now the Monotype Company has provided attachments to its casting-machine for producing type, borders, leads, slugs, rules, electrotype bearers, and tie-up slugs. The use of this material renders distribution unnecessary. After a job is completed it is swept off into the melting-pot.

The Linotype machine is a combined composing and casting mechanism. The caster part of the machine is sold separately, and may be used for casting leads, slugs, rules, borders, etc.; the length, however, is restricted to thirty-six picas.

At this writing, the Linotype Company is putting out a machine known as the Ludlow Typograph. With this machine the matrices are set in a special stick and the lines cast on a slug, which is then put into place in the job. It will cast a face as large as forty-eight point on a twelve-point slug. Slugs of various thicknesses and lengths can also be cast. The slugs are of the required height to support the overhanging slugs.

190. The Intertype.—Inasmuch as some of the basic patents on the Linotype have expired, another machine built along the same general lines has made its appearance. It is called the Intertype. It is a newcomer, is rapidly adding improvements, and is destined to become a very important machine. Its strongest bids for favor are the facts that it contains fewer parts and is being marketed at a much lower price than the Linotype.

191. Type-casting Machines.—Printers are finding it expedient to instal type-casting machines, thereby keeping their cases plentifully supplied with type. There are quite a few machines on the market. The Monotype caster will cast type bodies as large as thirty-six point. The Monotype Company has an extremely large number of type faces from which to choose, and the matrices may be rented for a nominal sum.

QUESTIONS ON CHAPTER XIII

1. What is machine composition ?
2. What two distinct methods of machine composition are in vogue at the present time ? Describe them.
3. Why is the Linotype machine so called ?
4. What does the word monotype mean ?
5. Give a general outline of the manner in which lines are composed and cast on the Linotype; on the Monotype.

6. How is tabular work composed on the Linotype? on the Monotype?
7. What is the Monotype unit?
8. How many matrices are there in a Monotype matrix-case?
9. Explain how illustrations are mounted on Monotype quads; on Linotype slugs.
10. What do you understand by non-distribution? Why is it advisable?
11. What is the Ludlow Typograph?
12. What is the Intertype?

CHAPTER XIV

PRESSWORK

THE term *presswork* covers two entirely different methods of obtaining impressions from type forms : by the aid of cylinder presses and by the aid of platen presses. The latter is the only

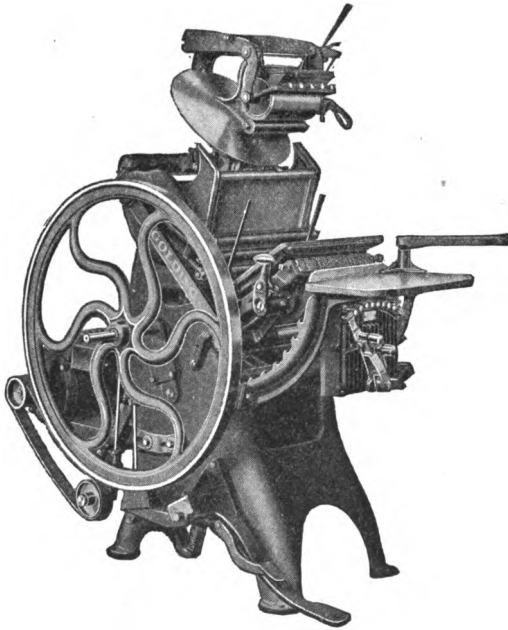

FIG. 134.—Golding Jobber.

one that will be discussed in this treatise. Primarily, because it is the simpler method and the one likely to be in general use in manual training schools, and because it is the logical step-

ping-stone to the more complex one of cylinder presswork, and admits of clearer exposition. He who aspires to be a cylinder pressman should first master the platen press. When that is accomplished he is qualified to take up cylinder work under the guidance of a skilled pressman.

192. Platen Presses.—A platen printing-press is one in which the form is locked up against a bed and the impression is

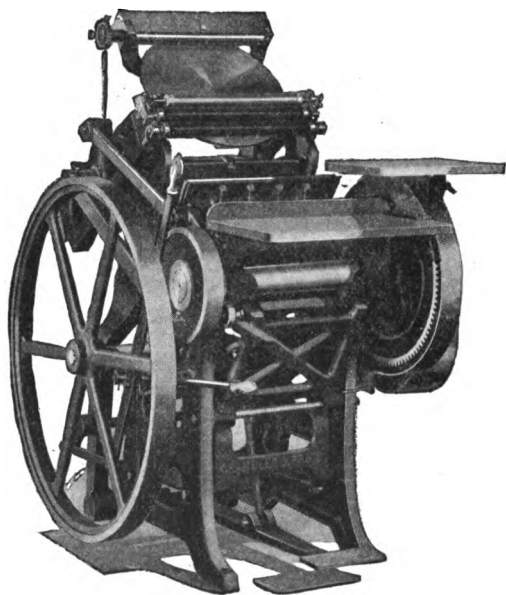

FIG. 135.—Chandler & Price Gordon Press.

delivered against a flat, smooth, level plate called a *platen*. There are two types of platen presses: one, known as the “clam-shell” type, in which the platen rocks up against the bed (Figs. 134 and 135); the other, known as the sliding platen, in which the platen is first placed parallel with the bed and then drawn up against it (Fig. 136). The latter method is the better one.

193. The Bed.—The bed of a printing-press is the part on or against which the form is fastened. On platen presses the

bed is always attached to some upright part of the framework. In some types of presses the framework moves, in others it is

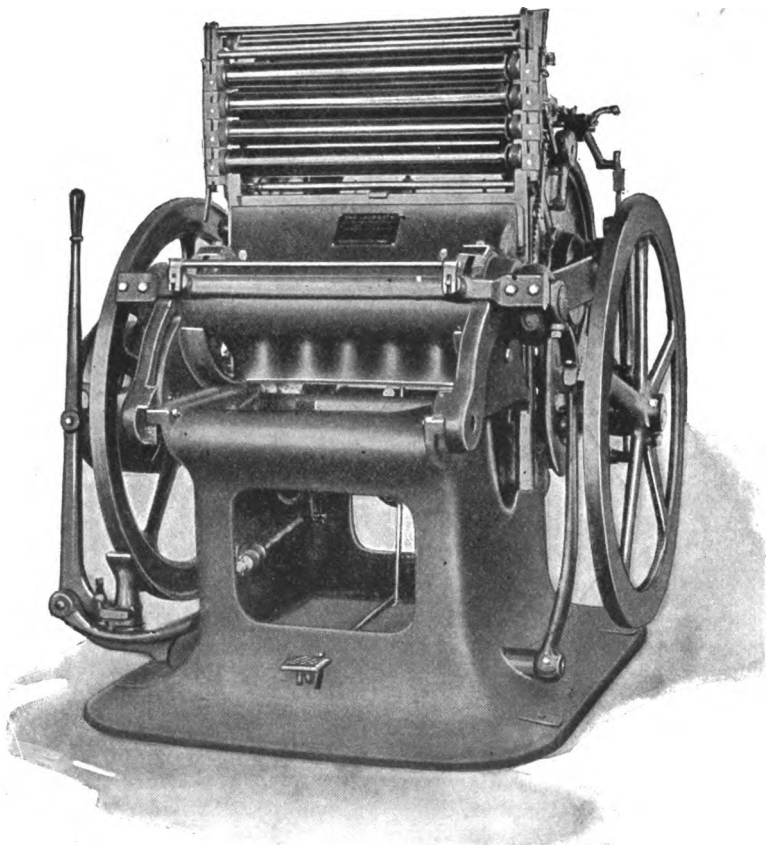

FIG. 136.—John Thomson Press, Model J.

rigid. While no adjustment of the bed is ever required, it is very important to see that the form is safely locked against it.

194. The Platen.—Inasmuch as the platen is the part against which the impression is taken, means must be provided

for altering, regulating, or equalizing the impression. This is accomplished by the use of adjusting-screws beneath the platen. To allow for variation in making ready, the experienced pressman has, for general use, a sheet of pressboard and three or four sheets of hard paper on top of the platen. This *tympan*, or *packing*, as it is sometimes called, is covered with a sheet of heavy manila paper, called a *draw-sheet*.

It is quite evident that if the platen is not properly adjusted the impression will not be even. The proper way to adjust the platen is to lock up four large, gothic letters, one in each corner of a chase, and pull an impression. By raising or lowering the impression-screws, as required, the whole four letters may be made to show uniformity of impression. When this is accomplished, the screws should be fastened with the lock-nuts. After the platen is once properly adjusted it should never be changed unless it becomes sprung, or it has been necessary to alter the impression in order to print a heavy form that could not possibly be locked in the center of the chase. If the impression has been altered for a special form, it should be leveled before proceeding with the next one.

195. The Draw-sheet.—The draw-sheet is the heavy sheet of manila paper that is stretched tightly over the packing and clamped under the tympan-bales. The *guides* and *fenders* are fastened to it.

196. The Grippers.—The grippers are the long steel “fingers” or strips that are clamped to the gripper-bar, which, in turn, is moved by the mechanism of the press, and causes the grippers to press the sheet tightly against the tympan while the impression is being taken, and to hold it there while the form and sheet are being withdrawn. On extremely light forms they are not necessary. If the form is a heavy one and carries much ink, they must be used to pull the sheet from the form. They are adjustable, and should be placed in the margins on light forms and at the point of strongest suction on heavy forms. Skeleton grippers are very convenient to have at hand, for it is sometimes necessary to use grippers in a very narrow space.

If the grippers fail to exert the required pressure on a sheet, a few thin pieces of cork glued to them at different points will usually prove effective.

197. Roller-bearers.—The subjects of roller-bearers, gudgeons, etc., are fully treated in Sections 144 and 145, and should be reviewed at this point.

198. Rollers.—Printers' rollers are made from a composition containing glue, glycerine, molasses, and other ingredients. Each manufacturer has his own pet formula, the proportions of which he varies according to the season of the year. These rollers are very susceptible to changes in temperature and humidity. It is, therefore, impossible to make a composition roller that will be in perfect condition at all times. Heat will soften the composition and cold will harden it. It will absorb moisture from the air and become "tacky." A roller in perfect condition for printing yields *slightly* under a firm pressure of the finger, and has enough "tackiness" to cause the ball of the hand to drag, when it is rubbed over its surface. If the hand slides, it lacks suction. If the finger sinks into the roller, the roller is too soft; if it does not dent the roller at all, the roller is too hard. Summer rollers (which are purposely made of a firmer composition) are too hard for winter use and winter rollers are too soft for summer use. Some printers change their roller outfits four times a year. This practice really pays; for a pressman can easily waste in time the cost of a set of rollers trying to do good work with poor rollers.

Hot, humid weather is especially trying on a composition roller; the atmospheric heat and the frictional heat sometimes being sufficient to cause the composition to "run down." Rollers should be carefully watched on hot, damp days.

Some inks have a very deleterious effect on composition rollers, many of them possessing an astringent property which takes all the suction out of the roller.

Rollers gradually shrink, and frequent changing of gudgeons is necessary so as to have roller and gudgeons of the same diameter. See under "Gudgeons," Section 145.

199. Oiling the Press.—One of the first things with which the embryo pressman should make himself familiar is how and where to oil the press. Every oil-hole should be located, and never neglected. The press should be fully and carefully oiled each morning before beginning work. A few drops at each point is usually sufficient. Do not flood the press with oil, for the surplus will simply run to waste. If any oil runs over the part while in the act of oiling, wipe it off at once. If the press has oil-cups, see that they are filled each morning. If you find that the oil-cups do not need filling, it is a sign that they are not feeding. Adjust them, and be on the lookout for warm bearings. If there is even the slightest squeak about a press ferret it out; something needs oil. To neglect it may ruin the machine. The side-arms on platen presses require careful attention. Do not fail to oil them daily. Also, be sure that *all* oil-holes are not clogged with dirt, otherwise they will not get oil even though you *think* you are oiling them.

Never attempt to oil or wipe a press while in motion. It is positively dangerous; practice the motto "Safety first."

200. Shrinking of Furniture.—After a form has been locked up and left standing for some time, it is usually found that the type is loose. This may be due to one of two causes, perhaps to both. The wood may have shrunk, or it may have yielded to the compression to which it was subjected. In any event, never go to press with a form without first being assured that the type is absolutely tight. If the press is left standing with the form on it for any length of time, try the quoins before proceeding with the job.

If compelled to leave a press standing for any length of time, remove the rollers. Never leave the rollers in contact with the form or on the ink-plate; the constant pressure will mark or mar them.

If, for any reason, a job is not completed at once, but is left on press for a few days, do not leave the press wide open, with the tympan exposed to the air, but close it, with the tympan almost in contact with the type. If left wide open during damp

weather, the paper on the tympan may absorb moisture and warp to such an extent as to spoil the make-ready.

201. Impression.—There is diversity of opinion among pressmen as to what constitutes a perfect impression. Should or should not the sheet show any impression on the back? There are so many factors entering into this question, that it can only be answered after special consideration of each particular case. In general, some impression is absolutely necessary to press the ink firmly against the paper. If the paper is soft and yielding the impression is bound to show. If the paper is hard and non-absorbent it requires a stiff ink; this necessitates considerable squeeze to set the ink firmly on the paper. Here, also, the impression is bound to show. A soft packing will show the impression regardless of other conditions. A hard packing, with smooth paper, good type, and good ink, should show but little impression. It will thus be seen that type, ink, stock, and packing all enter into the question. There is only one factor here over which the pressman has any control—packing. If possible, he should have a hard packing. The pressman must take what type and stock is given him, and use ink suitable to both. With this handicap against him he is supposed to produce perfect work. This is where his knowledge and skill count, for his troubles are legion.

202. The Tympan.—To the uninitiated it would seem that a hard tympan, or packing (see Section 194), would wear out type much quicker than a soft one. Just the reverse is true. It is surprising to find that a thin piece of paper placed beneath a thick pressboard will bring up low places in a form. Yet such is the case. If type is in perfect condition and not rounded on the edges, any smooth, level surface that is pressed firmly against it will yield a perfect impression. This is what a hard tympan does. Some pressmen use a thin sheet of copper or zinc instead of pressboard. If the type is rounded or worn a hard tympan will not touch the edges, and a soft or yielding one becomes necessary. Never use a soft tympan if a hard one will do, for, while it will bring up letters that are already rounded, it is also

the cause of that rounding. It is obvious that if type is being embedded in a soft packing the wear is all on the edges, which will be gradually rounded.

203. Inserting the Form.—The first step in the process of getting a job ready for printing is to insert the form in the press. Open the press to its fullest extent, at which time the rollers will be at their lowest point, and clear of the form. Insert the form (being very careful not to strike the grippers), and clamp it in position. Next, move the grippers, if necessary, so that they will clear the form, but be sure that they are tight before leaving them. If the draw-sheet used on the previous form will do for the present one, strip off all guides and fenders. Then remove the previous make-ready (retaining it for future use if the job is to be kept standing), insert enough sheets to make up for those removed, and proceed with a new make-ready. All the manila sheets on the tympan should be clamped beneath the tympan-bales. Always be sure to put the job in the press with the quoins at the top. If, for any reason, the form is removed from the press or its position changed after the grippers and guides have been set, be sure that the form does not strike them.

204. Make-ready.—The material of which printing forms are composed (type, rule, borders, ornaments, illustrations, etc.) is seldom, if ever, of uniform height. In order to secure a firm and even impression of this material on a sheet of paper, it is necessary to go through an operation known as *making ready*. The first step in this operation is the pulling of a trial sheet. This sheet is examined in a good light, and the impression noted. Where the impression is weak, the spots are outlined with lead-pencil marks, and patches are subsequently pasted thereon. This is known as *spotting up*. More than one *spot-up*, or patched sheet, is usually required before the form is ready for printing. The resultant series of patched sheets is called a *make-ready*.

A pressman will sometimes place one sheet of make-ready beneath the type or form in order to make everything level.

When this is done that part of the make-ready is called an *underlay*. The part that is placed on the tympan is called an *overlay*.

Inasmuch as it is impossible to tell just how much impression is being exerted by the type against the sheet if the type is flooded with ink, the pressman should see that there is too little rather than too much ink on the press. Many a pressman has frittered away time because he used too much ink when making ready, only to find that when the color (amount of ink) was properly adjusted for printing the job the form was breaking away, and he was compelled to stop the press and spot up another sheet. If the previous job on the press required a great deal of ink, remove about half of it from the plate, and thoroughly distribute the balance.

Before taking the trial impression, the tympan, or packing, should be arranged. Pressmen differ as to the proper method of doing this. One good way is to have three or four sheets of manila paper clamped beneath the tympan-bales. Between the bottom sheet of manila and the platen place three or four sheets of the same stock as that on which the job is to be made ready. Pull an impression on each manila sheet as a guide for placing the make-ready sheets.

When the trial impression is secured the sheet should be held to the light and examined on the back. If the type is punching through at any point it is evidence that there is something beneath the type. This must be removed, the form should then be opened up, re-planed, and again locked up.

If examination of the sheet does not reveal any type punching through, but, instead, certain areas lacking impression, these low places should be marked as a guide for patching or spotting up. These low areas or places are to be covered with patches of thin paper (usually French folio) in order to make them level with the high spots. The lower the spot the more patches required.

In order to properly see the impression the pressman should hold the sheet to the light, about on a level with the eyes; he should then mark on the back of the sheet the outlines of the

low areas, using a heavy crayon or pencil for this purpose. Sometimes three or more patches may be necessary on an extremely low place, each succeeding patch becoming smaller as it nears the center. The outlines for these patches are to be marked on the sheet. After all of the low places are marked on the back, the sheet should be turned over and examined on the face. The back of the sheet should be placed in contact with a sheet of carbon paper or put on the ink-plate of a press, and the low places on the face gone over with a pencil. This will leave marks on the back of the sheet.

The sheet is now ready for patching. Having secured some French folio, a little paste, and a sharp knife, put a little dab of paste on the smallest area first, stick on a piece of French folio, and with the sharp knife cut the folio to the outline shown by the pencil-mark. If more than one patch is required on a low area, each succeeding patch covers the smaller one, so that when the patching is complete the lowest spot in that area has the greatest number of patches. Do not use much paste; just enough to make the paper stick. Paste on the large patches with a series of finger-dabs around the edges and with a few in the center.

When this spot-up sheet is ready, cut off two diagonally opposite corners close to the printing, raise the upper tympan-bale, lower the top sheets, and paste this make-ready in register with the impression that was pulled on the lowest manila sheet. Take out a sheet of the loose stock near the platen. Put the tympan sheets down smoothly and carefully, clamp the tympan-bale, and pull another impression. The job should now be fairly level, with some low places still in evidence. Go over this sheet the same as you did the first. Should a third spot-up be necessary, follow the same routine. When everything is printing clearly and distinctly on the face without showing much impression on the back, the make-ready is complete. After the job is fully made ready, remove a few of the loose sheets near the platen and place the pressboard just beneath the draw-sheet. This will give a good, firm impression.

To avoid all risk of getting the spot-up sheets out of register, always release the tympan sheets by opening the same tympan-bale, preferably the top one. The upper sheets can be rolled down out of the way while pulling impressions on the manila sheets or for placing a spot-up sheet in position.

If an occasional letter is so low that it makes no mark on the sheet, it is evident that it is badly worn. Have it changed at once. If it cannot be replaced with a better one, but must be used, paste enough layers of paper on the bottom of it to make it type-high.

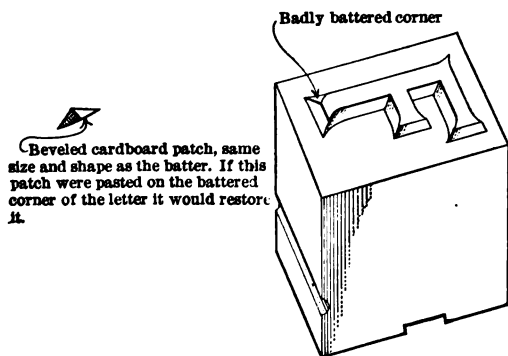

FIG. 137.—Showing How to Bring up a Badly Battered Letter.

Occasionally a single letter will be badly battered on one corner, and there will not be another letter in the office to replace it, hence it must be used. With a little ingenuity the pressman can make the impression given by it presentable. It may be necessary to overlay the battered corner with a piece of cardboard, but the cardboard patch should be beveled at the same angle as the batter so that it will push the sheet down and just touch the corner of the letter, but not punch through the stock. (See Fig. 137.)

205. Overlaying.—The process of making ready halftone plates is known as *overlaying*. Besides the cutting of overlays by hand, there are a number of mechanical methods of making

them, several being patented. In order to obtain a gradation in tone values throughout the picture, certain parts of the plate require more impression than others. The deep shadows require the most, the high-lights the least. Between these two extremes the impression should be varied by the number of sheets of overlay used, ranging from about three or four in the shadows to none at all in the high-lights. The half tones take about two sheets of overlay. To make a hand-cut overlay, pull about half a dozen impressions of the plate on French folio or "dry proof paper." Use one sheet as a background on which to paste the cutouts. Cut closely and carefully around the outline of each deep shadow and paste the cutout in proper position on the background. Do this with all the parts that need overlaying, putting on the requisite number of layers for each place. This must be very accurately done, for if any part of an overlay overlaps a part that does not require it, the effect will be spoiled. After the overlay is completed, it should be pasted on a tympan sheet in register with an impression that has previously been pulled.

In the other methods of overlaying this gradation is secured by mechanical means. Some of the processes are secret, some are rather elaborate. Anyone interested in mechanical overlays should consult "The American Manual of Presswork," page 34.

206. Guides.—After the job is satisfactorily made ready, the guides must be set. There are a number of *gauge-pins* on the market, but the old-fashioned three-em pica quad seems to be holding its own in popular favor. A *tympan-gauge*, consisting of a sheet of transparent celluloid with ruled lines printed thereon, affords a quick method of determining margins. An equally good one, however, when the job is to be printed in the center of the sheet, is to pull an impression on the draw-sheet, take a sheet of the stock on which the job is to be printed, and lay it on the draw-sheet with the edge of the paper against the upper edge of the printed matter. This will leave all the margin at the bottom of the stock. As only half of the margin is wanted at the bottom, fold the sheet back until its edge touches

the bottom of the printing. The new edge of the paper is the proper margin. Make two pencil-marks in the lower margin on the draw-sheet, one near the top of the job the other near the bottom, and draw a line parallel with the lower edge of the job. This is where the bottom guides are to be placed. Proceed in the same manner for the side guide, and mark its position. (See Fig. 138.)

Procure three three-em pica quads. Place a little liquid glue on one of the broad sides of each quad, rub it lightly over a sheet of paper to distribute the glue evenly, wipe off all the

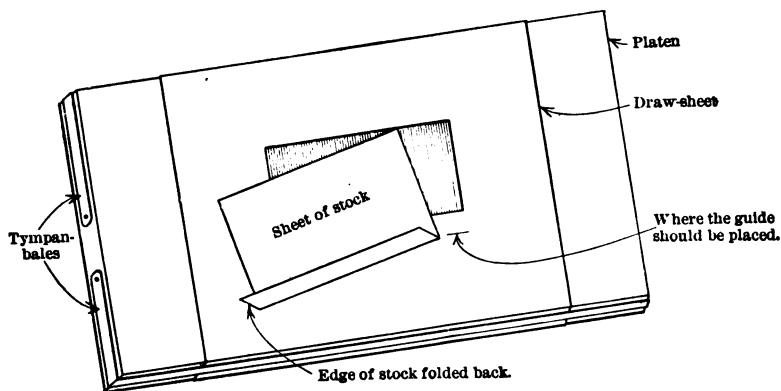

FIG. 138.—Setting Guides.

glue from the top narrow edge where the sheet will touch, and put the quad on the draw-sheet in proper position. Place all three guides in this way, pressing them down firmly. Do this quickly; then pull a sheet, and test the margins at once. To do this, fold the sheet in half, hold it to the light, and see if both margins are the same. If not, note which way and how much either one or both guides must be moved, and move them before the glue has had time to set. Determine the head and foot margins in the same manner. The guides should be moved in the direction opposite to that in which the printing should go. If the printing should go down, move the guides up; if the

printing should go up, move the guides down. With a little experience the proper setting of guides should be accomplished before the glue has had time to set.

After the guides are in proper position some precaution must be taken to keep the edges of the sheets from cutting

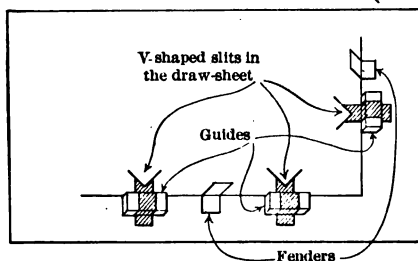

FIG. 139.—Showing Guides and Fenders in Position.

between the guides and the draw-sheet. This is accomplished by making a V-shaped slit in the draw-sheet, the V pointing toward the guide, and slightly raising the point of the V. As an additional safeguard, and also to firmly anchor the quad to the draw-sheet, a strip of gummed paper should be pasted beneath

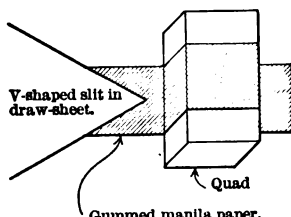

FIG. 140.—Showing V-slit and Quad Guide, Held Down with Gummed Manila Paper.

the V and carried completely over the three sides of the guide and out over the draw-sheet for a distance of about one inch. The gummed manila paper used for binding parcels is excellent for this purpose. Figs. 139 and 140 will make clear the preceding explanation.

Two sets of quad guides should be kept on hand, one set soaking in water while the other is in use.

If the job is a large one, with ample margins, *grippers* should be used to keep the sheet against the tympan after printing; if it is a small one, little pieces of cardboard, called *fenders* (see Fig. 139), are usually sufficient. A fender is simply a strip of stiff cardboard, bent at a slight angle, and glued to the draw-sheet. The bent part of it stands up slightly from the draw-sheet, and the stock can be slid beneath it. It serves to prevent the form from pulling the stock away from the draw-sheet. Fenders should be placed on the guide sides of the sheet, and at some point in the margin where they will not strike the type.

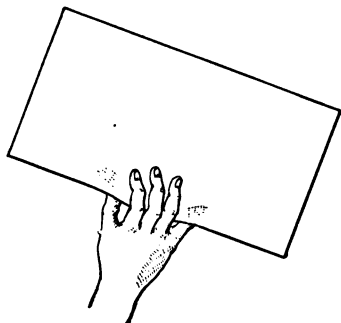

FIG 141.—Bowling a Sheet to Stiffen it so that it May be Fed into the Press.

207. Feeding a Press.—The manner in which a sheet should be fed into the press depends on the size and shape of the sheet. If the paper is fairly heavy and not too large, it can be grasped by the thumb and fingers of the right hand, bowed slightly without crimping, and pushed up to the guides (see Fig. 141). Never grasp a sheet firmly enough to leave a permanent crimp or buckle in it. If the sheet is thin or unwieldy, or cannot be fed without crimping or buckling, a method known as “flying” must be resorted to. To fly a sheet, turn the paper upside down on the feedboard, and “fan” out the pile by rubbing the thumb-nail over the top of the pile.

This will cause the sheets to project slightly (like the leaves of a fan), so that the edges may readily be grasped. Grasp the edge of the top sheet between the thumb and index-finger of the right hand, supporting the body of the sheet with the other fingers, and turn it completely over, at the same time swinging it from the feedboard into position on the tympan, and pushing it up to the guides. (See Fig. 142.)

The printed sheet is withdrawn with the left hand at the same time that the plain sheet is being brought over with the right. Some pressmen insert the plain sheet partly in the press

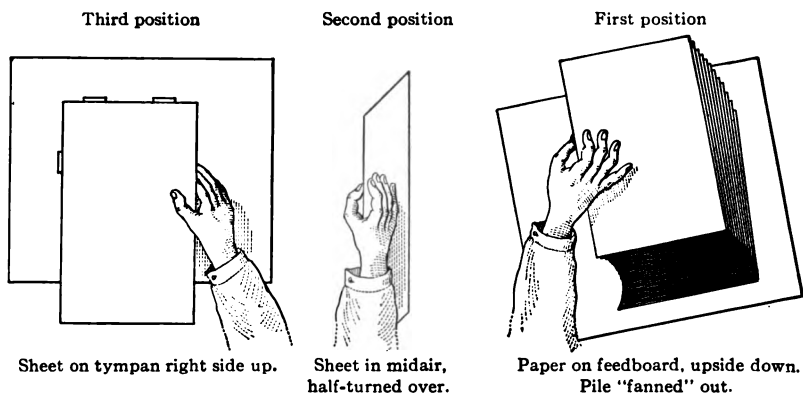

FIG. 142.—Successive Steps in Flying a Sheet.

before the printed one is withdrawn. This is a very bad habit, for in nine cases out of ten the edge of the incoming sheet will touch the ink on the printed sheet and be soiled. This will not be detected until the sheets are straightened. They must then be trimmed to get clean edges, sometimes to the detriment of the margin, and always at additional expense for trimming. Moreover, striking the printed sheet may mark the back of the plain sheet and give it the appearance of offset.

If it is impossible to withdraw the printed sheet before the plain one reaches the press, raise the printed sheet and feed the plain one beneath it, not over it. This will prevent soiling.

If you have trouble in withdrawing the sheet because the fingers slip over it, either fasten a piece of sandpaper to one finger with a rubber band, or moisten the finger occasionally on a piece of rag saturated with glycerine. Do not wet the finger with spittle. Such practice is unhygienic.

There is a difference between the two sides of every sheet of uncoated paper. This is due to the fact that it is almost im-

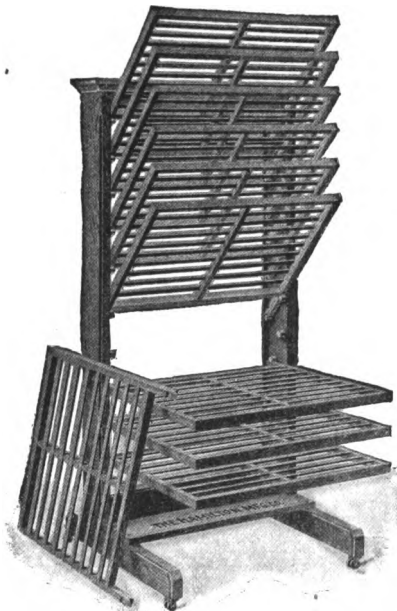

FIG. 143.—Drying-racks and Frame.

possible to eliminate the mark of the wire screen from one side of the paper (see Section 243). The rough side is the wire side, the smooth side is the felt side. With some papers this difference is so pronounced that to print on the wire side would spoil the job. Examine the stock carefully before printing on it.

208. Drying the Sheets.—If the form is a light one or the stock absorbs the ink readily, the printed sheets may be piled

without "offsetting"; that is, without the ink on one sheet marking the back of the sheet above it. If there is danger of offset do not pile the printed sheets, but lay them out on drying-racks (Fig. 143), in such manner that one sheet does not touch the printing on the other. Letterheads can usually be overlapped, somewhat after the manner of laying shingles on a roof. If the job is a small one, and from twenty to thirty piles can be laid out on a drying-rack, begin at one corner of the rack and lay off as many piles as the rack will hold. By the time the sheet for the last pile has been laid the first sheet placed on the rack should be dry enough to hold another sheet without offsetting. Go over the piles in regular order. Watch carefully for offset. If it occurs, the job must be slipsheeted as directed in the following section.

209. Slipsheeting.—When one printed sheet offsets on the next it is necessary to *slipsheet* the job. This consists in putting sheets of some rough-surfaced stock between the printed sheets, placing them alternately, first a printed sheet then a slipsheet. Paper known as heavy news is frequently used, but oiled manila is much better and lasts longer. Never use enameled paper for slipsheets, or the sheets will stick together. Inasmuch as it requires the services of a boy to put the sheets in and take them out again, slipsheeting is never resorted to if it can be avoided. Sometimes a press-feeder can put the slipsheets in while he is running the job, but usually at a sacrifice of speed. If the job can be put out on a rack in layers, each layer can be slipsheeted by the feeder. The slipsheets should be within reach of the feeder's left hand. As he finishes each layer he can quickly catch a slipsheet and place it without missing an impression.

210. Envelopes.—If an envelope be held to the light it will be seen that certain parts of it overlap, producing one or two extra layers of paper. If the printing strikes at such a point a cutout must be made from the envelope itself and pasted on the tympan so that there will be equal thicknesses of paper at all points. (See Fig. 144.)

Before making the cutout, the job should be made ready as if for a plain sheet, and the guides accurately set. If the envelopes are to be opened, and the printing does not strike any of the overlapping parts, no cutout is necessary. If the envelopes are not to be opened, and a cutout is required, remove a few sheets:

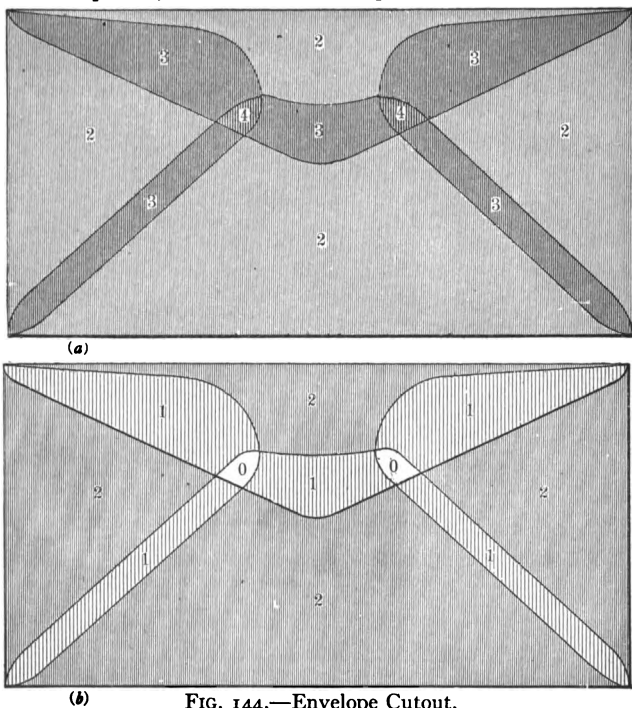

FIG. 144.—Envelope Cutout.

(a) shows the appearance of an envelope when held to the light. The figures indicate the number of thicknesses of paper at each overlapping part. (b) shows a cutout, the figures indicating the number of thicknesses of paper that must be retained, so as to produce an equal number of thicknesses of paper when the envelope and the cutout are placed into register.

of loose packing so that the printing will not punch through the envelopes and injure the type, and pull an impression to see where the printing strikes. If it be a corner card, and the printing does not strike the place where the envelope is glued together, but does overlap the side section, printing into that part where there is but one thickness of paper, proceed as follows:

slip the flap into the envelope and cut away the end of the flap by following the outline of the upper edge of the back of the envelope, using a sharp knife. Now cut away the entire back of the envelope, being careful to preserve the full outline or dimensions, retaining nothing but the front of the envelope and the remaining section of the flap. The cutout should now be placed in position. Place a perfect envelope on the guides and draw a pencil-mark on the draw-sheet along the bottom and side of the envelope. Remove the envelope and stab a few holes along this pencil-mark as a guide for placing the cutout on the sheet beneath. Raise the upper tympan-bale, lower the draw-sheet, and paste the cutout on the first manila tympan sheet below the draw-sheet. Replace the draw-sheet, and pull an impression. If the work has been carefully and properly done, the printing should present a uniform appearance.

If the envelope has a printed address, covering the lower half of it, make it ready as if for a plain sheet of paper, set the guides, and cut out the two parts where the sides and bottom are glued together, following the outline closely. Put the cutout in position on the manila tympan sheet as described above.

Any envelope can be made ready in this manner. In making a cutout it is simply necessary to have enough pieces of paper of proper shape in perfect register, so that when the envelope and the cutout are placed in position they will give an equal number of layers of paper. If the envelope has four thicknesses of paper at one point, three at another, and two at another, it will be necessary to add two pieces to the two layers, one piece to the three layers, and have none at all where there are four layers. When making such a cutout use one of the envelopes, so that the outlines may readily be followed. If the envelopes are to be fed closed, gum the flap fast to an envelope, and where the four layers occur, cut away the whole four layers; where the three layers occur, cut away two, retaining one; where the two layers occur, retain them both. This will leave one layer over the three layers, making four, and two over the two, making four. When the cutout and the envelope are put into register and held to the

light it will be found that they present a uniform tone. Put this cutout in position as described above.

211. Opening and Closing Envelopes.—The printing of envelopes is very hard on type, owing to the particles of gum

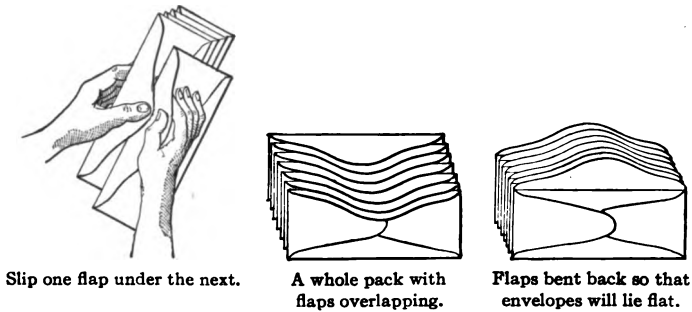

FIG. 145.—Method of Opening out Envelope Flaps.

that frequently stick to them. If the price obtained for printing them admits, it pays to open out the flaps before printing. Fig. 145 illustrates how this should be done. Grasp a pack (of twenty-five) in the left hand and bend the envelopes back

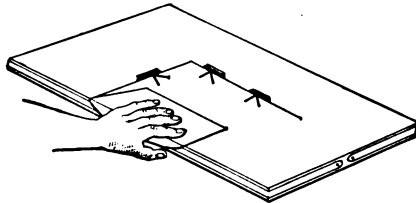

FIG. 146.—Showing How Envelope Flap May be Closed while Withdrawing Envelope from Press.

slightly at the top so as to raise the flap of the top one. Grasp the upraised flap with the thumb and fingers of the right hand, slip the top of the envelope beneath the flap of the one beneath, and push it completely under. Grasp the flap of that one, and proceed in like manner until the flaps of the whole pack have

been slipped one under the other. Raise the flaps and bend them back far enough to cause the envelopes to lie straight. With a little practice this can be done very quickly.

The envelopes may be closed while in the act of taking them from the press. Withdraw the envelope with the left hand by sliding it up the tympan. As the flap projects above the edge of the tympan, close it with the thumb. (See Fig. 146.)

212. Frisket.—Owing to the fact that parts of a form sometimes become inked and mark the printed sheet, it is often necessary to resort to the use of a *frisket*. This is a sheet of manila paper stretched tightly between the grippers and glued to them. An impression of the form is pulled on the manila sheet, and holes are cut in it so that the type may go through and print on the sheet beneath.

213. Registering.—Registering seems to be about as puzzling to the beginner in presswork as imposition is to the average compositor. The fact that everything is in reverse seems to confuse. If the job is too low on the sheet, the guides must be moved down; if it is too high, they must be moved up.

When printing a job in more than one color, pull plenty of register-sheets of the key-plate or form, and register each succeeding color into the key-form. Registering can be facilitated by pulling an impression on the draw-sheet, oiling a register-sheet so that the impression can be seen through it, and then moving the register-sheet until it is in register with the impression on the draw-sheet. Draw a pencil-line around the guide sides of the sheet, and mark the position of the guides (a register-sheet having been marked and preserved for this purpose). *Have the guides in the same position for all the colors.*

Difficulty is sometimes encountered in registering vignetted, three-color halftone plates in the center of a large sheet, especially if the job is a small one. Owing to the fact that there is no circumscribing outline, some prominent point in the center must be taken as a registering-point. For a trial register, set the guides as before described. If one place is in register, and the balance of the job seems to swing around that point as a center,

stick a pin through that central point, *remove the guides*, and very carefully swing the sheet the required amount. Replace the guides. The reason for removing the guides is that one of the bottom guides must go down and the other up when a sheet is swung around a center. Moreover, the side guide would be crooked. A movement of two points near the center of a sheet may require a movement of ten points at the guides.

214. Slurring of Rule Jobs.—When a job is completely surrounded by rule and all the corners are perfectly joined, the pressman is frequently troubled by his inability to overcome *slurring*, that is, producing a double mark on the sheet. This slurring is due to the air which is compressed inside the rule border at the moment the sheet touches the rule. The air is forced out over the edges of the rule, causing the sheet to move slightly and resulting in a slur. This happens more frequently on a press with a sliding platen. It can be obviated by drilling a couple of holes through the rule as an outlet for the air.

215. Embossing.—Embossing is the pressing of paper or thin cardboard between a pair of dies so as to leave the design in relief. The first essential is the *die*, which is usually of brass and hand cut. All the details that are to appear on the face of the finished product are cut *into* the brass plate. If the plate is not type-high, it is mounted on an iron base. The best way to mount a plate is to attach it with screws to the iron base. Lacking this, the next best (and usual) way is to coat one side of a strip of heavy manila paper with glue, and wrap it about the iron base until it has been built up to the proper height. Then glue the brass plate to the manila paper, holding it under pressure until firmly set. As embossing requires considerable pressure it should only be attempted on strongly built presses.

After the glue is thoroughly dry, the plate should be locked up in a chase and clamped on the bed of the press. The next step is the making of the *counter*. This is done by the pressman in various ways, one of which is as follows: strip off the tympan, leaving the platen bare. Glue a sheet of strawboard to the platen. While the glue is setting, mix a little Alabastine

with enough liquid glue and sodium silicate (soluble water-glass) to make the compound of about the consistency of putty. Smear this in a fairly even layer on the strawboard in such position that it will cover the die. Oil a sheet of tissue or French folio paper and cover the composition with it. Go over the inside of the die with an oily rag or dust it with French chalk (powdered soapstone) to prevent the composition from sticking to it if the oiled paper should break. Start the press and apply the pressure gradually, letting the press go over once, with a lingering squeeze. Remove the oiled sheet and examine the counter. If it has failed to fully fill the deep parts of the die, apply a little more composition where it seems to be needed, cover with an oiled sheet, and pull another impression as before. If the counter is now perfect, trim off the surplus composition while it is still plastic, cutting it away entirely where it is not needed. Allow room on the strawboard for the guides.

Leave the press wide open so that the composition will harden quickly. It is better to make the counter just before leaving in the evening, so that it may harden overnight. It should be as hard as stone in the morning. If the counter has any sharp or rough places that seem to break or tear the stock, they may be smoothed with fine sandpaper.

Another method (which the author has seen highly recommended, but which he has never tried) is to use an old talking-machine disk. Soften this by the aid of the heat from a painter's gasoline torch or a Bunsen burner, and make the counter while it is in a plastic condition. If the first strike is not a complete success, soften it again and add more impression. This hardens at once.

216. Perforating.—Perforating-rule comes in two heights—type-high and slightly higher. When it is run in type forms, it should be just type-high. The cutting-edge is sharp, and if it sticks up above the type, there is nothing to prevent it from cutting into the rollers and ruining them. It will also cut into the draw-sheet and pile up an aggregation of ink in the perforations. Even when the rules are type-high they should, if possible,

project beyond the edge of the printed sheet, and each end should be abutted with a short piece of three-point face-rule to prevent the ends from cutting the rollers. The three-point rule can be prevented from marking the draw-sheet by using a frisket.

It would be an improvement if perforating-rule were slightly lower than type-high so that it would not touch the rollers at all. A thin sheet of zinc or brass under the draw-sheet could be used to give the required impression for a clean cut. Of course, this would not be feasible if type came very close to the rule.

217. Scoring.—All machine-made papers have what is known as a grain. That is, the sheet will fold and tear more readily in one direction than the other. The grain runs the length of the stock on the paper-making machine, and usually the long way of the sheet. It is impossible to fold some cover stocks across the grain without cracking them. When the stock must be folded in that direction it must be scored. This consists in mashing the fibers with a thin, blunt edge. A piece of brass rule is usually used for this purpose, being locked in a chase in proper position. As no printing is to be done the rollers should be removed. The make-ready consists in adding sheets to the tympan until the rule mashes the stock just enough so that it will fold without breaking, but not until it is sufficient to cut it. If the stock is a cover for a book, two scoring-rules may be necessary, the distance between them being equal to the width of the back of the book. All scoring should be done on the outside of the sheet. If there is printing on the inside of the sheet it should be done before the scoring, as the scoring has a tendency to bend the sheet.

Scoring and printing can be done at one operation. If the printed mark made by the scoring-rule is objectionable, it can be prevented by the use of a frisket. (See Section 212.) It seldom shows after the sheet is folded.

218. Cutting and Slitting.—Slits and cutouts of various sizes and shapes can be made on a platen press by the use of steel cutting-rule assembled into proper form. If the outline is not rectangular, the usual method is to lay out the shape in

lead-pencil on an old electrotype block from which the plate has been removed. The block is then cut along the pencil-marks with a jig-saw, and the cutting-rule bent to fit the saw-cuts. The block is then locked up in a chase. Cutting-rule is of just the right temper so that it may be bent without breaking; it should be severed with a three-cornered file.

Best results are obtained when the cutting-rules strike against a thin sheet of zinc of brass placed under the draw-sheet on the tympan. If the piece of stock that is cut out sticks in the cutting-die instead of falling to the floor, a few pieces of cork

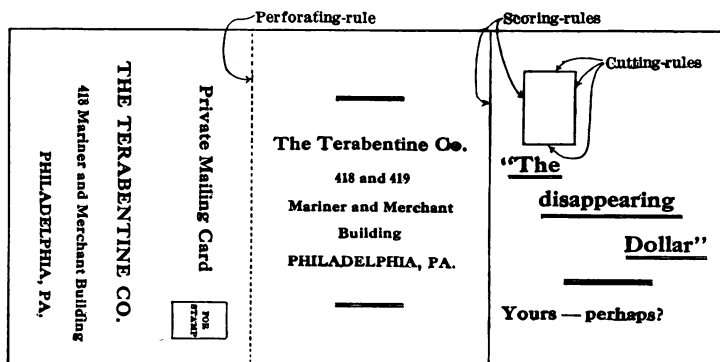

FIG. 147.—A Job that was Printed, Cut, Scored, and Perforated at One Operation.

glued to the block near the rule will eject it. A sheet of heavy paper on the floor to catch the cuttings will facilitate cleaning up after the job is finished.

219. Printing, Cutting, Scoring, and Perforating at One Operation.—By the exercise of a little ingenuity, the pressman can frequently accomplish several things with one impression. In Fig. 147 is shown a job that was printed, cut, scored, and perforated at one operation.

An impression of the job was first pulled and all the type underlaid; then the rules were all pushed down so that they would not take ink. The rollers were raised so that they would

not mash into the type. The job was made ready and enough impression put on the various rules to make them cut, score, or perforate, as required. When working a job of this kind if there is difficulty in getting the flap up after it is cut and scored, a piece of springy cardboard glued to the draw-sheet will serve to open it.

220. Printing a Two-color Register Job by the Aid of a Frisket.—Fig. 91 shows a two-color job for a tally-card, the various parts of which had to be kept in perfect position. Such a job is difficult to set, and more difficult to skeletonize. There is really no need to skeletonize it, for it can be kept intact and printed by the aid of a frisket. Pull a proof of the job on light cardboard and cut out the type not desired. Paste this on the back of the form, in perfect register, then lay the form on the stone, unlock it, and push down the type not desired, plane the form, and lock it up again. Strips of the same cardboard should be glued to the roller-tracks to raise the rollers. Take out enough packing from the tympan to compensate for the thickness of the cardboard underlay. Make the job ready. Cut a frisket so that only the printing desired will be impressed on the sheet. If the other parts do print slightly the ink will get on the frisket, not on the sheet.

After the first color is completed, wash up the press, put up the other color, cut a new underlay, just the reverse of the first, bringing up what was down, pushing down what was up, make a new overlay and a new frisket. *Be very careful not to displace the draw-sheet*, thereby altering the guides. The job will then be in perfect register.

221. Washing Up.—It is generally conceded that the best solution for washing rollers is kerosene. It is not inflammable at ordinary temperatures, as is benzine and gasoline, and it leaves a certain amount of oiliness on the rollers that is conducive to long life. Benzine evaporates quickly, and frequently takes the suction with it.

Benzine is in high favor with compositors for cleaning type because it evaporates at once, and, if necessary, another proof

can be pulled very shortly after washing the type. This is impossible with detergents of an oily nature. Type that is frequently washed with benzine finally becomes encrusted with dirt, and a lye bath is then necessary for a perfect cleansing.

222. Removing Hard Ink from Rollers and Press.—When rollers and presses are neglected or not thoroughly cleaned, they become encrusted with hard ink. This also happens with ink-knives and ink-slabs. There does not seem to be anything quite so efficient for softening these incrustations as *dead-oil*. This is a gas-house product, with a characteristic odor. Carbon tetrachloride is also recommended for this purpose.

223. Safety Devices.—Only within a comparatively few years has it been recognized that every member of our complex social system has a definite productive capacity and monetary value, and that the maiming or the shortening of the life of an individual is just so much loss to the community at large. Legislators have taken up the matter, and laws are being passed compelling employers of labor to safeguard their workmen. No piece of machinery that in any wise jeopardizes the life or person of the attendant should be permitted to be used without proper safety attachments. Printing machinery is particularly dangerous.

All exposed gear-wheels on printing-presses should be encased, so that it will be impossible for the attendant to be caught, no matter how careless he may be. Flywheels should be covered with sheet-iron on the outside so that no one can get between the spokes.

There is hardly a printing office that has not at least one pressman or feeder who, at some time, has not had a finger (perhaps a whole hand) mashed in a platen press. There are now several devices on the market that will lift the feeder's arm out of the way in time to avoid accident. Every press should be equipped with some such device. Fig. 148 shows a device for this purpose. True, attendants are frequently very foolhardy; they will take big chances to accomplish something without stopping the press. Sometimes safety attachments are thrown

back or out of use. *Don't take such risks.* If something serious should happen, it will necessitate a much longer stop, and it may mean a painful and permanent disability. No amount of safeguarding will prevent an accident unless there is intelligent co-operation on the part of the workman.

While this chapter is devoted to platen presses and not to cylinder presses, the author cannot refrain from telling of two accidents and one near-accident on cylinder presses with which he was personally acquainted. The two accidents happened in precisely the same way, one of them seriously. In both cases the pressman was trying to remove something from the form-

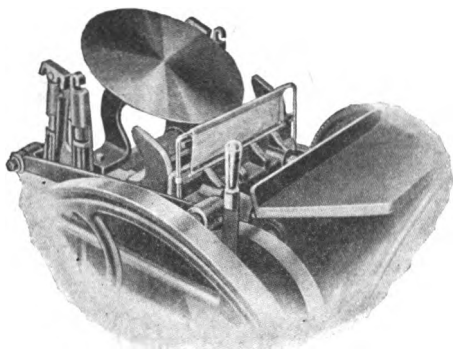

FIG. 148.—Sylvester Safety Device for Job Presses.

rollers while the press was running, and just at the moment of reversal each had a hand and arm drawn between the rollers. Fortunately, in one case the feeder stopped the press immediately by throwing off the power and pressing his body against the flywheel. This accident resulted in a badly sprained hand. The second pressman was not so fortunate. His arm was drawn in up to the elbow, necessitating amputation.

The near-accident occurred when a machinist was working beneath a cylinder press and pushed his foot against the back-up lever. He didn't know he was doing it, but thought someone

was starting the press. When he moved to get out of harm's way he removed the cause. Moral: never get under a cylinder press to fix anything or clean up while the power is attached. If it is belt-driven, throw off the belt; if it is electric-connected, pull out the fuse.

If you are running a power cutting-machine, keep your eye on the vicious knife-blade until it comes to a full stop. Under no circumstance be tempted to reach under the knife until you know you are safe. This is the one dangerous machine that cannot well be guarded. You must be your own guardian.

Never wipe around any kind of press while it is in motion. Keep in mind the slogan, "Safety first!" Remember also, that a careful workman is the best safety device.

QUESTIONS ON CHAPTER XIV

1. What is a platen press ?
2. Describe the different types of platen presses.
3. Which part of the press is the bed ?
4. Which part of the press is the platen ?
5. What is a tympan ?
6. What is the draw-sheet ?
7. What are the grippers ? Why are they used ?
8. Of what use are roller-bearers ?
9. What ingredients are usually used in composition rollers ?
10. Why is it necessary to vary the ingredients during the different seasons of the year ?
11. Describe the physical characteristics of a roller in perfect condition.
12. What causes some inks to have a deleterious action on composition rollers ?
13. Why is it necessary to change the gudgeons on composition rollers ?
14. What special care should you exercise when oiling a press ?
15. Why are forms containing wooden furniture usually loose after standing for some time ?
16. Why should rollers not be allowed to stand in contact with form or ink-plate for any length of time ?
17. Should or should not a printed sheet show any impression ?
18. Which is better, a hard or a soft packing ?
19. What causes type to wear round on its edges ?
20. What will prevent type from wearing round on its edges ?

21. If type is rounded on its edges, how can we get it to leave a perfect impression on a sheet ?
22. Describe how you would place a form on a platen press, telling what each move is intended to accomplish or avoid.
23. Should the quoins be at the top or bottom of a form ? Why ?
24. What do you understand by make-ready ?
25. Give a full description of your method of making a form ready for printing.
26. Why is it inadvisable to carry much ink while making a form ready ?
27. What is an "overlay" ? an "underlay" ?
28. Why is it advisable to open the upper tympan-bale instead of the lower one when pulling impressions on the tympan sheets and when placing the make-ready in position ?
29. Describe the making of a hand-cut overlay for a halftone.
30. What is a tympan-gauge ?
31. Describe the setting of quad guides on a platen press.
32. Why do we make V-shaped slits in the draw-sheet near the guides ?
33. What is a fender ? Why is it used ?
34. What do you understand by buckling or crimping a sheet as applied to press-feeding ?
35. How would you "fly" a sheet when feeding a press ?
36. What will happen if the incoming sheet rubs over the surface of the printed sheet as it is being withdrawn from the press ?
37. If you were having difficulty in withdrawing sheets from the press, how would you overcome it ?
38. How can you distinguish the right from the wrong side of the paper ?
39. What is offset ?
40. How should letterheads be laid out to avoid offsetting ?
41. Why is it necessary to slipsheet a job ?
42. What kinds of paper may be used for slipsheets ? What kinds may not be used ?
43. Describe the making of an envelope cutout.
44. Describe how the flaps of envelopes should be opened.
45. How may the flaps of envelopes be closed while in the act of drawing the envelopes from the press ?
46. What is a frisket ? How is it made, and why is it used ?
47. When printing jobs in more than one color why is it necessary to have the guides always in the same position for every sheet ?
48. Describe a method of getting a small job in register in the center of a large sheet.
49. How would you prevent a rule job from slurring ?
50. What is embossing, and how is it done ?
51. What is perforating-rule ?

52. Is it an advantage or a disadvantage to have perforating-rule higher than type-high? Give your reasons.
53. What is scoring, and why is it necessary?
54. If you wanted to print and score at the same operation, how would you prevent the scoring-rule from marking the sheet?
55. What do you understand by cutting and slitting?
56. If you wished to make a cutout, irregular in shape, how would you proceed?
57. If the piece of stock that is being cut out should stick in the cutting-die, how would you eject it?
58. Describe how you would prepare a form so that you could print, cut, score, and perforate at one operation.
59. How may a two-color register job be printed without skeletonizing it?
60. Why is benzine not as good as kerosene for washing rollers?

CHAPTER XV

PRINTING-INK

224. Composition.—The object of this chapter on printing-ink is not to give the student a full and comprehensive treatise on its manufacture, but simply to point out a few things regarding it and its use that a printer should know. The manufacture of printing-ink is too complex a process for the average layman, involving as it does a knowledge of chemistry. In general, the ink may be said to consist of a *pigment*, a *vehicle*, and a *drier*. Various other substances are added for specific purposes, but unless one is familiar with the composition of an ink, it is unwise to make additions that may enter into chemical combination with it, for other properties may be imparted that will completely debar it from use. All doctoring of an ink should be done by the maker, or by the use of ingredients made and recommended by him.

225. Pigments.—There is an infinite number of pigments used in the making of printing-ink, some of them occurring as earths in a raw or natural state, some are burned, some are precipitated from chemical mixtures, and others are made by dyeing a base with some coloring matter. No matter what the process of preparation, the object of the pigment is to give body and color to the ink. The pigments used in printing-inks vary in tinctorial strength. Ivory black has greater covering power than either carbon black or lampblack. For this reason a high-price ink is sometimes cheaper in the long run than a low-price one, because, cost for cost, it will cover a larger area than will the low-price one.

226. The Vehicle.—The vehicle which carries the pigment and permits it to be rolled out and spread thinly over a surface,

is *varnish*. Varnishes for printing-inks are made from rosin-oil and from linseed-oil, the better grades being made from the latter. Linseed-oil is obtained from the seeds of the flax plant. The seeds are crushed, heated, and put into hydraulic presses which squeeze out the oil, leaving a residue known as oil-cake, which is used as fodder. The seeds are about sixty-five per cent oil. The raw oil is boiled for definite periods, depending on the consistency or viscosity desired. The longer the oil is boiled the more viscid it becomes. It is thus possible to obtain a varnish suitable for mixing ink for almost any purpose. Each particular branch of printing requires a different kind of ink. The inks used in lithography, die-stamping, or intaglio printing are not adapted for letterpress work.

227. The Drier.—When linseed-oil, or a varnish made from it, is exposed to the air it absorbs oxygen and turns to a gum. When a varnish and a pigment are intimately mixed together, each individual particle of pigment is encysted in a covering of varnish. When rolled out thinly and exposed to the air, the varnish dries by absorbing oxygen from the air. This drying can be accelerated by mixing with the varnish some substance that will yield up oxygen to the mixture or cause it to take it up quicker from the air. Such substances are called *driers*. There are quite a number of combinations used, but one of the best is a mixture of the oxides of lead and manganese. Prussian, Chinese, and bronze blues have a natural affinity for oxygen and dry quickly.

Nearly every ink-maker has his own formula for the making of driers, and it is well to use ink and drier from the same manufacturer. You then know that the drier is adapted to the ink. Driers come in liquid and in paste form. The paste form is considered the better, especially for inks that are to be kept stiff, because it does not thin the ink as does the liquid form.

Soft ink will dry quicker on absorbent paper than on hard paper, because drying is facilitated by the absorptive power of the stock. Soft ink should not be used on hard paper because the paper is not absorbent. Hard papers require stiff inks, and

the ink should be firmly pressed into the paper. Stiff inks dry by oxidation; soft inks partly by absorption, partly by oxidation.

228. Pressroom Temperature and Humidity.—To the uninitiated, the putting on of ink and the printing of a job appears the simplest of operations. So it is when everything is just right. But everything isn't always just right. Every change in temperature or in the amount of moisture in the air alters conditions. Ink that gives satisfactory results at one temperature may not work well at another. Paper that will not "pick" under ordinary conditions may peel off on a damp day. The ink may be too stiff or too soft. It may give a mottled impression. It may offset. Sometimes ink will dry on the press while running, but will not dry overnight on paper. In fact, the pressman's troubles are legion.

The time is undoubtedly coming, and is, perhaps, not far distant, when the up-to-date pressroom will be glass-encased, where temperature and humidity can be kept under perfect control. When this is done a major portion of the trouble will be eliminated. Not only does humidity affect the working qualities of rollers and ink, but it also entails endless trouble in the registering of forms, especially with enamelled papers. Paper forty-four inches long has been known to expand one-fourth of an inch overnight. Nearly every experienced pressman can recount some unpleasant experience resulting from the expansion of paper. The author knows of one job, printed in nine colors on enamelled paper. It took about two weeks to complete the job, during which time there were many changes of temperature and humidity. If one color ran over from one day to the next, the first day's work would not always register with the next day's work. If the humidity varied from morning to evening, the sheets also varied; so did the register. When the job was completed, about one-half of the sheets were thrown away because they did not register.

229. Adapting Ink to Stock.—In order to produce a perfect effect in printing, the ink must be suited to the stock. If the job has many halftones of fine screen, a highly enamelled paper

is essential. If the coating on the paper is tender, a soft ink must be used to prevent the "tack" of the ink from pulling off the coating. The best plan for overcoming black-ink troubles with halftones on enamelled paper is to have two inks from the same maker, one a soft halftone black the other a stiff halftone black. By a judicious mixing of these two, any consistency required may be obtained. If the stiff ink is too stiff, add the soft ink; if the soft ink is too soft, add the stiff ink. In fact, if the printer be provided with two different consistencies for each color of ink, he can overcome nearly all his troubles. It may be argued that the addition of a thin varnish will accomplish the same result, but such is not the case. If varnish is added to an ink the ink is thinned and its covering power decreased. More ink is secured but it has less pigment per square inch; on the other hand, if the soft ink as sent out by the maker is used the covering power is retained yet the ink is softened.

230. How to Remedy Ink Troubles.—A proper appreciation of the changeable composition of a printing-ink and of the multitude of variable conditions that arise during its use usually leads to the best ways of overcoming ink troubles. Every change in temperature produces a change in the consistency of the ink. If the ink gets cold it becomes stiff and causes trouble. To remedy this, the temperature must be raised, or if this is not possible, the consistency must be varied, usually by the use of a thinner varnish, or, better, by mixing the stiff ink with a softer ink. If the temperature rises, making the ink too soft, obviously, it should be mixed with a stiff varnish or a stiffer ink. The proper temperature for a pressroom is between 70° and 80° F.

If the ink pulls off the face of the paper, it is too stiff; it should be softened. If it offsets, too much ink is being carried, there is not enough impression on the job, or there is not enough drier in the ink. The remedy in each case is obvious.

If an ink gives a mottled impression, this is evidence that the ink is too thin and lacks cohesion; it needs more "tack." Add heavy varnish, or use a heavier-bodied ink.

231. Dopes.—Nearly every experienced pressman has gathered an outfit which he terms “dope.” Each of these substances he uses for specific purposes. Occasionally a pressman is found who pins his faith to one “dope,” which he considers a panacea for all ink troubles. Another will have an array of red, white, and blue powders; paste and liquid driers; castor-oil, vaseline, turpentine, sodium silicate, etc. With this battery, he feels competent to tackle any ink trouble that arises. Frequently he would be better off without such so-called remedies. If he is not fully aware of just what action each has under every condition of temperature and humidity, he is usually groping in the dark. The value of the time wasted by a pressman trying to get an ink to work properly may frequently be more than the cost of an ink that would work properly without doping.

At the same time, there is no denying the fact that it is not always convenient to stop a press while waiting for the inkman, and the pressman must frequently rely upon his own resources. The novice should, however, undertake to remedy ink troubles only under the guidance of a competent pressman. Unless the pressman is also an ink chemist or knows definitely from previous experience what the result will be, it is rather risky to tamper with an ink by the addition of other materials. As stated before, the safest way to handle the ink problem is to have a stiff and a soft ink of the same color. By a judicious admixture of these two a suitable ink may usually be obtained. If not, then consult the inkman; the problem is his.

232. Mixing Ink.—It frequently happens that a job is to be printed in a specified color and the pressman is called on to match it. This he can sometimes do by mixing inks that he has in stock. It is a process, however, that calls for a well-developed color perception and a knowledge of color analysis. Here is an extremely interesting field for a pressman who is anxious to get ahead in his work, for a pressman who knows how to obtain a particular tint without wasting time in its produc-

tion is a valuable acquisition to any office and need never be out of employment.

The student is urged to read and digest Andrews's "Color and Its Application to Printing" and Munsell's "Color Notation." Both of these writers advocate a theory regarding color that is at variance with that usually accepted, but Andrews offers so much that is of practical value that the pressman will do well to read his book carefully. He also gives specific directions for color-mixing.

233. Mixing Tints and Shades.—The inexperienced pressman will sometimes make the mistake of adding a little white to a large amount of the body color when he wishes to obtain a tint of that color. This is wrong practice. When mixing colors, always put the stronger color into the weaker, and do so by adding a little at a time. If a tint is to be matched, and it is not known what body color has been used, try the experiment of adding a faint trace of the strong color assumed to be the correct one to a little white. Mix a little of the combination only until assured that the right color is being used. When this has been determined, proceed with the mixing by taking the required amount of white and adding the body color until the right tint is secured. It is always better to mix a little more than seems necessary, for if there is any shortage much valuable time will be wasted in matching the second mixture with the first. Use a glass slab when mixing inks, for it can easily be kept clean. Work the colors together thoroughly with a palette-knife.

When a certain shade is desired, if it is to be made by the addition of black or some darker color, take a volume of the lighter color and add the darker to it. Make the addition gradually, and mix the ink thoroughly as just explained.

234. Duotone Inks.—Two-color effects are obtained in printing halftones by two distinct methods. In one, known as the *duograph* or *duotype*, two halftone plates are prepared, one for printing the halftone proper the other for printing an undertone. The other method is by the use of duotone ink.

“Duotone” means two tones, and the effect of two tones is obtained by one printing.

If a halftone picture printed with duotone ink is examined it will be noticed that each dot in the halftone seems to be surrounded with a halo of a lighter color. This is due to the fact that the ink is composed of two colors that have not amalgamated, the lighter of which has spread out over the paper producing a stain, very much as a splash from a shaft-hanger would do if the thick, dirty oil dropped on a piece of paper. The most peculiar feature of the ink is that the job must be dried in the dark. If dried in the light, the undertone does not develop. Do not attempt to modify a duotone ink by the addition of dope, especially if any other part of the job has been printed with the same ink without doping.

235. Halftones.—Before the student can have a definite idea of the use of process inks it is essential that he should understand the method of making halftones and be familiar with the theory underlying process work.

In the production of the beautiful halftones that are now so much in evidence in modern printing, the photographic image is kept on the surface by breaking it up into dots. If these dots be examined it will be found that while they are uniformly spaced, they vary in size, ranging from almost imperceptible dots to sizes so large that they coalesce. This is accomplished by the use of a screen, which is placed in the camera, in front of the negative, while the picture is being taken. These screens are made by ruling pieces of glass with a series of parallel lines, then filling the lines with some opaque material. Two pieces are placed face to face, with the lines running at right angles, and cemented together. This produces a checkerboard with minute openings. The halftones in this book were made through a screen having one hundred and thirty-three lines to the inch. Newspaper halftones are usually sixty-five lines to the inch. Screens as fine as four hundred lines to the inch have been made. This means four hundred lines and four hundred spaces, yielding a space $1/800$ part of an inch wide.

236. Three-color Process Work.—According to the Brewster theory of color, the primary colors are red, yellow, and blue. From these the secondary colors, orange, green, and purple, may be mixed; and by the mixture of a primary and a secondary a tertiary color is produced. From this it is evident that all colors may be obtained simply by the admixture of the primaries in different proportions. The production of the beautiful three-color process engravings is accomplished by the use of a half-tone screen and by photographing the colored original through three different color-filters. Three separate plates are made. According to the amount of red in the original picture, dots of the required size to give the right amount of red in the finished picture will be provided for in the red plate; wherever yellow is needed in the finished picture the right amount will be provided for in the yellow plate; the same with the blue.

When the three plates are printed from, the effect is as if the object were printed in an infinite number of colors. If examined under a magnifying-glass it will be seen that the picture is built up of a mixture of red, yellow, and blue dots of varying size. It will also be noticed that the production of a hue is not due to the printing of one dot over another, but by printing them beside each other.

It is obvious that the juxtaposition of red and blue gives the effect of purple. If red predominates, the effect is a reddish purple; if blue predominates, it is a bluish purple. If the dots are small and much of the white of the paper is visible, the effect is that of a tint.

When making the negatives the lines of the screen are placed at a different angle for each plate, to avoid the production of a checkerboard or moire pattern in the picture.

237. Process Inks.—It has been found that inks that match the true spectrum colors do not give good results in three-color process work. By experiment, certain hues of the three fundamental colors—red, yellow, and blue—have been found which produce excellent results. These inks are called *process inks*. When printing, the plates are run in the order, yellow, red, blue.

Owing to the fact that the three fundamental colors cannot produce a black or a gray shadow, a fourth color is sometimes resorted to. This color is a grayish black. When printing a four-color process picture, the following is the proper order: yellow, red, black, blue. It is better to run the black before the blue, for if the black is run last and darkens the tones of the greens, there is no opportunity to rectify the trouble. If the blue is run last, the right hue may be used to produce the required tones of green.

When one ink is printed over another, if the first ink dries hard, it is frequently necessary to increase the tack of the one that is to be superposed; each subsequent one being tackier. Ink-makers provide special preparations that may be used to obviate this trouble.

QUESTIONS ON CHAPTER XV

1. Name three things that every letterpress printing-ink should contain.
2. What is a pigment ?
3. Of what use is varnish in a printing-ink ?
4. Of what substances are varnishes usually composed ?
5. What is a drier ? Why is it used ?
6. Is a drier absolutely necessary in a printing-ink ?
7. What is the difference between a liquid and a paste drier ? Tell under what conditions each should be used.
8. Why does soft ink dry quicker on some papers than on others ?
9. What kind of ink should be used on hard papers ? on soft papers ?
10. What effect have temperature and humidity on the working qualities of an ink ?
11. If the ink you were using pulled the face off of the paper, how would you rectify the trouble ?
12. If the ink was too thin, how would you stiffen it ?
13. What is the disadvantage of using varnish to soften an ink ?
14. What is the matter with an ink that gives a mottled impression ?
15. What do you understand by "tack" ?
16. Name some of the substances used by pressmen in doping ink.
17. Explain the proper method of mixing tints and shades.
18. What is a duotone ink ?

19. Explain how and why a duotone ink develops two tones, and tell what special handling of the sheets is necessary for perfect results.
20. What is a halftone plate? How is the printed image produced?
21. What is the Brewster theory of color?
22. What do you understand by three- and four-color process work?
23. What colors of ink are used in the three-color process? in the four-color process?
24. Name the order in which the colors are printed in three-color process work; in four-color process work.

CHAPTER XVI

PAPER

238. Origin.—Paper, that indispensable substance for which modern civilization finds so many uses, had its origin in the papyrus plant, from which it derives its name. The early Egyptians split the stalk of the plant in two and peeled off the pellicle in layers, then placed these so that they overlapped, and stuck them together with some adhesive, thus producing sheets or leaves.

The modern article consists of a prepared fiber mixed with a number of substances that act as binder, filler, coloring matter, etc. These substances are intimately mixed, and after passing through a number of processes are finally laid out on a moving wire screen which produces the paper as a continuous web.

239. The Fiber.—If a piece of paper be torn apart and a section of it held to the light, it will be seen to possess a feathery edge. This is the *fiber*. It is the most important part of the paper, and gives it strength. Long-fiber papers are stronger than short-fiber ones made from the same materials.

All fibers are of vegetable origin. While there are a great number of long and strong vegetable fibers throughout the world, the cost of preparation and importation makes their use prohibitive. Owing to the low rate at which paper must be sold, the cost of the raw material is an important factor. Of our native fibers, flax (linen) and cotton are most commonly used. Linen makes the very best paper, cotton ranking second. Other substances are as follows, in the order of their importance: wood, esparto (a grass), manila, and straw. Anything that yields a fiber is useful for paper-making. The residue of licorice-root, after the extraction of the licorice, is used. The linen and

cotton used in the better grades of paper are obtained from shirt and collar factories. Other grades are made from old rags. Rag stock is stronger than wood-pulp. Paper is frequently made by combining them.

The bulk of the paper used, however, is made from wood-pulp. Owing to the fact that timber is becoming scarce in the eastern section of the United States, wood is being made into pulp in the forests and shipped to various paper-making centers. Much of the pulp used in the United States comes from Norway, where, owing to the wooded mountains and the consequent cheapness of water, water-power, and timber, it can be produced and imported into the United States in competition with the home product.

240. Pulp.—The first step in the preparation of fiber for use in paper-making is to reduce the material to pulp. If pure white linen or cotton cuttings are used no special preparation is necessary other than to dust them and then cook them in an alkaline solution with steam, after which the fibers are thoroughly washed and bleached. If assorted rags are used, they are taken to a sorting department, sorted and graded, then cut into small pieces, dusted, and boiled in a strong solution of alkaline water to loosen the coloring matter, after which they are washed thoroughly and bleached. They are then ready to go into the beater.

Before wood-pulp is put into the beater it is prepared by grinding the wood mechanically or by treating it chemically. The paper used in the average newspaper is made from mechanical wood-pulp. The mills that make the paper are located near the source of supply. The trees are cut down, carried to the mill, stripped of the bark, put on inclined tracks, carried against circular-saws, cut to lengths, dropped into hoppers, held against grindstones, and ground to short fiber. To prevent the heat generated by grinding from igniting the wood, a stream of water is played against the wood and grindstone. The water carries away the ground particles. They are passed over a sieve, which excludes all that are not sufficiently minute

to be used in making paper. As mechanical wood-pulp contains various deleterious substances, it deteriorates rapidly and darkens on exposure to light.

Chemical wood-pulp is made by treating small particles of wood with chemicals to remove all extraneous substances and leave nothing but the fiber, which is really the cell-walls of the plant. There are two methods of making chemical wood-pulp—the *soda process* and the *sulphite process*. The former is the cheaper process, but the latter yields a stronger fiber. In both processes the wood is first chipped into small particles. In the soda process the chips of wood are put into a cylindrical tank, called a *digester*, together with a specified amount of caustic soda, and subjected to live steam at a pressure of about eighty pounds, for about eight hours, the cylinder being rotated during the boiling. The tank is then opened, the liquor drained off, and the pulp thoroughly washed. The first liquor is pumped into evaporators, where it becomes a syrup, after which it is burned and the soda reclaimed as soda-ash. After being mixed with lime the soda ash again becomes caustic soda, and can thus be used again and again. It is due to this reclamation of soda that the soda process is cheaper than the sulphite process, for with the latter all the chemicals are washed away and lost.

241. The Beater.—In order to thoroughly incorporate the ingredients, and also grind the fiber into minute particles, all of the materials of which paper is composed are put together into a device called a *beater*. (See Fig. 149.) The material passes between a steel or stone bedplate and a revolving roll on the periphery of which thick steel bars have been uniformly placed. The space between the roll and the bedplate can be accurately adjusted so that the fiber in passing between them is torn, dragged, or teased out so as to produce a feathery end instead of being cut off. This causes the fibers to mat together in the web of the paper, and produce a stronger article.

242. The Refining-engine.—From the beater the pulp, now called *stuff*, goes to a machine called a Jordan, or refining-engine (Fig. 150), which in action and appearance is very much

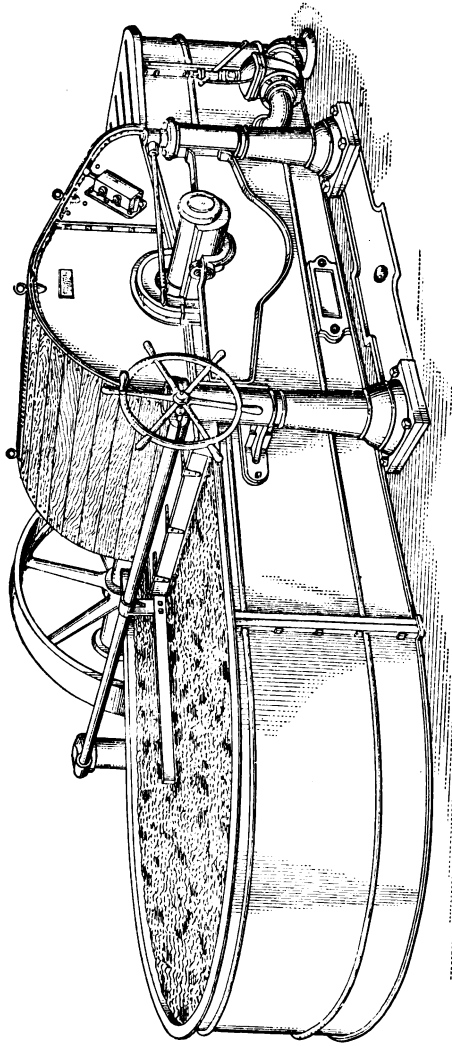

FIG. 149.—A Beater.

like a coffee-mill, except that it is fully encased. Here the stuff receives its final grinding or refining, after which it passes on its way to the paper-making machine.

243. The Paper-making Machine.—Figs. 151 and 152 show respectively the wet end and the dry end of a paper-making machine. After the stuff leaves the Jordan it passes into a sand-trap, where it is mixed with a great quantity of water, and as it flows along all heavy particles, such as sand, iron, or other foreign substances, sink to the bottom and are caught by ripples. The stuff continues on its way, passing through a fine screen to the head- or regulating-box, thence out under the gate on to the wire screen.

The gate is adjusted to allow a certain amount of stuff to pass through in a given time, and is very seldom changed. Different thicknesses of paper are obtained by regulating the speed of the machine. The faster the machine goes the thinner the paper produced; the slower the machine the thicker the paper. In fact, the machine is really laying out a predetermined weight of paper in a given time. The daily output of a machine, in tons, is fairly constant, provided the paper is not so thin as to be troublesome, in which event the speed of the machine and the set of the gate may have to be altered.

As the stuff emerges from under the gate it flows onto a moving copper screen, of fine mesh, made like an endless belt. The screen is moving forward at a uniform rate, taking a uniform layer of stuff. A sidewise shaking motion is imparted to the end of the screen nearest the regulating-box which tends to set the fibers at various angles, causing them to mat together.

As the screen moves forward, the bulk of the water in the stuff passes through the screen by gravity. In its forward journey the stuff passes over suction-boxes, where the balance of the water is removed. The stuff is prevented from flowing off the sides of the screen by a belt of rubber, called a *deckle*, which moves forward in unison with the screen. The shaking motion of the screen tends to force some of the stuff beneath

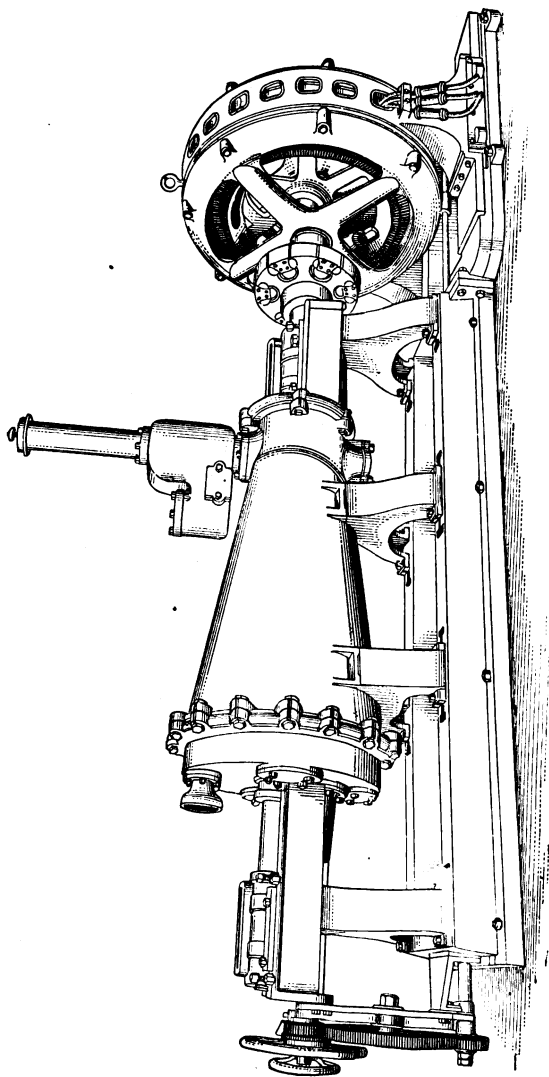

FIG. 150.—A Motor-driven Jordan, or Refining-engine.

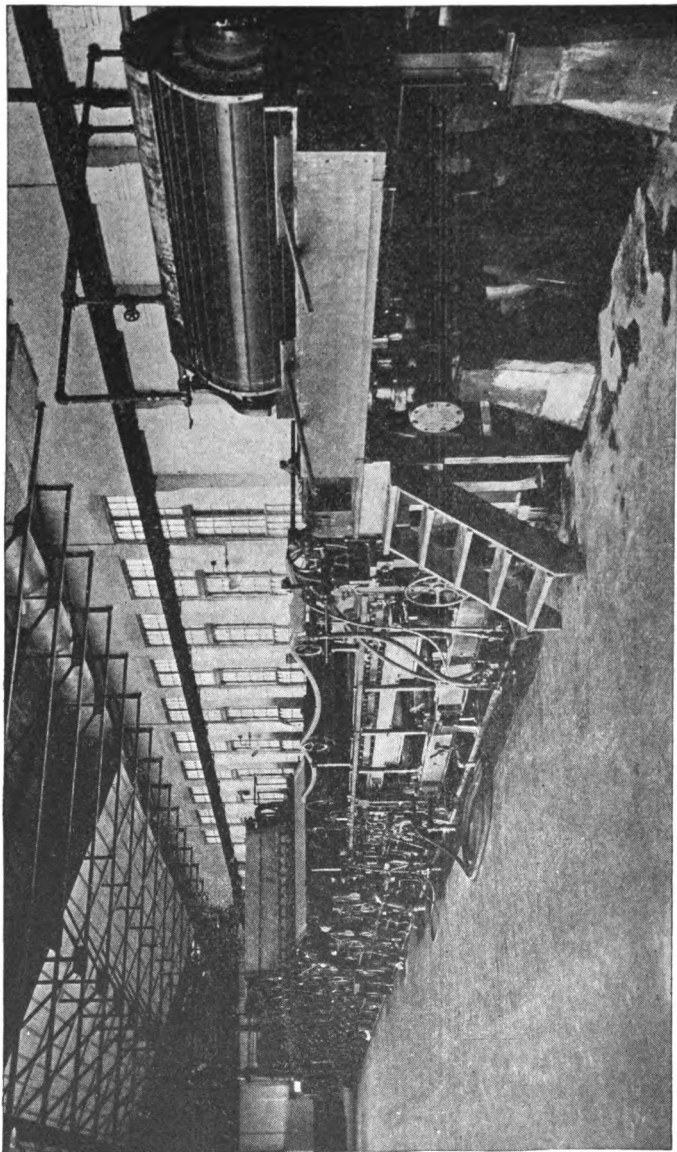

FIG. 151.—The Wet End of a Paper-making Machine.

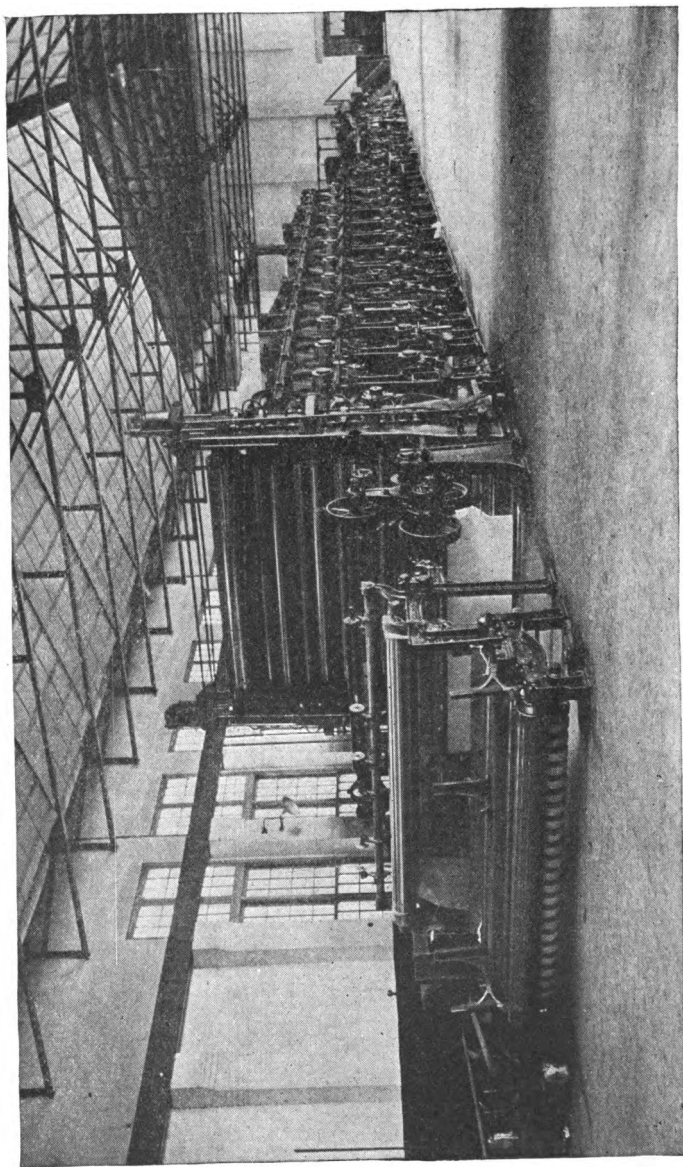

FIG. 132.—The Dry End of a Paper-making Machine.

high-grade work. If the deckle is not desired, it is cut off with a jet of water, before the stuff leaves the screen.

If the paper is to be watermarked, either with a name, trade-mark, or with a series of parallel lines (thus producing laid paper), it is passed beneath a *dandy-roll*, which is a hollow cylinder of wire gauze, on which the design is worked out with thin wire, soldered fast to the outside surface of the cylinder. The weight of the cylinder presses the design into the still plastic mass of the paper, pushing aside the material. The reason the watermark is visible when held to the light is because the paper is thinner at those places.

After leaving the screen the paper is run between heavy brass rolls and rolls covered with thick blankets or felts. This serves to compress the paper, absorb the balance of the water, and, so far as possible, obliterate the mark of the wire screen.

From the felts the paper goes to the drying-rolls or drums. These are heated by steam, and by the time the paper emerges from the rolls it is thoroughly dry. It is then passed through a *calender* to impart a finish, after which it is cut to size if machine-finished, or rolled up if it is to have further treatment.

The necessity for an abundance of pure, clean water in the making of paper will be realized when it is stated that in all the operations necessary from the time the wood fiber is put into the digester until it is laid out in a thin layer on the wire screen, a barrel of water has been used in the preparation of two pounds of paper. As the diluted stuff floats from under the gate to the wire screen it is ninety-six per cent water.

244. Hand-made Paper.—If a sheet of machine-made paper is torn, it will be found that it tears more readily in one direction than at right angles to that direction. This is due to the fact that the forward movement of the screen under the gate has had a tendency to set the fibers in a longitudinal direction. This is known as the *grain* of the paper. All machine-made papers possess this grain. Hand-made papers, however, owing to the way in which they are made, do not possess a grain.

When making paper by hand, the workman uses a wooden framework, or mold, covered with a copper screen. Another framework, known as the deckle, is fitted over the screened framework, and both of them are dipped into a tub containing the stuff. The mold is then drawn upward through the stuff, rapidly or slowly, as may be necessary, so as to leave an even and uniform deposit of stuff on the screen. As the mold is being withdrawn it is given a constant circular motion, which tends to swirl the fibers at all angles, and prevents grain. After the water has drained from the stuff, it is put between sheets of felt, and then compressed in a screw-press, after which it is hung up in lofts to dry. Hand-made papers are very much stronger than machine-made papers.

245. Book Papers.—There is an infinite variety of papers. The most important are *machine-finished*, *sized-and-supercalendered*, and *coated* or *enamelled papers*.

Machine-finished papers require no subsequent treatment after leaving the machine, but are usually cut to size after leaving the calender.

Sized-and-supercalendered papers, called engine-sized by paper-makers, are made by adding the sizing to the other ingredients in the beater. This sizing is usually saponified rosin, which is precipitated on the fiber by the use of alum. After the paper leaves the drying-drums it is rolled up and then conveyed to a calendering-machine, where it is steamed to bring out the starch, after which it is passed between calenders, which burnish the surface and impart a gloss.

A calendering-machine (Fig. 153) consists of heavy rollers, some of polished chilled-iron, others made up of disks punched out of sheets of paper. These disks are put on a mandrel and subjected to many tons' pressure, thus making a cylinder of solid paper, with the edge of each sheet on the circumference of the roller. This cylinder is then turned down in a lathe to proper size, after which it is ground and polished. The iron and paper rolls are of different diameter, and are placed alternately in the calendering-machine. When the machine is set

in motion there is friction between the surface of the rollers and the moving web of paper, and a gloss is imparted.

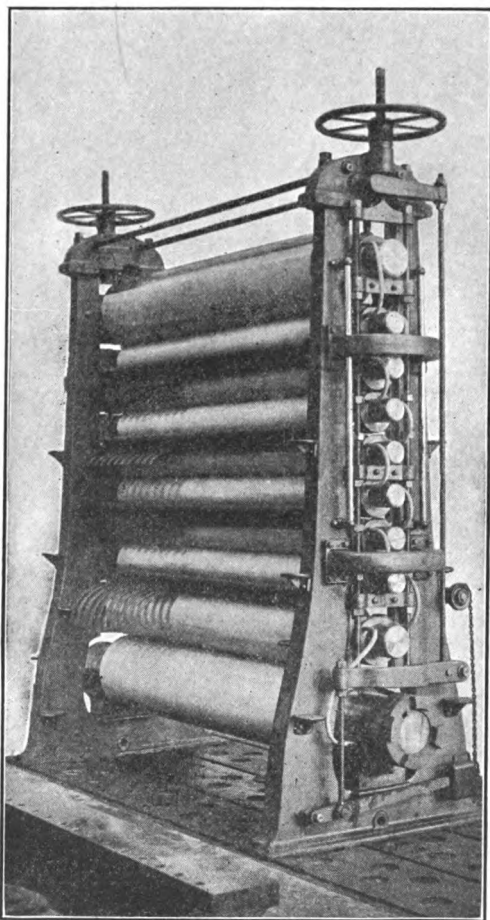

FIG. 153.—A Stack of Calenders.

Coated or enamelled papers are usually prepared by first making a web of paper, then passing the sheet through a trough containing the coating, after which it is passed between rollers to

squeeze off the surplus and leave an even, smooth coating, or by putting on the coating by the aid of brushes, which leaves it in a smooth, even layer. After coating, the paper is passed through calenders to be polished.

246. Flat Papers.—There was a time when nearly all large sizes of paper were folded before delivery, the smaller sizes being delivered flat. These were called *flats*. The name still persists for the smaller sizes, even though all large book papers are now delivered flat. Flats are the papers usually used for writing purposes, and embrace writings, bonds, and ledgers.

Owing to the high state of perfection attained in the manufacture of paper, it is almost impossible to tell from a superficial view of a sheet of paper of just what it is composed. Some papers watermarked linen ledger have so little linen in them that the amount is negligible.

Ordinary writings, especially the cheaper grades, contain nothing but wood fiber, and are composed of ingredients that impart to it a finish that will take writing-ink.

Bond papers are composed of good, strong fiber, with plenty of sizing which gives them a hard finish.

Ledger papers are bond papers that have been tub-sized to give them a coating that will fill up the pores and impart a smooth finish, specially adapted to writing-ink.

Papers that are to be used in blank-book making, especially matters of record, should be made from all-linen rags.

247. Sizes of Paper.—In the early days of paper-making, manufacturers restricted themselves to a moderate number of sizes. Today, papers, especially book papers, may be obtained in almost any size and weight. Flat papers have not changed as much as book papers. The following list gives the names and sizes of flat papers:

Demy,	16"×21"
Folio,	17"×22"
Medium,	18"×23"
Royal,	19"×24"
Double Cap,	17"×28"

Super Royal	20"×28"
Double Demy, Broad,	21"×32"
Double Demy, Long,	16"×42"
Double Folio,	22"×34"
Double Medium,	23"×26"
Double Royal,	24"×38"
Double Double Cap,	28"×34"

Some book papers may be obtained in the following sizes:

22"×28"	28"×44"
22"×32"	30½"×41"
23"×33"	32"×44"
25"×38"	33"×46"
28"×42"	38"×50"

248. The Ream.—The average schoolboy is being taught that there are twenty-four sheets to a quire, and twenty quires to a ream. This makes four hundred and eighty sheets to a ream. This is the legal ream. All papers (except a few imported ones and those that are so expensive that they are worth upward of two cents a sheet) are now made up into reams of five hundred sheets, or twenty-five sheets to a quire. As most jobs are ordered by the thousand, or a multiple thereof, this facilitates the computation of the necessary stock.

249. Weights of Paper.—A paper is known by the number of pounds it weighs to the ream of five hundred sheets. Book papers are based on a sheet 25×38 inches in size; flats, on a basis of 17×22 inches; cardboard, on a basis of 22½×28½ inches. If a paper-dealer were to test a sheet of paper by feeling it and say that it feels like an eighty-pound paper, he means that a ream of it, 25×38 inches in size, would weigh eighty pounds. If the stock were a writing, a bond, or a ledger, and he said that it feels like a twenty-pound paper, he means that a ream of it, 17×22 inches in size, would weigh twenty pounds.

250. Relative Weights.—It is evident that paper that weighs a given number of pounds to a ream 25×38 inches in size will weigh more if the sheet be larger and less if it be smaller.

These variations are known as *relative weights*, and they seem to be very perplexing to the average printer, for paper-dealers are daily called on to tell some printer what weight ream to order if he wishes to use a certain paper in another size. The calculation is comparatively simple.

If a ream of paper 25×38 inches in size, and weighing eighty pounds, were cut into piles one inch square, and one of these square inches containing five hundred sheets were weighed, *the weight of one square inch per ream* would be obtained. Or, by computation, as there are 950 square inches in a sheet 25×38 inches an eighty-pound ream would weigh 80 pounds divided by 950 = .08421 pound per square inch per ream. With this number as a constant the weight of any other size sheet may be found simply by multiplying the weight of one square inch per ream by the number of square inches in the sheet.

Example.—How much will a ream composed of sheets 32×44 inches weigh on a basis of 25"×38"—80 lb.? Using the above constant, .08421×32×44 = 118.57 pounds, or such a ream would weigh 118.57 pounds. As paper weights are never given in fractions of a pound, this weight would be listed by a paper-dealer as one hundred and twenty pounds to the ream.

The usual formula for determining relative weights of paper is the following:

$$\frac{\text{desired size} \times \text{basic weight}}{\text{basic size}} = \text{desired weight.}$$

Thus,

$$\frac{32 \times 44 \times 80}{25 \times 38} = 118.57 \text{ pounds.}$$

This formula is merely a mathematical expression of what has been explained above. The solution of the problem may be greatly simplified by cancellation: thus,

$$\frac{\overset{22}{32} \times \overset{16}{44} \times 80}{\underset{5}{25} \times \underset{19}{38}} = \frac{32 \times 22 \times 16}{5 \times 19} = \frac{11264}{95} = 118.57.$$

251. The Lakeside System.—The Lakeside Press, of Chicago, has evolved a plan of expressing paper weights according to a unit, the unit being one-thousandth of a pound. In Section 250 it was found that the weight of one square inch per ream of eighty-pound paper was .08421 pound. Expressed in thousandths, this would be 84.21; or an 84.21-unit paper.

If every package of paper were marked on this unit basis, it would simply be necessary to multiply the unit by the number of square inches in any size sheet to know how much a ream of it would weigh.

Example.—How much will a ream of 84.21-unit paper weigh if the size is 28×42 ? To solve, multiply $84.21 \times 28 \times 42$ and point off three decimal places for thousandths; the answer is pounds per ream.

$$\text{Thus, } 84.21 \times 28 \times 42 = 99.03.$$

This would be listed by a paper-dealer as 100 pounds per ream. Consult Table VI.

252. Designating Paper According to a Substance Number.—It will be apparent from what was stated in Section 250 that the different stock sizes and weights listed by paper-dealers are not absolutely the same paper, but only relative. This means that the paper-maker must make an infinite number of weights of paper so that when cut to specified sizes they will weigh an even number of pounds per ream. To illustrate: according to the calculation in Section 250, if exactly the same paper for size $32'' \times 44''$ as for $25'' \times 38''$ had been used, the ream would have weighed 118.57 pounds. The paper-maker does not make any such weight. He must slow down his machine so that the paper produced will weigh 120 pounds to the ream.

To avoid the necessity for making a great number of weights of paper, the American Writing Paper Manufacturers Association has inaugurated a method of designating paper according to a substance number. That is, taking $17'' \times 22''$ as a basis, a paper that weighs thirteen pounds to the ream is called a No. 13

TABLE VI.—RELATIVE WEIGHTS OF PAPER
BASED ON THE UNIT SYSTEM

Unit.	Size in Inches 20 X 25 500 Sq.in.	Size in Inches 22 X 28 616 Sq.in.	Size in Inches 24 X 36 864 Sq.in.	Size in Inches 25 X 38 950 Sq.in.	Size in Inches 28 X 42 1176 Sq.in.	Size in Inches 32 X 44 1408 Sq.in.
25.0	12.50	15.40	21.60	23.75	29.40	35.20
30.0	15.00	18.48	25.92	28.50	35.28	42.24
35.0	17.50	21.56	30.24	33.25	41.16	49.28
35.5	17.75	21.86	30.67	33.72	41.74	49.98
40.0	20.00	24.64	34.56	38.00	47.04	56.32
42.1	21.05	25.93	36.37	39.99	49.50	59.27
42.6	21.30	26.24	36.80	40.47	50.09	59.98
45.0	22.50	27.72	38.88	42.75	52.92	63.36
46.1	23.05	28.39	39.83	43.79	54.21	64.90
50.0	25.00	30.80	43.20	47.50	58.80	70.40
51.0	25.50	31.41	44.06	48.45	59.97	71.80
52.6	26.30	32.40	45.44	49.97	61.85	74.06
55.0	27.50	33.88	47.52	52.25	64.68	77.44
56.8	28.40	34.98	49.07	53.96	66.79	79.97
57.8	28.90	35.60	49.93	54.91	67.97	81.38
60.3	30.15	37.14	52.09	57.28	70.91	84.90
63.1	31.55	38.86	54.51	59.94	74.20	88.80
65.0	32.50	40.04	56.16	61.75	76.44	91.52
68.0	34.00	41.88	58.75	64.60	79.96	95.74
70.0	35.00	43.12	60.48	66.50	82.52	98.56
71.0	35.50	43.73	61.34	67.45	83.49	99.96
73.0	36.50	44.96	63.07	69.35	85.84	102.78
75.0	37.50	46.20	64.80	71.25	88.20	105.60
80.0	40.00	49.28	69.12	76.00	94.08	112.64
84.2	42.10	51.86	72.74	79.99	99.01*	118.55*
85.0	42.50	52.36	73.44	80.75	99.96	119.68
90.0	45.00	55.44	77.76	85.50	105.84	126.72
92.5	46.25	56.98	79.92	87.87	108.78	130.24
94.6	47.30	58.27	81.73	89.87	111.24	133.19
100.0	50.00	61.60	86.40	95.00	117.60	140.80
102.0	51.00	62.83	88.12	96.90	119.95	143.61
105.2	52.60	64.80	90.89	99.94	123.71	148.12
110.0	55.00	67.76	95.04	104.50	129.36	154.88
126.3	63.15	77.80	109.12	119.98	148.52	177.83

* The reason these weights do not agree with those given in the text is because the unit is here given as 84.2 instead of 84.21.

paper; if it weighs sixteen pounds to the ream it is a No. 16 paper; if it weight twenty pounds, it is a No. 20; and so on.

As this book goes to press the American Paper Manufacturers Association has before it for consideration a plan outlined by the author for making paper according to a definite unit. The plan, briefly, is this: adopt $\frac{1}{1000}$ of a pound per square inch per ream as the unit; graduate the different unit-numbers in tens. Weights would then be expressed as 10-unit, 20-unit, 30-unit, 40-unit, etc., instead of pounds per ream. To determine the weight of any ream of paper multiply the size in square inches by the unit, point off three decimal places, and the answer is the weight per ream. To avoid long decimal fractions, the weight to be given in the nearest half-pound. For example: size 22×28 , 90-unit, would weigh 55.44 pounds; this would be considered a 55.5-pound paper.

This method differs from The Lakeside System in that it advocates making paper according to a definite unit instead of calculating present weights on a unit basis. If this method is adopted, twelve unit-weights, ranging from 30-unit to 140-unit, inclusive, will supply every paper need.

253. Envelope Sizes.—Nearly all paper-dealers are now making paper and envelopes to match, in sizes suitable for office stationery. If special sizes are desired, they can be made to order. Table VII gives the numbers and sizes of envelopes ordinarily carried in stock in standard white papers.

TABLE VII.—ENVELOPE SIZES

COMMERCIAL			
No.	Size.	No.	Size.
5.....	$3\frac{1}{16}'' \times 5\frac{1}{2}''$	10.....	$4\frac{1}{8}'' \times 9\frac{1}{2}''$
$6\frac{1}{4}$	$3\frac{1}{2}'' \times 6''$	11.....	$4\frac{1}{2}'' \times 10\frac{3}{8}''$
$6\frac{3}{4}$	$3\frac{5}{8}'' \times 6\frac{1}{2}''$	12.....	$4\frac{3}{4}'' \times 11''$
7.....	$3\frac{3}{4}'' \times 6\frac{3}{4}''$	14.....	$5'' \times 11\frac{1}{2}''$
9.....	$3\frac{7}{8}'' \times 8\frac{1}{8}''$		
BARONIAL			
No.	Size.	No.	Size.
4.....	$3\frac{5}{8}'' \times 4\frac{1}{8}''$	5.....	$4\frac{1}{8}'' \times 5\frac{1}{8}''$

DRUG AND PAY ENVELOPES

Manila Paper

No.	Size.	No.	Size.
1.....	$1\frac{1}{4}'' \times 2\frac{7}{8}''$	3.....	$2\frac{5}{16}'' \times 3\frac{1}{2}''$
2.....	$2\frac{1}{8}'' \times 3\frac{3}{8}''$	Pay.....	$2\frac{1}{2}'' \times 4\frac{1}{4}''$

254. Figuring and Cutting Stock.—When figuring on stock, be sure that you are planning for the right number that may be cut from a sheet, and always endeavor to use a sheet that will cut to size with as little waste as possible.

Many cover stocks will fold only with the grain and not across it unless scored. If there is any choice in the matter, cut the stock so that it will fold with the grain.

The average letterhead is $8\frac{1}{2} \times 11$ inches in size, and four may be cut out of a sheet 17×22 inches. If a short letterhead ($8\frac{1}{2} \times 7\frac{1}{4}$ inches) is desired, it may be cut out of 17×22 -inch stock, six being obtained from a sheet.

Paper-dealers will not sell an odd number of sheets, and it is necessary to order stock in even quires. The usual allowance for spoilage on a job is two per cent for each time a sheet goes through the press. If the job is a three-color process one, three per cent for each time through the press is not too much.

If it is your duty to cut paper, proceed with extreme caution. Paper is frequently figured to get a certain number out of a sheet in one direction and a certain number in the direction at right angles to this. Many and many a time have such calculations been upset because the cutter took the first cut in the wrong direction!

QUESTIONS ON CHAPTER XVI

1. From what did paper derive its name?
2. What is the substance that gives paper its strength?
3. Name the different plants from which fiber is obtained?
4. What is pulp?
5. What is wood-pulp?
6. Explain the difference between mechanical and chemical wood-pulp.
7. Of the two chemical wood-pulps, which is the better, soda or sulphite? Why?

8. Which is the cheaper process, the soda or the sulphite? Why?
9. What is a digester? Why is it used?
10. Describe a beater, and tell what action it has on the fiber.
11. What is a Jordan?
12. How is paper of different thickness obtained on a paper-making machine?
13. Would it be possible to sell paper by the pound if the paper-making machine always ran at uniform speed? Give reasons for your answer.
14. What per cent of the "stuff" is water, as it runs out on the wire screen?
15. What prevents the "stuff" from running off the screen at the sides?
16. Why does the screen have a sidewise motion imparted to it?
17. What produces the feathery edge on paper?
18. What is the so-called watermark in paper? How is it produced?
19. Why is the plastic layer of paper run between heavy rolls and blankets or felts?
20. Is there any difference in the appearance of the two sides of a sheet of machine-finished paper? What is the difference, and what caused it?
21. How is paper dried while in process of manufacture?
22. What is a calender, and why is it used?
23. Why is hand-made paper stronger than machine-made paper?
24. What is a machine-finished paper? a sized-and-supercalendered paper? a coated paper?
25. What papers are usually known as "flats"?
26. How many sheets in a legal ream? How many in a ream of book paper?
27. Give the basic sizes in the following: book papers, flats, cardboard.
28. What do you understand by a 20-pound paper? an 80-pound paper?
29. What do you understand by relative weights?
30. Give the formula for finding relative weights.
31. How much would a ream of paper $22'' \times 28''$ weigh on a basis of $25'' \times 38'' - 80$?
32. How much would a ream of paper $32'' \times 44''$ weigh on a basis of $25'' \times 38'' - 70$?
33. Explain the Lakeside System of expressing paper weights. Does it differ essentially from the usual method of determining relative weights?
34. What advantages will be derived by making paper according to a substance number?
35. What advantages will be derived by making paper on a unit basis?
36. What difference does it make if cover stock is cut with or across the grain?
37. What is the usual allowance for spoilage?

GLOSSARY

Abbreviation.—Part of a word used as a substitute for the whole word.
Examples: Pa., for Pennsylvania; N. J., for New Jersey.

Accent.—A letter with a mark attached to show that the accent falls on that letter: é, acute; è, grave; ê, circumflex. Other marks, as ë (dieresis), ç (cedilla), ñ (tilde), are diacritical marks, and are used to denote pronunciation.

Agate.—Name used for a size of type. On the point system agate became 5½-point.

Alignment.—When different sizes of type are so justified that their faces all line at the bottom, they are said to be in alignment. See **Point-line**.

Alloy.—A basic metal mixed with other metals to give it certain characteristics. See **Type-metal**.

Antimony.—A metallic element, used in type-metal to make it hard so that it will resist wear.

Antique.—A name given to a type face. The topic headings in this book are set in ten-point Old-style Antique.

Appendix.—That part of a book usually added as an afterthought, or to incorporate matter omitted from the text.

Apprentice.—One who is working under an agreement to serve an employer for a stipulated time, with the privilege of learning a trade.

Ascender.—That part of a lower-case letter that extends above the body of the letter. The letters b, d, f, h, k, l, and t have ascenders.

Balance.—When a piece of type composition has its various parts so grouped that they are equalized in mass, it is said to possess balance.

Bar.—Book chases usually have bars across their centers to prevent them from spreading under pressure.

Bastard.—Anything around a printing office not to standard form or size is said to be bastard.

Beard.—See beard of type, Fig. 29.

Bearers.—**Roller-bearers** are useful in job-press forms when the roller-pins are broken, for they then cause the rollers to rotate. **Electrotype bearers** are pieces of metal, type-high, placed around type forms to protect them while making a mold in wax.

Belly.—When type forms are locked up and tested with a straight-edge, it frequently happens that the lines bind at the ends and show a gradual depression in the center. This is called a **belly**.

Ben Day Process.—A process invented by Ben Day, and used by photoengravers. The process consists in using gelatine films, with designs in relief, which are inked, and the designs transferred to metal plates. After being covered with a resin, which adheres to the ink and is burned on, the plate is etched.

Benzine.—A liquid derived from coal-tar distillation. Used for cleaning type and presses.

Bevelled Rule.—When the face of rule is at one side of the body, and the shoulder slopes to the other side, it is said to be **bevelled**.

Billhead.—A form of office stationery, usually sent with goods on delivery.

Black-letter.—A black-faced type, usually called *text*. So named because when set in mass formation the whole tone of the page is black.

Blank-out.—The blank part of the last page of a chapter. In the days of piecework, when type was mostly all set by hand, the compositor who got the last "take" in a chapter got paid for the blank-out.

Blocks.—Used for temporarily mounting electrotypes. The old form of electrotype block is rapidly giving way to solid and sectional blocks. The latter are composed of units, and can be made up to any size desired.

Bodkin.—A long, tapering, sharp-pointed instrument useful for getting type out of a line while making corrections.

Bodoni.—Designer of the first modern roman type face. There is a type named in his honor.

Body.—See diagram of a type, Fig. 29.

Bold.—Anything that stands out prominently. Certain heavy faces of type are called bold.

Boldface.—A name given to type that is heavier than the text in which it is used. All topic headings in this book are in boldface type. See Proofreaders' Marks.

Book Chase.—A large chase, usually with shifting bars. Fig. 118.

Border.—Anything enclosing a job, and intended to ornament it, is called a border.

Bottled.—When type is so badly worn that it no longer stands upright on its feet it is said to be “bottled.”

Bourgeois.—A name given to a type under the old system, now supplanted by nine-point under the point system.

Braces.—Here are a few samples of braces. See also “Cock and Hens.”

Brayer.—A small hand-roller, used to keep up a uniform supply of ink on a job-press. Sometimes used for inking type when pulling proofs.

Break-line.—The last line of a paragraph.

Brevier.—That size of type now called 8-point under the point system.

Brilliant.—A size of type. Now called 3½-point under the point system.

Bronzing.—Covering a printed surface with bronze powder. The bane of the pressman's life.

Burr.—Any small projection left on metal after some mechanical operation. See Section 178.

Cabinet.—An enclosed wooden or steel frame containing type cases. Some of the newest are very elaborately equipped for holding leads, slugs, and other spacing material. See Fig. 1.

Calculagraph.—A combination clock and time-stamp, so arranged that the elapsed time between two stampings is shown on the sheet.

Calendar.—A printed device showing the months of the year.

Calender.—A mechanical device, consisting of alternate rollers of chilled-iron and paper, and of different diameters, used for polishing the surface of sized and coated papers.

Cancelled Figures.—Figures with strokes through them, used in textbooks of mathematics, etc. $\# \# \# \#$. See under “Imposition,” page 182, also Section 250.

Caps.—Capital letters are usually spoken of as caps.

Caption.—The explanatory matter printed beneath an illustration is called a caption.

Case.—A receptacle for type or other material, partitioned to keep the different items separate.

Case.—The cover of a book, after being printed, stamped, and made up to proper size to fit the book, is known as a case.

Case-rack.—A frame used for the storage of type cases.

Cast.—An exact duplicate of a type form, obtained either by electrotyping or stereotyping.

Castling-off.—Measuring type to ascertain how it will divide into pages.

Catch-line.—A line consisting of a few of the unessential words in a piece of advertising, but necessary to bind the main lines together.

Cast-step Circular.—Also called a “pull-out” circular. A circular printed on two sides of a long strip of paper, and which is folded over and over. Many time-tables are folded in this manner.

Cedilla.—A mark under the letter *c* when it occurs before *a*, *o*, or *u*, to indicate that it has the sound of *s*, as in façade.

Celtic.—The name of a type face. This is **CELTIC**.

Chapter Heading.—The main head at the beginning of each chapter.

Chase.—An iron or steel frame, in which forms are locked, so that they may be held firmly on the bed of the press. There are many kinds of chases—cylinder, job, spider, McGreal combination, electrotype, etc.

Circumflex.—An accent, *ê*, used to designate the long sound of the vowel.

Clarendon.—The name of a type face. This is **CLARENDON**.

Coated Paper.—When a highly enamelled paper is desired, a web of paper is first made and then coated and calendered. It comes in glossy and dull finish, and is a prerequisite for high-grade halftone work.

“Cock and Hens.”—Individual characters that may be joined together to make braces . By the introduction of dashes the braces can be made of various sizes.

Collotype.—A photo-planographic method of printing. The printing-plate consists of a gelatine film mounted on a heavy plate of glass. The film is made selective of moisture and ink, as in lithography.

Colophon.—Virtually, a trade-mark; formerly placed at the end of a book by the early printers, now usually placed on the title-page.

Color Work.—A term used to cover that part of printing in which the work is done in more than one color.

Complementary Color.—In the analysis of white light, it is found that there are certain combinations, of two hues each, which, when recombined,

produce white light. Either of these hues is complementary to the other. In pigments, no two hues can be combined to produce white; the result is a gray. Green is complementary to red.

Composing-room.—A room where type is set or composed and made up into forms for printing.

Composing-rule.—A compositor does not set one line of type directly on top of another, but uses a composing-rule on which to compose type. It may be of brass or steel, and is usually two points thick. See Figs. 10 and 11.

Composing-stick.—A metal device used by compositors to hold the type while it is being assembled into lines. It has an adjustable knee so that it can be set to different measures. The very latest ones are graduated in ems and half-ems of pica, and are capable of being quickly set to these measures. The composing-stick derived its name from the fact that the first ones were made of wood. See Fig. 8.

Composition.—That part of printing covering all the necessary operations incident to preparing forms for press.

Compositor.—One who composes type or performs any of the various operations incident to preparing forms for press.

Contents.—A résumé of the subject-matter of a book.

Copper.—A reddish metal, sometimes used as an alloy in type-metal to improve its wearing qualities.

Copper Thin Spaces.—Pieces of copper, one-half point thick, cut to labor-saving lengths, usually from six points to forty-eight points.

Copy.—All material furnished to the printer and to be used by him in the production of printed matter is known as "copy." It may consist of manuscript, reprint, illustrations, photographs for reproduction, etc.

Copy-holder.—One who reads copy to a proofreader.

Corner Quads.—Pieces of type metal cast in the form of a right angle, and used around the corners of jobs, the intervening space being filled in with metal of the same thickness.

Cost System.—A modern efficiency method of ascertaining every item of expense connected with the production of a job of printing.

Creasing.—If cardboard or cover stock is so thick that it cannot be folded without breaking, it is necessary to crease it. This is usually done on a printing-press by locking up a piece of rule in the chase and exerting pressure against the tympan, the stock being fed to a guide. All heavy cover stocks that are to be folded against the grain must be creased.

Cut-in Note.—An explanatory note put right into the text to which it belongs, several lines of the text being set to a narrower measure so as to afford room for the note.

Cutter.—One who operates a cutting-machine.

Cutting-machine.—A mechanical device consisting of a bed, a clamp, and a knife, and used for cutting stock to the required size.

Cylinder-bands.—Strips of thin, flat steel, fastened in position near the cylinder and close to the bed of the press. They keep the rear edge of the sheets from falling on the bed of the press.

Cylinder Press.—A printing-press consisting of a cylinder, a flat bed, and an automatic inking device. The type form is locked on the flat bed, and the bed moves back and forth beneath the rotating cylinder, the sheet being held on the cylinder while the impression is being taken. If the cylinder makes but one revolution during a forward and backward motion of the bed, it is called a "drum" cylinder; if it makes two revolutions during a forward and backward motion of the bed, it is called a two-revolution cylinder. In the latter type of machine, while the bed is moving forward the cylinder is raised so that the bed may pass beneath it; when the bed is moving backward the cylinder is down, taking the impression.

Dandy-roll.—A cylindrical roll used on a paper-making machine to produce the watermark and the laid effect which is visible when a sheet of paper is held to the light.

Dashes.—Plain or ornamental pieces of rule used to separate various parts of printed matter.

Dead-line.—A line marked on the bed of a cylinder press as a guide for placing the form. If the type extends beyond the dead-line it will strike the grippers on the cylinder.

Dead Matter.—Type that has been used and which is ready for distribution.

Deckle.—The feathery edge that is incident to the process of making paper. It is left on the printed sheet to give an artistic effect.

Delete.—To expunge; to remove. See "dele," under Proofreaders' Marks.

Descender.—That part of lower-case letters that descends below the body of the letter. The letters g, p, q, and y have descenders.

Diacritical Marks.—Marks used in dictionaries to show the proper pronunciation of the words.

Dieresis.—Two dots (¨) placed over the second of two adjacent vowels to show that they are to be pronounced separately, as in coöperation.

Distributor.—Any mechanical device that distributes type.

Distribution.—Placing type, rules, leads, furniture, and other material in their respective places.

Distributor.—One who distributes type.

Dope.—Nearly every pressman has some pet material which is supposed to be a panacea for all pressroom troubles. This is known as "dope."

Double-led.—Placing two leads between lines in text matter.

Dovetailing.—When doubling-up leads, the arranging of them so that they overlap, or break joints.

Draw-sheet.—The top sheet of a tympan, to which the guides and fenders are attached.

Drier.—A material added to ink to facilitate its drying.

Drying-rack.—A skeleton frame with removable slides. The printed matter is spread out on the slides when printing, and the slides are placed in the frame until the material is dry. See Fig. 143.

Dub.—An inexperienced printer. A mediocre workman.

Dummy.—Unprinted sheets made up into the form in which the finished job is to appear.

Duograph.—Two halftone plates made from one copy and usually printed in black and one tint, or two hues of the same color, the two plates being made with different screen angles.

Duotone.—An ink which, on drying, gives the job the appearance of having been printed in two different colors.

Duotype.—Two halftone plates made from one copy, both from the same negative and etched differently.

Egg-shell Finish.—A finish given to enamelled papers whereby the luster is destroyed.

Electrotype.—A printing-plate made by the deposition of a copper shell in a wax mold. This is backed with lead, trimmed to size, and mounted.

Em.—The square of any body of type. The pica em is the unit of measurement in printing offices. See "en."

Embossing.—Pressing paper or cardboard between a pair of dies so as to leave the design in relief.

En.—One-half of an em. Owing to the similarity in sound of em and en, the en quad is frequently spoken of as the “nut” quad, and the em as the “mutton” quad.

Enamelled.—Said of paper that has been coated and the surface calendered to a high polish.

Envelope Corner.—Advertising matter printed in the upper left-hand corner of an envelope, usually restricted to the name, business, and address of the sender. Useful in case of miscarriage of the letter.

Expanded.—A name given to a type face whose width is slightly wider than a normal one.

Extended.—A name given to a type face of extreme width.

Face.—That part of a type that is inked and which leaves the impression on the printed surface.

Fat.—Said of matter that is full of illustrations, blank lines, or open spaces.

Feeder.—One who feeds a press. Also a name for any piece of mechanism that accomplishes the same thing—that of putting sheets down to a guide or holding them in a definite position.

Feet.—When a type is cast there is a jet adhering to the center of the bottom of the letter. This is broken off, leaving a rough section. A groove is ploughed through the center to remove this rough section, and this leaves the letter with two separate sections, on which it stands. These are called feet. See Fig. 29.

Felt Side of Paper.—All papers are made on fine wire screens, which leave what is known as a wire-mark on one side of the paper. With a view to eliminating this, the paper is squeezed between heavy blankets. This imparts a felt finish to the paper. The wire-mark is never entirely eliminated.

Fenders.—Pieces of cardboard glued to the tympan to prevent a sheet from slipping over the guides.

Fiber.—Part of the cellular structure of plants; used in paper-making to impart strength. The longer the fiber, the stronger the paper.

Flats.—It was formerly the custom with large sheets of paper to count them into quires and fold them in half. Small sizes of paper were not folded, but were delivered flat. In this way paper up to about 17×28 inches became known as flats.

Fly.—A mechanical device with long wooden strips, used on cylinder presses to receive the printed sheet from the cylinder and place it on a pile.

Flyleaf.—The blank page at the front or back of bound books.

Folding-machine.—A mechanical device so constructed that it will fold a sheet of paper, ready to be bound into a book.

Folio.—Originally, a leaf in a book. From the Latin *folium*, a leaf. In the early days books were actually written on the leaves of plants; hence the name leaves. The figure used to designate a page number is also called a folio. The size 17×22 is called folio.

Font.—A complete assortment of any one size and style of type is called a font. Typefounders have a regular fonting scheme, each font containing a prescribed number of each letter or character.

Footnote.—An explanatory note put at the foot of a page, and usually referred to by some specific mark in the text.

Form.—An assemblage of type, quoins, etc., locked up ready for press.

Form-truck.—A two-wheeled device, used for rolling heavy forms from place to place.

Fournier (Pierre Simon).—A native of France, and inventor of the point system.

Fractions.—Fractions are made in three different forms: solid, $\frac{1}{2}$; piece, $\frac{1}{2}$; and adaptable, $\frac{122}{1000}$.

Frame.—A composing-stand, of skeleton form, with slides for holding cases. See Fig. 1.

Frisket.—A sheet of heavy paper stretched across the grippers of a job press and cut out so that only the type can print on the sheet on the tympan. It is used when certain parts of the form mark and spoil the sheet.

Full-point.—The mark of punctuation known as the period is frequently called a "full-point."

Furniture.—Pieces of metal or wood used in making up forms. It comes in widths which are multiples of picas, and in various lengths.

Galley.—Sometimes called a "pan." It may be of wood, but is usually of metal. It consists essentially of a smooth, flat bottom, with raised edges along three sides, the end being left open so that the composed matter may be pushed from the galley to the stone.

Galley-boy.—A boy whose duty it is to look after the galleys of type, pulling proofs, etc.

Galley-press.—A device consisting essentially of a base and a heavy roller running on tracks, and used for proving galleys of type. See Fig. 19.

Galley-rack.—A sectional rack, with inclined slides, for holding galleys of type.

Gauge-pins.—Pieces of sheet metal, stamped into form, and used as guides on the tympan of job presses.

Gauge, Type.—A strip of wood or metal, graduated in type sizes. The gauge usually used by compositors is graduated in pica and half-pica sizes.

Gothic.—A name given to a type face, usually square in outline and devoid of serifs. The so-called text letter is really Gothic in form. This letter is in gothic—H.

Graphic Arts.—A name that embraces every form of printing that has for its object the production of text or illustration.

Grave (˘).—An accent, signifying that the letter is not to be strongly accented.

Great Primer.—A name given to a size of type that was in vogue prior to the adoption of the point system.

Grippers.—The small fingers on a cylinder press that hold the sheet firmly against the cylinder while the impression is being taken. On a job press the grippers are simply flat pieces of steel that press against the sheet and hold it firmly against the tympan.

Gudgeons.—Metal wheels that are slipped over the ends of the roller-stocks on job presses. The gudgeons roll on the tracks and, being keyed to the stocks, cause the rollers to rotate. They should be of the same diameter as the rollers. Adaptable and adjustable gudgeons are made for this purpose.

Guides.—On job presses, either quads glued to the tympan or gauge-pins stuck into it; so placed that the printing comes into proper position on the sheet. On a cylinder press the bottom guides are fastened to a bar, and the side guides to the feedboard. Each guide is set by moving a screw which has a milled head, a set-screw holding it firmly after it has been properly adjusted.

Hair-line.—The very fine lines of any type face are known as hair-lines. The term "minor element" has been suggested as a more appropriate one.

Half-title.—The name or title of a book, placed at the head of the first chapter, or printed in one line on a full page.

Halftone.—A photoengraved plate consisting of dots of varying sizes, but uniformly placed, and capable of rendering not only the high-lights and shadows of a picture, but all the half or intermediate tones.

Hell-box.—A box into which all manner of bent, battered, or useless printing material is thrown. There should be separate boxes for type, leads, and brass rule.

Imposing-stone.—A framework surmounted by a smooth, level slab of marble or steel, on which forms are imposed.

Imposition.—The placing of pages in a form so that they will print in proper position on the sheet.

Imprint.—The name and address of a firm. A name put on printed matter to show who did the printing.

Indention.—When one line stands in farther than another it is said to be indented. Paragraphs are usually indented. If the first line begins flush, and the subsequent lines are held in a little, the indention is called a *hanging indention*.

Index.—A compilation of the most essential things contained in a book, and arranged alphabetically for quick reference.

Initials.—Large letters used at the beginning of the main sections of a book or other printed matter.

Ink.—A combination of pigment, varnish; drier, etc. Made in many forms, colors, and consistencies, to suit the varied requirements of the printer.

Ink-balls.—Formerly used for inking forms. They were made of leather stuffed with cotton. Since the advent of rollers they are no longer used. A picture of two ink-balls, face to face, is frequently used as a symbolic sign by printers.

Ink-knife.—A thin, flexible steel knife, used for mixing inks.

Inserts.—Pieces of printed matter produced separately from the main body of a book or magazine, and inserted in proper position before binding.

Intaglio.—Any engraved surface where the design is cut *in* the metal, and which is filled with ink, the surface being cleaned, so that the ink in the design may be transferred to paper.

Ionic.—A name given to a type face. This is a specimen of Ionic type—**H**.

Italic.—A sloping type face, named in honor of Italy.

Italic Quads.—Among the uninitiated, the sending of an apprentice for italic quads is supposed to be a joke. The American Type Founders Company, however, did make a font of Gothic Italic in which every letter

sloped, and which required italic quads. The italic matrices used on the Ludlow Typograph also slope in this manner.

Jeff.—To throw em quads in the same manner as dice. The one throwing the greatest number of quads with the nick up winning the throw.

Jet.—A small projection on the bottom of each piece of type as it comes from the mold. The jet is broken off and the roughness removed with a plane, thus leaving the letter with two feet.

Job Press.—Any printing-press used for printing jobs. Formerly restricted to platen presses. Since the introduction of curved electrotype plates, small job cylinder presses have appeared on the market.

Journeyman.—A full-fledged workman. A few centuries ago this title was given to a workman who journeyed from place to place in order to acquire a full knowledge of his trade.

Justification.—Making a line fit a given measure. When using two sizes of material together, justifying is the placing of enough material with the smaller to make it equal the larger.

Kern.—That part of the face of a letter which overhangs the body. The letters f and j are usually kerned. Because of the kern on the f it is necessary to have the ligatures fi, ff, fl, ffi, and ffl. Many italic letters are kerned.

Keyboard.—An assemblage of keys, systematically arranged, each of which controls some mechanism so arranged that a matrix may be assembled (as in the Linotype and Intertype) or a letter cast (as in the Monotype).

Key-plate.—Any plate that is used as a guide to get other plates into register. In the three-color process the blue plate is used; in the four-color process the black plate is used.

Laid Paper.—Any paper which, when held to the light, shows close, parallel lines, some of them frequently running at right angles. The laid effect is a watermark, and is due to the pressure of the dandy-roll on the soft paper-pulp.

Layout.—Practically, a working diagram of a job. Usually marked to show the general grouping of a job, and also specifying the sizes and kinds of type to be used.

Layout Man.—Sometimes called a "typotect." Practically a typographical architect. One whose duty it is to prepare layouts.

Lead.—One of the elements of the earth. The basic metal in an alloy used as type-metal. The proportion of lead in type-metal varies with the size of type to be cast.

Lead-cutter.—A device for cutting strips of lead to required size. See Fig. 120.

Leaded Matter.—Type matter with leads between the lines.

Leaders.—Leaders are periods or dots cast to different multiples of the body size. They are used in tables to lead the eye from one point to another. Open leaders run one dot to the em, and are cast on one-, two- and three-em units. Close leaders are cast on en, em, and two- and three-em units, and are sometimes used as a substitute for dotted rule.

Leading.—Placing the required number of leads in a piece of composition.

Lead-rack.—A partitioned receptacle for the accommodation of stock sizes of leads.

Leads.—Strips of metal, made to multiples of points, and used in spacing lines of type.

Leaf.—Each separate sheet of paper in a book. Some of the early books were made by scratching on leaves with a stylus; hence the word "leaf."

Letter-board.—A flat board, usually with strips of wood around three edges, used as a place of storage for composed type.

Letterhead.—The printed form at the head of sheets of letter paper; also the sheet itself after it is printed.

Letterpress.—The adjective; denoting printing that is done from raised surfaces.

Letter-press.—The noun; denoting an office device for copying letters.

Letter-spacing.—Putting thin spaces between letters in a word in order to increase the length of the word, or to make uniform the apparent white space between the letters.

Ligature.—Two characters joined together on one body, as fi, ff, &, &, etc. Erroneously called logotypes.

Light-face.—A name sometimes given to a type face whose major and minor elements are very narrow, and therefore light in character.

Line-engraving.—A photoengraving whose various parts are represented in lines, and not broken up into half tones.

Linotype.—A composing-machine. After the operator assembles a line of matrices, the machine automatically casts a "line-o'-type," or slug, and then distributes the matrices into a magazine, ready for use.

Lithography.—A planographic method of printing. Originally, it simply meant printing from stone, but at the present time it also covers printing from grained zinc or aluminum plates. The process is based on the antagonism of grease and water. The design on the stone is made receptive of greasy ink. The stone absorbs water and resists the ink. By successively moistening and inking the stone, impressions can be obtained on paper. Thin sheets of zinc or aluminum are used in the "offset" process of printing.

Live Matter.—Type matter that is not ready for distribution.

Lock-up.—Locking up forms for press.

Logotype.—A combination of letters joined together on one body. Ligature is the proper name, though most printers call them logotypes. See "Ligature."

Long Primer.—Name of a size of type in use before the adoption of the point system. Ten-point is the size nearest to what was long primer.

Lower Case.—The lower of a pair of type cases; the one in which the small letters are kept. Also, one of the small letters. When designating a lower-case letter on a proof the contraction "l.c." is written.

Machine Finish.—Usually, a dull finish, left on paper as it comes from the paper-making machine.

Magazine.—That part of a composing-machine in which the letters or matrices are stored, ready to be assembled into lines.

Majuscule.—A letter used as a capital letter during the period when books were written. See "Minuscule."

Make-ready.—The process of getting a job ready to print. It consists of pulling an impression, spotting up, setting guides, etc. The name is also given to the sheet containing the spot-up.

Make-ready Knife.—A knife specially shaped and ground, and used for cutting the pieces of paper used in spotting up a make-ready.

Make-up.—A compositor whose duty it is to make up composed type into pages.

Make-up Rule.—Sometimes called a "humpback" rule, because it has a hump in the back which can be readily grasped when it is desired to push the type along. It is used by newspaper men in making up pages.

Mallet.—A wooden head mounted on a handle. Used in conjunction with an uncovered planer to plane forms or with a proof-planer to beat off proofs.

Margin.—The amount of space around the printed matter on a page.

Marginal Note.—Explanatory matter placed in the margin of a page, usually beside the matter to which it refers.

Mass.—Spoken of in relation to groups or patches of type matter on a page.

Matrix.—That part of a mold in which the face of type is cast.

Measure.—The length to which a stick is set.

Melting-pot.—That part of a casting-machine in which the metal is melted.

Minion.—A name of a type size in use before the advent of the point system. Seven-point is the size nearest to what was minion.

Miniscule.—One of the small letters developed during the period when books were written.

Mitering-machine.—A mechanical device for obtaining straight, smooth ends on leads, slugs, rule, etc., so arranged that it will miter to any angle.

Modern.—A name given to a type face that is characterized by straight serifs and thin hair-lines. First cut by Bodoni in 1783.

Mold.—That part of a casting-machine in which the body of the type is cast.

Monotone.—All in one tone. A name given to a type face in which the various elements are all of equal width.

Monotype.—Literally, one type or letter; specifically, a composing-machine that casts and composes individual type units into pages, ready for printing.

Mortice.—The noun. Any cavity cut out so that something may be inserted in it.

Mortise.—The verb. To make a cavity so that something may be inserted in it.

Nick.—A depression left in one side of the body of a type during the process of casting. So that the letters will be in the proper order for printing, type is set in the stick with the nick up.

Nippers.—The grippers on a cylinder press are sometimes called nippers. See "Grippers."

Numerals.—The Arabic numerals are 1, 2, 3, 4, 5, etc.; the Roman numerals are I, II, III, IV, V, etc.

Offcut.—Short sections of paper stock left over after the original stock has been cut down to the size required for a job.

Off Its Feet.—Said of type when it is not standing perfectly upright.

Offset.—A smudge resulting from carrying so much ink on a sheet that some of it adheres to the bottom of the sheet above it.

Offset Printing.—A planographic process, wherein the ink from the form is first offset on a rubber blanket instead of being transferred directly to the sheet.

Old-style.—A type face, characterized by oblique serifs.

Optical Center.—That point on a printed page which the eye seems naturally to seek as the center. It is slightly above the actual center of the page; being, approximately, three-eighths of the distance from the top.

Ornament.—Any rule, border, or conventional device used as an embellishment.

Overhang.—Anything that projects beyond the main body of the type or slug.

Overlay.—When preparing a form of type or plates for printing it is necessary to put more impression on some parts than on others. A proof is pulled and the sheet spotted up. If this sheet is put on the tympan or cylinder, it is called an overlay; if it is put under or back of the form, it is called an underlay.

Overrunning.—Carrying over words from the end of one line to the beginning of the next. Frequently done to avoid a series of divisions or to obviate bad make-up.

Page.—One side of a leaf of a book.

Paging.—Making type matter into pages of uniform length.

Palette-knife.—A thin, flat, flexible steel knife, used for mixing inks.

Panel.—An auxiliary part of a piece of type composition that has been separated from the main body by being enclosed with a border.

Parchment.—The dried skin of animals. Vegetable parchment is made by treating paper to a bath in heated sulphuric acid for a specified time.

Pearl.—A name for a type size. Under the point system, pearl became five-point.

Perforating.—Punching small holes or slits in a piece of paper so that it will tear easily at some desired place.

Perforating-rule.—A piece of steel or brass rule, usually put into a type form, so that the job may be printed and perforated at the same time.

Photoengraving.—Any engraving process in which photography plays an important part.

Photogravure.—An intaglio printing process. By the aid of photography holes of different sizes and depths are etched in the outside surface of a copper cylinder. To break up the photographic image so that it will produce holes, it is necessary either to make the negative through a screen or lay a grain on the cylinder that will resist the action of the etching-fluid. This keeps the surface of the cylinder level. The cylinder rotates in a fountain of ink, the surplus being scraped from the surface by a "doctor," leaving the ink only in the holes. The shadows of the pictures have deep holes which give up a lot of ink, while the high-lights have shallow holes and give but very little ink.

Photomechanical.—Said of a process in which photography is an aid or an auxiliary to some mechanical process.

Pi.—Type matter that has fallen apart and its various elements badly mixed.

Pica.—The name of a type size. Under the point system pica became twelve-point. The name pica is still used. It is the unit of length for leads, slugs, rules, furniture, etc.

Picking (of Paper).—Printers frequently have trouble with enamelled or coated papers, due to the fact that the ink is so tacky that it pulls the coating from the face of the paper.

Picking "Sorts."—When a compositor is setting a job and he finds that certain needed letters are missing from the case, he is sometimes compelled to go around the office picking "sorts" from other jobs in order to set his own.

Piece-fraction—A fraction that has been made up of more than one piece. The most-used fractions, like $\frac{1}{4}$, $\frac{1}{2}$, $\frac{3}{4}$, etc., are made in one piece; but unusual fractions, like $\frac{12}{1000}$ or $\frac{129}{600}$, are built up of pieces, called piece-fractions.

Piece-hand.—A workman who is paid at a specified rate for the work that he does. He is not paid by the week. His earnings depend entirely on the volume of work that he produces.

Piece-work.—In composition, piece-work is that which is paid for at so much per thousand ems.

Pigment.—Any solid substance that is added to printing-ink to give it body and color.

Planer.—A block of hard wood, one face of which is level and smooth. Used on the face of type forms to push down all the letters and make the form plane or level. The face of a proof-planer is covered with felt.

Planographic.—Any printing process where the ink is taken from a plane surface. All such processes are based on the antagonism of grease and water. (See Lithography.)

Plate.—Any metal surface so prepared that after being inked it is capable of yielding impressions.

Platen.—That part of a job printing-press on which the make-ready, tympan, and guides are placed, and on which the sheet takes the impression from the type.

Point.—The unit of the point system. It is one-twelfth of the American pica, and measures .01384 inch thick. Type sizes are now based on this unit.

Point-line.—When the face of type is placed in such position on the body that various sizes may be justified by using material that is some multiple of the point, it is said to be on point-line.

Point-set.—Said of a font of type whose characters are all cast on body widths that are some multiple of the point.

Point System.—A system of casting type bodies on some multiple of a unit called a point. One point is .01384 inch.

Poster.—A printed sheet used for outdoor display advertising, usually pasted on billboards and fences. A one-sheet poster is a single sheet 28×42 inches in size; a two-sheet poster is made by using two sheets, one-half of the design being on each sheet. Very large posters are made up of a combination of single sheets, each containing a portion of the design.

Poster-stick.—A large, wooden composing-stick, used when setting type for posters.

Pressman.—One whose duty it is to prepare forms for printing. This he does by making ready the form, and by making proper adjustments of the various parts of the press.

Pressroom.—A room where printing is done. The ideal pressroom is one that is so arranged that temperature and humidity may be controlled; perfect control being essential to uniform results.

Printing-press.—Any piece of mechanism from which a succession of reproductions may be obtained by first inking an original and then transferring the ink to paper or other material by the application of pressure.

Process Work.—Work obtained by printing from plates prepared by the photoengraving process. A halftone process whereby varicolored pictures may be obtained by the use of three- or four-color plates as originals.

Proof.—Any printed impression of a job that has been made for the purpose of inspection and correction.

Proof-paper.—Any paper used for pulling proofs. Dry proof-paper is specially made for the purpose, one side of it being highly glazed.

Proof-planer.—A block of wood, one face of which is perfectly plane and covered with a layer of felt.

Proof-press.—Any piece of mechanism made especially for pulling proofs.

Proofreader.—One whose duty it is to read proofs and mark the errors.

Pull-out.—Anything pulled out from the form by the suction of the rollers.

Pull-out Folder.—A printed circular whose pages have been folded over and over. The pages pull out when opening the folder. Also called "cat-step" folder.

Pulp.—Wood or other vegetable fiber from which paper is made.

Punctuation.—The separation of words into clauses and sentences by the use of marks, each of which has a definite use.

Quads.—Blocks of type metal, cast to point sizes of body, and in multiples of the square of the body. A one-em quad is just as wide as it is thick; a two-em quad is twice as wide as it is thick; a three-em quad is three times as wide as it is thick. Em quads of various sizes are illustrated on page 6.

Quoin.—A mechanical device so constructed that it may be expanded, thereby exerting pressure. Used by printers to lock up forms. See Fig. 95.

Quoin-key.—A device for tightening quoins.

Quotation.—Matter written by one author and made use of by another, the latter giving full credit to the former.

Quotation Furniture.—Metal furniture that has been cast in type molds. The body of the furniture has a smooth top, but it is hollow beneath, the walls being sustained by cross-ribs. It is cast in lengths from four to twenty picas, varying by four picas.

Quotation Marks (" ").—A set of marks used to enclose quotations, thus indicating that the words so enclosed were written by someone other than the author.

Railroad Furniture.—Metal furniture whose two side walls are joined through the center with a sustaining web.

Railroading.—A term used to describe the marking-over of words at the ends of successive lines.

Reducer.—A substance put into printing-ink to reduce its consistency.

Register.—To get the various parts of different forms into such position that when they are all printed on a sheet each printing will be in its proper place.

Reglet.—When wooden furniture is cut into strips thinner than two picas, it is called reglet. The most familiar thicknesses are six and twelve points.

Reprint.—To print again. After a job has been printed once, each subsequent printing is a reprint.

Reproductive Processes.—Any process of printing whereby a number of impressions may be taken from a prepared surface, the surface being inked each time before the impression is taken.

Revise.—To compare a marked proof with a proof of a corrected job. After the proof is revised it is known as the *first revise*. If the corrections are not all made, and a second proof is necessary, that one is known as the *second revise*; and so on.

Riding.—When any part of a form works up on press, it is said to be riding.

Roller Composition.—A combination of glue, glycerine, molasses, etc., melted and cast in molds around a central core or roller-stock. Each manufacturer has his own secret formula. The amount of each ingredient varies with the season of the year, a softer roller being required for winter than for summer use.

Roman.—The word “roman” when used in connection with type faces means that the vertical elements are upright, and not inclined, as are the same elements in the italic form.

Routing.—Cutting away that part of any printing-block which is not needed, and which would likely mark the sheet.

Rules.—Strips of brass or lead, type high, one long edge of which has been prepared as a printing surface.

Runic.—A name of a type face.

Running Head.—Head-lines used at the top of each page throughout a pamphlet or book.

Scoring.—Making a crease in heavy paper stock, so that it may be folded without breaking.

Script.—A type face in imitation of handwriting.

Serif.—A small projection at the ends of letters. See Fig. 29.

Setwise.—A term used to differentiate the width of a letter from its body size. Body size is bodywise; width is setwise.

Sheetwise.—When a sheet has been printed on one side from one form and then backed up with another form, it is said to have been printed sheetwise.

Shooting-stick.—A piece of iron or wood so shaped on one end that when placed against one edge of a wooden quoin and struck with a mallet the quoin will be driven against its mate and the form locked up. Mechanical quoins have almost supplanted wooden quoins for locking up forms.

Side-head.—A subhead placed at the top of the text but at the side instead of the center.

Side-stick.—A long, tapering, wedge-shaped piece of wooden furniture, used alongside of type in forms and galleys, and locked in place with wooden quoins.

Signature.—Small Arabic numerals printed on the first page of each form of pages throughout a book, and numbered consecutively to show in what order the sections are to be assembled. Each section is also called a signature.

Sinkage.—Blank space placed at the beginning of a chapter in a book.

Size.—When a job is to be bronzed it is first printed with size, which is a sticky compound used like printers' ink, and to which the bronze powder adheres.

Sized and Supercalendered.—Paper is said to be sized and supercalendered when the sizing is put into the beater with all the other ingredients used in making the paper, and afterward steamed and calendered.

Skeletonizing.—Taking a job apart and rebuilding it so that its various parts may be printed in different colors.

Slip-sheeting.—Placing pieces of heavy, rough paper between printed sheets so that the printing on one sheet will not offset on another.

Slitting.—Cutting slits in sheets by the aid of steel cutting-rule. Also cutting sheets apart as they emerge from the printing-press, by the use of cutting-wheels.

Slugs.—Pieces of lead, about $\frac{1}{4}$ -inch high, usually six or twelve points thick, used as spacing material between lines of type. The bar of metal with the type cast on it by the Linotype or Intertype is called a slug.

Small Caps.—Capital letters, usually made for book fonts, but of a smaller size than the regular capitals. They are generally made about the same height of face as a lower-case m.

Small Pica.—The name of a type size under the old system. On the point system small pica became eleven-point.

Solid Matter.—Type matter that has been set without using leads between the lines.

Sorts.—Type of various sizes and kinds held in reserve for replenishing cases.

Space-band.—A thin, compound wedge, made of steel, and used on the Linotype and Intertype for justifying the line of composed matrices.

Space-case.—A case specially arranged for the accommodation of quads and spaces of various sizes.

Spacing.—Putting the proper amount of material between words, lines, or groups.

Spotting-up.—Marking out and putting on patches on a make-ready sheet.

Stereotype.—A plate cast in type metal from a plaster-of-Paris or papier-maché matrix.

Stet.—A term used in proofreading. When written on a proof, stet means, "do not remove the part marked out; let it stand."

Stick.—A composing-stick is usually referred to as a "stick."

Sticker.—Advertising matter printed on gummed paper.

Stone-hand.—A workman whose sole duties consist of imposing and locking up forms.

Stonework.—Imposing and locking up forms.

Straightedge.—A long, flat, straight piece of steel, useful in lining up pages in a form.

Straight Matter.—Type composition that does not contain display lines.

Supercalendered.—See "Sized and supercalendered."

Swash Letters.—Letters that have ornamental prolongations or embellishments. (See page 82.)

Tack.—Adhesiveness possessed by a printing-ink, due to the use of a stiff varnish.

Tail-piece.—An ornamental design used at the conclusion of a chapter or a piece of printing.

Take.—When copy is cut up into sections and given to compositors to be put into type, each section of copy is known as a take.

Text.—The straight body matter of a book is known as the text.

Text Letter.—Text letter is the name given to a type face whose general characteristics are bold, heavy, body strokes with sharp, thin, elongated serifs. Historically speaking, it should have been called Gothic. This word is set in **Text**.

Tie-up Material.—A general term, embracing everything used in the tying-up of composed type—string, leads, slugs, corner braces, etc.

Tilde (˜).—Placed over the letter n to show that it has the sound of ny, as in cañon.

Tin.—A metallic element, used in type-metal to make it tough and increase its resistance to wear.

Title.—A name given to a type face possessing modern characteristics.

Title-page.—Usually the first page of a book, and containing the title of the book, author's and publisher's names, etc.

Tumbled.—When a printed sheet is backed up by turning it from top to bottom instead of from right to left, it is said to be tumbled. This should be avoided, if possible.

Turned Letter.—A letter put in upside down to call attention to the fact that another letter has been substituted for the right one. This is usually done when the right letter is not available.

Tympan.—The sheets of paper drawn tightly across the platen and held in place by the tympan-bales. Sometimes called the packing.

Tympan-bales.—Bands of metal bent to conform to the shape of the top and bottom edges of the platen, and hinged to the sides of it. They are used to clamp the tympan to the platen.

Type-caster.—A machine for casting type.

Type-gauge.—A strip of wood or metal, graduated in type sizes, and used for measuring the number of lines contained in a piece of matter.

Type-metal.—An alloy, ordinarily composed of five parts of lead, two parts of antimony, and one part of tin.

Type-high.—In America, .918 inch high. It varies in other countries from .916 to .923 inch high.

Typography.—The art of printing from type. More particularly, type setting, or the proper assembling and grouping of type units in a piece of type composition.

Typotect.—A typographical architect. One who plans a job and designates just how it is to be put together.

Underlay.—A spot-up sheet placed beneath a plate or type page in an endeavor to make it level on the face.

Unit.—A standard quantity or number by which other things are gauged.

The Monotype Unit is $1/18$ of the set em of the body.

The Point is the unit of the point system. It is $1/12$ of the American pica.

The unit for paper is the weight of one ream of paper one inch square, expressed in thousandths of a pound.

Varnish.—The vehicle or medium used in printing-ink to bind the pigment together.

Vellum.—Name given to a paper, the finish of which is similar to the finish on real vellum, which is a dressed animal skin from which the hair has been removed.

Vignette.—A halftone plate whose edges gradually fade away until they become lost on the white surface of the paper.

Wash-up.—The act of washing up a press.

Watermark.—A mark left in paper during its manufacture, and which is distinctly seen when the paper is held to the light.

Wax-engraving.—A method of obtaining printing-plates by first engraving on a wax-coated plate of copper, then building up the background and making an electrotype from the plate.

Woodcut.—A printing-plate of wood, on which an image has been left in relief by cutting away the background.

Wood-engraving.—That branch of the art of preparing printing-plates in which the plate is of hard wood. It is really the precursor of all printing processes.

Wood Type.—Type characters cut out on the end grain of wood, usually cherry, and mostly of large size. Smaller sizes of type are usually of metal and cast in molds.

Work and Turn.—Printing a full form on one side of a sheet and then turning it over and working the same form on the other side.

Wove Paper.—Paper that is free from the watermark lines which characterize a laid paper.

Wrong Font.—Any letter in printed matter which is not of the same size or face as the balance of the word in which it is found.

Zinc-engraving.—A printing-plate made of zinc, the background of which has been etched away, leaving the design in relief.

INDEX

The numbers given are page numbers, not section numbers.

For additional list, see Glossary, pages 281-305.

A

Abbreviated titles, 70
Abbreviation for pounds, 70
Abbreviations, 57
Ability required to set tables and other intricate matter, 141
to analyze and plan work, 84
Absorptive power of paper, 253
Accidents on cylinder presses, 248
Accurate and uniform spacing, 16
Adapting ink to stock, 254
Adhering to one type family, 87
Adjustable gudgeons, 168
Adjusting platen by aid of the impression-screws, 223
Adoption of the point system, 5
Adverbs qualifying adjectives, 66
Advertising, 87
campaigns, 87
Aid to type study, pi as an, 81
Alabastine, use of, for embossing, 242
Algebra, genealogies, and pedigrees, 161
Aligning rule with type, 105
Allowance, for spoilage, 279
for squeeze, 112, 170
for squeeze in tables, 146
of distance between lines when setting tables, 144
of white space around cuts, 156
Allowing for movement, in blank-book headings, 154
of register jobs, 168
Altering an author's style of writing, 50
Always hold stick in hand while spacing lines, 30
A.M. and P. M., 71
Ambiguity resulting from omission of comma, 53
American Lead- and Rule-cutter, 199
Amount of impression, 226
of space around an initial, 99, 100
of space between words with sloping letters, 17
of space between words with tall, straight letters, 17
of water necessary to the production of a pound of paper, 270
Ampersand, 71
origin of, 71
use of, 71
Analysis of copy for letterhead, 116
Analyzing a job with a view to improving it, 102
Ancient Roman stamps and coins, 74
Antiques, 79
Apostrophe, uses of 59

Appropriateness, 85, 90
Approximation of material by measuring it in inches, 7
Arrangement of type in cap case, 1
in lower case, 1
Arranging and assembling display type, 84
Arranging the tympan, 228
Artistic temperament, opportunities for men of, 84
Ascenders of Cheltenham, 80
Assembling and arranging display type, 84
Assembling device, Linotype, 210
Author's plan for making paper according to a unit, 278
Auto-Mat Tabulator, 211
Averaging the number of words in a line, 36

B

Back, 181
Bad typography to mix old-style and modern type, 79
Badly battered letter, patching a, 230
Balance, 85
Balancing of type groups, 85
Barber Low Slug Trimmer, 199
Bars, shifting, 183
Bastard lengths, alongside of initials, 113
of leads and slugs, 35
Bastard measure, cutting leads to, 114
Battering rule with bodkin, 172
Bearers, 167
do not bear off form-rollers, 167
roller-, 224
Beater, the, 264
Bed of platen press, 221
Bending leads and slugs into circular form, 159
Benton, L. B., 80
Benzine for cleaning rollers, 246
for cleaning type, 246
Bewick Roman, 79
Black ink on white paper, 90
Black-ink troubles, how to overcome, 255
Black-letter, 73
Blank-book headings, 153
Block letter, 73
Bodkin, battering rule with, 172
Bodoni, designer of modern type face, 77
quotation marks, 60
Bonds, 273
Book forms, proofs of, 26
Book papers, 271
Booklet cover, 127
Border units, how to make up, 113
cleaning of, 32

- Borders and ornaments, 98
 Bowing a sheet, 234
 Brackets, uses of, 62
 Brass rule, 104
 Brayer, or hand-roller, 23
 Break-line at top of page, 30
 Brewster theory of color, 259
 Bulk of straight matter set on machines, 50
 Bullen, Henry Lewis, 78
 contribution to the study of type faces, 78
 subdivision of type faces, 79
 Burr on rule, 202, 203
 Business card, 126
 Butted rule, 107
- C
- Cabinets, dustproof, 1
 Calculating typewritten copy, 36
 Calculations for Monotype matter, 37
 Calendar, 271
 Calendering-machine, 271
 California Job Case, 1
 Capital E's and T's, 79
 Capital R's of various type faces, 81
 Capitalization, 67
 Cancelled figures, 182
 Carbon tetrachloride, 247
 Care of cutting-tools, 206, 207
 Case, lay of, 1
 Cases in pairs, 1
 Casting-machine, Monotype 212
 Casting off a table, 147
 in columns, 143
 type, gauge for, 30
 type into pages, 30
 Casting sorts on composing-machines, 217, 218
 Cause of loss of time when locking up jobs, 30
 Chalk-mark as a guide for registering, 169
 Chamfered or side-face rule, 106
 Chandler & Price Gordon Press, 221
 Changing dimensions to points, 37
 Characters used in Monotype rule work, 147
 Chase, 182, 194
 McGreal combination, 194
 top of, 183
 Chase-bars, loose, 184
 Cheltenham, 79
 lacking old-style characteristics, 79
 Chemical wood-pulp, 264
 Circle, determining the exact distance
 around, 159, 160
 bending leads and slugs to fit, 159
 placing a line around, 159, 160
 setting type in, 158
 Clam-shell type of platen press, 221
 Cleaning border units, 32
 rules, 32
 stone before pulling proof, 23
 type, 32
 type with lye, 247
 Clearface, 80
 Closing envelopes, 240
 while withdrawing from press, 241
 Coated papers, 271
 Collating, 193
 Collating-marks, 193
 Colon, and dash used together, 55
 and quotation marks used together, 57
 uses of, 56, 57
 "Color and Its Application to Printing," 257
 Color-mixing, 257
 "Color Notation," 257
 Colored ink on colored paper, 90
 Colton, W. R., on proportions, 96
 Columns, casting off in, 143
 Comma, uses of, 51-54
 Commas and periods inside of quotation marks, 59
 Comparison of old-style and modern serifs, 78, 79
 of serifs, 81
 of type faces, 82
 Complex sentences, 56
 Composing-machines, 209
 economy of, 209
 Composing-room material cut to standard lengths, 7
 Composing-rules, 15
 in sets, 15
 made from brass rule, 15
 Composing-sticks, 13
 Composition of printing-ink, 252
 Composition rollers, 224
 running down of, 224
 Compositor, skill required, 84
 Compound, adjectives, 65
 nouns, 65
 nouns of one or more syllables, 66
 sentences, 56
 word, omission of part of, 67
 words set in capitals, 55
 words without the hyphen, 66
 Condensed type, use of, 101
 Consideration of stock and ink when plan-
 ning job, 90
 Consistency of varnish, 253
 Constant, or multiplying factor, 98
 Contractions, 57, 59
 Contrast, 85, 87, 90
 Copper or zinc instead of pressboard, 226
 Copy prepared by proofreader before setting,
 50
 Cord, saving for future use, 30
 Cork on grippers, 224
 Cork to eject stock from cutouts, 245
 Corners, gaping, how to fix, 172
 mitered, 107
 troublesome, 170
 Corrected proof, 49
 Correcting a job, 29
 on stone, 29
 Counter, embossing-, 242
 Cover for an invitation, 134
 Covering power of ink, 255
 Crowded matter, 90
 Curved line, holding in position, 161
 use of gummed paper for holding in
 position, 159, 160
 Cut, 181
 Cutout for envelope, 238, 239
 for tally-card, 160
 Cuts, running type around, 155
 type matter against, 156
 Cutting and figuring stock, 279
 and slitting, 244
 circle in old electrotype block, 161
 leads, slugs, rule, etc., in bulk, 197
 leads to bastard measure, 114
 leads to odd measures, 199
 Linotype slugs, 198, 199
 paper in more than one direction, 279
 pattern for running type around cut, 156

- Cutting, printing, scoring, and perforating at one operation, 245
 steel rule, 198
 to multiples of a point on a mitering-machine, 204
 very small pieces of rule, 205
 Cutting-rule, mounted in old electrotype block, 245
 steel, 244
 Cutting-tools, care of, 206, 207
 for printers, 197
 Cylinder presses, accidents on, 248
- D
- Dandy-roll, 270
 Danger of type pulling out on press, 16
 Dash and colon used together, 55
 Dash as frequently used by advertising men, 55
 Dash, uses of, 54-56
 Dead-line, 183
 Dead-oil, 247
 Deckle, 266
 edge, 266
 Dele mark, 45
 Deleterious effect of electrotypes on red ink, 111
 of ink on rollers, 224
 Della Robbia, 79
 Designating an order-blank which way type is to be set, 116
 Designating paper according to a substance number, 276
 Determining amount of space to fill line, 17
 amount of leads to page, 41
 exact distance around circle, 159, 160
 how many lines of any size type may be gotten into a given space, 38
 how much matter a certain piece of copy will make, 36
 lay of a form, 178
 margins, 177
 margins for pages of equal size, 177
 margins for pages of unequal size, 177
 number of ems in composed matter, 38
 number of inches of matter copy will make, 37
 value of composed type, 39
 weight of type by measurement, 41
 Devices, safety, 247
 Diagonal method of proportions, 94
 Diagrams showing inside and outside pages coming together, 182
 Die, embossing-, 242
 Difference in modern and old-style faces, 76
 Differentiating the comma from the apostrophe, 47
 Digester, 264
 Dirty type, 14
 Discordant elements, 87
 Dishing of rule, 199
 Disk, talking-machine, use of, for embossing-counter, 243
 Display type, 79
 arrangement of, 84
 Distributing display type, 34
 Distributing-bar, Linotype, 211
 Distribution, 33
 Diversity of opinion regarding amount of impression, 226
 division of words, 63
- Diversity of opinion regarding punctuation, 50
 use of hyphens in compound words, 65
 Dividing a word, 16
 according to pronunciation, 65
 of compound words, 64
 of verbs in the past tense, 64
 of words, 63-65
 Dollar mark, when and how to use, 71
 Dominating feature of a letter, 78
 Do not sacrifice the appearance of spacing, 18
 Dopes, 256
 Double quotations, 59, 60
 Doubling-up leads, 11
 rule, 106
 Dragging of proof-paper over form, 23
 Draw-sheet, 223
 V-shaped slit in, 233
 Drawing lines from errors to corrections on proof, 47
 Drier for printing-ink, 253
 Driers, paste and liquid, 253
 Dropping or throwing type into cases, 35
 Dry proof as a guide for skeletonizing, 110
 Dry proof paper, 23
 Drying of printing-ink, 253
 the sheets, 236
 Drying-racks, use of, 237
 Dummy, making a, to get lay of form, 179
 Duotone inks, 257
 Dustproof cabinets, 1
- E
- Each author has his own style of writing, 45
 Early types of composing-machines, 209
 Ecclesiastical purposes, type for, 91
 Economy of composing-machines, 209
 Edge, deckle, 266
Editions de Luxe, 90
 Eight, lay of the, 187, 188
 Eight-point figures self-justifying to pica widths, 9
 three-point spaces of, 150
 type self-spacing to pica measures, 150
 Electrotype block, cut to shape for making cutouts, 245
 cutting circle in, 161
 Electrotype plate, inserting cut in, 157
 Electrotyped job, use of rule in, 107
 Electrotypes, deleterious effect on red ink, 111
 to be nickel-plated, 111
 Electrotyping job for two colors, no need to skeletonize, 111
 when printing more than one at a time, 141
 Elements, discordant, 87
 of success in a job, 102
 that give distinctive characteristics to type, 82
 Em of the body, the, 6
 Em, pica, 6
 Embossing, 242
 counter, 242
 die, 242
 explanation of term, 242
 Emptying a stick, 18
 En quad, 7
 Enamelled paper for halftones, 254
 inability to get register on, 254
 Enamelled papers, 271

Encasing of gear-wheels on printing-presses, 247
 Envelope corners, 124, 128, 129
 locking up, 165
 Envelope, cutout for, 237, 239
 cutout, placing in position, 239
 sizes, 278
 Envelopes, 237
 closing; 240
 closing while withdrawing from press, 241
 opening and closing, 240
 Equal space each side of small words, 18
 Exclamation mark, origin of, 61
 uses of, 61
 Expansion of paper, 254
 Experiments to ascertain legibility, 80

F

Face-rule, how to use, 104
 Fanning a pile of paper, 234
 Fascination about typesetting, 84
 Feeding a press, 234
 Fenders, 223, 234
 Fiber used in paper, 262
 Figures, cancelled, 182
 line-up of, 151
 Figuring and cutting stock, 279
 File, mitering with, 206
 Filigree work on initial, 101
 First step in setting a ruled blank, 143
 Fish glue, use of, for embossing, 243
 Fitting letters, 103
 Five-em space, 7
 Flat papers, 273
 Flying a sheet, 234, 235
 Fold, 181
 Folding, by machine, 193
 hand- and machine-, 177
 heavy paper, 194
 of sheet to obtain hypotenuse oblong, 97
 proofs into book form, 26
 Folios, 32, 181
 enclosed in brackets, 62
 to go into margins, 185
 Forms, containing rules, locking up, 165
 imposing, 182
 inserting, in press, 227
 lay of, determining the, 178
 locked up head down, 165
 locked up head to the left, 165
 locking up, 163
 making a dummy to get lay of, 179
 planing a, 166
 riding of, 172, 173, 184
 springiness or "give" in, 167
 squaring, 172
 testing, 167
 various parts of, 181
 work-and-turn, 176, 181
 Form-planer, 23
 Form-rollers not borne off by bearers, 167
 Four, lay of, 187, 188
 Four-em space, 7
 Four-em wooden furniture, groove on, 172
 not square, 172, 184
 Fournier, inventor of point system, 4
 French folio, 23
 folio for spotting up, 228
 chalk, use of, for embossing-die, 243
 Frisket, use of, 241, 244
 use of, in printing a register job, 246

Full body of letter occupied by initial, 101
 Fundamental principles of job composition, 85
 Furniture, metal, 184
 placing in form, 184
 reversing of, to prevent riding of forms, 173
 shrinking of, 225
 wooden, 172, 184

G

Galley-press, 25
 Gaping corners, how to fix, 172
 Gauge for casting off type, 30
 tympan-, 231
 Gauge-pins, 231
 Genealogies, algebra, and pedigrees, 161
 General classification of type faces, 73
 principles of locking up forms, 163
 rules for layouts, 124
 survey of the field of job composition, 84
 "Give" or springiness in a form, 167
 Glass-encased pressroom, 254
 Glass slab for mixing ink, 257
 Glossary, 281-305
 Gluing cardboard to roller-track, 168
 Glycerine as an aid in withdrawing sheets
 from press, 236
 Golden oblong, 97, 98
 ratio of Greek art, 94
 Golding Jobber, 220
 Gordon Press, 221
 Gothic and text, use of together, 87
 Gothic type, 74
 Goudy, type designer, 75
 Grain of paper, 244, 270
 Graphic representation of proportions, 96
 Gray tone, 87
 Greek art, golden ratio of, 94
 Gress on optical center, 85
 Gripper-edge, 181
 Gripper-gauge, 183
 Grippers, 181, 223, 234
 cork on, 224
 skeleton, 223
 Grit beneath type, 23
 Groove on four-em wooden furniture, 172,
 184
 Grouping, 85, 91
 of word "books" for letterhead, 120
 Groupings for letterhead, 118, 119
 Gudgeons, 167, 224
 adjustable, 168
 and rollers not of same diameter, 168
 Guide for registering, chalk-mark as a, 169
 Guides, 223, 231
 holding in position on draw-sheet, 233
 how to set, 231, 232
 quad, 231
 Gutenberg's invention, 4

H

Hair-lines, 76
 Hair-space, 7
 Halftone screen, 258
 Halftones, 258
 enamelled paper for, 254
 Hand- and machine-folding, 177
 Hand-cut overlay, 231
 Hand-made paper, 270
 Hand-roller, or brayer, 23

Hand-set rule job, 142
 ruled blanks, 143
 table, 108
 Hand-written books of the early scribes, 98
 Hard ink, removal of, 247
 Hard packing, 226
 Harmony, 85, 87
 Century Dictionary's definition of, 87
 Hash, typographical, 80
 Headings, near bottom of pages, 32
 blank-book, 153
 Heavy-faced type for iron and steel ads, 90
 Heavy paper, folding, 194
 Heavy tone, 87
 Holding curved line in position, 161
 guides in position on draw-sheet, 232
 proof-paper against roller on galley-press,
 25
 How different thicknesses of paper are made,
 266
 much will it make? 36
 printing-ink dries, 253, 254
 type should be held in the hand while
 distributing, 33
 How to acquire speed as a typesetter, 15
 approximate the number of words in
 copy, 36
 distinguish the letters *b*, *d*, *g*, and *p*,
 1, 4
 fill a certain space with a certain piece
 of copy, 38
 handle a planer, 166
 make a layout for a letterhead, 120
 make up border units, 113
 obtain perfect joints in tables, 108
 place proof-planer on form, 24
 read type in the stick, 4
 remedy ink troubles, 255
 set lines straight across, 151
 stand at ease, 19
 tell a roller in good condition, 224
 use a galley, 19
 Humidity, action on rollers and ink, 254
 pressroom, 254
 Hyphen, uses of, 58
 with a double stroke, 47
 Hypotenuse oblong, 97, 98
 not changed by folding, 97

I

Imposing the form, 182
 Imposing-stone, placing pages on, 176
 Imposition, 176
 Impression, amount of, 226
 trial the, 228
 Improper division of words to conserve equal
 spacing, 104
 to obtain uniform spacing, 18
 Improper way to lock up a form, 163
 Improperly punctuated sentence, 51
 Improving a job, 102
 by the use of colored ink and paper,
 102
 Inability to get register on enamelled paper,
 254
 Incorrect method of feeding a press, 235
 Indentation of paragraphs, 71, 72
 of poetry, 72
 Initial *A*, as part of the word, 100
 standing alone, 100
 Initial, amount of space around, 99

Initial and text in harmony, 99
 in a different color, 99
 lined up at the top, 100
 occupying full body of letter, 101
 when word is all caps, 99
 with filigree work, 101
 Initials, 99
 bastard lengths alongside of, 113
 mortised, 99
 with plenty of white space on them, 100
 without white space on them, 100
 Ink, deleterious effect of, on rollers, 224
 hard, removal of, 247
 soft, use of, 226
 stiff, use of, 226
 suited to the paper, 253
 troubles, how to remedy, 255
 Inserting cut in electrotype plate, 157
 Inserting form in press, 227
 Inserts, 177
 Insetting, 193
 Inter-relation of spaces of different sizes, 151
 Interrogation mark, origin of, 60
 uses of, 60, 61
 Intertype, the, 218
 Ionics, 79
 Iron and steel ads, type for, 90
 Iron quoin, 164
 Irregularly shaped cut, justifying type to, 158
 running matter around, 156
 Italic type, 75

J

Jenson, Nicolas, 74
 Job composition, 84
 Job, not in harmony with shape of the page,
 136
 same shape as type, 101
 setting, 116
 Jobs containing rules, 141
 locking up, 170
 Joints in tables, how to obtain perfect, 108
 Jordan, or refining-engine, 264
 Judging proof by the impression in the
 paper, 23
 Judicious ornamentation, 98
 Justification by the use of point material,
 112
 Justifying a line, 16
 on the Monotype, 214
 one size of type with another, 9
 type by the use of point-thick spaces, 9
 type to irregularly shaped cut, 158
 Justifying-scale, Monotype, 214

K

Kerned letters, 4
 Kerosene, best material for washing rollers,
 246
 Keyboard, Linotype, 209
 Monotype, 212
 Key-form for registering, 241
 Kind of twine for tying up type, 19
 Knowledge required of a proofreader, 44

L

Label, 126
 Labor-saving material, 7
 rule not to be cut, 107
 Laid paper, 270

- Lakeside system of expressing paper weights, 276
- Lapped corner, 107, 108
- Last line of a paragraph, 17
- Last page of a chapter, 32
- Latins, 79
- Lay of case, 1
- form, determining the, 178
 - forms, 187
 - the eight, 187, 188
 - the four, 187, 188
 - the sixteen, 192
 - the twelve, 188, 189
- Layout for an outlook billhead, 125
- for a statement for outlook envelope on unruled stock, 122
 - for a statement on ruled stock, 122
- Layout man, 84
- Layouts, general rules for, 124
- Law of levers, 85, 91
- Laws, unwritten, of typography, 90
- Lead-cutter, 197-199
- Lead rule, 104
- Leaded matter, 10, 39
- Leaders, 150
- Leading matter while setting, 10
- Leads, cutting of, to odd measures, 199
- odd lengths of, 113
- Ledgers, 273
- Legal ream, 274
- Legibility, 10
- of old-style faces, 76
- Length to width, relation of, 94, 95
- Lengthwise forms, proper lay of, 194
- Letter s showing optical illusion, 85
- Letterhead, analysis of copy for, 116
- description of, 116
 - groupings, 118, 119
 - how to make a layout for, 120
 - laying out, to dry, 237
 - locking up, 165, 166
 - margins for, 121
 - position of, on sheet, 121
- Letters, mitering, 205
- mortising, 205
- Letter-spacing, 102, 103
- to make lines of equal length, 104
- Levers, law of, 85
- Ligatures, 4
- Light-faced type for millinery ads, 90
- Line drawn through a capital letter in copy, 47
- Line standing alone, 90
- tight enough to stand alone, 16
- Lines of nearly equal length, 103
- too nearly uniform in size, 90
- Line-up of figures, 151
- Lining up an initial at the top, 100
- initials containing filigree work, 101
 - paragraphs on proof, 50
- Linotype, method of mounting illustrations, 216, 217
- method of running type around cuts, 155
 - rule, 104
 - slugs as spacing material, 11
 - the, 209
- Linseed-oil, 253
- Liquid drier, 253
- Littering of type cases, 81
- Locking a form so that it may be easily moved, 169
- job and furniture together, 163
- Locking two sections of a rule job in one form, 170
- up a form, 165
 - improper way, 163
 - proper way, 164
- up envelope corners, 165
- up forms, 163
 - containing rules, 165
 - general principles, 163
 - head down, 165
 - head to the left, 165
 - so that pressman can read printed matter, 165
 - jobs containing rule, 170
 - letterheads, 165, 166
 - perforating-rule, 170
 - register jobs, 168
- Locking-quoins, 169
- Logotypes, 4
- Loose chase-bars, 184
- Lye for cleaning type, 247

M

- Machine- and hand-folding, 177
- Machine-finished papers, 271
- Machine-fold, 193
- Magazine, Linotype, 209
- Main item for display, 90
- Major and minor elements, 82
- Make-ready, 227
- marking a sheet for, 229
 - patching a sheet of, 229
 - placing in position, 229
 - spoiling, 226
- Making a dummy to get lay of pages, 179
- columns equal full width of job, 144
 - columns to some multiple of the en, 149
 - pages a line long to avoid short pages, 32
 - ready, 227
 - up a stick, 13
 - to narrow measure, 148
 - up odd lengths of leads, 113
 - up pages, 30
 - up to the paper, 187
- Mallet, 23
- Manuscript copy, 101
- Margins, 177
- determining, 177
 - for letterhead, 121
 - how to determine, when setting guides, 232
- Marked proof, 48
- Marking a sheet for making ready, 229
- copy for boldface, 45
 - capitals, 45
 - italic, 45
 - small capitals, 45
 - of rollers, 225
 - pages on dummy, 179, 180
- Marks, of punctuation, 51
- proofreaders', 45
- Marring of sheets while feeding a press, 235
- Mass grouping, 91
- Masses, 91
- Mass-weight, 85
- Material, troublesome, 112
- Matrices, Linotype, 210, 211
- Matrix-case, Monotype, 214, 215
- Mattling of fiber in paper-making, 266
- McGreal Combination Chase, 194
- Meaning of the word "plane," 166
- Measuring type with a foot-rule, 39

Mechanical overlay, 231
 wood-pulp, 263
 Mediocre ability, 84
 Menu, treatment of, 132
 Metal furniture, 184
 Method of holding and tapping form-planer, 24
 Miller Saw-Trimmer, 197
 Millinery ads, type for, 90
 Minor and major elements, 82
 elements, 76
 Mitchell Mitering-machine, 200
 Miter, explanation of term, 200
 Mitered corners, 107
 Mitering letters, 205
 Mitering-machine, 200
 cutting to multiples of a point on, 204
 Mitchell, 200
 resetting knife on, 202
 set of knife on, 201
 trimming material on, 202
 trimming to gauge on, 203, 204
 type fitting on, 205
 upright, description of, 200, 201
 Mitering with a file, 206
 Miters, inside and outside, with chamfered rule, 106
 Mixing ink, 256
 tints and shades, 257
 Modern and old-style faces, difference in, 76
 Modern type, 77
 for newspapers, dictionaries, etc., 77
 Mold-disk, Linotype, 210
 Monotype, method of mounting illustrations, 216
 method of running type around cuts, 155
 method of setting rule work, 147
 rule, 104
 rule job, 142
 system a unit system, 10
 the, 212
 unit, 213
 Mortised initials, 99
 Mortised letters, 103
 Mortising letter, 205
 Mottling, 255
 Motto card, 133
 Mounting embossing-die, 242
 illustrations in machine-set composition, 215
 Multio-Hexset Quadrats, Stephens's, 144
 Multiplying factor, or constant, 98

N

Narrow measure, setting type in, 149
 Need for skill in setting tabular matter, 141
 Nicknames, omission of period in, 58
 No change in the cap case since the days of
 Jensen, 74
 Non-distribution, 216
 Nonpareil, 4
 Number of divisions permissible, 65

O

Oblique or sloping serifs, 79
 Oblongs, 97
 Odd lengths of leads, making up, 113
 Office stationery, 101
 Oil-cups, need for constant attention, 225
 Oiled sheet for registering, 241

Oil-holes, care of, 225
 Oiling the press, 225
 Old-face, 76
 Old-style, 75
 and modern not to be used together, 87
 faces, legibility of, 76
 for display work, 77
 Omission of part of compound word, 67
 of period after Roman numerals, 70
 of period in nicknames, 58
 of periods from headings and display lines, 70
 of words in an extract, 58
 One line longer than the rest, 16
 Opening and closing envelopes, 240
 Opening up of letters a and s to improve legibility, 80
 Opportunities for men of artistic temperament, 84
 Optical center, 85
 Gress on, 85
 Trezise on, 85
 Optical illusion, 85
 Order-blank, 116
 a typical, 117
 Order of procedure in proofreading, 50
 of sequence in printing process inks, 260
 Ordering stock in even quires, 279
 Origin of exclamation mark, 61
 of interrogation mark, 60
 of paper, 262
 of the Roman alphabet, 74
 Ornamentation, in harmony with balance of job, 99
 of early hand-written books, 98
 shape of, 99
 Ornaments and borders, 98
 Other groups of type faces, 79
 Outlook envelope, planning for, 124
 Oval serifs, 79
 Overlay, hand-cut, 231
 mechanical, 231
 Overlaying, 230, 231
 Overrunning type, 29

P

Pabst Oldstyle, 79
 Packing, 223
 hard, 226
 soft, 226
 Pages, in reverse of the printed sheet, 179
 making up, 30
 of equal size, determining margins for, 177
 of unequal size, determining margins for, 177
 on stone not in regular sequence, 176
 out of center, 186
 that back each other, 176
 Panel grouping, 91
 Trezise on, 91
 Paper, 262
 coated, 271
 cutting in more than one direction, 279
 different thicknesses of, how made, 266
 enamelled, 271
 expansion of, 254
 flat, 273
 grain of, 244
 hand-made, 270
 ink suited to, 253
 laid, 270

- Paper, machine-finished, 271
 making up to the, 187
 origin of, 262
 picking of, 254
 sized-and-supercalendered, 271
 sizes of, 273, 274
 weights, Lakeside system, 276
 weights of, 274
 wire side of, 236
- Paper-cutter, a dangerous machine, 249
- Paper-making machine, the, 266
- Paragraph with side heading, 30
- Paragraphs, indention of, 71, 72
- Parentheses, use of, 62
- Parts of a form, 181
- Paste drier, 253
- Patching a badly battered letter, 230
 a sheet of make-ready, 229
- Pedigrees, algebra, and genealogies, 161
- Pencil sketches, 120
- Per cent, 71
- Percentages for oblongs, 97
- Perfect joints in tables, how to obtain, 108
- Perforating, 243
 printing, scoring, and cutting at one operation, 245
- Perforating-rule, 243
 cutting rollers, 244
 locking up jobs containing, 170
 lower than type-high, 244
 preventing from cutting rollers, 170
- Period of old-style faces, 75
- Period, uses of, 57, 58
 with Roman numerals and Arabic figures, 57
- Periods and commas inside of quotation marks, 59
- Pi, 81
 as an aid to type study, 81
- Pica, a standard size, 4
 actual size of, 5
 actual thickness of, 5
 em, 6
 size, lack of uniformity of, 5
- Picking of paper, 254
- Piece-workers, 39
- Pigments used in printing-ink, 252
- Placing a job on the stone, 23
 a line around a circle, 159, 160
 envelope cutout in position, 239
 furniture in form, 184
 make-ready in position, 229
 of proofreaders' marks on proof, 47
 pages on the imposing-stone, 176
- "Plane," meaning of the word, 166
- Planer, form-, 23
 how to handle, 166
 proof-, 23
- Planing a form, 166
 form after it is locked up, 186
- Planning a job, 91
 things to be kept in mind when, 101
 a ruled job, 145
 for an outlook envelope, 124
- Platen, adjusting by aid of impression-screws, 223
 definition of, 221
 presses, 221
 the, 222
- Plugging quoins with a wad of paper, 170
- P. M. and A. M., 71
- Poco proof-press, 27
- Poetry, indention of, 72
- Point, actual thickness of, 5
- Point system, 4
 invention of, by Fournier, 4
- Point-line, 9
- Point-set, 10
- Point-thick spaces, 9, 113, 150
- Points, press-, 194
- Poorly balanced page, 136, 138
- Position of letterhead on sheet, 121
- Possessive case, 59, 70
- Potter proof-press, 27
- Pounds, abbreviation for, 70
- Press, feeding a, 234
 oiling the, 225
- Pressboard on tympan, 226
- Presses, platen, 221
- Press-points, 194
- Press-proofs, 26
- Pressroom, temperature and humidity, 254
 up-to-date, glass-encased, 254
- Presswork, 220
- Preventing perforating-rule from cutting the rollers, 170
- Printed sheet, pages in reverse of, 179
- Printers' oblong, 97, 98
- Printing a job in two sections to obtain perfect joints, 109
 a two-color register job by the aid of a frisket, 246
 cutting, scoring, and perforating at one operation, 245
 type above rule lines, 105, 106
- Printing-ink, 252
 composition of, 252
 dopes, 256
 drier for, 253
 duotone, 257
 how it dries, 253
 knowledge of chemistry required, 252
 mixing, 256
 pigments used in, 252
 process, 259
 tack of, 255
 unwise to make additions to, 252
 vehicle for carrying pigment in, 252
- Printing-office style, 69
- Probable origin of the serif, 77
- Problem in proportion, 91
- Process inks, 259
 order of sequence in printing, 260
- Process work, three-color, 259
- Professional removal notices, 131
 statement, 130
- Proof-paper, 23
- Proof-planer, 23
- Proofreader, knowledge required of, 44
- Proofreader's duty, 51
 to suggest change, 45
 marks, 45
 privilege, 51
- Proofreading, 44
 requirements for, 44
- Proofs in colors, 24
- Proper and improper way of using rule with type, 105
 lay of lengthwise forms, 194
 spacing for leaded matter, 10
 spacing for solid matter, 10
 way to lock up a form, 164
- Properly punctuated sentence, 51
- Proportion, 85, 91, 94

Proportion, diagonal method, 94
 in relation to type faces, 76
 Proportions, table of, 95
 Proving book forms, 26
 pages in pairs, 26
 Publicity type, 79, 90
 Pulling a proof, 23
 a revise, 30
 proof of cylinder form, 186
 proofs when jobs are too large for proof-press, 26
 Punctuation, 50
 marks, 51
 Putting away leads and furniture, 35
 Pyramid ornament, 99
 style of placing furniture in forms, 163

Q

Quad guides, 231
 Quads, 7
 Query, 51
 Quire, number of sheets to, 274
 Quoins, 164
 iron, 164
 locking-, 169
 tightening, 167
 wooden, 164
 Quotation marks and colon used together, 57
 and semicolon used together, 56
 uses of, 59, 60
 Quotations, double, 59, 60
 single, 59, 60

R

Rag stock for paper-making, 263
 Ratio, 91
 of three to five, 91
 Reading type line for errors, 16
 Ream, number of sheets to, 274
 the, 274
 Reclamation of soda-ash, 264
 Red ink, deleterious effect of electrotypes on, 111
 Refining-engine, the, 264
 Register on enamelled paper, inability to get, 254
 Register jobs, allowance for moving when setting, 112
 allowing for movement of, 168
 locking up, 168
 Registering, 241
 used of oiled sheet, 241
 use of pin in, 242
 Reglet, use of, 185
 Regular oblong, 97, 98
 Relation between characters of same font on Monotype, 215
 of margins for pages out of center, 187
 of type sizes, 90
 of width to length, 94, 95
 Relative strength of hand-made and machine-made papers, 271
 Relative weights of paper, 274
 how to determine, 275
 table of, 277
 Removal notices, professional, 131
 Removing hard ink from rollers and press, 247
 rollers when press is left standing, 225
 Requirements for proofreading, 44

Reset specimens in "The Inland Printer," 124
 Resetting of a poorly balanced page, 137, 139
 knife on mitering-machine, 202
 Reversing furniture to prevent riding of form, 173
 Revise, pulling a, 30
 Ribs on linotype slugs, 11
 Riding of forms, 172, 173, 184
 Ring drawn around a contraction, abbreviation, or an ampersand, 47
 Rio Grande, 70
 Rollers, 224
 and gudgeons, not of same diameter, 168
 composition of, 224
 cut by perforating-rule, 244
 deleterious effect of ink on, 224
 for different seasons, 224
 in good conditions, how to tell, 224
 marking of, 225
 shrinking of, 224
 sliding contact of, 168
 Roller-bearers, 224
 Roller-pins, wearing of, 168
 Roller-stock keyed to gudgeons, 167
 Roller-track, gluing cardboard to, 168
 Roman type, 74
 Rosin-oil, 253
 Round serifs, 79
 Rounding of type from soft packing, 227
 Rouse or American Slug-cutter, 199
 Rubbing rules on the stone, 32
 Rule, 104
 burr on, 202, 203
 dishing of, 199
 doubling-up, 106
 in a job part of the ornamentation, 104
 job by four different methods, 142
 job, slurring of, 242
 job, two sections locked in one form, 170
 Linotype, 104
 Monotype, 104
 Ruled blank, first step in setting, 143
 blanks, hand-set, 143
 job, planning a, 145
 job, setting a, 145, 146
 Rules aligned with type, 105
 and type to align at bottom, 105
 butted, 107
 for spacing, 17
 Running down of composition rollers, 224
 matter around irregularly shaped cuts, 156
 type around cuts, 155
 type around cut, cutting pattern for, 156

S

S as an illustration of optical illusion, 85
 Saddle-stitched, 176
 Safety device for job press, Sylvester, 248
 devices, 247
 first, 225
 Salient features of a job, selecting the, 101
 Sandpaper as an aid in withdrawing sheets from press, 236
 Sans-serif, 73
 Saving cord for future use, 30
 Saviour with a u, 70
 Saw-Trimmed, Miller, 197
 Scoring, explanation of term, 244
 printing, cutting, and perforating at one operation, 245

- Screen, halftone, 258
 Script type, 75
 Secret of obtaining good proofs, 24
 Selecting the salient features of a job, 101
 Selection of rule for a job, 104
 Self-spacing table, specimen of, 148
 Selling composition on a square-inch basis, 39
 Semicolon and quotation marks used together, 56
 Semicolon, uses of, 56
 Sentence improperly punctuated, 51
 properly punctuated, 51
 Separating letters while distributing type, 33
 Serif, 77
 probable origin of, 77
 the dominating feature of a letter, 78
 Serifs, old-style and modern compared, 78
 Serviceability of brass rule, 104
 of lead rule, 104
 "Set" of knife on mitering-machine, 201
 Setting a blank-book heading, use of ruled sheet in, 154
 a job, 116
 a job in two sections to obtain perfect joints, 109
 a register job, 112
 a ruled job, 145, 146
 and registering type to horizontal lines, 154
 more than one column in a single measure, 152
 rule work, Monotype method, 147
 tables and other intricate matter, 141
 tables to even multiples, 146
 type, 15
 type in circles, 158
 type in narrow measure, 149
 Shades, mixing, 257
 Shape harmony, 101
 job lacking in, 136
 Shape of ornamentation, 99
 Shaving letters, 103
 Sheet, bowing a, 234
 flying a, 234, 235
 Sheetwise, 176, 181
 Shifting bars, 183
 Short "and", 71
 Shrinking of furniture, 225
 of rollers, 224
 Side-face or chamfered rule, 106
 Sierra Nevada, 70
 Signatures, 193
 Simplicity of modern composition, 99
 Single measure, setting more than one column in, 152
 Single quotations, 59, 60
 Sixteen, lay of the, 192
 Size type to be used, 121
 Sized-and-supercalendered papers, 271
 Sizes of envelopes, 278
 of papers, 273, 274
 of spaces, 7
 Skeleton grippers, 223
 Skeletonizing, 109-111
 for two colors, 110
 no need to, when job is to be electrotyped, 111
 Sliding contact of rollers, 168
 Sliding type of platen press, 221
 Slipping of paper over face of type on galley-press, 25
 Slipsheeting, 237
 Slitting, 244
 Sloping or oblique serifs, 79
 Slug, Linotype, 209
 Slug-cutter, Rouse or American, 199
 Slugs, tie-up, 186
 Slurring, 242
 of rule jobs, 242
 Soaking type in lye-water, 32
 Soda process, 264
 Sodium silicate, use of, for embossing, 243
 Soft ink, use of, 226
 Soft packing, 226
 Solid matter, 10, 39
 Soluble water-glass, 243
 Sort, 81
 Sorting leads and slugs, 35
 Source of dirty quad-boxes, 18
 Space, white, use of, 90
 Space-bands, Linotype, 210
 Spaces alongside of type, 18
 of different sizes, inter-relation of, 151
 point-thick, 113, 150
 sizes of, 7
 thickness of, 8
 Spacing before colon, semicolon, interrogation mark, and exclamation mark, 18
 condensed type, 102
 extended type, 102
 job type, 102
 letters, 102, 103
 of lines, 10
 of words when lines stand alone, 102
 words in capitals, 102
 words with sloping letters, 102
 words with straight letters, 102
 Specimen of Bodoni Modern, 79
 Caslon Old-style, 79
 Cheltenham, 80
 Clearface, 80
 Forum Title, 76
 gothic type, 74
 harmony and appropriateness, 88
 Kennerley, 76
 old-style italic type, 75
 old-style type, 74
 panel grouping, 93
 poorly balanced job, 86
 poorly balanced page, 92
 Scotch-face Roman, 77
 script type, 75
 self-spacing table, 148
 text type, 73
 well-balanced job, 86
 well-balanced page, 92
 Specimen showing use of three-point bevel rule, 93
 Specimens of Bodoni type, 75, 77
 brass rule, 105
 inharmonious groupings, 89
 statement headings, 123
 swash letters, 82
 Specimens, reset, in "The Inland Printer," 124
 Spelling out of numbers, 71
 Spoilage, allowance for, 279
 Spoiling job by printing on wrong side of paper, 236
 make-ready, 226
 proof by improper use of proof-planer, 24
 Spotting up, 227
 use of French folio, 228
 Spot-up, 227
 Springiness or "give," 112, 167

- Square effect, 103
 ornament, 99
 Squaring the form, 172
 Squeeze, allowance for, 112, 146, 170
 Standardizing proportions, 96, 97
 Statement, professional, 130
 Stationery, office, 101
 Steel cutting-rule, 244
 rule, how to cut, 198
 Stephens's Multio-Hexset Quadrats, 144
 Stet mark, 47
 Stiff ink, use of, 226
 Stock, adapting ink to, 254
 Straight matter, 38
 Strawboard for cleaning rules, 32
 Stuff, 264
 Style of the office, 44, 69
 Substance number system of designating
 paper, 276
 Success, elements of, in a job, 102
 Succession of the same word on more than
 two lines, 70
 Sulphite process, 264
 Swash letters, 82
 Sylvester safety device for job press, 248
 Symbols employed in proofreading, 46
 System, typotabular, 141
- T
- Table, casting off a, 147
 hand-set, 108
 of proportions, 95
 of rates per square inch for computing
 value of composed type, 40
 of relative weights of paper, 277
 of symbols employed in proofreading, 46
 showing thickness of spaces, 8
 Tabular matter, need for skill in setting, 141
 work, Linotype, 211
 Tack of ink, 255
 Talking-machine disk, use of, for embossing-
 counter, 243
 Tally-card, cutout for, 160
 Temperature, pressroom, 254
 Testing a form, 167
 Text and gothic, use of, together, 87
 and initial in harmony, 99
 from ecclesiastical sources, 73
 letter as the main feature of job, 87
 type, 73
 type for ecclesiastical purposes, 91
 Thickness of spaces, 8
 Thick-space, 7
 Thin space before colon, semicolon, interro-
 gation mark, and exclamation mark, 18
 Things to be kept in mind when planning
 a job, 101
 Three-color process work, 259
 Three-em space, 7
 Three-point rule a multiple of pica, 106
 Three-point space of eight-point, 9, 150
 Throwing or dropping type into case, 35
 Tie-up slugs, 186
 Tightening quoins, 167
 Tilting proof-planer, 24
 Tints, mixing, 257
 Titles, abbreviated, 70
 To detect inequality of indentation on proof, 50
 determine charging rate per square inch, 40
 find cost of one square inch of any size
 type, 40
- Tone, 85, 87
 gray, 87
 heavy, 87
 uniformity of, throughout job, 87
 Top of chase, 183
 Treatment of a menu, 132
 Treize on optical center, 85
 on panel grouping, 91
 Trial impression, the, 228
 Trim, 181
 Trimming material on mitering-machine, 202
 to gauge on mitering-machine, 203, 204
 Troubles with black ink, how to overcome,
 255
 Troublesome corners, 170
 material, 112
 True art not based on mathematics, 94
 Tumbling, 193
 Turning one type face into another, 78
 Twelve, lay of the, 188, 189
 Twisting plates into register, 168
 Two-color job with type all in one form, 246
 Two colors, skeletonizing for, 110
 Two-letter division, 63
 Two-on, 194
 Tying up a job, 19, 21
 Tympan, 223
 arranging the, 228
 hard, 226
 soft, 226
 the, 226
 Tympan-bale, which one to open, 230
 Tympan-gauge, 231
 Type adapted to paper, 75
 and rules to align at bottom, 105
 calculations, 36
 distribution of, 33
 faces, 73
 faces, general classification, 73
 families, 80
 family, adhering to one, 87
 fitting on a mitering-machine, 205
 for ecclesiastical purposes, 91
 for narrow measures, 101
 for wide measures, 101
 groups, balancing of, 85
 matter against cuts, 156
 of maximum legibility, 80
 off its feet, 21
 punching through paper when pulling
 proof, 23
 rounding of, from soft packing, 227
 same shape as job, 101
 size to be used, 121
 sizes, new and old systems compared, 5, 6
 sizes, relation of, 90
 study, pi as an aid to, 81
 systems, 6
 to be set nick up, 15
 Type-casting machines, 218
 Type-high, 167
 machines, 206
 Typical order-blank, 117
 Typographical hash, 80
 Typography, bad, to mix old-style and
 modern type, 79
 Typotabular method of securing definite
 number of points between lines, 143
 Typotabular rule job, 142
 Typotabular squares, 141
 Typotabular system, 141
 Typotect, 84

- U
- Underlay, 228
 Underlining of words in copy, 45
 Uniform spacing, 17
 Uniformity of tone throughout job, 87
 Unit, casting type to, 4
 Monotype, 213
 system for making paper, author's method, 278
 Units, border, how to make up, 113
 Unwritten laws of typography, 90
 Upright mitering-machine, description of, 200, 201
 Use of comma before conjunction, 53, 54
 comma in amounts of five figures, 71
 four figures, 71
 condensed type, 101
 figures for numbers, 71
 frisket, 241, 244
 gummed paper for holding curved line in position, 159, 160
 leads to make type fit space, 38
 period with Roman numerals and Arabic figures, 57
 pin in registering, 242
 reglet, 185
 rule in electrotyped job, 107
 ruled sheet in setting a blank-book heading, 154
 thin paper when making up a stick, 14
 two-em furniture when tying up a bulky job, 21
 white space, 90
 Uses of the apostrophe, 59
 brackets, 62
 caret, 47
 colon, 56, 57
 comma, 51-54
 dash, 54-56
 exclamation mark, 61
 hyphen, 58
 interrogation mark, 60, 61
 parentheses, 62
 period, 57, 58
 quotation marks, 59, 60
 semicolon, 56
 Using rule with type, proper and improper ways, 105
- V
- V, the old form of the capital U, 74
 Vandercook proof-press, 28
 Various parts of a form, 181
- Varnish, 253
 Varnishes of different consistencies, 253
 Vehicle for carrying pigment in printing-ink, 252
 Verify divisions of words, 50
 Victoria Press, 168
 Viscosity, 253
 V-shaped slit in draw-sheet, 233
- W
- Wad of paper for plugging quoins, 170
 Warped wooden furniture, 172, 173
 Washing rollers, kerosene best material for, 246
 Washing up, 246
 Washington hand-press, 27
 Water on wooden furniture, 172
 Watermark, 270
 Wax-engraving effect, 109
 method of obtaining a ruled job, 146
 rule job, 142
 Wearing of roller-pins, 168
 Weights of paper, 274
 Well-balanced page, 135
 Well-proportioned pages, 97
 Wetting type prior to distribution, 33
 What size type shall I use? 37
 Which way type is to be set, designating, 116
 White paper, black ink on, 90
 White space, 90
 around cuts, allowance of, 156
 use of, 90
 Width to length, relation of, 94, 95
 Wiping around presses, 249
 Wire side of paper, 236
 Wiring through the side, 176
 Wooden furniture, 172, 184
 four-em, not square, 172, 184
 warped, 172, 173
 water on, 172
 Wooden quoins, 164
 Wood-pulp, chemical, 264
 mechanical, 263
 Words, division of, 63-65
 of one syllable cannot be divided, 64
 Work-and-turn form, 176, 181
 Working by the piece, 38
 Workmen of mediocre ability, 84
 Writings, 273
 Wrong font, 81

FEB 19 1918

