

TECHNOLOGICAL

HANDBOOKS

PRINTING

C. T. JACOBI

ifornia
onal
ity



THE LIBRARY
OF
THE UNIVERSITY
OF CALIFORNIA
LOS ANGELES

TECHNOLOGICAL HANDBOOKS.



PRINTING.

TECHNOLOGICAL HANDBOOKS.

1. DYEING AND TISSUE-PRINTING. By William Crookes, F.R.S., V.P.C.S. 5s.
2. GLASS MANUFACTURE. INTRODUCTORY ESSAY, by H. J. Powell, B.A. (Whitefriars Glass Works); CROWN AND SHEET GLASS, by Henry Chance, M.A. (Chance Bros., Birmingham); PLATE GLASS, by H. G. Harris, Assoc. Memb. Inst. C.E. 3s. 6d.
3. COTTON SPINNING; Its Development, Principles, and Practice. By R. Marsden, Editor of the "Textile Mercury." With an Appendix on Steam Engines and Boilers. 3rd edition, revised, 6s. 6d.
4. COAL-TAR COLOURS, The Chemistry of. With special reference to their application to Dyeing, &c. By Dr. R. Benedikt. Translated from the German by E. Kuecht, Ph.D. 2nd edition, enlarged, 6s. 6d.
5. WOOLLEN AND WORSTED CLOTH MANUFACTURE. By Professor Roberts Beaumont. 2nd edition, revised. 7s. 6d.
6. COLOUR IN WOVEN DESIGN. By Professor Roberts Beaumont. *In the press.*
7. BOOKBINDING. By J. Zaehnsdorf.
8. PRINTING. By C. T. Jacobi, Manager of the Chiswick Press.
9. COTTON WEAVING. By R. Marsden. *In preparation.*

PRINTING :

A PRACTICAL TREATISE ON THE ART OF TYPOGRAPHY
AS APPLIED MORE PARTICULARLY TO THE
PRINTING OF BOOKS.

BY

CHARLES THOMAS JACOBI,

MANAGER OF THE CHISWICK PRESS; MEMBER OF THE COUNCIL OF THE INSTITUTE
OF BRITISH PRINTERS; AUTHOR OF "THE PRINTERS' HANDBOOK"
AND "THE PRINTERS' VOCABULARY."

WITH UPWARDS OF 150 ILLUSTRATIONS

AND MANY USEFUL TABLES, TOGETHER WITH GLOSSARIAL INDEX OF
TECHNICAL TERMS AND PHRASES.

LONDON: GEORGE BELL AND SONS,
YORK STREET, COVENT GARDEN.

1890.

CHISWICK PRESS — C. WHITTINGHAM AND CO., TOOKS COURT,
CHANCERY LANE.

715p

5-8-11
bms

PREFACE.

I N offering the following pages as a contribution to the advancement of technical education, I have endeavoured to lay down the principles of good and sound workmanship in the practice of typography. Without proper care and attention, together with the employment of good materials, it is impossible that satisfactory results can be obtained. Nor can anyone acquire perfection in this or any art without the necessary practical experience, combined with a natural aptitude for the particular craft he may adopt.

Printing has been described as the "art preservative of all other arts," and doubtless it is so, for without the ready means of placing on record the methods and other details belonging to the arts and crafts generally, much would have been lost to the present generation. For the Art of Printing itself a great deal has been done in this respect during the last few years, and this circumstance is evidence of the craving for increased technical instruction, and is a healthy impulse which should be fostered to the utmost.

The use of mechanical processes, and the consequent subdivision of labour which it has entailed, has much to answer for in reducing the interest of the journeyman printer in his daily labour, and it is mostly by the institu-

tion of classes and the issue of works bearing on the technical details of the subject that he can be qualified for higher posts, and perhaps fit himself for the position of a master-printer and employer of labour.

I do not presume to say that the methods I have here laid down are universally adopted, but I am confident that good and thorough workmanship will be produced if the text of this book is studied and acted upon. Experience is still the best teacher, and much depends upon the conditions and circumstances under which the workman may labour.

Book printing is the criterion of Printing in general; what are called jobbing and news-work are branches of minor importance. The first is here treated of as fully as space would allow, the others I could but briefly touch on. One word I must say against the tendency noticeable nowadays to over-elaborate jobbing work. The excessive rule-work, twisted and twirled in all manner of fantastic shapes, the adoption of grotesque types, together with the employment of diversified colours (not always harmonious) is work really overstepping the bounds of proper typography, and it appears to me but an emulation of lithography or chromolithography. This style of work may be produced better and with less expense by these two processes, and the cultivation of such effects by letterpress printing is therefore, in my opinion, to be deprecated. Its execution in type may be clever and ingenious, but that is all.

We still suffer for want of a uniform scale of measurements as regards the bodies of type, and it is hoped by the formation of a sub-committee in connection with the

Institute of British Printers that these bodies may be universally assimilated at no distant period, and that some scale, decimal or otherwise, of relation of one type to another will be adopted. At present the measurements of the several type-founders are very diverse.

Mechanical contrivances for type-setting have been introduced from time to time during the present century, the latest being the "Linotype." To my mind it is the nearest to perfection, and is a marvel of ingenuity, casting its own type, and justifying it as it goes along. Something near a panic was caused in that part of the trade which would have been affected by it if introduced to any great extent, but apparently it has not yet realized the expectations of its introducers. Notwithstanding this, it is only reasonable to assume that sooner or later hand-setting will be largely superseded by mechanical aids, but at the same time, doubtless, the demand for printing will be largely increased, as it was upon the introduction of machine-printing. However clever the machine may be, its resources will probably not be such that it will be able to compose difficult work of an irregular nature—as, for instance, works with italic or clarendon types, cross-lines, head-lines, &c., or to accomplish the make-up; there will always be work left for the skilled compositor.

News-work has made greater progress during the past twenty years than any other branch of printing, and machinery of wonderful and imposing character has been brought into use. But for the care of one experienced artisan the working of these is automatic, from the feeding to the delivering of the printed papers, sometimes folded and even wrapped—the intermediate stages

of damping, printing, and cutting being performed by the same operation. The output, as compared with that of the hand-presses or single-cylinder machines, is enormous, and one can only pause and wonder where invention will stop.

For motive-power steam has largely given way to gas, and there are many motors of this character in the market adapted especially for the smaller or medium-sized offices. Propulsion by electricity is probably only a matter of time.

In conclusion I have to express my indebtedness to several firms for many of the illustrations given in this work. I thank Messrs. Caslon and Co., Cropper and Co., Crossley Brothers, Furnival and Co., Harrild and Sons, Hopkinson and Cope, Hughes and Kimber, the Institution of Civil Engineers (for diagrams of printing machines taken from a paper read by Mr. E. A. Clowes, in their minutes of proceedings), Messrs. Miller and Richard, M. P. McCoy, Sir Charles Reed and Sons, Shanks and Co., F. Ullmer, and others.

C. T. J.

CONTENTS.

TYPES.

	PAGE
CHAPTER I. Letterpress Printing defined—The Production of Type: the Punch, Matrice, and Moulds for Hand and Machine Casting—Component Parts of Metal—Selection of Founts of Type for Wearing Properties and Good Appearance—List of Letters which constitute a Fount—Fractions, Accents, and Signs—Varieties of Old Face, Old Style, and Modern Faces — Italic — Black-letter Founts—Some Jobbing Founts—Distinctive Parts of a Letter—Classification of Letters—The Bodies of Types as to Depth—Sizes of Types—Relation of Types to each other in Body—Spaces and Quadrats—Table of Measurements of Type Bodies	1-23

COMPOSITION AND DISTRIBUTION.

CHAPTER II. Materials, Tools, and Appliances used—Varieties of Frames and Cases—Different kinds of Composing Sticks, Setting Rules, and Galleys—Leads—Brass Rules of Plain and Fancy Character—Furniture, Wooden and Metal—Quoins—Patent Locking-up Apparatus—Mallet, Planer, and Shooting Sticks—Chases, Imposing Surfaces, Forme and Letter-Board Racks—Galley Proof Presses—Rule and Lead Cutters—Bodkin, Tweezers, and Shears	24-52
CHAPTER III. Position and Aspect of a Composing Room, with Plan—Lays of Book and News Cases—Learning the Boxes—Reversed Print—Attitude in Composing—Spacing	

	PAGE
and Justifying—Composition—Making Measures—Rules for Spacing—Emptying the Stick—Punctuation, Capitalization, and Indentions	52-64
CHAPTER IV. Preparing Type for Distribution—Method of Distribution—Odd Sorts and Peculiarities—The Jigger—The Sticking or Caking of Type	65-68
CHAPTER V. Making-up into Pages—Different Styles of Headlines—Determining the Length of Page—Page Gauges—Side-notes, Cut-in-notes, and Footnotes, with their Reference Marks—Rules for the Setting of Preliminary and Appendix Matter—The Printer's Imprint—Tying-up Pages—Signatures	68-73
CHAPTER VI. Imposition—Outer and Inner Formes—Definitions of Sizes of Books—Table of Signatures and Folios—Schemes of Imposition—Margins of Books, and Furniture required—Making Margins—Type Measures or Scales—The proper use of Quoins—Furniture Gauges	73-90
CHAPTER VII. The Locking-up of Formes—The Forme Carriage—Pulling the Proofs—Making Corrections in the Metal—The Space Paper or Box—Signs and Marks used by Readers in Correcting Proofs—Clean Proofs	90-96
CHAPTER VIII. Jobbing Work—The Character of Types used—Wood Types and their Receptacles—Preserving Wood-letter and Cuts—Ornaments, Borders, and Brass Rules—The Classification of Faces—The Adjustment of Border Rules—Curved Work	96-101
CHAPTER IX. Colour Work—Selection of Suitable Types for Rubricated Lines—Methods of making Skeleton Formes or Underlaying for Different Colours—Tint Blocks, how they can be made	102-105
CHAPTER X. Newspaper Work—The Qualifications necessary for News-hands—Making even—Composing Machines in the Market—Description of the Linotype and Thorne Machines	105-109

	PAGE
CHAPTER XI. Classical and other Languages—The Cases used for Greek, Hebrew, and German, with Plans of Lays in general use—Rules for Composition in these Languages	109-127
CHAPTER XII. Type Music—Suggested Plan of Cases—Some Specimens of Music Founts in use	127-129
CHAPTER XIII. Table and Tabular Work—Definitions—Composition	130-131
CHAPTER XIV. Scale of Prices as paid in London—Method of Casting-up Value of Work—Lengths and Widths for ordinary Book-work—Number of Lines per Thousand—How to Cast-off Copy for Quantity—Comparative Sizes of Types—Equivalent of Leads to Type Bodies	131-140

READING.

CHAPTER XV. Qualifications necessary for a Corrector of the Press—Rules for Guidance in the Composing and Reading Departments—The Rudiments of Reading—First Proof Reading—Reading for Press—The Selection of Reading Boys—Books showing Progress of Work in hand—Reference Works for use	141-144
---	---------

PRESS-WORK.

CHAPTER XVI. Definition of Press-work—Description of Presses used—The Stanhope, Columbian, and Albion Presses—Instructions for erecting these Presses—Chill of the Albion Press—Sizes of Presses determined by the Platen	145-152
CHAPTER XVII. Appliances, Tools, and Materials used in connection with Hand Presses—The Tympan and Frisket—The Bank and Horse—Ink Tables—The Brayer and Slice—Ink Knife and Sheep's-foot	153-157

CHAPTER XVIII. Rollers—Varieties of Hand Rollers used—The old-fashioned Inking Ball—Recipes for Composition—Casting Rollers—Hints as to Condition and Treatment of Rollers	158-168
CHAPTER XIX. Inks—The Management of Inks—Description of Various Kinds and Properties of Good Inks for different Purposes—Recipe for Black Ink—Mixing of Coloured Inks	168-172
CHAPTER XX. Printing by Hand-presses—Method of Covering Tympan—Fixing Forme on Press and Making ready—Cutting the Frisket out—Obtaining Register—Press Points—Even Colour in Working off—Lubricating the Press—Difficulties due to Change of Temperature—The Cleansing of Type—Set-off—Slurring	172-183
CHAPTER XXI. The Printing of Illustrated Work—Care of Woodcuts—Cutting Overlays for Cut-work—The Degrees of Work in a Cut—Process Blocks—Rolling and Beating for sufficient Colour—Specimen of Cut without and with Overlay	183-188
CHAPTER XXII. Colour Work—Method of Printing by Underlaying and Skeleton Formes—Hints on Colour—Selection of Colours to Harmonize—Register of Colour Work—Bronze Work and Appliances—Some Remarks on Bronze Work	189-194
CHAPTER XXIII. Stereotype Work—Methods of Mounting Plates for Printing—Varieties of Stereotype and Electrotype Plates—Some Hints and Suggestions on Press-work generally—Picks—Mode of Payment for Press-work	194-199

MOTIVE POWER.

CHAPTER XXIV. Motive Power : Steam, Gas, and Water—Beam, Horizontal, and Vertical Steam Engines—Shafting, Riggers, Speed Pulleys, Brackets, &c., for Driving Purposes—Gas, Horizontal, and Vertical Engines—Water Motors	200-211
--	---------

MACHINE PRINTING.

	PAGE
CHAPTER XXV. Machine Printing—Methods of Impression, Platen and Cylindrical—Classification of Printing Machines—Some Hints on Laying-down Machines as regards Foundation and Light—Cleanliness and Lubrication—Systems of Making-ready by Hard and Soft Impression	212-216
CHAPTER XXVI. Jobbing Work—Class of Platen Machine best adapted for Light and Heavy Work—Ink Distribution—Lay Marks and Gauge Pins—System of Making-ready on these Machines	216-222
CHAPTER XXVII. The Larger Kind of Platen Machine, Single and Double—Making-ready and Mode of Working	222-224
CHAPTER XXVIII. One-sided Cylinder Machines: The Wharfedale—The System of Inking applied to Single-cylinder Machines—Description and Rate of Speed to be attained by the Wharfedale in Working—Making-ready—Finding the Pitch—Hard Packing—Slurring—Packing Rollers—Register—Supply of Ink—Altering the Impression	225-234
CHAPTER XXIX. Perfecting Machines: The Web, Drop-bar, and Gripper Varieties—Set-off—Making-ready—Speeds of Perfecting Machines	235-238
CHAPTER XXX. Rotary Machines: The Victory—The Marinoni—The Whitefriars—Hoe's Six-Cylinder—Their Working Parts, Capabilities, and Speeds	239-247

WAREHOUSE WORK.

CHAPTER XXXI. The Warehouse Department—Varieties of Machine and Hand-made Papers—Number of Sheets comprised in a Ream—Tables of Sizes, Equivalent and Relative Weights, &c.—Cards—Their Qualities and Sizes	248-258
---	---------

CHAPTER XXXII. Machines and other Appliances used in connection with the Warehouse Department—The Hydraulic Press—The Nipping Press—Glazed-Boards—Hot Pressing—Hot Rolling—Cold Rolling—Cutting Machines	258-264
CHAPTER XXXIII. The Care of Paper—Wetting down—The Wooden Press—Counting—The Drying Room—Cold Pressing and manner of performing the same—Stacking Work—Gathering—Collating—Folding—Booking—Packing—Keeping Stock—Folding, Stitching, Stabbing, and Sewing—Binding, Ruling, Perforating, and Numbering	265-274
GLOSSARIAL INDEX	275-302

LIST OF ILLUSTRATIONS.

FIG.	PAGE
1. Steel punch for type	3
2. Matrice for type	3
3. Hand-casting mould (open)	4
4. ,, ,, (shut)	4
5. Type with break attached	5
6. Type showing pin-mark	5
7. Casting machine	6
8. Descriptive parts of a single type	16
9. Double composing frame	25
10. Whole composing frame	26
11. Three-quarter composing frame	27
12. Half composing frame	28
13. Ordinary upper case	28
14. ,, lower case	29
15. Double case	29
16. Treble case	29
17. Screw composing stick	30
18. Lever composing stick	30
19. Thumb-screw composing stick	30
20. Newspaper composing stick	31
21. Broadside composing stick	31
22. Setting rule	31
23. Various galleys	32
24. Specimens of brass rule	34
25. Brass-rule case	35
26. Saw and block	36
27. Metal furniture	36
28. Wooden side-stick	37
29. Wooden quoin	37
30. Screw chases	38
31. Marinoni locking-up apparatus	39
32. Ward locking-up apparatus	39
33. ,, ,, side-stick and quoin	39

FIG.		PAGE
34.	Mallet	40
35.	Planer	40
36.	Various shooting sticks	40
37.	Cast-iron chase	41
38.	Wrought-iron chase	42
39.	Jobbing chases	42
40.	Lock-up chase	43
41.	Imposing surface	44
42.	“Standard” forme-rack	45
43.	“Universal” „	46
44.	Letter-board rack	47
45.	Tall case-rack	48
46.	Galley rack	49
47.	Cylindrical galley press	49
48.	Platen „ „	50
49.	Lever lead and rule cutter	51
50.	“Bowra” „ „	51
51.	Bodkin	51
52.	Tweezers	52
53.	Shears	52
54.	Plan of composing room	53
55.	Lay of book cases	54
56.	„ news cases	55
57.	Specimen of reversed print	56
58.	Method of holding composing stick	60
59.	„ emptying „	62
60.	„ holding type for distribution	66
61.	Jigger for odd sorts	67
62.	Page gauge	70
63.	Method of tying-up pages	71
64.	Margin of a book defined	84
65.	„ printed sheet defined	85
66.	Making margin	86
67.	„	86
68.	„	86
69.	„	86
70.	„	87
71.	„	88
72.	Type measure	89
73.	Two quoins	89
74.	Section of side-stick, quoin, and chase	89

FIG.	PAGE
75. Forme carriage	91
76. Space box for corrections	91
77. Method of holding corrections in the fingers	92
78. Trays for wood type	97
79. Specimens of "French" rules	98
80. Metal corners for brass-rule work	99
81. Oxford corner	100
82. Metal justifiers for curves and circles	100
83. Brass circle	101
84. Lay of Greek cases	110
85. ,, Hebrew cases	117
86. ,, German cases	124
87. Suggested plan for music cases	128
88. Lever action of Stanhope press	146
89. The Columbian press	148
90. The Albion press	150
91. Chill of Albion in action	151
92. ,, ,, out of action	151
93. Bank and horse	154
94. Cylindrical ink-table	155
95. Brayer ink-table	156
96. Wooden brayer	156
97. Ink slice	156
98. Pedestal ink-table	157
99. Ink knife	157
100. Sheep's-foot hammer	157
101. Hand roller	158
102. Roller frame	159
103. Small roller	159
104. Ink ball	159
105. Roller composition kettle	160
106. Solid roller mould	161
107. Roller mould (open)	162
108. ,, (shut)	162
109. Ink grinding mill	171
110. Printed sheet showing point holes	176
111. Point screw	177
112. Spring octavo point	177
113. Spring twelvemo point	177
114. Chase showing point grooves	178
115. Portable lye-jar	181

FIG.		PAGE
116.	Lye trough	182
117.	Flat pull of cut	<i>interleaf</i> 188
118.	Overlaid pull of cut	189
119.	Bronzing brush	192
120.	Bronzing machine	193
121.	Steam beam engine	201
122.	„ horizontal engine	202
123.	„ vertical engine	203
124.	„ engine and boiler combined	204
125.	Descriptive parts of shafting and rigging	206
126.	Patent lubricator	207
127.	Otto horizontal gas engine	208
128.	„ vertical gas engine	209
129.	Bisschop gas engine	210
130.	Minerva platen machine	217
131.	Distributing ink discs of Minerva	218
132.	Method of centring a sheet	219
133.	Cork lay mark	220
134.	Spring lay marks	220
135.	American gauge-pins for lay	220
136.	Universal platen machine	221
137.	Scandinavian single platen machine	223
138.	Double platen machine	224
139.	The Wharfedale	226
140.	Method of inking for single cylinder machines	227
141.	The perfecting machine	236
142.	The Victory rotary machine	240
143.	The Marinoni rotary machine	242
144.	The Whitefriars rotary machine	244
145.	Hoe's six-feeder machine	246
146.	Double hydraulic press	259
147.	Nipping press	260
148.	Gill's hot-rolling machine	262
149.	Self-clamp cutting machine	264
150.	Card-cutting machine	264
151.	Wetting trough	266
152.	Method of wetting down	267
153.	Poles for drying room	268
154.	Wooden peel	268
155.	Plan of filling-in glazed-boards	269
156.	Section of stabbed book	273

P R I N T I N G.

TYPES.

CHAPTER I.

Letterpress Printing defined—The Production of Type: the Punch, Matrice, and Moulds for Hand and Machine Casting—Component Parts of Metal—Selection of Founts of Type for Wearing Properties and Good Appearance—List of Letters which constitute a Fount—Fractions, Accents, and Signs—Varieties of Old Face, Old Style, and Modern Faces—Italic—Black-letter Founts—Some Jobbing Founts—Distinctive Parts of a Letter—Classification of Letters—The Bodies of Types in Depth—Sizes of Types—Relation of Types to each other in Body—Spaces and Quadrats—Measurements of Type Bodies shown at a glance.

LETTERPRESS printing, or typography, is the art of printing from movable types, the surface of these types being inked and then impressed on to the paper. Another term would be relief printing, in contradistinction to plate or intaglio printing; this latter process, of which this book will not attempt to treat, being obtained by entirely opposite means. For instance, a sheet of copper is taken, and the parts to be printed are cut out, whether separate letters or designs; then, when the plate is finished, it is inked over, the ink being deposited in the hollows or furrows. The surface is then cleaned of superfluous ink. This act is usually performed by a skilful movement of the palm of the hand, care being exercised not to wipe out the ink from the interstices. The paper is then impressed into the

hollows formed in the plate. Thus, whilst relief printing is a method of indentation—the ink being really forced into the paper—the intaglio process leaves the ink somewhat raised on the surface of the finished copy. The following diagram will explain this :



Subsequent pressing or rolling of course removes the indentation or impression from sheets printed by the letterpress method, besides improving the surface. Work executed by the copperplate process is never pressed, as the printing would be “smashed.”

Letterpress printing embraces type, woodcuts, electrotype and stereotype plates—in fact, everything obtained by the relief method.

Practically speaking, the same system is still used in the setting of type as when William Caxton brought to this country the art of printing, and it is only in matters of detail, as concerns the casting and finishing of type, that it has improved. Ever since 1477, when Caxton issued his first book, “*Dictes and Sayings of the Philosophers*,” from Westminster, types have been picked up singly, notwithstanding various attempts to perfect the mechanical appliances invented from time to time for type-setting.

In the olden time printers made their own types, and it was not till the seventeenth century that the arts of letterfounding and printing began to be divided. Moxon, in his “*Mechanical Exercises*,” vol. ii., 1683, is the first practical and the most reliable authority on the subject of the making of types; it is curious to see how the same methods and appliances were in use till quite a recent date in the production of types by hand. It was not until the middle of the nineteenth century that machinery was generally applied to type-casting. This of course was the means

of enormously increasing the output, and consequently reducing cost very considerably. The old plan of hand-casting is still used for the production of small orders or "sorts."

The manufacture of types and a description of the parts of a single letter may appropriately be treated before we

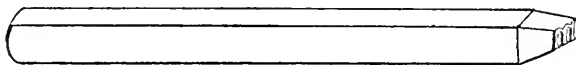

Fig. 1.

commence with the initial stage of printing, *i.e.*, composition of type. To start with, the punch-cutter is provided with a long square piece of steel, on the end of which he proceeds to cut the required letter. A proof is obtained by the aid of smoke as the finishing of the letter advances. By this proof he can see more readily any defects in the shape. When satisfactorily executed it is hardened. This *punch* is somewhat of the shape and size shown here, fig. 1. It is then struck into an oblong bar of copper, thus forming a *matrice* or "*strike*," fig. 2. These matrices can be replaced when worn out, but it is highly important that the utmost care should be taken of the originals. After the matrice is struck, it requires very careful justifying to insure perfect depth and ranging of face, for nothing is so bad as an irregular type in regard to thick and thin lines or an up and down tendency in ranging of line.

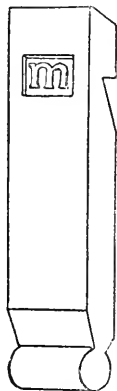

Fig. 2.

The old method of casting by hand was performed by means of a *mould* of two equal portions, figs. 3 (opened) and 4 (shut), closed and fastened by means of a spring loop; this mould was made of wood and lined with iron. Each size of

body required a different mould, but the width could be regulated according to the thickness of letter to be cast.

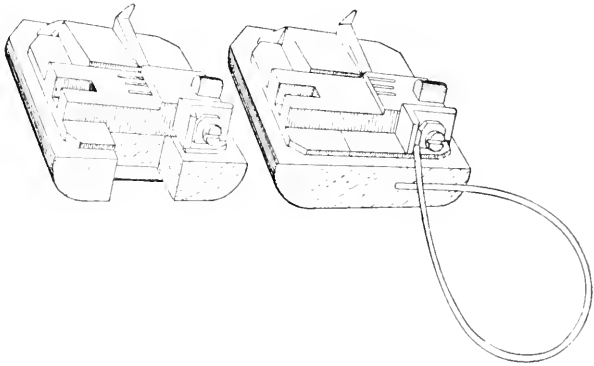

Fig. 3.

The operation of casting, though apparently a simple one, requires experience and judgment, so that the mould be well

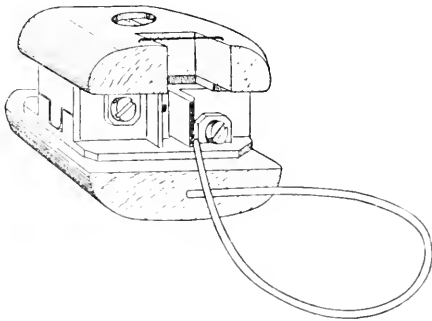

Fig. 4.

filled, and the letter perfect in body and face when finished. To perform this, the mould is filled with the metal heated

up to a given degree, and with a peculiar jerk of the left hand, which holds the mould, the metal is sent right home into the very inmost portions of the matrice, thus giving a perfect cast of the letter. The metal cooling very quickly, the mould is soon opened, and the letter turned out, with a tag of metal at the foot technically called a "*break*," fig. 5. This action is repeated until the required number of letters is made, the matrices being changed as often as a fresh letter is needed. The superfluous metal is then broken off, and the letter rubbed, dressed, and grooved at the foot, after being set up in long lines; most of these latter details being executed by boys.



Fig. 5.

The production of type requires the work of many different persons, but the most important part is that which is carried out at the onset—the punch-cutting.

The mechanical appliances for type-casting have been improved from year to year. These machines, fig. 7, are propelled by means of either hand or power. The same matrices can be used, and a mould adapted for the machine is the only difference. The letters are delivered in a constant stream as cast. Machine type can usually be identified by the round *pin-mark*, fig. 6, on the top side of the letter. Some machines profess to turn the type out already finished, but we cannot recommend them.



Fig. 6.

Type-metal.—The component parts are generally lead, tin, and antimony; this last is used to obtain the requisite hardness and clearness of face, while the tin has the effect of imparting additional toughness to the metal. The proportion of these metals varies according to the size and character of the type to be made. Different

founders have their own particular quantities of each kind, sometimes also introducing other metals, but to a very

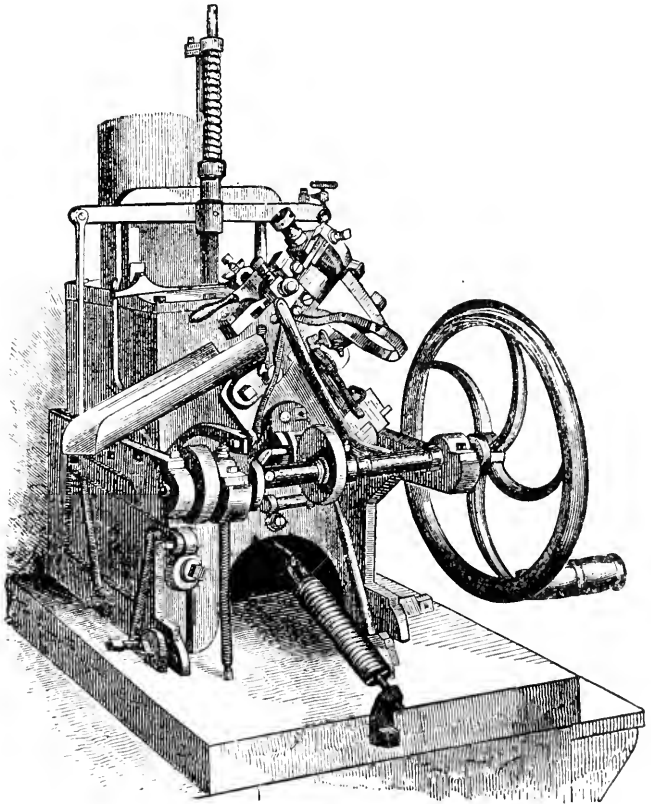

Fig. 7.

limited extent. Of course the metal used for quadrats and "leads" is of a lower standard in composition—lead forming the greatest bulk in all instances, and especially so in

the latter. In the so-called hard metals, the proportion of tin and antimony is increased, and sometimes copper is added, but very sparingly. For ordinary purposes the following recipes will be found serviceable :

Moxon :

To 28 lb. metal, 25 lb. lead and 3 lb. of iron and antimony mixed.

Besley :

100 lead, 30 antimony, 20 tin, 8 nickel, 8 copper, 5 cobalt, and 2 bismuth.

Various others :

55 lead, 22·7 antimony, 22·3 tin.

61·3 lead, 18·5 antimony, 20·7 tin.

69·2 lead, 19·5 antimony, 9·1 tin, and 1·7 copper, according to the amount of hardness desired.

Selection of types.—For good wear and tear, the following points are recommended for consideration: (*a*) That the metal is of such hardness as not to be brittle, and that attention is paid to the size of the type in proportion to the thickness and thinness of its lines. (*b*) That there is a good depth in face; cheap founts of type offered by some founders are sometimes cast from electrotyped matrices, and not from those which are struck from punches, and therefore are more shallow in face. (*c*) That the body is perfectly square and even. (*d*) That there is a good nick or nicks to the fount, to prevent possible mixing with other types, and for facilitating composing. (*e*) That the whole fount, roman and italic, is perfect in ranging; and in ordering additions from time to time, see that the different letters are also in line. (*f*) That the overhanging or kerned letters are well supported from the shank of the letter, to prevent breaking off when giving an impression.

Founts of type are made up to certain scales, called "bills" by type-founders. Taking a complete roman

fount of say 1,000 lbs. weight, the lower-case vowels would be made up according to the average use in the English language for an ordinary work; the consonants would be based on this plan too, and the capitals and letters in proportion. Quadrats and italic would be included in a complete fount to the extent of ten per cent. each. There are also schemes for French and other foreign languages. This obviates the possibility of having any great number of letters left on hand when the type has been all set up, unless the matter composed is of an exceptional nature. If such is the case, "sorts" must be ordered to level the fount. The following list comprises all the sorts usually supplied with a roman fount; other letters would be extra, and come more properly under the head of "signs" or "peculiarities":

Capitals. A B C D E F G H I J K L M N O P
Q R S T U V W X Y Z Æ Œ

Small Capitals. A B C D E F G H I J K L M N O P
Q R S T U V W X Y Z Æ Œ

Figures. 1 2 3 4 5 6 7 8 9 0

Accents, diæresis. ä ë ï ö ü

„ *acute.* á é í ó ú

„ *grave.* à è ì ò ù

„ *circumflex.* â ê î ô û

Reference marks. * † ‡ § || ¶

Lower case. a b c d e f g h i j k l m n o p q r s t u v w
x y z æ œ fi ff fl'fli fl

Points. , . ; : ! ? ' - () [] — ... — — —

Miscellaneous. & £ / ç 

Spaces. Hair, thin, middling, thick.

Quadrats. En, em, one, two, three and four ems.

Fractions and additional accents are sometimes added, but these are best apart and laid in separate cases. Italic founts as a rule do not have small capitals, and the figures are usually the same as the roman, with some few exceptions.

Fractions are generally cast in two ways—"whole" and "split." The former are fractional figures cast in one piece, $\frac{1}{4}$ $\frac{1}{2}$ $\frac{3}{4}$, and the latter those cast on half bodies, $\frac{1}{4}$ $\frac{1}{2}$ $\frac{3}{4}$, &c. The split method allows of many combinations which are hardly possible when the figures are cast in one piece.

Accents, beyond those given in the synopsis of an ordinary fount, consist of many varieties. Some of those in most general use are :

Long. ā ē ī ō ū

Short. ǎ ě ĭ ǒ ů

Various. ã ĝ ñ ñ p̃ p q, &c.

Signs are of different kinds too numerous to mention in detail. They are grouped under the heads of commercial, astronomical, mathematical, algebraical, geometrical, &c. The explanation of these is outside the scope of this work.

All these signs and peculiars can be obtained in most bodies. The utmost care should be taken of them in keeping them distinct and in separate cases.

Book-founts may be classed generally as of three kinds, namely, (a) the *old faced*; (b) the revived *old style*, of somewhat lighter face and more regular appearance; (c) the *modern* face. Each variety has its distinctive character of italic, and the modern faces are subject to a great number of designs, some better than others. We here give, in pica, a specimen of each kind :

Old face. A B C D E F G H I J K L M N O P Q R S T

U V W X Y Z Æ Æ

A B C D E F G H I J K L M N O P Q R S T U V W X Y Z Æ Æ

1 2 3 4 5 6 7 8 9 0

a b c d e f g h i j k l m n o p q r s t u v w x y z æ œ ð ð ð ð ð

A B C D E F G H I J K L M N O P Q R S T

U V W X Y Z Æ Æ

a b c d e f g h i j k l m n o p q r s t u v w x y z æ œ ð ð ð ð ð ð ð

Old style. A B C D E F G H I J K L M N O P Q R

S T U V W X Y Z Æ Æ

A B C D E F G H I J K L M N O P Q R S T U V W X Y Z Æ Æ

1 2 3 4 5 6 7 8 9 0

a b c d e f g h i j k l m n o p q r s t u v w x y z æ œ ð ð ð ð

A B C D E F G H I J K L M N O P Q R

S T U V W X Y Z Æ Æ

a b c d e f g h i j k l m n o p q r s t u v w x y z æ œ ð ð ð ð ð ð ð

Modern. A B C D E F G H I J K L M N O P Q R S T

U V W X Y Z Æ Æ

A B C D E F G H I J K L M N O P Q R S T U V W X Y Z Æ Æ

1 2 3 4 5 6 7 8 9 0

a b c d e f g h i j k l m n o p q r s t u v w x y z æ œ ð ð ð ð

A B C D E F G H I J K L M N O P Q R S

T U V W X Y Z Æ Æ

a b c d e f g h i j k l m n o p q r s t u v w x y z æ œ ð ð ð ð ð ð ð

The difference in the *figures* should be particularly observed—the old face and old style having the quaint ascending and descending strokes, the modern ranging at the top and bottom :

1234567890 = 1234567890

Occasionally the old figures are used with modern founts, but we think it advisable that they should be kept as distinct as possible.

It is somewhat interesting to remember, with regard to *italic*, that these characters were invented by Aldus Manutius, a Venetian printer who flourished in the fifteenth century, and that roman capitals were first used with the italic lower-case. The italic used by Aldus is usually supposed to have represented the handwriting of Petrarch,¹ and assumed a much more running or scroll-like character than that used nowadays.

The following types of Messrs. Caslon and Co. give an idea of some of the old italic founts, with the tails and flourishes :

A B C D E F G H I J K L M N O P Q R

S T U V W X Y Z Æ Œ

a b c d e f g h i j k l m n o p q r s t u v w x y z æ œ

The somewhat fanciful capitals were sometimes called “swash” letters.

Black-letter next requires our consideration, and the five samples added here will give some idea of the different faces of that character in use :

¹ See “A History of the Old Letter Foundries,” T. B. Reed.

Caxton, 15th century.

A B C D E F G H I J K L M
 N O P Q R S T U V W X Y Z
 a b c d e f g h i j k l m n o p q r s t u v w x y z

Old English, 16th century.

A B C D E F G H I K L M N O
 P Q R S T U V W X Y Z
 a b c d e f g h i j k l m n o p q r s t u v w x y z

Tudor, 17th century.

A B C D E F G H I K L M N O P
 Q R S T U V W X Y Z
 a b c d e f g h i j k l m n o p q r s t u v w x y z æ œ

Old Flemish, 18th century.

A B C D E F G H I K L M N
 O P Q R S T U V W X Y Z
 a b c d e f g h i j k l m n o p q r s t u v w x y z

Modern-faced Black Letter, 19th century.

A B C D E F G H I K L M N
 O P Q R S T U V W X Y Z
 a b c d e f g h i j k l m n o p q r s t u v w x y z æ œ

The dates given are only approximate, but the types convey a good impression of the black-letters in use at the various periods.

Jobbing types are to be obtained of all kinds, some good, others bad or indifferent, and we propose to show only a few of those faces mostly in demand, which may fairly be considered to meet with general approval. Unfortunately the fanciful names applied to these types cannot be always relied on, for some letter-founders may have the same or similar characters in their specimen-books, but designated by an entirely different name. Broadly speaking, the thicker-faced type used in dictionaries to give emphasis to the reference word is classed as "Clarendon," whereas the older and uglier form of fat-faced letter is termed "Egyptian." But what one founder would call "Clarendon," another perhaps would name "Antique," and this applies to many of the fancy or jobbing founts in use at the present day. Some of these founts have lower-case allied to them, but, in order to make the difference more plain between some of the different styles, we give the capitals at one glance, including again the old face, old style, and plain roman capitals.

Judgment must be exercised in acquiring these founts. It is a good rule to order a whole series of one class of face rather than to be inconvenienced by the sole use of one, or even two, sizes of any particular character. Select your types from those made by the well-known firms, and thus avoid the possibility of having founts cast from electro-type matrices.

As before said, fancy types are offered in all conceivable shapes and sizes, and it is impossible to give here specimens of every variety, but the few shown overleaf will give a general idea of the principal styles.

Old face.

ABCDEFGHIJKLMNOPQRSTUVWXYZÆ

Old style.

ABCDEFGHIJKLMNOPQRSTUVWXYZ

Modern.

ABCDEFGHIJKLMNOPQRSTUVWXYZÆ

Old roman.

ABCDEFGHIJKLMNOPQRSTUVWXYZ

Latin elongated.

A B C D E F G H I J K L M N O P Q R S T U V W X Y Z Æ Æ

Clarendon.

ABCDEFGHIJKLMNOPQRSTUVWXYZÆÆ

Egyptian.

ABCDEFGHIJKLMNOPQRSTUVWXYZ

Antique Old style.

ABCDEFGHIJKLMNOPQRSTUVWXYZ

Antique.

ABCDEFGHIJKLMNOPQRSTUVWXYZÆ

Sans serif.

ABCDEFGHIJKLMNOPQRSTUVWXYZ

Ornamented.

ABCDEFGHIJKLMNOPQRSTUVWXYZ

These types, where classed as "jobbing," are frequently made up in small founts on the "Aa" plan, that is, assuming it is a "4A 20a" size of fount, the remaining capitals and lower-case letters would be given in proportion, thus :

4A 20a FOUNT.					36A 70a FOUNT.						
A	4	a	20	1	5	A	36	a	70	1	16
B	2	b	8	2	5	B	16	b	24	2	12
C	3	c	12	3	4	C	22	c	34	3	12
D	3	d	16	4	4	D	20	d	36	4	12
E	5	e	35	5	4	E	42	e	92	5	12
F	2	f	8	6	4	F	18	f	24	6	12
G	2	g	8	7	4	G	18	g	24	7	12
H	3	h	16	8	5	H	22	h	44	8	12
I	4	i	20	9	4	I	36	i	70	9	12
J	2	j	5	0	6	J	10	j	16	0	16
K	2	k	6	£	1	K	10	k	12	£	5
L	3	l	16	&	5	L	22	l	44	&	10
M	3	m	12	fi	—	M	20	m	32	fi	7
N	4	n	20	ff	—	N	36	n	70	ff	7
O	4	o	20	fl	—	O	36	o	70	fl	5
P	3	p	12	ffi	—	P	20	p	26	ffi	4
Q	2	q	5	ff	—	Q	8	q	10	ff	4
R	4	r	20	,	20	R	36	r	70	,	50
S	4	s	20	;	4	S	36	s	70	;	14
T	4	t	20	:	4	T	36	t	70	:	12
U	2	u	12	.	20	U	20	u	34	.	50
V	2	v	8	-	8	V	10	v	12	-	18
W	2	w	8	'	8	W	12	w	20	'	24
X	2	x	4	!	4	X	8	x	10	!	14
Y	2	y	8	?	3	Y	12	y	24	?	12
Z	2	z	4			Z	8	z	10		
Æ	1	æ	1			Æ	3	æ	4		
Œ	1	œ	1			Œ	3	œ	4		

Going back to book-founts, there is one important consideration in purchasing a new fount, that is, its thickness.

A fount is considered of fair size when the whole alphabet of twenty-six letters, lower-case *a* to *z*, extends to or exceeds twelve em of its own body, thus :

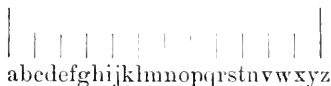

If the alphabet comes within the twelve ems, an extra charge is involved, according to a provision in the scale of prices for composition, and it consequently ranks as a "thin fount." Therefore it is necessary that a purchaser should be careful in selecting a new fount, in order to obviate this extra charge being made.

In type-founder's language each portion of a single letter has a distinctive name, as shown in the following sketch, fig. 8 :

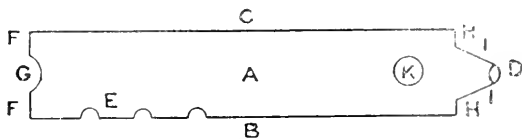

Fig. 8.

- | | |
|------------------------------|------------------------------|
| <i>a</i> The body or shank. | <i>f</i> The feet. |
| <i>b</i> The belly or front. | <i>g</i> The groove. |
| <i>c</i> The back. | <i>h</i> The shoulder. |
| <i>d</i> The face. | <i>i</i> The bevel or beard. |
| <i>e</i> The nicks. | <i>k</i> The pin-mark. |

A *kern* is that part of a letter which overhangs its body, as in a lower-case *f*. This is frequently met with in italic founts, owing to the sloping nature of the characters. *Serifs* are the fine lines on the top and bottom of letters; the two samples show respectively a letter with and without serifs :

H H

The faces of letters, taking lower-case as an illustration, are classified into four divisions:

Short letters.

a c e m n o r s u v w x z

Long letter.

j (this occupies the whole depth of face).

Ascending letters.

b d f h i k l t

Descending letters.

g p q y

The capitals, and figures too (in a modern fount), would be described as ascending letters, whereas the small capitals would be classed as short. The only exception to these rules would be the capital Q, which would be a long letter, as in the case of the lower-case j.

Bastard founts, or founts in which the face is of one size while the body is of another, are sometimes cast to obviate the necessity of leading works. They economize the cost of composition, because in casting-up, supposing the type has a small pica face on a pica body, it would reckon as only small pica in width, but pica in depth. It is usual to have the face one remove only from the size of body, but of course there are exceptions to this rule.

Nicks in English types are on the front or belly of the letter, but the system of the French and most other continental nations is to have the nick on the back, and their standard as regards "height to paper," *i.e.*, the height as the letter stands from the feet to the face, is slightly higher than ours. Indeed, our heights vary slightly according to

the several founders, but the difference is infinitesimal. It is a matter for regret that the depths of bodies are not always the same in this country, and it is hoped that some steps will be taken to remedy this state of affairs. Roughly speaking, the height of type is equal to a shilling standing on its edge.

Taking the five leading founders of the present day,¹ we find the standard of pica is about the same, 72 to the foot, but the other sizes vary, especially the long primer, as the following will show :

Caslon and Co.	89·5 to the foot.
Figgins	90 „
Miller and Richard	} 89 „
Stephenson, Blake, and Co. }	
Reed and Sons	92 „

The remaining sizes are dependent very largely on these variations in long primer.

Some of the type-founders will cast founts to order on a body which is not their standard, and one firm at least is open to cast on the American principle of type bodies, *i.e.*, points, which may be explained as follows : Pica is the basis of twelve points, and the other sizes are removed from that number by one point, or half points in the smaller sizes, at a time. This scheme is very practicable, and, in the absence of any other, is commendable.

The following specimen page of types of Messrs. Miller and Richard's old style will give the difference in face of most of the sizes enumerated later on ; the exact depth of body is given at the side.

¹ Caslon and Co. ; V. and J. Figgins ; Miller and Richard ; Stephenson, Blake, and Co. ; and Sir Charles Reed and Sons.

- Canon is the
- Two-line Great Pr
- Two-line English is
- Double Pica is the size of
- Great Primer is the size of this typ
- English is the size of this type, which is
- Pica is the size of this type, which is equivalent
- Small Pica is the size of this type, which is equivalent
- Long Primer is the size of this type, which is equivalent to
- Bourgeois is the size of this type, which is equivalent to two of
- Brevier is the size of this type, which is equivalent to two of Gem, or
- Minion is the size of this type, which is equivalent to one half of English, or
- Nonpareil is the size of this type, which is equivalent to one half of Pica, or one
- Ruby is the size of this type, which is equivalent to one half of Small Pica, or one quarter of
- Pearl is the size of this type, which is equivalent to one half of Long Primer, or one quarter of

The following table gives the names of the types in general use, with their nominal relation to each other. Where blanks are left there are no real equivalents :

Minnikin			
Brilliant			
Gem	<i>is</i> half of Brevier		
Diamond	half of Bourgeois		
Pearl	half of Long Primer		
Ruby	half of Small Pica		
Nonpareil	half of Pica		
Emerald	half of Two-line Emerald		
Minion	half of English		
Brevier	half of Two-line Brevier	<i>or</i> two of Gem	
Bourgeois	half of Great Primer	two of Diamond	
Long Primer	half of Paragon	two of Pearl	
Small Pica	half of Double Pica	two of Ruby	
Pica	half of Two-line Pica	two of Nonpareil	
English	half of Two-line English	two of Minion	
Great Primer	half of Two-line Great Primer	two of Bourgeois	<i>or</i> four of Diamond
Paragon	half of Two-line Paragon	two of Long Primer	four of Pearl
Double Pica	half of Two-line Double Pica	two of Small Pica	four of Ruby
Two-line Pica	half of Canon	two of Pica	four of Nonpareil
Two-line English	two of English	four of Minion	
Two-line Great Primer	two of Great Primer	four of Bourgeois	eight of Diamond
Two-line Paragon	two of Paragon	four of Long Primer	eight of Pearl
Two-line Double Pica	two of Double Pica	four of Small Pica	eight of Ruby
Canon	two of Two-line Pica	four of Pica	eight of Nonpareil

Larger sizes of type are made, but they are designated by the number of picas the body is equal to, such as five-line, six-line, &c. Founts are generally cut in wood when they reach eight or nine lines of pica in depth of body.

Spaces of various degrees, used generally to divide words, and quadrats to fill up short lines, which are cast to regular sizes, complete a fount in the ordinary way. Hair spaces, the thinnest of all, are cast perhaps eight to an em of their own body; sometimes they are made thinner or thicker. Taking long primer, in which this work is printed, as our standard, the spaces here shown give the width :

hair space	thin space	middling space	thick space
8 to em	5 to em	4 to em	3 to em

Quadrats of the same body :

en	em	2 em	3 em	4 em
■	■	■	■	■

The following suggestions may be of service:

Hints on Ordering Sorts.—The following table contains a rough estimate (taking Brevier as a standard) of the amount which the respective boxes of the regular full-sized lower case will contain; the first two columns give the letters and weight only, the last two columns the letters and number that will weigh a pound.

Letters.	Weight to Box.	Letters.	No. Letters to lb.
a c d i s m n h o u t r	2 lbs.	a b d g h k n o p q u v x y z	582
f b l v g y p w	15 oz.	c e r s t	682
k j z x q and figures	6 oz.	m	398
e	3 lbs.	f i j l	850
Capitals	5 oz.	Periods and Commas	1400

Weight of Type Required for a Job.—To find this, divide the area of the page expressed in pica ems by 128. The answer gives the number of lbs. weight in the page. 50 per cent. for small founts, and 30 to 40 per cent. for large founts, should be added to allow for sorts, &c.

Example: I have to set fifty pages of Brevier octavo, the size of the page in pica ems being 20×34 . What weight of type should I order?

The area of each page is 20×34 , equal to 680 ems pica; divide by 128 and multiply by the number of pages, 50. The result is 266 nearly. Add 40 per cent., and the sum will be 372 lbs. *Ans.*

A Square Inch of Type.—It is not always, when asked for an estimate, that the printer has at hand the means of making it. He has mislaid his graduated scale, or the matter to be cast off is in awkward batches. A ready method, however, has been suggested. It has been calculated that a square inch of pica contains 36 ems; of small pica, 49 ems; long primer, 56 ems; brevier, 86 ems; minion, 100 ems; nonpareil, 144 ems; and ruby, 196 ems. Any fractions in the calculations are in favour of the printer.

The following plan gives some of the type bodies at a glance, Messrs. Miller and Richard's standards being used. Every fifth line is numbered, and each column is two ems wide of its own body.

Great Primer	English	Pica	Small Pica	Long Primer	Bout- geois	Brevier	Minion	Nonp.	Ruby	Pearl	Diam'd
											5
								5	5		10
			5	5						5	15
5	5	5									20
				10							25
		10									30
	10										35
			15								40
10											45
		15									50
	15										55
			20								60
				25							65
											70
		25									75
			30								80
20	25										85
				35							90
		30									95
			35								100
					45						105

COMPOSITION AND DISTRIBUTION.

CHAPTER II.

Materials, Tools, and Appliances used—Varieties of Frames and Cases—Different kinds of Composing Sticks, Setting Rules, and Galleys—Leads—Brass Rules of Plain and Fancy Character—Furniture, Wooden and Metal—Quoins—Patent Locking-up Apparatus—Mallet, Planer, and Shooting Sticks—Chases, Imposing Surfaces, Forme and Letter-Board Racks—Galley Proof Presses—Rule and Lead Cutters—Bodkin, Tweezers, and Shears.

BEFORE proceeding to the matter of type-setting, it is necessary to give some idea of the materials, tools, and other appliances required in this department, and the illustrations here given, with short descriptions, will make clear the use to which they are put.

To commence with, we have the *composing frames* of various kinds. These are made of deal, and stand breast-high, forming a stand to hold the type-cases at a proper angle for the most comfortable position in picking-up types. These frames are generally made with a rack to hold the cases not in immediate use, but likely to be required. The *double frame*, fig. 9, has two sets of racks for cases, which hold five pairs in each, making a total of twenty cases in all. This is a good and serviceable frame where rack-room is a consideration.

The *whole frame*, fig. 10, is one, however, more in general use; it has only one case-rack, which holds five pairs, and the frame-stand itself is somewhat shorter. The re-

maining portion of the frame is occupied by a shelf called a bed, which is very handy for surplus sorts turned out in distribution, and for other things. This frame holds two pairs of cases up for immediate use, as does the double frame.

The *three-quarter frame*, fig. 11, is a little longer than

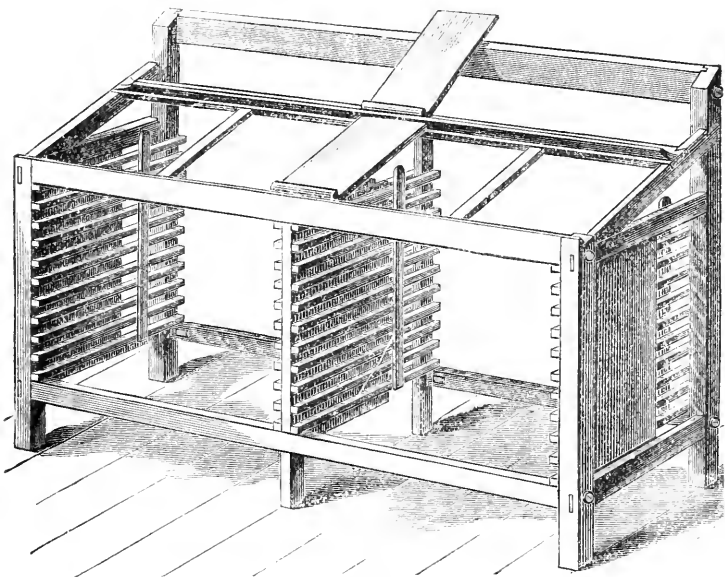

Fig. 9.

the half-frame, and holds up one pair of cases, having a case-rack for five pairs not in actual use.

The *half-frame*, fig. 12, is simply a small stand for one pair of cases up, with no case-rack. This frame is useful for holding italic cases on, because it can stand in any out-of-the-way corner, where there is not sufficient room for a double frame. There are in addition to these, several other kinds

of frames made for making-up purposes, called *random frames*, and others with special drawers or cupboards constructed to order.

Type-cases themselves are usually made of teak, and the bottom board of the case is lined with smooth white paper before the divisions forming the boxes are fastened on. By this means the cases are kept cleaner, and made more com-

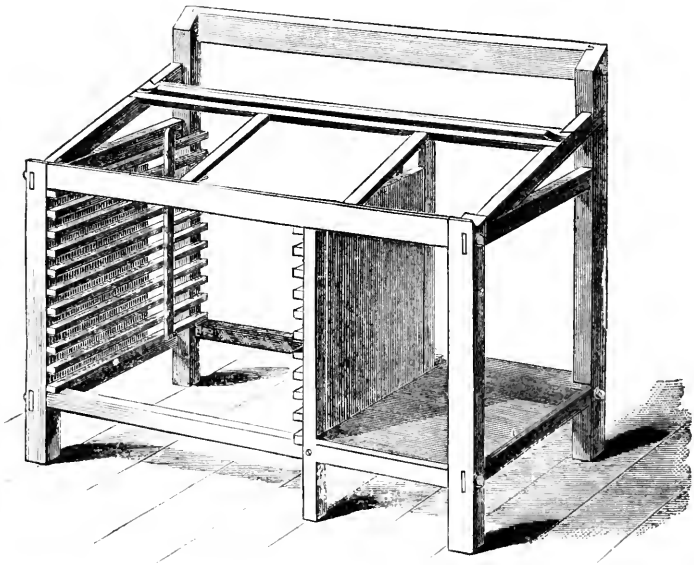

Fig. 10.

fortable for picking up the type when the letter is set low. There are two cases used for ordinary book-work, called *upper* and *lower* case, which contain the capitals and small letters respectively. Though English cases are always made with the same number of boxes or divisions, the "lay," of which we shall speak presently, varies according to fancy and requirement for any particular class of work. The upper case

has 98 boxes, and the lower case 53 boxes. The *e* is allotted the largest box in the lower case, and the other vowels and consonants most frequently used are placed in the next size of division. These boxes are situated according to the demand for the different letters in setting-up ordinary works. For instance, the compositor stands at the centre of his case, and of course it is reasonable to suppose that those letters

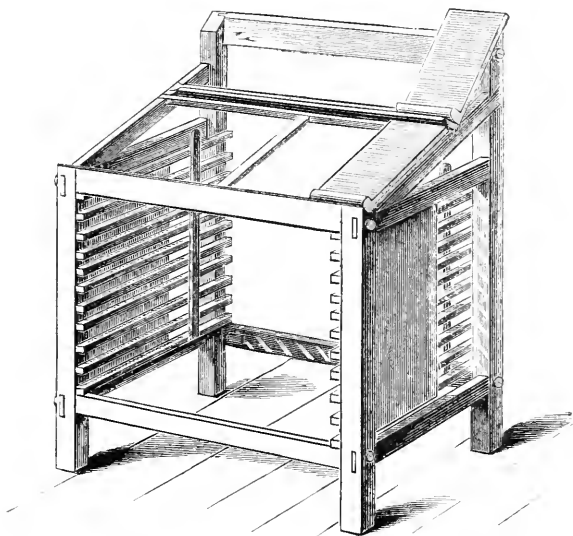

Fig. 11.

most frequently in use, as the vowels and consonants *t n d h*, should be nearest to his picking-up hand, in order to save time in conveying the letter from the box to the composing stick. The diagrams, figs. 13 and 14, show the plan of the ordinary upper and lower cases.

For jobbing purposes special cases are used, and, amongst others, *double* cases, fig. 15, and *treble* cases, fig. 16, are

manufactured, and found very useful. Other varieties are made for four or six founts in one case, and some for brass

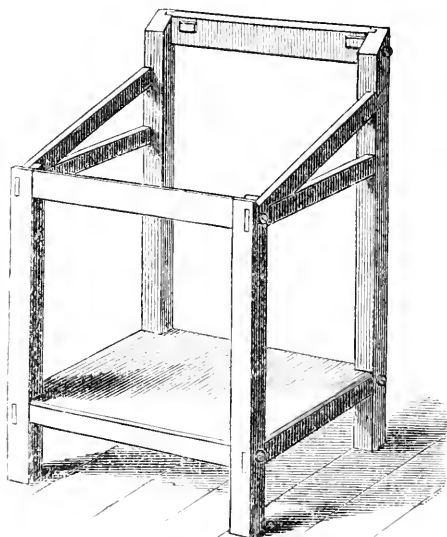

Fig. 12.

rule and leads. Hebrew, Greek, and other classical or

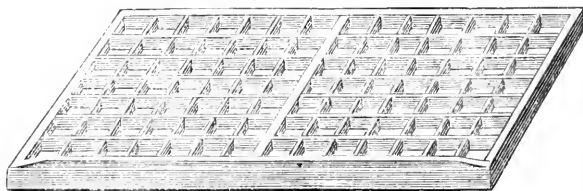

Fig. 13.

oriental languages require cases of different construction as regards the boxes.

The *composing stick* is the tool used for type-setting, fig. 17. It is made in various metals, but generally of iron or gun-metal for book-work. For newspaper work

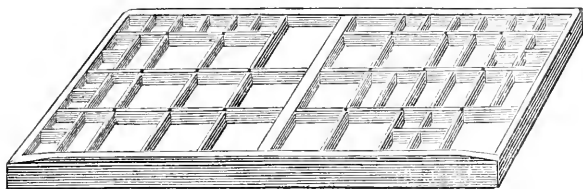

Fig. 14.

a short mahogany stick is employed, lined with metal, and

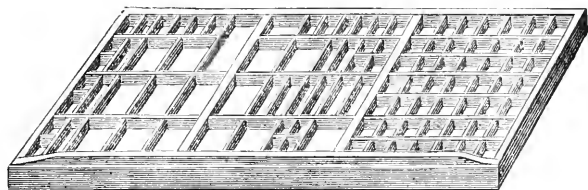

Fig. 15.

the measure is of course fixed. For poster or broadside

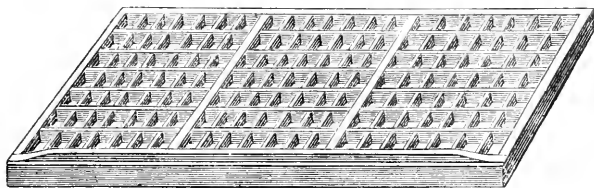

Fig. 16.

work long sticks made entirely of a hard wood are used. To the metal book-work composing sticks a movable slide is attached, which can be adjusted to any measure

within the length of the stick. These slides are fastened usually by means of a slotted head-screw, as in fig. 17, but for jobbing purposes a lever, fig. 18, or thumb-screw, fig. 19,

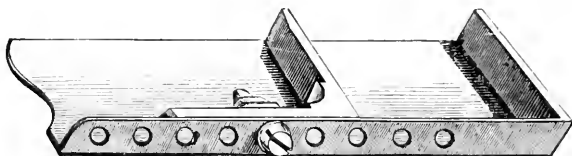

Fig. 17.

is sometimes substituted; these allow of more rapidly changing the measure. The illustrations show the varieties



Fig. 18.

in use. Fig. 20 is a mahogany stick lined with metal, usually brass, and fig. 21 is a long wooden stick for broadside or poster work.

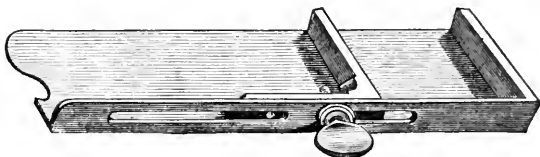

Fig. 19.

In connection with the composing stick we have the *setting rule*, fig. 22, which is placed within the stick for the type to lie against as it is being set. It is generally made of four-to-pica brass rule with a knib or nose-piece at end, to

allow of its being more readily lifted out and placed in front of the line just set and justified. Its use is to facilitate the

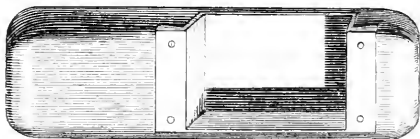

Fig. 20.

setting of the type, as it permits the letter, when placed in the stick, to slide more readily into its position, and as each

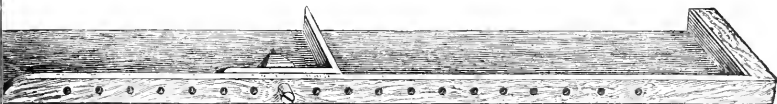

Fig. 21.

line is composed it is placed in front of the one just finished. It also assists in emptying the stick on to the galley—especially when the matter is set “solid,” *i.e.*, without leads.



Fig. 22.

It may be said here that “matter” is a synonym for composed type, and also that “setting” is equivalent to the act of composing.

When the stick is full, it has to be emptied on to a *galley*, fig. 23. These receptacles are generally made of mahogany for book-work, and for news-work or slip matter of brass, or more frequently of zinc. In the wooden kinds we have slip, octavo, quarto, and folio galleys. It is desirable that well-seasoned wood be obtained, for they are very apt to get twisted or warped. Old wainscoting makes an admirable galley in all respects.

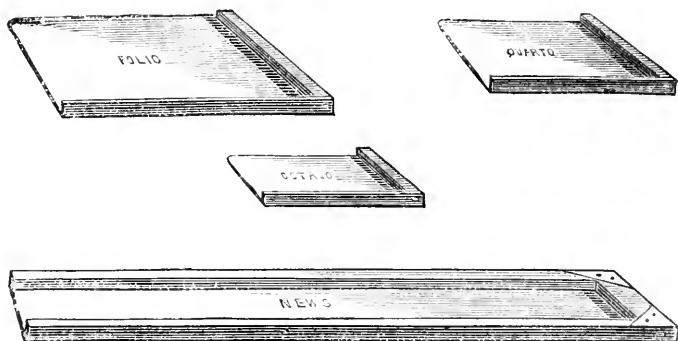

Fig. 23.

Leads are slips of metal cast to different thicknesses and cut to various lengths; these are used for placing between the lines if the work is required to be "leaded." They are made of less brittle metal than type, and are therefore more pliable. They are cast so many in thickness to a pica, from four to sixteen to a single em of pica body. Technically speaking, a *thick lead* is four to pica; a *thin lead* eight to pica; and *hair leads* perhaps fourteen or sixteen to a pica. Besides these sizes there are twelve, ten, and six to pica leads. Leads are cut to pica ems in length, except in the case of special half-measures, that is, a given number of ems with an en added for double column matter of a narrow measure. The following schemes are handy for ordering quantities :

NUMBER OF LEADS IN A POUND.

Lengths.	4 to Pica.	6 to Pica.	8 to Pica.	Lengths.	4 to Pica.	6 to Pica.	8 to Pica.
4 ems	144	216	288	26 ems	22	33	44
5 ems	112	168	224	27 ems	21	31	42
6 ems	96	144	192	28 ems	20	30	40
7 ems	82	123	164	29 ems	20	30	40
8 ems	72	108	144	30 ems	19	29	38
9 ems	64	96	128	31 ems	19	28	38
10 ems	56	84	112	32 ems	18	27	36
11 ems	52	78	104	33 ems	17	26	34
12 ems	48	72	96	34 ems	17	25	34
13 ems	44	66	88	35 ems	16	24	32
14 ems	41	61	82	36 ems	16	24	32
15 ems	38	57	76	37 ems	15	23	30
16 ems	36	54	72	38 ems	15	22	30
17 ems	34	51	68	39 ems	15	22	30
18 ems	32	48	64	40 ems	14	21	28
19 ems	30	45	60	41 ems	14	21	28
20 ems	28	42	56	42 ems	14	21	28
21 ems	27	40	54	43 ems	13	20	26
22 ems	26	39	52	44 ems	13	19	26
23 ems	25	37	50	45 ems	13	19	26
24 ems	24	36	48	46 ems	12	18	24
25 ems	23	34	46	47 ems	12	18	24

Weight of Leads Required for a Job.—Multiply the number of lines in a page by the number of pages to be leaded, and divide the product by the number of leads of the measure required that go to the lb.

Example: I have to lead (8-to-pica) 24 pages of matter set to 21 ems pica, there being 35 lines to the page. How many pounds of leads shall I want? In the table I find 54 8-to-pica leads, 21 ems long, go to the lb. Therefore I divide 35×24 by 54 and get 15 lbs. 10 oz. *Ans.*

Note: It would be as well to order 20 lbs., cut to the right measure, to be sure of having enough.

Brass rules, fig. 24, are thin strips of rolled brass made type high in lengths of 18 and 24 inches, and in various thicknesses and patterns. In addition to the faces given many other varieties can be had, and many combinations can be made by using two or more patterns together.

Column rules are sometimes made on large bodies, such as pica; this obviates the use of leads in forming the white on either side of the rule—an advantage in newspaper work. For short lengths the *special case*, fig. 25, is recommended.

Furniture and reglet, both wood and metal, is used for

45		46			46½		45½
44		47			47½		44½
43		48			48½		43½
42		49			49½		42½
41		50			50½		41½
40	21	20	1	11	20½	21½	40½
39	22	19	2	2½	19½	22½	39½
38	23	18	3	3½	18½	23½	38½
37	24	17	4	4½	17½	24½	37½
36	25	16	5	5½	16½	25½	36½
35	26	15	6	6½	15½	26½	35½
34	27	14	7	7½	14½	27½	34½
33	28	13	8	8½	13½	28½	33½
32	29	12	9	9½	12½	29½	32½
31	30	11	10	10½	11½	30½	31½

Fig. 25.

forming the margins round the printed matter of a book, and to assist in bulking out the pages when imposed in the chase.

Wooden furniture is, perhaps, more generally used. It is made of well-seasoned oak, and supplied in yard lengths by the manufacturers. The term “furniture” is applied to that of the larger kind, from three ems thick and upwards. Reglet is made in various thicknesses, the same length as furniture, and generally equivalent to the bodies of types from Nonpareil up to Two-line Great Primer. Confusion is likely to arise if too many sizes are used, as the edges are sure to

wear round quickly, and then it is a difficult matter to distinguish the thickness. The best for general use are Nonpareil, Long Primer, Pica, Great Primer, Double Pica, Two-line English, and Two-line Great Primer.

For obtaining register, *i.e.*, accurately adjusting the position of pages which are printed back to back, *scaleboard* is

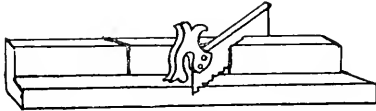

Fig. 26.

used, made of wood and of the same thicknesses as leads. Furniture is manufactured in three picas (technically called narrow), four picas (broad), six picas (double narrow), seven picas (broad and narrow), and eight picas (double broad). Both reglet and furniture are cut up into short lengths as required by means of *saw* and *block*, fig. 26.

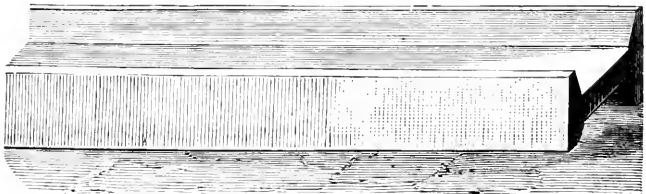

Fig. 27.

Great advantage is derived by using *metal furniture*, fig. 27. In addition to securing greater truth and solidity, a considerable return is made for the old metal when broken or battered.

All furniture which has become defective by wear and tear or warping, should be discarded, as it is likely to give

trouble in obtaining register, and also to prevent the forme from being locked-up securely.

Foot and side-sticks, fig. 28, are also classed under the general head of furniture. They are generally made of oak when in wood, but sometimes metal is used, and then chiefly iron. These last are cast and planed on the side which is



Fig. 28.

placed nearest the type, and made to sizes. Wooden ones are made in long lengths and cut down as required, the thin end being cut at an angle of say 45 degrees, and the outer edges of the two outer ends just pared or chamfered to prevent the corners being split up. As seen in the diagram, one side only is sloped, to allow of the quoin, which has a corresponding slope on one side, being fastened squarely and tightly when locked-up.

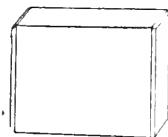

Fig. 29.

Quoins.—Those used for general work are made of wood—usually sycamore; they are sold by the 1,000, and each bag contains an assortment of various sizes. These assortments are still further divided or classified respectively as jobbing, book, and news—the last-mentioned containing those of the larger kinds, whereas the others run smaller on the average. As explained before, one side of the quoin, fig. 29, is square, and the other sloped to correspond with the same angle of the side or foot-stick, the corners being also pared and chamfered. The shape may be likened to a wedge. The object of quoins is to “lock up” or fasten the pages in the chase, that the whole may lift as a “forme.”

There are many mechanical appliances in the market for locking-up, and they are recommended especially for works of a regular size, but the prices of these improved systems are somewhat prohibitive for general work. For news-work *screw chases* are very handy. These chases are made specially as regards size. A thread tapped in the edge of the chase allows of a screw or screws being placed in and fastened up to the side or foot-stick. One kind is that shown in the following diagram, fig. 30.

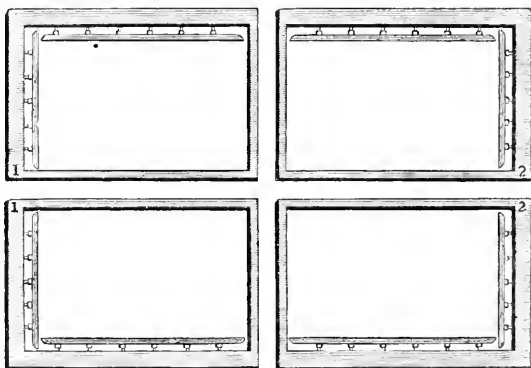

Fig. 30.

The *Marinoni* system, fig. 31, consists of a nut tightened up by means of a key; its application can be seen at a glance. *Ward's* patent, figs. 32 and 33, is of an entirely different kind, the fastening-up being obtained by the old method of mallet and shooting stick. The ordinary metal side or foot-stick is used, and the quoin is really another stick of similar length, but cast as it were like a series of connected quoins. This plan gives a more equal pressure all along, but care should be exercised in first starting the locking-up, or undue pressure may be given at the driving end. All these patented apparatus are made of

iron. As before said, for miscellaneous work the old-

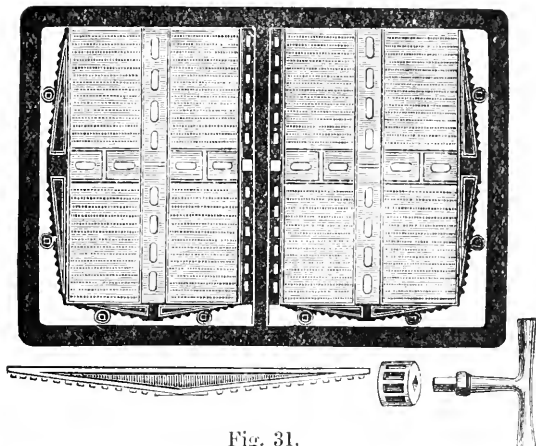

Fig. 31.

fashioned wooden quoin is after all the most useful, and it

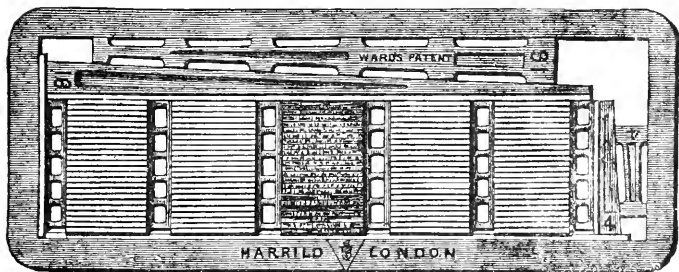

Fig. 32.



Fig. 33.

is an open question whether the formes are not really more secure with them if properly fitted and locked-up—pro-

vided the formes are well looked after in hot weather, as the quoins are apt to shrink.

For levelling and fastening up the type in chases sundry

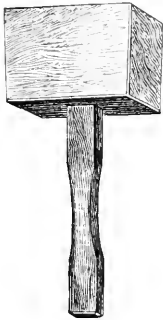

Fig. 34.

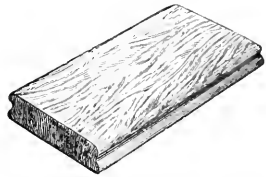

Fig. 35.

tools are used, among them the *mallet*, fig. 34, and *planer*,

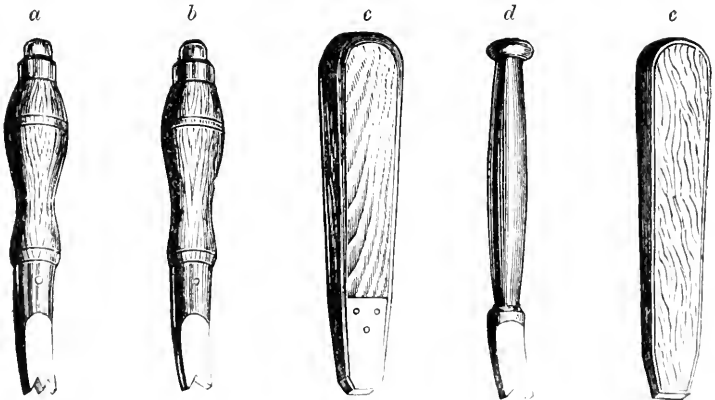

Fig. 36.

fig. 35. *Shooting sticks*, fig. 36, or “shooters,” as they are called for shortness, are made of various kinds. We give a

few varieties: *a*, *b*, and *c* are of boxwood with gun-metal tips, *d* is of iron entirely, and *e* is the original form of shooting stick, made of boxwood only. This last is the best for locking-up on the old imposing surfaces made of stone, as metal tips are liable to chip the surface, but on iron surfaces the gun-metal tips would have no effect. The one lettered *d* is a very narrow one, being adapted for unlocking formes when the quoins are very small, but care must be exercised that the stick does not injure the surface.

Chases are rectangular frames used for placing round

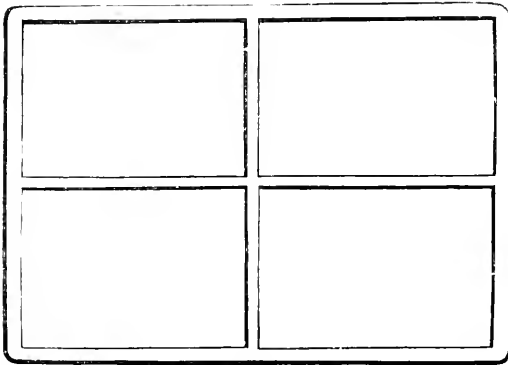

Fig. 37.

pages of type in imposing, and are made both in cast and in wrought iron. Though dearer in the first place, the latter are much to be preferred, as the cast ones are likely to get cracked or broken in usage if not handled with care, and, further, are not always true, thus making the register or backing of pages in printing a difficult matter, and at the same time a difficulty always to be repeated whenever the chase is used. There are many varieties of chases, and these are classed roughly under three heads, as news, book, and jobbing. The two first kinds are not only made in single chases, but

in double and quadruple sizes, so as to permit of their being placed close together on the machine in printing a large

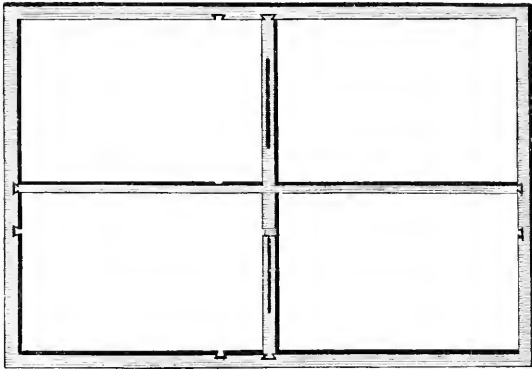

Fig. 38.

sheet. These chases are often divided or subdivided into

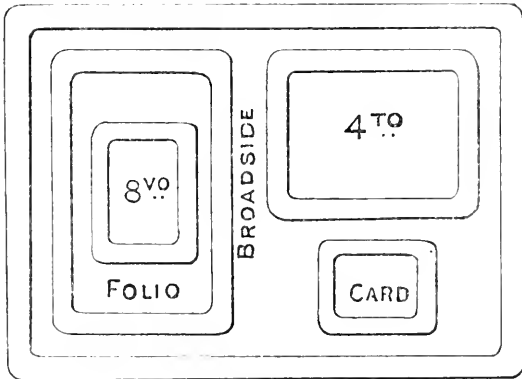

Fig. 39.

folio or quarto by means of cross-bars. In *cast-iron* chases, fig. 37, these bars are fixed, but in *wrought iron*, fig. 38,

they are usually movable; thus, as will be seen from the vacant slots on the inside, allowing of the chase being adapted for either twelvemo or eighteenmo. All chases are made to regular sizes to suit the requirements of paper, *i.e.*, demy, royal, double foolscap, &c., with their respective double and quadruple equivalents. *Jobbing chases* are of many varieties, fig. 39, and differ greatly in sizes and shapes. They are used for broadsides, slips, or headings, cards, and jobs of all kinds.

The following is a handy chase for locking-up small

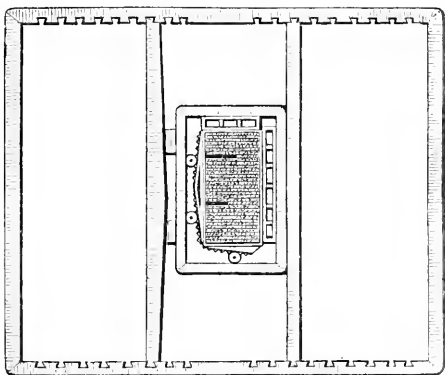

Fig. 40.

formes on press or machine, fig. 40. It is fitted with movable bars, which can be placed at different intervals according to the size of the job imposed in the smaller chase. This method obviates a quantity of furniture being used, and, further, is far more secure in fastening the forme to a given position.

Imposing surfaces, fig. 41, or *stones*, as they are more often called, from the fact that these surfaces were originally made of either stone, marble, or slate, are made of cast-iron slabs planed on the top surface. These are mounted

on strong wooden stands, bolted and screwed to give additional strength. They are made in several sizes, such as double or quad crown, and even larger, and have drawers placed underneath to hold quoins. Sometimes the spare space below is utilized for forme-racks or other receptacles, where space is an object.

Forme-racks, fig. 42, are made, as a rule, distinct, and of different heights to take the standard sizes of chases. They are made of deal, with battens top and bottom to prevent the formes rubbing or touching each other, thus forming a

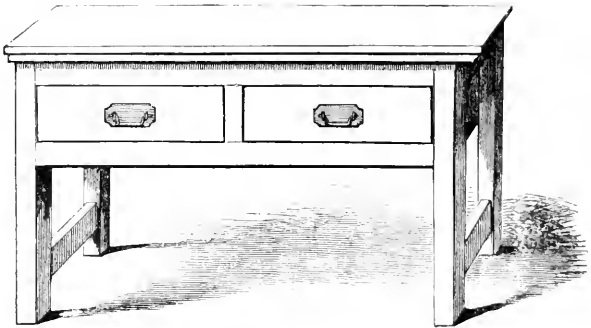

Fig. 41.

series of grooves; the space between the bottom battens is lined with hoop-iron—to allow the formes to be more easily pushed in and drawn out than they otherwise would be if not so lined. These racks can also be obtained of another kind, and we show the two systems as applied to holding various sizes of formes. The second is called the “Universal” forme-rack, fig. 43, and is made of a number of inclined boards with grooves at the bottom lined with iron. In placing these racks it is advisable to select one that leans back from the direction in which the best light is given, as the face of the type would then be

exposed to a better view when you are searching for any particular forme. These receptacles are made in any size or length; if only one rack in height the top can be used as a bench or bulk.

Bulks are movable boxes with the front open, having

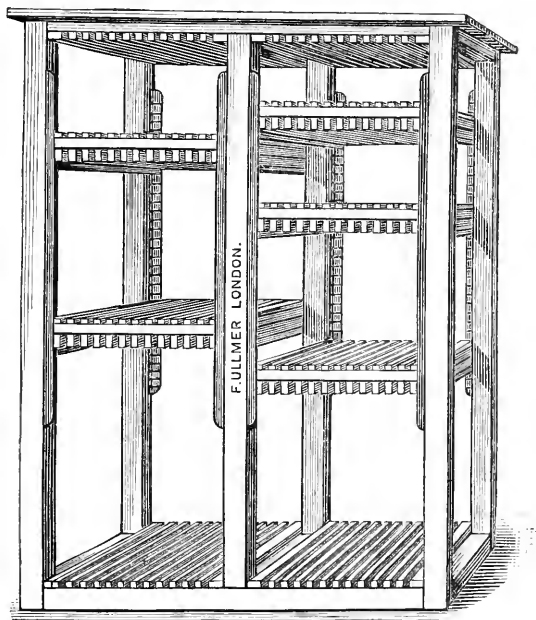

Fig. 42.

battens to form a *letter-board rack*, fig. 44. These are demy, royal, or double crown in width, and are placed generally at the end of the composing frames. The letter-boards contained in these racks are for holding matter for distribution, or for laying-up formes for the same purpose, the top of the bulk being also utilized. Some frames have a

small bulk attached to them in the shape of a single shelf

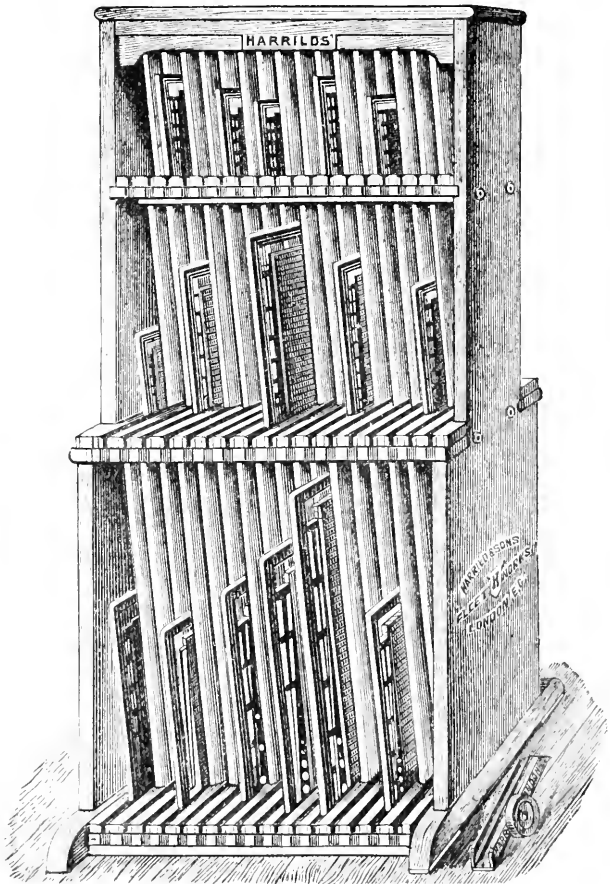

Fig. 43.

with legs ; this is useful for putting pages on as made up, or superfluous sorts turned out of the cases.

Case-racks are also made apart from the frames. These are fixed in convenient places, usually holding fourteen pairs of cases, and are for storing the cases not in immediate use. They are made single, or in pairs, or even in series, according to space at command. The illustration overleaf, fig. 45, shows a bracket arrangement for holding

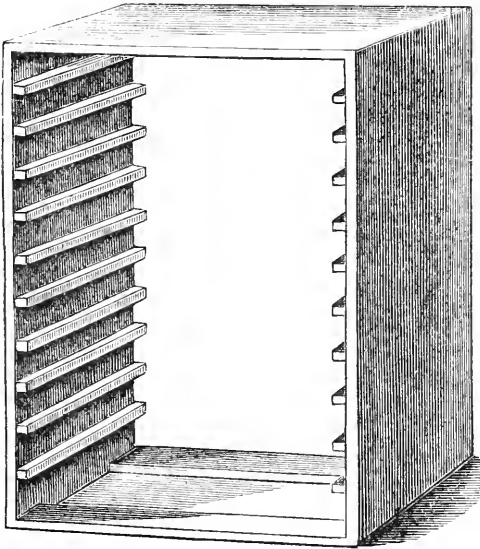

Fig. 44.

a case when only a line or two is required to be set, and is a useful addition. These racks are about six feet in height.

Another receptacle is the *galley-rack*, fig. 46. These can be obtained singly to stand in any corner, or between two composing frames which back each other. For larger spaces they are made in rows as room will permit.

In establishments where news-work, or a class of work is executed which necessitates slip proofs, a *galley-press* is a

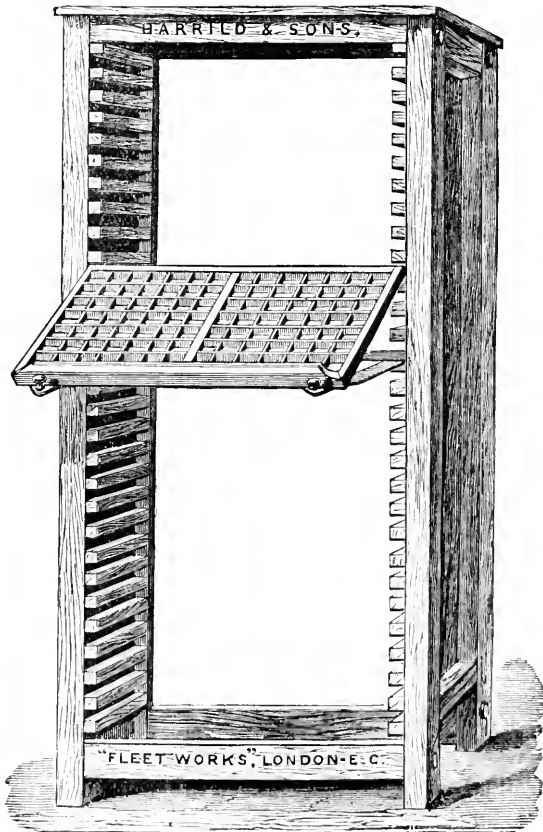

Fig. 45.

requisite article. There are two kinds of these to be obtained, viz., cylinder, fig. 47, and platen, fig. 48. They

occupy a very small space, and require but little experience in manipulation.

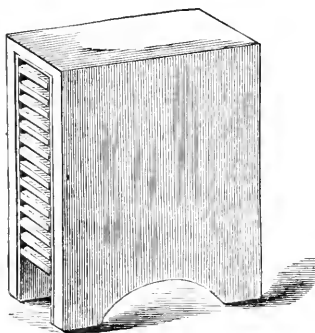

Fig. 46.

For cutting *brass rule* or *leads*, small machines are used. A good serviceable one is the old-fashioned cutter,

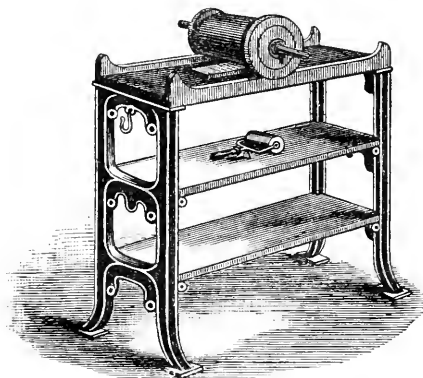

Fig. 47.

but that with a lever arrangement, fig. 49, is an improvement. Another form is very compact, having a spring

handle, fig. 50, with a guide to the right indicating the length being cut off. This machine is termed the "Bowra."

Page-cord, used for tying-up pages or portions of type, is a net twine. Ordinary twine will not stand water, there-

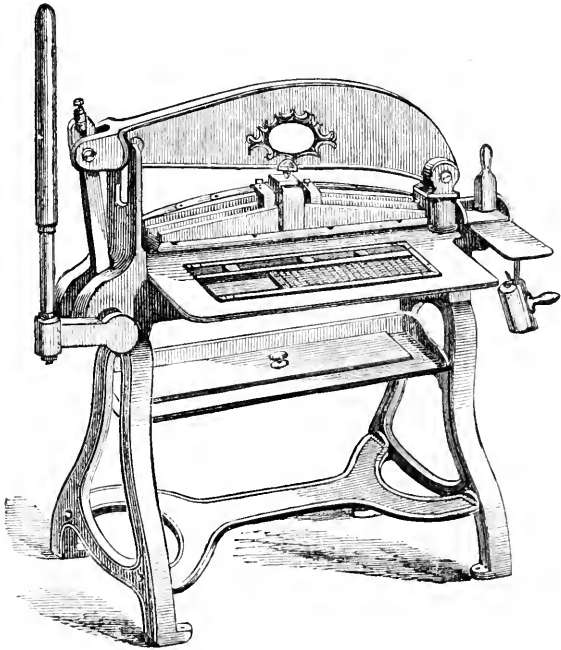

Fig. 48.

fore the proper kind must be obtained. Its application facilitates the lifting of matter from the galley to the imposing surface.

A few other implements complete for the present the

general outfit of a composing room. Among these are a *bodkin*, fig. 51, and *tweezers*, fig. 52; the first for correcting

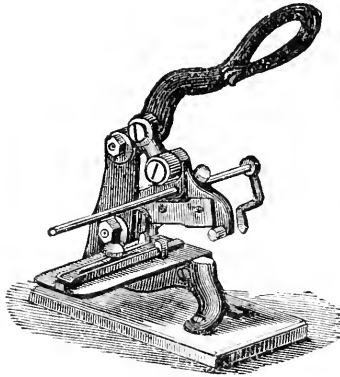

Fig. 49.

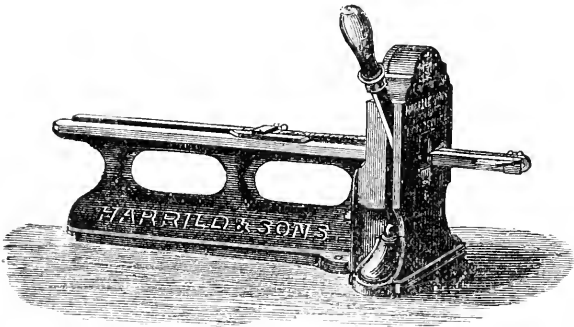

Fig. 50.



Fig. 51.

ordinary matter, and the latter especially useful in table-work for lifting figures out of columns. A pair of *shears*,



Fig. 52.

fig. 53, is necessary for cutting odd pieces of either lead or

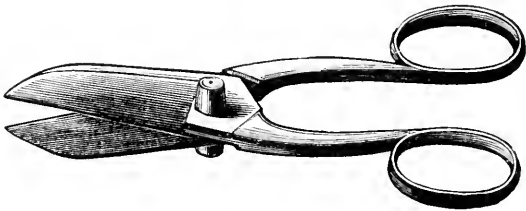

Fig. 53.

brass rule. Other articles in use will be referred to as required.

CHAPTER III.

Position and Aspects of a Composing Room, with Plan—Lays of Book and News Cases—Learning the Boxes—Reversed Print—Attitude in Composing—Spacing and Justifying—Composition—Making Measures—Rules for Spacing—Emptying the Stick—Punctuation, Capitalization, and Indentions.

HAVING now gained some insight into the general aspects of the composing department, and the materials, tools, and other appliances used therein, it is necessary for the student to acquire a knowledge of the boxes of the upper and lower cases respectively.

It is absolutely necessary, in the first place, that a good light should be obtained for the composing frames, and, if possible, the light should be on the left of the operator as he stands at his case, but if the frames are placed back to back in order to economize room, it is only every other

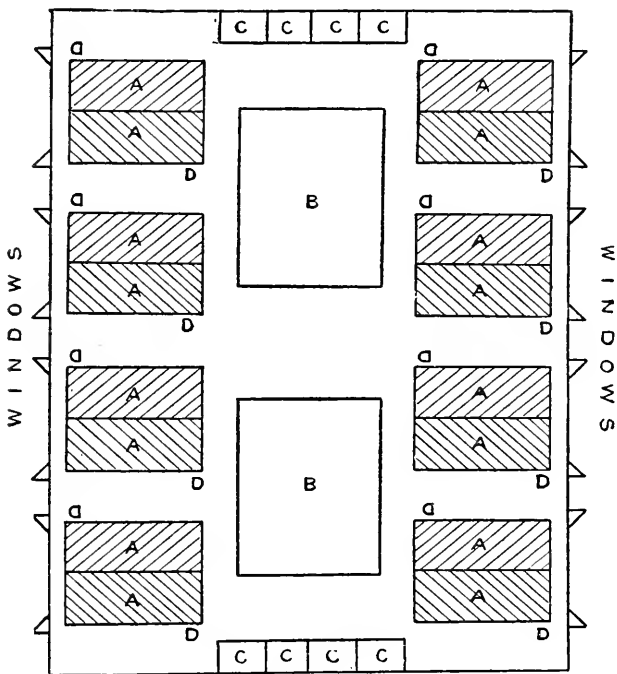

Fig. 54.

compositor who will obtain a left-hand light. For offices of a medium or large size, the best situation for a composing room is at the top of the building, on account of the better light; if the room is square with windows on both sides, the plan shown, fig. 54, is a good one.

Assuming, then, that your room is square or oblong, with

ample light on either side, (A) would represent the frames placed back to back, two men (D) working shoulder to shoulder,

PLAN OF BOOK CASES.

A	B	C	D	E	F	G	A	B	C	D	E	F	G
H	I	K	L	M	N	O	H	I	K	L	M	N	O
P	Q	R	S	T	V	W	P	Q	R	S	T	V	W
X	Y	Z	Æ	Œ	U	J	X	Y	Z	Æ	Œ	U	J
ı	2	3	4	5	6	7	â	ê	ï	ô	û	§	†
8	9	o	ℒ	/	—	~	á	é	í	ó	ú		†
ä	ë	ï	ø	ü	ç	k	à	è	ì	ò	ù	¶	*

Upper Case.

—] æ œ) j		Thin and Mid. Spaces	!	?	!	:	...	ff		
&	b	c	d	e	i	s	f	g	...	ff	
ff									...	ff	
ff	l	m	n	h	o	y	p	,	w	En Quadrats	Em Quadrats
Hair Space											
z	v	u	t	Thick Spaces	a	r	q	:		Quadrats	
x							.	.			

Lower Case.

Fig. 55.

but at opposite ends of the frames, in order to give each other more room; (c) represents the tall case-racks holding cases not in use; (B) the imposing or correcting surfaces, are placed in the middle of the room. The other openings

or spaces would allow sufficient room to move about freely. Unfortunately, such a good situation cannot always be pro-

PLAN OF NEWS CASES.

á	é	í	ó	ú	ç	*	A	B	C	D	E	F	G					
à	è	ì	ò	ù	~	†	H	I	K	L	M	N	O					
â	ä	ê	ë	î	ï	ô	ö	û	ü	—	‡	P	Q	R	S	T	V	W
X	Y	Z	Æ	Œ	U	J	x	y	z	Æ	Œ	U	J					
1	2	3	4	5	6	7	A	B	C	D	E	F	G					
8	9	o	\$...	7	ℒ	H	I	K	L	M	N	O					
1/4	1/2	3/4	1/8	3/8	5/8	k	P	Q	R	S	T	V	W					

Upper Case.

—] æ œ) j		Thin and Mid. Spaces	'	?	!	;	...	fl
&	b c d e		i	s	f	g	...	ff	
ff							...	fi	
Hair Space	l m n h		o	y	p	,	w	En Quadrate	Em Quadrate
ff									
z	v u t	Thick Spaces	a	r	q	:	Quadrats		
x					.	-			

Lower Case.

Fig. 56.

cured, and other arrangements have to be made according to circumstances. By all means keep the composing rooms quite distinct from the other departments, as the noise or bustle of any one department is very inconvenient to another.

Returning to the subject of learning the boxes. There are several systems in use, and we give two methods. Fig. 55 is that generally used for laying the letters for book-work. News-hands adopt a different lay, and that shown in fig. 56 is the one used by some of the leading London daily papers. This last system no doubt facilitates the composition of news-work.

For Greek, Hebrew, and some other languages cases of special make and complicated nature as regards the lay are required; these will be referred to in their order.

Having learnt the boxes, it is advisable that the learner shall have some experience in setting-up before he attempts

if may be well bebjexing to the novice.
 if in that position, front, at first glance,
 The eye soon becomes accustomed to read
 compositor would read it in the metal.
 This type is now printed exactly as the

Fig. 57.

distribution. There are certain letters which are rather puzzling at first glance to the novice, and he has literally to mind his p's and q's, and also his b's and d's, in his first attempts at composition. Naturally, to print correctly when impressed, the faces of the types are reversed in the metal; therefore the practised compositor is accustomed to read his matter upside down. This, of course, is due to the manner in which it is set in the stick, nicks being placed uppermost. The reversed print, fig. 57, illustrates the first difficulty, which is, however, soon overcome.

There are a few elementary rules to be impressed on the learner. The most important is that he should acquire a proper and correct attitude in composing. If

this is neglected at first, bad habits will grow, and then become no easy matter to shake off. Let the operator choose a standing position; a seat should not be allowed except in the case of physical inability to stand for any length of time, and, if this is necessary, a sitting posture should be adopted for distribution rather than composing. If a stool is requisite, one with a single leg is best, because it allows more freedom, and the body will move or turn more easily. As before mentioned, the frame should be breast-high, so as to bring the lower case to a level with the elbow, as this is the most comfortable height at which to compose. In the case of a short person, a platform or stool must be used to bring up the arms to the required level. If anyone above the average height, the cases can be made sufficiently high by putting one or even two pairs of cases under that in use. The body should have little or no swing in it; still, total rigidity is to be avoided. In picking each letter up separately, the hand holding the composing stick should be advanced a little to meet it. No false or unnecessary movement should be made in picking up or conveying the letters to the stick; the left thumb receiving the letter when placed in the stick by the right hand, each separate type being allowed to fall into the stick with a very gentle click. We have seen some compositors make a very laboured action in picking-up—throwing the arms about, and, in dropping the letter into the stick, quite stutter or stammer, as it were, over that very simple operation. Be sure, then, that you acquire a graceful and easy method in starting, and all will be well in the end. The centre of the case, where the cross-bar is, should be the correct place to stand. To avoid the character of being slovenly, read your lines as composed. This should be done as soon as they are finished and before spacing out; in time the habit will become so fixed, that in spacing out, or even in composing the line, the eye will wander over the words, and detect

any letterals. Sometimes a quick type-setter who does not read his lines, will, when a week's work is done, be behind the more painstaking man who does, even though the latter may be slower in composing.

Spacing and justifying are two very important factors in good work. When not executed correctly the first is offensive to the eye which can appreciate careful and even spacing, and the latter increases the risk of the forme falling out if not properly justified. Spaces are so graduated that no excuse can possibly be made for bad and unequal spacing; nothing mars the appearance of a prose work so much as a want of uniformity in this respect. Bearing in mind the respective relations of the different spaces to their own body—*thin* (five to em), *middling* (four to em), *thick* (three to em), and *en quadrats* (two to em)—the spacing can be so finely graduated (more or less) as to be really imperceptible to sight when printed. For very particular works the spacing may be humoured to a certain extent. For instance, two words ending and commencing with either descending or ascending letters would require a little more space between them than two words which ended and commenced with short letters.

<i>a</i>	<i>b</i>
bad boy	nice child

These two pairs of words having precisely the same space between illustrate what we mean: that *a* would take more space than *b* if the spacing is to be equalized so closely. Then, again, letters with a serif, as the lower-case f, would certainly take more, whereas after a comma the space could, if necessary, be reduced slightly. Unless a work is exceptionally well leaded, the thick or three-em space is considered the average, and it is this which the compositor uses when setting-up. Poetry works, with the exception

mentioned, always have this space between each two words, the end of the line being filled up with quadrats and justified with spaces. In prose works the same space is used, and if at the end of a line something must be done in order to fill it up, the circumstance of it being a solid or leaded work should be weighed. For solid or unleaded works, or even those with a thin lead, adopt a closer space, and for leaded works select a wider, if any choice is given at the end of a line, supposing that it falls short of the measure. Taking a thick space as our standard, the following will give the spaces for getting in or driving out a line :

For increasing—

Thin and middling,
En quadrat,
Thick space and middling,
Two thick spaces.

For decreasing—

Middling space,
Thin space,
Hair space
(as a last resource).

Justifying a line should be performed by spacing each line out with equal tightness, but not to such a degree as to prevent the stick being emptied easily. Good justification, so as to allow a handful or page of type being lifted without dropping a single letter, is evidence of the careful workman.

We will now place ourselves at the frame and take the composing stick, which has been made up to the required measure, in the left hand. It should be laid loosely in the palm of the hand, the thumb touching the brass setting rule placed against the bottom of the stick. Measures are determined by pica ems, placed in the stick thus—

≡ ≡ ≡ ≡ ≡ ≡ ≡ ≡ ≡ ≡ ≡ ≡ ≡ ≡ ≡ ≡ ≡ ≡ ≡ ≡

It is a bad plan to make up these measures to pica quadrats or leads of the length desired. One particular fount of pica should be selected for making measure for all in the same establishment, to obviate any possible variation of body. An odd en quadrat is sometimes used for narrow or half-measure.

sures in book-work, but only when the full measure demands it.

In commencing to set type, a few words of the copy lying in front of the operator on the upper case should be committed to memory. Assuming that a fresh paragraph is begun, an em quadrat is first placed in the stick to form the required indention. He should then take a capital letter for the commencement of the word, placing it nick uppermost in the stick, the left thumb receiving it from the right hand and gently letting it slide into its position, fig. 58—these actions being repeated till the word is quite

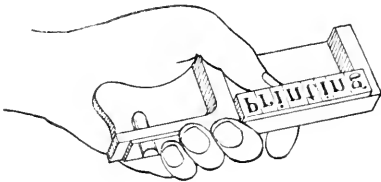

Fig. 58.

spelt out and a space inserted from the thick space box. In placing spaces in the stick, they may be put in regardless of the nick, as also quadrats; but the habit is so firmly acquired that one generally puts the nicks uppermost, uniform with

the letters. In picking each separate letter out of the case, the compositor should fix his eye on some one of his letters, observing which way the nick is, and in conveying it to the stick dexterously turn it to its proper position before it arrives there. Probably at first he will seize the first letter that comes to his fingers, and look at it, turning it to the required side before he drops it in the stick. In course of time he will be enabled to "spot" his letter as it lies in the case, and thus expedite the setting. When the first word is done, and space inserted, the same process has to be gone through till the line is finished. The copy, of course, is read off as required, and the time occupied in picking up the space is a favourable opportunity for doing this. At the end of the line, supposing it is not filled

out and there is not sufficient room for the next word, the rule laid down as to reducing or increasing the spacing according to the solid or leaded character of the work, must be considered. Dividing words by means of the hyphen should not often be resorted to if the line can be fairly spaced without having too much or little between the words. In wide measures, supposing the type is not a very large one, there should be no excuse for dividing words; where necessary to do so in narrower measures, do not break words in two following lines. When the line has been spaced and justified, put the lead in, if the work be leaded, and lift the setting rule out, placing it in front again preparatory to setting another line.

Certain extra spaces are required after the double points, to give, as it were, emphasis to the value of these punctuation marks; thus an en quadrat should be placed after a semicolon (;), note of admiration (!), note of interrogation (?), and colon (:)—each of these points should have a thin space in front of it if they are cast on a thin shank—if a beard on the inside, a hair space only, but if an extra large beard, nothing whatever; also, if the spacing of the line has to be altered more or less, the spaces after these points should be altered too, proportionately. Commas and full points (as full stops or periods are called) should be placed quite close up to the last letter of the word. An em quadrat is placed after a full point in a run-on sentence. The last line of a paragraph, if a short one, is spaced out with quadrats. Commas should only have the usual thick space after them. Parentheses () and brackets [] are usually placed close up at either end, and the second (or closing) one is formed by simply turning it round—the nick to the back. Turned commas (“) used for quotations are made by reversing two commas and placing a space after them; the closed ones are formed of two apostrophes (”).

When the stick is filled line by line it has to be emptied.

This is a difficulty to the novice, and it is best that he should practise on a half-filled stick for the first few occasions. To execute this step the stick should be placed crosswise on the case head upwards, and the top grasped by the forefingers of each hand and the bottom by each thumb—the remaining fingers can then help to clasp the sides, thus holding the whole together. If the matter has not been too tightly

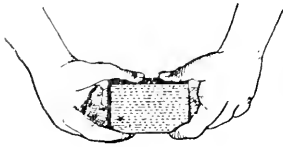

Fig. 59.

justified it can be lifted out easily, fig. 59, and carried in that position, face outwards, to the galley on which it has to be emptied. When this has been done successfully several times a full stick can be tried. In all instances the setting rule should be used to give additional support to the

handful; this is, of course, actually necessary in absolutely solid works.

The reading of each line must be borne in mind before spacing out, and certain other rules are to be followed in good composition. These are the styles and customs of the house. In well-ordered establishments it is best that a few brief regulations should be drawn up and printed for the benefit and guidance of the case department. Different offices have their own methods for the capitalization of words, spellings, and other matters, therefore only general rules can be laid down here. Of course all proper names should be commenced with a capital, and it is a good plan also to adopt the same rule for any direct reference to the State, Church, and words used in relation to the Deity, such as He, Him, Thy, Thine, Thou, Who, Whom. Other details should be determined by the custom of the office.

Wide measures of book-work take $1\frac{1}{2}$ or even 2 ems indentation of their own body, and in the case of a first

paragraph of a fresh chapter or section the first word is generally set in CAPITALS and SMALL CAPITALS, and if so, set full out to the measure without indention. In manuscript copy the usual signs to indicate capitals, small capitals, and italic are :

Capitals	= <i>three</i> underlinings	≡≡≡≡
Small capitals	= <i>two</i> „	≡≡
Italic	= <i>one</i> „	≡

In spacing out poetry or short lines with quadrats, always place the quadrats at the end of the measure, and any spaces requisite to justify the line between the first and second, if more than one quadrat is used. This plan prevents the spaces falling down in the event of their being placed next the last word, should it be necessary to lift the word out for correction ; if only one quadrat is needed, place the space, if any, immediately after the last word.

Manuscript copy requires far more judgment in composing owing to the way it is usually written. Most authors and writers ignore punctuation and use capitals too freely ; it is, therefore, the duty of the compositor to point his matter as he proceeds, and follow the rules of the house as regards capitals and other details. For this purpose an extra price is provided in the scale of charges—a half-penny per thousand ens being considered the equivalent value, but in our estimation it is very insufficient for the average class of manuscript copy supplied. Reprint works generally have to be followed literally.

Cross-lines or chapter heads set in capitals or small capitals should be justified in the centre of the measure by putting equivalent quadrats and spaces at either end of the line ; if the matter of a thin space is left to be divided at the last, put the extra space in the first part of the line ; this will help to counterbalance the comma or full point

that may be placed at the other end, as these punctuation marks, in a large type especially, appear to throw the line out of the centre.

We have now shown the method of setting-up for ordinary straightforward book-work. With the help of the remarks on spacing, justifying, and emptying the stick, the learner can proceed till the type in his case has been exhausted. But it is very necessary not to forget the advice given as regards position and movement in composing, and we repeat it. Avoid all unnecessary movements in picking-up, and drop the letters in the stick deliberately but quietly. Experience will soon teach the nearest and best way to the boxes, and back again to the composing stick. Bad habits and ungraceful movements are easily acquired and difficult to throw off, therefore it is of the highest importance that a free and not formal manner should be acquired. The wrist must be used as much as possible, and the elbows kept square, and at the same time the body should have but little or no movement. All feints in picking up the letter or flourishes with the arm must be avoided, and the left hand containing the stick should be carried a little in the direction of the other to partly meet it, but care should be taken that it is not stretched too far.

CHAPTER IV.

Preparing Type for Distribution—Method of Distribution—Odd Sorts and Peculiarities—The Jigger—The Sticking or Caking together of Type.

THE letter—as type is called sometimes in a collective sense—having been all set up, the operator may now proceed to learn something of *distribution*. He will have acquired a good knowledge of the boxes by this time, and will be able to drop the different letters into their respective boxes with a greater degree of certainty than if he attempted this part of the work in the first instance. It is marvellous to observe the rapidity with which a practised compositor distributes the type into his case; this being only attained by long practice. Clean matter and proofs being desired, much depends on proper and correct distribution, therefore it is necessary to cultivate a very careful manner in distributing, and too much haste by a beginner should be deprecated.

Distribution is a term applied both to the matter itself as a whole and to the act of distributing the same. The type may be obtained from the store-room or from formes of the work in hand—technically called “its own”—or those of a similar nature in the same fount. Under any circumstances, the compositor should see that the type is quite clean, and if not, he must wash it. Assuming he has to take a forme of type for his distribution, and it requires washing—it should be placed on a board, washed over with lye, and rinsed with cold water; then the forme should be unlocked and receive a second rinsing, by which the water will run between the lines and spaces, thus rendering the

whole more convenient for the separation of the letters, which would not be attained if manipulated in a dry condition. This last wetting is perhaps better done with a sponge usually kept for the purpose. Though this treatment assists the distribution by making the letters separate more freely, it at the same time, curiously enough, has the effect of binding the whole matter together in bulk. Take, for instance, a page left standing naked on the imposing sur-

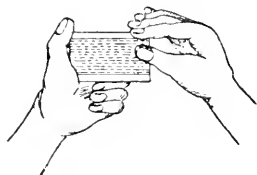

Fig. 60.

face or board—that is, without any surrounding furniture. If dry, the letters on the outside edges of the page would most probably fall over on their sides, but if wetted they would keep their position whilst any moisture was retained. In fact, if a forme has to be re-imposed or re-

arranged on the stone, it is always best to damp the edges slightly with a sponge. This prevents any possible accident to the type, which might be overlooked in the proof.

To commence, the operator would take a handful of matter, say about a stickful in depth, taking care that the bottom line has either a lead or setting rule against it to prevent breaking or “pieing”—a technical term for broken or mixed type. The piece should be lifted with both hands and placed, nicks uppermost, in the hollow of the left hand, the type lodging on the three fingers, and the forefinger grasping it round the back; the thumb would then steady the left side of the handful, fig. 60. The right hand is thus free to commence. With the second finger of this hand push the first word of the right-hand end of the line up, then seize it also with the forefinger and thumb. You have now got the word grasped between the thumb and the two first fingers of the right hand. As you do this, the word should be read, and each letter dropped singly

into its own box. The separation of the letters is easy, and you will find, when the word is held in the fingers as described, that a little pressure or squeeze of the fingers, especially with the second finger, will serve to divide each segment of the word. When the word is all put into case, repeat the action till the case is filled. In course of time you will become so expert, that you will be able to take two or three words at a time, according to the size of type in use—the smaller the better, provided it is not too minute. Carefully discriminate between the spaces, and throw them into the proper receptacles, because it will save so much

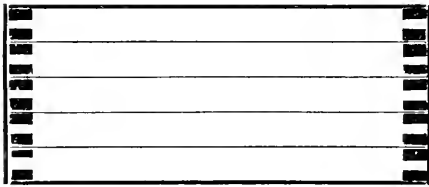

Fig. 61.

time afterwards in composing. The average speed for distribution is from three to four times that of setting.

Odd sorts and other peculiarities which have no place in the cases in use, as likewise occasional words of italic, should be put aside for after-distribution in their proper cases.

A handy article to hold these sorts temporarily is a *jigger* made of quadrats and leads combined, a piece of stout paper being wrapped round the back to form a bottom, and the whole being tied round with page-cord. The accompanying diagram, fig. 61, will give some idea of what we mean. Wooden boxes on the same principle can be obtained of the material manufacturers. It is a reprehensible plan to allow these sorts—often valuable—to accumulate, and possibly be thrown in the back or unused boxes of the upper case. They create there a mass of pie, and cannot be found when

wanted. The quadrat box should also be kept scrupulously clean from all extraneous sorts or spaces.

Another consideration of type for distribution is that new founts, or type laid by out of use for a long period, is apt to become stuck together, "caked" or "baked." There are certain remedies to counteract that evil, for it is assuredly one, as anyone who has experienced it will testify. If distribution is attempted under those conditions, it will probably cut the fingers if the type is new, and, if old, at least will make them very sore and unfit for composing. Hot lye is sometimes used to wash the type over to assist the separation; glycerine also may be tried with good results. Another remedy, if the type is not very much caked, is to have the steam-cock of the boiler turned on to the face of it.

CHAPTER V.

Making-up into Pages—Different Styles of Headlines—Determining the Length of Page—Page Gauges—Side-notes, Cut-in notes, and Footnotes, with their Reference Marks—Rules for the Setting of Preliminary and Appendix Matter—The Printer's Imprint—Tying-up Pages—Signatures.

TAKING book-work as our standard at the moment, it will be seen that books are most frequently divided into chapters or sections. Sometimes these commence with a fresh page, and in such instances usually with a "dropped head"—that is, they will begin about one-third down the page. Sometimes, on the other hand, they are "run on," by which we mean that the new chapter or section commences on the same page, with a suitable amount of white or space between it and the end of the preceding chapter, provided the last chapter does not end

very low down on the page. Whichever plan is adopted, uniformity is to be desired throughout as regards spacing and display of chapter heads.

Headlines of the pages are set in various styles. Pamphlets may perhaps have a plain folio only, but works, *i.e.*, longer books, will have a headline which may be dependent on instructions. Italic capitals, italic lower-case, and roman small capitals, are all used in turn, and sometimes with a rule under. Further, the subject-matter of the headline is often determined by the nature of the work. Some volumes would have the fixed left-hand headline bearing the name of the volume, and the right-hand one containing the subject of the chapter. The amount of white or leading after the headline, too, is regulated by the style adopted, and the solid or leaded character of the work.

The length of a page depends of course on the width of matter, and the size of paper to be used. Roughly speaking, to form appropriate margins to a page, the length should be a line shorter than the width—by this we mean that there should be a trifle more margin on the top and bottom of a page than on the two sides. Side-notes, and runners down the sides of pages, are thrown into the margins entirely if the former are not very heavy. Foot-notes are therefore preferable where possible, as full side-notes do not improve the appearance of a page.

The length of a page having been determined, a *gauge*, fig. 62, should be made to the size, a piece of pica reglet with a notch cut serving as the mark for length. Each page should have a white line of quadrats at the bottom—this line to be over and above the length determined on in making the limit of the page, but included in the gauge. This white line serves two purposes—first, it protects the last line of type, forming, as it were, a bulwark; secondly, it contains the signature of the sheet when re-

quired, and is also useful in certain exigencies of making-up, in allowing the pages to be made a line long. When this occurs it is desirable to have the facing page, be it odd or even, equally long. In paging matter never turn the break or end line of a paragraph over to the top of the next page, and if possible do not commence a fresh paragraph—being indented—at the bottom line of a page.

Where *footnotes* are voluminous and numerous, much trouble is sometimes caused in putting the notes to their proper pages, especially if the references happen to fall near the bottom. Under these circumstances it is permissible to carry over a portion to the next page. Reference marks for notes are of three characters: the signs * † ‡ || § ¶ are used occasionally, and when further references are



Fig. 62.

required on the same page, these are repeated ** †† and so on. Superior figures ^{1 2 3} and letters ^{a b c} also are used, but more frequently the figures. *Side-notes* as a rule do not have references, as their parallel position indicates the reference. Footnotes are nearly always set in type two sizes (or removes, as they are called) smaller than text; if this is leaded, the notes should have a thinner lead. *Side-notes* are frequently put into three or four removes smaller.

With regard to the *preliminary* matter of a volume, avoid using fancy types in displaying, and set the title in good round types of the same character as the body of the work. Condensed type does not look well unless it is for an exceptionally long line which would suffer more in dividing. Contents pages, if not very full, in capitals and

small capitals, and dedication neatly displayed in even small capitals. Prefaces and introductions, if not long, should be set in type one size larger than text, but the old-fashioned way of putting them in italic looks well. If these parts of the preliminary matter are extensive, the text type may be used, with a slightly thicker lead than that used in the book put through. If the text is solid, then use only a thin lead. All these pages should be paged with numerals—not figures—in roman lower-case, commencing with the half or bastard title. Indexes are as a rule set in two sizes smaller than text in two columns, and the pagination

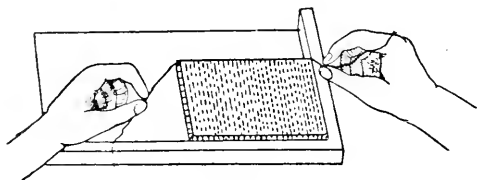

Fig. 63.

continued on from the text. The style to be adopted in setting these depends on the nature of the index to be composed.

The printer's *imprint* should always appear at the end of the work, and might also be placed at the back of the title.

Having considered these methods of composing the preliminary and appendix matter, we will follow the making-up or paging of the work. As the pages are completed they should be tied up with page-cord, fig. 63, this cord being sufficiently long to go round the page at least three times in a small page—in a large one, four times or more to give additional security. Place the end of the cord a short distance beyond the left-hand corner, and carry to the right, drawing it tightly; when the whole

page has been encircled once, and the overlapping portion crossed, pull the cord rather more tightly, first of all placing the left hand on the face of the page to prevent it rising on the tightening of the cord; when the end is reached, simply tuck it in with the bodkin, leaving the extreme end out in order that it may be the more easily untied. See that it is pushed down to the centre of the type, as the page may spring when lifted if the cord is not placed in the middle. After this is done, the pages may either be lifted to the imposing surface one by one, or, in the case of large pages, slid off the galley on to the surface by sharply drawing the galley from underneath, care being taken to keep the page as square as possible, otherwise the type will be sent off its feet, and be difficult to put right. When a sufficient quantity of pages has been made up—the size of the page of type and paper governing the number of pages to the sheet, *i.e.*, folio, quarto, octavo, sixteenmo, &c.—the imposition must be so arranged that the pages when printed shall fall correctly on the sheet when folded.

Each sheet should have a letter, called the *signature*, at the foot of the first page, that the folder may more readily identify the particular sheet; these signatures are also used as a means of identification by the printer, and should be in sequence. Commence page 1 with signature B; the preliminary matter, usually put into type after everything else, is distinguished as a rule by *italic* lower-case letters, *a b c d*, &c. The printer's alphabet consists of

B C D E F G H I K L M N O P Q R S T U X Y Z AA BB, etc.,

A or *a*, with the subsequent letters in *italic* lower-case, being reserved for the preliminary matter. It will be observed that the letters J V W are omitted. Some printers use a second signature for the opposite corner of the sheet, *i.e.*, the third page; this is denoted by B 2, c 2, d 2, &c. In twelvemo and eighteenmo the insets

should also be marked with a signature answering to the one on the first page. For instance, sig. B in twelvemo half-sheet work would have B 2 on the fifth page. If a work extends over three or more alphabets, express the signatures thus, 2 A or 3 A, &c. If only spread over two alphabets the double letters may be used, A A, B B, &c.

CHAPTER VI.

Imposition—Outer and Inner Formes—Definitions of Sizes of Books—Table of Signatures and Folios—Schemes of Imposition—Margins of Books, and Furniture used to make same—Making Margins—Type Measures or Scales—The proper use of Quoins—Furniture Gauges.

THE placing of the pages in their respective positions previous to working the sheet is called *imposing* them. The appended schemes of *imposition* will give all the varieties required for book-work. But first a few technical terms must be explained. In sheet work there are two formes—the *outer* is the one containing the first page and the signature; the *inner* forme is the backing forme, containing the second page. Sizes of books are determined by the number of times a sheet is folded, be it demy or any other size. A sheet folded once or in half is called *folio*; folded into four, *quarto*; into eight, *octavo*; twelve, *duodecimo* or *twelvemo*; sixteen, *sixteenmo*; eighteen, *octodecimo* or *eighteenmo*, and so on.

The annexed table of signatures and folios will be found useful for reference purposes, the folios being compiled for sheet work. In half-sheet work the number of pages here given must be halved, *e.g.*, signature R in 8vo sheet work is p. 241; in half-sheet it should be p. 121.

TABLE OF SIGNATURES AND FOLIOS.

No.	Sigs.	Folio.	4to.	Svo.	12mo.	16mo.	18mo.	24mo.
1	B	1	1	1	1	1	1	1
2	C	5	9	17	25	33	37	49
3	D	9	17	33	49	65	73	97
4	E	13	25	49	73	97	109	145
5	F	17	33	65	97	129	145	193
6	G	21	41	81	121	161	181	241
7	H	25	49	97	145	193	217	289
8	I	29	57	113	169	225	253	337
9	K	33	65	129	193	257	289	385
10	L	37	73	145	217	289	325	433
11	M	41	81	161	241	321	361	481
12	N	45	89	177	265	353	397	529
13	O	49	97	193	289	385	433	577
14	P	53	105	209	313	417	469	625
15	Q	57	113	225	337	449	505	673
16	R	61	121	241	361	481	541	721
17	S	65	129	257	385	513	577	769
18	T	69	137	273	409	545	613	817
19	U	73	145	289	433	577	649	865
20	X	77	153	305	457	609	685	913
21	Y	81	161	321	481	641	721	961
22	Z	85	169	337	505	673	757	1009
23	AA	89	177	353	529	705	793	1057
24	BB	93	185	369	553	737	829	1105
25	CC	97	193	385	577	769	865	1153
26	DD	101	201	401	601	801	901	1201
27	EE	105	209	417	625	833	937	1249
28	FF	109	217	433	649	865	973	1297
29	GG	113	225	449	673	897	1009	1345
30	HH	117	233	465	697	929	1045	1393
31	II	121	241	481	721	961	1081	1441
32	KK	125	249	497	745	993	1117	1489
33	LL	129	257	513	769	1025	1153	1537
34	MM	133	265	529	793	1057	1189	1585
35	NN	137	273	545	817	1089	1225	1633
36	OO	141	281	561	841	1121	1261	1681

SCHEMES OF IMPOSITION.

Note.—In laying down pages for imposition the first page of the sheet or half-sheet is always placed at the left-hand corner.

HALF SHEET OF FOLIO.

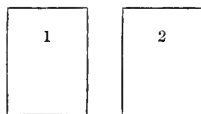

SHEET OF FOLIO.

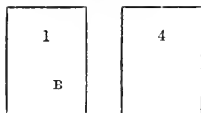
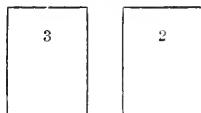
Outer Forme.*Inner Forme.*

HALF SHEET OF QUARTO.

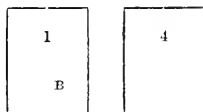
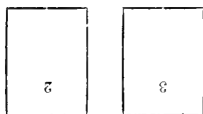

SHEET OF QUARTO.

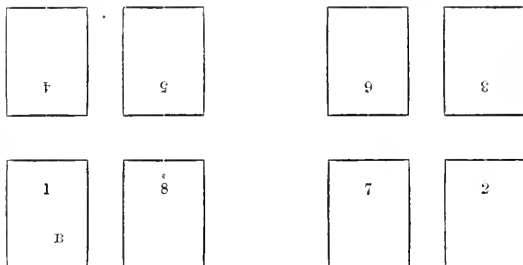
*Outer Forme.**Inner Forme.*

HALF SHEET OF OCTAVO.

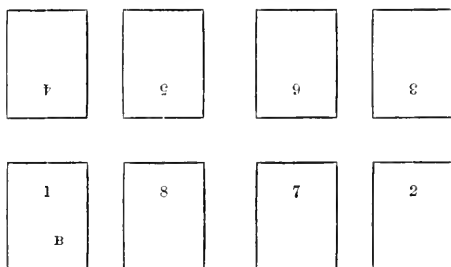

SHEET OF OCTAVO.

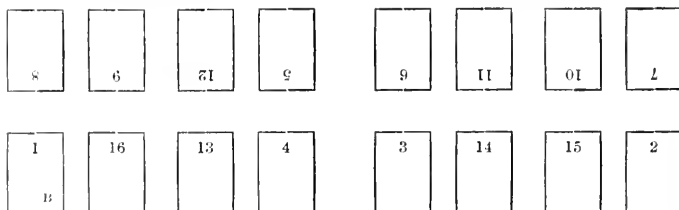
*Outer Forme.**Inner Forme.*

HALF SHEET OF TWELVES (*with offcut and one signature*).

9	7	8	5 B 2
4	6	10	3
1 B	12	11	2

SHEET OF TWELVES (*with offcut and one signature*).*Outer Forme.**Inner Forme.*

12	13	16	9 B 2	10	15	14	11
8	17	20	5	6	19	18	7
1 B	21	21	4	3	22	23	2

HALF SHEET OF SIXTEENS.

2	15	11	8
7	10	11	6
8	6	12	5
1 B	16	13	4

SHEET OF SIXTEENS.

*Outer Forme.**Inner Forme.*

1	65	28	5	9	27	30	3
13	20	21	12	11	22	19	14
16	17	24	9	10	23	18	15
1 B	32	25	8	7	26	31	2

HALF SHEET OF EIGHTEENS (*with offcut, transposition, and one signature*).

FI	2A 5	10	6	9	13
4	5I	12	7	9I	8
1 B	18	11	8	17	2

When one side of the paper is worked, the following transpositions must be made: pages 7 and 12 to take the places of 11 and 8; and 11 and 8 the places of 7 and 12 respectively.

HALF SHEET OF EIGHTEENS (*without transposition, with offcut and two signatures*).

9	7	18	11	8	3A 5
4	6	9I	15	10	11 2 8
1 B	12	13 C	14	11	2

SHEET OF EIGHTEENS (*with offcut and three signatures*).*Inner Forme.*

7	11	11	87	97	98
3	10	15	22	27	34
5 B2	8	17 C2	20	29 D2	32

Outer Forme.

9	2	81	61	08	18
F	6	91	17	87	99
1 B	12	13 C	24	25 D	36

HALF SHEET OF TWENTY-FOURS (*without cutting*).

2	23	22	2B 3	9	19
11	14	15	10	7	18
12	13	16	9	8	17
1 B	24	21	4	5 B 3	20

HALF SHEET OF TWENTY-FOURS (*with three signatures*).

2	1	10	15	18	23
3 B 2	6	11 c 2	14	19 D 2	22
4	5	12	13	20	21
1 B	8	9 C	16	17 D	24

SHEET OF TWENTY-FOURS.

Inner Forme.

2	17	46	24	9	43
23	26	27	22	19	30
14	35	13	15	18	13
11	38	39	10	7	42

Outer Forme.

21	12	40	6	8	14
13	36	33	16	17	32
15	25	25	12	05	65
1	48	45	4	5	44
B				B 3	

HALF SHEET OF THIRTY-TWOS.

4	27	28	9	9	27	30	8
13	20	21	12	11	22	19	14
16	17	24	6	10	23	18	15
1	32	25	8	7	26	31	2
B							

Other impositions are required occasionally. These may be determined by folding a sheet of paper into the required number of leaves, and then marking with a pencil the pages in order. This sheet can then be opened out; one side will give one half of the forme, and the reverse side the other half. Of course the pages should be laid down in reversed order compared with the sheet so marked; then an impression from these pages of type would be the same as your folded sample.

Making of margins.—A chase or chases of a suitable size must be selected. In large formes it is requisite to have as many bars as possible, because they lend additional security to the forme, and prevent the rising or springing of the type when locked-up. Some printers aim at centring the pages of printed matter on each leaf of paper, allowing a little on the outside edges for the cutting

of the book by the binder afterwards, but this plan in our estimation is wrong. Our idea of a good margin to a page is that the fore-edge and tail should be greater than the back and head margin. From a binder's point of view, the surrounding margins of a printed page of a book are defined as shown in fig. 64 :

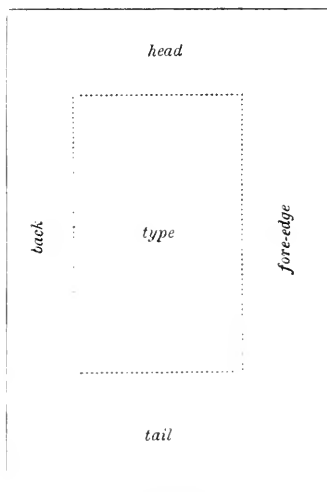

Fig. 64.

and from a printer's standpoint, taking a sixteenmo as our example, the marginal portions of a sheet, simply for the convenience of gauging the furniture, are termed as in fig. 65.

Some printers call the *back* the gutter and the *long cross* the back, but we prefer our method, as the back here quoted is really the back of the book. The long and short crosses respectively are where the long and short crossbars of the chase fall.

Margins, to look well and to be proportionate, should be

arranged somewhat on the following principles. Books, especially good ones, issued in cloth, are likely to be rebound in leather at some future date, and, if cut again, would suffer most on the fore-edge and tail; where consequently a larger margin is desirable. This, too, allows of wear and tear, which occurs more generally on these edges of a book. Further, if old books are studied in this respect, particularly those of the famous presses, English and

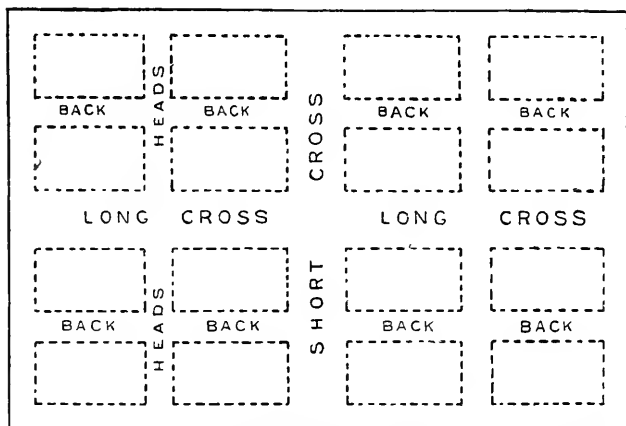

Fig. 65.

foreign, it will be found that this idea was frequently carried out, possibly with a view to allow of annotations in the margins. Bearing in mind what was said a little way back that the length of a page on paper should be regulated by its width, the head margin should be a little more than the back, as by an optical illusion an equal margin generally looks less in the head, perhaps caused by the back of the book. Fifty per cent. more margin on fore-edge and tail than on the back and head

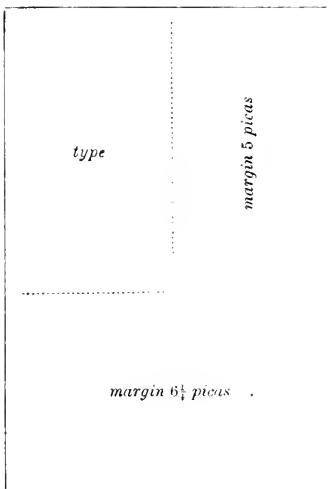

Fig. 66.

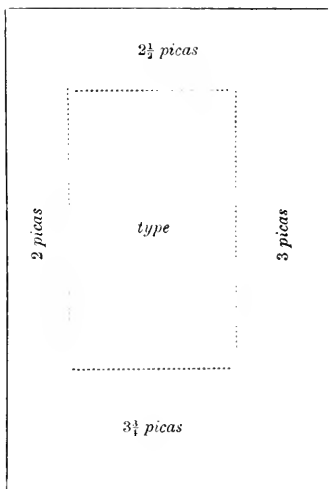

Fig. 67.

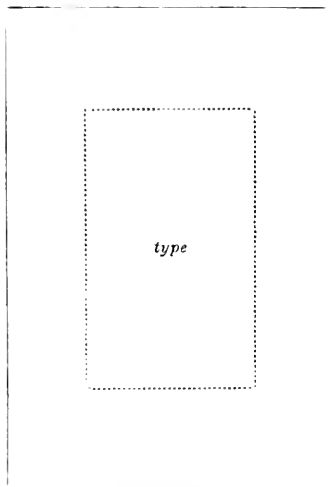

Fig. 68.

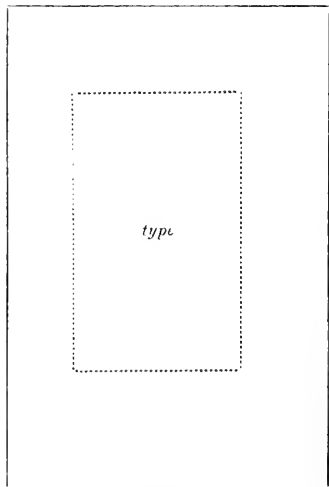

Fig. 69.

respectively looks well, and it can be made more or less according to taste. The diagrams, figs. 66 and 67, will show the proportions worked out.

We also give a centre, or equal, margin round a page, fig. 68, for comparison with the one we suggest, fig. 69, which we contend gives a better proportion than the other.

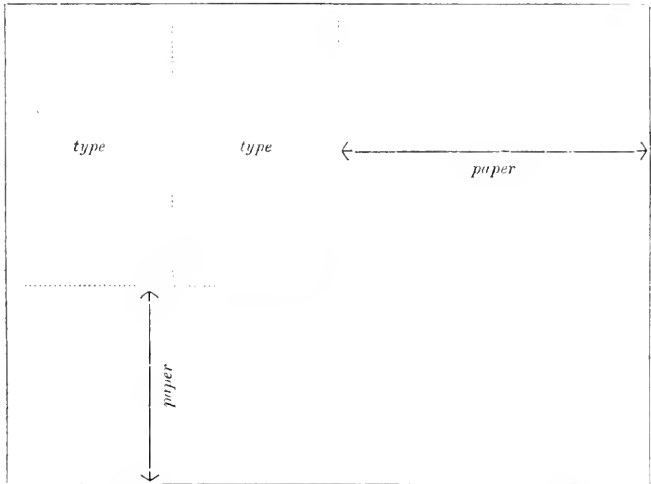

Fig. 70.

An easy way to fix these margins, supposing the book is an octavo, is to fold the sheet into four, or quarto, and measure the length and width of two pages, as in fig. 70. Then calculate the spare margin between the arrows, and if the rule we laid down as regards proportion be adopted, place two-fifths in back or head, and allow three-fifths for fore-edge and tail. When this is done, it must be made out to paper, fig. 71.

By thus adjusting the furniture the sheets when folded

come out with equal margins on the fore-edge for octavo. In other sizes, with a greater number of pages, the sheet should be turned the other way and made out lengthwise precisely in the same manner.

Type measures.—For measuring purposes a *pica-gauge* or *type-scale*, fig. 72, marked with pica ems, must be used. These may be obtained either in ivory or boxwood of the material-maker or type-founder; they also contain the marked ems of other bodies. A home-made one can be manufactured by the pica ems being marked on a piece

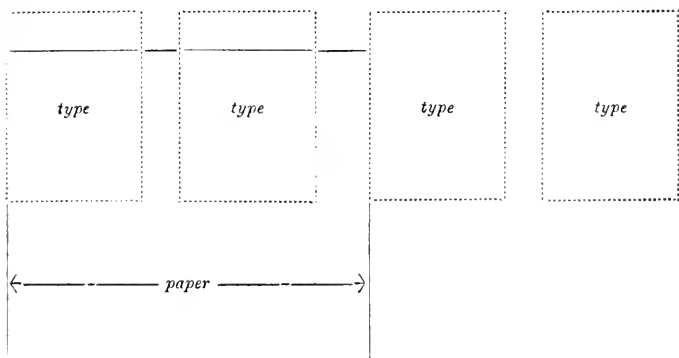

Fig. 71.

of four-to-pica brass rule. In purchasing a measure, however, it is best to procure one which has the standard bodies of the particular founts in use in your office, as some of the types other than pica vary somewhat.

The furniture to be placed round the forme is the next thing to be considered. The terms “dressing” or “clothing” a forme are sometimes used—a forme laid up for distribution and stripped of its furniture is expressed by the opposite term, *i.e.*, “naked.” Assuming that we have a sixteenmo forme to dress, it is best that all the furniture used lengthwise should be a little longer than the page itself

—say a couple of picas at least. That used in the width should not exceed the measure of the work, and care must be taken that it is not too long, or else it will cause a bind. The furniture down the length of the page being longer obviates the possibility of a slip of any lines, provided it has been placed properly, so as to include both ends of the page. The side and foot-sticks should be a little longer than the parts they have to secure, but just sufficient to prevent overlapping each other

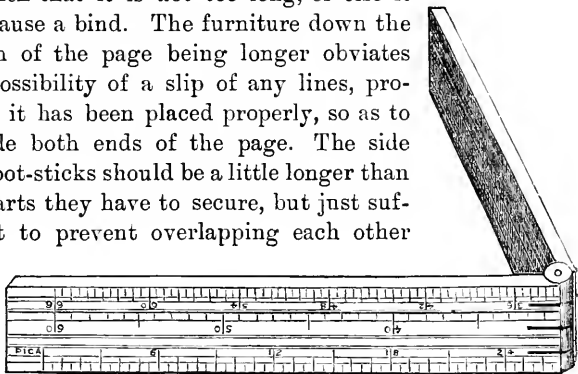

Fig. 72.

either one way or the other. When this is done, the page-cords may be removed from the pages, the inner pages being untied first, and, as each page is released, the surrounding furniture must be pushed up so as to protect it. As the cords are removed, be careful not to get them entangled; place them round the neck temporarily, and when done with hang them on a nail for future use. The quoins may now be fitted; in doing this, supposing there is a large amount of space to fill up, do not use two quoins together, as in fig. 73, but use short lengths of furniture. Using two quoins together is extravagant, and will not permit of the forme being locked-up tightly or squarely, as a moment's reflection will show, on comparing a quoin and a side-stick together, fig. 74. The use of leads in

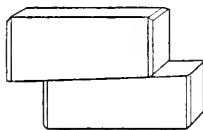

Fig. 73.



Fig. 74.

quoining-up is to be deprecated as a wasteful and slovenly habit. Furniture which is worn and not good enough for placing between pages to form margins is of service in quoining-up; therefore the use of good furniture for this purpose should be forbidden. When formes are sent to press or machine great care should be exercised in straight-edging after gauging-up the margins, and one scale-board at least should be placed on either side of the cross-bars; this will allow of correct register being obtained if the pages do not back properly. When the first forme has been approved of, a furniture gauge should be made, say of card, in order that all the successive sheets of the same work may be uniform as regards margin.

CHAPTER VII.

The Locking-up of Formes—The Forme Carriage—Pulling the Proofs—Making Corrections in the Metal—The Space Paper or Box—Signs and Marks used by Readers in Correcting Proofs—Clean Proofs.

AFTER quoining-up the forme and seeing that the furniture is in proper position, the type may be lightly planed down with the special tool for that purpose. Let each stroke with the mallet hit the planer firmly and flatly, and do not drag or push it over the surface of the type. In locking-up, always tap up the foot of the pages first; this prevents the springing and bending of the leads, if a leaded work, whereas in unlocking a forme unfasten the sides first for the same reason. The whole forme should be locked-up equally all round, and not too tightly, as much pressure will cause the pages to spring. This fact can always be detected in re-planing down after locking-up, for if the type is on its feet, as it should be,

the slightest touch will make it apparent. Should the forme have sprung, unlock it and put it square again—by no means attempt to put it down by the use of the planer. Too much care cannot be used in the wielding of this, for in incompetent hands it is a dangerous and destructive implement. After this has been performed satisfactorily, the forme should be raised very carefully and slightly to see if the whole lifts. Should it not, it may be due to bad justification of lines, “binding” of furniture, or imperfect gauging of pages or furniture. If such is the case, the cause must be found out and the defect remedied. All being well, the proof can then be taken and passed over to the reading department; this proof being termed a “first” proof.

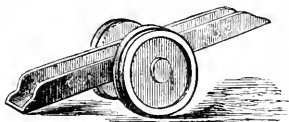

Fig. 75.

A useful carriage for moving formes about is the *forme trolley*, fig. 75. Rubber tyres are placed round the wheels to render them noiseless.

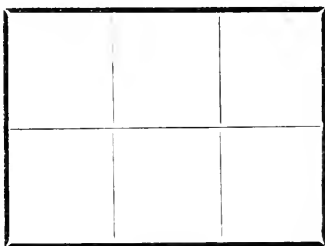

Fig. 76.

When the proof has been read by the corrector of the press, the forme should be laid upon the imposing surface and unlocked in the manner described above.

Making corrections.—The compositor should be provided with a *space-paper* or *space-box*, fig. 76, a small tray con-

taining usually six divisions; these hold the spaces of the fount about to be corrected.

Assuming the corrections are not very heavy, gather the necessary letters in your fingers, and when you have collected as many as you can comfortably hold, place them between the first and second fingers of the left hand, fig. 77; then



Fig. 77.

with the help of a bodkin proceed to correct the errors as marked in the proof. In substituting other letters be careful to see that the alteration leaves no difference in the justification; if it does, space the line out again as before. In the case of any omissions or repetitions of words—called respectively “outs” and “doubles”—it is best to lift out that portion of the matter likely to be affected by the error, place it on a galley, and put it through the stick again; this insures better justification, and will facilitate the correction. Certain signs and marks are used by the readers in correcting the proofs; the two samples given at pp. 94-5, uncorrected and corrected, will give the usual characters in vogue in most offices.

It is perhaps best that the learner should compare each separate mark with the corrected page; they will then be committed to memory with greater ease. We give, however, an explanation of some of the signs:

SYNOPSIS OF READERS' MARKS.

- This indicates that the line has to be indented one em of its own body.
- ⊙ A full-stop or full-point has to be inserted.
- Trs.* A transposition of a word or words.
- Ital.* Change roman into *italic*. Also indicated by underlining the word or words to be in *italic*.
- l. c.* A capital or small capital to be changed to a lower-case letter.
- Rom.* Change *italic* into roman.
- Cap.* A lower-case or small capital letter to be changed to a capital.
- Sm. Cap.* A lower-case or capital letter to be changed to a small capital.
- × A bad or battered letter.
- Stet.* Matter wrongly altered shall remain as it was. Dots are usually placed under the matter in question.
- # A space has to be inserted.
- └ Space to be reduced.
- ∩ A turned letter.
- New par.* or *n. p.* or [Commence a fresh line.
- Run on.* Sentence not to commence a new line, but to follow on previous matter.
- ∂ Delete or expunge.
- ┑ A space or quadrat standing high to be pushed down.
- w.f.* Denotes a wrong-fount letter.
- Equal.* Equalize spacing throughout the line.
- ∫ The matter has something foreign between the lines, or a wrong-fount space in the line, causing the types to get crooked.
- 7 When a superior letter or inverted comma is required to be inserted in the matter, it is usually written over this sign.
- ⊂ The words or letters over which this is marked to be joined.

Page showing corrections.

□ Do not try to correct the faults of hurried making-ready by a weak impression, and by carrying an excess of ink to hide the weakness. Excess of ink fouls the rollers, clogs the type, and makes the printed work smear or set off. A good print cannot be had when the impression is so weak that the paper touches (barely) the ink on the types and is not pressed against the types. There must be force enough to transfer the ink not only on to the paper, but into the paper. A firm impression should be had, even if the paper be indented. The amount of impression required will largely depend on the making-ready. With careful making-ready, impression may be light; roughly and hurriedly done, it must be hard. Indentation is evidence of wear of type. The spring and resulting friction of an elastic impression surface is most felt where there is least resistance—at the upper and lower ends of lines of type, where they begin to round off. It follows that the saving of time that may be gained by hurried and rough making-ready must be offset by an increased wear of type. That impression is best for preventing wear of type which is confined to its surface and never laps over ~~over~~ its edges. But this perfect surface impression is possible only on a large forme with new type, sound, ~~soft~~ packing, and ample time for making-ready. If types are worn, the indentation of the paper by impression cannot be entirely prevented. Good presswork does not depend entirely upon the press or machine, neither on the workman, nor on the materials. Nor will superiority in any ~~one~~ point compensate for deficiency in another: new type will suffer from a poor roller, and careful making-ready is thrown away if poor ink be used. It is necessary that all the materials shall be good, that they should be adapted to each other and fitly used. A good workman can do much with poor materials, but a neglect to comply with one condition often produces as bad a result as the neglect of all.

If the foregoing facts are carefully studied many difficulties will be overcome in obtaining really good work.

ital
tro
sket of
l.c.
T/
new par
H
l.c.
L #
d/
h/
m/
run on
x
/ rom
L
!
x
n/
the/
of
here
wf.
x
d/
3
3
!
x

Page as corrected.

Do not try to correct the faults of hurried making-ready by a weak impression, and by carrying an excess of ink to hide the weakness. Excess of ink fouls the rollers, clogs the type, and makes the printed work smear or set off. A good print cannot be had when the impression is so weak that the paper barely touches the ink on the types and is not pressed against the types. There must be force enough to transfer the ink not only on to the paper, but into the paper. A firm impression should be had, even if the paper be indented. The amount of impression required will largely depend on the making-ready. With careful making-ready, impression may be light; roughly and hurriedly done, it must be hard; indentation is evidence of wear of type. The spring and resulting friction of an elastic impression surface is most felt where there is least resistance—at the upper and lower ends of lines of Type, where they begin to round off. It follows that the saving of time that may be gained by hurried and rough making-ready must be offset by an increased wear of type.

That impression is the best for preventing wear of type which is confined to its surface and never laps over its edges. But this perfect surface impression is possible only on a large forme with new type, sound, hard packing, and ample time for "making-ready." If types are worn, the indentation of the paper by impression cannot be entirely prevented: good presswork does not depend entirely upon the press or machine, neither on the workman, nor on the materials. Nor will superiority in any point compensate for deficiency in another: new type will suffer from a poor roller, and careful making-ready is thrown away if poor ink be used! It is necessary that all the materials shall be good, that they should be adapted to each other and fitly used. A good workman can do much with poor materials, but a neglect to comply with one condition often produces as bad a result as the neglect of all. If the foregoing facts

Clean proofs.—When the proof has been finished, it is customary in the absence of other instructions to pull two clean revises to send out to the author or customer, but should the compositor have failed to make good all the errors in his first proof, he would have to correct the forme at his own expense the second time; therefore it is to his advantage to use every care in his corrections.

The different stages here enumerated, viz., composing, distributing, making-up, making margins, imposing, and correcting, are those applied to book-work. These operations apply also to jobbing work and newspaper work to some extent.

CHAPTER VIII.

Jobbing Work—The Character of Types used—Wood Types and their Receptacles—Preserving Wood-letter and Cuts—Ornaments, Borders, and Brass Rules—The Classification of Faces—The Adjustment of Border Rules—Curved Work.

WITH regard to *jobbing work*, which is a large subject, and embraces all kinds of small work, such as circulars, cards, programmes, invoice forms, memorandums, and the like, a great amount of taste and practice is required.

Jobbing types may be obtained in three classes, so to speak—plain, fancy, and grotesque or fantastic. The last variety is to be shunned if really good taste is to be displayed, and this rule is applicable to the type ornaments and borders of the same kind. Over-ornamentation or elaborateness is to be avoided in displaying, for nothing after all is so effective as boldness and simplicity. A few specimens of jobbing or fancy types

have already been given. Whilst simplicity is recommended, it is not desirable that a printer should never add new faces to his stock. Curved lines and an excessive amount of rule-work are not in keeping with letterpress printing, we venture to think; such work is more in harmony with lithography. Special cases for jobbing types are made by the printer's joiners, and a double and treble case have been shown. The selection of these, however, should be determined by the size of type and the quantity to be in

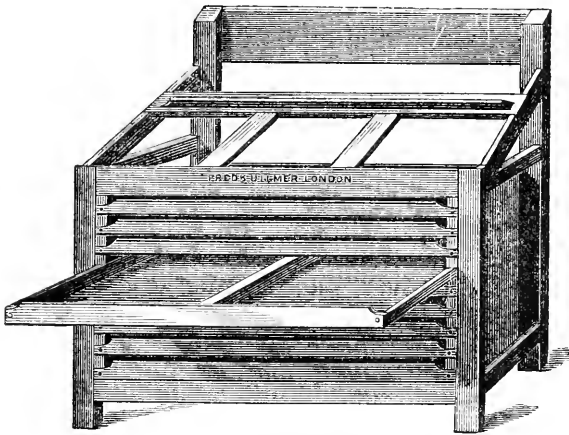

Fig. 78.

use. Wood-type, used for broadside and other similar work, should be kept on trays, fig. 78, or special shelves for the purpose—the plan shown here is a convenient one.

To Preserve Wood-Letter and Cuts.—To prevent warping in blocks and wood-letter used in large bills, they should be placed in a zinc basin, provided with an air-tight lid, and then thoroughly saturated with paraffin oil; after being left thus for about four days, they should be wiped with a clean, dry rag. Prepared in this way, when new, wood-letter is

said to resist the effects of lye, petroleum, turpentine, and atmospheric changes.

Ornaments, borders, and brass rules of the different varieties should all have their proper places. The special case given in the earlier portion of this work is a useful article, especially for short lengths. These may include the short fancy or "French" rules, fig. 79, used for displaying.

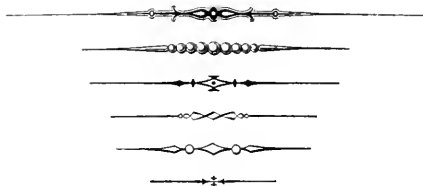

Fig. 79.

Jobbing work involves a great deal of display as a rule, but each class of jobbing requires a different treatment; what would be effective in a poster would be vulgar for a smaller job, such as a small show-bill. Regard must be given to a customer's taste and the nature of the work. Having taken these two things into consideration, the next point is to study the copy and find the most important lines requiring prominence. In setting, do not mix indiscriminately old face, old style, or modern faces, but keep to one class as far as possible. Use extended or condensed founts only where absolutely necessary, such characters being out of place when used simply for the sake of effect rather than necessity. For commercial announcements perhaps a bolder display is required, but for private work, such as circular letters or invitation cards, a more simple style may be adopted. Where ornamentation is used, do not crowd the lines in order to make room for your design,

but rather use your ornament as a secondary consideration. In selecting these do not mix your styles, but keep to the same character as your type, for it is inconsistent to use, say, a gothic kind of ornament with light and modern types. If fancy types are adopted, use them sparingly.

Where rule borders are required, it is best to mitre your corners in order that they may join correctly. For this purpose special mitring machines may be obtained, but if the brass rule to be used is not thicker than four-to-pica, it may be filed at the ends to an angle of forty-five degrees to allow of a square border being obtained. In

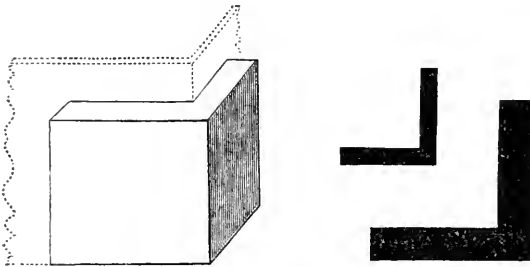

Fig. 80.

selecting brass rule it is best as far as possible to confine the choice to one thickness, for it is very confusing to have several thicknesses in general use. Where rule-borders are required for a series of pages, it is, however, best to have thicker brass, for the stouter it is the better it will join when locked-up, provided of course the mitres are true. Metal *corners*, fig. 80, are very useful in mitred rule-work, making it easy to obtain a perfect join at the corners, especially if placed both inside and out. They are cast the same height as quadrats.

Oxford borders, fig. 81, may be made in two ways—by giving the full length one side, and carefully cutting and

justifying the small odd piece of the other corner, or by taking a riband file of the proper thickness and morticing slots at the ends, a little below the centre of the height—of course reversing half of the rules first. When finished



Fig. 81.

they can be fitted in over each other, thus forming a perfect and fixed frame.

If curved or circular lines are really required in certain

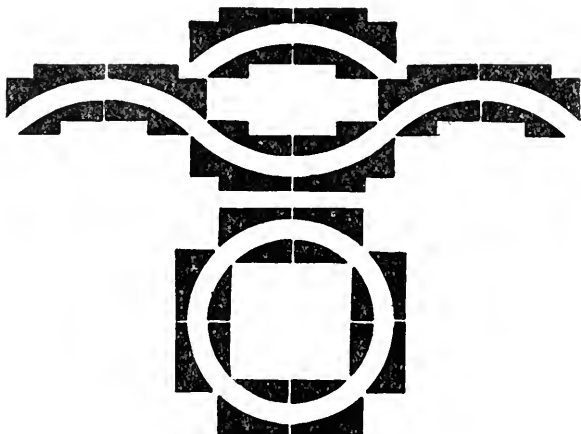

Fig. 82.

jobs, there are various ways of making them. Special pieces of metal can be obtained, somewhat of the nature of the appended designs, fig. 82, cast to different widths and sizes,

and there are other methods invented and sold by the different type-founders, but for general and miscellaneous work they may be improvised with a little ingenuity. Brass rules, of a soft calibre, and leads may be adopted for this purpose. After determining the shape and extent of your curve, bend your material to the size. Two corresponding pieces of the curving material will be required to hold the line on either side in its position. If only a small curve is needed, it can be built up in the composing stick, but if a large one, it must be boxed in on the galley by means of furniture placed round in order to keep it in its defined position. After the line is set, it must be gradually squared up by means of the lines of type on either side of it, with quadrats of various bodies to assist it. If the angles are too sharp, and more solidity is wanted, plaster of Paris may be used to fill up the interstices, care being taken not to mix it too liquid, as it will take so much time in drying and getting hard.

For the printing of certain designs, *brass circles*, fig. 83, and oval shapes of various sizes can be obtained. Those cast on square bodies are recommended for simplicity in justifying.

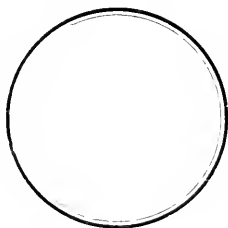

Fig. 83.

CHAPTER IX.

Colour Work—Selection of Suitable Types for Rubricated Lines—Methods of making Skeleton Formes or Underlaying for Different Colours—Tint Blocks, how they can be made.

THE subject of *colour work* to some extent comes under the head of jobbing. Supposing we have a few lines of red in a job, those lines should be set in a good bold face, otherwise red lines look very poor and meagre, more especially in a short line. Avoid two red lines close together, and distribute them over the page, balancing the top with the bottom; where a large page, if possible have a line in the centre. If an initial letter has to be rubricated, do not use electrotype letters, as the copper has a deteriorating effect on the red ink, but have nickel-faced or white metal letters.

It is customary to prepare colour formes for press by one of two methods. The first is by drawing the red lines from the forme, and substituting a line of quadrats of the same body as that withdrawn. When the black is printed, these white lines would be lifted out, and the red lines dropped in their exact place, the line first being underlaid by means of a thick lead cut to the width of the type in body. This plan raises the lines that height above the first forme printed. The impression of the machine or press being altered will allow of this additional height, and only the raised lines will be printed by the second working, if made ready properly. The other process is to make a skeleton forme up entirely of the lines to be printed in colour, supposing there are many, or there are any difficulties in the way of printing. In the first place, the lines in colour should be withdrawn as in the former plan, and lines of quadrats of their own bodies substituted. But before this

is done, it is better to have a proof taken of the forme on dry paper, in order that the skeleton forme may be made up correctly. The dry paper obviates any shrinking which would occur in the case of a damped sheet. The different lines would be then spaced out to the desired distances as in the proof, which may be folded for the purpose. All justification material in this forme should be as solid as possible—more metal than wood, as the latter gives in locking-up, and is subject to fluctuation through atmospheric conditions. The latter method is preferable for colour work where there are many lines to print in the second colour, or other complications, and it is also best for machine work. The first method is recommended especially for press work, and particularly so when there are but few lines to print. We have assumed in giving these directions, for the sake of illustration, that the work is a two-colour job, and a red and black one, but the same rules apply to any colour, or any number of workings—each colour being a distinct printing. For the formation of grounds in the working of tinted backgrounds, the following hints may be found useful.

Blocks for Tinted Grounds.—These may be made of various materials, such as brass, type-metal, box or other wood, celluloid, &c., and a printer in any great commercial centre is always able to satisfy his requirements almost at a moment's notice. A provincial printer may be seriously inconvenienced when one of his customers takes a fancy to colours. The way small German printers help themselves may, therefore, be read with advantage. They take a very smooth and even glazed board, such as is used in pressing and glazing the paper after printing, and cut two or three pieces out of it, a little larger than the desired tinted block. Similar pieces are cut out of common pasteboard, well sized and smooth, and the whole is then formed into a layer with best glue, and stuck, also with glue, on a solid wooden board

—oak will suit best—so as to form a type-high block. This done, the block is put into a glazing press, or into a letter-copying press, or you may simply put boards and heavy weights on it, just to let it dry under severe pressure, care being taken that the pasteboards are well united to each other and to the wooden block, as the result depends on this. When the wood and paper block is completely dry, the transfer may be made. The forme to which the tinted block is to fit is locked-up in a frame, as also is the block itself, the latter being disposed so as to fit in the composed matter as exactly as possible. Then this last one is lifted into the press or machine, and, after being well inked, one pull is made from it on to a sheet fixed on the tympan or cylinder. This done, the formes are changed, the block forme taking the place of the composition forme, after a sheet of thin pasteboard, of the thickness of common Bristol board, has been put on the bed of the press, to raise the block a little above type height to give more effect to the pull. The tympan, still bearing the impressed sheet, being now brought down and a pull taken, a negative copy of the contents of the forme will be obtained on the glazed-board block, the cutting of which may now be proceeded with. That operation is best effected with a thin penknife, or even with a small chisel, care being taken to cut in an outward slanting direction, so as to give the printing surface of the block a larger and stronger basis. When the cutting is finished, the block is ready for printing; but should the number of copies to be printed from it be large, it is better to give it first a coating of varnish. A coating of shellac, diluted in alcohol, applied twice, has proved most effective, and will stand the printing of a very large number of copies before any change is to be observed. In cleaning, lye must be avoided, and only a little petroleum or turpentine rubbed over with a smooth rag. When the tinted ground is to show a pattern, this may be obtained by sticking embossed paper

on it, taking care to fill the indentations of the paper well with stiff glue, and to paste it thus on the block. When dry, it may be varnished and printed from as before stated.

CHAPTER X.

Newspaper Work—The Qualifications necessary for News-hands—Making even—Composing Machines in the Market—Description of the Linotype and Thorne Machines.

IN *newspaper work* the ordinary compositor performs a somewhat mechanical part, composing and distributing alternately being his task all the year round. The charge of and the giving out of copy, the making-up, and in fact the entire control of a paper, is in the hands of the “printer,” as the responsible person is called, with his subordinate. The ordinary journeyman is paid by piecework. The payment is determined by lines and galleys—a galley being dependent on size of type—Minion being almost exclusively adopted for news-work. It is requisite that all compositors employed in this class of work should be expeditious and careful in their work, a clean proof being a great recommendation for a news-hand. A mere type-lifter, one regardless of errors, would soon be despatched about his business.

To suit the exigencies of the early issues, and otherwise to expedite the composition, copy is given out in very small “takes;” each man has to “make even” in the absence of a paragraph ending, and therefore spacing has very largely to be sacrificed. Bad spacing can be obviated to a great extent by practice and foresight on the part of the compositor. In the case of most newspapers, at any rate those of a medium or large circulation, the formes, as soon as made up into the required pages, are sent to the

stereotyping department, and it is astonishing how quickly finished plates can be turned out for printing purposes. For short numbers perfecting machines are mostly used, whereas for the longer ones rotary machines, requiring stereotype plates curved or bent for attachment to the type cylinders, are made, and these are printed from a continuous web of paper, perhaps two or three miles in length. These machines have the necessary appliances for damping, reeling the paper, and cutting and folding in most instances. The laying-on and taking-off by the means of flyers is purely mechanical, and thus the whole is automatic. These machines will be referred to in due course. In the ordinary way there is nothing particular in the production of newspaper work, beyond its wonderful resources for turning out great numbers of copies in a short time, but this applies more to the actual printing operation, whilst the mere composition is a bare repetition day by day, and therefore does not call for any particular description. Perhaps, in connection with news-work, the mechanical contrivances for type-setting may be mentioned, but none of these have proved any great success at present, whatever may be the result of time. Some of the best perhaps are the Linotype and the Thorne machines.

The *Linotype* is the latest introduced, and no doubt is the nearest to perfection, but it will have to be improved as regards its reliability for continuous working. The shape is somewhat that of the old-fashioned square or vertical pianoforte. Vertical tubes or magazines, placed in front of the operator, hold the matrices, which are set up into line. These matrices, made of brass, are liberated by the operator touching the keys, the plan of which is similar to that used for type-writers. When the matrix is liberated, it falls into a channel, and then by a blast from an air-pipe it is carried along to the receiver, and the line, made up to the given measure, is formed in the same manner as

with types. When this line is completed, it is justified by the means of wedge-shaped spaces, already inserted as composed, which are pushed up from the bottom till the line is tightened out. When this is finished, it is carried to the casting-box, and the line is cast in one piece. Thus the page or column is made up entirely of lines of type, the name "line o' type" being derived from this fact. When the line of matrices leaves the casting apparatus, it is carried up and passes along an endless band, and as each matrice arrives opposite its own tube, it falls into its proper place as before. This ingenious arrangement is caused by certain nicks or grooves on each matrice, which correspond to the ridges on a stationary bar situated on the top of the tubes. In the event of a letter or matrice being dropped into the wrong receptacle, the operator's attention is called to the fact by an electric bell, and the distributing process is at once stopped. Beyond the keys being manipulated, the remainder of the different actions are entirely automatic, for whilst the first line is being stereotyped or cast, the second is set, and again, whilst the third is being composed, the second is cast and the first distributed, the whole three operations going on simultaneously. This is, of course, repeated over and over again, the metal, heated by gas, being kept all the time to a proper temperature. This last particular is important, as the proper sharpness of face and squareness of body are dependent on the heat being maintained at an equable standard. The great advantages of this machine are its expedition, its self-spacing or justifying arrangements, and its dispensation with type entirely, the matrices being used over and over again, and thus saving the enormous amount of plant, and consequent space, that would otherwise be required for any method where type was used in bulk. Again, when the lines of type are done with and melted down, a considerable percentage of the cost is returned.

The principal features of the *Thorne* Type-setting and Distributing Machine are a keyboard and two vertical cylinders having the same axis, the upper one resting on the lower. Both cylinders are cut with a number of vertical grooves of such a form as to receive the type, which is to be first distributed and then reset. There are ninety of these vertical grooves in each of the cylinders, sufficient to contain enough characters for ordinary purposes. When a key is depressed the letter corresponding to it is ejected from its proper groove in the lower cylinder upon a circular and revolving table which has the same axis as the cylinder, but is of larger diameter. A number of types may thus be ejected from the grooves in each revolution of the disc, and all are brought round in their proper order to a point of delivery where they are conveyed by a travelling band and carried continuously to a setting stick in front of the keyboard and thence to a galley. The necessary justifying is done by a second operator, who sits opposite a small case containing spaces, quadrats, and so forth. The control of the types is effected by forming on the side of each character recesses something like the wards of a key, the arrangement, of course, being different for each different character. The grooves in the lower cylinder are provided with projections corresponding to those on the types, so that no type will fall into any groove other than that for which it is intended. This arrangement applies only to the cylinder, which does not revolve. The grooves in the distributing cylinder are large enough to receive all the types indifferently that are fed into them. Distribution is effected as follows: An attachment to the side of the upper cylinder enables the operator to place the galley containing the type to be distributed in contact with the cylinder, and by a very simple device line after line of type is fed into the cylinder until every groove is nearly filled, and the upper cylinder is caused to revolve upon the

lower one, with which it is in contact. As the columns of mixed type pass over the heads of the shaped grooves of the lower cylinder, letter by letter falls into its proper groove as soon as the nicks in the types find their corresponding wards.

CHAPTER XI.

Classical and other Languages—The Cases used for Greek, Hebrew, and German, with Plans of Lays in general use—Rules for Composition in these Languages.

IN connection with composition we must not forget classical or foreign languages which require special cases, as also some amount of experience in setting. The languages which the compositor has to deal with more generally are Greek, Hebrew, and German. For those different from English, but set in roman types, the ordinary cases, plans of which we have already given, are used. The schemes of the Greek and Hebrew cases are somewhat complicated, especially the former, but if the learner has some superficial idea of the language he proposes to set, or at least is conversant with the alphabet, he will find either circumstance a good stepping-stone to an easy acquirement of the knowledge he seeks. The accents are very confusing at first, but a little perseverance will soon overcome the apparent difficulties.

GREEK.

The plan of *Greek cases* shown, fig. 84, is one generally in use, but offices which make their speciality in printing these languages adopt their own lay, and frequently have cases of a different make.

PLAN OF GREEK CASES.

A	B	Γ	Δ	E	Z	H	á	à	ã	â	ä	å	ã	ä	å	ã	ä	å	ã	ä	å	ã	ä	å	
Θ	Ι	K	Λ	M	N	Ξ	έ	ε	ẽ	ê	ë	ê	ë	ẽ	ê	ë	ẽ	ê	ë	ẽ	ê	ë	ẽ	ê	ë
O	Π	Ρ	Σ	T	Υ	Φ	ή	η	ñ	ή	η	ñ	ή	η	ñ	ή	η	ñ	ή	η	ñ	ή	η	ñ	ή
X	Ψ	Ω	ξ	ρ	η	φ	ί	ι	ï	î	ï	î	ï	î	ï	î	ï	î	ï	î	ï	î	ï	î	ï
		ς	ς				ó	ò	õ	ô	õ	ô	õ	ô	õ	ô	õ	ô	õ	ô	õ	ô	õ	ô	õ
ς	ς	ς	ς	ς	ς	ς	ύ	υ	ÿ	ύ	υ	ÿ	ύ	υ	ÿ	ύ	υ	ÿ	ύ	υ	ÿ	ύ	υ	ÿ	ύ
ς	ς	ς	ς	ς	ς	ς	ώ	ω	ώ	ω	ώ	ω	ώ	ω	ώ	ω	ώ	ω	ώ	ω	ώ	ω	ώ	ω	ώ

Upper Case.

Kerns

α	ε	η	ο	υ	ω	Thin and Mid. Spaces	σ	ς	ψ	ρ̇	ρ̇
β	ε	γ	δ	ε			ι	η	θ	φ	χ
κ	λ	μ	ν				ο	π	ρ	En Quadrats	Em Quadrats
ξ	ζ	υ	τ	Thick Spaces			α	ω	ι	ρ	Quadrats
									·	·	

Lower Case.

Fig. 84.

The following alphabet and remarks generally on Greek will assist the student.

We are indebted to R. Hope's Compositors' Primers on Greek and Hebrew, now out of print, and Savage's "Dictionary of the Art of Printing," for much of the information here given.

GREEK ALPHABET.

Characters.		Name.	Power.	Numerals.
Capitals.	Small Letters.			
A	<i>a</i>	Alpha	<i>a</i>	1
B	<i>β β</i>	Beta	<i>b</i>	2
Γ	<i>γ</i>	Gamma	<i>g</i>	3
Δ	<i>δ</i>	Delta	<i>d</i>	4
E	<i>ε</i>	Epsilon	<i>e</i> short	5
Z	<i>ζ</i>	Zeta	<i>z</i>	7
H	<i>η</i>	Eta	<i>e</i> long	8
Θ	<i>θ θ</i>	Theta	<i>th</i>	9
I	<i>ι</i>	Iota	<i>i</i>	10
K	<i>κ</i>	Kappa	<i>k</i> or <i>c</i>	20
Λ	<i>λ</i>	Lambda	<i>l</i>	30
M	<i>μ</i>	Mu	<i>m</i>	40
N	<i>ν</i>	Nu	<i>n</i>	50
Ξ	<i>ξ</i>	Xi	<i>x</i>	60
O	<i>ο</i>	Omicron	<i>o</i> short	70
Π	<i>π</i>	Pi	<i>p</i>	80
P	<i>ρ ρ</i>	Rho	<i>r</i>	100
Σ	<i>σ σ</i>	Sigma	<i>s</i>	200
T	<i>τ</i>	Tau	<i>t</i>	300
Υ	<i>υ</i>	Upsilon	<i>u</i>	400
Φ	<i>φ</i>	Phi	<i>ph</i>	500
X	<i>χ</i>	Chi	<i>ch</i>	600
Ψ	<i>ψ</i>	Psi	<i>ps</i>	700
Ω	<i>ω</i>	Omeg'a	<i>o</i> long	800

VOWELS, DIPHTHONGS, AND CONSONANTS.

The Greek alphabet consists of twenty-four letters—seven vowels and seventeen consonants. The vowels are *α, ε, η, ι, ο, ω, υ*.

There are twelve diphthongs, viz.—

Proper : *αι, αυ, ει, ευ, οι, ου*.

Improper: α , η , φ , $\eta\nu$, $\nu\iota$, $\omega\iota$ —the point under these vowels denoting that *iota* (ι) is subscribed.

Because capitals have no subscripts, the ι is put in lower case to the capital letters.

The consonants are divided thus—

<i>Gutturals.</i>	<i>Labials.</i>	<i>Linguals.</i>
κ , γ , χ .	π , β , ϕ , μ .	τ , δ , θ , λ , ν , ρ , σ .

Again, according to the form in which the organs of speech act in their formation—

<i>Liquids.</i>	<i>Sibilant.</i>	<i>Mutes.</i>
λ , μ , ν , ρ .	σ .	π , κ , τ , β , γ , δ , ϕ , χ , θ .

These mutes are also divided—

	<i>Soft.</i>	<i>Hard.</i>	<i>Aspirated.</i>	<i>Sound.</i>
Gutturals	κ ...	γ ...	χ ...	k .
Labials	π ...	β ..	ϕ ...	p .
Linguals	τ ...	δ	θ ...	t .

In compounds, when the first word ends in s , the final form of the Sigma (ς) may be used. This form ς sometimes becomes τ , when it is equivalent to $\sigma\tau$ (st).

ACCENTS.

Accents are supposed to have been introduced into the language to facilitate its pronunciation for strangers. The ancient Greeks never used them, and it is not an easy matter to tell when and why they were first introduced.

Accents, by the Greeks called $\tauόνοι$, tones, are the rising or falling of the voice in pronunciation; which may be considered either separately in distinct syllables, or conjunctively in the same syllable.

There are three accents: two simple, viz., the acute,

ᾶξῶς, figured thus (´), which denotes the elevation of the voice; and the grave, βαρῶς, shaped thus (`), to signify the falling or depression of the voice; and the circumflex, περισπῶμενος, which was formed first of these two lines or points joined together, thus (˘), and afterwards was changed into a round sort of a figure like an inverted Upsilon, thus (α), but at length came to be figured like an s drawn crossways (˜).

The Acute (´) raises the voice, and is only used upon one of the three last syllables of a word.

The Grave (`) depresses the voice, and can only be used upon the last syllable of a word.

The Circumflex (˘) lengthens the sound, and occurs either upon the last syllable of a word, or the last but one.

The Greek vowels allow of two Spirits, or breathings: the *Asper* (´), which the Greeks use instead of the letter *h*; and the *Lenis* (`), which denotes the absence of the *h*.

All vowels beginning a word have a Spirit over them; but Upsilon (υ) allows of no other than the *asper*.

When the letter ρ begins a word it has an *asper* over it; and where two ρ's come together in a word, the first has a *lenis*, and the second an *asper*; as, ῥῥῶς.

The Apostrophe (´) is used for striking out the vowels α, ε, ι, ο, and sometimes the diphthongs αι and οι, when they stand at the end of a word or syllable, followed by another vowel beginning a word or syllable. Elision takes place in all the prepositions, except περι and προ. Sometimes it unites two words.

The Diæresis (¨) is used to separate one vowel from another, and to prevent their being taken for diphthongs.

Every vowel in Greek is pronounced as a separate syllable.

Points.—The comma, the period, and the exclamation in Greek are the same as in English; but the interrogation

(;) is our semicolon; and the colon is a point at the head of a letter, as (˙)—nothing more than an inverted period.

ASPIRATES AND ACCENTS.

˘	Lenis.	°	Asper grave.
˘	Asper.	-	Circumflex.
˘	Acute.	˘	Circumflex lenis.
˘	Grave.	˘	Circumflex asper.
˘	Lenis acute.	˘	Diæresis.
˘	Lenis grave.	˘	Diæresis acute.
˘	Asper acute.	˘	Diæresis grave.

Compositors who are not Greek scholars should pay attention to what has been said above relating to the proper situations of the spirits and accents, as by attending to this many faults may be avoided. The following rules should be committed to memory :

No word can have an *accent*, except over one of the three last syllables.

No *spirit* can be placed over a vowel, except at the beginning of a word.

The *Grave* (˘) over the last syllable of a word; and

The *Asper Grave* (°) and *Lenis Grave* (˘) over a few monosyllables.

The majority of words in the Greek language have an *accent*, and rarely have more than one; when there is a second, it is an *acute* thrown back upon the last syllable from an enclitic, which is not accented, except it be followed by another enclitic. No word can have an *acute* accent over the last syllable but in this case, except before a period, colon, or interrogation, when the *grave* is changed to an *acute*—an occurrence which has led compositors, ignorant of the principles for accenting the same word differently in different situations, to imagine that there was an error in their copy.

NUMERALS.

Numbers are expressed by the whole alphabet and three symbols, which make them to consist of twenty-seven sorts. They are divided into three classes—units, tens, and hundreds; as—

No. 1.	No. 2.	No. 3.	No. 4.
<i>Units.</i>	<i>Tens.</i>	<i>Hundreds.</i>	<i>Thousands.</i>
α 1 ...	ι 10 ...	ρ 100 ...	α 1,000
β 2 ...	κ 20 ...	σ 200 ...	β 2,000
γ 3 ...	λ 30 ...	τ 300 ...	γ 3,000
δ 4 ...	μ 40 ...	ν 400 ...	δ 4,000
ϵ 5 ...	ν 50 ...	ϕ 500 ...	ϵ 5,000
ς 6 ...	ξ 60 ...	χ 600 ...	ι 10,000
ζ 7 ...	\omicron 70 ...	ψ 700 ...	κ 20,000
η 8 ...	π 80 ...	ω 800 ...	ρ 100,000
θ 9 ...	\beth 90 ...	ϑ 900 ...	σ 200,000

Column No. 1 consists of the eight first letters of the alphabet, with this form ς (*st*), called *ἐπίσημον*, which signifies 6.

Column No. 2 contains the eight following letters, with this character \beth , called *κόππιά*, which signifies 90.

Column No. 3 includes the eight last letters of the alphabet, with this additional character ϑ , called *σάνπι*, which signifies 900.

The acute (,) under each letter in column No. 4 stands for a thousand, and the letter expresses the number of thousands signified.

By compounding the above numerals any number may be expressed; as, $\alpha\alpha$ makes 11; $\kappa\epsilon$, 25; $\rho\gamma$, 103; $\alpha\epsilon$, 1,005.

Also, the Greeks sometimes use the following six capitals to express sums, I for 1; II for 5; Δ for 10; H for 100; X for 1,000; and M for 10,000.

The above capitals may be all four times reduplicated,

except Π ; thus, Π for 2; III , 3; IIII , 4; $\Delta\Delta$ for 20; $\Delta\Delta\Delta$, 30; $\Delta\Delta\Delta\Delta$, 40.

Sometimes the Delta, Eta, Chi, and Mu are enclosed in a great \square , and then the value of the letter is five times repeated; as, $\square\Delta$, 5 times 10 are 50; $\square\text{X}$, 5 times 1,000 are 5,000; $\square\text{M}$, 5 times 10,000 are 50,000.

Words in Greek intended to be emphasized or "italicized" are usually hair-spaced.

By following the instructions carefully the student will derive great assistance in composing Greek, and thus avoid a dirty or foul proof.

In turning out occasional words of this language, or even any other, in ordinary roman distribution, they should be laid aside for the moment, and afterwards returned into their proper cases.

HEBREW.

Hebrew cases are almost identical to the roman ones, the upper case containing the same number of divisions precisely as the ordinary upper case; the lower case being similar, excepting a few extra divisions to the larger boxes, fig. 85. This, of course, is due to the fact that far fewer accents are used in Hebrew, or rather, we should say, a smaller number of accented letters—the accents themselves are greater in number than in Greek, but used more sparingly. The learner, therefore, has an easier task in acquiring a knowledge of the cases, but is not called upon so often to exercise that knowledge, as in the ordinary run of book-work, theological works excepted, Hebrew is less used than Greek.

PLAN OF HEBREW CASES (WITH POINTS).

א	ב	ג	ד	ה	ו	ז	ח	ט	י	כ	ל	מ	נ	ס	פ	צ	ק	ר	ש	ת
א	ב	ג	ד	ה	ו	ז	ח	ט	י	כ	ל	מ	נ	ס	פ	צ	ק	ר	ש	ת
א	ב	ג	ד	ה	ו	ז	ח	ט	י	כ	ל	מ	נ	ס	פ	צ	ק	ר	ש	ת
א	ב	ג	ד	ה	ו	ז	ח	ט	י	כ	ל	מ	נ	ס	פ	צ	ק	ר	ש	ת
א	ב	ג	ד	ה	ו	ז	ח	ט	י	כ	ל	מ	נ	ס	פ	צ	ק	ר	ש	ת
א	ב	ג	ד	ה	ו	ז	ח	ט	י	כ	ל	מ	נ	ס	פ	צ	ק	ר	ש	ת
א	ב	ג	ד	ה	ו	ז	ח	ט	י	כ	ל	מ	נ	ס	פ	צ	ק	ר	ש	ת

Upper Case.

				Vowel Points.					Final Letters.					Broad		Letters								
				א	ב	ג	ד	ה	ו	ז	ח	ט	י	כ	ל		מ	נ	ס	פ	צ	ק	ר	ש
Spaces and Quads. for justifying the Points.	Thick Spaces	Thin Spaces	Em Quads.	א	ב	ג	ד	ה	ו	ז	ח	ט	י	כ	ל	מ	נ	ס	פ	צ	ק	ר	ש	ת
	Thin Spaces	Thin Spaces	Em Quads.	א	ב	ג	ד	ה	ו	ז	ח	ט	י	כ	ל	מ	נ	ס	פ	צ	ק	ר	ש	ת
	Thin Spaces	Thin Spaces	Em Quads.	א	ב	ג	ד	ה	ו	ז	ח	ט	י	כ	ל	מ	נ	ס	פ	צ	ק	ר	ש	ת
	Thin Spaces	Thin Spaces	Em Quads.	א	ב	ג	ד	ה	ו	ז	ח	ט	י	כ	ל	מ	נ	ס	פ	צ	ק	ר	ש	ת

Lower Case.

Fig. 85.

From the plan here given it will be seen that the Hebrew cases are laid as near as is possible to the English method now in use. The alphabets have been classified and arranged so as to facilitate the composition; that is, the three different dotted alphabets in the upper case

are quite distinct from each other, sometimes being separated by a thicker partition, to lead the eye of the compositor to it with greater certainty. The lower-case letters are also arranged as near to the English plan as is possible. The א (*a*) in the a box ; the ב (*b*) in the b box, &c., so that the compositor can go from a pair of English cases to the Hebrew ones with very little perplexity, and a great saving of time, instead of looking over a wide surface of three cases, as formerly, without any classification or arrangement whatever. In composing Hebrew without points the lower case only is required, as the final letters and broad letters are brought into it.

Hebrew is read from the right to the left. Savage says, "In composing it, the general method is to place the nick of the letter downwards, and when the points are put to the top, to turn the line and arrange those points that come under the letters, taking care to place them in the following order: if the letter has but one leg, the point must be placed immediately under that leg, but otherwise the point must be placed under the centre."

Annexed is the alphabet, which consists of twenty-two letters, with vocal points, accents, &c. The remarks on the similarity of certain letters should be carefully noted, otherwise the student will find it a difficult task to acquire a knowledge of the cases and manner of composition.

HEBREW ALPHABET.

Number and Order.	Characters.	Name.	Power.	Numerals.
1	א	Aleph	<i>h</i> , unaspirated	1
2	ב	Beth	<i>v</i> , as in van; (ב) <i>b</i> , as in band	2
3	ג	Gimel	<i>g</i> , hard; (ג) <i>gh</i>	3
4	ד	Daleth	<i>d</i> , as in door	4
5	ה	He	<i>h</i> , soft; (ה) <i>h</i> , aspirated	5
6	ו	Vau	<i>v</i> or <i>w</i>	6
7	ז	Zain	<i>z</i> , as in zeal	7
8	ח	Cheth	<i>kh</i> , aspirated	8
9	ט	Teth	<i>t</i> , as in torn	9
10	י	Iod	<i>y</i> , as in young	10
11	כ	Caph	<i>k</i> or <i>c</i> , hard	20
12	ל	Lamed	<i>l</i> , as in law	30
13	מ	Mem	<i>m</i> , as in manner	40
14	נ	Nun	<i>n</i> , as in nothing	50
15	ס	Samech	<i>s</i> , as in sir	60
16	ע	Oin	<i>ng</i>	70
17	פ	Pe	<i>ph</i> , as in Philip; (פ) <i>p</i> , as in pint	80
18	צ	Tzadde	<i>tz</i> , as in howitzer	90
19	ק	Koph	<i>k</i> , as in lock	100
20	ר	Resh	<i>r</i> , as in road	200
21	ש	Shin	<i>sh</i> , as in shine	300
22		Sin	<i>s</i> , as in sin	
22	ת	Tau	<i>th</i> , as in thin; (ת) <i>t</i> , as in tin	400

FINAL LETTERS.

<i>Caph.</i>	<i>Mem.</i>	<i>Nun.</i>	<i>Pe.</i>	<i>Tzadde.</i>
ך	ם	ן	ף	ץ

BROAD LETTERS

are used in order to fill up the space and make a full line; as a Hebrew word is never divided as in English, so that a portion of it may be in one line and the remainder in another.

<i>Aleph.</i>	<i>He.</i>	<i>Cheth.</i>	<i>Lamed.</i>	<i>Mem.</i>	<i>Tau.</i>
א	ה	ח	ל	מ	ת

Compositors should strongly mark the difference between the following characters, which have some resemblance in shape:

- ב נ *Beth* projects a little at the bottom towards the right hand, but *Caph* is rounded.
- ג נ *Gimel* is open at the bottom towards the right hand, but *Nun* is closed.
- ד ר *Daleth* projects a little at the top towards the right hand, but *Resh* is rounded.
- ה ח ת The left upright stroke of *He* is separated from the horizontal one, but in *Cheth* it is joined to it; while that of *Tau* has a kind of foot.
- ז ו ן *Zain* projects a little at the top towards the right hand, but *Vau* is square; while the upright stroke of *Nun final* is longer than either *Zain* or *Vau*.
- ט כ *Teth* is open at the top towards the left hand, but *Mem* is open at the bottom.
- ם ס The right-hand corner of *Mem final* is square at the bottom, but *Samech* is rounded at that part.
- ע ז ץ The tail of *Oin* is sloped towards the left hand, that of *Tzadde* is horizontal, and that of *Tzadde final* is conveyed nearly straight downwards.

Capitals are not used in Hebrew; therefore letters of the same form, but of a larger body, are used at the beginning of chapters and other parts of works in that language.

VOWELS.

These points exhibit a system of marks or characters arranged either above, in the middle, or beneath the consonants. Their names, forms, and powers are as follows:

PERFECT VOWELS.				IMPERFECT VOWELS.					
Name.	Form.	Power.		Name.	Form.	Power.			
Kamets	...	̄	...	ā	Pathakh	...	̆	...	ä
Tsere	...	̅	...	ē	Segol	...	̇	...	ë
Long Khirik	...	̆	...	i	Short Khirik	...	̈	...	ÿ
Kholem	...	̇	...	ō	Kamets Khataph	...	̈́	...	ö
Shurek	...	̈́	...	ū	Kibbutz	...	̈̇	...	ü

SHEVA AND ITS COMPOUNDS.

Sheva and its compounds are pronounced very short, and are never regarded as properly making a syllable, only as beginning or ending it.

Name.	Form.	Power.		Name.	Form.	Power.		
Sheva	...	̆	...	ë	Khatef Segol	̆̇	...	ë
Khatef Pathakh	...	̆̈́	...	ä	Khatef Kamets	̆̈́̄	...	ö

The three last are called the compound Shevas.

Long Khirik (̆) is a small point placed before *Iod* (י), which it silences.

Kholem (̇) is a small point placed over letters. When put over ̆ that letter is silenced; but if another point be placed under *Vau* it is not silenced.

Shurek (̈́) is only placed in *Vau*, and silences it; but if

another point be placed under *Vau*, the dot in ׀ denotes *DAGESH forte*.

Short Khirik (◌) has its place under any letter, but silences none.

POINTS.

DAGESH (◌) and *MAPPK* (◌) are two points put in the body of certain letters.

DAGESH is either *forte* or *lene*.

DAGESH forte: Inscribed in any consonant, preceded and followed by a vowel, or preceded by a vowel and has a *Sheva*, such letters are sounded double. It may have a place in all the letters, except א ה ה ע ר.

DAGESH lene has its place only in the letters ב ג ד כ פ ת, and deprives them of their aspiration, but strengthens their pronunciation in some degree.

MAPPK is placed in the letter ה (*He final*) only, to show that it retains its power as a consonant.

RA-PHE is a small dash (◌) that formerly was placed over ב ג ד כ פ ת, when they had no *DAGESH*, to show that they should be pronounced with *h* aspirate.

MACCAPH is a small dash (◌), used to join words together.

ACCENTS.

These are very numerous, and are seldom used in any other than theological and grammatical writings, and only in some books of the Bible, where they stand for notes to sing by, and are called *accentus tonici*; others *accentus distinctivi*, because they distinguish the sense; and others *ministri*, or *servi non-distinctivi*, which show the construction and connection of words. They are placed below and above the line of the consonants. There are twelve found below the line; their names and forms are—

Sulluk	Athnakh	Tiphkha	Do. anterior	Tevir	Yethiv	Munakh	Mahpak	Yerakh	Merca	Double Merca	Darga
⌣	⌢	⌣	⌣	⌣	⌣	⌣	⌣	⌣	⌣	⌣	⌣

There are eighteen placed above the line, as follows :

• Keviah	◌ Geresh	◌ Zakefkaton	◌ Zakefgadol	◌ Segolta	◌ Pashta	◌ Shalsheleth	◌ Zarka	◌ Zarka anterior	◌ Pazer	◌ Geresh	◌ Double Geresh	◌ Karnephara	◌ Telishaketanna	◌ Telishagedola	◌ Kadma	◌ Manah superior	◌ Mahpak superior
◌	◌	◌	◌	◌	◌	◌	◌	◌	◌	◌	◌	◌	◌	◌	◌	◌	◌

One mark is found in the same line with the consonants,—namely, **LEGARME** ('); when situated under the line, **PESIK** (˘).

Another mark is sometimes found over words in the Hebrew contents—namely, **KETHIV** (°), a small circle, intended to direct attention to a note in the margin or at the foot of the page.

GERMAN.

On the whole the use of the German characters (*fraktur*) is declining, and that of the ordinary roman types (*antiqua*) is being substituted. Nevertheless, it is necessary to give the lay and certain remarks on the composition of works in that language, in order that one may be prepared to set German when occasion demands it. Formerly these types were laid in one large double case, almost square—that is, nearly as wide as long—but of late years the ordinary roman cases have been adopted, as being more convenient in composing and less awkward when out of use.

GERMAN ALPHABET.

Characters.		Signification.		Name.
Capitals.	Small Letters.	Capitals.	Small Letters.	
A	a	A	a	Ah
B	b	B	b	Bey
C	c	C	c	Tsey
D	d	D	d	Dey
E	e	E	e	Ey
F	f	F	f	Ef
G	g	G	g	Gey
H	h	H	h	Hah
I	i	I	i	E
J	j	J	j	Yot
K	k	K	k	Kah
L	l	L	l	El
M	m	M	m	Em
N	n	N	n	En
O	o	O	o	O
P	p	P	p	Pey
Q	q	Q	q	Koo
R	r	R	r	Air
S	s	S	s	Ess
T	t	T	t	Tey
U	u	U	u	Oo
V	v	V	v	Fow
W	w	W	w	Vey
X	x	X	x	Iks
Y	y	Y	y	Ypsilon
Z	z	Z	z	Tset

In addition to the characters of the preceding alphabet, the Germans make use of three, which are vowels: *Ue*, *ä*, or *ä*, expressed by the Roman character *ä*, and having the sound of *e* in *where*; *De*, *ö*, or *ö*, and in the Roman character *ö*, which has the sound of *eu* in the French *heure*;

Ue, ü, or ũ, having its representative in the Roman ü, and its expression in the thin *u* of the French in *vertu*.

The Germans also make use of the following double letters in printing :

ch	ch	ff̄i	ffi	fī	si	st̄	st
ck	ck	fl̄	fl	ss̄	ss	sz̄	sz
ff	ff	ll̄	ll	ssī	ssi	tz̄	tz
fi	fi						

In the printed alphabet some letters are apt to be mistaken and confounded one with another. To facilitate the discrimination the difference is here pointed out.

B (B) and V (V). The latter is open in the middle, the former joined across.

C (C) and E (E). E has a little horizontal stroke in the middle, projecting to the right, which C has not.

G (G) and S (S). These letters, being both of a round form, are sometimes taken for one another, particularly the G for the S. But S has an opening above, G is closed, and has besides a perpendicular stroke within.

K (K), N (N), R (R). K is rounded at the top, N is open in the middle, R is united about the middle.

M (M) and W (W). M is open at the bottom, W is closed.

b (b) and h (h). b is perfectly closed below, h is somewhat open, and ends at the bottom, on one side, with a hair stroke.

f (f) and f (f). f has a horizontal line above.

m (m) and w (w). m is entirely open at the bottom, w is partly closed.

r (r) and x (x). r has a little hair stroke below on the left.

v (v) and y (y). v is closed, y is somewhat open below, and ends with a hair stroke.

As will be seen, here too the ordinary roman cases, upper and lower, are used, fig. 86, and owing to the few accents in demand—the diæresis only being used—the lay can be

easily mastered when the characters have been learnt. One of the great difficulties in composing this language, if from manuscript, is the character in which it is written; this is harder to decipher than the printed form, if the compositor is a novice, and the copy not carefully written.

CHAPTER XII.

Type Music—Suggested Plan of Cases—Some Specimens of Music Founts in use.

MUSIC is printed by three processes—plate, lithography, and type—the last method being largely used for book music. The composition requires some amount of practice, as this class of work is almost distinct from ordinary letterpress printing. The cases used are very complicated, and contain more boxes than are required for other founts, foreign or otherwise, owing to the very large number of pieces used. The cost, too, of music type is very great as compared with other type, which is attributable to the expense of cutting such a large number of distinct pieces, and also to the smallness of the demand. Firms which make a speciality of music printing are very chary in printing from their type, on account of the great initial outlay, and usually stereotype it first,¹ the quantity of fine lines being liable to a larger amount of wear and tear in printing direct from the type.

The exact details of setting this class of work are very difficult, and perhaps hardly within the scope of this book, but the suggested plan of cases submitted, fig. 87, may be of interest. Nearly every office has a special lay, requiring cases of different make.

¹ The plaster process is preferable for this purpose, because the necessary beating in moulding by the paper process is detrimental to the kerned notes.

Founts of type music are very limited in number; we give a few specimens of those in general use.

Ruby.

Musical score for 'Ruby'. The piece is in G minor (one flat) and 2/4 time. The right hand features a melody with eighth and sixteenth notes, while the left hand provides a steady accompaniment of quarter notes. The score consists of two staves.

Diamond.

Musical score for 'Diamond'. The piece is in D major (two sharps) and 2/4 time. The right hand has a melody with eighth notes and rests, and the left hand has a bass line with eighth notes. The score includes a piano (*p*) dynamic marking, a 'Ped.' (pedal) instruction, and an asterisk (*) at the end of the piece. The score consists of two staves.

Semi-Nonpareil.

Musical score for 'Semi-Nonpareil'. The piece is in B-flat major (two flats) and 2/4 time. The right hand features a melody with eighth notes and rests, and the left hand has a bass line with eighth notes and rests. The score includes a forte (*f*) dynamic marking and a 'tremolo' instruction. The score consists of two staves.

CHAPTER XIII.

Table and Tabular Work—Definitions—Composition.

BOTH *table* and *tabular* work are somewhat difficult classes of composition, and the setting of these, especially the table work, requires a good deal of judgment. Table work is defined as matter in a series of four columns with headings, and is charged at double prices. Tabular matter, three columns with headings, is charged at half as much again as ordinary composition. In receiving copy for such work instructions should also be given for the limits of the table. In selecting the type for this the compositor must be guided by the number of lines in his copy for the depth and width of his columns. To settle this he should select the fullest line of each column, and set each in his stick. It is best, supposing the various columns are narrow, to make the measure of each up to ems (or even ens, if imperative) of the fount in which he is composing. This greatly facilitates the justification of each segment. Supposing a small type has to be chosen in order to bring the width within a certain compass, the length must not be lost sight of, or he may experience some difficulty in filling up the page to its proper depth. If this occurs, he can allow the width of the columns to be pinched a little, and some of the lines to turn over to make two, if necessary. Should this plan be followed, the turn-over line would have to be balanced by a white line in each of the other columns, so that the next line of the table may range across in reading. The headings of the table should be left till the last, and may be set in a smaller type. It is permissible also to set the table oblong, though the shape of the work may be upright

or bookwise. The cross-rules used in the columns should be metal ones of the fount in which the table is set, but the column rules should be of brass rule. The fact of using metal cross-rules for the column greatly simplifies the justification, saving the cutting and dressing of brass rule, which in short lengths is both troublesome and unsatisfactory.

CHAPTER XIV.

Scale of Prices as paid in London—Method of Casting-up Value of Work—Lengths and Widths for ordinary Book-work—Number of Lines per Thousand—How to Cast-off Copy for Quantity—Comparative Sizes of Types—Equivalent of Leads to Type Bodies.

BEFORE closing this section of the work, the *scale of prices* in vogue in London, and the various extras allowed by usage and custom, will be of service. The majority of labour in this department of the printing office is paid for by piecework, whereas in the provinces, where wages are generally lower, the reverse is the rule, and it is generally newspaper hands who are paid by result. The basis of the present scale was formulated about a century ago by a joint committee of employers and men, and the price per thousand has been increased from time to time by arrangement.

Casting-up.—A *thick space* is equivalent to an en in width, and an en to an em in depth. If the number amounts to 500 ens, 1000 is chargeable; but if under 500 ens, they are not reckoned. When the “cast-up” does not amount to threepence, it is not chargeable; but when it amounts to threepence, sixpence is reckoned. Em and en quadrats, or whatever may be used at the beginning or end of lines, are reckoned as an em in the width. Pamphlets

of five sheets and under are paid one shilling per sheet extra. Bottom notes, one shilling per sheet. Jobs of one sheet and under are paid at eightpence; nonpareil at ninepence. Appeal Cases are paid at eightpence; and if above forty ems in width, at ninepence. Side-notes to Appeal Cases are charged as follows: In folio or quarto—broad quotations, 3*s.*; double-narrows, 5*s.*; double-broad, 6*s.* Chancery Cases are paid according to the Parliamentary Scale, viz., 7*d.* per thousand.

Compositors on the establishment are paid not less than thirty-six shillings per week, for nine hours per day. They are restricted, when employed on the piece, from being put on the establishment to do any description of "composition," unless engaged for "a fortnight" at least. If requested, when out of employment, to assist in the "composition" of book-work or jobbing, they may accept a temporary engagement for not less than a day on the establishment, at six shillings per nine hours, but not of longer duration than "a fortnight," at the expiration of which agreement they may continue upon the establishment, terminating with "a fortnight's notice," or be paid upon the piece. Night-work is paid threepence per hour extra, but no charge of less than one shilling is made between the hours of ten p.m. and six a.m. Sunday-work, sixpence per hour extra, but in no case shall a compositor receive less than two shillings and sixpence extra. Work set up on the piece is not made up by a clicker on the establishment. Corrections are paid at not less than eightpence per hour.

There is one charge per thousand for all sizes, inclusive of Brevier to English; one rate for leaded and one for solid (not leaded); also a difference for copy, whether reprint, reprint with MS. insertions, or manuscript. Foreign languages also take an extra charge per thousand. There are besides a multitude of extras for

various kinds and characters of work. Exhaustive as the scale may be as regards the number of provisions it contains, there are always questions arising, and these are subject to mutual arrangement between master and man.

The following are a few of the intricacies of the scale of prices :

Tabular and *table work* is matter set up in three or more columns depending upon each other and reading across the page. To be paid as follows :

3 columns without headings, one-fourth extra.

3 columns with headings, or 4 columns without, one-half extra.

4 columns with headings, and 5 or more with or without, double the price of common matter.

Headings in smaller type than the body, but not exceeding two removes from it, if not more than 3 lines in depth, to be paid 1s. per sheet extra; if more than 3 lines, or if in smaller type than two removes, to be cast up according to the relative values of the two bodies; the greatest number of appearing lines being considered the depth.

Blank tables to be cast up double the price of the text type of the work. No extra charge to be made for headings in smaller type, unless such headings constitute one-half of the table.

The extra price for table, tabular, and column matter to be paid upon its actual dimensions only, with the following exceptions: Title headings to table and tabular matter to be reckoned as part of such matter; but if they exceed 5 ems of the body of the table, &c., in depth, 5 ems only to be charged as table, the remainder as common matter.

Pedigrees to be paid double the price of common matter; and the heads and notes upon the same principle as the heads and notes of tables.

ABSTRACT OF LONDON SCALE.

SIZE OF TYPE.	Dictionaries, Grammars, &c.									Greek.	
	English.	Foreign.	English.	English & Foreign.	Foreign.	English.	English & Foreign.	Foreign.	Without Accents.	With Accents.	
Manuscript.	<i>d.</i>	<i>d.</i>	<i>d.</i>	<i>d.</i>	<i>d.</i>	<i>d.</i>	<i>d.</i>	<i>d.</i>	<i>d.</i>	<i>d.</i>	<i>d.</i>
	ENGLISH to } ... { <i>lead</i>	6 $\frac{3}{4}$	7 $\frac{1}{4}$	7 $\frac{1}{4}$	7 $\frac{1}{2}$	7 $\frac{3}{4}$	7	7 $\frac{1}{4}$	7 $\frac{1}{2}$	9 $\frac{1}{2}$	11
	BREVIER } ... { <i>solid</i>	7	7 $\frac{1}{2}$	7 $\frac{1}{2}$	7 $\frac{3}{4}$	8	7 $\frac{1}{4}$	7 $\frac{1}{2}$	7 $\frac{3}{4}$	9 $\frac{3}{4}$	11 $\frac{1}{4}$
	MINION { <i>lead</i>	7	7 $\frac{3}{4}$	7 $\frac{1}{2}$	7 $\frac{3}{4}$	8 $\frac{1}{4}$	7 $\frac{1}{4}$	7 $\frac{1}{2}$	8		
 { <i>solid</i>	7 $\frac{1}{4}$	8	7 $\frac{3}{4}$	8	8 $\frac{1}{2}$	7 $\frac{1}{2}$	7 $\frac{3}{4}$	8 $\frac{1}{4}$		
	NONPAREIL ... { <i>lead</i>	7 $\frac{3}{4}$	8 $\frac{1}{2}$	8 $\frac{1}{4}$	8 $\frac{1}{2}$	9	8	8 $\frac{1}{4}$	8 $\frac{3}{4}$		
 { <i>solid</i>	8	8 $\frac{3}{4}$	8 $\frac{1}{2}$	8 $\frac{3}{4}$	9 $\frac{1}{4}$	8 $\frac{1}{4}$	8 $\frac{1}{2}$	9		
	RUBY { <i>lead</i>	8 $\frac{1}{4}$	9	8 $\frac{3}{4}$	9	9 $\frac{1}{2}$	8 $\frac{1}{2}$	8 $\frac{3}{4}$	9 $\frac{1}{4}$		
 { <i>solid</i>	8 $\frac{1}{2}$	9 $\frac{1}{4}$	9	9 $\frac{1}{4}$	9 $\frac{3}{4}$	8 $\frac{3}{4}$	9	9 $\frac{1}{2}$		
	PEARL..... { <i>lead</i>	8 $\frac{3}{4}$	9 $\frac{1}{2}$	9 $\frac{1}{4}$	9 $\frac{1}{2}$	10	9	9 $\frac{1}{4}$	9 $\frac{3}{4}$		
..... { <i>solid</i>	9	9 $\frac{3}{4}$	9 $\frac{1}{2}$	9 $\frac{3}{4}$	10 $\frac{1}{4}$	9 $\frac{1}{4}$	9 $\frac{1}{2}$	10			
DIAMOND { <i>lead</i>	10 $\frac{3}{4}$	11 $\frac{1}{2}$	11 $\frac{1}{4}$	11 $\frac{1}{2}$	12	11	11 $\frac{1}{4}$	11 $\frac{3}{4}$			
..... { <i>solid</i>	11	11 $\frac{3}{4}$	11 $\frac{1}{2}$	11 $\frac{3}{4}$	12 $\frac{1}{4}$	11 $\frac{1}{4}$	11 $\frac{1}{2}$	12			
Reprint.	6	6 $\frac{1}{2}$	6 $\frac{3}{4}$	6 $\frac{3}{4}$	7	6 $\frac{1}{4}$	6 $\frac{1}{2}$	6 $\frac{3}{4}$	8 $\frac{3}{4}$	10 $\frac{1}{4}$	
	ENGLISH to } ... { <i>lead</i>	6 $\frac{1}{4}$	6 $\frac{3}{4}$	6 $\frac{3}{4}$	7	7 $\frac{1}{4}$	6 $\frac{1}{2}$	6 $\frac{3}{4}$	7	9	
	BREVIER } ... { <i>solid</i>	6 $\frac{1}{2}$	7 $\frac{1}{4}$	7	7 $\frac{1}{4}$	7 $\frac{1}{2}$	6 $\frac{3}{4}$	6 $\frac{3}{4}$	7 $\frac{1}{4}$	10 $\frac{1}{2}$	
	MINION { <i>lead</i>	6 $\frac{1}{4}$	7	6 $\frac{3}{4}$	7	7 $\frac{1}{2}$	6 $\frac{1}{2}$	6 $\frac{3}{4}$	7 $\frac{1}{4}$		
 { <i>solid</i>	6 $\frac{1}{2}$	7 $\frac{1}{4}$	7	7 $\frac{1}{4}$	7 $\frac{3}{4}$	6 $\frac{3}{4}$	7	7 $\frac{1}{2}$		
	NONPAREIL ... { <i>lead</i>	7	7 $\frac{3}{4}$	7 $\frac{1}{2}$	7 $\frac{3}{4}$	8 $\frac{1}{4}$	7 $\frac{1}{4}$	7 $\frac{1}{2}$	8		
 { <i>solid</i>	7 $\frac{1}{4}$	8	7 $\frac{3}{4}$	8	8 $\frac{1}{2}$	7 $\frac{1}{2}$	7 $\frac{3}{4}$	8 $\frac{1}{4}$		
	RUBY { <i>lead</i>	7 $\frac{1}{2}$	8 $\frac{1}{4}$	8	8 $\frac{1}{4}$	8 $\frac{3}{4}$	7 $\frac{3}{4}$	8	8 $\frac{1}{2}$		
 { <i>solid</i>	7 $\frac{3}{4}$	8 $\frac{1}{2}$	8 $\frac{1}{4}$	8 $\frac{1}{2}$	9	8	8 $\frac{1}{4}$	8 $\frac{3}{4}$		
	PEARL..... { <i>lead</i>	8	8 $\frac{3}{4}$	8 $\frac{1}{2}$	8 $\frac{3}{4}$	9 $\frac{1}{4}$	8 $\frac{1}{4}$	8 $\frac{1}{2}$	9		
..... { <i>solid</i>	8 $\frac{1}{4}$	9	8 $\frac{3}{4}$	9	9 $\frac{1}{2}$	8 $\frac{1}{2}$	8 $\frac{3}{4}$	9 $\frac{1}{4}$			
DIAMOND..... { <i>lead</i>	10	10 $\frac{3}{4}$	10 $\frac{1}{2}$	10 $\frac{3}{4}$	11 $\frac{1}{4}$	10 $\frac{1}{4}$	10 $\frac{1}{2}$	11			
..... { <i>solid</i>	10 $\frac{1}{4}$	11	10 $\frac{3}{4}$	11	11 $\frac{1}{2}$	10 $\frac{1}{2}$	10 $\frac{3}{4}$	11 $\frac{1}{4}$			

Reprints with MS. insertions add $\frac{1}{4}d.$ to the price stated above.

Stereotyped matter with high spaces adds $\frac{1}{4}d.$ to the price stated. Stereotyped matter with low spaces adds $\frac{1}{2}d.$ to the price stated.

Notes constituting the charge of One Shilling per Sheet.

- Quarto and Octavo . . . 20 Lines or 2 Notes, and not exceeding 4 pp. in every 10 Sheets.
- Twelves 1 Page or 2 Notes, and not exceeding 6 pp. in every 10 Sheets.
- Eighteens or above . . . 2 Pages or 2 Notes, and not exceeding 8 pp. in every 10 Sheets.
- Pamphlets 10 Lines or 2 Notes, and not exceeding 2 pp. in 5 Sheets.

Casting-up.—These examples give some idea of the method of arriving at the value of composition per sheet :

(a) NONPAREIL (solid), at 8*d.* per 1000.

Number of ems in depth	74	
Number of ens in width	84	
	296	
	592	
	6216	
Number of pages in sheet	24	
	24864	
	12432	
Total number of en quadrats ...	149,184	
at 8 <i>d.</i> per 1000	= £4 19 6	
Placing of notes	0 1 0	
	£5 0 6	

(b) LONG PRIMER (solid), at 7*d.* per 1000.

Number of ems in depth	47	
Number of ens in width	54	
	188	
	235	
	2538	
Number of pages in sheet	24	
	10152	
	5076	
Total number of en quadrats	60,912	
at 7 <i>d.</i> per 1000	= £1 15 6	
Placing of notes	0 1 0	
	£1 16 6	

The process of “casting-up” as here exemplified is the result of multiplication. The number of ems in depth is the multiplicand, and the number of ens in width is the multiplier. The number of pages in a sheet is the compound multiplier, and the total number of en quadrats is the product.

For approximate purposes this scheme is a handy one :

LENGTHS AND WIDTHS OF PAGES FOR ORDINARY BOOK-WORK,

*With the number of Ens contained in each page, from
Pica to Nonpareil inclusive.*

Length.	Width.	SIZE.	Pica.	Small Pica.	L. Primer.	Bourgeois.	Brevier.	Minion.	Nonpareil.
Picas.		<i>F'cap.</i>	Ens.	Ens.	Ens.	Ens.	Ens.	Ens.	Ens.
41	30	4to.	2460	3243	3825	4988	5796	6900	9840
32	18	8vo.	1152	1517	1800	2346	2695	3180	4608
28	15	12mo.	840	1088	1295	1680	1978	2350	3360
19	15	16mo.	570	748	888	1134	1334	1600	2280
21	12	18mo.	504	672	780	1020	1184	1400	2016
		<i>Crown.</i>							
48	34	4to.	3264	4290	5040	6693	7696	9120	13056
36	21	8vo.	1512	1968	2340	3060	3520	4200	6048
32	16	12mo.	1024	1369	1600	2116	2401	2809	4096
23	16	16mo.	736	962	1160	1518	1715	2014	2944
23	15	18mo.	690	884	1073	1419	1610	1900	2760
		<i>Demy.</i>							
54	42	4to.	4536	6014	6968	9240	10707	12600	18144
42	24	8vo.	2016	2640	3120	4080	4810	5600	8064
36	19	12mo.	1368	1804	2115	2754	3190	3780	5472
26	20	16mo.	1040	1380	1600	2109	2440	2838	4160
28	16	18mo.	896	1184	1400	1840	2107	2491	3584
21	12	32mo.	504	672	780	1020	1184	1400	2016
		<i>Royal.</i>							
64	48	4to.	6144	8140	9401	12604	14652	17120	24576
48	27	8vo.	2592	3410	4020	5313	6142	7290	10368
40	21	12mo.	1680	2208	2600	3420	3968	4690	6720
29	21	16mo.	1218	1584	1872	2520	2880	3430	4872
32	18	18mo.	1153	1517	1800	2346	2695	3180	4608
24	14	32mo.	672	896	1050	1360	1591	1880	2688

The above figures are subject to the slight variations in founts from different foundries.

Another useful table is the following :

NUMBER OF LINES PER THOUSAND.

No. of Pica. Ems in Width.	Pica.	Small Pica.	Long Primer.	Bour- geois.	Brevier.	Minion.	Non- pareil.
10	50	43	40	36	32	29	25
11	45	40	36	32	29	27	23
12	42	36	32	29	27	24	21
13	38	33	30	27	25	23	19
14	36	31	29	25	23	21	18
15	33	29	29	23	23	20	17
16	31	27	25	22	20	19	16
17	29	26	23	21	19	17	15
18	28	24	22	20	18	16	14
19	26	23	21	19	17	15	13
20	25	22	20	18	16	15	13
21	24	21	19	17	15	14	12
22	23	20	18	16	14	13	12
23	22	19	17	15	14	13	11
24	21	18	16	15	13	12	10
25	20	17	16	14	13	12	10
26	19	17	15	14	12	11	10
27	19	16	15	13	12	11	9
28	18	15	14	12	12	11	9
29	17	15	14	12	11	10	9
30	17	14	13	12	11	10	8
31	16	14	13	11	10	10	8
32	16	14	12	11	10	9	8
33	15	13	12	11	10	9	8
34	15	13	12	10	9	9	7
35	14	12	11	10	9	8	7
36	14	12	11	10	9	8	7
37	14	12	11	10	9	8	7
38	13	11	10	9	9	8	7
39	13	11	10	9	8	8	6
40	12	11	10	9	8	7	6

The foregoing table may be used as a means for ascertaining the value per hour of the number of lines contained in solid composition. Should there be any necessary deviation from it as to an increase or decrease in the number given (which may arise from intricate or productive composition), such deviation must be decided by mutual agreement. When the matter is leaded by the compositor, there is generally a deduction of one line per hour.

Casting-off copy.—An important consideration is that of estimating the number of pages of a required size which any given copy will make. As copy varies so much, especially when in manuscript, a great deal of perseverance is requisite, and although entirely exact rules cannot be laid down, the following may be recommended as the result of experience. After having made up a composing stick to the measure proposed for the width of the work, take an average page of the copy, and set from it until a certain number of lines come out even with a number of lines of type. From this a calculation can easily be made for the whole of the work. Suppose a manuscript of 250 pages, and 31 lines in a page, be given for casting-off, and it is required to determine how many pages it will make in Long Primer, the page being 28 ems wide and 40 lines of types in length; and it is found, by setting up a few lines, that 9 of the copy are equal to 7 of the type. Then :

250 pages manuscript.

31 lines in a page.

250
750

7,750 lines manuscript.

9 : 7,750 : : 7

9) 54,250

40)6,027 lines of types.

151 pages of types.

The number of sheets can be ascertained by dividing 150 by 8, 16, or 24, according to the size of the signature in which the work is to be printed.

To assist in casting-off a volume in any particular fount of type the following table will be of value.

Comparative Sizes of Types.—The following are the number of ems of Miller and Richard's types of various bodies that go to the foot. The types of the other founders vary slightly in the measurement of their bodies from those of Miller and Richard.

Pica 72 ems	Minion 122 ems
Small Pica 83 „	Emerald 138·5 „
Long Primer 89 „	Nonpareil 144 „
Bourgeois 102·5 „	Ruby 166 „
Brevier 111 „	Pearl 178 „

Example of Use of the Table: A book set in Small Pica 21 ems (pica) wide, 36 lines to a page, leaded 8-to-pica, occupies 500 pages. If the same book should be set in Brevier solid, 18 ems (pica) wide, 45 lines to the page, how many pages will it occupy?

The proportions are as follows—111 : 83, 45 : 36, 18 : 21. The fact that one book is solid and the other leaded need not be taken into account, as the difference is shown in the number of lines to the page. Therefore, the number of pages required is $500 \times 83 \times 36 \times 21$ divided by $111 \times 45 \times 18 = 349$ pages. *Ans.*

Note: The faces should be of the same series; that is, proportional. If the Small Pica were a condensed letter and the Brevier an extended, the number of pages would be correspondingly enlarged, and *vice versâ*.

The equivalent depth of type bodies in leads, given over-leaf, will be found useful.

*Leads required to Justify with Type from Pearl to
Great Primer inclusive.*

PEARL	One four and one eight-to-pica.
RUBY	One four and one six-to-pica.
NONPAREIL	Two fours; three sixes; or four eights.
EMERALD	One four, one six, and one eight.
MINION	One four and two sixes.
BREVIER	Two fours and one eight.
BOURGEOIS	Three eights and two sixes.
LONG PRIMER ...	Three fours; or six eights.
SMALL PICA	Two fours and two sixes.
PICA	Four fours; or six sixes.
ENGLISH	Three fours and two sixes.
GREAT PRIMER... ..	Four fours and two sixes.
PARAGON	Six fours; or twelve eights.
DOUBLE PICA ...	Six fours and one six.

READING.

CHAPTER XV.

Qualifications necessary for a Corrector of the Press—Rules for Guidance of the Composing and Reading Departments—The Rudiments of Reading—First Proof Reading—Reading for Press—The Selection of Reading Boys—Books showing Progress of Work in hand—Reference Works for use.

THIS department is usually recruited from the composing room. If the "corrector of the press" has technical experience, with a certain amount of literary knowledge, so much the better for his success as a reader and for the reputation of the establishment. Further, this person should be gifted with a sharp eye for details—whilst he is looking at one point, say a matter of style, he must not lose sight of his copy. A practical printer is to be preferred by all means to a non-practical man, though there are instances of capable men of the latter class filling responsible positions as printer's readers; but as a rule a compositor, if he has received a fair education and has been noted for clean proofs in type-setting, is the most suitable person. There are so many details and technicalities in printing that it is hardly possible for a non-practical man to ever become thoroughly perfect in picking up deviations of style,—he cannot be expected to know even the elementary principles of composition.

It is essential in all well-regulated and large offices to have a perfect understanding between the composing and

reading departments as regards matters of style, spelling, punctuation, capitals, quotations, authorities, &c. If these are not perfectly understood, they should be printed and circulated. Even then the points laid down may be subject to alteration at the suggestion or order of the customer, who has, we suppose, a right to have his own way to a certain extent. In cases of this nature, the special instructions should be clearly understood by all concerned.

First-proof' reading.—In book-work the rudiments are to see that the size and shape of the selected specimen or book are properly followed. The next step is to verify signature of sheet, head-lines, and folios throughout. After the first sheet it is necessary to get the connection from signature to signature by checking the last word of the first and the first word of the subsequent sheet. It is customary in finishing the reading of a sheet, supposing there is no more ready, to indicate the ending of this sheet on the copy by a bracket mark [(this side of copy being called the “prima”), at the same time marking the signature and first folio of the next in order on the margin. As the proofs are sent out to the author or publisher it is best to retain this “prima” for reference purposes in reading the next sheet. The length of pages should also be checked, and uniformity preserved as much as possible in all matters of style. The marks and signs used in corrections should be clearly expressed in the margin without being written too large. It is a good plan to draw an imaginary line down the centre of the page by the eye, and write the corrections belonging to the left-hand portion on the left margin, and on the right for the right-hand division of the page. The method of marking the corrections has been shown on pp. 93-95 in the section of the work devoted to composition. The proof should never be read to the lad; he should read the copy to you; this is the safest course, though the other plan is occasionally adopted. If

time will allow, it is best to skim through the proof beforehand for letterals and matters of style. In altering the make-up of pages, see that your alteration is an improvement, and that it will not make matters worse, either in front or after your proposed change. As far as possible it is desirable that the same reader should have the charge of the same work, and also have the opportunity of revising his own first proofs. Particular attention should be paid to proper names as regards spelling, all dates and authorities should be verified as far as possible, and, if any doubt arises, queries should be marked on the clean proofs sent to the customer. Works of peculiar character or foreign languages, with which a boy cannot be supposed to be sufficiently acquainted, should be compared with copy word by word and letter by letter.

Press-proof reading is a responsible duty, and is usually performed by a separate reader—one generally of superior experience and education. In large offices, specialists as regards language and other qualifications are retained, and the work is divided according to the nature of the subject. An elementary knowledge of Latin, French, and Greek is a great acquisition for a first-proof reader, and those more learned in these subjects are sought after as final or press readers.

Selection of reading boys.—Only those with clear voices and good articulation should be engaged. The boy should, without doubt, be fond of reading, otherwise he will find it a very monotonous task. He should have good eyesight, and be able to grasp the meaning of the subject in hand. Further, he should have a natural aptitude for deciphering the many varieties of handwriting which are placed before him.

A work-book should be kept containing ruled pages—one to each work—showing its progress, *i.e.*, first-proof reading, revising, proofs out and returned for author's revise or for

press, and, finally, when printed off. Such a volume will be found exceedingly useful.

Works of reference.—One other essential in well-regulated offices is a good library of reference books. Besides dictionaries of various languages, a Whitaker's almanack, a peerage, and other works of a similar nature, are valuable additions.

PRESS-WORK.

CHAPTER XVI.

Definition of Press-work—Description of Presses used —The Stanhope, Columbian, and Albion Presses—Instructions for erecting these Presses—Chill of the Albion Press—Sizes of Presses determined by the Platen.

PRESS-WORK is generally understood to mean printing by hand by a flat or platen impression. The men who perform this part in the production of a book are called pressmen. Owing to the increase of mechanical means of printing, the old school of pressmen is fast dying out. Few lads are apprenticed to this department of the business nowadays, as the demand for hand labour is somewhat limited, the great improvements in machinery of various classes allowing of really good work being executed by machinery. The small platen machines, propelled by either foot or steam, have also very largely reduced in late years the amount of work done by the hand-presses even after the introduction of the larger printing machines. Notwithstanding this, certain classes of work must yet be done by the hand-press, and the exercise of a pressman's calling requires a deal of practice apart from the manual labour bestowed on the printing off. An ordinary press, with two men working at it, one rolling and the other pulling, is only capable of producing about two hundred and fifty impressions per hour, even when in full swing, and after all the making-ready has been finished. Small numbers and works in colours are the principal jobs relegated to this

department. The preparatory stages in getting a forme ready to print are more accessible on the press, and a machine is paying best when running; hence the reason for small numbers with frequent making-ready going to the press-room. A pressman's educational qualifications are not always of the same standard as his fellow-worker the compositor, but it is requisite that he should be intelligent, and capable of exercising sound practical sense in the per-

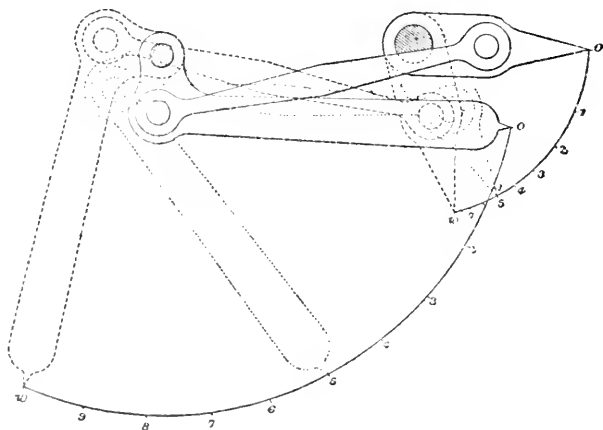

Fig. 88.

formance of his duties. These duties are only acquired in a proper manner by long experience. A good workman may always command constant employment.

The earlier presses were made of wood, and the bed was generally of stone embedded in the coffin. The first iron press was invented by Earl Stanhope in the beginning of this century, and became the basis for the presses now used. The action of the levers employed on this press is shown here, fig. 88. Various alterations and improvements were made from time to time; it is only necessary

to give particulars of those more generally in use at the present day, viz., the Columbian and Albion. Formerly pressmen were supposed to be able to erect and take down their presses, but this is now generally accomplished by the printer's engineers, though it is essential that the men who work them should have a general knowledge at least of these two operations should they be called upon to act in an emergency, and we propose to give a few hints for this purpose on each kind of press in turn.

We will first take the *Columbian* press, fig. 89, as the oldest in make.

This press is not so much in use as the Albion, because the latter is better adapted for sizes of double crown and smaller, whilst the Columbian is recommended for larger than double crown, especially as greater strength can be obtained. Each part of the press has a distinctive name, and the best way to erect it is to follow the suggestions here offered.

Erecting the Columbian press.—Place the feet on the staple in the positions as marked, and raise it upon them; then place the bar-handle in, with the bolt belonging to it; put the principal lever into its place, and then the bolt which connects it to the staple; then the angular or crooked part, which has one square and three round holes, through it, into the mortice, which is in the projecting part of the long side of the staple, and place in the bolt that attaches it to the staple. In the extreme edges of the heads of the two before-mentioned bolts you will observe marks, and corresponding marks over the holes through which they pass; put the bolts in so that these marks meet together and correspond, and so on, until you have all the remaining parts in their respective places. The four screws for the platen, which have heads on one side, are intended to attach the platen to the piston, which being placed in their proper places, are secured

by the four small blocks of iron which accompany them. To increase the power, turn the nut in the rod so as to shorten it, and to decrease it, turn it the reverse way. By the nut

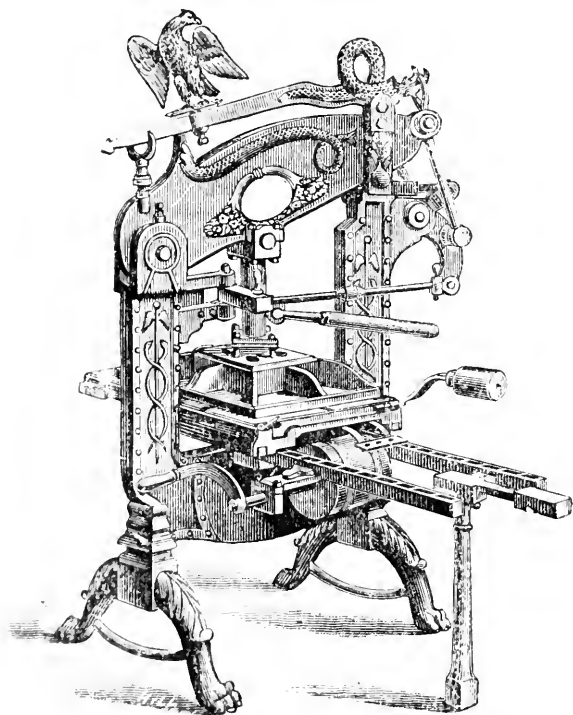

Fig. 89.

on the iron screw, which connects the main and top counterpoise levers, you may regulate the rise and fall of the platen, so as to clear the head-bands of the tympan, which is done by screwing the iron nut up as far as is necessary. In adjusting the platen so as to approach the forme exactly

parallel, you must, after hanging on the platen and having a forme on the table, square it to your tympan, then make a pull, and hold the bar-handle home until someone else screws the four platen bolts to an equal tightness. The small holes which communicate with the different bolts require a small quantity of machine oil occasionally. The impression may be increased by putting thin pieces of tin or sheet iron, cut to the size of the plate of iron which lies between the platen and the piston, secured by the four screws on the top of the platen, and placing it under the piston; you can then readily tell whether everything is in its proper place, by the perfect ease with which the bar-handle acts.

By comparing these directions with the illustration of the press the different parts may be identified. As will be gathered, the impression is obtained by means of levers, somewhat on the plan of those used by Earl Stanhope in his press. The power is given by the heavy cross-beam at the head of the press, set in motion by pulling the bar-handle across, which acts on the horizontal rod attached, and also brings the elbow into play, great power being thus obtained. The top cross-rod, on which the eagle is placed, is the counter-weight, which falls back into its original position—having been raised in the act of impression—when the recoil of the bar-handle has taken place. These presses are made as large as double royal.

As before said, the *Albion*, fig. 90, is in more general use, because of its more accelerated movements in printing.

As in the case of the *Columbian*, each part has its particular name, and the hints given, with those as applied to the erection of the *Columbian* press, will be sufficient to fix up one of these.

Erecting the Albion press.—Place the feet on the staple as marked, and raise it on them; then place the spring and box on the top of the staple, dropping in the long

loop bolt, which is connected with it, into the long hole in the staple; then connect the piston by passing the round bolt through the hole in the staple, and fasten with

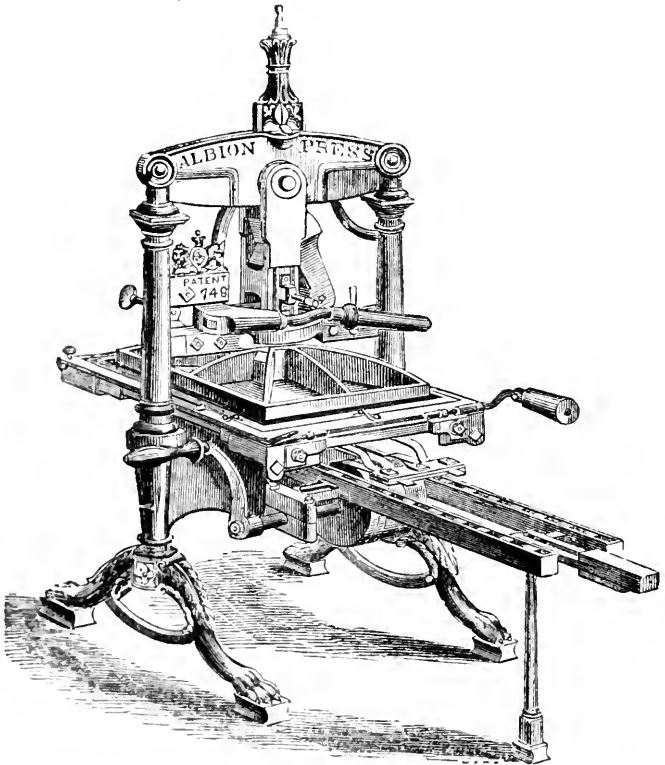

Fig. 90.

pin and washer; put the bar-handle in its place with bolt, tightening it so as to allow the bar-handle to be free; then attach on, with the four screws, the slides or guide-pieces to piston; then place the chill into the piston, also

the tumbler or wedge-shaped piece, taking care that the bright or numbered side is towards the bar-handle; then connect the chill with the bolt in the handle, screw up the nut or top of the spring-box sufficiently to draw back the bar, so as to keep all parts in their places. The wedge and brass guard in front of piston are intended to regulate the pressure. The other parts of this press may be fixed in the same manner as the Columbian.

These presses are also made in very large sizes. The

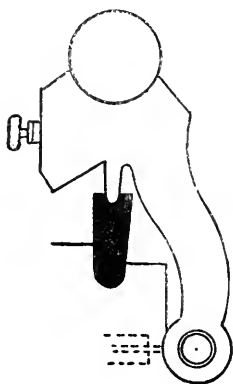

Fig. 91.

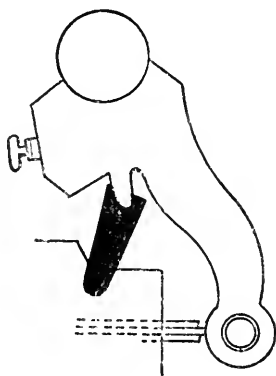

Fig. 92.

power is obtained by means of levers, which act on an inclined piece of steel called a chill; by pulling the bar-handle across, this chill is brought from the sloping into a vertical position at the precise moment of impression. On the bar-handle being allowed to go back to its original position, the chill resumes its former inclination, and the platen is raised from the surface of the type by the recoil of a spring contained in the box at the head of the press; this then allows the forme to be run out, rolled, and run in again for successive impressions, the sheet as printed

being first removed, and another laid on its place. The exact action of the chill, figs. 91 and 92, in and out of action, is shown on the previous page.

Presses are made in various sizes, and classified, commencing with the smaller, as card, quarto, folio, and broadside, corresponding with the different sizes of paper used in printing. The size of platen determines the classification, and the same conditions apply to both kinds of presses mentioned. Card or quarto presses measure something less than the smallest dimensions now given.

<i>Name of Press.</i>	<i>Size of Platen.</i>
Foolscap folio	15 × 9 $\frac{3}{4}$ inches.
Post „	16 × 11 „
Demy „	18 × 12 „
Foolscap broadside	19 × 14 $\frac{1}{4}$ „
Crown „	21 × 16 „
Demy „	24 × 18 „
Royal „	26 × 20 $\frac{1}{2}$ „
Super-royal „	29 × 21 „
Double crown „	34 × 22 $\frac{1}{2}$ „
Double demy „	36 × 23 „
Double royal „	40 × 25 „

For export purposes, or conveyance to great distances, presses are made of a portable nature, the staple being in two portions, which is an advantage, on account of the weight of this part of the press.

CHAPTER XVII.

Appliances, Tools, and Materials used in connection with Hand Presses—The Tympan and Frisket—The Bank and Horse—Ink Tables—The Brayer and Slice—Ink Knife and Sheep's-foot.

THE most important adjunct of the press are the *tympan*s. They are square iron frames, consisting of "inner" and "outer" respectively—the latter is the larger, and outside one, as its name implies, and is nearer the type in printing off. When the inner is laid inside the outer the two frames are flush, and are fastened by means of semicircular hooks on the outer, which encloses a stud on the inner tympan. The object of the tympan is, first, to contain a few sheets to receive the impression, and also the making-ready of each forme; when fastened down and turned up to its proper position, the sheet to be printed is laid upon it.

The *frisket* is a light iron frame attached to the upper part of the tympan by means of a knuckle and pins at either corner. Its object is to keep the sheet in its position when turned down over the tympan, and also to prevent the blacking or inking of any part of a forme not to be printed. It is covered with thick paper, an impression of the type is taken on it, and the exact parts to be printed are cut out. It should have been said that the two tympan's are generally covered with parchment—this material being the most durable and less inclined to get loose or baggy. Cambric, or even silk, is sometimes used for exceptionally fine work, but of course does not last long, and is expensive.

To assist the pressman in getting a proper purchase it is customary to have an inclined *wooden stool* fastened to the flooring immediately under that part of the ribs which

the bar-handle would be pulled across. To prevent the frisket straining the knuckle-joints attached to the tympan and falling back too far when "flown," *i.e.*, turned up for the purpose of taking off the sheet just printed, it is necessary to have some kind of stay fastened up to the proper height, to catch the top part of it—this is generally made with a piece of wood fastened from the ceiling.

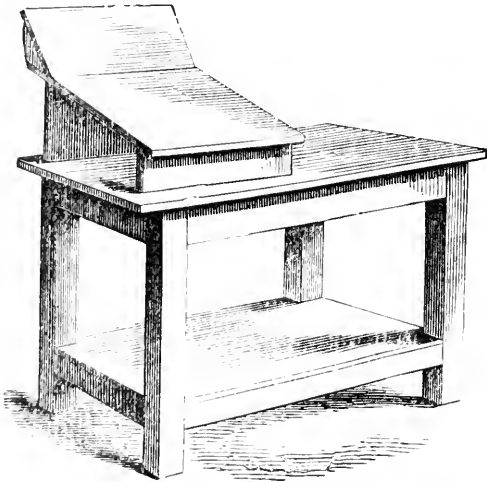

Fig. 93.

Several other things are necessary for the outfit of a press, and the next in importance is a *bank*, fig. 93, an oblong deal table, with an undershelf. This shelf is handy for placing waste sheets on, and for holding the different papers for making-ready or pulling proofs and revises. In connection with this bank a wooden *horse* is used, an inclined stage with a sloping back. The paper to be printed is placed on this horse, as is also the heap when

the second side is being worked off. As the sheets are printed they are placed on the end of the bank farthest from the horse.

Ink-tables are of two kinds, cylindrical and brayer. The best kinds are those entirely made of iron, because they are more solid and firm in standing, but under any circumstances they must be fastened to the floor to the required

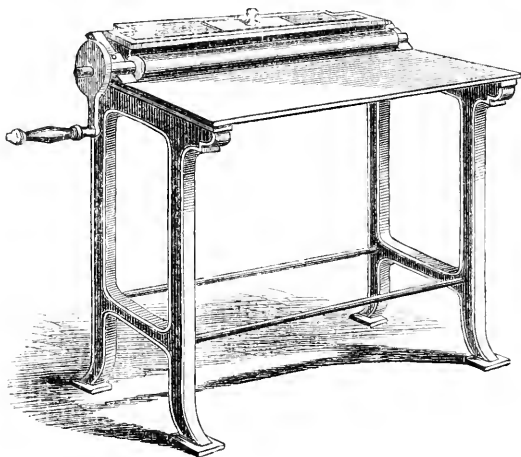

Fig. 94.

position, as the suction or lug of the roller is apt to make them unsteady.

The *cylindrical table*, fig. 94, gives out the ink for distribution as necessary when the crank handle is turned, but it need not be turned each time fresh ink is taken, as there will be sufficient on the cylinder for several distributions if the work is not a heavy one.

The *brayer table*, fig. 95, is used thus: a small quantity of ink is placed loosely on the back of the table, and with a small wooden implement called a *brayer*, fig. 96, the ink

is brayed or rubbed out as required. The ink as it is taken from the can should be lifted by the aid of an *ink slice*, fig. 97.

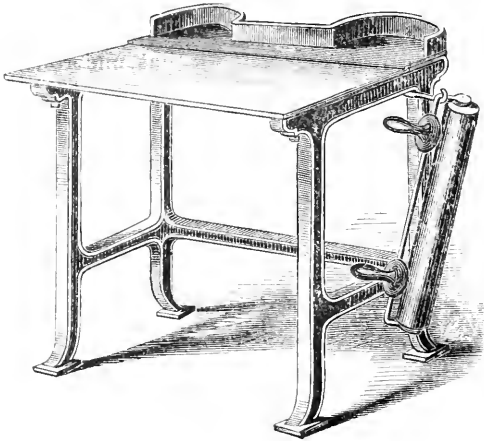

Fig. 95.

The surfaces of these tables should be planed quite smoothly, and should be kept quite free from dirt or dust. For colour-work iron surfaces must not be used, but



Fig. 96.



Fig. 97.

slabs of either porcelain or marble substituted. These may be fastened down on the planed iron table with thick string. This will prevent jarring, more especially if a few

thicknesses of wrapper paper are placed between the two surfaces.

A small table, called a *pedestal table*, fig. 98, is handy for small presses, occupying as it does so little room.

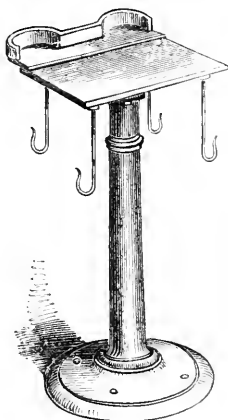

Fig. 98.

For the mixing of colours a special *knife*, fig. 99, is used. Each press should have, in addition, a *mallet*, *shooting stick*, and *planer*, together with a *hammer* for fastening



Fig. 99.



Fig. 100.

the forme on the press; if this latter has a claw it is useful in raising formes on the press. This particular hammer is called a *sheep's-foot*, fig. 100. The workman should also be furnished with a sharp pair of scissors and a cutting-out knife, both of which are employed in making-ready.

CHAPTER XVIII.

Rollers—Varieties of Hand Rollers used—The old-fashioned Inking Ball—Recipes for Composition—Casting Rollers—Various Hints as to Condition and Treatment of Rollers.

THE *rollers*, fig. 101, used for press-work are made of a composition, principally of treacle and glue. They revolve on an iron frame with two wooden handles. At the two edges of these frames a point is made, which fits into a metal hollow in the wooden spindle on which the roller composition is clothed. The frame is made in two pieces overlapped, and is fastened by means of collars and nuts,

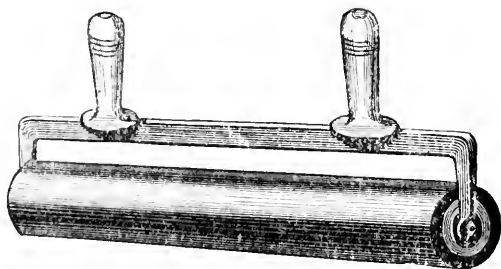

Fig. 101.

so that, when these nuts are undone, the different halves open out and allow the old roller to be withdrawn and a new one substituted and refastened up. The cut, fig. 102, gives the frame itself.

Rollers are made to any size, according to the requirements of the work in hand, such as demy royal, double crown, &c.

For small work a roller with a single handle, fig. 103, is sufficient. We also show the old-fashioned *inking ball*,

fig. 104, which was used for beating the surface of the type before rollers were made of composition. These balls are rarely used now, and then only for very special purposes. Wood engravers use them sometimes, as they are handier than a roller. The present system of rolling is far pre-

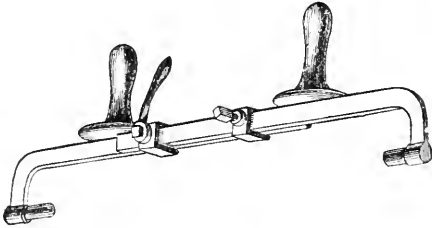

Fig. 102.

ferable to the old one of beating, which was indeed a laborious task, though it is astonishing what results were got from the inking balls as regards evenness of colour. Without the invention of the cast rollers, machinery, with

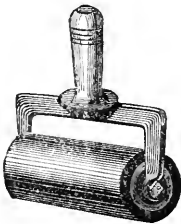

Fig. 103.

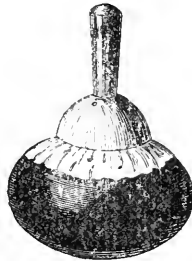

Fig. 104.

its automatic rolling and inking appliances, would not have made the strides it has.

Rollers are made by firms who make the manufacture a study, and they can be had by the single roller or by the contract system—a definite price being charged, so much per

quarter for a given number of rollers to be kept in working order and renewed as frequently as required. This plan is adopted by many of the large offices in London, as it is found more economical in the long run than to make their own. However, we propose to show how ordinary rollers may be cast, from various recipes given for different compositions. There are some kinds advertised as patented which have great lasting properties, but the manufacture of these is a trade secret. To be prepared for any contingency that may arise, good serviceable rollers may be



Fig. 105.

prepared from the following—the figures are “parts,” and should be calculated by weight :

- (a) Treacle 12, glue 8, Paris white 1.
- (b) Glue 10, sugar 10, glycerine 12.
- (c) Treacle 12, glue 4.

As will be observed, glue and treacle form the principal parts of these rollers. Glycerine and Paris white may be added according to experience and fancy. The success of your rollers depends largely on the quality of the ingredients used, and it is advisable to use the best ; the

glue in particular should be clear in colour, and break shortly and crisply. The glue, after being broken, should remain in soak till it is rendered soft, and then be placed in the *composition kettle*, fig. 105.

When sufficiently hot and dissolved, the treacle and other ingredients should be added. It is then necessary for the whole to boil for about one hour. Taking, for example, a royal roller for working at hand-press, the mould should be dry and quite clean, warmed, and anointed with oil; this enables the roller to be delivered more easily from the mould.

For small rollers the *solid mould*, fig. 106, made in one piece, is well adapted. The drawing here given shows the position of the roller inside the mould by the dotted lines. For the larger kind we recommend the moulds made in halves, fig. 107, and to show the method of closing up fig. 108 will answer our purpose. The stock must be fastened to the end-piece, and placed in its position in the mould. In order to turn out a good roller pour the composition in slowly without a break, and in doing so avoid pouring it on the sides of the mould, but rather against the stock. Well fill the mould over and above the length of the stock, and then stand it aside to cool. When removed from the mould the roller should be kept in an even temperature, protected from dust by being placed in a box or cupboard constructed for the purpose. Before doing this, cut off the superfluous composition at either end of the roller.

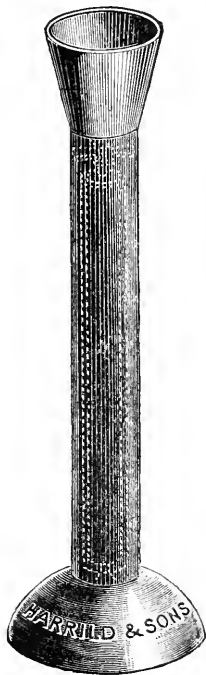

Fig. 106.

Rollers are very subject to the influence of climatic and atmospheric conditions—the least change affects them, and they require constant attention. In cold weather they get hard, in hot weather soft.

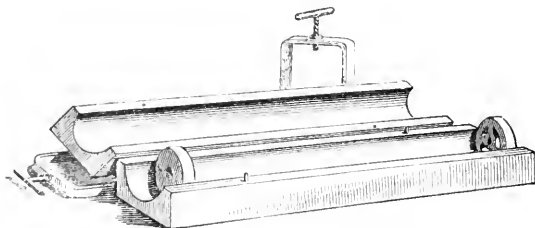

Fig. 107.

They should not be too hard or too soft, neither crack nor skin on the surface, and there should be some amount of “life” in them, that is to say, there should be a certain amount of “tackiness” when manipulated with the hand.

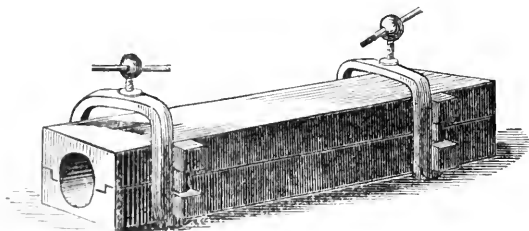

Fig. 108.

Sometimes they are too fresh or new, “green” as it is termed; when in this state, they should be put aside to mature. Improper treatment in washing has frequently much to do with the bad condition of rollers. Lye should be used sparingly, and only when the roller has been in use

some time. For washing rollers used in colour-work benzine or turpentine should be taken.

We add some suggestions for the manufacture, care, and treatment of rollers; many of these will be found useful in emergencies.

To Cast Rollers.—See that the roller-mould is perfectly clean; make a mop and with it oil carefully every part of the interior of the mould. Now turn your attention to the stock; be quite sure that it is perfectly dry, and if the composition is apt to slip off it, bind some string very lightly upon it, then place it in the mould, being very careful that it stands true in the middle; fit on the guide at the top, and fasten the stock down to the mould with string lest it should rise; then warm the mould all over. Meanwhile your composition will have been melting: take care that it does not boil, and stir it about occasionally. Never re-melt old composition without a good proportion of new, and if the old is very hard, you may add some treacle. It is best to use one of the special kettles sold by the printer's furnishers, as otherwise there may be some difficulty in getting the composition to melt properly. When it is quite melted, carefully pour it into the mould, filling it to the level of an inch or two higher than the end of the stock to allow for shrinkage. Let it stand for about twelve hours; then prepare to draw the roller out of the mould. If it will not come readily, one man must hold the stock and another the mould, and they must pull without jerking in opposite directions. Pushing upon the lower end of the roller may perhaps be necessary also, but if the mould has been properly oiled there ought not to be much difficulty in drawing it. When out, trim the ends, and hang it up in a dry, cool place for a day or two before using.

Lubricating Roller Moulds.—Sperm and lard oils are the best. If they are properly used, no trouble will be experienced in drawing the rollers.

Facts about Rollers.—The setting of a roller, especially on a cylinder press, requires care and judgment. Rollers cast from re-casting composition never shrink. Roller trucks should be one-sixteenth of an inch less in diameter than the roller. Glue and molasses rollers should be kept in an air-tight box with a shallow jar at the bottom for water as needed. In damp weather remove the water, in dry weather let it remain. Rollers when out of use any length of time should be put away with the ink on them to protect their surface from the action of the atmosphere. Several things enter into the choice of composition, such as quality of ink used, climate, class of work, requirements of presses, &c. The cores should be cleansed by scraping, or, if of wood, by scalding in strong lye or soapsuds, then dried. New rollers should be washed in sperm or coal oil before use. It will prevent the strong suction. Turpentine is better than benzine for removing coloured inks. Never use lye on new rollers.

Treatment of Old Rollers.—When rollers have been lying for weeks with a coating of ink dried on to the surface—a circumstance that often occurs, more especially when coloured inks have been used—get an ordinary red paving brick (an old one with the edges worn away will be the best), place the roller on a board, then dip the brick in a trough of cold water and work it gently to and fro on the surface from end to end, taking care to apply plenty of water, dipping the brick in repeatedly, and in a short time the ink will disappear. Nor is this all; for if a little care and patience be exercised, it will put a new face to the roller, making it almost equal to new; the coating of ink having, by keeping the air from the surface, tended to preserve the roller from perishing. Sponge off clean.

Good Wearing Rollers.—It is stated that rollers made from Chinese sugar-cane molasses are far superior to those made with any other kind. The syrup will bear long boil-

ing without granulation, and when cast into a roller is much tougher, more elastic, and has better suction than those made with the material in common use.

Rollers out of Use.—Rollers put away in an upright position, and allowed to remain idle for a week or longer, are observed to have a smaller circumference near the ends than at the middle. To avoid this it is suggested that the rollers should be placed in boxes lying lengthwise, with a bearing at both ends in the sockets provided for the purpose.

Arched Rollers.—The arching of rollers is generally caused by the roller becoming dried or hard. When it takes place, and the outside edges bear off the centre of the roller, cut a strip of the composition off each end with a sharp knife.

Flaring a Roller.—This operation is both dangerous to the roller and unsatisfactory in its results, but nevertheless we give particulars how to proceed with it, as it is a very favourite device with London pressmen, especially in small offices. It is as follows: Get a sheet or two of waste printing paper, make it up into a loose torch, and when lighted flare the roller all over, just sufficient to add a new face to it without melting the composition. This plan will, if successfully executed, close up the fissures caused by the cutting of brass rule.

Washing Rollers.—Rollers must not be washed with lye until they are beginning to wear somewhat. Smothering in common ink and scraping are recommended in preference. Old enamelled-faced rollers may be washed with turpentine with great advantage, as it makes them sticky, which produces a slight temporary suction in the roller. Washing with turpentine will soon spoil a good roller, the stickiness produced becoming a dryer or coating on the face of the roller.

Cooling Rollers.—As ice-chests are now very common, it may be well to warn the printer on no account to put a

roller in such a receptacle, or it will soon become frost-bitten and utterly useless. It might be thought that when the roller is almost separating from the stock in hot weather almost any mode of cooling it would be desirable. The sudden chill to the surface is, however, quite enough to spoil the roller before the cold has time to penetrate sufficiently deep to harden it. If unworkable, owing to the excessive heat of the atmosphere, hang the roller all night in a cool, dry cellar, or in any cool place where a good current of air can get to it. If it is a small roller, swing it well to and fro for a quarter of an hour before using it.

Warming Rollers.—If rollers have become too cold, place them in warm rooms, not near the fire, until they recover themselves. When they begin to work, place a candle or gas jet under the ink-table—if an iron one, the flame about a foot below the iron—and occasionally vary the position of the light. The table must not be made hot, and the heat applied must be imperceptibly small, as the object is only to remove dampness and the rigidity of the cold.

Damp or Greasy Rollers.—These may be known by their printing a dull, dirty grey instead of a proper black. If new, wash them in turpentine; if old, in lye. A far better plan is to smother them in common ink-scrape, and sheet them; this is always effectual. If a damp roller does not recover with this treatment, you should hang it up in a warm room until it does.

Cracked or Cut Rollers.—These are almost incapable of being mended. If they are cut by working rule formes they may be carefully “flared” with a piece of lighted paper, and hung for a day or two to recover themselves. If split or cracked by accident, let the flame of a lighted candle into the fissure and close carefully with the fingers; then let the roller be hung up to recover itself. The fingers must be wet, to prevent the composition sticking to them.

Caution is necessary not to use a cut roller for colour-work, as the old black ink will be sure to ooze out of some of the apertures. When working at press always cut round those parts of the roller-handles which rest upon the ink-table before commencing colour-work, or the black ink which adheres to them will deteriorate the colour.

Difficult Rollers.—If printer's thin varnish be added to the ink in small quantities it very frequently allows the roller to work, although with a pale, greyish appearance. The ink we now suppose is good, and the roller unruly. This expedient should only be resorted to on emergencies, although it is a favourite device with some pressmen. If you have a very hard roller and wish to work a light job, such as a circular, spit four or five times on the ink-table and distribute with a small job roller, holding it as you would a mallet, and well hammer the table with it, distributing it at the same time; that is, each time the roller strikes the table draw it along the table to the edge. Five or ten minutes bestowed upon the roller in this manner will cause it to work off a short-numbered job quite satisfactorily.

To Dry or Warm a Roller at a Short Notice.—Hold it a few feet from a moderate fire, and keep turning the roller on its axle for five minutes. Or, take some sheets of waste paper and make them as hot as you can, wrapping the roller in them, one after the other. If a new roller be required from a roller-maker, always send a blanket with the boy, to wrap it in. If to be sent by train, rollers should be suspended in a box.

Too New Rollers.—Coat the roller by distribution with balsam of capivi and let it hang for two hours; after which, scrape it. This evil-smelling drug is also very useful if mixed with black or coloured inks when they do not work satisfactorily.

Preserving Rollers.—A simple process for preserving and renovating ink rollers, and adding greatly to their longevity,

is as follows : A steam jacket is added to the roller closet, and numerous fine jets are so arranged as to play gently upon the rollers within. These jets thoroughly cleanse the surface of the roller, the skin on its face disappears, the body of the roller absorbs a portion of the heated vapour, and the whole is kept in a fresh, elastic condition, ready for work without further preparation. Experiments by practical men seem to show that the contrivance possesses considerable value, and is likely to prove very economical in large printing establishments.

To Keep Rollers.—In Germany the following preservative of rollers when not in use is often applied : Corrosive sublimate, 1 drachm, fine table salt, 2 oz., are put together in half a gallon of soft water. The mixture is then allowed to stand twenty-four hours, and must be well shaken before using. It is applied with a sponge after washing.

CHAPTER XIX.

Inks—The Management of Inks—Description of Various Kinds and Properties of Good Inks for different Purposes—Recipe for Black Ink—Mixing of Coloured Inks.

THE *ink* used for printing purposes is now manufactured mainly by outside persons, and the printer is relieved of the trouble of making his own. Perhaps this is for the best, for the firms which make it their business are better able to give it their entire attention, and, further, it is produced under the care of responsible persons with some chemical knowledge.

Ink is a substance consisting of varnish, with an added colouring matter. Taking black ink as an example, this varnish is composed generally of the best linseed oil, boiled,

with the addition of resin, and occasionally soap—the colouring being obtained by means of lampblack, some makers intensifying the depth by a little indigo or Prussian blue.

The management of inks seems to be little understood by many printers. Printing ink is substantially a paint triturated to extreme fineness. There are occasions, of course, when the least amount of colour that can thus be put on is sufficient, but it generally needs more, and especially so for handbills and posters. The first requisite in this case is that they shall catch the eye quickly, which cannot be done by hair-line faces or small quantities of ink. They should be charged with colour. Principal lines should have more impression than weaker ones; this is generally better accomplished by underlays than overlays, for not only is the impression stronger, but the line will thus take more ink. The more slowly the impression is made the blacker the line will appear, as the ink has then time to penetrate. It is well sometimes, when extra solidity of colour is required, to run a good piece of work through a second time. House-painters do not finish a house at once, but lay on one coat after another until the requisite intensity of colour is obtained. Especially should this precaution be followed in pale or weak colours, such as the various yellows. One great reason why this hue is hardly ever used by printers, except through bronzing, is that it always looks pale and ineffective on paper, and is lost in artificial light. The colour, in its various modifications with red and black, is very effective, as can be seen by looking at the leaves of trees in autumn, which are compounds of green, brown, red, and yellow, the first soon disappearing, and brown being the last to go.

Inks of various qualities, and for different purposes, can be obtained. What will suit one class of work is not always adapted for others. Broadsides require a thinner kind

of ink, which need not be of an expensive kind. Book-work should be printed with an average priced ink, and, further, the conditions under which it has to be applied must be taken into consideration. Hand-presses require a stiffer character of ink, whereas machine printing demands a softer kind, and this too depends on the rate of production of the machine. Jobbing inks, of a quick-drying character, are necessary for the speedy turning out of such orders. Illustrations, too, have a special make, designated "cut" ink, which is higher in price. Many improvements have been made in the manufacture of ink from time to time, which have tended very greatly to reduce the price, but the printer is strongly urged not to use a cheap article for good work, if he is desirous of his work retaining a permanent colour. Select an ink which will work clean, and one that is a good black, neither blue nor brown in shade. This can be better seen in the printing of large type, where there is a larger mass of ink. Some inks have a tendency to turn brown in drying, and this should be carefully watched. The drying properties should be noticed—offset, after a reasonable time, being as great an objection as too quick-drying when used for book-work. The paper to be used must also be considered, whether wet or dry. Ink that is used on dry paper must be naturally more rapid in its action, and a smaller quantity is required in the printing of such papers; on the other hand, dampened papers require more ink and need not be so quick-drying, for the drying of the paper absorbs the ink. Coloured inks are most difficult of manufacture, and necessitate very great care in working. The colours should be thoroughly ground and mixed, and varnish of only the very best quality used. Lighter colours are usually more easy to print, but some dark colours are more difficult to work than others of a darker hue.

Savage, in his book "On the Preparation of Printing

Ink," 1832, gives a recipe for a good black ink for ordinary work :

Balsam of capivi	9 oz.
Best lampblack	3 ,,
Indigo <i>or</i> Prussian blue	1 $\frac{1}{4}$,,
India red	$\frac{3}{4}$,,
Turpentine dry soap	3 ,,

This makes a total of 17 oz., the whole to be well ground.

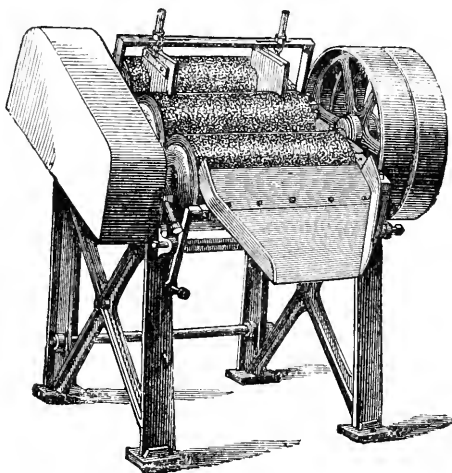

Fig. 109.

For the grinding of ink, *mills*, fig. 109, are made, but for small quantities the slab and muller may be used. Under any circumstances, the last articles should be kept if the printer desires to fall back on his own resources for coloured inks. For this purpose, too, the prepared varnish must be obtained, and an assortment of dry colours kept in stock for immediate requirements.

In the making of coloured inks cleanliness and thorough

grinding and mixing are absolutely necessary. Avoid adding white for reducing colour, as it takes away the brightness—this especially refers to the light shades of colours. The addition of a little curd soap prevents the ink clogging the face of the type, and also reduces the tendency to “skin” of the top part of the ink when in the can.

CHAPTER XX.

Printing by Hand-presses — Method of Covering Tympan — Fixing Forme on Press and Making-ready—Cutting the Frisket out—Obtaining Register—Press Points—Even Colour in Working off—Lubricating the Press—Difficulties due to Change of Temperature—The Cleansing of Type—Set-off—Slurring.

HAVING a short description of the presses generally in use, and acquired some knowledge of the properties of rollers and inks, the pressman may proceed to commence operations by covering the *tympan*, both inner and outer.

Each skin of parchment should be selected some two or three inches larger than the frame of the tympan for which it is required. It should be uniform in substance as far as possible, and free from holes and other blemishes. Lay one of the skins on a table, or bank, if wide enough, and place the frame on it as near the centre as possible, thus leaving an equal margin all round for turning in or lapping over. The best surface of the parchment should be turned to the side which will be nearest the forme, supposing it is the outer tympan you are doing first. If this be the case, holes must be cut in the margin to allow of the tympan hooks being placed through, and a piece taken out of the four corners to permit of a neat turning over,

without being bulky or clumsy. The point-grooves in the frame must be left open, so that the points may be fastened in any position. When the shape has been cut out, raise the frame, and well paste it with a strong mucilage, first seeing that it is perfectly clean, and that all old paste and parchment is removed from it. After this, well paste the outer edge of the parchment that has to be turned over the frame. When these two things have been done, put them into position again, and commence turning over the parchment, and tuck in with a folding-stick. In doing this care must be taken that it is not pulled or stretched too much in any particular direction, but put on squarely and equally. The edge of the four sides of parchment should be wrapped well round and underneath the frame, first seeing before pasting that the superfluous margin is not too much for this purpose. The covering of the inner tympan is a much more simple task, and therefore, perhaps, better for the learner to begin with. After the paste has dried, the parchments may be sponged with clear water, and allowed to dry again. When completed, the two parchments should be perfectly tight, as in a drumhead.

The next operations are successively fastening the forme on press and making ready for printing. This last expression embraces the most important point in the art of printing, as distinct from composition. Without proper making-ready all efforts are thrown away, and therefore it is essential that the utmost pains be taken in the proper execution of this part of the business. Roughly, making-ready is bringing up the type to a level, and making the pages register in backing or perfecting of the sheet in printing. If type is new it is pretty level; not much trouble is experienced, and a few sheets only are required to be placed in between the tympan. If a fount is somewhat worn, it requires more time and patience

in bringing up to a proper level; in this case more sheets are required in the tympan, or a blanket of flannel, felt, or rubber may be used. The inequalities of type are counteracted by using thin paper, cutting it away where the impression is high, and where low adding a piece the required shape by pasting. Practically speaking, if the type was new and absolutely true, and the platen and forme carriage equally correct in its parallel, little or no make-ready would be required.

Fastening the forme on press.—The type surface should be placed in the centre of the press exactly, and the chase fastened to the corner-pieces of the bed with furniture and quoins. If by chance the forme has to be lifted for any purpose after fastening down, the exact position should be marked on the press with a pencil before lifting. When the forme or chase is a small one, it may be fastened by furniture stuck down with a piece of melted roller composition, the glue contained in this acting as the adhesive power. This, however, is not a reliable method for heavy formes, even if they be small, and an outer chase should be used as a fill-up. Better still, use one of the special chases now made with a movable bar either end, which was shown in an early part of this work; this enables the pressman to secure his forme with a minimum amount of trouble.

Making-ready.—After all is fast, a few sheets, say six or eight of very thin double crown, should be placed in the tympan to take off the hardness of the impression. Supposing the impression of the press is somewhat set to a type forme, a proof may be pulled for final revision by the reader. At the same time, if the forme is the first one of a new work, a proof should be taken on its own paper, laid as carefully as possible in the centre, in order that the margins made may be duly certified as correct. These two things done, the pressman may proceed to pull

his impression sheet without ink. Before lifting the tympan up two holes should be pricked with a pin or needle right through the tympan at both ends, in order that when this sheet has been patched up (*i.e.*, made level), it can be placed between the tympan in its exact position by means of the corresponding holes, pasting it at the corners to prevent shifting. After the impression sheet has been pulled, it should be taken to a well-lighted place and turned face downwards on an inclined board. By choosing a good light the impression made can be seen by a side glance. Where the type stands high it should be cut away, and where low it should be patched up with the very thin set-off paper—corners and pieces of this paper being torn off to the required shape and pasted on the parts which do not come up well—thus equalizing those parts that originally stood high and low. When this is done, it can be placed into its position as before explained, and a second and third sheet, if necessary, pulled in the same manner and examined, till the whole forme has been well brought-up. Before pulling the first sheet, we should have said that if the forme is not a solid one, that is, if any of the outer sides of the type are short or entirely blank, the absence of printing surface must be compensated for by the substitution of a bearer in the shape of anything type-high,—a metal clump for preference. If possible, this bearer should be so placed that it will not be impressed on the paper, because it leaves an ugly mark which will not come out in pressing the sheets afterwards. It should be placed just beyond the extreme edge of the paper opposite to the short or blank page; this plan obviates any possible hardness of impression on that part of the printed sheet. The bearer can either be fastened with the locking-up materials which hold the forme to the press or stuck down with melted roller composition.

Cutting the frisket.—After the impression has been levelled, this may be done. To prepare for it, it is best, in the first

place, to paste the frisket frame all over with stout brown paper, and lay it aside to dry whilst patching up the impression sheets. The frisket being dry can then be fastened to the tympan with the pins supplied for that purpose, the forme inked lightly, and the frisket and tympan turned down over the forme. A light pull should be taken, or, as some workmen prefer, the whole forme beaten gently and

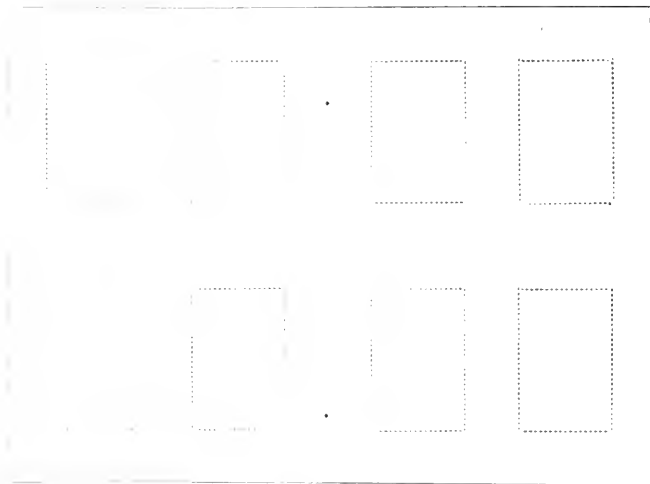

Fig. 110.

firmly with the palms of the hands. This indicates the exact position of the type to be printed. The frisket should then be taken off, and all the parts to be printed cut out with a sharp knife or pair of scissors, care being taken that all the printing surface is eliminated from the frisket, otherwise superfluous frisket sheet will cause a "bite," or non-printing of the portion that should be printed. This satisfactorily executed, it can then be re-fastened on.

Firing the points.—The next operation is to secure proper

register on the second side of the sheet, whether it be half-sheet or whole-sheet work. Assuming it is an octavo which is on the press before us, the point-holes would fall as indicated by the dots in fig. 110, the points being screwed in the grooves by means of the *point-screws*, fig. 111.

These *points* are made of two kinds, spring and ordinary. The first are adapted for assisting in throwing the sheet partly off when impressed, which is a help to the pressman. They are also made in different patterns, according to the size of the work in hand. We show an octavo, fig. 112, and a twelvemo *point* (with an elbow), fig. 113, both with the spring attached. The ordinary ones are the same shape precisely, only without the spring tongue. In addition to these points there are others, and



Fig. 111.



Fig. 112.

amongst them the *paste points*, used for obtaining particularly fine or close register; sometimes four of these are used. These are pasted in between the two tympan—the point or spear protruding through the outer parchment; frequently drawing-pins are used for the purpose, but care must be taken that they are firmly secured, or all your labour will be thrown away. These points, when they fall in the middle of the sheet, and in a corresponding position to the cross-bar where one is used in the chase, must fall in the grooves, fig. 114, in the centre of the short bar, otherwise the spurs will be smashed at the first pull taken. It will be observed on the diagram given of the sheet showing the point-holes, fig. 110, that the off-side one is somewhat nearer the centre

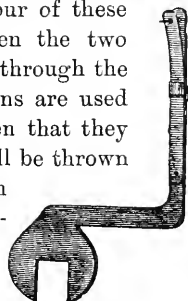

Fig. 113.

than the near-side one; this is merely to obviate the necessity of the pressman reaching over so far in pointing the second side of the sheet.

Making register.—The sole object of points is to obtain perfect registration in backing, or printing the “reiteration” of the sheet, as it is called. To arrive at this, supposing the forme is correct as regards its furniture and straight-edging, the points must be placed in the dead centre of the sheet. Pull an inked proof, and then turn the sheet from top

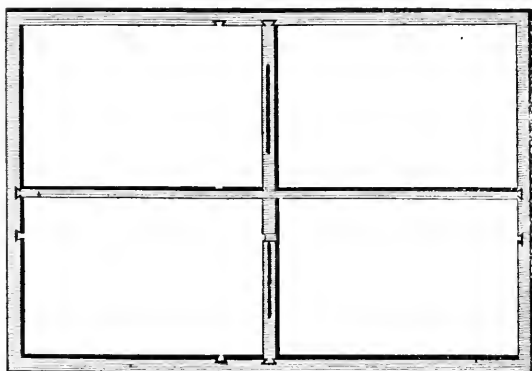

Fig. 114.

to bottom, and not from near-side to off-side, as would be done in the case of a twelvemo. Half-sheet register should be made, even in sheet-work; at any rate for the first forme. This having been done, the sheet should be held up and examined page by page, to see what is the result of register. If the pages do not fit in with each other correctly, the reason must be found out. Two causes may be responsible for it—first, that the furniture has not been gauged up truly, or the pages not straight-edged properly; or, second, that the points have not been put on in the centre or squarely. If the fault is due to the latter, the point on the side in

which it is out must be gently tapped in the direction required to make better register. If the furniture is the cause of the imperfect backing, the forme must be unlocked and altered as desired, and for this purpose scaleboard should always be placed in the crosses of the formes in making-up or gauging the furnitures for press. The bringing-up, register, and frisket completed, any possible slurs should be obviated by corks being stuck down on the forme at intervals, and likewise on the frisket, between the pages. These pieces of cork should be cut into slices, and when fastened down on the furniture should be sufficiently thick to be a shade higher than the type. They act as bearers to the paper only, and, in the case of any bagging of the tympan or frisket, prevent the sheet from sagging and keep it flat. Corks on the forme, placed judiciously, also prevent the roller from jumping or wiping on the extreme edges of the pages. It is a good plan to have these corks so arranged both on the near-side and off-side portions of the forme, in addition to being placed at the end of each space caused by the gutter or back margins, otherwise the roller will drop, in rolling across, between the line of pages, and deposit an objectionable excess of ink at the edge of the page. After these details have been carried out, the revise signed, and the necessary paper obtained from the warehouseman, the ink-table may be put into condition, and the colour-sheet approved of.

Uniformity of colour in working is a matter of great importance, and to maintain this it is necessary to have proper and equal distribution of ink. In braying-out the ink do not spread it out too far over the table, or else you will not leave room for proper distribution. Take little and often, rather than large portions for braying-out, adding to the roller from time to time. Good press-work should be free from "monks" and "friars." The first are black and dirty patches in any portion of a sheet, and the last are rotten, or pale

parts in any page. To give a good and even colour take fresh ink and distribute well, and then reverse the roller and redistribute before taking another supply of ink, each of these actions being separately taken in rotation as the sheets are printed one by one. If the forme is a light one, the reversing of the roller and redistribution can be repeated before taking fresh ink. Experience will soon teach the pressman when to take more colour, but regularity in these details will insure greater evenness. These remarks are to be impressed on the learner, and cannot be too often dwelt on. If regularity is observed, and the roller is kept on the move continuously, being sometimes reversed, the difficulty will be greatly reduced; especially if the forme, too, is rolled equally each time. Always commence and finish rolling on the near-side. Cleanliness is important, therefore both the forme, roller, and ink-table should be absolutely clean. The colour-sheet should be kept well in sight for the first side of the printing. This done, the sheet can be laid aside for the time. In checking the colour of the second side or forme, the side first printed can be turned up occasionally for comparison. Having got the roller in order and the paper ready, the lay of the sheet for the first side should be determined by halving the margin exactly, both at the top and bottom and the two sides of the paper. This lay is made by sticking pins in the tympan obliquely, two for the off-side and one for the foot. After the first side has been printed, these pins should be removed and the second side laid on the spurs by the point-holes made in the sheet by the first impression.

In book-work it is customary for two men to work as partners, each taking it in turn to roll and to pull. It is the duty of the one rolling to straighten the sheets as laid off, and to keep a look-out for any deviation of colour, or other defects. The man pulling has all his work cut out in laying on, pulling, and taking off the sheets as printed,

preparatory to commencing the same operations over again for each sheet.

Lubricating the press.—For the proper and easy running of the press it should be kept well oiled. The *lubricant* should not be applied too freely, otherwise the press is likely to become very dirty, apart from the waste occasioned by an excess. Lard oil is a good lubricant, though difficult to keep liquid in cold weather.

Extremes of weather occasion difficulties in the press-room through their effect on the rollers and ink. Rollers, as before mentioned, get hard or soft according to temperature, and a few hints on this subject have already been given. Ink, too, is difficult to distribute in cold weather

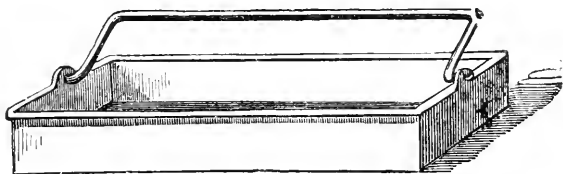

Fig. 115.

the inking surfaces refusing to take kindly to the ink when chilled. A gas jet attached to a flexible tube may be lighted and placed under the table for a few moments, in order to bring it up to a normal condition. Printing offices are nowadays much improved in respect of more equal temperature, as in olden times it was a very frequent occurrence for the pressmen to be "frozen out" (*vide* Moxon).

Cleansing the type.—Solvents of various kinds, generally called *lye*, are used, but are only applicable to black ink—colours requiring turpentine. The *lye* mostly in use is pearlash, but other chemicals are also in demand. The proportion of water to a pound of pearlash should be about a gallon. This is the old-fashioned wash, and after all

perhaps the best. One pound of potash to four quarts of water is another recipe. To hold the lye, troughs are used and replenished from jars in which it is stored. We give illustrations of a portable *lye-jar*, fig. 115, and a *trough*, fig. 116, in which formes may be placed and washed, being taken out for rinsing with clear water afterwards.

Off-set and Slurring.—These are two other matters which should be watched for. The first is caused by the off-set of the ink of the first side in printing the second, if it has not

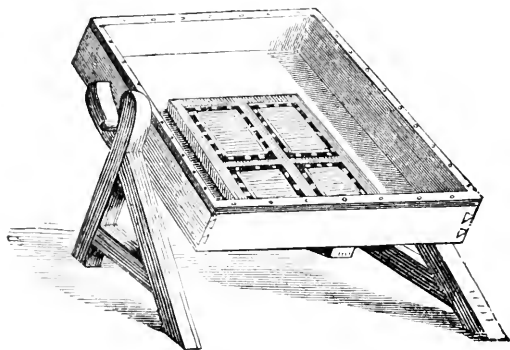

Fig. 116.

had sufficient time to dry. To prevent this it is necessary to change occasionally the thin set-off sheets pasted by the four corners on the tympan. Oiled sheets are sometimes used for this purpose; home-made ones may be manufactured by washing them over with turpentine—this obviates the necessity of changing frequently. The following suggestions may also be of service :

Set-off Papers.—A paper saturated with benzine is as good as, or better, and much cleaner than oiled paper, to avoid a “set-off,” when work has to be printed on both

sides. Also a sheet of paper wet with glycerine and used as a tympan-sheet will prevent off-setting.

If not detected in time the set-off of ink will be transferred to the subsequent sheets in printing. Slurring, which gives the printed sheet a double or mackled appearance, is occasioned by the bagging of the sheet or sagging of the tympan or frisket, and may be remedied by slices of cork, or springs made of paper rolled up and fastened on the frisket between the pages on the part of the sheet at fault. Or it may be due to some mechanical defect in the platen, probably the platen bolts themselves requiring tightening up—under any circumstances the cause must be sought for, and the fault rectified.

When the forme has been printed the sheets should be counted before lifting it off the press, in case of “shorts” in the paper, or spoilages. Printers’ reams are made up to 516 sheets; this allowance is ample for “overs” and a reasonable amount of spoilage or waste, unless it is for exceptional work. For smaller numbers the proportions of the overs to a perfect ream should be thrown in; thus, for 250 of sheet-work 258 sheets should be given out.

CHAPTER XXI.

The Printing of Illustrated Work—Care of Woodcuts—Cutting Overlays for Cut-work—The Degrees of Work in a Cut—Process Blocks—Rolling and Beating for sufficient Colour—Specimen of Cut without and with Overlay.

THE art of *woodcut printing* is capable of a large amount of treatment. To bring out the degrees of light and shade of an illustration which has much work in it is a task which requires a great deal of experience; in

fact, the workman should possess some artistic qualification to appreciate and to give effect to the artist's design. To print a block correctly, the system of overlaying must be adopted. This is performed in a similar way to ordinary making-ready, but of course requires much more judgment and practice. In the first place, though the woodcuts themselves are not always used, a good electrotype taken direct from the original block, provided it has not been printed from, is almost equal to the wood-block; in the case of an accident on press to the electro, the cut can be easily duplicated by the same process.

Woodcuts, too, are very apt to get warped, and the joints, though bolted, are liable to open through a variety of causes, such as washing over or rapid changes in the weather. Under any circumstances, when illustrations are printed from woodcuts, they should be cleaned with turpentine and wiped carefully with a rag—water must by no means be used; if left on the press for any length of time, they should be run underneath the platen with the tympan first turned down. Sometimes it is well to pull the bar over and fasten it with a slight pull on. In the event of the cuts warping or twisting, a good plan is to lay them face downwards on something damp and run them in under the press, leaving them overnight with a small amount of pull on.

In preparing an *overlay*, the engraver's proof should be obtained, or, in the case of process blocks, the original drawing, as these very greatly assist the workman in bringing out the details, and at the same time give prominence to the parts required. It is quite possible to give two different effects to any cut by the system of overlaying, if the meaning of the picture cannot be readily grasped; therefore it is very advisable to work by some proof or copy in cutting out. The same amount of delicacy cannot be always realized in printing as in an engraver's proof.

Perhaps the latter is taken singly, with a very special ink, and burnished up by hand to give the necessary difference in light and shade—even the excess of ink, in light tints, sometimes being partly wiped off. However, the india proof should be emulated as far as practicable in the making-ready.

The work in a cut, assuming it is landscape, may consist of three degrees as regards depth, *i.e.*, solids, light tints, and medium—the foreground usually being the more solid, and the background the lighter work, the intermediate part forming the medium shade. This is a general rule, but objects in the background have sometimes to be brought forward by means of overlaying, and the reverse applies to the foreground, when it is requisite to cut away. Distance must be allowed for in looking at a picture; this can be increased or decreased in a very great measure by perseverance in the art of overlaying. It is an important thing, too, that rottenness of impression should not be mistaken for light tints, as frequently in cutting away the workman is liable to take too much. All the work must be there, and, as before said, there is a distinction to be drawn between lightness and rottenness or broken lines. If the artist or engraver desired the latter, he would not go to the trouble of cutting work which is not to appear. Let your work be sharp and sound, even if very light. This is a great feature in woodcut printing. In cutting away lights skiver or peel away your thickness of paper, and do not make a straight deep cut. Vignette work is particularly difficult in this respect, and these remarks chiefly apply to this kind of work.

Cutting overlays.—To commence with the overlay: pull three or four good sound flat impressions, with not too much ink, on a hard kind of paper—cream wove is preferable, say about 24 lb. large post; do not use a laid paper by any chance. This done, they should be put aside

to dry. Four is an advisable number to pull in case of accident, but three only will be really required for most cuts. The object now is to blend the three impressions into one overlay, by cutting away certain parts of each and pasting together. Let your paste be good and strong, but of a thin consistency, otherwise the delicacy of your work will be impaired. Take one of the pulls, and treat this as your number one, or foundation for the whole. In this one all the light tints may be carefully cut out—not abruptly, but in a gradatory manner—by using your knife in a slanting direction, and consulting the engraver's proof for differences of light and shade. When this has been done thoroughly, the second pull can be adapted for the solids, by cutting these parts out very clearly and sharply; the edges of these need not be cut out so slopingly, but great care must be taken in pasting these pieces on, that they fit exactly on the corresponding portion of the first impression cut out, because, if they shift by any means, the whole labour expended on the overlay is wasted. If the paste is not sufficiently tenacious, the pieces are likely to move in printing, and the result may be disastrous to the appearance of your cut. Number three of the pulls may be treated thus: cut away the light parts, and retain the solids and medium. In cutting out the last part of this pull the medium parts should be softened down in the cut by slanting your knife. To obviate hardness on the edges of your cut, the overlay, when all has been pasted together, may be rubbed down slightly, or even skivered. These three thicknesses will be sufficient for most cuts; difficult cuts may have four, if there is a broad difference between the depths of shade comprised in the illustration. Before putting the overlays on, if the cuts are printed with type, the blocks should be underlaid so as to bring them up to a slightly higher level than the type. In fastening the overlays up, after the remainder of the making-ready has been performed,

great care must be taken that they are pasted down in their exact position. When they have been fixed, and a trial sheet has been pulled, they can be further humoured and touched up. All overlays should be preserved, packed up, and labelled, because in the case of reprints much valuable time and expense are saved by keeping them.

Process blocks are generally of a more sketchy nature, though lately some marvellous specimens of photo blocks as regards fineness and details of work have been produced. Special papers are even more necessary for these than for woodcuts, owing to the little depth in the face of the blocks, and dry super-calendered papers are the most suitable for their proper production. Very frequently more effect is got out of a flat pull, supposing it has been first roughly levelled, than by an elaborate overlay. A sharp and hard impression, with a suitable paper and good ink, is required. In printing these the original drawing, from which the block is made, is a good guide in making-ready. As dry paper is used for these process cuts, a good drying ink, to work clean, is necessary. For woodcuts the same kind of paper is used, but plate paper, or woodcut (semi-plate) paper, is perhaps more frequently in demand for this class of work. Papers are also now made termed "art papers." These have a prepared surface, apparently obtained by enamelling, and are well adapted for some classes of work.

Printing heavy cuts.—In press-work it is necessary to beat the cuts with the roller in order to impart the necessary amount of ink. It requires some skill to perform this properly if the blocks are placed in the midst of type. On machine, exceptionally heavy cuts are sometimes made a separate and distinct working.

Examples of cut printing.—For the sake of comparison we give here two illustrations. Fig. 117 is simply a flat pull without any making-ready whatever, and fig. 118 is

printed with an overlay of three pieces cut out and pasted together. These prints are taken from two separate electrotypes of the same wood-block. If these different impressions are carefully studied, the result of overlaying will be seen. The exact details of each overlay cannot be shown in print—at least, not in any cut with a fair amount of work. The difference between two prints, one overlaid and the other not, is sufficiently marked to give some idea of effect.

A competent person who has an appreciation of pictorial effect can get much better results out of a woodcut or process block than one who is not gifted with some amount of taste, though the latter may labour at it, and spend considerably more time over it.

Let it then be remembered that the last specimen here given has been executed simply with three thicknesses in overlaying, a little subsequent finishing being applied when placed in position. Some cuts of more elaborate nature as regards light and shade may take four or even five, but three are sufficient for an average cut. Moreover, it is best to avoid so many distinct and separate pieces, as the impression of any great thickness on the surface of the cut has a damaging, or at least depreciating, effect on the block itself after any large number has been struck off.

Rolling of the paper, both before and after printing, improves the appearance of illustrations, but the paper need not be glazed in the first instance if it has already a good surface.

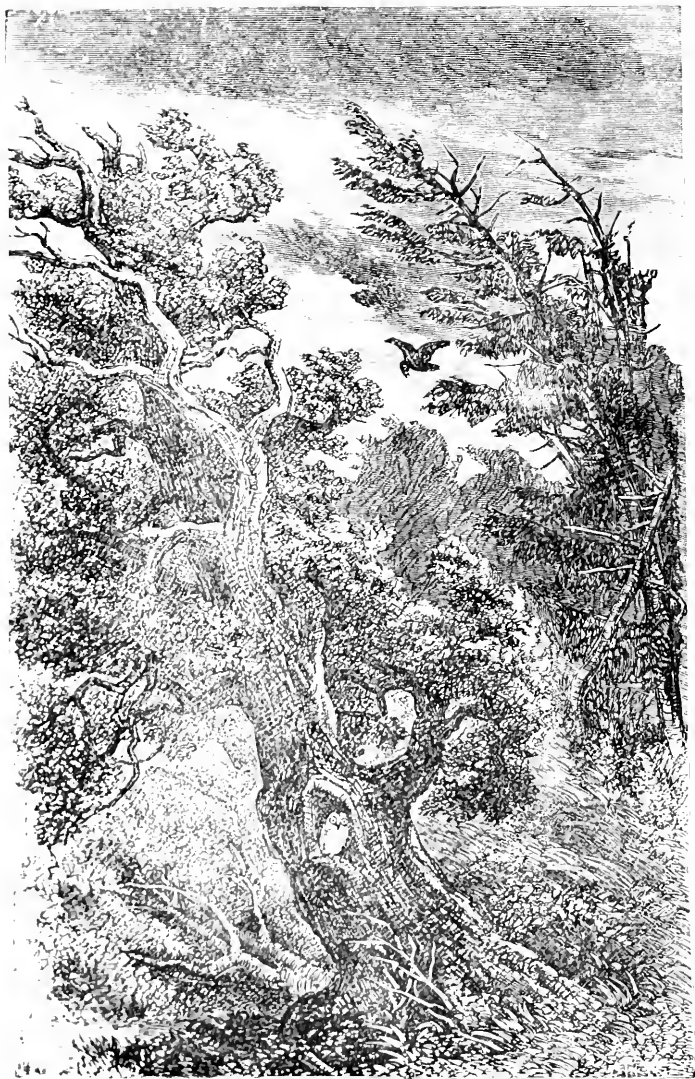

Fig. 117. Printed *without* Overlay.



Fig. 118. Printed *with* Overlay.

CHAPTER XXII.

Colour Work—Method of Printing by Underlaying and Skeleton Formes—Hints on Colour—Selection of Colours to Harmonize—Register of Colour Work—Bronze Work and Appliances for same—Some Remarks on Bronze Work.

COLOUR work, in the press department, is an important branch. Perhaps not so much is done now as formerly, owing to the perfection of chromo-lithography. *Colour printing*, as far as letterpress is concerned, is more frequently confined to works printed in any one colour, or books which are rubricated, or have a red line or border round.

There are two methods in practice for the latter description, *i.e.*, either by underlaying or by printing from a second or "skeleton" forme—the latter being adopted where there is much of a second colour to print, the former when there are only a few lines here and there. This has been explained before in the part devoted to colour work in the composing department. For the rubricating of religious works a red of a vermilion hue is desirable, and a pinky red is to be avoided. Other colours, of course, are dependent on taste; but whatever be selected, let your colours be good, not dirty, and always work them on a slab of marble or porcelain, as iron has a tendency to destroy the beauty of the colour. Red ink must not be applied to electrotypes unless brass or nickel-faced, because copper has a chemical effect on that particular colour, turning it almost black after a few impressions. The following is a good method to obviate this difficulty :

Printing Red Ink and Electrotypes.—Take one ounce of prepared gold size and a quarter of an ounce of the "lake-brilliant" of Cornelissen, and grind well together with a

muller; roll the electro with this preparation and let it stand for twelve hours, when it will be found as hard as stone, and the vermilion may be printed from the plate without the least injury to its brilliancy.

If other than red and black are used, see that the colours harmonize, whether two or more kinds, for even two colours may be antagonistic to each other. The laws of harmony are fixed and must be studied. The following rules may be consulted :

Hints on Colour.—Yellow and carmine or deep red produce scarlet or vermilion; carmine and blue produce deep lilac, violet, and purple; carmine, yellow, and black produce a rich brown; yellow and black, a bronze green; yellow, blue, and black, deep green; carmine and white, pink of any shade; ultramarine, white, and carmine, deep tones of lilac; violet and white, pale lilac or lavender; cobalt and white, lively pale blue; and Chinese blue, deep bronze blue, chrome, pale lemon, any tone of emerald green. Amber is made from pale yellow, chrome, and carmine. Red brown is made from burnt umber and scarlet lake. Light brown is made from burnt sienna shading with lake. Blue and black are made from deep blue or deep black. Salmon is made from burnt sienna and orange, shading with white.

TWO COLOURS WHICH HARMONIZE WELL.

Scarlet red and deep green.	Chocolate and bright blue.
Light blue and deep red.	Maroon and warm green.
Orange and violet.	Chocolate and pea-green.
Yellow and blue.	Claret and buff.
Black and light green.	Violet and pale green.
Dark and light blue.	Deep blue and golden brown.
Carmine and emerald.	Deep red and grey.
Red and black.	Deep blue and pink.
Black and warm brown.	Maroon and deep blue.
Violet and light rose.	Black and warm green.

THREE COLOURS.

Orange, black, and light blue.	Dark brown, orange yellow, and blue.
Light salmon, dark green, and scarlet.	Crimson lake, greenish yellow, and black.
Brown, light orange, and purple.	Red, yellow, and blue.

FOUR COLOURS.

Black, green, dark red, and sienna.	Ultramarine or cobalt blue, vermilion, bronze green, and lilac.
Scarlet, dark green, lavender, and black.	Sienna, blue, red, and black.

We add here some further remarks on the choice of colours :

The Selection of Colours.—The following table will be found useful in choosing the various tints, inasmuch as by examining them in the order here given, the eye will at once detect the slightest differences of shade. To refresh the eye

<i>Look at Greens before choosing</i>		Reds.
„	Blues	„ Oranges.
„	Violets	„ Yellows.
„	Reds	„ Greens.
„	Oranges	„ Blues.
„	Yellows	„ Violets.
„	Tints	„ Browns.
„	Browns	„ Tints.

Register is an important item in colour work. Extra points can be used, in the shape of the paste-points already mentioned, made of drawing-pins pushed through the tympan from inside, and pasted over on the back with paper to prevent shifting. The holes made by these points

are very fine and not so conspicuous as ordinary points, the pins of which are generally larger. Four points used of this character will insure greater accuracy.

Bronze work comes under the general head of colour work. The bronzes can be obtained of gold and silver. The part to be printed is rolled and pulled with an almost colourless varnish preparation, the bronze being applied with wadding, and the superfluous metal brushed off with the same piece. They should receive a further cleansing afterwards with a fresh piece of the material. The bronze portion of a forme should be printed first, as the bronze is likely to adhere to any part of a sheet printed in another

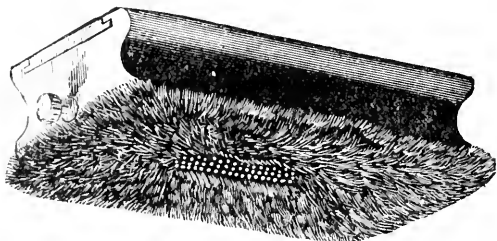

Fig. 119.

colour if it has not had time to dry. This is the old way of performing the operation, and is satisfactory for small and occasional work.

Bronze brushes, fig. 119, have been made recently, with a receptacle to hold the powder, which is liberated as the brush passes over the required part. The proper amount can be regulated by the use of the screw at the end of the brush. This powder is injurious when inhaled to any extent, and a kind of respirator is necessary if much work has to be done, as the bronze flies about.

Mechanical appliances have also been lately introduced, adapted for bronze work in large quantities. An illus-

tration is here given, fig. 120. The sheets are fed in at one end as in a rolling machine, and are turned out at the other end bronzed.

Rolling is a decided improvement in bringing the bronze up, as it gets rid of the somewhat granulated appearance which bronze always gives as distinct from leaf printing. The last method is not usually adopted in letterpress printing.

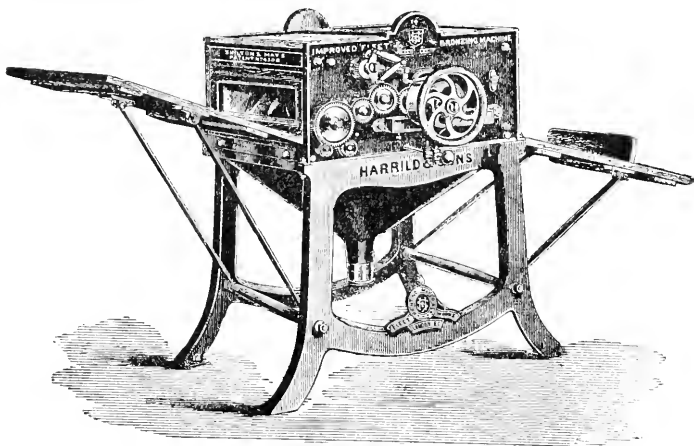

Fig. 120.

Another method is the following :

How to Improve Bronze printing.—Bronze work is very seldom thoroughly satisfactory. Its failure, as a rule, rests in the inability to fix it firmly on the paper. Of course rolling is the most reliable remedy, but if you do not happen to have a rolling machine, or the inclination to invest in one, adopt the following method: Work the forme with gold size and apply the bronze in the usual way; when the number required is completed, simply take all the rollers off the machine, clean the forme, but do not

disturb it, and run the sheets through the machine again off the clean forme. The appearance of the work is greatly improved by this process.

CHAPTER XXIII.

Stereotype Work—Methods of Mounting Plates for Printing—Varieties of Stereotype and Electrotype Plates—Some Hints and Suggestions on Press-work generally—Picks—Mode of Payment for Press-work.

THE printing of *stereotype* work is another subject requiring explanation, some firms making it a large feature of their business. The plates are mounted in various ways, sometimes on wooden, and at other times on metal blocks. There are various patented blocks of different kinds, some taking the shape of a bed, the plates being fastened down with catches, or even stuck down by the aid of some composition. Both wood and metal blocks are largely in use—perhaps metal more than wood. Metal is to be recommended because of its solidity, which means a sounder and firmer impression. They are also interchangeable, and can be made up to any shape or size by use of the different pieces. Also, when worn out, there is a considerable return for old metal. The plates on these blocks are mounted and fastened, when locked-up, by brass catches which fit into the sides and ends of the blocks, a short pin being cast on the inside, which is inserted in the block, keeping it steady, and preventing rising or blacking in printing. When made up they are imposed in the same manner precisely as type; when a forme has been printed off, the plates are lifted from the blocks whilst on the press, and another signature laid on in its

stead, the forme being gauged and straight-edged before locking-up.

To Mount Stereo Plates.—For fixing stereo plates on type-high stereo cores, thereby saving the expense of the old wood-blocks and also the labour in fixing, the following plan is a good one: The bed is a plain iron surface of any stereo-block height. It is placed on a steam-chest to be warmed, and is then coated by a brush with cement composed as follows: beeswax, 1 lb.; gum ibus, 1 lb.; Burgundy pitch, $\frac{1}{4}$ lb. It is then removed to an iron table to cool. When quite cold, the stereo plates are placed on the dry cement and adjusted. In order to do this accurately, a light wooden frame is laid over the iron bed, with cross threads stretched at proper intervals to mark the margin. The iron bed is then again pushed on the steam-chest, and as soon as the cement is melted, the bed is shunted on to the bed of a press. Loose sheets are laid over the plates to soften the impression, and the table is run under the platen. The pressure is applied till the cement is cold, and then the forme is ready for the machine. The plates are got off with a stout knife, or melted off.

Plates are more troublesome to print, as a rule, than type, because there is more inequality in thickness, even though plates are planed nowadays—formerly they were simply turned on a lathe, and a first impression was not very satisfactory, as can be imagined. There are three kinds of plates,—electrotype, and stereotype of two descriptions, those made respectively by the plaster and paper processes. The most satisfactory for printing purposes, as regards impression, are plaster plates, for they are sharper, and have more uniformity in thickness. The plaster method of producing plates is not now so much in demand, owing to the slowness in manufacture and consequent expense. Paper process plates are cheap (and nasty, too, sometimes, especially when used for poetry works). In beating of the mould, the edges,

being irregular or broken, are very liable to get hard, though the ends of the lines may have been packed-up first. This objection applies also to electrotype plates when used for the same class of work, owing to the manner of moulding, and the evil is increased by the subsequent backing-up of the plate to the standard pica thickness. For poetry it is recommended that the plaster process be used, as the nature of its production is in favour of a better impression and a sharper appearance, as before said; but as a matter of wear and tear electrotypes are preferable, plaster plates coming next, and the paper process last in respect of durability. If expedition is necessary for their manufacture, the paper process must, of course, be resorted to; for, as an instance of despatch, the plates used on the rotary machines for newspaper work are cast and finished within an hour. In printing stereotype plates on press, the making-ready is facilitated by pulling an impression sheet, and first underlaying the low parts of the plates before patching-up for the tympan sheets. This is further facilitated if the mounting blocks are underlaid to one height in the first instance.

In printing, whether it be type or stereotype, there are certain conditions which constitute good work, and these conditions can only be realized by painstaking workmen. The following points are evidence of good workmanship, provided the appliances, tools, and materials are good: impression must be firm without being too hard, and making-ready must be thorough and not hurried. A weak impression is often remedied by taking a larger quantity of ink, but this is a mistake, because the ink is simply deposited on the paper, and not impressed into it, thus creating a tendency to offset. This applies to ordinary printing of book-work on other than super-calendered paper. On the other hand, too much impression is apt to give the type a smashed appearance, and is most damaging

to the fount. In printing off, the type should be clean, the roller in condition, and the distribution and rolling equal throughout. To complete this summary of good work, the following suggestions, which appeared in a previous volume compiled by the present writer, may be thoroughly digested.

Some Hints on Press-work.—Do not try to correct the faults of hurried making-ready by a weak impression, and by carrying an excess of ink to hide the weakness. Excess of ink fouls the rollers, clogs the type, and makes the printed work smear or set off. A good print cannot be had when the impression is so weak that the paper barely touches the ink on the types and is not pressed against the types. There must be force enough to transfer the ink not only on to the paper, but *into* the paper. A firm impression should be had, even if the paper be indented. The amount of impression required will largely depend on the making-ready. With careful making-ready, impression may be light; roughly and hurriedly done, it must be hard. Indentation is evidence of wear of type. The spring and resulting friction of an elastic impression surface is most felt where there is least resistance—at the upper and lower ends of lines of type, where they begin to round off. It follows that the saving of time that may be effected by hurried and rough making-ready must be set against an increased wear of type. That impression is best for preventing wear of type which is confined to its surface and never laps over its edges. But this perfect surface impression is possible only on a large forme with new type, sound, hard packing, and ample time for making-ready. If types are worn, the indentation of the paper by impression cannot be entirely prevented. Good press-work does not depend entirely upon the press or machine, neither on the workman, nor on the materials. Nor will superiority in any one point compensate for deficiency in another: new type will suffer from a poor roller, and careful making-ready is

thrown away if poor ink be used. It is necessary that all the materials shall be good, that they should be adapted to each other and fitly used. A good workman can do much with poor materials, but a neglect to comply with one condition often produces as bad a result as the neglect of all.

Printing on Glazed Surfaces.—It is well known that printing ink when used on glazed and enamelled paper dries rapidly and pulverizes easily, so that the work is more or less rubbed off. This is due to the fact that the paper absorbs up to a certain point those elements or substances which enter into the composition of the ink and whose function is to bind together the solid elements. In consequence of this absorption the colour or lampblack rests like dust on the enamel and rubs off naturally with great facility. To obviate this inconvenience recourse is had to two different methods: either to modify the paper used or to add some ingredient to the ink which will cause it to adhere better. The latter is the preferable course, for it is the most simple. For printing on glazed or enamelled paper add a varnish rich in resin, such as is used for bronze work. This causes the colour of the ink to be somewhat deteriorated, but if care is taken there is not much to fear.

To Work Headings at Press.—Have your paper ruled to the desired pattern, and set up your type so that it will register in the compartments of the ruling prepared for it. Then make ready the forme and lift a sheet in, as near register as possible on to the tympan of the press—it is impossible to work headings properly at a cylinder machine. Then get some very long darning needles, the longer the better, and stick them firmly into the tympan so that they are flat to the paper. These needles, if stuck as you do pins for laying the sheets to, will guide the register, as they must be so placed as to hide lines of the ruling, both at the off side and bottom side of the tympan.

Centring the Lay of a Sheet.—In job work, when an impression is taken on the tympan, and the pressman wishes a sheet to be printed in the centre, he has only to place the right edge of his paper at the right end of the printed line on the tympan, and mark on the sheet at the left end of the same line, and fold the remainder into one half, marking the tympan at the left edge of the sheet to be printed.

Picks.—In working, picks, consisting of pieces of dirt choking up the face of any particular letter, must be guarded against. The best remedy is to have the forme thoroughly washed beforehand, and to distribute your ink well.

Prices of Press-work.—Pressmen are, as a rule, paid by the piecework system, but there are various scales of charges in vogue in the different offices in London, and no fixed scheme can be relied on. The principle is, however, that the work is calculated by means of tokens, which are represented by 250 pulls, and the price varies according to the size of the printed sheet and the nature of the work. The token is equivalent to an “hour;” this average being arrived at because it is a fair amount for two men to work within that space of time. If they can produce more, the standard of excellence not being departed from, it is of course to their advantage.

MOTIVE POWER.

CHAPTER XXIV.

Motive Power: Steam, Gas, and Water—Beam, Horizontal, and Vertical Steam Engines—Shafting, Riggers, Speed Pulleys, Brackets, &c., for Driving Purposes—Gas, Horizontal, and Vertical Engines—Water Motors.

BEFORE commencing the important section devoted to machine printing, *power* must first be considered. This power is derived from three sources, viz., steam, gas, and sometimes water. The first is the best for the driving of a large number of machines; for a few, gas is admirably adapted, even if two or three engines are laid down. Water-power is used in two ways, according to circumstances; in the country a passing stream can be utilized, and machinery driven by the water-wheel—a system applied to other factories at the water's edge. Another form of water-power is the Backus motor, but this is only available for very small requirements, as the pressure of water in town supplied by the different companies is not equal to any great demand.

Steam engines.—These are of several varieties. Their choice depends largely on the number of machines to be driven; the nature of these also must be considered, as some machines require more driving power than others of an equal size. Before placing an engine a perfectly sound foundation must be secured for it; therefore it is best to

have it in the basement, to obviate any vibration in driving. The boiler (Cornish ones are more usually adopted) should be situated as near as possible to it, because steam does not lose so much force in passing from the boiler to the engine if there is only a short distance to travel. The different engines may be classified as follows: (a) beam, (b) horizontal, (c) vertical, (d) table, (e) combined vertical engine and boiler.

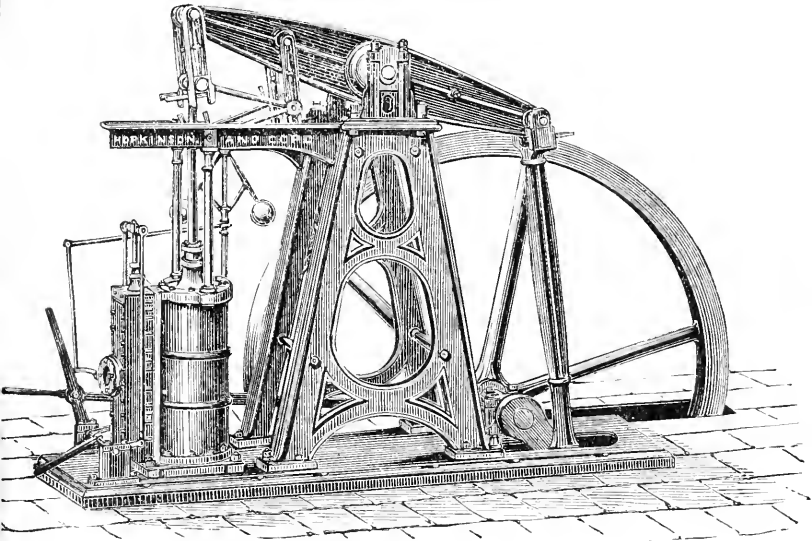

Fig. 121.

The *beam engine*, fig. 121, is preferable if a large number of machines have to be driven, and particularly if they are of different kinds. The difference in character of machine—cylindrical or platen impression—must be allowed for by counter-shafting, otherwise an equal power will not be maintained if driven from the main shaft. If you have machines of platen make, drive them from a

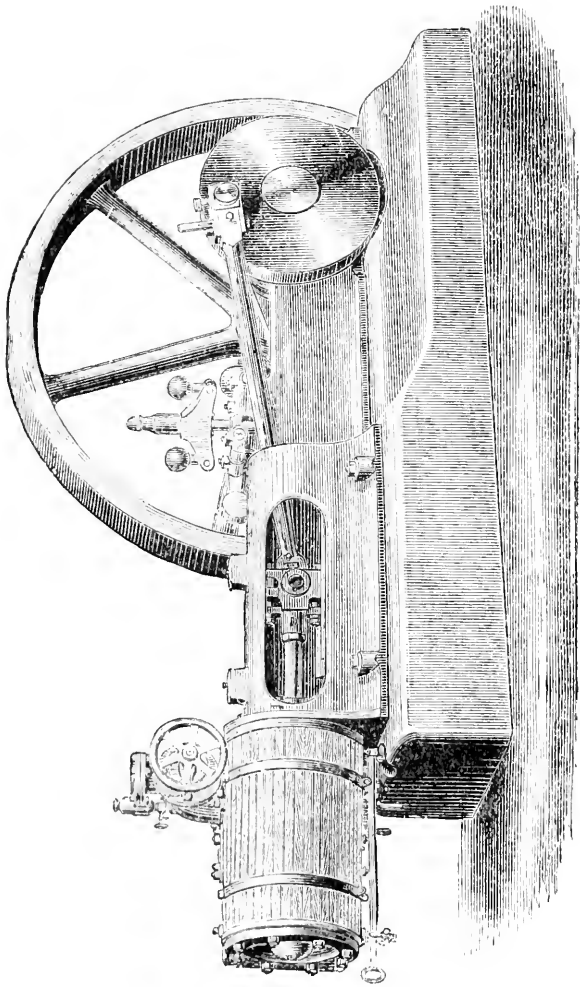

Fig. 122.

counter-shaft, that is, a small shaft connected with a band from the main. These engines consume a little more fuel, and are more expensive than the other kinds, but are recommended for steadiness in driving and for great power.

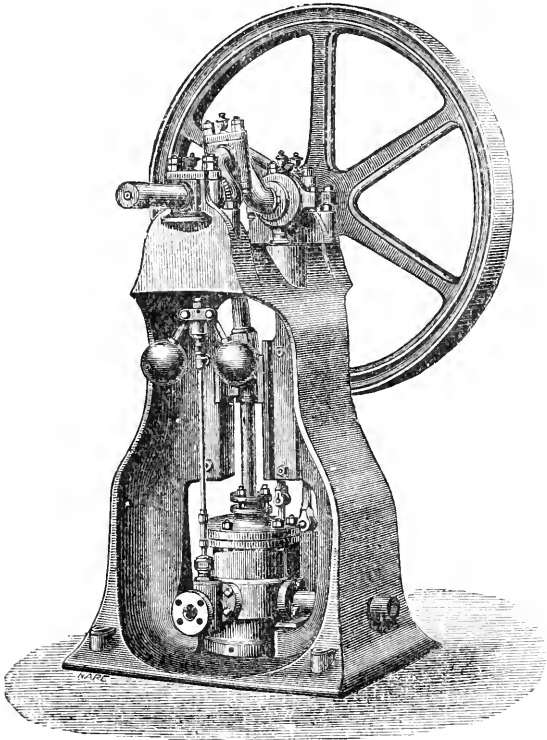

Fig. 123.

The *horizontal engine*, fig. 122, comes next; this is, perhaps, in more general use, as it occupies less room than the beam, and is sufficient for ordinary requirements. In very large offices, where a beam engine is used, a hori-

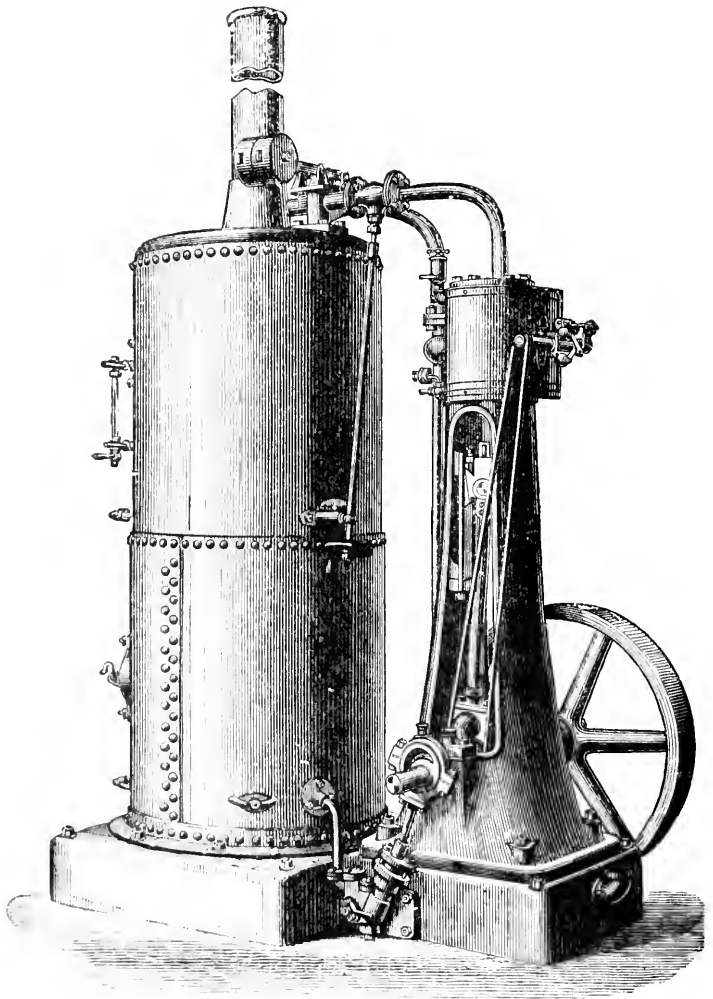

Fig. 124.

zontal engine is always a good reserve in case of a breakdown; it is necessary to have an additional boiler for the same purpose.

Another reason for placing these in the basement is because they can be farther apart from the machine-room, even if the basement is used for machinery, as the atmosphere of a boiler-room is not conducive to the comfort of the employés, the care of rollers, or other conditions affecting good work.

Two other varieties, the *vertical*, fig. 123, and the *combined engine and boiler*, fig. 124, are handy for smaller powers, and where only limited space is at command. The same remarks apply to the *table engine* for still smaller power and space.

In fixing on the position of the engine choose a dry situation; it is also important that the boiler should be examined occasionally, the flues and tubes being kept quite clear and clean. Governors and steam-gauges should be tested periodically to insure perfect safety. The incrustation which forms inside the boiler must be removed from time to time. There are many adjuncts for the purpose of economizing fuel; two important ones are, first, the covering of the boiler and steam-pipes with a coating of special composition which keeps the heat in and reduces the temperature of the boiler-house and engine-room very considerably, and the other an apparatus for the automatic pumping into the boiler of hot water instead of cold; this in itself is a great saving, as the existing quantity of steam in the boiler is not depreciated when a fresh supply is taken in.

Shafting, riggers, &c.—Before leaving the subject of steam we append a few illustrations, fig. 125, of the different parts used in connection with the driving power; these are:

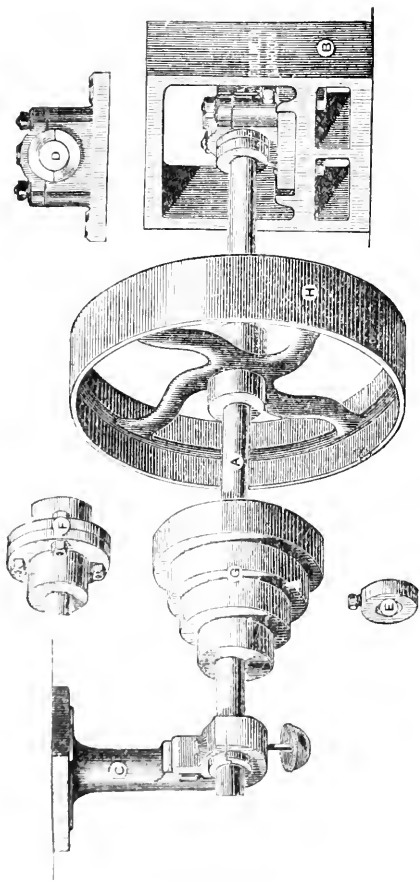

Fig. 125.

- (A) The shaft.
- (B) Wall-box.
- (C) Bracket, or hanger.
- (D) Bearing.

- (E) Collar.
- (F) Connection.
- (G) Speed pulleys.
- (H) Rigger.

Lubricators.—A good one is the *needle lubricator*, fig. 126 ; it can be easily attached, and requires little attention.

With these appliances and the aid of belting the necessary power can be imparted to the machinery. In driving by steam, good stoking is another important matter as regards the amount of fuel consumed. The care of a boiler is also a consideration, in minimizing the risk of explosion ; therefore it is requisite to appoint a reliable and practical man to look after these engines and boilers. Another point is the coal used ; smokeless Welsh is the best undoubtedly, as it burns better and the flues and tubes do not require so much attention.

Gas motors are in the market of various kinds—both horizontal and vertical and up to any power—estimated by “man” or “horse.” In laying down engines, either gas or steam, power should be in excess of what is actually required, so as to be amply provided. For small offices one horse-power beyond the normal quantity is advised, whilst for larger offices two, three, or even four horse-power in excess of actual requirement should be ordered. In the case of steam, the capabilities of boiler as regards the pressure of steam must be regulated according to the horse-power of the engine.

Of gas engines, the “Otto” is a serviceable one for driving the larger quantities of limited machinery—the horizontal, fig. 127, for greater, and the vertical, fig. 128, for smaller powers. These machines require very little attention, and are remarkably handy in being ready for immediate use. They can be started and stopped momentarily, and they can be placed in the machine-room without detriment. A good plan is to have them boxed in with

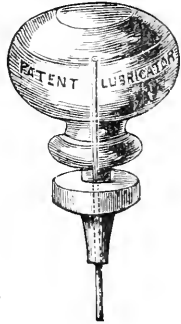

Fig. 126.

glass sides, which keeps them free from dirt and dust. The principle of these engines is: an admixture of gas and air in the cylinder is exploded by means of a small gas jet, this giving the necessary impetus to the fly-wheel. These engines should be kept scrupulously clean; therefore the covering in is suggested. The Otto is

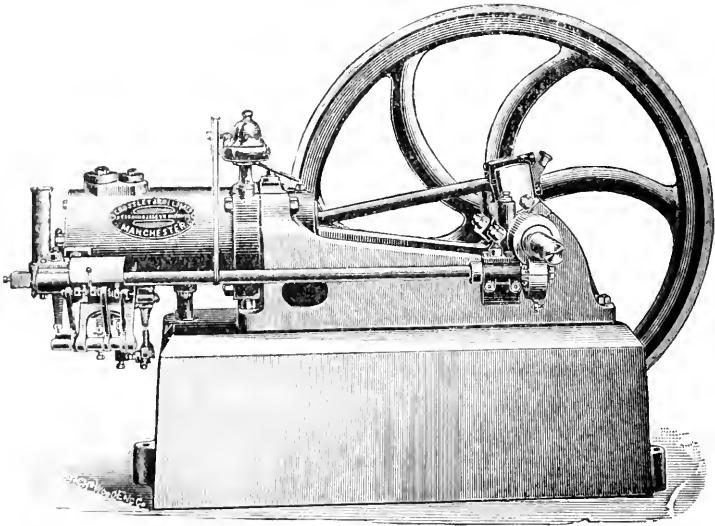

Fig. 127.

reckoned one of the safest and most reliable engines propelled by gas which have been offered to the trade.

The "Bisschop," fig. 129, is another form of gas engine, of French origin. It is only adapted for small power, and is of the vertical pattern. The principle of power emitted is much the same as that of the Otto, but no water is required. As these engines are inexpensive, the initial cost of laying one of them down is not so great. To

sum-up—the various advantages of gas engines, provided the requisite amount of power can be obtained, may be enumerated as follows: cheapness, adaptability for small

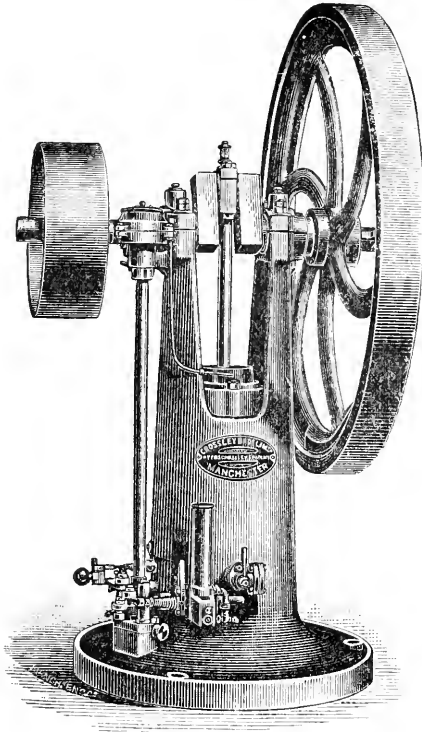

Fig. 128.

spaces, non-interference with existing machinery; also the little attention they require, their cleanliness, and last, but not least, the convenience of having power at command at a moment's notice.

With regard to the water motor above-mentioned, the "Backus" is the only system we can say anything about. The engine itself is cheaper than the gas one of equivalent

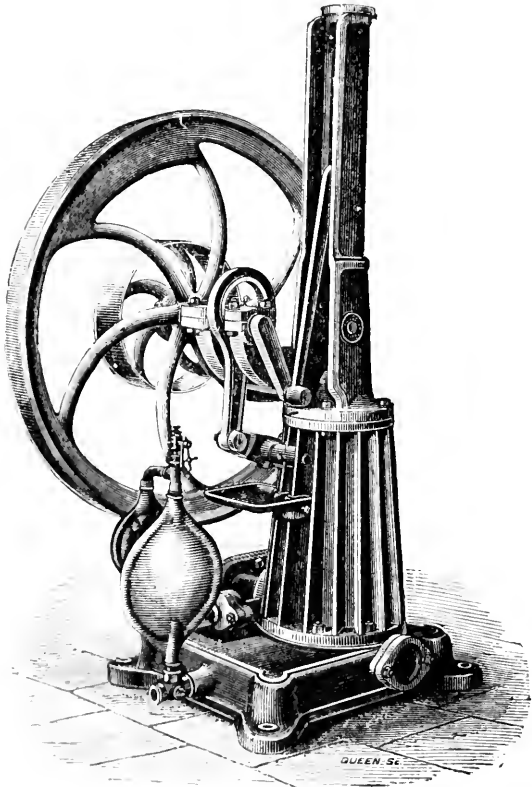

Fig. 129.

power, but the cost of driving is perhaps more. It is very simple in construction, and occupies a very small space indeed. A small jet of water is played on the plates

or tongues inside the hollow iron wheel, which are arranged round the spindle on which it revolves. As soon as the power is exerted by the action of the inlet pipe, it escapes at once through the outlet pipe at the back of the motor. The wheel itself acts as the fly-wheel to impart motion and power, which is communicated to the band by means of a very small rigger on the right-hand side. Owing to insufficient pressure from the water-mains the system cannot be applied to any great extent.

One great advantage attaching to the use of gas engines, and this too applies to the water motors, is that no extra rate of premium is charged for them by the fire insurance companies.

MACHINE PRINTING.

CHAPTER XXV.

Machine Printing—Methods of Impression, Platen and Cylindrical—Classification of Printing Machines—Some Hints on Laying-down Machines as regards Foundation and Light—Cleanliness and Lubrication—Systems of Making-ready by Hard and Soft Impression.

IN writing on this subject it must not be forgotten our mission was to describe more particularly those machines used in relation to book-work, but we propose to touch also on the appliances in use for jobbing or newspaper work.

Printing by mechanical means is now effected by two methods of impression, *i.e.*, flat or round—the former termed the platen, and the latter the cylindrical. The platen impression is akin to the hand-press, but owing to rapid improvement in the more true manufacture of the cylinders the system of flat impression is fast dying out, except in the case of hand-presses or the platen small jobbing machines.

Classification of machines.—The following list will suffice to give some idea of the various machines actually in use, and the class of work for which they are best suited :

PLATEN.

Jobbing machines, worked by foot or steam, in various small sizes, usually up to demy folio.

Single platen (called the Scandinavian) and *double platen* (rarely now used for book-work).

CYLINDER.

Single cylinder, or one-sided machines, adapted for good book-work of short numbers, illustrated or otherwise.

Double cylinders, or perfecting machines, for longer numbers of book-work, printed on both sides at one operation.

Rotary machines, used particularly for newspaper or magazine work, illustrated or otherwise, and made for printing from the web (or reel) of paper, or single sheets, on the two, four, or more, feeder principle.

Laying down machines.—An important matter to be considered is the light—artificial means of lighting should only be resorted to in extreme cases, both from an economical, and, what is still more material, from a healthful point of view. Good light means good work. Care must also be exercised that the foundations and surroundings are in keeping with the requirements of the machines. It is usual to have them erected either in the basement or ground floor. It is also advisable to have the larger kinds built over pits. This gives additional solidity to the machines, obviates vibration to a great extent, and gives easy access to the under parts when they need cleaning or repairing.

Ample room should be allowed for the purpose of getting round the machine to any working part, and all wheels or exposed dangerous portions should be fenced in. This latter is, in fact, a provision in the Factory Acts.

The first machine invented was of the cylindrical character, and was patented by William Nicholson, of London, as far back as 1790. It is really on this one that the sub-

sequent machines were based, and it was left to M. Koenig to further perfect this apparatus some twenty years later, when Mr. Walter of "The Times" took the idea up. Successive inventors improved on the cylindrical principle, and the results are the wonderful achievements by both book and newspaper machines. At the present time nearly all newspapers are printed from rotary machines—stereotype or electrotype plates being curved on other cylinders instead of being flat; the paper employed is generally from a web some miles long. As printed the sheets are cut by the machine, and in some instances folded. There is also a damping apparatus attached for the wetting of the paper, if necessary, before printing. By this process of printing, after the making-ready has been performed, the production of the printed sheet is purely automatic, save for the watchful care of the machine-minder. It is highly necessary that this person should be at once both a printer and of a mechanical turn of mind, considering the great responsibility involved in the charge of one of these valuable and intricate pieces of machinery.

Care of machines.—For the proper working of any machine there are two very essential points to be borne in mind—cleanliness and due attention to the lubrication of the working parts. On no account should dirt or grease be allowed to accumulate. In oiling the parts it is better to give a little and often than to give an excess. For the larger parts requiring lubrication perhaps tallow is the best, and oil for the smaller. By all means give both to the machine, but sparingly, on starting in the morning. If the holes get clogged a little paraffin should be applied, and the machine run for a short time—this will then have the effect of cleansing it; afterwards it can be oiled as usual. In choosing a lubricant, one must be selected which does not congeal, and which is of good quality; the higher-priced ones are generally the best. Next to efficient

making-ready the question of proper inking facilities is the most important. It is frequently the case that the ink-ducts are very imperfectly understood. If the keys are regulated as intended, good ink used, and the rollers in condition, the colour, when once set, should be equal and thorough in working. Some machine-minders still obstinately refuse to avail themselves of the mechanical means at their disposal for the proper and even taking of ink at each revolution of the machine, preferring often to feed the vibrating and other rollers; this practice should be highly deprecated. If the duct is in good working order, no excuse should be tolerated. The minder should be thoroughly conversant with all the details of the machine he is entrusted with, and should seek to improve his acquaintance with the several kinds which he may be called upon to take charge of. A knowledge of mechanics is a great qualification for him, although the construction of the different machines is much the same in principle in all of the cylindrical character.

It is customary for the makers of the various machines to erect them, and to give any instructions on this subject for the purpose would be irksome, considering the number of machines of different patterns in the market, some of them being of so very complicated a nature. Nevertheless, it is essential that the workmen who tend these machines should have some superficial idea of their construction, in order that they may know the cause of any possible defect in the working parts.

Making-ready.—Before giving any description of the various machines in use, it will be well to dwell a little on the styles of making-ready. The system of bringing-up by under- or over-laying is the same in principle as on the hand-presses, but, as the workman has to deal with a far larger and more complicated machine, there are rules and methods to be followed to compensate for the great diffe-

rence between the two modes of printing by hand and by more automatic means—these rules and methods differing again according to the nature of the machine used. The present fashion is largely to print with super-calendered paper (dry) by the hard-packing system; the old method of damping paper and printing with a soft impression is fast losing its hold on the younger generation of printers. In order to adopt the former kind your machine must be in good order and the type not very much worn—the less the better; if it is, hard-packing will not be of use in bringing up the type to a true level, and the old style of using the blanket or a rubber will have to be resorted to. Finally, it is highly important that whatever process be adopted, the forme should on no account be pulled or run through by power; the impression should be felt for by turning the machine by hand. Stereotype work especially is very likely to get seriously damaged by a first—and hard—impression.

CHAPTER XXVI.

Jobbing Work—Class of Platen Machine best adapted for Light and Heavy Work—Ink Distribution—Lay Marks and Gauge Pins—System of Making-ready on these Machines.

WE will now briefly take the jobbing work, assuming it is executed by small platen machines driven by treadle or steam, which are generally made in size up to demy folio, though larger are occasionally manufactured.

Taking the ordinary *Cropper*, or *Minerva*, fig. 130, for our example, as it is very largely used, it will be seen that the bed or coffin of the machine is in a fixed vertical position.

The type is locked-up in special chases, and secured by clamps, which can be readily fastened and unfastened. The platen in working is carried from the almost flat position in front of the operator by two arms, one on either side, and

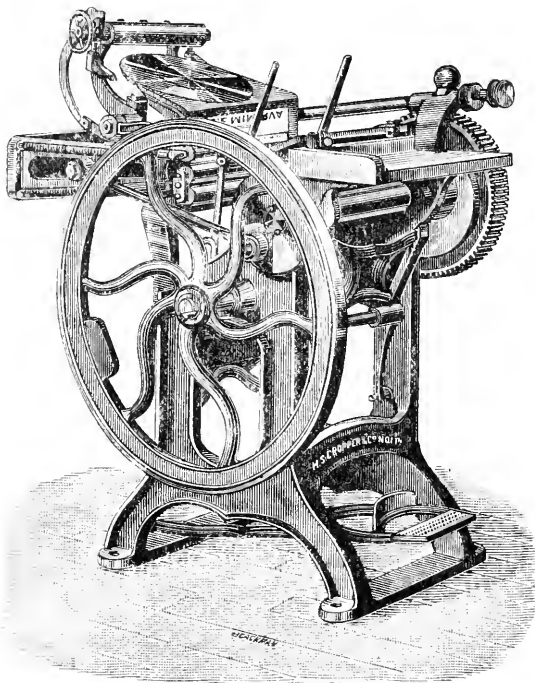

Fig. 130.

travels to the forme for each copy printed. It is necessary, of course, for the laying-on and taking-off, that this position should be as stated; after due practice the feeder can tread the machine and lay on and take off 1,000 copies at least

per hour, without fear of accident. The impression is regulated, in the more recent machines, by one screw only underneath the platen—this should be interfered with as little as possible. In the older makes of this machine, or indeed any other of the same kind, the impression was altered by means of five screws, one in each corner and another in the centre, but very great care was requisite in getting a perfectly level impression, otherwise the platen

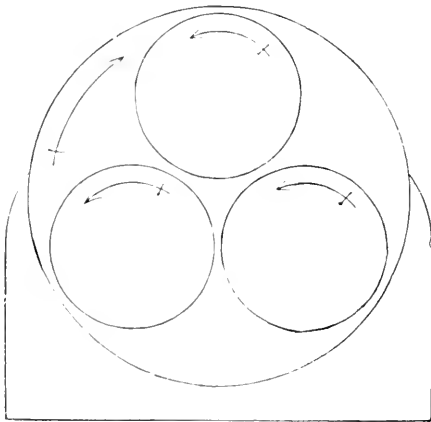

Fig. 131.

was thrown out of all truth. Therefore the modern plan is the preferable.

The inking arrangements are placed behind and above the bed holding the forme, and by an ink-duct, vibrator, and a *distributing disc*, fig. 131, which is made in the more recent machines, with three inner discs revolving in an opposite direction to the larger and outer disc, ample distributing power is obtained. As the platen falls back from each separate impression the rollers pass down over the forme and back again. The frame of the

machine is now cast in one piece, which gives increased strength and rigidity to the whole. These machines are usually worked by lads, who, with a little instruction and subsequent experience, can be entrusted to turn out a good deal of work, subject only to slight supervision. In making-ready, a thick sheet serves as the top one, and a few thin sheets—three or four—are all that is necessary for packing. The outer and thicker sheet is fastened by being turned in under the thin iron frame which fits lightly round the outer edge of the platen. When the

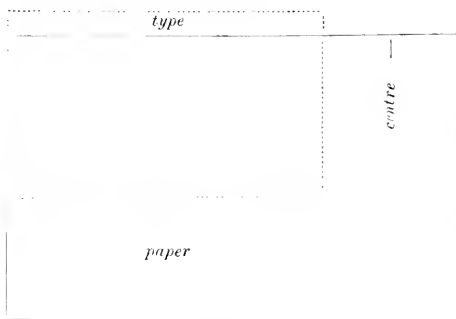

Fig. 132.

sheets are placed inside, and the impression turned over once by hand, the impression-screw can be adjusted as required in order to bring the forme within touch.

Then the making-ready can be proceeded with by cutting-out or patching-up a first, and subsequently a second sheet, if necessary. When this has been done, the lay should be made; if central, place one side of the sheet to the extreme edge of the print on the top sheet (a faint print, or even blank pull, is sufficient for the purpose). Then the surplus paper, fig. 132, with the other end of the sheet over and above the print, should be folded just in half; this gives the exact centre when marked on the top sheet with a pencil.

This rule is a ready one, and applies either to the side or bottom lay.

Lay marks.—Pieces of cork, fig. 133, or springs, fig. 134, made of glaze-board, are both used for laying to, but in long numbers they should be watched, as the paper or cards used for the job in hand are likely to cut or wear away that part



Fig. 133.

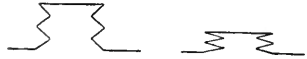

Fig. 134.

laid to. There are *gauge-pins*, fig. 135, to be obtained, of American origin. They are of metal, and consist of a long pin, which is forced through the top sheet. They have two teeth, which are pressed into the packing or making-ready to hold them in the correct position. To assist the sheet in coming away from the forme after printing, fingers or grippers are used; these can be adjusted to any distance on the paper, but it should be seen that they are screwed up



Fig. 135.

tightly and in the proper place, as otherwise they may be pulled across the face of the forme. It is best not to place them on till the forme has been brought-up and the lay obtained correctly.

In the case of a job being perfected or backed, the side-lay should be shifted to the opposite side in order to secure exact register; any variation in the size of card or paper would throw it out if laid to the same side. There

are different ways of laying-on and taking-off at the same time, but the operator should accustom himself to laying both sides with equal facility, and keep a very sharp look-out, or he may get his hand caught in the machine whilst in motion. The supply of ink can be regulated to a nicety. There is also a "throw-off" for the impression, used for running-up colour, or in the event of a "miss"

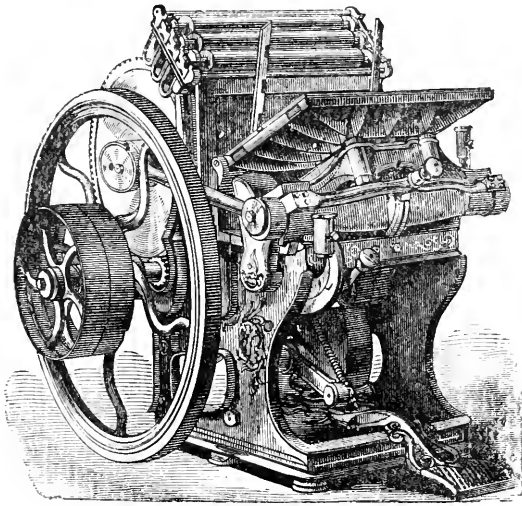

Fig. 136.

in laying-on. If a very open or broken forme is on the machine, a frisket can be made to prevent blacks, this being fastened to the fingers and cut away in the parts to be printed.

There are many other varieties of small platen machines ; among them are the Universal, Sun, Bremner, Gordon, Little Wonder, Hatton, Standard, Arab, Liberty, Empire, &c. In principle they are much the same, but they

vary in details, and the same remarks apply broadly to all, subject to the deviations necessitated by the make. Some of these machines are more substantial than others. Whilst the *Minerva* is admirably adapted for the lighter kind of jobbing work, the *Universal*, fig. 136, is perhaps the best for the heavier class.

CHAPTER XXVII.

The Larger Kind of Platen Machine, Single and Double—
Making-ready and Mode of Working.

THE larger kind of platen machines propelled by power formerly superseded hand-presses to a great extent. They were manufactured either single or double, and in various sizes.

To commence with the *single platen*, fig. 137, sometimes called the Scandinavian, or “Scan,” for shortness. As in the case of a hand-press, the tympan is usually made of parchment, and the frisket formed of brown paper cut out to the necessary shape.

The making-ready is carried out in a manner similar to that explained in the part devoted to press-work, and the operators lay-on and take-off respectively—the sheets as printed being placed at the side of the machine on a bank or table. The forme in this single platen machine does not travel, but is a fixture under the platen. When a fresh sheet is laid on and the tympan turned down, the sheet is carried along to a position immediately between the forme and platen, and then impressed by the descent of the platen. The inking arrangements are attached to the front part of the tympan, and pass and re-pass over the forme as the sheet goes in and out for its impression, the fresh

supply of ink being obtained from the table at the other end from the feeding. The crank action is applied in the working of this machine, and the carriage holding the forme can be easily withdrawn, if necessary, for correction. The rate of speed obtained is but little in excess of the hand-press.

Of the *double platen*, fig. 138, there are two kinds as regards working action, the crank and the knuckle-joint—the latter being the more speedy. The illustration we give is that of the crank movement. The double platen has

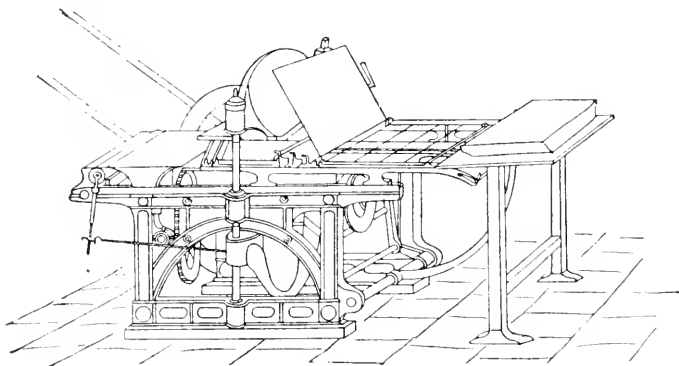

Fig. 137.

two ends, similar in all respects; these ends are available for distributing and inking purposes, as the formes travel backwards and forwards. Two formes are placed on the beds at either end, and, as each in turn arrives under the platen, it is impressed, and then returns to its former position to have the sheet removed and a fresh one laid on. A double set of operators are of course required at each end. The making-ready and other details in laying-on and taking-off are the same as in the single platen.

Machines on this principle are now being rapidly dis-

carded for those of the cylindrical character, but they are capable of turning out thoroughly good book-work. Their great drawbacks are their slowness of production and their inferiority in inking facilities as compared with the more modern make of cylinder machines.

The cylindrical mode was originally adopted for printing

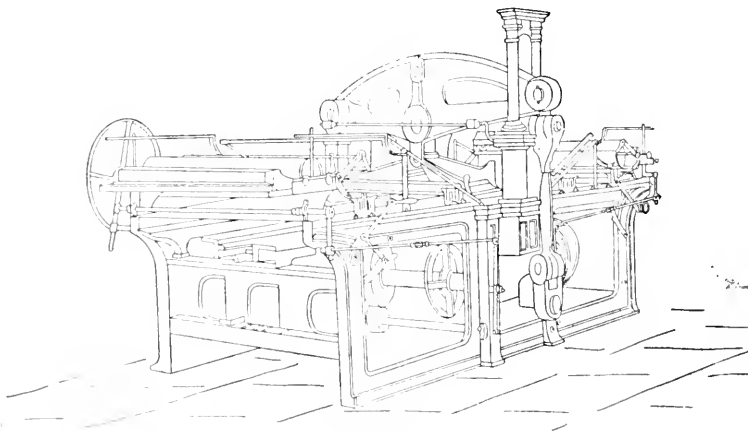

Fig. 138.

machinery, as was shown by Nicholson's invention in the latter part of the last century. It was eventually superseded by the flat impression of the platen, but in recent years the first plan has come to the front again. Owing to the very great improvement in the manufacture of the cylinder through accurate turning, or, in some instances, grinding, it will probably retain its position as the best method of impression in printing.

CHAPTER XXVIII.

One-sided Cylinder Machines : The Wharfedale a good kind—The System of Inking applied to Single-cylinder Machines—Description and Rate of Speed to be attained by the Wharfedale in Working—Making-ready—Finding the Pitch—Hard Packing—Slurring—Packing Rollers—Register—Supply of Ink—Altering the Impression.

FOR general book-work of the shorter numbers in printing, the *Wharfedale* machine, fig. 139, is the best and in most demand. It has a single cylinder, and consequently prints one side only at a time. Dawson's machine, we believe, is the original Wharfedale, but there are several other good machines of the same type in the market, varying little from the one here given (Payne's). They are made in all sizes ; their inking and distributing powers are a great feature, as likewise the accessibility to all parts of the machine, and the convenience of laying-on and taking-off. They are simple of construction and do not occupy much space. Very great improvements have been made in them from time to time, and by stopping cylinders and double rolling action every facility is given for turning out the different kinds of work which these machines are called upon to execute.

System of inking.—To illustrate the method of inking as applied to single cylinder machines, the diagram, fig. 140, will be of service.

Here are seen the distributing and inking rollers respectively, and the method of taking and giving ink to the forme : (D) is the ink-duct, a shallow trough containing the ink, which is let out by a long thin iron plate, termed the "knife." The quantity of ink to be given at each impression is regulated by screws or keys, turned by

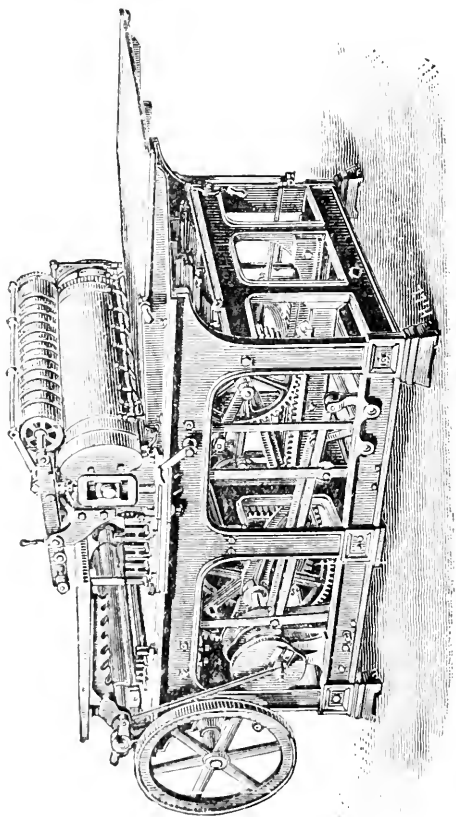

Fig. 139.

the aid of a tommy; if properly and consistently done in the first place, equality in colour will be obtained. The ink let out is deposited on the ink-cylinder, a metal roller within the duct, which revolves slightly at each turn of the machine, and from this cylinder the ink is lifted at intervals by the vibrating roller (v). This roller in its action places it on the ink-table (T), which travels with the forme coffin (F), being attached to it; (w)

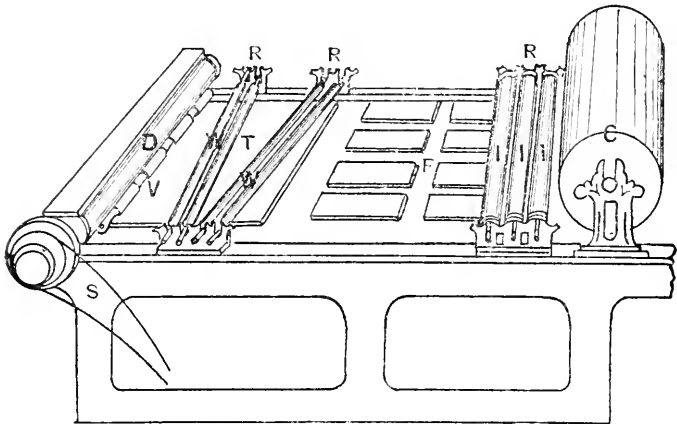

Fig. 140.

are the wavers, or distributing rollers, which manipulate the ink on the table, and as the forme passes and re-passes under the other rollers (r), called the inkers, it receives the necessary quantity of ink; (c) is the impression cylinder. As will be observed, the inkers receive the ink from the table after it has been distributed thereon by the wavers. The ink-cylinder within the duct is kept on the move, a part revolution at each impression, by a ratchet wheel in connection with the shaft of the machine (s), and the rollers

revolve on their spindles, which are held in forks (R), by the travelling of the ink-table and forme carriage.

In the Wharfedale machine that end of the machine occupied by the inking appliances and frame is covered up by the taking-off board, which is a great economy of space; consequently the working parts just enumerated are practically covered up when in action. When it is requisite to get at the rollers or to correct the forme this board is turned up on its end, immediately over the ink-duct, and an iron rack at either side is disclosed; this is for placing the rollers on, if it is necessary to lift them out for any reason. These machines will run off copies to the extent of 1,000 per hour if the speed is regulated by the special pulleys, but it is rather too high a number for good work, or that of a heavy nature; however, 750 or 800 is a safe number to attain.

The gripper arrangement is that used for feeding machines of the Wharfedale class.

Flyers may be used with great advantage, thus dispensing with some amount of unskilled labour, an item to be considered in large establishments. An automatic laying-on apparatus for these machines has been introduced lately, but as the system adopted is somewhat complicated and expensive, we cannot with any degree of certainty recommend them. No doubt they will be further perfected in course of time, and the cost reduced.

We take the Wharfedale as an example of a single cylinder, because we are convinced that this character of printing machine is the best suited for the general run of book-work. In addition to Dawson's and Payne's machines, there are Harrild's, Miller and Richard's, Furnival's, and others; all of which may be relied on for good and sound work. Some have advantages over others, but these are generally compensated for by other good points.

Wharfedales are made usually from double crown up-

wards; we have seen one of Messrs. Payne's which will print 60 × 48 inches, and yet be comparatively noiseless and smooth in running.

Compactness in build, and accessibility in feeding and taking-off are two things in favour of these machines. In proportion to the size of sheet which may be printed the Wharfedale probably occupies less standing-room than any other class of machine.

Making-ready.—Assuming the old method of the blanket (soft impression) is adopted, the machine-minder should proceed to put up the calico next the cylinder. This is fastened at one edge between two flat bars just inside the cylinder at the gripper side. The calico is then carried smoothly round the cylinder and fastened at the other end, and tightened by the ratchet wheel. The object of the calico is to form a basis or foundation for the impression sheets to be pasted on. Some six or eight sheets of thin paper should be placed next—the requirements of the particular machine will teach the exact number—and pasted down. See that these lie perfectly flat. The blanket may then be placed on. In choosing this do not take a thick one, but select a blanket of fine and even texture. The forme-carriage should then be brushed down, the forme placed on, and the correct “pitch” obtained, otherwise the sheet will not be gripped, or the forme may be battered in the first pull.

Finding the pitch.—The best plan is to daub a little ink on one end of the cylinder opposite the grippers, and turn the coffin under till this mark is transferred to the impression bearer. A gauge should then be cut for future use, and the formes of works of varying margins may be adjusted to the exact position at once without fear of accident.

After the forme has been placed on the coffin and fastened down a sheet may be pulled for register. At the same time

a proof should be taken for final revision by the reader, supposing the impression is pretty level; this obviates delay in starting. If the forme is not within touch, the impression screws at either end of the cylinder may be tightened. If too hard they may be loosened. The next step is to make register, and, if the work is to be pointed, the two points should be fastened to the forme at both ends for the first side in printing. In sheet work it is advisable to lay the inner one of the two formes on first. Of course these points are not used for the second forme, or, if half-sheet work, they should be lifted when the sheet is backed or perfected. When the pages are registered and the points for the second side adjusted on the laying-on board, an impression sheet may be pulled for making-ready or levelling the type.

It is usually more convenient to use a hand roller in performing these operations than to put any rollers on the machine. By adopting this method you will be enabled to make a good start with the proper rollers when all else is ready.

If there are any cuts in the forme to be printed, see that they are first underlaid so as to bring them up to a level just beyond type-height, for by doing this, much time in making-ready will be saved.

The necessary patching-up and cutting-out should be carried out in the same manner as detailed in the part of this work devoted to press-work. When the making-ready has been affixed to its proper position, additional touching-up can be done on the cylinder.

The revise being passed, the doctor should be seen to, and the requisite supply of ink regulated by the keys. The rollers placed in their respective places, colour may be run up, and a few waste sheets sent through the machine so as to distribute the colour evenly on the table and rollers before making an actual start.

Hard-packing system of making-ready.—This plan dis-

penses with the blanket, and few sheets only are necessary between the type and cylinder, with a stout hard sheet of paper or milled card—a glazed-board is an admirable substitute—placed next the cylinder. Unless the machine is in good order, and the type fairly new, this method is not advisable; but given these two points, the machine-minder may adopt it.

Illustrated work printed on super-calendered papers lends itself to this class of printing, and the cut-work in the magazines of the present day are all produced by this system.

To dress the cylinder for this method, a stout card or board should be first stretched over the cylinder, as the calico is in the other style of making-ready. Great care should be taken that it lies perfectly flat and close; to assist this the board may be scored right along on the top, a short distance from the edge, to allow of its turning more easily into the opening of the cylinder. When fixed, next place two or three sheets of thin paper, and, lastly, one of a stouter kind, which will serve as the top sheet. If the whole is not firmly fixed, slurring will probably result; therefore it is requisite that the board with the following sheets be lapped round very tightly. These details having been performed satisfactorily, the making-ready may proceed as usual.

As before said, if the machine is in fair condition, and the type new or little worn, not much time will be required in putting the finishing strokes to a forme preparatory to starting, provided the forme has been brought within touch by the proper number of sheets placed on the cylinder in the first place.

The object of printing by this method is to obtain a sharp, hard, and clean impression, without being heavy. If these points have been attained, cold-pressing of the sheets afterwards will not be needed. Two other essentials in

this system are that a good drying ink be used and the paper be perfectly smooth, that is, super-calendered. For the printing of illustrations a soft sized super-calendered paper is necessary.

Slurring in printing.—The possibility of slurring through inefficient packing of the cylinder, whether by the old or new styles of making-ready, has already been pointed out, but it is also sometimes caused by the natural wear and tear of the machine—the cylinder having become out of truth by constant running. If this is the case, the wooden cylinder bearers which run on either side of the coffin must be packed up with pieces of card. Tacking down these cards opposite the pages of type will relieve the edges of the pages considerably, and obviate the slurring.

Packing the rollers.—This is sometimes necessary to avoid the “wiping” of the roller on the extreme edges of the type, which causes an excess of ink on the part where the rollers pass over any opening between the pages of the forme. In order to get over this difficulty thick card, or even pieces of leather, may be used as packing; the length should be a little more than the opening to which they are placed opposite. Let the extreme edges be bevelled off so that the rollers will run over without jumping. The exact height will be determined by experience, but generally a sixth or an eighth of an inch in thickness is sufficient.

Register in printing.—This is attained either by pointing or by simply laying each sheet with very great care. For ordinary book-work the last method may be adopted if a very careful layer-on is engaged. To perform this correctly the second side in printing should be laid to the reverse end of the feeding-board; that is, the same edge of the paper must be laid to on the second side as in the first printed, but to another mark on the off-side of the machine. To do this it is sometimes best that the layer-on should go to the other

side of the machine, in order to secure greater accuracy in register. Colour work and other particular formes or closely-set pages should be printed with points, and registered on the second side by pointing, and not merely by laying to a mark at the reverse end.

Proper supply of ink.—Keep the ductor perfectly clean, and do not tamper unnecessarily with the keys. If allowed to become dirty the keys get clogged, and will not act properly. This causes an irregular supply of ink to be given out, and unevenness of colour in printing is the result. To assist the proper distribution, it is frequently necessary to cut the vibrating roller into sections; that is, certain pieces should be cut out at intervals to correspond with the openings between the pages. These excised pieces should be a trifle wider than the type openings. By this method the possibility of an excess of ink to those parts is reduced. In cutting the roller use the knife in a slanting manner, and do not go too deep, or else the suction or lug of the ink-table will pull the remaining composition off the stock.

Altering the impression of the cylinder.—This should not be interfered with more than can be helped, as the cylinder is likely to be thrown out. Formes of various kinds and of a broken nature require different impressions, and sometimes more than can be compensated for by altering the number of sheets on the cylinder. Where it is actually necessary to alter the impression screws of the cylinder do so consistently and evenly at both ends—if done carelessly it will be difficult to make correct again, and will perhaps injure the machine.

In laying on a fresh work select a solid forme for the first working; this will set the machine properly, and the subsequent formes will not be so much trouble in making-ready.

It will be obvious that the machine-minder's duties are

of a responsible nature, when we consider the value of the machine of which he is in charge. It is his business by forethought to keep the machine running as much as possible. For instance, whilst making-ready let him see that his final revise is passed, and that his boys are occupied in their spare time in cleaning up the machine. The necessary lubrication should now be applied, and the rollers got into condition and position for working. Care should be taken that the coffin and forme are quite clear, and that nothing has been left lying about which might injure the machine in running under the cylinder.

Everything should have a place, so that it may be found when wanted, and each machine should be separately furnished with tools, in the shape of mallet, shooting stick, and hammer, besides the usual accessories, viz., spanners, tommies, &c.

The machine-minder will find information in Chapter XVIII. respecting the care and treatment of rollers, which will be of assistance to him at all times and seasons.

In giving these directions we have generally spoken of the Wharfedale class of machine, but they apply more or less to others of the single cylinder character.

CHAPTER XXIX.

Perfecting Machines: The Web, Drop-bar, and Gripper Varieties—Set-off—Making-ready—Speeds of Perfecting Machines.

PERFECTING machines are those which print both sides of the sheet at one operation, and are specially adapted for book-work of long numbers. As the sheet is fed in, fig. 141, it is carried round one of the large cylinders (E) on to the small register drums placed over and between the two larger cylinders. By this means the sheet is presented on its reversed side to the second large cylinder (E), and receives the backing or perfecting impression. Thence it is discharged on to the taking-off board (D), situated below and between the two impression cylinders. The exact course of the sheet may be likened to a serpentine track, in order that the unprinted side of the sheet should be printed in turn.

The sectional drawings given of the different machines shown in this and the next chapter will exhibit the working of each. These reference marks are necessary for the proper understanding of the parts, and apply to all :

P Paper.	E Impression cylinders.
L Laying-on board.	C Cutting rollers.
w Damping apparatus.	F Flyers.
T Type cylinders.	D Delivery board.
I Inking apparatus.	

The different varieties of actions used for perfecting machines are of three characters, and may be defined as follows :

The Web.—Each sheet is laid separately to back marks

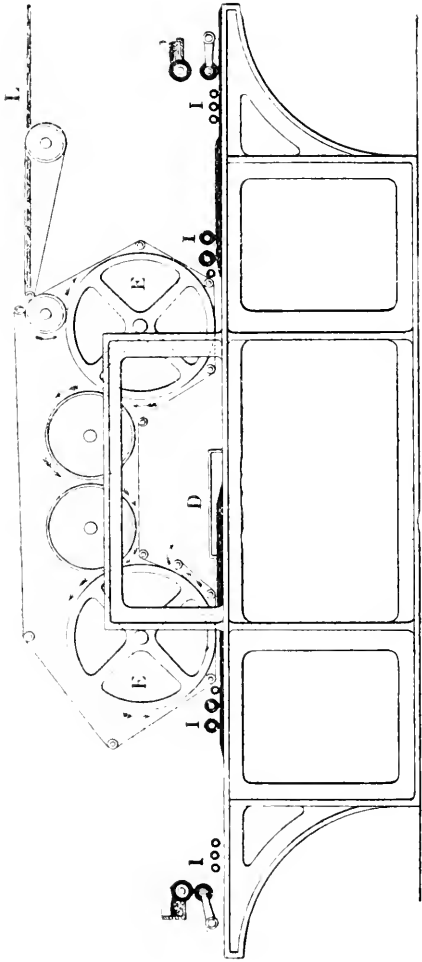

Fig. 141.

on to a series of tapes, and is carried forward. This class of machine is consequently slower in production, owing to the time engaged in lifting and carrying each sheet from the heap to the impression cylinder.

The Drop-bar.—In this machine the heap of paper is brought nearer, and the sheets are simply stroked up to certain marks. They are then seized by the bar, which rises slightly, and conveyed to the impression cylinder.

The Gripper.—This method allows of the sheets being taken by a series of fingers called grippers, after having been stroked forward from the adjacent heap up to the front marks. These two last characters of feeding are now generally adopted, but perhaps the gripper arrangement is more satisfactory in obtaining a correct lay, a greater speed being also attained.

These machines have a series of complicated tapes necessary to carry the sheet in the course of its travel from the feeding to the taking-off board, which with a little trouble may be readily understood.

Set-off on these machines is a difficulty to be guarded against. We should have said that usually the inner forme is printed on the first impression cylinder (E) nearest the feeding board (L), and the outer is printed on the other large cylinder just before discharging the sheet on to the delivery board (D). To avoid set-off long strips of paper, a trifle wider than the pages, and as many strips as there are rows of pages, are pasted so as to form endless bands, which are placed round the outer cylinder and a small drum. These keep on the move with the action of the machine, and all off-set is deposited on them. If these set-off bands are made of oiled paper they will last for some time without renewing—that is, for some few reams.

Making-ready on these machines is performed in a similar manner to that described for the single cylinder, but the parts are not so accessible, and when running they require

closer attention, owing to the number of tapes employed and the liability to set-off.

The speed of these machines varies from 1,000 upwards, but there are some in the market, of the gripper kind, that profess to turn out as many as 2,000 copies per hour perfect.

A perfecting machine has been made lately with one large impression cylinder only. One side having been printed, by a clever arrangement the sheet is reversed, and then the second side is printed on the return of the forme carriage.

Having treated of the two kinds of machines mostly in use for book-work, *i.e.*, single cylinders for short numbers and double cylinders for the class of work of longer numbers, we now propose just to touch on a few of the rotary machines in use at the present day, so that the student may form some conception as to the methods adopted. The reference letters already given in this chapter will be required for the different working portions of the several machines.

CHAPTER XXX.

Rotary Machines: The Victory—The Marinoni—The Whitefriars—Hoe's Six-Cylinder—Their Working Parts, Capabilities, and Speeds.

ROTARY machines are of various characters, and, as will be seen at a glance, very different in construction. These machines print, as a rule, from the web, or endless, paper, but some may be used with separate sheets. We have selected a few examples to enable the student to grasp the main principles. Printing surfaces either of stereotype or electrotype plates are curved to the requirements of the cylinders of the particular machine on which they are used. Frequently they have a special stereotyping plant issued with them, the size of the cylinder necessitating a certain curve in casting the plates.

These machines are adapted for periodical or newspaper work owing to the great output of which they are capable. Some are wonderful specimens of mechanical contrivance, the whole of the operations—wetting, feeding, printing (both sides), cutting, and folding—being purely automatic. With such appliances the newspaper of the present day is produced, and they have had the effect of expediting and multiplying to an unlimited extent the number of copies issued, and been the means of cheapening the cost to the public.

The person in charge of one of these machines must necessarily be a thoroughly practical man, and one who has had a wide experience in the trade. Such a workman is sought after and commands a high wage, generally more than in any other branch of the trade.

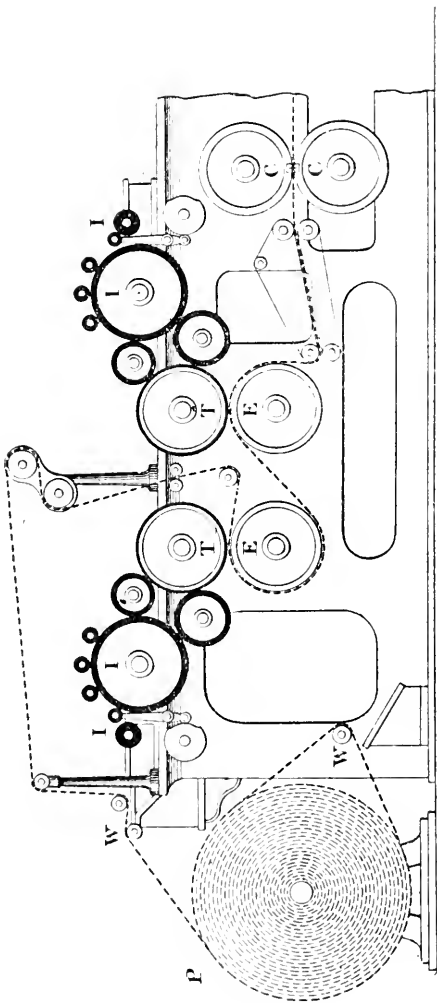

Fig. 142.

THE VICTORY.

The *Victory* rotary, fig. 142, is a web printing machine that has received very considerable patronage. It is particularly noted for its folding apparatus, and is one of the most complete machines in the market. It has a good damping appliance, and the papers are printed, cut, delivered, and folded, it is said, at the rate of twelve thousand per hour.

The type (T) and impression (E) cylinders are arranged in the centre of the machine, the printing surfaces being placed on the top. The working is as follows: The paper (P) after being damped is conducted to the first impression cylinder (E) over small rollers, which act as "smoothers," when it is printed on the first side. It then passes to the second impression cylinder, and is printed on the reverse side. Thus perfected, it is carried along to the cutting cylinders (C), and thence conveyed to the folding apparatus, which is in duplicate, and receives the papers as cut alternately, depositing them in the boxes at the other end of the machine, not shown on the plan given.

The wetting apparatus (W), usually worked by fine jets of water, which are emitted from a series of pin-holes in a pipe, is to the right of the reel of paper, and the inking cylinders (I), with their respective vibrating and inking rollers, will be observed on the top of the machine at either end, the ink-cylinders acting as distributing surfaces.

The dotted lines give the exact progress of the paper in all the diagrams.

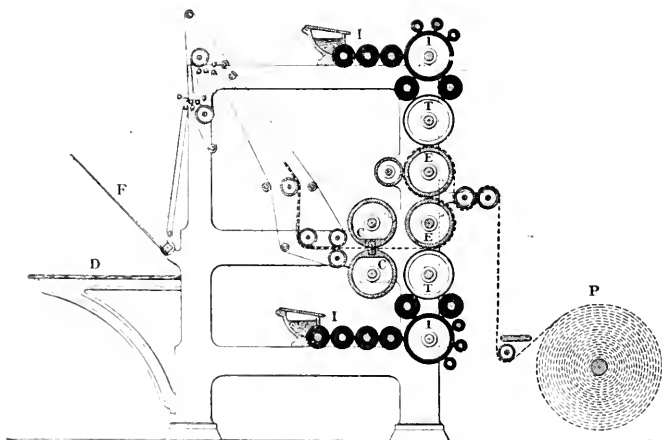

Fig. 143.

THE MARINONI.

The *Marinoni* rotary machine, fig. 143, as will be seen, has four cylinders arranged in a perpendicular manner. The two middle ones (E) are those which give the impression, and the other two (T), on top and bottom, are those on which the curved plates are fastened. At the extreme ends of these cylinders are the inking appliances (I); the distributors here have a lateral movement, through a cam action. As they are printed the sheets are collected and pass through the cutting drums (C), situated at the left centre of the other cylinders. When five sheets have been cut, they are carried along and deposited on the delivery board (D).

This machine will print at the rate of ten thousand perfect copies per hour, and is largely used for printing newspapers.

Sometimes a folding apparatus is attached, necessitating an alteration in delivering the sheets.

This machine also has a damping apparatus, and the paper travels between smoothing drums before it passes to the first type cylinder.

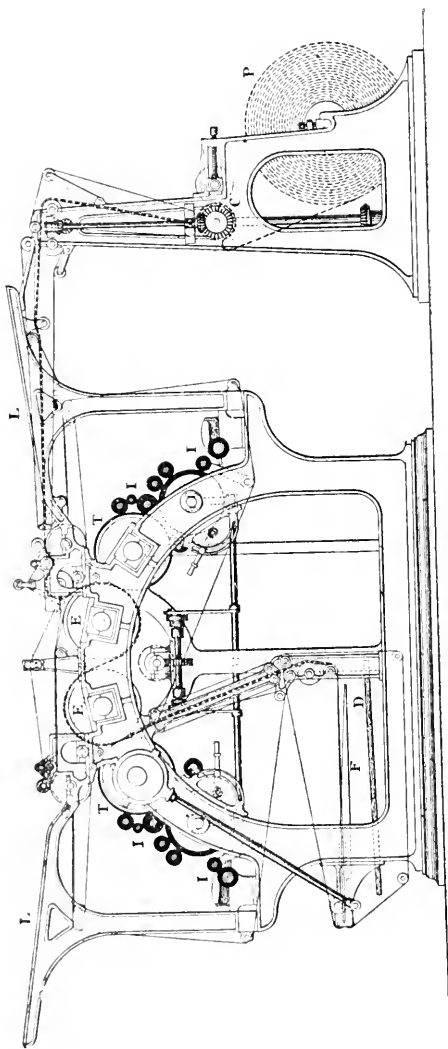

Fig. 144.

THE WHITEFRIARS.

The *Whitefriars* rotary machine, fig. 144, invented by Messrs. Pardoe and Davis, is adapted for newspaper or magazine work, plain or illustrated, and its speed as a two-feeder is from four to five thousand perfect copies per hour. It prints either from the reel or single sheets, and is rapidly coming to the front, owing to the various improvements made in it from time to time. The rate of production is greatly enhanced if the reel arrangement be used. The alteration in method of printing from sheet to reel, or *vice versâ*, is a very simple matter, the portion to the right hand being dispensed with in the latter case.

It has four cylinders arranged round an arched frame marked (T) and (E) respectively. When used for single sheets, the feeding boards (L) are placed on the top of the machine at each end. The inking apparatus (I) is placed at the extreme ends of the arch. The sheets after being impressed on both sides are carried to the flyers (F), and then laid smoothly on the delivery board (D) underneath and in the middle of the machine.

The diagram given is that of the two-feeder for single sheets, with the reel arrangement, when used, attached as at the right-hand side of the illustration. A folding apparatus is used occasionally, which is situated at the other end of the machine. The cutting rollers (C), when used for web printing, are placed just above the delivery board (D).

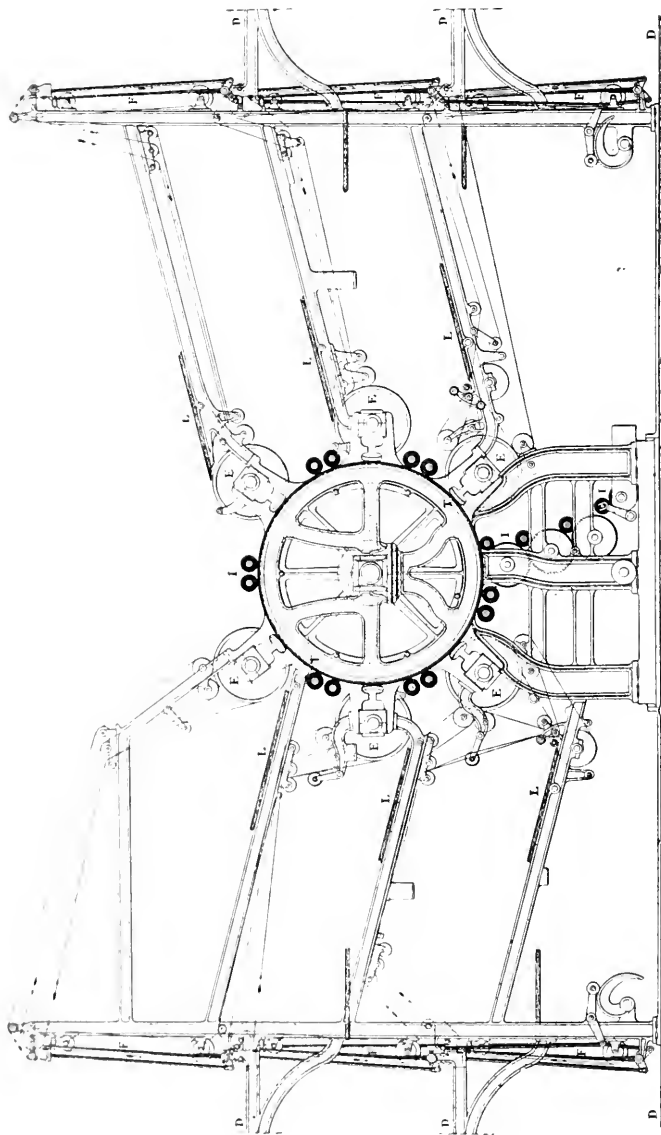

Fig. 145.

HOE'S SIX-CYLINDER.

This machine, a six-feeder, fig. 145, though somewhat out of date, and superseded by the web machine of rotary make, which prints from stereo or electro plates, by the same firm, will illustrate the system used in the type-rotary machine. The segments of type were fastened to the single large cylinder (T) placed in the centre, by means of column rules and screws. This cylinder revolved, and the type was inked by the rollers (I), which were fed from one large ductor placed underneath the type cylinder. The sheets were laid from six different positions (L), each having its own impression cylinder (E), and automatically delivered by the flyers (F) to the six different delivery boards (D), situated at the two outer sides of the machine.

This machine, we believe, was adopted in this country by the "Times" newspaper, but the complications were many, and the manual labour in feeding alone was heavy.

WAREHOUSE WORK.

CHAPTER XXXI.

The Warehouse Department—Varieties of Machine and Hand-made Papers—Number of Sheets comprised in a Ream—Tables of Sizes, Equivalent and Relative Weights, &c.—Cards—Qualities and Sizes of the same.

THIS department is devoted to paper—printed and unprinted; the latter being known technically as “white” paper, irrespective of its colour. The head warehouseman is a responsible person, and much depends on the warehouse department of a printing-office, if it is a large establishment, in the proper care and account of stock. Every sheet and ream of paper should be accounted for from the time it enters the warehouse till it leaves the charge of the warehouseman printed and finished for the bookbinder. He should have a thorough knowledge of papers of various kinds, both as regards quality and size.

Papers may be classed at once as either hand-made or machine-made. These are both further subdivided into drawing, writing, and printing papers, and of two characters, “wove” and “laid.” Hand-mades are usually identified at sight by the rough or deckle edge of the paper, and machine-paper generally from the fact that the edges are cut and straight. But as antique machine papers are now made with one or two raw edges, it is somewhat difficult for the inexperienced to identify them. Hand-made papers can be

often told from those made by machine by the circumstance that they are darker in tone on the right side, and the latter darker on the wrong side. The right and wrong sides of paper can be easily detected by comparison, the rougher of course being the wrong one. To discriminate between laid and wove papers—hold up a sheet to the light, when it will be seen that the former exhibit wire marks, which are absent in the latter. This is a rough and ready rule, and correct in general practice. Drawing and writing papers are principally made of rags (the amount of the same regulating the quality of the paper), with a considerable addition of size to permit of the article being used for the purpose indicated. Printing papers, except the better qualities, contain little or no rag, and are made from other substances, chiefly esparto, both sized and unsized. The unsized papers can be detected by wetting the corner with the tongue, when the moisture will spread as in a piece of blotting paper. The more a paper is sized the harder it is. There are two methods of sizing adopted, viz., tub and engine sizing; the former is generally used for hand-made and the latter for machine-made papers. The principal properties of papers are that they should be strong, though not harsh, and that they should be as opaque as possible.

A ream of paper of the printing class usually consists of 516 sheets = $21\frac{1}{2}$ quires of 24 sheets in each—termed “perfect” or “printers’” reams—this plus of 16 sheets being allowed for spoilages and over copies for every 500 sheets. Hand-made papers, whether drawing, writing, or printing, are as a rule made up to 20 quires of 24 sheets = 480 sheets, but sometimes this varies, and reams are 472 or 500; in these cases they are styled “imperfect” reams. “Mill” reams are 472 sheets, and “inside” reams generally 480 sheets. There are different ways of packing—a ream may be either “flat,” “folded,” or “lapped.”

The meaning of the first is obvious; the second is when a certain number of sheets is simply folded in half (or "quired"), and the third when the two ends are doubled over without being absolutely folded, thus forming a parcel lapped in three—this is only done with the larger sizes of paper. "Bundles" of paper are two reams done up in one, and a "parcel" is a term applied to a whole make when an order is given for a certain quantity. "Retree" is indicated by $\times \times$ (two crosses), "outsides" or "broken" by $\times \times \times$ (three crosses), which imply that the papers are respectively of second and inferior quality, the last being perhaps torn or broken in the "make"—as the manufacture is technically termed. Paper as a rule is made to standard sizes, some varying with the different makers; the list now appended shows the average sizes of most printing papers in use:

SIZES OF PRINTING PAPERS.

	Inches.		Inches.
Pott	$15\frac{1}{2} \times 12\frac{1}{2}$	Double Crown	30×20
Foolscap . . .	$17 \times 13\frac{1}{2}$	Imperial . . .	30×22
Post	20×16	Double Post . .	32×20
Demy	$22\frac{1}{2} \times 17\frac{1}{2}$	Columbia . . .	$34\frac{1}{2} \times 23\frac{1}{2}$
Medium	24×19	Double Demy . .	$35 \times 22\frac{1}{2}$
Royal	25×20	Atlas	36×26
Double Pott . .	$25 \times 15\frac{1}{2}$	Double Medium	38×24
Double Foolscap	27×17	Double Royal . .	40×25
Super Royal . .	$27\frac{1}{2} \times 20\frac{1}{2}$	Double Imperial	44×30

In addition to these papers, others are made in double and quadruple size. The following table exhibits at a glance the equivalent weights of papers in certain sizes:

EQUIVALENT WEIGHTS OF PAPERS.

Demy.	Double Foolscap.	Royal.	Double Crown.	Imperial.	Columbia.	Atlas.
lbs.	lbs.	lbs.	lbs.	lbs.	lbs.	lbs.
12	14	15	18	20	25 $\frac{1}{2}$	28 $\frac{1}{2}$
14	16	17 $\frac{1}{2}$	21	23	29 $\frac{1}{2}$	33
16	18 $\frac{1}{2}$	20	24	26 $\frac{1}{2}$	34	38
18	20 $\frac{1}{2}$	22 $\frac{1}{2}$	27	29 $\frac{1}{2}$	38	42 $\frac{1}{2}$
20	23	25	30	33	42 $\frac{1}{2}$	47 $\frac{1}{2}$
24	27 $\frac{1}{2}$	30	36	39 $\frac{1}{2}$	51	57
28	32	35	42	46	59 $\frac{1}{2}$	66 $\frac{1}{2}$
32	36 $\frac{1}{2}$	40	48 $\frac{1}{2}$	53	68	76
36	41	45	54	59 $\frac{1}{2}$	76 $\frac{1}{2}$	85 $\frac{1}{2}$
40	46	50	60	66	85	95
45	52	50	67 $\frac{1}{2}$	74	95 $\frac{1}{2}$	106
50	57 $\frac{1}{2}$	62 $\frac{1}{2}$	75	82 $\frac{1}{2}$	106	118 $\frac{1}{2}$

For instance, 12 lb. demy is the same thickness in handling as 14 lb. double foolscap, or 15 lb. royal, and so on.

Paper is also made in endless reels or webs, some miles in length, for the requirements, principally, of newspaper work printed on rotary machines. As will be seen from the foregoing table, papers are made to definite weights—a given number of pounds avoirdupois to the ream, whether it contains 472, 480, 500, or 516 sheets. Machine-made papers can be adjusted to a nicety as regards weight in manufacture, but hand-mades vary somewhat, and are frequently charged by poundage instead of by the ream. The scheme on the next page gives the equivalent weights of reams of 480, 500, and 516 sheets. To find the equivalents of other weights not given there see p. 256.

RELATIVE WEIGHTS OF A REAM CONTAINING 480, 500, OR
516 SHEETS.

Ream of 480 Sheets.	Ream of 500 Sheets.	Ream of 516 Sheets.	Ream of 480 Sheets.	Ream of 500 Sheets.	Ream of 516 Sheets.
lb.	lb. oz.	lb. oz.	lb.	lb. oz.	lb. oz.
7	7 4	7 8	39	40 10	41 15
8	8 5	8 9	40	41 10	43 0
9	9 6	9 10	41	42 11	44 1
10	10 6	10 12	42	43 12	45 2
11	11 7	11 13	43	44 12	46 3
12	12 8	12 14	44	45 13	47 5
13	13 8	13 15	45	46 14	48 6
14	14 9	15 1	46	47 14	49 7
15	15 10	16 2	47	48 15	50 8
16	16 10	17 3	48	50 0	51 9
17	17 11	18 4	49	51 0	52 11
18	18 12	19 5	50	52 1	53 12
19	19 12	20 7	51	53 2	54 13
20	20 13	21 8	52	54 2	55 14
21	21 14	22 9	53	55 3	56 15
22	22 14	23 10	54	56 4	58 1
23	23 15	24 11	55	57 4	59 2
24	25 0	25 12	56	58 5	60 3
25	26 0	26 14	57	59 6	61 4
26	27 1	27 15	58	60 6	62 5
27	28 2	29 0	59	61 7	63 7
28	29 2	30 1	60	62 8	64 8
29	30 3	31 3	61	63 8	65 9
30	31 4	32 4	62	64 9	66 10
31	32 4	33 5	63	65 10	67 11
32	33 5	34 6	64	66 10	68 13
33	34 6	35 7	65	67 11	69 14
34	35 6	36 8	66	68 12	70 15
35	36 7	37 10	67	69 12	72 0
36	37 8	38 11	68	70 13	73 1
37	38 8	39 12	69	71 14	74 3
38	39 9	40 13	70	72 14	75 4

The annexed tables are all useful in connection with the warehouse department :

EQUIVALENT SIZES OF WRITING AND PRINTING PAPERS AND CARTRIDGES.

Description.	Writings.	Printings.	Cartridges.
Emperor	72 × 48
Antiquarian	53 × 31
Double Imperial	44 × 30	44 × 30
Double Elephant	40 × 26 $\frac{3}{4}$	40 × 26
Atlas	33 × 26	36 × 26
Colombier	34 $\frac{1}{2}$ × 23 $\frac{1}{2}$	34 $\frac{1}{2}$ × 23 $\frac{1}{2}$
Imperial	34 × 22	30 × 22	30 × 22
Elephant	28 × 23	30 × 23	28 × 23
Super Royal	27 × 19	27 $\frac{1}{2}$ × 20 $\frac{1}{2}$	27 $\frac{1}{2}$ × 19 $\frac{1}{2}$
Cartridge or Log	26 × 21
Royal	24 × 19	25 × 20	25 × 20
Medium	22 × 17 $\frac{1}{2}$	24 × 19
Demy	20 × 15 $\frac{1}{2}$	22 $\frac{1}{2}$ × 17 $\frac{1}{2}$	22 × 17 $\frac{1}{2}$
Music Demy	20 $\frac{3}{4}$ × 14 $\frac{3}{8}$
Large Post	21 × 16 $\frac{1}{2}$
Copy	20 × 16	20 × 16 $\frac{1}{4}$
Post	19 × 15 $\frac{1}{4}$	20 × 16
Foolscap	17 × 13 $\frac{1}{2}$	17 × 13 $\frac{1}{2}$
Pott	15 × 12 $\frac{1}{2}$	15 $\frac{1}{2}$ × 12 $\frac{1}{2}$
Sheet and Half Pott..	22 $\frac{1}{2}$ × 12 $\frac{1}{2}$
Sheet and Third Cap.	22 × 13 $\frac{1}{4}$
Sheet and Half Cap...	24 $\frac{1}{2}$ × 13 $\frac{1}{2}$
Sheet and Half Post..	23 $\frac{1}{2}$ × 19 $\frac{1}{2}$
Double Foolscap	26 $\frac{1}{2}$ × 16 $\frac{5}{8}$	27 × 17
Double Crown	30 × 20	30 × 20
Double Post	32 × 20
Double Demy	35 × 22 $\frac{1}{2}$	35 $\frac{1}{2}$ × 22 $\frac{1}{2}$

EQUIVALENT WEIGHTS PER REAM OF WRITING PAPER OF
VARIOUS SIZES.

Foolscap, 17 × 13½.		Pinched Post, 18½ × 14¾.		Post, 19 × 15¼.		Large Post, 21 × 16½.		Extra Large Post, 22½ × 17¾.		Royal, 24 × 19.		Super Royal, 27 × 19.		Imperial, 34 × 22.	
lb.	oz.	lb.	oz.	lb.	oz.	lb.	oz.	lb.	oz.	lb.	oz.	lb.	oz.	lb.	oz.
7	11	9	7	10	1	12	0	13	14	16	0	18	0	22	14
8	5	10	4	10	14	13	0	15	0	17	6	19	8	24	13
9	0	11	1	11	12	14	0	16	3	18	11	21	5	26	11
9	10	11	13	12	9	15	0	17	5	20	0	22	10	28	10
10	4	12	10	13	6	16	0	18	8	21	6	24	1	30	8
10	14	13	6	14	4	17	0	19	10	22	11	25	9	32	7
11	9	14	3	15	1	18	0	20	13	24	0	27	1	34	5
12	3	15	0	15	15	19	0	21	15	25	6	28	9	36	4
12	13	15	12	16	12	20	0	23	2	26	11	30	1	38	2
13	7	16	9	17	9	21	0	24	4	28	0	31	9	40	1
14	2	17	6	18	7	22	0	25	7	29	6	33	1	41	15
14	12	18	2	19	4	23	0	26	9	30	11	34	9	43	14
15	6	18	15	20	2	24	0	27	12	32	1	36	1	45	12
16	0	19	11	20	15	25	0	28	14	33	6	37	9	47	11
16	11	20	8	21	12	26	0	30	1	34	11	39	1	49	9
17	5	21	5	22	10	27	0	31	3	36	1	40	9	51	8
17	15	22	1	23	7	28	0	32	6	37	6	42	1	53	6
18	9	22	14	24	5	29	0	33	8	38	11	43	9	55	5
19	4	23	11	25	2	30	0	34	11	40	1	45	1	57	3
19	14	24	7	26	0	31	0	35	13	41	6	46	9	59	2
20	8	25	4	26	13	32	0	37	0	42	11	48	1	61	0
21	3	26	0	27	10	33	0	38	2	44	1	49	9	62	15
21	13	26	13	28	8	34	0	39	5	45	6	51	1	64	13
22	7	27	10	29	5	35	0	40	7	46	12	52	9	66	12
23	1	28	6	30	3	36	0	41	10	48	1	54	1	68	11
23	12	29	3	31	0	37	0	42	12	49	6	55	10	70	9
24	6	30	0	31	13	38	0	43	15	50	12	57	2	72	8
25	0	30	12	32	11	39	0	45	1	52	1	58	10	74	6
25	10	31	9	33	8	40	0	47	4	53	6	60	2	76	5

SIZES OF PRINTING PAPER, SUBDIVIDED.

	Broadside.	Folio.	4to.	8vo.	16mo.
Pott	$15\frac{1}{2} \times 12\frac{1}{2}$	$12\frac{1}{2} \times 7\frac{3}{4}$	$7\frac{3}{4} \times 6\frac{1}{4}$	$6\frac{1}{4} \times 4$	4×3
Foolscap	$17 \times 13\frac{1}{2}$	$13\frac{1}{2} \times 8\frac{1}{2}$	$8\frac{1}{2} \times 6\frac{3}{4}$	$6\frac{3}{4} \times 4\frac{1}{4}$	$4\frac{1}{4} \times 3\frac{1}{2}$
Post	20×16	16×10	10×8	8×5	5×4
Crown	20×15	15×10	$10 \times 7\frac{1}{2}$	$7\frac{1}{2} \times 5$	$5 \times 3\frac{3}{4}$
Demy	$22\frac{1}{2} \times 17\frac{1}{2}$	$17\frac{1}{2} \times 11\frac{1}{4}$	$11\frac{1}{4} \times 8\frac{3}{4}$	$8\frac{3}{4} \times 5\frac{1}{2}$	$5\frac{1}{2} \times 4\frac{1}{4}$
Medium	24×19	19×12	$12 \times 9\frac{1}{2}$	$9\frac{1}{2} \times 6$	$6 \times 4\frac{3}{4}$
Royal	25×20	$20 \times 12\frac{1}{2}$	$12\frac{1}{2} \times 10$	$10 \times 6\frac{1}{4}$	$6\frac{1}{4} \times 5$
Double Pott.....	$25 \times 15\frac{1}{2}$	$15\frac{1}{2} \times 12\frac{1}{2}$	$12\frac{1}{2} \times 7\frac{3}{4}$	$7\frac{3}{4} \times 6\frac{1}{4}$	$6\frac{1}{4} \times 4$
Double Foolscap	27×17	$17 \times 13\frac{1}{2}$	$13\frac{1}{2} \times 8\frac{1}{2}$	$8\frac{1}{2} \times 6\frac{3}{4}$	$6\frac{3}{4} \times 4\frac{1}{4}$
Super Royal ...	$27\frac{1}{2} \times 20\frac{1}{2}$	$20\frac{1}{2} \times 13\frac{3}{4}$	$13\frac{3}{4} \times 10\frac{1}{4}$	$10\frac{1}{4} \times 7$	7×5
Double Crown	30×20	20×15	15×10	$10 \times 7\frac{1}{2}$	$7\frac{1}{2} \times 5$
Imperial	30×22	22×15	15×11	$11 \times 7\frac{1}{2}$	$7\frac{1}{2} \times 5\frac{1}{2}$
Double Post ...	32×20	20×16	16×10	10×8	8×5

TABLE FOR GIVING-OUT PAPER.

Number of Copies.	Number of impressions on sheet.																	
	1		2		4			8			12			16				
	q.	s.	q.	s.	q.	s.	o.	q.	s.	o.	q.	s.	o.	q.	s.	o.		
50	2	2	1	1	0	13	2	0	7	6	0	5	10	0	4	14		
100	4	4	2	2	1	1	0	0	13	4	0	9	8	0	7	12		
150	6	6	3	3	1	14	2	0	19	2	0	13	6	0	10	10		
200	8	8	4	4	2	2	0	1	1	0	0	17	4	0	13	8		
250	10	10	5	5	2	15	2	1	8	6	0	21	2	0	16	6		
300	12	12	6	6	3	3	0	1	14	4	1	1	0	0	19	4		
400	16	16	8	8	4	4	0	2	2	0	1	10	8	1	1	0		
500	20	20	10	10	5	5	0	2	15	4	1	18	4	1	8	12		
750	31	6	15	15	7	20	2	3	22	2	2	15	6	1	23	2		
1000	41	16	20	20	10	10	0	5	5	0	3	12	8	2	15	8		
1500	62	12	31	6	15	15	0	7	20	4	5	5	0	3	22	4		
2000	83	8	41	16	20	20	0	10	10	0	6	23	4	5	5	0		
3000	125	0	62	12	31	6	0	15	15	0	10	10	0	7	20	8		
4000	166	16	83	8	41	16	0	20	20	0	13	22	8	10	10	0		
5000	208	8	104	4	52	2	0	26	1	0	17	9	4	13	1	8		

Note.—q means quires, s sheets, and o the overplus copies.

Other numbers may be obtained by multiplying any of the above quantities.

1000 - 1000 = 0
 2000 - 1000 = 1000

To find the equivalent weight of paper in another size.—Supposing the table of equivalent sizes is not handy, or does not include the required size, the rule is: Multiply the weight of the paper you have by the size (in square inches) of a sheet of the paper whose weight you require to know, and divide by the size (in square inches) of a sheet of the first-named paper.

Example: I have a 24 lb. demy paper: what will be the weight of a ream of the same paper in double crown size?

The size of a sheet of demy is $22\frac{1}{2} \times 17\frac{1}{2}$ inches, and that of a sheet of double crown is 30×20 inches. To ascertain the weight of the ream of double crown, multiply 24 lbs. by (30×20) and divide by $(22\frac{1}{2} \times 17\frac{1}{2})$, *i.e.*, 24×600 divided by $393\frac{3}{4}$ equals $36\frac{1}{2}$ lbs. *Ans.*

SIZES OF LETTER AND NOTE PAPERS.

	Inches.		Inches.
Medium 4to . . .	$10\frac{3}{4} \times 8\frac{3}{8}$	Post 16mo . . .	$4\frac{3}{8} \times 3\frac{5}{8}$
Medium 8vo . . .	$8\frac{3}{8} \times 5\frac{3}{8}$	Copy 4to . . .	$9\frac{5}{8} \times 7\frac{3}{4}$
Demy 4to . . .	$9\frac{3}{8} \times 7\frac{3}{8}$	Copy 8vo . . .	$7\frac{1}{4} \times 4\frac{5}{8}$
Demy 8vo . . .	$7\frac{1}{4} \times 4\frac{3}{4}$	Foolscap 4to . . .	$8 \times 6\frac{3}{8}$
Demy 16mo . . .	$4\frac{5}{8} \times 3\frac{5}{8}$	Albert . . .	$6 \times 3\frac{7}{8}$
Large Post 4to . . .	10×8	Queen . . .	$5\frac{3}{8} \times 3\frac{1}{2}$
Large Post 8vo . . .	8×5	Prince of Wales . . .	$4\frac{1}{2} \times 3$
Post 4to . . .	$9 \times 7\frac{3}{8}$	Foolscap . . .	$12\frac{3}{4} \times 8$
Post 8vo . . .	$7\frac{1}{8} \times 4\frac{1}{2}$		

SIZES OF BROWN PAPERS.

	Inches.		Inches.
Casing . . .	46×36	Imperial Cap . . .	29×22
Double Imperial . . .	44×29	Haven Cap . . .	26×21
Elephant . . .	34×24	Bag Cap . . .	$24 \times 19\frac{1}{2}$
Double Four Pound . . .	31×22	Kent Cap . . .	21×18

There is a multitude of papers of various kinds made for general consumption; a few of them are as follows—their names showing their use in most instances: browns, sugars, cartridges, railway buff, bank, loan, small hand, enamelled, duplex, and a great assortment of tinted papers in various colours and different weights, suitable for almost any purpose.

Cards, too, are within a warehouseman's duty. These are made in boards, mostly royal size, and cut to standard measurements. The average sizes are here given:

SIZES OF CARDS.

	Inches.
Large	$4\frac{1}{2} \times 3$
Carte de Visite	$4\frac{1}{8} \times 2\frac{1}{2}$
Small	$3\frac{1}{2} \times 2\frac{1}{2}$
Reduced Small	$3\frac{1}{2} \times 2\frac{1}{8}$
Extra Thirds	$3 \times 1\frac{7}{8}$
Thirds	$3 \times 1\frac{1}{2}$
Half Small	$2\frac{1}{2} \times 1\frac{3}{4}$
Town Size	3×2
Half Large	$3 \times 2\frac{1}{4}$
Double Small	$5 \times 3\frac{1}{2}$
Double Large	$6 \times 4\frac{1}{2}$
Quadruple Small	7×5
Quadruple Large	9×6

Cards are of various colours, qualities, and characters. They are of two kinds, *i.e.*, pulp and pasted. The last are regulated in thickness by the number of sheets pasted to form a board, and are known as "three sheet," "four sheet," &c., according to the number used. When stocked in the cut sizes these are mostly done up in packs of fifty-two (the odd two being for overs or spoilage). The cards in boards are generally reckoned by the gross. The annexed table

is useful for determining the number of cards of a given size to be obtained out of a royal board :

NUMBER OF CARDS CONTAINED IN A ROYAL BOARD.

Thirds	96	}	Double Small	25
Broad Thirds	80		Double Large	16
Small	50		Quad Small	12
Large	32		Quad Large	8

CHAPTER XXXII.

Machines and other Appliances used in connection with the Warehouse Department—The Hydraulic Press—The Nipping Press—Glazed Boards—Hot Pressing—Hot Rolling—Cold Rolling—Cutting Machines.

IN connection with the warehouse certain mechanical appliances are necessary. Presses for cold pressing—the power for which is generally obtained by hydraulic pressure; rolling machines both for hot or cold methods; and cutting machines for paper.

The *hydraulic press*, fig. 146, is made in various sizes, and the pressure is given by means of water, which is forced by pumping (either by hand or by steam) into a receptacle which contains the piston or ram. This ram is attached to the bed of the press, and the act of pumping gradually raises this bed from the bottom. As very great pressure is given, the sides of the press, as likewise its head, must be of great strength, and, as a matter of course, made of iron. When it is pumped up and the required pressure exerted, it is held by fastening a valve, and if the press is in good order the power is retained as long as required. By unscrewing the valve again and

turning a tap, thus releasing the water forced up, the pressure is relaxed. A power of 450 tons may be given and retained by an ordinary press with a 12-inch ram,

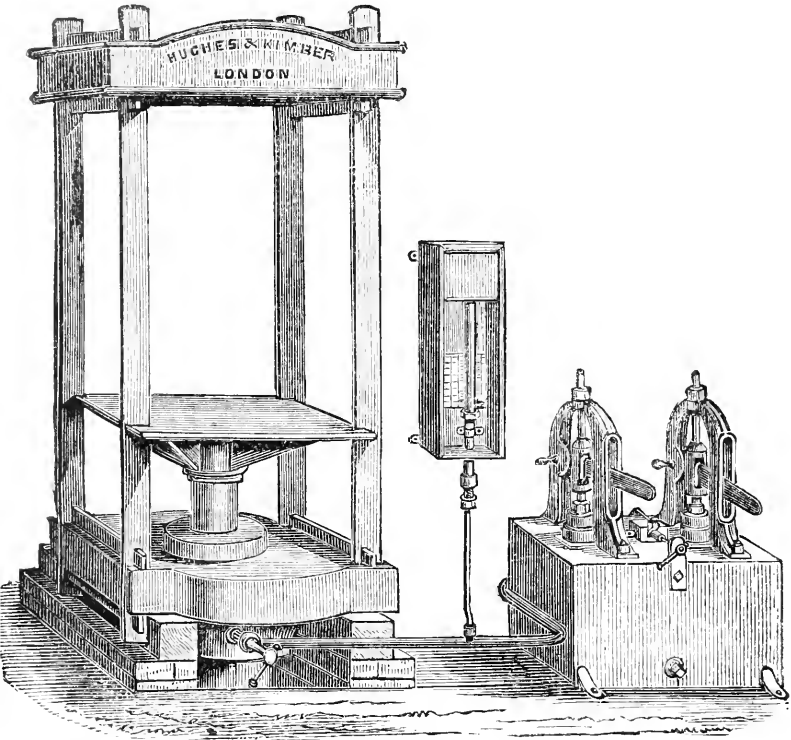

Fig. 146.

which will take, say, double demy. If the leather collar of the piston gets worn, it will cause a leak and the pressure gives. A dial indicating the tonnage is sometimes attached to these presses, and is a guide in pumping up. The example

given is one with double pumps attached, greater power being thus obtained.

A *nipping press*, fig. 147, made of iron, and worked by means of a screw, is a handy adjunct to the warehouse. It is very useful for jobbing work of a small character, which is required in a great hurry, when a nip will suffice.

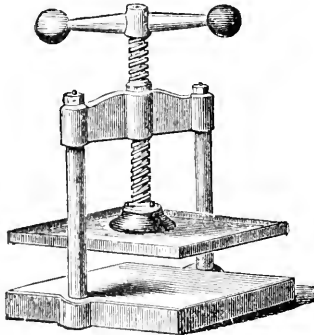

Fig. 147.

Glazed boards are used for pressing purposes. These boards are made mostly of rope and thoroughly well milled and rolled. The printed sheets are placed between them, and the impression is taken out and a slight glaze imparted from contact with the boards in pressing.

SIZES OF GLAZED BOARDS.

	Inches.		Inches.
Foolscap . . .	18 × 14½	Double Foolscap	28 × 18
Demy . . .	23½ × 18½	Super Royal .	28½ × 21½
Royal . . .	26 × 21	Double Crown .	31 × 21
Royal Extra .	27 × 22	Imperial . . .	31 × 23

In filling up the press it is customary to place iron plates at certain intervals; this gives additional solidity to

the whole, and, in the case of two or more sizes of work being placed in the press at one operation, compensates for the difference in size of sheet and distributes a more equal pressure all over. Glazed boards soiled with ink may be cleaned with a little turpentine rubbed on with a piece of flannel and finished with a soft duster.

Hot pressing is as a rule undertaken by people outside, and is generally performed by a hydraulic press, hot plates being inserted at frequent intervals. The impression is taken out more easily by this method, and a better finish usually given by the heat employed. The sheets are placed between glazed boards as in cold pressing. This process is well adapted for cut work owing to its thoroughness in pressing and finish without an excess of glaze, which is given by hot rolling.

Hot rolling machines are constructed for the purpose of drying and pressing (or rolling), the heat being obtained either by steam or gas. Gill's machine, fig. 148, was the first brought to the notice of the trade, but another has been lately introduced by Mr. Salmon.

For fine work that is not in a very great hurry this process is not recommended, as the heat to some extent deteriorates the colour of the ink; but for average work which is wanted sharply it is admirably adapted, as the machine answers the double purpose of drying and pressing, besides effecting a large economy in the drying room, which may be utilized for other work in less hurry and requiring to be dried by the slow process. The degree of rolling by the hot system may be regulated—the heavier the roll the greater the glaze. Of course this has the effect of thinning the paper by the great pressure brought to bear on it, but in some instances, in very bulky books, this may be desirable; for instance, the bulk of "Kelly's Post Office Directory" is considerably reduced by this method. As before said, this class of rolling is a great

labour-saving consideration, but, naturally, the ink, to retain its normal colour and density, should be dried by less artificial means, and it is by the older and more gradual method of drying that really first-class book-work should be executed, if durability and fulness of colour be desired.

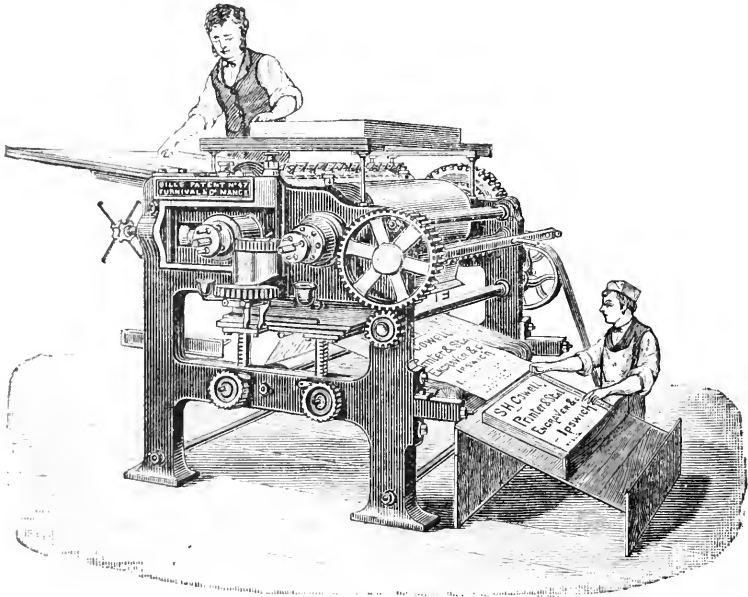

Fig. 148.

The glazing, too, for some characters of paper, is objectionable; the act of rolling, hot or cold, having the tendency to take all the "life" out of the paper and alter entirely its original texture. For illustrated magazine work where time is an important item, and the class of engravings are improved by rolling, it is very useful and particularly recommended.

Cold rolling may also be performed by the last-mentioned machines, but for any great quantity the older kind of machine is advised. Less surface is imparted by this last process, and if cuts have to be printed on a paper which has not a good surface, cold rolling is resorted to—as also after the work is printed. If cuts are printed on one side only, as for separate plates, the paper need only be rolled on one side. To do this it is customary to send two sheets through the machine at one time, back to back, the outside of the two sheets only being glazed and the inner sides retaining somewhat the old surface. This plan prevents the paper being made too thin. There are two methods of rolling, viz., plate, and that performed simply by running the work between the bare rollers, without anything in the shape of boards, sheets, or plates. In rolling printed work great care should be taken to prevent offset of ink. The hot-rolling apparatus has an automatic arrangement for cleaning the rollers when in use. For cold rolling the best way is to first have the printed work thoroughly dried, or it will assuredly be spoiled.

Cutting machines form an important feature in the warehouse department, and the selection of a machine offered by well-known firms is advised. Various machines are before the trade, but those on the guillotine principle are the best. Some give a straight and direct cut, others a diagonal, and there is also a self-clamping arrangement used. Furnival's machine, fig. 149, is one of this class, embodying all the latest improvements, and thus effecting a great saving of time in cutting large quantities.

For the cutting of small jobs a *spring guide* is used, which allows of the work being pushed to the front for the cut—the width of the platen preventing this in the ordinary machine.

A *card-cutting machine*, fig. 150, is likewise useful in this department. For the present, these are all the machines

required in the warehouse, the other appliances will be touched on in order.

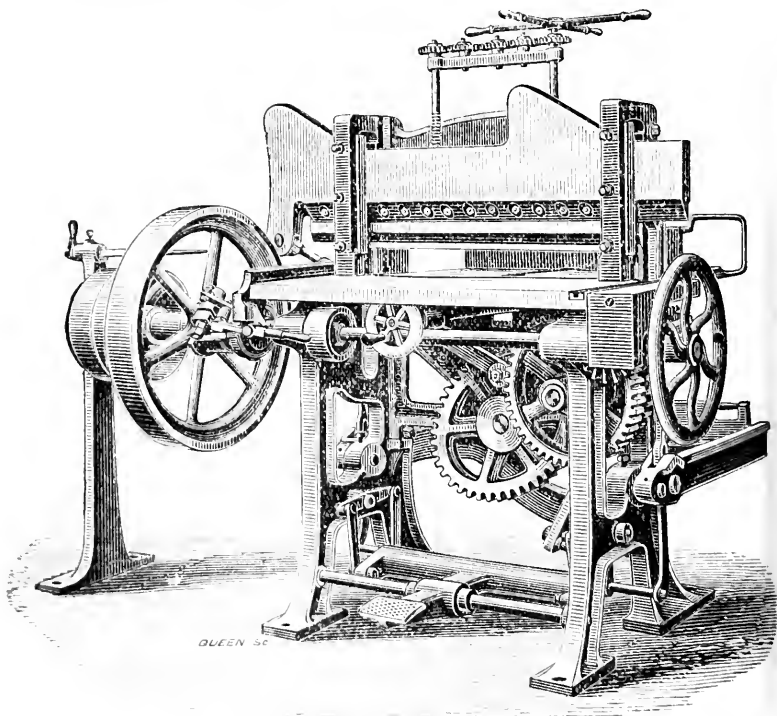

Fig. 149.

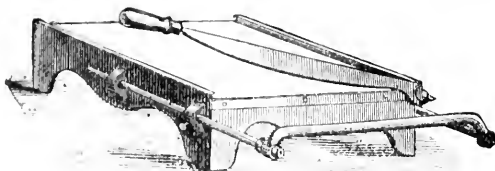

Fig. 150.

CHAPTER XXXIII.

The Care of Paper—Wetting down—The Wooden Press—Counting—The Drying Room—Cold Pressing and manner of performing the same—Stacking Work—Gathering—Collating—Folding—Booking—Packing—Keeping Stock—Folding, Stitching, Stabbing, and Sewing—Binding, Ruling, Perforating, and Numbering.

ONE of the first duties of a warehouseman is the charge of white paper—in large offices a separate warehouseman is told off for this purpose. All paper received should be checked and entered up in a proper book, showing at a glance the date, from whom received, the size, weight, and description, besides the name of the work it is intended for, and on whose account it is sent in, whether a customer's or the "house." These latter particulars are important, as a printer often keeps a stock of certain kinds of paper for his own use, or for customers for whom he supplies paper. Nothing should be given out or used till a note has been taken; in doing so it should be seen whether reams are "perfect" or not.

Wetting down.—To prepare paper for printing it is customary to damp it down—that is, ordinary printing papers. Soft, unsized, glazed or rolled, and writing papers should not be wetted down, as that operation would spoil them at once; they must be printed dry. In wetting down all other papers, the nature of the paper must be considered; some of the papers, being well sized and harsh, will not take the water easily, and when wet require to lie by longer, and need more turning. Supposing the paper to be wetted is an ordinary printing one, machine made, and the paper quired or folded, the wetter should open his ream, and place it on the left of his *wetting trough*, fig. 151, open the quire, smooth out the back, and dip one end of the sheet in

first, drawing it through the water in the form of a curve, fig. 152. When he has done that, he should place it flat on a quire already opened, but not wetted. Having laid the wet quire on the dry, he should lay another dry one on the top of the wetted one, and so on to the end of the ream—each wetted quire being sandwiched by two dry ones. When he has completed the ream or reams required, a board

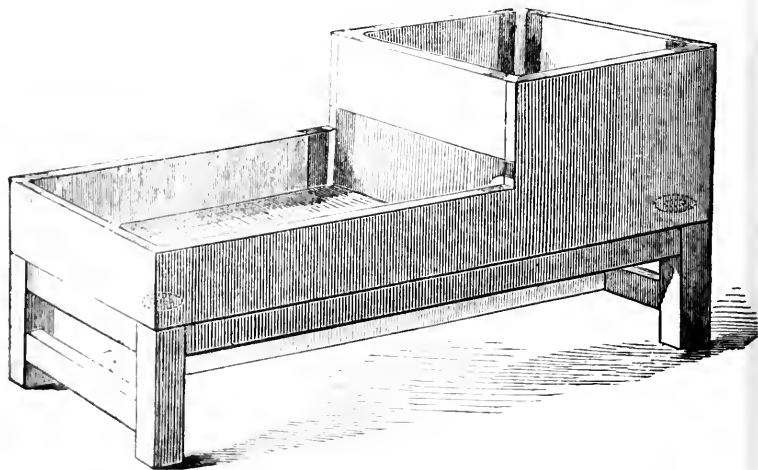

Fig. 151.

should be placed on the top, a bottom one having been first placed down to receive the first quire, and weights placed on the top for a few hours, in order to thoroughly soak the whole. When time has been allowed for this, the board should be taken off, and the whole of the ream turned. This is performed simply by turning round (not over) every quire or so, thus mixing up the whole, dry and wet. The paper should then be placed in the screw press, and fastened down. These presses are of wood, and are worked by an iron screw attached to the "follower."

Counting.—Paper should be checked before being given out for printing. As the operation of counting is a very important one, great correctness is necessary, especially in counting printed work. The method adopted is to take two or three quires, according to the thickness of the paper, at the corner, and give it a sharp turn over by a quick movement of the wrist. If this is done properly, it fans the sheets out, and they may be counted very readily. They are counted off in fives, twenty “fives” to a hundred, and the hundreds usually lapped over. This is the most expeditious manner of counting, and an expert can run through a thousand in a very short space of time. In giving paper

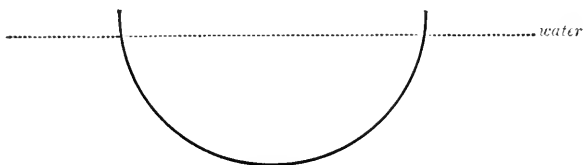

Fig. 152.

out, reams should be perfect, or made so, and duly entered up. When printed it has to be counted again, and if correct, entered—the date, signature, name of work, and workman being noted. In sheet work it is advisable to count it when the first side is printed off, before perfecting the sheet.

The drying room is the next consideration, and the most useful one is that heated by hot water; steam is sometimes used. The pipes should be arranged all round the room in coils, and, if a very large room, some placed in the middle too. The drying poles are frames, fig. 153, hanging from the ceiling, which slide along two larger horizontal poles. Those which hold the work are about two feet apart, the length being determined by the width of the room. By

placing these frames on a sliding arrangement overhead they may be shifted along, and a wider passage formed between each two, so as to allow a person to pass through, that

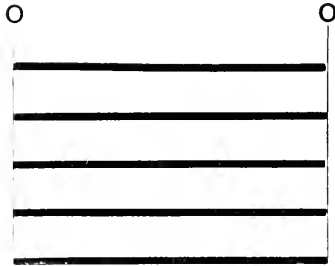

Fig. 153.

he may get readily at the work. Placing the printed work on the poles is performed by dividing the ream into “lifts” or handfals, just overlapping each other on one edge. The topmost poles are reached with a *peel*, fig. 154; several lifts are put on at a time, and placed in their position by the same instrument—the lower ones, of course, are best filled by hand. The room should be kept up to a uniform heat—about 120 degrees Fahrenheit—and the work removed as dried, and its place occupied by other work.

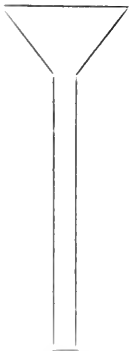

Fig. 154.

In the absence of a proper drying room poles are sometimes suspended singly from the roof of the warehouse, and the work is dried by perfectly natural means; but care should be taken that the top sheets do not get soiled by dust; to prevent this wrappers should be placed over each lift. The peel is here an indispensable tool in hanging up, as also in taking down. When the work is sufficiently dry it should be stacked, each signa-

asked for by a customer whilst the work is in progress, and the pulling down the whole of the pile is avoided by this means. Always build stacks on a board or stage raised from the ground, as this prevents accidents from the upsetting of water, or the bottom of the pile being damaged by getting knocked or even kicked by the feet.

Gathering.—For this purpose a table is used, generally of a horse-shoe or three-sided pattern, which should be large enough to hold twenty sheets of, say, double crown at least, placed side by side. Rotary or revolving gathering tables are sometimes used, the bench revolving as the operator stands in a fixed position, and lifts one of each sheet as it passes him. The sheets should be laid down on the board in order of alphabet, commencing with signature B, the title and other oddments coming last. If the book is a long one, or the paper is thick, the gathering must be made in two or even three sections. One of each signature only should be gathered at a time, and when the end of the table is reached they should be gently knocked up squarely at the edges, and each book or section placed in a pile.

Collating, folding, and packing.—When a heap is formed it should be collated by means of a bodkin or piece of rubber, all duplicates drawn, and wrong sheets rectified. As each book is collated and found correct, it should be simply moved aside a little in the left hand to indicate the division between each, and when the hand is full, lifted off the pile, and turned face downwards. They are then ready for folding in half. This is done merely for the more convenient packing of parcels. In folding these books or sections care should be exercised to obviate “herring boning,” that is, not creasing the paper by the improper use of the folder. This can be obviated by holding the folder somewhat flatly, both in the up and down strokes with that instrument, reversing the angle of the folder on the back or down fold. When folded, the work may be booked; if in sections, the parts

must be put together, and reversed—every copy—in order to keep the parcel flat and square. If the book is in one section only, the copies may be reversed, or turned in “sixes.” Suitable parcels as regards size should be packed in brown paper, tied with string, and labelled with the name of the work and the number of copies they contain.

To return to the finishing off of the sheets after drying. The methods of hot pressing, hot or cold rolling, have been already mentioned. Cold pressing is nearly always done by the printer himself, but the other methods, especially the hot pressing, by outside firms. The great point in hot rolling is that the rolls should not be too hot, and that too great a pressure should not be exerted. If the first happens the ink will suffer, and in the latter case the paper will be thinned out too much; for ordinary purposes the impression is all that is necessary to be taken out, and in doing this sufficient glaze and finish will be given to the sheets. Offset is another danger to be avoided by the proper use and care of the special apparatus for the purpose, a solution of common soda in water being mostly used.

Keeping stock.—In delivering work a complete record should be kept, and nothing sent away without a signature being given for it. The warehouseman should keep two ledgers, one for white paper, accounting for all paper received and used, and showing at a glance what is on hand. It is best that the stocks of customers be kept distinct from each other, and, if complicated, that one separate entry be made for each kind of paper. Further, it is advisable that the house papers—those supplied for the different jobs and works by the printer himself—be kept quite apart from any customer's; in fact, treated, as it were, for quite a distinct customer. If these suggestions are carried out, and the books kept up to date, much trouble and labour will be saved in referring from time to time, and a report or stock-

list may be furnished at short notice. All white papers should be kept covered up, and broken reams—we mean parts of reams—re-packed and marked as to quantity. Printed work should also be protected, and if stacked for any length of time whilst the book is in progress, the pile should be built squarely and firmly, and care taken that the edges are all even and well knocked up. All stacks should be well covered at the top to keep them free from dust and dirt, and, of course, printed sheets or reams should not be handled or carried about without a top or bottom sheet; a wrapper on both sides is the best protection.

On the first delivery of any job or work a complete copy should be laid aside for charging-up purposes by the counting-house, but this copy need not be a good one so long as it is perfect as regards the whole quantity, and has a ticket attached explaining the name of customer, date of delivery, size, quantity printed, if paper supplied by customer or house, &c.

In *parcelling* up works for delivery, neatness in packing and conciseness in labelling are two great points. The parcels should not be unwieldy, but adapted for handling easily. Care should be taken that the string does not cut into the edges of the sheets, which may be obviated by a piece of paper doubled up and placed under the string at the points where it turns over the edges of the parcel. If it is a very particular character of paper, it is best to seal it up, because this reduces the risk of damaged edges; but it is of course awkward if necessary to draw on the parcel, as it requires re-sealing up, whereas a bundle tied up is more readily re-tied.

Folding, stitching, stabbing, and sewing come under the head of binding, and are usually executed out of the house, but a description of these points may be of interest. *Stitching* applies mostly to pamphlet work of a single section, when it is stitched through the centre of the sheet at the fold

by opening it, and sometimes through the wrapper, if there is one, at the same operation ; sometimes the wrapper is drawn on, that is, glued or pasted on, after stitching. Stabbing is a system to be avoided as much as possible, because it is a method which does not allow of the book opening freely ; it is adopted frequently for pamphlets of several sections, and is performed by stabbing the thread through several sheets at the side thus, fig. 156 :



Fig. 156.

Sewing is used for books, and is the best way of binding anything together consisting of more than one section. Each sheet is sewn through the middle of the fold, over two or three cross tapes or strings, according to the size of the book, and the thread carried into the next sheet, and so on ; this is the proper method, allowing of the book opening easily.

Edges of books are treated differently, sometimes according to fancy. "Untouched" or "unopened" edges are those where left precisely as folded ; "trimmed" edges, the heads and bolts are left unopened, and the fore-edge and tail lightly trimmed to make tidy only, but not necessarily smooth ; "cut edges" are when a book is cut all round perfectly smooth.

Publisher's binding is defined as cloth-work or case-work,

but binding proper is really applied to those books bound in leather. Whole bound is when a book is encased in leather entirely ; half-bound, when the back and corners are in leather and the sides in paper or cloth ; quarter-bound, when the back only is leather, the sides being cloth or paper, as in the half-bound.

All these matters sometimes come under the supervision of the warehouseman in giving out work for binding, and it is necessary that he should have some knowledge of the different styles.

Ruling, perforating, and numbering, used for a variety of purposes, are nearly always executed by outside firms, and the terms explain themselves.

GLOSSARIAL INDEX OF TECHNICAL TERMS AND PHRASES.

The following Glossary has been compiled from the author's "Vocabulary of Technical Terms, Phrases, etc.," 1888, but the terms and phrases here given are not all necessarily contained in the text of this work.

- ACCENTED LETTERS.**—Letters with various marks on used in our own and foreign languages for pronunciation or abbreviation, such as à é î ò ñ ã ë etc. 9.
- ACCESSORIES.**—The tools and other small details necessary for the working of any press or machine. 234.
- ACCOUNT MARK.**—A sign thus $\frac{a}{c}$ used in commercial matters, meaning literally "account current."
- ACUTEACCENT.**—A mark placed over a letter, thus á. 8.
- ALBION PRESS.**—An improved iron printing hand-press first invented by Mr. Cope. 149.
— how to erect. 149.
- AMERICAN HARD PACKING.**—This refers to the system of making-ready in vogue in America, in contradistinction to the usual style adopted in England. 230.
- AMPERSAND.**—The abbreviation or sign for the word "and" thus—& (roman), & (italic), ‡ (black letter). 8.
- ANGLO-FRENCH MACHINE.**—A cylindrical perfecting printing machine—the result of various English and French ideas.
- ANTIQUARIAN.**—A size of drawing paper, 53 × 31 inches. 253.
- ANTIQUE TYPE.**—Founts of old or mediæval character, such as Caslon's. 9.
- A. P.**—These initials stand for "author's proof."
- APPEARING.**—A term used to express (say) the length of a page exclusive of white line—just that part of a page which "appears" in printing.
- APPENDIX MATTER,** setting of. 71.
- ARAB MACHINE.**—A small platen machine for jobbing purposes originally made in America. 221.
- ARABIC FIGURES.**—Ordinary figures, roman or italic, thus —1 2 3 etc., as distinct from roman numerals. 11.
- ASCENDING LETTERS.**—These are all letters with up-strokes, such as b d h k l. 17.
- ATLAS.**—A size of writing paper, 36 × 26 inches. 253.

- AUTHOR'S PROOF.**—A proof bearing corrections made by the author or editor. 143.
- BACK BOXES.**—A term applied to the unoccupied boxes of an upper case where there are no small caps or accents. 67.
- BACK MARK.**—The back mark of a laying-on board of a printing machine. 235.
- BACK OF A TYPE.**—The reverse side to the nick or belly of a type. 16.
- BACK PAGES.**—The even or "verso" pages of a printed sheet.
- BACKS.**—Referring to the "back" margin of pages—that part of a book which is sewn when bound; sometimes the crosses are thus termed. 84.
- BACK-UP.**—Is to reverse the motion of a machine, mostly performed by hand.
- BACKUS MOTOR.**—A power obtained by water. 210.
- BAD COLOUR.**—Too much or too little ink used—also uneven distribution and rolling. 179.
- BAD COPY.**—Applied to badly written MSS. and "lean" copy. 63.
- BAD MATTER.**—Term used to indicate type for distribution. 65.
- BAKED.**—Applied to type when sticking or caked together, and hard to separate in distributing. 68.
- BAND.**—A belt or strap for imparting motion from the shaft to a machine. 207.
- BANK.**—A wooden table or bench for placing the sheets on as printed. 154.
- BANK PAPER.**—A thin paper mostly used for foreign letter or note paper to save cost of postage. 257.
- BAR.**—A cylindrical printing machine with "drop-bar" action for laying on. 237.
- BARGE.**—A small wooden box with six or eight divisions used for holding spaces to alter justification in making corrections. 91.
- BASTARD FOUNTS.**—A fount of type cast on a larger body than originally intended for. This obviates trouble and the expense of leading a smaller body. 17.
- BASTARD TITLE.**—A fly or half-title before the full title of a work. 71.
- BATTER.**—Broken or damaged letter or letters through accident, wear and tear, or carelessness. 93.
- BEAM ENGINE.**—An engine well adapted for driving machines of various classes. 201.
- BEARD OF A LETTER.**—The blank sloping part, foot or head, of the shoulder of a type not occupied by the face of the letter. 16.
- BEARER.**—A clump or anything type-high to bear off the impression from the light parts of a broken forme. 175.
- BEAT.**—In order to impart good colour to a particularly solid part of a forme—a woodcut, for instance—a pressman beats that portion with his roller to give it additional ink. 187.
- BED.**—The table or "coffin" of a machine or press upon which the forme lies. 146.
- BED OF THE FRAME.**—The lower part of the frame, which forms a shelf that can be used for placing surplus sorts on. 25.
- BELLY OF A TYPE.**—The front or nick side of a type. 16.
- BELTS.**—The straps or bands for driving machinery. 207.
- BILLS OF TYPE.**—Complete

- founts of type made up to certain weights. 7.
- BINDING.**—In locking-up a forme if the furniture is longer or wider than the type and doubles, it is said to bind, and the pages cannot be tightened up properly. 91.
- BISSCHOP GAS ENGINE.**—A small horizontal motor. 208.
- BITE.**—When a page or portion thereof is not printed by reason of the frisket being badly cut out and the impression only shows. 176.
- BLACK LETTER.**—A general expression used to indicate old English or church type. 11.
- BLACKS.**—When a space, quad-rat, or furniture rises and is imprinted on the sheet. Also used when woodcuts and electros are not sufficiently cleared out, and print the low parts.
- BLIND P.**—A paragraph mark ¶ so called from the loop of the p being closed. 8.
- BLOCK.**—A general term used—embracing woodcuts, electros, or zincos. 184.
- BOARD RACKS.**—Racks, made in “bulks” usually, to hold laying-up boards. 47.
- BODKIN.**—A pointed steel instrument fixed in a round handle, mostly used to correct with in the metal. 51.
- BODY.**—This is the shank of a letter. Also applied to the text type of a volume, “body of the work.” 16.
- BODY OF THE WORK.**—The text or subject-matter of a volume is thus described to distinguish it from the preliminary, appendix, or notes.
- BOLSTER.**—A stop at the end of the ribs of the press to prevent the carriage running out too far.
- BOOK FOUNTS.**—Founts of type distinct from fancy or jobbing types. 9.
- BOOK-WORK,** table of lengths and widths of. 136.
- BOTTOM BOARDS.**—The lower or taking-off boards of a printing machine.
- BOTTOM NOTES.**—Footnotes are sometimes thus called, to distinguish them from side-notes. 70.
- BOURGEOIS.**—The name of a type one size larger than Brevier and one size smaller than Long Primer—equal to half a Great Primer in body. 19.
- BOWRA CUTTER.**—For lead or brass. 50.
- BOX IN.**—A term used to indicate that rules should be placed round as a border.
- BRACES.** ~ ~ These are cast on their own bodies and by degrees of ems. and used to connect lines. Longer ones are usually made of brass rule by special pliers. 8.
- BRACKET.**—A holder or hanger from the roof to support shafting. 206.
- BRAKE.**—Apparatus for facilitating the stopping of machinery.
- BRANCH OUT.**—To lead or “white” out a title or display lines of any kind.
- BRASS CIRCLES.**—Used for jobbing work. 101.
- BRASS RULE,** cases for. 35.
- BRASS RULE cutter.** 49.
- BRASS RULES,** specimens of. 34.
- BRAYER.**—A wooden implement for rubbing out ink on the table for distribution. 155.
- BRAYER INK TABLE.**—A table used by pressmen on which to bray ink out, distinct from cylindrical ink tables. 155.
- BREAK.**—An expression used to

- indicate the end or commencement of a paragraph. It is also indicated in copy by a bracket mark, thus [or]. 93.
- BREAK OF A LETTER.**—The surplus metal on the foot of a letter when cast. 5.
- BREAK UP.**—An amateurish expression for distribute or clear away.
- BREAK UP INTO PARS.**—To break up solid copy into short paragraphs.
- BREVIER.**—A size of type one size larger than Minion and one size smaller than Bourgeois. 19.
- BRILLIANT.**—A size of type one size larger than Minikin and one size smaller than Gem. 20.
- BRING UP.**—To make ready or level the type by overlaying or patching up. 175.
- BROAD.**—A piece of furniture, wood or metal, four picas in width. 36.
- BROADSIDE.**—A sheet printed one side only, such as a poster or bill. 97.
- BROADSIDE composing stick,** usually made of wood. 30.
- BROKEN LETTER.**—Is said of type pied or squabbed.
- BROKEN PAPER.**—Outsidesheets or quires indicated by three crosses × × × 250.
- BRONZE BRUSHES.**—A special contrivance for dusting bronze by hand. 192.
- BRONZE INK.**—Various inks made with an addition of bronze. When dry, they give a decided metallic appearance to the surface. 192.
- BRONZE PRINTING,** how to improve. 193.
- BRONZING MACHINE.**—A mechanical contrivance to economize time and obviate waste of material. 193.
- BULK.**—Usually the bench situated at the end of a composing frame. 45.
- BUNDLE.**—Generally two reams of paper in a parcel. 250.
- BUR.**—The roughness left on a letter through insufficient dressing by the type-founder.
- BUTTON OF TYMPAN.**—The stud on the frame which the hook catches in order to hold the inner and outer tympan secure. 153.
- CAKED TYPE.**—See “Baked” type. 68.
- CALENDERED PAPER.**—Paper very highly rolled or glazed, much used for the printing of illustrated works. 231.
- CAM.**—A wheel of irregular shape (not round) to impart eccentric motion to any particular part of a machine.
- CANCEL.**—A reprint of a leaf or leaves owing to a mistake—literary or technical—and usually indicated by an asterisk in the white line.
- CANON.**—A type four picas deep in body, but somewhat small in face. 19.
- CAPS.**—Abbreviation of word “capitals,” and usually indicated by three lines === in MS. 63.
- CAPS AND SMALLS.**—A word or words set in small capitals with the initial letter a full capital—thus, **PRINTER**—indicated by three and two underlinings respectively, thus — and — in copy. 63.
- CARD CHASES.**—Small chases used for cards or similar small jobs. 43.
- CARD-CUTTING MACHINE.**—A small machine specially made for the cutting of cards. 263.
- CARD PRESS.**—A small jobbing

- hand-press—treadle machines are sometimes so called—used for printing cards or other small work. 152.
- CARDS, number contained in a royal board. 258.
- sizes of. — There are several regular sizes, such as large, small, thirds, cabinet, carte de visite, etc. 257.
- varieties of. 257.
- CARRIAGE.—The bed or coffin on which the forme is laid and which runs under the platen or cylinder in a printing press or machine. 146.
- CARTE DE VISITE CARDS.—Cards cut $4\frac{1}{2} \times 2\frac{1}{2}$ inches, used by photographers for mounting prints of that size. 257.
- CASE.—The receptacle in which type is laid to compose from. When in pairs, defined as upper and lower respectively. 26.
- CASE RACKS.—Receptacles for holding cases when out of use—distinct from frame racks, which are used for cases in use. 47.
- CASE WORK.—The general expression for defining the compositors' work in printing a book.
- CASING.—A size of brown paper, 46×36 inches. 256.
- CASLON TYPE.—A term sometimes applied to the old-face types cut by William Caslon. 11.
- CASTING-UP.—To measure the pages by means of ems and ens of its own body according to the existing scale of prices. 131, 135.
- CAST-IRON CHASES.—Chases made by casting in an iron foundry. These, though cheaper than wrought iron, are rougher and more likely to be fractured if not carefully handled. 42.
- CAST-OFF.—To calculate or estimate length of copy to be printed—a troublesome task in uneven and badly-written MS. 138.
- CATCHES.—Made generally of brass, to hold stereo or electrotype plates on blocks. 194.
- CATCHLINE.—The line which contains the "catchword" at the bottom of a page.
- CANTON.—The particular kind of Old English type used for composing books in that character. 12.
- CEDILLA c.—A French accent—thus, ç. 8.
- CHAPELS.—The meetings held by the workmen to consider trade affairs, appeals, and other matters are thus termed. Derived, it is said, from Caxton's connection with Westminster Abbey.
- CHAPTER HEADS.—The headings to a chapter. 63.
- CHASE.—An iron frame, cast or wrought, to hold the type for printing. 41.
- CHECK SCREW.—A screw in the hand-press to regulate the length of pull.
- CHILL.—An elbow of steel immediately at the end of the press bar, which gives the impression by its being moved into a vertical position on the bar being pulled over. 151.
- CHOKED.—An expression used when the face of type gets filled up with ink and dirt, owing to bad washing and rinsing of formes.
- CIRCLED CORRECTIONS.—Special alterations made after the type has been corrected are generally encircled on the

- proof in order to call particular attention to them.
- CIRCLES.**—Brass rings cast hollow to allow of type being placed inside. 101.
- CIRCULARS.**—The class of small job work which includes letters, circulars, etc. 96.
- CIRCUMFLEX.**—Accented letters marked thus, á ê î ô û. 8.
- CLARENDON.**—A bold or fat-faced type is generally thus described; the older fonts were called "Egyptian." 13.
- CLASSICAL LANGUAGES** in composition. 109.
- CLEANING TYPE.** 181.
- CLEAN PROOF.**—Term used to discriminate between a foul or first proof and a proof ready to be sent out to a customer. 96.
- CLEARING PIE.**—To separate and distribute broken or mixed types into their proper cases.
- CLICHÉ.**—French term for a cast, usually applied to stereo or electro duplicates.
- CLICKER.**—The compositor in charge of a companionship, who receives copy and instructions direct from the overseer or principal, and is responsible to his companions for the charging of the work. 132.
- CLOSED APOSTROPHES.**—Double apostrophes (") indicating the end of a quoted passage. 61.
- CLOSED UP.**—When a compositor has been behindhand with his share of copy and his companions awaiting the completion, he is said to have "closed up" when finished.
- CLOSET.**—The counting-house is sometimes thus described, as is also the reading-room.
- CLOTHING A FORME.**—Placing the necessary furniture round the pages of type. 88.
- CLOTHING ROLLERS.**—Changing the composition on worn-out rollers. 158.
- COBB PAPER.**—A paper largely used by bookbinders for the sides of half-bound books. It is made in various shades of colour.
- COCK-UP.**—A superior figure or letter that does not range at bottom, and is used for contractions, thus "Mr." or "A."
- COFFIN.**—The carriage or bed of a cylindrical machine or platen press. 227.
- COLD PRESSING.**—Sheets pressed between glazed boards, usually, and more effectually, in a hydraulic press. 269.
- COLD ROLLING.**—In contradistinction to hot rolling—the rollers being made hot in the one instance, and in the other the rollers being in the natural state. 263.
- COLLAR.**—A circular band fastened with nuts and screws to hold two lengths of shafting together. 206.
- COLLATE.**—To run through the sheets of a book to see if the signatures are in sequence. 270.
- COLOMBIER.**—A drawing paper, size $34\frac{1}{2} \times 23\frac{1}{2}$ inches. 253.
- COLON.**—A mark of punctuation: 8.
- COLOUR,** hints on. 190.
— uniformity of. 179.
- COLOUR PRINTING.**—Printing in one or more colours than black. 102, 189.
- COLOUR WORK** in composition. 102.
— in press department. 189.
- COLOURED INKS,** making of. 172.
- COLOURS,** harmony of. 190, 191.
— selection of. 191.
- COLUMBIAN PRESS.**—An iron hand-press invented by Mr. Clymer of Philadelphia in the early part of this century. 147.

- COLUMBIAN PRESS**, how to erect. 147.
- COLUMN GALLEY**. — A metal galley used in newspaper work. 32.
- COLUMN MATTER**. — Type set in two or more columns is thus described. 133.
- COLUMN RULES**. — Rules used for dividing works set in columns. 35.
- COMBINED ENGINE AND BOILER**. 205.
- COMMON POINTS**. — Ordinary points with a pin or spur attached, in contradistinction to "spring points," etc. 177.
- COMPANIONSHIP**. — A number of compositors who work together under a clicker.
- COMPLETE FOUNT**. — A fount of type including capitals, small capitals, lower-case, figures, accents, spaces, etc., as distinct from "sorts." 8.
- COMPOSE**. — To set up type. 56, 60.
- COMPOSING FRAMES**. 24.
- COMPOSING MACHINES**. — Mechanical appliances for setting type. 106.
- COMPOSING ROOM (or DEPARTMENT)**. — The portion of a printing office occupied by the compositors. 24.
- suggested plan of. 53.
- COMPOSING RULE**. — A brass rule, with a nose-piece, the length of the measure or width of the type being set up; it facilitates the composition in being shifted line by line. 30.
- COMPOSING STICK**. — A tool or implement for setting type in, usually made of iron or gun-metal. Long sticks, used for broadsides, are made of wood for lightness. 29.
- COMPOSITION**. — The art of composing or setting type. 24.
- COMPOSITION**. — Scale of prices. 131.
- COMPOSITOR**. — A type-setter or composer of type.
- CONDENSED LETTER**. — Thin and elongated founts of type are thus described. 13.
- CONNECTION**. — In passing sheets of a work finally for press the reader sees that the sequence from sheet to sheet is preserved, and not disturbed by any overrunning. 142.
- CONTRACTIONS**. — Abbreviations, or record sorts, indicated by accents over or through the letters.
- COPY**. — The manuscript or reprint copy from which the compositor composes. 60.
- CORKS on forme**. 179.
- CORNER**. — An ornament used for decorating the corner of a border in brass rule or otherwise.
- CORNER IRONS**. — The corner pieces of iron screwed on the corners of the bed or coffin of a press.
- CORNISH BOILERS**. — A boiler frequently adopted by steam printers. 201.
- CORRECTING STONE**. — The surface on which a forme is laid to be corrected. 43.
- CORRECTIONS**. — The emendations or alterations made on a proof. 94, 95.
- method of making. 91.
- holding, in fingers. 92.
- CORRECTOR OF THE PRESS**. — Another term for the proof reader. 141.
- COUNTER**. — The person responsible for the proper counting of all work as printed off. 267.
- COUNTER SHAFTING**. — A shaft connected with the main shaft in driving machinery. 201.
- CREAM-LAID**. — A writing paper

- showing the wire marks when held up.
- CREAM-WOVE.**—A writing paper without wire marks—the reverse of “cream-laid.”
- CREAMY PAPER.**—Paper with a slight tone is thus described.
- CROPPER MACHINE.**—An American small treadle platen machine made by Mr. Cropper. The original one was the “Minerva.” 216.
- CROPPER.**—A short term for the “cropper” small printing platen machine.
- CROSS-BARS.**—The bars which divide chases into sections—fixed in cast chases, but generally movable in wrought. 42.
- CROSS LINES.**—Short displayed lines, such as chapter or section heads. 63.
- CURVED LINES,** method of making. 100.
- CUSTOM OF THE HOUSE.**—Certain rules and regulations in vogue in any particular printing office. 62.
- CUT AWAY.**—To lower or cut away any particular part in a making-ready sheet. 175.
- CUT FORMS.**—Forms of illustrations, in contradistinction to ordinary forms of type or book-work.
- CUT OUT.**—To cut out an overlay, or cut away in a making-ready sheet. 175.
- CUTS.**—This is a colloquial expression for an illustration of any kind—electrotype, woodcut, or zincograph. 155.
- CUTTING MACHINES.**—Appliances for cutting paper. 263.
- CUTTING-OUT KNIFE.**—A sharp-pointed knife used in making ready. 157.
- CYLINDER GALLEY PRESS.**—A small press for pulling galley proofs by means of a heavy roller or cylinder pushed along by hand. 48.
- CYLINDER MACHINE.**—A printing machine giving the impression by a cylinder instead of a platen. 212.
- CYLINDRICAL INK TABLE.**—An ink table which revolves by a handle, and thus gives the ink to the roller, instead of braying out by the tool for the purpose. 155.
- DANDY.**—The wire frame or mould on which paper is made.
- DECIMO-SEXTO.**—The bibliographical term for sixteenmo—written shortly, 16mo.
- DECKLE.**—The raw, rough edge of paper in hand-mades is thus termed. 248.
- DELE.**—To omit or expunge, indicated thus δ . It is derived from the Latin. 93.
- DEMY.**—A size of printing paper, $22\frac{1}{2} \times 17\frac{1}{2}$ inches; writing paper, $20 \times 15\frac{1}{2}$ inches. 250.
- DESCENDING LETTERS.**—These are all those letters with down strokes, thus—p q y, etc. 17.
- DIAMOND.**—The type one size larger than Gem, and one size smaller than Pearl—equal to half a Bourgeois in body. 20.
- DIRTY PROOF.**—A proof-sheet with many corrections due to careless composition.
- DISPLAY WORK.**—Type displayed, such as titles, headings, and jobbing work, is thus termed to distinguish it from ordinary solid composition. 96.
- DISTRIBUTE.**—To replace type in cases after printing. 66.
- DISTRIBUTING ROLLERS.**—The rollers which take the ink from the vibrator communicating with the ductor. The rollers have a diagonal move-

- ment, and distribute the ink on the table. They are sometimes called "wavers." 227.
- DOUBLE.**—Words repeated in composition by error, necessitating overrunning; used by pressmen when a sheet is twice pulled or mackled. 92, 183.
- DOUBLE BROAD.**—Furniture eight picas in width—double the width of "broad." 36.
- DOUBLE CASES.**—Cases specially made upper and lower case in one, used for small jobbing founts. 27.
- DOUBLE CROWN.**—A printing paper, 30 × 20 inches. 250.
- DOUBLE DEMY.**—A printing paper, 35 × 22½ inches. 250.
- DOUBLE FOOLSCAP.**—A printing paper, 27 × 17 inches; writing paper, 26½ × 16½ inches. 250.
- DOUBLE FRAME.**—A frame to hold two pairs of cases up at one time. 24.
- DOUBLE IMPERIAL.**—A printing paper, 44 × 30 inches. 250.
- DOUBLE LETTERS.**—Diphthongs and old-face letters, æ, œ, ð, &, etc., are thus called. 8, 10.
- DOUBLE NARROW.**—Furniture six picas in width—double the width of a narrow. 36.
- DOUBLE PICA.**—The name of a fount one size larger than Paragon, and one size smaller than Two-line Pica—it is two Small Picas in depth. 19.
- DOUBLE PLATEN MACHINE.**—A machine, somewhat out of date, with a flat impression printing at both ends. 223.
- DOUBLE POST.**—A size of printing paper, usually 32 × 20 inches. 250.
- DOUBLE POTT.**—A printing paper, 25 × 15 inches. 250.
- DRAG.**—When a shake or slur is on a printed sheet it is said to "drag."
- DRAW.**—When through bad justification the letters draw out on the roller in inking the forme.
- DRESSING A FORME.**—See "Clothing." 88.
- DROP-BAR perfecting machine.**—The laying-on is performed by the "drop-bar" action. 237.
- DROPPED HEAD.**—Chapter or first pages driven down at the top are thus called. 68.
- DRIVING ROOM.**—For printed work, heated by steam or hot water. 267.
- DUCTOR.**—A reservoir which holds the ink in a printing machine, the supply from it being regulated for each impression. 218, 225.
- DUODECIMO.**—Commonly called twelvemo, a sheet of paper folded into twelve leaves, written shortly, 12mo. 73.
- DWELL.**—The stationary period while a sheet is being impressed on the type or forme—a long "dwell" is a good point in a machine.
- EGYPTIAN.**—A fat and ugly-faced kind of type. There is nowadays a larger and more graceful selection of these fancy types. 13.
- EIGHTEENMO.**—A sheet folded into eighteen leaves (octodecimo), written shortly, 18mo. 73.
- EIGHT TO PICA LEADS.**—Leads cast eight to a pica; also called "thin" leads. 32.
- ELBOW POINT.**—Press points made upon an elbow for convenience in pointing twelve or eighteenmo works. 177.
- ELECTROTYPE PLATES.**—A printing surface produced by a galvanic deposit of copper, afterwards backed up with type metal. 195.

- ELEPHANT.**—A size of printing paper, 30 × 23 inches; writing or drawing paper, 28 × 23 inches. 253.
- ELONGATED.**—A thin and condensed form of fancy display type. 14.
- EMPEROR.**—A writing or drawing paper, 72 × 48 inches. 253.
- EMPIRE MACHINE.**—A small platen machine made by Messrs. Powell and Son. 221.
- EM QUADS.**—A quadrat cast one em square to any particular body. 21.
- EM RULES.**—Rules cast on an em of any particular body—a dash, or metal rule. 8.
- ENDLESS PAPER.**—Paper in reels—not in sheets—used for rotary machines. 239, 251.
- EN QUADS.**—Spaces two to an em of any particular body. 21.
- EQUIVALENT WEIGHTS OF PAPER.**—The difference in weight between two sizes to compensate for a larger or smaller sheet. 251, 253, 254.
- ESTABLISHMENT.**—A workman on fixed wages is said to be on the “establishment.” 132.
- EXTRAS.**—The charges involved on composition over and above the fixed price per sheet of the text type, generally charged at the end of a work. 133.
- FANCY RULES.**—Rules other than plain ones of various designs—some short, as used between sections, and border rules. 98.
- FANCY TYPES.**—Founts of type of various kinds used for jobbing purposes. 13.
- FASTENING FORME ON PRESS.** 174.
- FAT.**—Well-leaded, open, or good paying work for piecehands. Sometimes vulgarly called “grease.”
- FATHER OF THE CHAPEL.**—The person who presides at the printers’ chapel.
- FEET OF A PRESS.**—The bottom of the legs of a press resting on the ground. 147.
- FIGURES,** modern and old style. 11.
- FILLING IN.**—Putting the sheets, after printing and drying, between glazed boards previous to pressing. 269.
- FINGERS.**—The grippers which hold the paper in printing on a machine. 228.
- FIRST PROOF.**—The first pull of a forme after composing, which is read for the first time by the copy. 91, 142.
- FLAT PAPER.**—Paper in reams not folded or quired. 249.
- FLAT PULL (or IMPRESSION).**—A simple proof without under or overlaying. 187.
- FLYERS.**—Taking-off apparatus attached to a printing machine. 228.
- FLY LEAF.**—A blank leaf not printed on.
- FLY-TITLE.**—The half-title in front of the general title, or which divides sections of a work. 71.
- FOLDED PAPER.**—Paper folded in half or quire fashion, not “flat” or “lapped.” 249.
- FOLDING.** 270, 272.
- FOOLSCAP.**—A size of printing paper, 17 × 13½ inches. 250.
- FOOT-NOTES.** 70.
- FOOT-STICKS.**—A sloping piece of furniture placed at the foot of pages. 37.
- FORME.**—Page or pages of type imposed in a chase constitute a “forme”—sometimes spelt “form.” 37.

- FORME CARRIAGE** or trolley.—
For moving heavy formes. 91.
- FORME RACKS.** 44.
- FRACTIONS.**—Sometimes cast in one piece, termed "whole," and occasionally in halves, and called "split." 9.
- FRACTUR.**—German expression for their text or black-letter characters. 123.
- FRAGMENTS.**—The odd pages at the commencement and end of a work—now usually called "oddmens." 9.
- FRAME RACK.**—A rack attached to the frame for cases not in immediate use. 24.
- FRENCH RULES.**—Short ornamental rules of either brass or type metal are generally thus designated. 98.
- FRENCHMAN.**—A perfecting machine originally of French make, but improved by English manufacturers, and now called Anglo-French machine.
- FRESH ROLLERS.**—Rollers when too new are said to be "fresh."
- FRET.**—When rollers crack or peel they are said to "fret."
- FRIAR.**—A light or broken patch in a printed sheet. 179.
- FRISKET.**—A thin iron frame joined to the tympan. Its object is to prevent the sheet being dirtied or blackened, by pasting a sheet over the frame and cutting out only the parts to be printed. 153.
— cutting the. 175.
- FROZEN OUT.**—In olden times, before offices were warmed, printers were occasionally frozen out. 181.
- FULL-FACED LETTER.**—A fount of capitals which has no beard on the top of the shank, occupying the whole depth of the body.
- FULL MEASURE.**—Type com-
- posed the full width, and not in half measure or columns.
- FULL POINT.**—Technical name for a period or "full stop"—a mark of punctuation. 61.
- FURNITURE.**—The wood used in making margin for a printed sheet, the thinner kind being usually called "Reglet." Sometimes French metal furniture is used. 35, 36.
- FURNITURE GAUGE.**—The gauge used in measuring the furniture of a forme before sending it to press. 90.
- GALLEY.**—These are wooden or zinc receptacles for holding type before making-up into pages. 32.
- GALLEY PRESS.**—An appliance for pulling proofs of slip matter. 48.
- GALLEY RACK.**—Receptacles for galleys. 47.
- GAS ENGINE.**—A motor propelled by gas of different man or horse powers. 207.
- GATHERING.**—When a volume is wholly printed off, the sheets after drying and pressing are gathered in single copies of complete books; in half-sheet work there would be two copies on. 270.
- GAUGE.**—A gauge to regulate length of page or margins. 69, 90.
- GAUGE PINS.**—Small steel pins with teeth, for securing the lay on small platen machines. 220.
- GEM.**—A type one size larger than Brilliant and one size smaller than Diamond. 20.
- GERMAN CASES.**—These are cases of a special lay for founts used in composing this language. 124.
- GILL'S MACHINE.**—A hot-rolling

- machine much used at the present time for drying and pressing work as it is printed of—thus greatly expediting delivery. 261.
- GIRTH WHEEL.**—The drum on which the girthing winds in the running in or out of the press carriage.
- GIRTHING.**—A kind of webbing regulating the running in and out of the carriage of a press.
- GLAZED BOARDS.**—Millboards, very hard and highly rolled, used for pressing printed sheets in the warehouse. 260.
- GOLD BRONZE.**—Very fine powder used in gold-printing. It is dusted on after the forme is printed with a preparation specially made. 192.
- GOOD COLOUR.**—When the ink is properly applied to a sheet—neither too much nor too little—but of a good and even depth. 179.
- GORDON PRESS.**—A small treadle platen machine made by Messrs. Powell and Son. 221.
- GOTHIC.**—An antique character of type similar to black-letter.
- GRAVE ACCENT.**—A sign over a letter, thus à. 8.
- GREAT PRIMER.**—A size of type one size larger than English and one size smaller than Paragon, equalling two Bourgeois. 19.
- GRIEK,** rules for composition of. 109.
- GRIEK CASES.**—These are cases of special lay for composing works in that language the upper case being especially complicated by reason of the many accents required. 110.
- GRIPPER** perfecting machine. —Applied to the machines that receive the paper by the “gripper” method. 237.
- GUILLOTINE CUTTING MACHINE.**—A machine made for cutting paper on the “Guillotine” principle. 263.
- GUN-METAL SHOOTING STICK.**—Locking-up sticks tipped with gun-metal to render them more durable. 29.
- GUTTER.**—The “back” margin or furniture of a sheet. This is the part of a sheet which when folded falls in the back of the book. 84.
- HAIR LEADS.**—Very thin leads—mostly sixteen to a pica—rarely used nowadays. 32.
- HAIR-LINE LETTER.**—Very thin-faced type, generally used for letterings of mounts.
- HAIR SPACES.**—Very thin spaces, used mostly for spacing out the letters in headlines of pages. 21.
- HALF CASES.**—Small cases used for jobbing purposes.
- HALF FRAME.**—Small composing frames made to hold one pair of cases only. 25.
- HALF-SHEET.**—Book-work is sometimes printed in “half-sheet” fashion. When thus printed there are two copies on one sheet. 73.
- HALF TINTS.**—A term applied to the parts of an illustration of partial depth. 183.
- HALF-TITLE.**—The sub-title in front of the full title. 71.
- HAMMER.**—The ordinary tool used on pressor machine. 157.
- HAND-MADE PAPER.**—Paper made entirely by hand—a slow and tedious process—chiefly used for éditions de luxe. 248.
- HAND-MADE REAMS.**—These generally run 480 sheets to a

- ream — occasionally 500, or even 516. 249.
- HAND ROLLER.**—Applied to the press roller used by machine-minders in pulling a proof to obviate running up colour with the machine rollers. 158.
- HANGER.**—An iron bracket attached to the ceiling to hold shafting. 206.
- HARD IMPRESSION.**—Too much “pull” on the forme, but sometimes necessary for certain classes of work by reason of paper, etc. 174.
- HARD PACKING.**—An American system of making ready for printing dry paper. 230.
- HEAD.**—The top part of a press, or the top part of a page. 148.
- HEADINGS, to work, at press.** 198.
- HEADLINE.**—The top line or heading of the page which runs throughout the book. 69.
- HEADPIECES.**—Ornamental headings to pages, placed at the commencement of a book or chapter.
- HEADS.**—A term applied to the margin of books at the top of the page. 84.
- HEAP.**—A working or pile of paper, printed or not printed. 154.
- HEBREW, rules for composition of.** 116.
- HEBREW CASES.**—Cases of special lay used for composing books in that language. 117.
- HEIGHT TO PAPER.**—A general expression to denote the height of type. French type is slightly higher than English, consequently its “height to paper” is greater. Worn type is “low to paper.” 18.
- HIGH.**—Type or blocks which stand higher than the rest of the forme. New type is higher than worn type. 175.
- HIND PARTS OF PRESS.**—The supports at the end of the ribs which hold that part up.
- HITHER CHEEK.**—The side of the cheek which is nearest the pressman as he works.
- HOE MACHINES.**—Machines of various patterns made by Messrs. Hoe and Co. of New York. 247.
- HOOK UP (or DOWN).**—The end of a line turned over, and bracketed in the line above or below.
- HORIZONTAL STEAM ENGINE.**—Distinct from the upright or vertical one. 203.
- HORSE.**—An inclined stage set on the bank to hold the heap which has to be printed. 154.
- HORSE-POWER.**—The driving power of engines is determined by horse-power. 207.
- HOT PRESSING.**—A method of pressing by heated plates inserted at intervals. 261.
- HOT ROLLING.**—A method of drying and pressing by hot rolls. 261.
- HOUSE MARKS.**—Corrections in proofs which the piece-hand is not expected to execute.
- HYDRAULIC PRESS.**—Presses in which the power is applied by means of water pressure. 258.
- IMPERFECT PAPER.**—Reams of paper not made up to the full number of a printer’s ream, *i.e.* 516 sheets. Hand-made, drawing, and writing papers are generally imperfect, and run 472, 480, or 500 sheets to the ream. 249.
- IMPERFECTIONS.**—Short sorts required to perfect a type-founder’s bill for a fount of a certain weight.

- IMPERIAL.**—A size of printing paper, 30 × 22 inches; writing paper, 34 × 22 inches. 250.
- IMPOSING STONE.**—A perfectly smooth stone or iron surface on which formes are imposed and corrected, embedded in a strong wooden frame on legs, if stone; if iron, laid on the frame. 43.
- IMPOSITION.**—The art of laying pages down so that when printed they fall correctly in folding. 73.
- IMPOSITION SCHEMES.**—The various schemes or plans by which pages are laid down for imposition. 75-83.
- IMPRESSION.**—The pressure applied to the forme by means of a platen or cylinder to give a print from type. 174.
- IMPRESSION CYLINDER.**—The surface which takes the paper and comes in contact with the type or plates. 227.
- IMPRESSION SCREWS.**—The screws which regulate the amount of pressure in a printing press or machine. 233.
- IMPRESSION SHEETS.**—The sheets which are placed between the tympan or round the cylinder to receive the impression. 174.
- IMPRINT.**—By an old act of parliament a printer is required to affix his name and address to a work (with certain exceptions), and this is termed an imprint. 71.
- IN SLIP.**—Matter set up and pulled on galleys before making-up into pages.
- IN THE METAL.**—Anything in type—the reverse of anything in print; for instance, to read a revise “in the metal” before taking a proof.
- INSET NOTES.**—Side-notes which are let into the text instead of the margin. 70.
- INDENT.**—A line set back a little; for instance, the commencement of a paragraph, which is generally indented an em. 62.
- INDEX.**—The sign of a hand or fist ~~✋~~ Also the reference index at the end of a work. 8.
- INDIA PROOFS.**—Artists’ or engravers’ proofs pulled on India paper. 184.
- INFERIOR FIGURES.**—Special figures cast or made to range at the bottom of a letter, thus
—^{1 2 3}
- INFERIOR LETTERS.**—Small letters which are cast on the lower part of the body, *e.g.*, a e i o u—the reverse of “superior” letters—^{a e i o u}
- INK BRAYER.**—A small wooden implement for rubbing out the ink on the table. 155, 227.
- INK, component parts of black.** 168.
- INK CYLINDER.**—A small metal cylinder contained within the ductor. 227.
- INK DUCTOR.**—The receptacle similar to a trough which holds the ink at the end of a machine. 225.
- INK KNIFE.**—The long blade in the ductor which regulates by means of keys the amount of ink to be given at each impression. Also a small hand-knife used at press. 157, 225.
- INK, management of.** 169.
- INK MILLS.**—Appliances for grinding. 171.
- INK, recipe for black.** 170.
- INK SLAB.**—The table on which ink is distributed, either at press or machine. 155, 171.
- INK SLICE.**—A small iron implement for lifting the ink out of can. 156.

- INK SUPPLY** on machine. 233.
- INK-TABLES.**—The surface on which the ink is distributed. 155.
- INKERS.**—The large rollers on the printing machine which apply the ink to the type. 227.
- INKING BALL.**—The old-fashioned method of applying ink to the type before rollers were invented. 158.
- INKING DISTRIBUTOR** of Cropper. 218.
- INNER FORME.**—The pages of type which fall on the inside of a printed sheet in "sheet" work—the reverse of "outer" forme. 75.
- INNER TYMPAN.**—The smaller and inner of the pair. 153.
- INSET.**—A sheet, or part of a sheet, to be placed inside another sheet to complete sequence of pagination. 72.
- INSIDE REAMS.**—Good and selected paper—applied more especially to drawing or hand-made papers—of 480 sheets; mill reams of 472 sheets contain top and bottom "outside" quires. 250.
- INTAGLIO.**—Printing, such as from copperplate—the reverse of "relief" printing. 1.
- INVERTED COMMAS.**—Extract matter or names of works are placed between inverted commas, thus "and" 61.
- ITALIC.**—*Types of this character.* 11.
— mode of expressing. 63.
- ITS OWN BODY.**—This term is applied to the text type of a work to distinguish it from the note or appendix types, usually smaller.
- ITS OWN PAPER.**—The particular kind of paper used for a certain work—a proof is some-
times asked for on "its own paper."
- JIGGER.**—A small box with divisions to hold peculiar sorts, usually made of quadrats and leads. 67.
- JOB.**—Any work which makes less than a sheet. 132.
- JOB CHASES.**—Small chases used for jobbing purposes. 43.
- JOBGING CASES.**—Double cases made with upper and lower in one. They are sometimes made treble. 27.
- JOBGING FOUNTS.**—Types of fancy character. 13.
- JOBGING MACHINES.**—The small treadle platen machines. 216.
- JOBGING WORK** in composition. 96.
- JUSTIFICATION.**—This term is applied generally to the even and equal spacing of words and lines to a given measure. 58.
- KERN.**—The under part of any letter which overhangs the shank or body, as in some italic founts. 16.
- KISS.**—When rollers on a machine fret against each other they are said to "kiss."
- KNIB OF SETTING RULE.**—The nose of the rule which the compositor lifts up line by line as the type is composed. 30.
- KNOCK UP.**—To make the edges of a heap of paper straight and square by knocking up to one edge. 270.
- LAI D PAPER.**—Paper showing the wire or dandy marks. 249.
- LAPPED PAPER.**—Reams of paper sent in flat, *i.e.* not folded, with the two ends lapped over—thus being divided into three. 249.

- LARGE CARDS.**—A size of card, $4\frac{1}{2} \times 3$ inches. 257.
- LARGE COURT ENVELOPES.**—To take large post 8vo in half, $5\frac{1}{2} \times 4\frac{1}{4}$ inches.
- LARGE POST.**—A size of writing paper, $21 \times 16\frac{1}{2}$ inches. 253.
- LAY.**—This refers to the position of the print on a sheet of paper. Also to the order in which type is laid in cases. 56, 178.
- LAY of book cases.** 56.
- of German cases. 124.
- of Greek cases. 110.
- of Hebrew cases. 117.
- of music cases. 128.
- of news cases. 56.
- of sheet, centring. 199, 219.
- LAY MARKS.** 220.
- LAYER ON.**—The feeder on a printing machine. 222.
- LEAD CUTTER.**—A machine for the cutting of leads or brass rule. 40.
- LEAD OUT.**—To white or spread out by means of leads.
- LEADS.**—Strips of lead cast to different thicknesses and cut to various sizes. 32.
- number of, in a pound. 33.
- required to justify with type. 140.
- LEADERS.**—Dots or full points cast on an em of any particular body, thus ... 8.
- LEAN.**—Close and poor work for piece-hands.
- LEAN FACE.**—A thin or meagre-faced fount of letter. The reverse of "fat face."
- LENGTH OF PAGE,** determining. 69.
- LET-IN NOTES.**—Another term for cut-in notes, *i.e.* let into the text, as distinct from side-notes.
- LETTER.**—A general term for type as a fount. 65.
- LETTER, distinctive parts of a.** 16.
- LETTER BOARD.**—Another term for laying-up boards. 45.
- LETTER MOULD.**—The apparatus used for hand casting of types. 3.
- LETTERPRESS.**—Printing from type as distinct from lithographic or plate printing. 1.
- LETTERS, classification of.** 17.
- LEYER composing stick.**—The slide-fastener consists of a thumb lever. 30.
- LIGATURES.**—Two or more letters cast in one piece, such as &t or &li. 10.
- LIGHT TINTS.**—The lighter parts of a cut in printing. 185.
- LINES, table of, per thousand.** 137.
- LINOTYPE composing machine.** 106.
- LOCKING-UP APPARATUS.**—Applied to the various kinds of patent fastening, such as screws or iron wedges. 38.
- LOCK-UP.**—To fasten up tightly the quoins of a forme by means of a mallet and shooting-stick. 37.
- LOCK-UP CHASES.**—Special chases made in order to dispense with large quantities of furniture in filling up spare room in formes or on the press. 43.
- LOGOTYPES.**—Two or more letters, or sometimes words, cast in one piece.
- LONDON SCALE** for type composition, abstract of. 134.
- LONG CROSS.**—The longest cross-bar of a chase. 42.
- LONG LETTERS.**—Accented letters used to denote contractions, pronunciation, as \bar{a} \bar{e} \bar{i} \bar{o} \bar{u} , etc. 9.
- LONG PRIMER**—A size of type one size larger than Bourgeois and one size smaller than

- Small Pica, equal to two Pearls. 19.
- LOW.—When letters or other parts of a printed sheet do not show up clearly they are said to be “low.” 175.
- LOW TO PAPER.—Type when worn is of course lower than when new, and it is then said to be “low to paper.” 17.
- LOWER CASE.—The case which contains the small letters, points, and spaces—the lower of the pair of cases. 26.
- LUBRICATING.—The act of oiling any part of a press or machine. 181.
- LUBRICATORS.—Small glass globes placed on the shafting to lubricate the working parts of a machine. 207.
- LUG.—When rollers are tacky or stick together they are said to lug. 233.
- LYE.—The preparation used for cleansing type after printing. 181.
- LYE-JARS. 182.
- LYE-TROUGH.—The receptacle for holding lye. 182.
- MACHINE MINDER.—The skilled workman who is responsible for the care of a machine. 215.
- MACHINE PAPER.—Paper other than that made by hand. 248.
- MACHINE POINTS.—Special points which are used in the machine department, and distinct from press points. 232.
- MACHINE PRINTING. 212.
- MACHINES, care of. 213.
- classification of. 212.
- laying down. 213.
- MACKLE.—A printed sheet with a slurred appearance, owing to the frisket dragging, or a defect in the impression. 183.
- MAHOGANY composing stick.— Principally used for news-work. 30.
- MAKE EVEN.—In copy with long paragraphs, or in newspaper work, compositors have sometimes to finish their portions at the end of a line, in order to expedite the closing up of “takes.” They are then said to “make even.” 105.
- MAKING MARGIN.—To give the proper proportion of margin or furniture to a forme preparatory to imposition. 84.
- MAKING MEASURE.—To make the composing stick up to a given measure. 59.
- MAKING READY.—Preparing for printing by patching up or cutting away, etc. 174, 215, 229, 237.
- MAKING-UP into pages. 68.
- MALLET.—A wooden hammer with a large head used for locking-up formes. 40.
- MANUSCRIPT COPY. 63.
- MARGINAL NOTES.—Usually called side-notes; sometimes in-cut, or let into the matter at the side. 70.
- MARGINS, binder’s definition of. 84.
- printer’s definition of. 84.
- MARINONI LOCK-UP. 38.
- MARINONI MACHINE.—A French printing machine of rotary make, invented by a person of that name. 243.
- MARK.—This refers to the mark to which a sheet is laid in printing. 220.
- MARKS OF REFERENCE.—Signs of various kinds used for notes, such as * † ‥ ¶ Sometimes superior figures or letters are so used. 70.
- MATRICE (or MATRIX).—The copper mould with a punch struck in by which type is cast; also called “strikes.” 3.

- MATTER.**—Another term for composed type. 31.
- MEASURE.**—The given width of a page of type. Measures are generally made to pica ems, but sometimes in narrow or double-column matter an en is used in addition. 59.
- MEDIUM.**—A size of printing paper, 19 × 24 inches; writing, 22 × 17½ inches. 250.
- MELTING KETTLE.**—The utensil used for melting composition in making rollers. 161.
- METAL CORNERS** for rule-work. 99.
- METAL FURNITURE.**—Furniture cast in an alloy of poorer quality than type metal. 36.
- METAL GALLEY.**—Galleys generally made of zinc, but sometimes of brass, used for newspaper work mostly. 32.
- METAL RULE.**—A general term for em rules or dashes. Also applied to longer rules, such as two, three, or four ems. 8.
- MIDDLING SPACES.**—Spaces cast four to an em of any particular body. 21.
- MILL REAMS.**—Hand-made paper only 472 sheets to a ream; if all inside quires, 480. 250.
- MINERVA MACHINE.**—A small platen jobbing machine—the original “Cropper” machine. 216.
- MINION.**—A size of type one size larger than Emerald and one size smaller than Brevier. 19.
- MINNIKIN.**—A size of type smaller than Brilliant. 20.
- MISS.**—An omission to lay a sheet on by the feeder of a machine. 221.
- MIXTURE.**—An extra charge involved on composition if three or more types are used in a work.
- MODERN-FACE TYPE.**—Founts of recent date, the reverse of antique or old-faced types. 9.
- MONK.**—A black patch on a printed sheet caused through insufficient distribution or bad ink. 179.
- MOTIVE POWER.** 200.
- MOULDS** for type casting. 3.
- MOUSE ROLLER.**—A small additional roller for the better distribution of ink on a machine.
- MOVABLE.**—A general term applied to type to distinguish it from stereotype, etc. 1.
- MUSIC CASES.**—Special cases of a complicated character for composing type-music. 127.
- MUSIC, composition of.** 127.
- MUSIC DEMY.**—A printing paper, 20¾ × 14¾ inches. 253.
- MUSIC TYPE.**—Special type used in letterpress printing distinct from engraved plates. 129.
- N. P.**—An abbreviation for “new paragraph,” the commencement of a new line by means of indention. 93.
- NAKED FORME.**—A forme of type waiting for—or stripped of—furniture. 88.
- NARROW.**—Wooden furniture (sometimes of metal) three picas in width. 36.
- NECK OF A LETTER.**—Sloping part of a type from the shank to the face of the letter. 16.
- NEWS COMPOSING STICK.** 30.
- NEWS HANDS, qualifications for.** 105.
- NEWSPAPER CHASES.**—Specially made chases to allow of the pages being laid closely together on the machine. 41.
- NEWSPAPER WORK** in composition. 105.
- NICHOLSON'S MACHINE.**—This machine was devised by William Nicholson in the last

- century, and was the fore-runner of all subsequent machines. 213.
- NICK.**—The groove or grooves placed in the shank of a letter to assist composition, and to discriminate between different founts. 17.
- NIPPING PRESS.**—A small screw press for the more expeditious cold-pressing of jobs. 260.
- NOISELESS FORME CARRIAGE.**—A small trolley with india-rubber tyred wheels. 91.
- NONPAREIL.**—The size of a type one size larger than Pearl and one size smaller than Emerald—half of a Pica in depth of body. 19.
- NUMBERING or paging by mechanical aids.** 274.
- NUMERALS.**—Numbering by means of Roman numerals, i, ii, iii, iv, etc., instead of Arabic figures, 1, 2, 3, etc. 71.
- OCTAVO.**—A sheet of paper folded into eight—shortly written thus—Svo. 73.
- OCTODECIMO.**—A sheet folded into eighteen leaves. 73.
- OFF-CUT.**—That part of the sheet which has to be cut off in order that the sheet may be folded correctly, as in a “twelves.” 77.
- OFFICIAL ENVELOPES.**—Long narrow envelopes, $8\frac{3}{4} \times 3\frac{3}{4}$ inches, to take fcap. folio when folded in four—used in official circles.
- OFF ITS FEET.**—A term applied to type when it is not standing squarely on its feet. 72.
- OFF-SET.**—The set-off of ink from one sheet to another of printed work whilst wet. 182.
- OLD ENGLISH.**—Founts of type of black-letter character. 11.
- OLD FACE.**—Anything pertaining to the old or antique style. 9.
- OLD STYLE.**—Founts of revived antique type. 9.
- OPENING.**—When a compositor has copy in hand unfinished, and the next man in order awaits the closing-up.
- OTTO GAS ENGINE.**—Gas motor especially well adapted for driving printing machinery. 207.
- OUT OF REGISTER.**—When pages do not back one another line for line, or at head and foot, through bad gauging of pages or furniture. 178, 232.
- OUTER TYMPAN.**—The larger tympan, into which the inner one fits. 153.
- OUTSIDE REAMS.**—Reams of paper made up entirely of outside or damaged sheets. 250.
- OVERLAY.**—To make ready by overlaying—the reverse of underlaying. 185.
- OVERPLUS.**—The “plus” or “over” copies of a definite number in printing. 183.
- OVERRUN.**—To re-arrange or re-make-up matter after deletions or insertions. 92.
- OVERS.**—The “plus” copies beyond a certain number. 183.
- OXFORD CORNERS.**—Borders with mortised corners, thus
+ 99.
- PACKING of printed work.** 270.
- PAGE CORD.**—A particular kind of cord, about the thickness of twine, used for tying-up pages of type. 50.
- PAGE GAUGE.**—A piece of notched reglet used for making-up pages to a uniform length. 69.
- PAMPHLET.**—Any work which does not exceed five sheets, and is usually done up in a

- paper wrapper. An extra charge is involved in setting this class of work. 131.
- PAPER. 248.
- care of. 265.
 - drawing. 249.
 - equivalent weights of. 251, 253.
 - hand-made. 248.
 - printing. 249, 250.
 - relative weights of different reams. 252.
 - sizes of brown. 256.
 - sizes of letter and note. 256.
 - sizes of printing subdivided. 255.
 - table for giving out. 255.
 - writing. 249.
- PARAGON.—A size of type one size larger than Great Primer and one size smaller than Double Pica, equalling two Long Primers in depth. 20.
- PARCELLING up work. 272.
- PARDOE MACHINE.—A rotary machine adapted for newspaper work invented by Messrs. Pardoe and Davis. 245.
- PASTE-POINTS.—Very fine points—usually drawing-pins—used for very closely registered work on press. 177.
- PATCH UP.—To overlay or bring up an impression sheet with pieces of thin paper. 175.
- PEARL.—A size of type one size larger than Diamond and one size smaller than Ruby, equalling half a Long Primer in depth—the smallest type enumerated by Moxon. 19.
- PEARLASH.—Carbonate of potash when diluted is used as a wash for type. 181.
- PECTILIARS.—A general term for out-of-the-way sorts, *i.e.* accents, records, etc. 8, 67.
- PEDESTAL INKTABLE.—A small ink table on a single leg or pedestal. 157.
- PEEL.—A wooden implement used for hanging up printed sheets for drying. 268.
- PEELING.—A process of preparing overlays by skivering or thinning down the hard edges of an illustration. 186.
- PERFECT PAPER.—Reams of paper made up to a printer's ream, *i.e.* 516 sheets, are said to be "perfect." 249.
- PERFECT UP.—This is the printing of the second side of the paper in half-sheet or sheet work. 178.
- PERFECTING MACHINE.—A double cylindrical machine which prints both sides of the sheet at one operation. 235.
- PERFORATING. 274.
- PICA.—A size of type one size larger than Small Pica and one size smaller than English—the body usually taken as a standard for leads, width of measures, etc.—it is equal to two Nonpareils in body. 19.
- PICKS.—A speck or blur caused by dirt or badly distributed ink on the face of a letter. 199.
- PIE.—Type broken or indiscriminately mixed. 67.
- PIGEON HOLES.—A slang expression used by compositors for wide and bad spacing, on account of the amount of white between the words.
- PINCHED POST.—A size of writing paper, small post, $18\frac{1}{2} \times 14\frac{3}{4}$ inches. 254.
- PIN MARK.—The slight mark in the side of a type near the top of the shank made in casting by machinery. 5.
- PIT.—The hollow cavity in the floor under a machine for accessibility to the under parts. It is sometimes also neces-

- sary for the steady working of a machine. 213.
- PITCH.—Placing the forme on a machine to a given position, in order that the type will be printed in a correct position on the sheet. 229.
- PLANER.—A flat smooth piece of wood used for levelling the type before locking-up. 40.
- PLATE PRINTING.—Intaglio printing—the reverse of relief. 1.
- PLATEN JOBBING MACHINES.—Worked by either steam or foot. 216.
- PLATEN MACHINE.—Printing machines which have a flat impression—not a cylindrical one. 222.
- PLUS.—Over copies to any given number in printing off. 183.
- POINT HOLES.—The punctures made in the sheets by the pins or spurs of the points. 177.
- POINT SCREWS.—Screws for fastening the points on the tympan. 177.
- POINTS.—Long thin pieces of iron with a pin or spur at the end, used for insuring the correct register of the sheets in perfecting. 1, 177.
- elbow (twelvemo). 177.
- fixing on press. 176.
- octavo. 177.
- paste. 117.
- POLES for drying printed work. 268.
- POST.—A size of printing paper, 20 × 16 inches. 250.
- POSTER STICK.—A long wooden composing stick. 30.
- POTT.—A size of writing or printing paper, 15 × 12½ inches. 250.
- PRELIMINARY.—Any matter coming before the main text of a work—title, preface, contents, etc. 70.
- PRESS PROOF.—The final proof passed by the author or publisher “for press.” 143.
- PRESS, working at. 180.
- PRESSES, classification of. 152.
- PRESSING BOARDS.—The glazed boards used for pressing printed sheets. 260.
- PRESSMEN.—The skilled workmen who manipulate hand-presses. 145.
- PRESSWORK.—Printing by hand presses. 145.
- prices of. 199.
- some hints on. 197.
- PRIMA.—In reading a work sheet by sheet the first word of the ensuing signature is marked by the reader as the “prima.” 142.
- PRINTERS’ DEVIL.—A term generally applied to the junior apprentice in a printing office.
- PRINTERS’ REAM.—A perfect ream of 516 sheets. 183, 249.
- PRINTING of cuts. 183.
- on glazed surfaces. 198.
- PROCESS BLOCKS.—Illustrations in relief produced by any mechanical process. 187.
- PROOF READER.—A general term for the “corrector of the press.” 141.
- PROOFS, clean.—Pulls after correction—distinct from “first proofs.” 96.
- PUBLISHER’S BINDING.—Cloth case work. 273.
- PUNCHES.—The small steel dies used for punching into the matrice. 3.
- PUNCTUATION MARKS, spacing of. 61.
- QUADRATS.—Large metal spaces of various sizes for filling up short lines, etc. 21.
- QUARTO.—A size given when a sheet is folded into four leaves—written shortly, 4to. 73.

- QUIRE.**—Sections of a ream of paper, consisting of twenty-four sheets. 249.
- QUIRED PAPER.**—Reams of paper folded in quires—not sent in “flat.” 249.
- QUIREWISE.**—Jobs of single leaves printed on both sides of the paper, *i.e.*, as first and third pages. This allows of “sewing” instead of “stabbing.”
- QUOINS.**—Small wedges of various sizes, usually of wood, used for tightening or locking-up formes. 37.
- fitting of. 89.
- QUOTATIONS.**—Large quadrats, generally of four-line pica and cast hollow, used for making up blanks and short pages.
- RACKS.**—Receptacles for holding cases, boards, etc. 45.
- RAG.**—The bur sometimes left on type by the founder used to be thus called.
- RANDOM.**—A special frame used by compositors in making-up and for putting standing lines and heads on. 26.
- READER.**—The responsible person who compares and reads the proof by copy, and who revises corrections made by an author or editor. Also called “corrector of the press.” 141.
- READERS' MARKS,** synopsis of. 93.
- READING.** 141.
- READING BOYS,** selection of. 143.
- REAM.**—Paper in parcels or bundles of a certain size—a printer's ream being 516 sheets. Hand-made and drawing papers slightly differ in the number of sheets, sometimes 472, 480, or 500. 249.
- RECTO.**—The right-hand pages of any work.
- RED INK,** printing electros with. 189.
- REEL OF PAPER.**—The paper made in continuous lengths used for rotary printing machines. 251.
- REFERENCE MARKS.**—Used for notes, such as * + ‡ § || ¶. Sometimes figures or letters are used. 70.
- REGISTER.**—The exact adjustment of pages back to back in printing the second side of a sheet. 36, 178, 191, 232.
- REGLET.**—Thin wooden furniture up to Two-line Great Primer generally comes under the head of “reglet.” 35.
- REITERATION.**—The second side of a sheet in printing. 178.
- RELATIVE WEIGHTS.**—The difference in weight of any reams between printing, writing, or drawing papers. 252.
- RELIEF PRINTING.**—Letterpress and block printing comes under the head of “relief,” as distinct from lithography or plate printing. 1.
- REMOVES.**—The difference between one size of type and another is expressed by this term. 70.
- RETREE.**—The outside, rejected, or damaged paper of different reams, marked thus × × in invoicing. 250.
- RIGGERS.**—Wheels attached to shafting for transmitting driving power to a machine. 205.
- RISE.**—A forme is said to rise when it springs through bad locking-up and the type gets off its feet. The term is also used when quadrats and furniture black in printing through imperfect justification. 90.
- RISERS.**—Wooden or metal blocks for mounting stereo and other plates. 194.

- ROLLER composition, recipes for. 160.
- kettle. 161.
- flaring a. 165.
- ROLLER FORKS.—Iron receptacles to hold the spindles of the rollers. 228.
- ROLLER FRAME.—Made of iron and used for press rollers. 158.
- ROLLER MOULDS.—Apparatus of various sizes in which rollers are cast. 161.
- lubricating. 163.
- ROLLERS.—Made of a composition, and used for applying ink to the type. 158.
- arched. 165.
- casting of. 163.
- cooling of. 165.
- cracked or cut. 166.
- damp or greasy. 166.
- difficult. 167.
- drying or warming. 167.
- facts about. 164.
- good wearing. 164.
- keeping of. 168.
- making of. 161.
- out of use. 165.
- preserving of. 167.
- treatment of old. 164.
- too new. 167.
- washing of. 165.
- warming of. 166.
- ROLLING AT PRESS. 180.
- ROMAN.—The particular kind of type in which book and other work is composed (such as this fount), as distinguished from *italic* or fancy types. Called “antiqua” by the Germans. 7.
- ROTARY MACHINES. 239.
- ROTTEN.—Term applied to an unsound impression in printing. 185.
- ROYAL.—A size of printing paper, 25 × 20 inches; writing paper, 24 × 19 inches. 250.
- RUBRICATED LETTERS.—Capital letters printed in red ink. 102.
- RUBY.—A size of type one size larger than Pearl and one size smaller than Nonpareil, equal to half a Small Pica in body. 19.
- RULE BORDERS.—Made of brass or other metal, to form a frame or line round a page. 99.
- RULE CASE.—Trays for holding brass rule of the usual size of type cases. 35.
- RULE CUTTER.—An apparatus for cutting brass rule into short lengths. 49.
- RULING.—Such as is used for account books. 274.
- RUNNERS.—Figures or letters placed down the length of a page to indicate the particular number or position of any given line. 69.
- RUN-ON.—A sentence continued in same line, not a distinct paragraph. 68.
- SAW BLOCK.—Block of wood in which slots are cut, used for sawing up furniture on. 36.
- SCABBY.—A term applied to uneven and rotten colour in printing. 185.
- SCALE-BOARD.—Very thin strips of wooden furniture used for obtaining close register in printing. 36.
- SCANDINAVIAN.—A printing machine with single cylinder, introduced many years ago into this country by the inventor—a Scandinavian. 222.
- SCREW CHASES.—Chases mostly used for newspaper work, fitted with screws to obviate the use of wooden quoins. 38.
- SCREW COMPOSING STICK.—The old-fashioned composing stick is fastened up by means of a

- screw with a slotted head. 30.
- SERIF.—The fine lines on the top and bottom of a letter, thus H. 16.
- SET.—A recognized term for “composed”—to “set” type is to “compose” it. 31.
- SET OFF.—When the ink off-sets from one sheet to another. 237.
- SET-OFF PAPERS.—Special papers used to reduce the set-off in printing. Oil, turpentine, or glycerine may be applied to the sheets for this purpose. 182.
- SETTING RULES.—Brass rules used in setting type and shifted line by line as finished. 30.
- SEWING.—Used for book-work, and distinct from “stitching” or “stabbing.” 272.
- SHAFTING.—Revolving turned-iron pole suspended horizontally to convey the driving power to the machines. 205.
- SHAKE.—A slur on a printed sheet through some defect in the impression. 182.
- SHANK.—The body of the letter or type. 16.
- SHEARS.—The ordinary implements used for cutting short lengths of brass or leads. 52.
- SHEEPSFOOT.—An iron hammer with a claw at the foot. 157.
- SHOOTING STICK.—The implement—generally made of box-wood, but sometimes of metal used with the mallet in locking-up formes. 40.
- SHORT CROSS.—The shorter and wider of the two cross-bars in any chase. 42.
- SHORTS.—A term applied to letters with the “short” accent over them, thus \tilde{a} \tilde{c} \tilde{i} \tilde{o} \tilde{u} . Also applied to copies printed off short of the number required. 9, 183.
- SHOULDER NOTES.—Marginal notes placed at the top corner of the page.
- SHOULDER OF TYPE.—The flat top of the shank of a type from whence the bevel to the face starts. 16.
- SIDE-NOTES.—Marginal notes as distinct from “foot-notes.” 69, 70.
- SIDE-STICKS.— *See* “Foot-sticks.” 37.
- SIGNATURE.—The letter or figure in the white line of the first page of a sheet, to guide binder in folding—also used by printers to identify any particular sheet. 72.
- SIGNATURES AND FOLIOS, table of. 74.
- SIGNS. 9.
- SINGLE CYLINDER machine, system of inking. 225.
- SIXTEENMO.—A sheet folded into sixteen leaves—written shortly, 16mo. 73.
- SKELETON FORME.—A special forme—usually of a broken and open nature—made up for a subsequent printing in another colour of ink. 102, 189.
- SLICE.—A flat wide iron knife used for lifting ink out of the can. 157.
- SLURRING.—A defective impression, having a doubled or mackled appearance. 183, 232.
- SMALL CAPITALS.—The smaller capitals laid in the upper case, distinct from the full capitals, thus—PRINTING, and indicated in MS. by two lines = underneath. 63.
- SMALL CARDS.—A size of card, $3\frac{1}{2} \times 2\frac{1}{2}$ inches. 257.
- SMALL PICA.—A size of type one size larger than Long Primer and one size smaller

- than Pica, equal to half the body of a Double Pica. 19.
- SMALL POST.**—A size of writing paper, $19 \times 15\frac{1}{4}$ inches. 254.
- SOFT SIZED PAPER.**—Special printing paper manufactured with a very little admixture of size. 249.
- SOFT TINTS.**—The lighter parts of an illustration. 185.
- SOLID MATTER.**—Type composed without leads; also applied to type with but few quadrats in. 31.
- SOLIDS.**—The blacker or more solid parts of a woodcut or other illustration. 185.
- SORTS.**—The general term applied to any particular letter or letters as distinguished from a complete fount. 21.
- SPACE BOX.**—A small tray with six or eight divisions—a handy substitute for the “space barge.” 91.
- SPACES.**—Metal blanks cast to different thicknesses of their own bodies for placing between words and filling up lines. 21.
- SPACING,** rules for, 58.
- SPEED RIGGERS.**—Riggers graduated to allow of the driving band being shifted to increase or reduce running power. 228.
- SPLIT RIGGER.**—Riggers made in two equal portions and screwed together in order to facilitate shifting or changing.
- SPOILAGE.**—Applied to the sheets spoilt in printing, sometimes called “waste.” 183.
- SPRING GUIDE** for cutting machine. 263.
- SPRING POINTS.**—These are a special kind of press points which assist in throwing the sheet off the spur of the point as printed. 177.
- SPUR.**—The short pin at the end of the point which pricks the hole in the sheet for registering purposes. 177.
- SQUABBLE.**—To break or upset type and thus make “pie” of it.
- STABBING.**—A reprehensible method of fastening leaves together. 272.
- STACKING** of printed work. 269.
- STANHOPE PRESS.**—The first iron printing press made. 146.
- STAPLE OF PRESS.**—The frame or uprights of a hand printing press.
- STEAM POWER.** 200.
- STEREOTYPE BLOCKS.** 194.
- STEREOTYPE PLATES,** mounting of. 194, 195.
- STEREOTYPE WORK.** 194.
- STITCHING.**—Used for pamphlet work. 272.
- STOCK,** keeping of. 271.
- STONES,** imposing.—Generally, in these days of iron, called “surfaces.” 43.
- STRIKER.**—The apparatus attached to a machine for “striking on,” or putting it in motion.
- STRIKES.**—A term for type matrices struck from the original punches. 3.
- STROKER.**—A small implement, generally made of wood and tipped with metal, for laying on or “stroking in” sheets in a printing machine. 237.
- SUPERIOR FIGURES.**—Small figures cast on the shoulder of type, generally used for footnote reference, thus—¹ ² ³. 70.
- SUPERIOR LETTERS.**—Small letters cast at the top of the shoulder of type, used for references or abbreviations, as Mr, N^o, etc. 70.
- SUPER ROYAL.**—A size of printing paper, $27\frac{1}{2} \times 20\frac{1}{2}$ inches; writing, 27×19 inches. 250.
- SWASH LETTERS.**—Seventeenth

- century italic capitals with tails and flourishes, thus—*A B D M N* etc. 11.
- TABLE ENGINE.**—A small steam engine. 205.
- TABLE WORK.**—Matter of four or more columns, which reckons as double composition in casting-up. 130, 133.
- TABULAR WORK.**—Three-column matter, which reckons a quarter or half extra in value of composition according to its nature. 130, 133.
- TACKY.**—Rollers to be in proper condition ought to be “taeky,” that is, should be slightly adhesive to the touch. 162.
- TAKE.**—Each portion of copy falling to the share of a compositor. 105.
- TAKER OFF.**—The person, usually a lad, who receives the sheets as printed off, and places them on the heap. 222.
- THICK SPACES.**—Spaces cast three to an em of their own particular body. 21.
- THIN FOUNT.**—When the lower-case letters a to z come within a certain limit, it is so reckoned. 16.
- THIN SPACES.**—Spaces cast five to an em of their own particular body. 21.
- THORNE COMPOSING MACHINE.** 108.
- THREE-QUARTER COMPOSING FRAME.** 25.
- THROW-OFF IMPRESSION.**—An apparatus attached to a machine for throwing off the impression whilst running. 221.
- THUMB LEVER COMPOSING STICK.**—A composing stick fastened by means of a small lever, instead of the screw with slotted head. 30.
- THUMB SCREW COMPOSING**
- STICK.**—A composing stick fastened with a thumb screw, instead of the usual screw with slotted head, and distinct from the “thumb lever.” 30.
- TILLS.**—The cell-like divisions on the top side of the platen of a hand printing press.
- TINT BLOCKS.**—Blocks or surfaces used for printing coloured backgrounds. 103.
- TOKEN.**—Two hundred and fifty impressions are reckoned as a token. 199.
- TOMMY.**—An iron implement for tightening up screws. It has a hole through the head instead of a slot. 227.
- TRANSPOSE.**—To shift words, lines, leads, or any portion of matter. 93.
- TRAYS** for wooden types. 97.
- TREADLE MACHINE.**—Small machines worked by the foot, as distinct from those driven by any other power. 216.
- TREBLE CASES.**—Special upper cases made to hold three sets of capitals. 27.
- TURNED SORTS.**—When a particular letter becomes scarce, another letter is temporarily substituted with its nick reversed.
- TURNSCREW.**—A small flat piece of steel for fastening or unfastening the screws of composing sticks.
- TWEEZERS.**—Used for correcting tabular matter. 51.
- TWELVEMO.**—A sheet of paper folded into twelve leaves, written thus—12mo. Also called “duodecimo.” 73.
- TWENTY-FOURMO.**—A sheet folded into twenty-four leaves, written thus—24mo. 73.
- TWO-COLUMN.**—Matter arranged in double columns. 133.
- TWO-FEEDER MACHINES.**—Ma-

- chines adapted for two distinct layings-on. 213.
- TWO-LINE LETTERS.**—Plain initial letters the depth of two lines, used at the commencement of a chapter or work.
- TYING-UP** a page. 71.
- TYMPAN.**—The frame, usually covered with parchment, on which the sheet is placed in printing at press. 153, 172.
- TYPE**, a square inch of. 22.
- cleaning of. 181.
- complete fount of. 8.
- print of reversed. 56.
- production of. 3.
- selection of. 7.
- to find the weight of. 22.
- TYPE BODIES**, American principle of. 18.
- at a glance. 23.
- relation of. 20.
- TYPE CASES.** 26.
- TYPE-CASTING** machines. 5.
- TYPE-FOUNDERS**, leading. 18.
- TYPE-HIGH.**—Anything the height of type. 17.
- TYPE MEASURE.**—Scales of wood or ivory used for measuring type. 88.
- TYPE-METAL**, component parts of. 5.
- TYPE MUSIC.**—Music printed from movable type, as distinct from plate or engraved music. 127.
- TYPES.** 1.
- comparative sizes of. 20.
- sizes of. 19.
- TYPOGRAPHY.**—The art of printing from movable letters. 1.
- UNDERLAID FORMES.** 102, 189.
- UNDERLAY.**—The process of making-ready under type or cuts—as distinct from “overlay.” 174.
- UNIVERSAL forme rack.**—A receptacle for holding formes of various sizes. 44.
- UNIVERSAL MACHINE.**—A jobbing platen machine—for steam or treadle—manufactured by Messrs. Hopkinson and Cope. 221.
- UNLOCK.**—To unfasten a forme with mallet and shooting stick. 91.
- UNSIZED PAPER.**—Paper made entirely without size, and consequently very absorbent and adapted for plate printing. 248.
- UPPER CASE.**—The top or upper one of the pair of cases. 26.
- VERSO.**—The left-hand pages of any work.
- VERTICAL ENGINE.**—An upright engine, as distinct from a “horizontal” one. 205.
- VIBRATOR ROLLERS.**—Those rollers on a machine which have a vibrating motion, and convey the ink to the slab for distribution. 227.
- VICTORY** rotary machine. 241.
- WALL BOX.**—A receptacle cut into the wall for fixing shafting. 206.
- WARD'S LOCK-UP.** 38.
- WAREHOUSE.**—The department responsible for printed work and “white” paper. 248.
- WAREHOUSEMAN.**—The workman in charge of the warehouse department in a printing office. 249.
- WASTE.**—Surplus sheets of a book beyond the plus copies. Also spoil sheets used for running up colour on a machine, etc. 183.
- WATER-POWER.** 210.
- WAVER ROLLERS.**—Rollers which distribute ink on the ink table in a diagonal direction. 227.

- WAVY RULE.**—Brass rule made with an undulating face, thus
~~~~~ 34.
- WEB MACHINES.**—Cylindrical printing machines in which the paper is laid on by tapes. 235.
- WETTING BOARDS.**—The boards placed between the different reams in the press in the wetting department. 265.
- WETTING DOWN.** 265.
- WETTING TROUGH.**—The receptacle for water used in wetting down paper. 266.
- WHARFEDALE MACHINE.**—A cylindrical machine manufactured in Yorkshire and called after the place of that name. 225.
- WHITEFRIARS MACHINE.**—A newspaper machine of rotary make invented by Messrs. Pardoe and Davis. 245.
- WHITE LINE.**—A line of quadrats at the bottom of a page. Also a full blank line of text body when used in a page. 69.
- WHITE OUT.**—To space or “branch out” any composed matter, such as displayed or advertisement work.
- WHITE PAPER.**—A general term used for unprinted work—whether white or coloured paper. 248.
- WHOLE FRAME.**—A stand made to hold two pairs of cases, with a case rack attached. 24.
- WIPE.**—This is when the rollers catch or deposit an excess of ink on the edge of a forme in printing. 232.
- WOOD FURNITURE.**—Furniture made of wood—distinct from “metal” or “French” furniture. 36.
- WOOD-LETTER.**—Large types are cut on wood when they reach eight or nine picas in body. 21.  
— preserving of. 97.
- WOODCUT PAPER.**—A half-plate or rather soft printing paper specially adapted for printing woodcuts and other illustrations. 187.
- WOODCUT PRINTING.** 183, 187.
- WOODCUTS,** preserving of. 97.  
— printing of heavy. 187.  
— the care of. 184.
- WORK-BOOK** for reading department. 143.
- WORKS OF REFERENCE** for reading department. 144.
- WOVE PAPERS.**—Papers which do not exhibit wire-marks caused in making—distinct from “laid” papers. 249.
- WRONG FOUNT.**—Letters of a different character or series mixed with another fount, although perhaps of the same body. 93.
- WROUGHT IRON CHASES.**—Chases made of wrought iron—distinct from “cast iron.” 42.
- YELLOW WOVE.**—A cheap kind of coloured wove paper, but, anomalously, blue in shade.
- ZINC GALLEYS.**—Receptacles on which type is placed, used for slip and newspaper work. 32.
- ZINCOGRAPHY.**—The art of producing engravings on zinc by a mechanical process. 187.

BY THE SAME AUTHOR.

*Crown 8vo, cloth, price 3s. 6d. each (by post, 3d. extra each vol.).*

## The Printers' Vocabulary

A Collection of some 2,500 Technical Terms, Phrases, Abbreviations, and other expressions, mostly relating to Letterpress Printing, many of which have been in use since the time of Caxton. Including specimen page of marks and signs used by Correctors of the Press, and sizes of types graduated and named. Useful book for Authors and Publishers, as the work contains many bibliographical references.

## The Printers' Handbook

Of Trade Recipes, Hints and Suggestions relating to Letterpress and Lithographic Printing, Bookbinding, Stationery, Engraving, etc., etc. With many useful Tables and an Index.

*Both books have been very favourably reviewed by the whole of the technical press.*

LONDON: CHISWICK PRESS, TOOKS COURT, CHANCERY LANE.

# Messrs. BELLS' BOOKS for CHESS PLAYERS.

**CHESS.** By ROBERT F. GREEN, Editor of the "British Chess Magazine." *With Illustrations.* 1s. [The Club Series.]

**CHESS PROBLEMS.** A Collection of Two-Move Problems. By B. G. LAWS. 1s. *Preparing.* [The Club Series.]

**MORGAN'S NEW TELEGRAPHIC CHESS CODE,** for transmitting Two Moves of a Game by One Word. Containing full Explanation of the System, Diagrams, &c., together with a Complete List of Code Words necessary for any Two Combinations possible in a game of Chess. Crown 8vo. 7s. 6d.

By this method single games can be transmitted at the minimum of cost; or ten or more games may be played between clubs in distant towns, at a less expense than is now entailed for the railway fares of the visiting team.

A NEW EDITION OF "HORWITZ AND KLING."

**CHESS STUDIES AND END GAMES.** In Two Parts:— Part I. CHESS STUDIES. Part II. MISCELLANEOUS END GAMES. By E. HORWITZ and J. KLING. Second Edition, Revised by the Rev. W. WAYTE, M.A., late Fellow of King's College, Cambridge. Demy 8vo. 7s. 6d.

"One of the most valuable and interesting books which a chess-player can have upon his shelves."—*Saturday Review.*

**STAUNTON'S CHESS PLAYER'S HANDBOOK.** A Popular and Scientific Introduction to the Game of Chess, as exemplified in Games actually played by the greatest masters, and Illustrated by numerous Diagrams of original and remarkable positions, and a Coloured Frontispiece. Small post 8vo. 5s.

**STAUNTON'S CHESS PRAXIS.** A Supplement to the Chess Player's Handbook. Containing important improvements in the Openings, Illustrated by actual Games; a Code of Chess Laws; and a Selection of Mr. Morphy's Games in England and France, critically Annotated. 636 pages. *With Diagrams.* Small post 8vo. 5s.

**STAUNTON'S CHESS PLAYER'S COMPANION.** Comprising a Treatise on Odds, Collection of Match Games, including the great French Match with Mons. St. Amant, and a Selection of Original Problems. *With Diagrams and Coloured Frontispiece.* Small post 8vo. 5s.

**MORPHY'S GAMES OF CHESS.** Being the Matches and best Games played by the American Champion, with Explanatory and Analytical Notes by J. LÖWENTHAL. With short Memoir and Portrait of Morphy. Small post 8vo. 5s.

This volume contains by far the largest collection of games played by Mr. Morphy extant in any form, and has received his endorsement and co-operation.

LONDON: GEORGE BELL & SONS, YORK STREET,  
COVENT GARDEN.

# Messrs. BELLS' BOOKS for REFERENCE.

*The only Authorized and Unabridged Editions.*

**WEBSTER'S GUINEA DICTIONARY OF THE ENGLISH LANGUAGE.** Including Scientific, Technical, and Biblical Words and Terms, with their Significations, Pronunciations, Alternative Spellings, Derivations, Synonyms, and numerous Illustrative Questions. *With Supplement of over 4,600 New Words and Meanings.* 1 vol. of 1,628 pages with 3,000 Illustrations. 4to. cloth, 21s. ; half calf, 30s. ; calf or half russia, 31s. 6d. ; russia, £2.

**THE COMPLETE DICTIONARY.** Containing various valuable Literary Appendices, and 70 extra pages of Illustrations grouped and classified, rendering the work a COMPLETE LITERARY AND SCIENTIFIC REFERENCE BOOK. *New Edition, with New Biographical Appendix, containing over 9,700 Names.* 1 vol. (1,919 pages). 4to. Cloth, 31s. 6d. ; half calf, £2 ; calf or half russia, £2 2s. ; russia, £2 10s.

"Certainly the best practical English Dictionary extant."—*Quarterly Review*. Oct. 1873.

**THE QUEEN'S ENGLISH.** A Manual of Idiom and Usage. By the late DEAN ALFORD. *Sixth Edition.* Fcap. 8vo. Paper, 1s. ; cloth, 1s. 6d.

**A BIOGRAPHICAL DICTIONARY.** Containing Concise Notices (upwards of 15,000) of Eminent Persons of all Ages and Countries, and more particularly of distinguished Natives of Great Britain and Ireland. By THOMPSON COOPER, F.S.A. With a Supplement, bringing the work down to 1833. 2 vols. 5s. each.

**BOHN'S DICTIONARY OF POETICAL QUOTATIONS.** *Fourth Edition.* 6s.

**GASC'S MODERN POCKET DICTIONARY OF THE FRENCH AND ENGLISH LANGUAGES.** *Forty-fifth Thousand, with Additions and Corrections.* 16mo. Cloth, 2s. 6d.

**GASC'S DICTIONARY OF THE FRENCH AND ENGLISH LANGUAGES.** With more than 15,000 New Words, Senses, etc. *Fourth Edition, Revised and Enlarged, with New Supplement.* 1 vol. 10s. 6d.

**FLÜGEL'S COMPLETE DICTIONARY OF THE GERMAN AND ENGLISH LANGUAGES.** By C. A. FEILING, A. HEIMANN, and J. OXENFORD. *New Edition.* 2 vols. 8vo. £1 1s.

**FLÜGEL'S ABRIDGED GERMAN-ENGLISH AND ENGLISH-GERMAN DICTIONARY.** Carefully compiled from the larger Dictionary. By C. A. FEILING and J. OXENFORD. *New Edition.* Royal 18mo. 6s.

*Published Annually. Cloth, gilt top, 10s. 6d.*

**DOD'S PEERAGE, BARONETAGE, AND KNIGHTAGE OF GREAT BRITAIN AND IRELAND.** Including all the Titled Classes.

*Neatly bound, gilt edges, 4s. 6d.*

**DOD'S PARLIAMENTARY COMPANION.** Published Annually.

"'Dod' is extremely accurate and satisfactory."—*Times*.

LONDON : GEORGE BELL & SONS, YORK STREET,  
COVENT GARDEN.

219 MILL.

JAMES WRIGLEY AND SON  
(LIMITED),

**Paper Manufacturers,**

BRIDGE HALL MILLS, BURY,  
LANCASHIRE.

---

*WAREHOUSES:*

LONDON :—21, BUDGE ROW, E.C.

MANCHESTER :—29, JOHN DALTON STREET.



Superfine and Fine Printings, and all other grades.

Lithographic and Plate-Glazed Printings.

Tinted Writings, Laid and Wove.

Cheque Papers, Plain, Lettered, and " Safety."

White and Tinted Ivory Boards.

Map and Drawing Papers, Cartridges, and  
Blottings.

Antique Etching Paper and Printings.

News, all qualities in Reams or in Web.

Superfine and Fine Laid and Wove Writings, and  
cheaper grades.

Super Calendered Papers.

Super Vellum, Laid and Wove.



**Printing Machine, Press, Type, Material, Wood  
Letter, and Composition Roller  
Manufactory.**

Fredk. Ullmer, 1825.  
Ullmer and Watts, 1845.



Established Upwards of  
Half a Century.

**FREDK. ULLMER,**  
MANUFACTURER OF MACHINERY AND MATERIALS  
OF EVERY DESCRIPTION FOR  
**PRINTERS, LITHOGRAPHERS,  
AND BOOKBINDERS.**

“ Standard ” Works,  
CROSS STREET, FARRINGTON RD., LONDON, E.C.  
*(Near the Farringdon Station of the Metropolitan Railway).*

**FREDK. ULLMER'S “STANDARD CIRCULAR,”**

Published quarterly, contains Specimens of the Latest Novelties in Type, Borders, Ornaments, etc., both English and American; list of New Machinery, Presses, and Materials for Printers and Bookbinders; Trade Notes, etc.; List of Second-hand articles on sale.

The above is *Posted Free* in the United Kingdom. A copy will be sent on receipt of Business Card.

No. 17, now published, printed on a Demy “Standard” Cylinder Machine, with “Standard” Composition Rollers.

FREDK. ULLMER has the Sole Agency in Great Britain for the supply of—

**TYPE, BORDERS, AND NOVELTIES,**  
From the Best American Foundries.

THE MOST USEFUL FACES ARE KEPT IN STOCK.

ILLUSTRATED PRICE LIST OF NEW MACHINERY AND MATERIAL.  
CATALOGUE OF SECOND-HAND FOUNTS. Priced. Contains some very excellent founts of Book, Jobbing Fancy Type, etc.

SPECIMEN BOOK OF NEW TYPES. Embracing the Modern Faces, with Weights and Prices to each fount.

LIST OF SECOND-HAND MACHINERY, PRESSES, MATERIALS, etc.

Valuer to the Trade.

---

*Registered Telegraphic Address:—“COMPOSITION, LONDON.”*

# SPALDING & HODGE, WHOLESALE STATIONERS.

---

**SUPERFINE AND FINE PRINTINGS,  
TUB AND ENGINE-SIZED WRITINGS,  
PLATE AND CARTRIDGE PAPERS,  
ETC.**

---

Messrs. SPALDING AND HODGE keep in Stock, at their  
Warehouses in Drury Lane, a large and varied assortment of—

*WHITE AND TONED PRINTINGS of all Qualities.*

*LITHOGRAPHIC PRINTINGS.*

*HAND-MADE PRINTINGS, for "Editions de Luxe."*

*COLOURED PRINTINGS.*

*FINE AND ORDINARY NEWS.*

*HAND AND MACHINE-MADE WRITINGS.*

*HAND-MADE PAPER FOR PRINTING ETCHINGS (specially prepared for  
the purpose, and giving unequalled brilliancy and depth of tone).*

*MACHINE-MADE ETCHING PAPERS.*

*CARTRIDGES, BROWNS, SMALL HANDS, TISSUES, ETC.*

---

**PRICES AND SAMPLES ON APPLICATION.**

OFFICES AND WAREHOUSES:

LONDON:—145-147, DRURY LANE, AND  
8-11, GREAT WILD STREET, W.C.

ESTABLISHED A.D. 1809.

---

# HARRILD AND SONS,

PRINTERS' & BOOKBINDERS' ENGINEERS,

MAKERS OF THE

SINGLE AND TWO-FEEDER, TWO-COLOUR,  
TREADLE PLATEN, AND CHROMO-LITHO.

REGISTERED "BREMNER" MACHINES.

---

THE "FLEET" PRINTING MACHINES.

---

Ruling, Paging, and Perforating Machines.  
Newspaper and Magazine Folding Machines.

---

PRINTERS' ROLLERS AND  
ROLLER COMPOSITION.

---

TYPE CASES, COMPOSING FRAMES,  
CASE, FORME, AND WOOD-LETTER RACKS.

---

WROUGHT AND CAST IRON CHASES.

---

Stereo and Electro Foundries. Patent Type-high  
Adjustable Stereo Cores and Core Bars.

Furniture Moulds and Stereo.

Sundries.

---

"FLEET" WORKS, 25, FARRINGDON STREET, LONDON, E.C.

# GROSVENOR, CHATER & CO. LIMITED

PAPER MAKERS, AND WHOLESALE

AND EXPORT STATIONERS,

68, CANNON STREET, LONDON, E.C., AND

6, RUE FAVART, PARIS.

---

AGENTS FOR DUTCH HAND-MADE PRINTING  
PAPERS.

*Printing, Writing, Drawing, Blotting,  
Packing, and all other Papers.*

WHATMAN'S, JOYNSON'S, AND TURKEY MILL  
PAPERS.

---

WORKS :

ABBAY MILLS, HOLYWELL, FLINTSHIRE.

---

AUSTRALIAN REPRESENTATIVE :—H. M. COLLINS,

*c/o Reuter's Telegraph Company, Melbourne.*



SHACKELL, EDWARDS & CO.,

PRINTING INK AND VARNISH  
MANUFACTURERS,

5, RED LION PASSAGE, FLEET STREET,  
LONDON, E.C.

MAKERS OF GENUINE  
DENSE BLACK LITHO AND LETTERPRESS PRINTING INKS.

---

Special Ink for Rotary Cut Machines.

Special Ink for Newspaper Printing.

Special Ink for Very Thin Paper.

Fine Blue-Black Ink for Woodcuts.

COLOURED INKS OF EVERY SHADE IN STOCK.

*Prices and Samples sent Free on Application.*

---

Upwards of 100 YEARS' experience. Established 1786.

---

FIRST ORDER OF MERIT AND MEDAL AWARDED AT  
CENTENNIAL INTERNATIONAL EXHIBITION,  
MELBOURNE, 1888.

---

*Agent for Australia:—*

**F. W. ALLISON,**  
418, CHANCERY LANE, MELBOURNE.

Stanhope Foundry.

# KNIGHT & HAWKES,

ESTABLISHED OVER 60 YEARS,

13, CLERKENWELL CLOSE, LONDON, E.C.

## ELECTROTYPERS AND STEREOTYPERS.

*Honourable Mention awarded at the Exhibition of Works of Industry of all Nations, 1851.*

**E**LECTROTYPE or Stereotype Plates by the *Plaster* and Patent process of Book-work, Daily, Weekly, or Monthly Publications. Newspaper type-high, and Wood-Cuts, Tints, Zincotype Blocks. Graining Plates from Leather Skins, and Electrotypes of Type for Bookbinders' Letterings. Engravers' Surface Metal, etc. Plates Nickel-faced for Colour Printing.

---

## PHOTO-ETCHING, PHOTO-LITHOGRAPHY, AND PHOTO-GRAVURE PROCESSES.

**M**ESSRS. KNIGHT AND HAWKES undertake the production of Zinco-engraving Process Blocks for Letterpress Printing. These are reproduced, reduced, or enlarged from all kinds of originals or from Nature, Engravings, Printed Matter, Pen and Ink Drawings, Wash Drawings, Photographs, Drawings on Stone or Transfer Paper, Maps, Music, Lace, Copper or Steel Plates, Bookbinders' Blocks.

Photo-Litho Transfers supplied.

Printers and others in town or country requiring Electrotypes, Stereotypes, or Zinco-engraved Blocks of any description attended to promptly in the best style, and may rely on all orders having the personal attention of the principals.

Zinco Blocks produced at all times, our Studio being fitted up with powerful Electric Lights.

## ESTIMATES GIVEN.

*Carts round London daily for Collecting and Delivering.*



University of California  
SOUTHERN REGIONAL LIBRARY FACILITY  
305 De Neve Drive - Parking Lot 17 • Box 951388  
LOS ANGELES, CALIFORNIA 90095-1388

Return this material to the library from which it was borrowed.

ILL NEW

UCLA ACCESS SERVICES

Interlibrary Loan

1000 University Research Library

92575

92575

REC'D YRL 108 006





L 005 793 850 8

UC SOUTHERN REGIONAL LIBRARY FACILITY



AA 001 199 791 3

PLEASE DO NOT REMOVE  
THIS BOOK CARD



University Research Library

1 2 3 4 5 6 7 8 9 10 11 12 13 14 15 16 17 18 19 20 21 22 23 24 25 26 27 28 29 30 31 32 33  
GLOBE 42145-0

|             |     |    |     |
|-------------|-----|----|-----|
| CALL NUMBER |     |    |     |
| SRN         | VOL | PT | COP |

U