

o

PRACTICAL PRINTING

EXPLAINING
THE WAYS AND MEANS
OF PRODUCTION
IN THE
MODERN PRINTING
PLANT

o

By GEORGE SHERMAN

o

New York
Oswald Publishing Company
1911

B5929.11.2

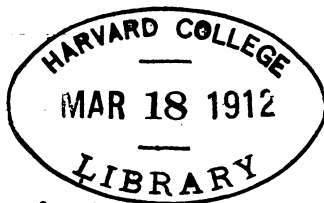

Sohier fund

Copyright 1911 by the
Oswald Publishing Company



CONTENTS

CHAPTER	PAGE
I From Apprentice to Journeyman	1
II The Composition of Commercial Forms	9
III Display Composition	19
IV Bookwork	31
V Job Composition, Proof-making and Proof-reading	44
VI Composing-room Equipment	57
VII Facilitating Composing-room Production	68
VIII Imposition and Lock-up	75
IX Platen Presswork	87
X Cylinder Presswork	97
XI Printing Inks	108
XII From Superintendent to Shipper	117
XIII In the Shipping-room	131

LIST OF ILLUSTRATIONS

	PAGE
Locking miters in use	11
Construction of locking miters	12
Brass panel and corner fonts	13
An example of brass rule designing	14
Use of a low rule in tabular work	16
A type area sketch	21
A letter sketch	22
Completed type design	23
Table of space calculation	24
Table of ems in one pound of type	25
Enclosing type matter in irregular mortise	26
Table of sizes and weights of paper	33
Table of type and leads calculation	34
Use of text letter in title-page	36
A classic chapter heading	37
A hand-lettered effect	39
A German title-page	40
A reverse plate effect	42
Letterhead with reader's marks	50
Letterhead partly corrected	51
Table of proofreader's marks	53
Effective proof of business card	54
Proofing frame	56
Serviceable cabinet	58
Brass galley	59
Yankee job stick	60
Brass type gage	61
Case for steel composing rules	62
Case for brass and copper spaces	64
Small set of gravers	65
A type-high planer	66
Combination stone and cabinet	67
Arrangement for medium sized shop	69

List of Illustrations

	PAGE
Index to cabinets	70
Label for miscellaneous character cases	71
Card for removed cases	72
Index for storage of cuts	73
Job ticket bin	74
Railroad furniture	77
The midget quoin	81
Steel skeleton furniture	81
Book-heading chase	83
Sectional block	84
Types of register hooks	84
Key for register hook	85
Patent block	86
Ratchet	86
Types of form racks	86
An ink closet	93
Modern platen press	95
Feeding mechanisms	102
Use of the latch arm	103
Modern cylinder press	104
The sheet steel trip arm	105
Valve and chamber	106
Chart for harmonious color relations	112
Job ticket	118
Job record	119
Composing-room time ticket	121
Time ticket	123
Time slip	126
Proof envelop	127
Proof receipt	128
Combination cutting slip	128
Special job ticket	129
Patented shipping box	132
Shipping tag	133
Package label	133
Reminder and re-order blank	135
Receipt	136
Another form of receipt	137
Instructions to shipping clerk	139
Bundling machine	140

PREFACE

IT was the aim of the author and publishers of this book to make it exactly fit its title; that is, practical. The methods and processes described have been tried and proved. The recommendations may be safely followed, but it is expected that the advice given will be accepted as merely suggestive, that the reader will think for himself. Improvements in printing machinery and methods follow one another in rapid succession; the reader is advised before purchasing any portion of the equipment recommended in these pages, to look into market conditions carefully so as to get the latest and best it affords. The publishers will always be glad to furnish any possible information.

CHAPTER I

From Apprentice to Journeyman

"If I were asked to give advice to the young man of today, I would say, 'Take one thing and study it, learn it thoroly, become a master of it.'"—
SIR ALFRED HARMSWORTH, English millionaire newspaper proprietor.

"In years gone by, the printing trade, in common with many other occupations, was confined, restricted. Those were the days when one man completed a pair of shoes, when the entire suit was modeled, cut and sewn by a single tailor. And oftentimes the printer edited the copy, set it up, locked it, made it ready, ran it off, and, after wrapping it, delivered it to the customer. Then the all-around man was not only an advantage, but a necessity. . . . The master printers of today seldom claim to do everything. They will announce that their specialty is booklets, catalogs or railroad work. As the employers have abandoned the old-time methods and adopted those suitable to the changed conditions of the present, so should the employees—compositors and pressmen alike—strive to excel in one particular. The man who perfects himself in some one special thing gains the fat envelop and assures himself of steady employment."—JOHN H. CLAYTON.

TECHNICALLY the making of the most successful journeyman in the modern printshop means the making of the specialist. This is the plan of present-day instruction in the workshop, in the technical school and of the printing trade journal.

In the fulfilment of this idea the apprenticeship period of four or five years should be divided so as to permit the young man to apply himself to the all-around duties of the composing-room during the first two or three years. Careful observation of his tendencies, or his proficiency in any one particular line, will enable the foreman to determine the specialty for which he is best fitted, whether it be artistic display composition, booklet construction, rule

and figure work, make-up, imposition, proofreading or the management and supervision of large jobs requiring four or five men in their completion. The last two years should be devoted to the perfection of either one of these special qualifications. Under such a system a four- or five-years' apprenticeship will bring forth fruitful results to the employer and a guarantee of maximum wages to the journeyman.

The mercenary motives of some unscrupulous employers are too frequently responsible for the indifferent qualifications of commonplace journeymen. The ambitious young man should be advised of this. If he is continuously assigned to the duties of an office porter or an errand boy with the promise of a trade as a subterfuge his four or five years of apprenticeship may grant him a journeyman's title of very ordinary value.

Some twenty years ago an unpromising lad entered the employ of one of Pennsylvania's most successful publishers. In less than a week it was discovered that the boy was utterly unfitted for the trade. He lacked the necessary common school education and he was not of the bent and stuff productive of good printers. He was unceremoniously discharged with the laconic advice to seek employment in a blacksmith shop. This printshop sarcasm was accepted in a literal sense. Today, the discharged printers' apprentice is a man of affluence and wealth and the products of his wagon-shop are known to every user of heavy vehicles in the country.

This is for the benefit of both employer and apprentice and it is intended to stimulate the employment of only such boys as are adapted to the trade. Hundreds of men

are poor printers because they are unfitted for the business, and they are unsuccessful in life because some one failed to tell them to quit years ago and take up blacksmithing.

No boy should enter a printshop as an apprentice under sixteen years of age. He should not be permitted to qualify unless he is able to show the results of a grammar school education. If compelled to go to work before he arrives at sixteen, his duties should be confined to office and shop errands, as a preliminary to entering upon a regular apprenticeship.

On the very first day of his actual apprenticeship he should be permitted to learn the cases. He should be told briefly how to hold the stick, how to stand before the frame, how to grasp the letters, and above all to avoid eagerness to attain great speed in setting. False motions are always acquired during these first days of case experience by the over-zealous boy and the impediment usually lingers during his life at the business.

An old case of ten point is the proper thing for the beginner. It is the most practical size for the young hands to pick up and past experience has proven that the fastest compositors have developed their speed from a beginning on this letter. Use no other than perfectly spaced and properly indented reprint book copy, leaded with two-point leads, measure no less than twenty ems or more than twenty-five ems. Show the boy how to dump his stick by beginning with four or five lines and increasing until he is able to handle an entire stickful with proficiency. Then teach him how to lock up his galley and to take a roller-press proof. Send these trial

proofs thru the proof-room in regular manner and permit some journeyman to take the few minutes' time to point out the errors in composition as a first corrective lesson. The boy who is unable to produce a fairly correct and moderately well-spaced proof after two weeks' work at the case, allowing say four or five hours' actual practice each day, is not intelligent enough or does not possess sufficient inclination to make it worth while to continue him as a composing-room apprentice. In such case permit him to enter as an apprentice in the platen press-room or send him on his way with kindly advice to seek employment in some other field.

Distribution of display type should not be attempted or permitted during the first six-months' apprenticeship. During this period he should devote some of his time to the study of faces with similar characteristics, he should learn to know them by name, by studying case labels, type founders' specimens and the advertisements in leading trade journals.

The second period of six months may be devoted to the distribution of straight-line display composition. Here is where the young apprentice will discover a wealth of information if he is sufficiently interested in his work to court it. He should be alert and watch the dead jobs of the best journeymen in the composing-room. In distributing and dismembering the rule, line and letter justifications, he should note the manner in which these are put together and endeavor to derive something of value from each job.

The most successful boys are those who are obliging to the journeymen, who do not object to looking up a

sort occasionally and who are ever ready to lend their assistance in placing materials within easy reach. For this spirit they will be indirectly compensated by information which will be readily imparted to them by the more advanced workmen. The boy who "knows it all" in the beginning will discover that he has much to learn many years afterward, and that the task is then much more difficult.

Upon entering the second year the ambitious apprentice should endeavor to secure the foreman's consent to his becoming an assistant or understudy of some proficient journeyman in charge of booklets, monthly publications and other large work. In this capacity he should be called upon to set running heads, make typographical alterations, set occasional reprint advertisements, learn to handle linotype slugs and monotype metal, proving on the Washington hand press, and, as he advances, learn something of page make-up, which includes the justification of cuts among type matter, folioing, tying, shelving and storing. During this second-year period he should advance rapidly, as he is now approaching the critical period when he is to receive his finishing touches and when he is to be allowed to try out his originality. This period will be his third year.

At this time he should be a subscriber and a regular reader of at least two prominent printing trade journals, for he must now acquaint himself with the prevailing styles of display in job composition and the most approved methods of mechanical construction. Detailed analysis and instruction along these lines will be covered in succeeding chapters.

Points worthy of immediate attention to the third-year apprentice in the job shop will be briefly cited here:

In setting displayed work from manuscript copy be sure to study the main points to be brought out.

Do not erroneously emphasize unimportant parts of the text.

Refrain from an endeavor to show too many faces. Always remember that the choicest specimens of display composition consist of simple, well-chosen lines in neat, straight-line arrangement.

Study the subject of appropriateness in the use of type. In other words, learn to understand that a polite announcement is not susceptible to the same treatment that might be accorded to a forceful newspaper advertisement, and that Blair, Engravers' Roman, scripts and other imitations of copperplate printing and lithography do not travel in company with the more common letters generally used on dodgers, and in the display of practical business forms.

Space all lines uniformly. The stoneman will discover poor justification to your detriment if you persist in being careless.

Do not attempt chap-book typography and letter-spaced effects until you have thoroly mastered the mechanical details of plain printing.

Study alignment. An interesting table of points above and points below for lining system justification will be found in every modern type founder's specimen book.

The slovenly workman is generally known by his quad boxes. Don't permit these boxes to become a depository

for wrong-fonts and broken letters. Be neat and tidy in the disposition of material.

Don't imagine that your ideas are far above those of the designer of your copy, or the lay-out man. If he suggests a certain line or a certain style of display, it will pay you to adhere to it.

Don't mix old-style and modern letters in display composition.

Make a detailed study of rule work and rule joining. Above all do not cut labor-saving lengths of rule. Any combination can be made without cutting. If you are confronted with a difficulty in this respect it will be well to consult some one who is acquainted with these problems.

After the apprentice has completed his third year in the various details of composing-room performances he should begin to get acquainted with his bearings. He should know whether he is better fitted for stonework or for display composition, or whether he should apply himself to proofreading or any of the other specialties into which the trade is now substantially divided.

If he prefers stonework it will be well for him to take about six months of the fourth year on the platen press stone. This will give him adequate instruction in the placing of locking furniture, the use of quoins, planing, the lay-out of small fours and eights and other details. To become an expert on the book stones he will require from two to three years of continuous experience as an assistant to the regular man in charge of this work. In the meantime he should consult books on imposition, the mechanism and adjustment of folding machines, margins,

nipper and guide edges and paper stock. After completing a thoro training in all of these departments he will emerge a finished mechanic with every prospect of advancement, in later years, to the position of foreman or superintendent.

One reason why the percentage of thoroly competent journeymen has decreased in recent years lies in the fact that apprentices are too frequently permitted to use their own discretion in the matter of perfecting themselves. They are carelessly hired and even more carelessly fired, which fosters the idea that the trade must be acquired thru varied ups and downs in a number of shops. While the majority of master printers and their foremen are lax in their attention to the apprentices under their charge, the parents of these boys are even more careless and frequently antagonistic to stern supervision.

The famous printers of years ago were not left to sway to the whims of their choice in this manner. All were carefully and strictly indentured, a system which virtually compelled a boy to serve his time in strict accordance to a prescribed system of instruction and advancement.

CHAPTER II

The Composition of Commercial Forms

THE construction of brass-rule designs for commercial forms and the use of rule in tabular work are subjects worthy the attention of the apprentice who is interested in job-room mechanics.

A practical man, well known to the printing world, speaks of brass rule in the following terms:

In brass rule the compositor has the simplest and most severe material. Handled wisely and with the proper types, the use of brass rule imparts to a design an element of strength and a high order of refinement and dignity. Brass rule in a design either looks well, commonplace, or decidedly bad. When it looks well, the use is simple, direct, and honest, and is invariably the work of the most skilled men in the composing-room. A design which depends for decorative effect upon brass rule will achieve this effect not so much from what a compositor has done as from what he has left undone.

In building panel designs it is a matter of facility to avoid mitering. A joint formed by square-butting is as good as a mitered joint and it can be made perfect in less time. Imperfect joints lend an indifferent appearance to rule work and a visible opening, whether butted or mitered, is equally displeasing. For this reason mitering should be done only when absolutely necessary, or when one-piece parallel rules are used.

When mitering is done on any of the conventional

hand-lever shaving machines the rule must first be cut into pieces about six points longer than the sizes required. Adjust the machine to forty-five degrees for a square corner and cut a miter at one end of each rule. All miter-shaving machines are made to cut deeper at the foot of the rule than at the face, which tends to produce a closed joint. The machine must now be set for the reverse miter and for accurate length. First, move the triangle in position for square-end shaving, and then set the gage with twenty-four point em quads. These should be placed in body-to-body arrangement, as there is more dependable accuracy in bodies than in sets. Raise the handle so that the knife will rest against the very top of the line of quads and then move the gage up snugly against the other end. Tighten the thumb-screw. Never adjust the gage for length while the handle is down with the blade resting against the bottom of the quad, for, if you do, the rule will cut a trifle short. After this adjustment has been made the triangle should be moved to forty-five degrees for mitering. When the miters are cut, the feet of the rules should be faced on a piece of emery paper to remove the burr.

The best joints will result in a paneled design by first completing the brass-rule work with an interior filling of new metal furniture. The type should not be inserted until all of the rule work has been completed.

Finally, however, after a panel design has been correctly constructed, a great deal depends upon the lock-up and make-ready in securing perfect rule-joinings. Faulty locking is the chief cause of poor joints. Frequently, swelled or shrunken wood furniture and a warped chase

will prevent a perfectly square lock-up. The eye may be unable to detect it, which emphasizes the necessity of using a steel square on all forms containing panels and rule-joinings. The quoins should be tightened with the fingers at first and then each rule-joint should be subjected to individual planing with the smooth end of a boxwood quoin. After that, slight variations in the heights of connecting rules can be readily detected with the fingers. These joints should be rubbed down and faced with a Scotch stone or a small bit of lithograph stone. Very old and badly-worn rule often can be made to print perfect corners by deftly touching up the joints with a fine jeweler's file. The filed joints should be finished with a facing stone. Typefounders have devised a number of clever wrinkles for the improvement of rule-joints, many of which are time- and labor-savers in addition. Next to the solid and

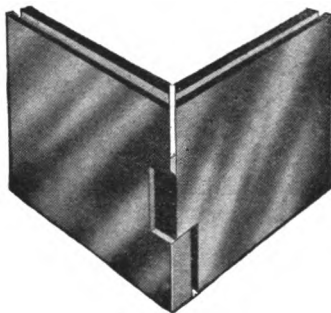

Figure 1

brazed corners the locking miters (Figures 1 and 2) are recommended, especially in the bodies four-point and larger. Mere pressure of the quoins in locking tends to

draw the parts together, thus forming a perfect miter. The interlocking lugs serve properly to direct the parts into position as the form is being fastened, and to prevent the leads that are outside the type from entering the joint. High metal corner quads are among other improvements

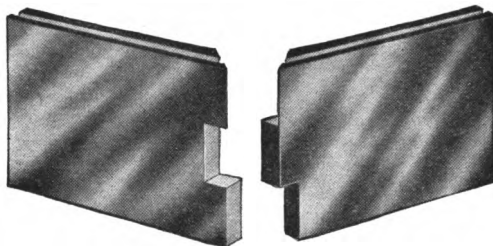

Figure 2

designed to lend support to one- and two-point rules and to lessen the tendency of these weaker rules to bend inwardly or outwardly at the corner joinings.

Very pleasing and characterful designs, in keeping with the tendency toward straight-line effects in modern decoration, may be produced with the new fonts of brass square corners and solid brass panel ends. All these are labor-saving, easy to assemble and justify, and readily convertible to many uses. A series of these fonts is shown, Figure 3, and their availability in brass-rule designing, Figure 4.

The practicability of setting tabular work in one measure across-page with the aid of short-measure slugs, or by casting up mentally for alignment, was demonstrated by the newspaper compositor of the hand-set days. This method of setting tables across-page and inserting rules

The Composition of Commercial Forms 13

afterward is adhered to to this day by the expert rule-and-figure printer, and it is the only method by which this class of composition can be handled on line- and letter-

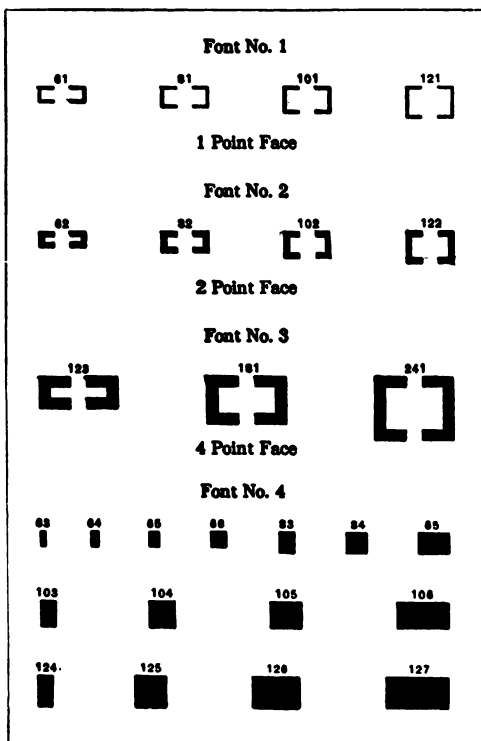
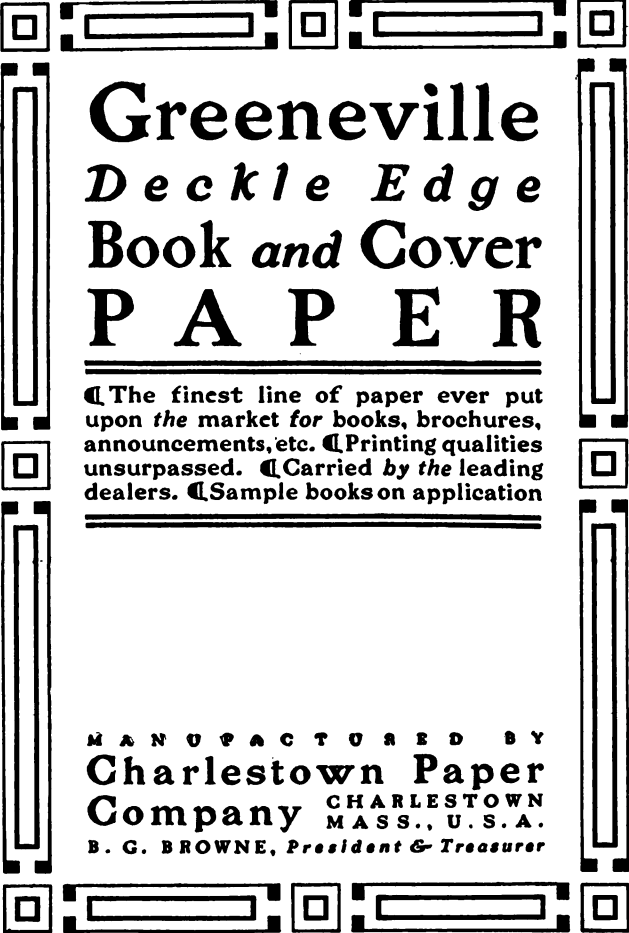

Figure 3

casting machines. The Rogers system, as applied to the linotype, has made it possible and practical to insert vertical brass rules in tabulated machine composition.



Greeneville *Deckle Edge* Book and Cover P A P E R

☞ The finest line of paper ever put upon *the market for books, brochures, announcements, etc.* ☞ Printing qualities unsurpassed. ☞ Carried by the leading dealers. ☞ Sample books on application

MANUFACTURED BY
**Charlestown Paper
Company** CHARLESTOWN
MASS., U. S. A.
B. G. BROWNE, *President & Treasurer*

Figure 4

The Composition of Commercial Forms 15

Figure 5 shows how a low rule, similar to the Rogers low rule, is used to advantage in hand-set tabular work. The column-rules (E) are supported by a two-point shoulder on the cross-rules (C) and two-point supporting spaces (A) of whatever type-body used. At one end of the table regular unnotched pieces (D) of cross-rule may be used. Side spaces (B) are also supplied to work with the type figures used. These side spaces are cast shoulder high and are en-set or figure-set of the body of type used. The hight of the shoulder notch on the cross-rule (C) and the hight to which supporting-type-spaces (A) are cast is such that leads, slugs, spaces and quads of regular manufacture may be used.

The composition of type-matter to register perfectly to machine-ruled blank lines and book-headings is another branch of typesetting that has become specialized. The quickest way to set and register the type-matter for a plain-ruled box-heading, consisting of a single line of type of one size, is as follows: Cut off the heading of the ruled sheet and tip this narrow strip of paper to the bottom of a stick set to even ems and as nearly the measure of the sheet as possible. Set the type on this strip of paper and justify each word in the center of the space, between the respective pairs of vertical rules allotted thereto.

But this method is hardly practical in setting the more complicated ruled blanks, in which the headings consist of a number of boxes containing matter of various depths and several sizes of type, and marginal or side lines in addition. Such blanks must usually be set in two sections, each separately—first the box-heading and then the marginal or side lines. In setting the heading, place

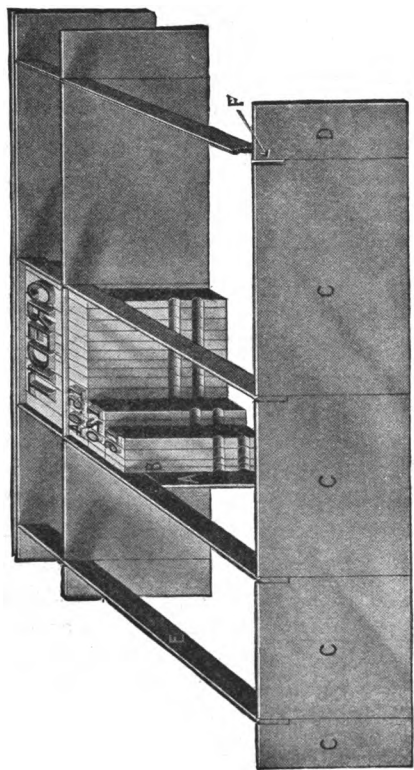

Figure 5

The Composition of Commercial Forms 17

the galley on the frame with its head to the left, just the reverse of its position in general use. Lay the ruled sheet on the bottom of the galley with the foot of the sheet to the lower left-hand corner. A reglet or slugs of some labor-saving length, long enough to cover the heading, should be placed over the sheet at the side of the galley as a foundation to work against.

All of the matter in the boxes should be set in a stick made up to twelve-point ems. Commence by setting the box containing the greatest amount of matter, which will establish the maximum depth of the box-headings. Let us suppose this box to contain three eight-point lines, measuring fifteen twelve-point ems. Under ordinary circumstances, the difference in the various measures of the boxes in the heading would require a number of changes in the set of the stick. The experienced book-heading printer will avoid these changes by setting his stick to the measure of the widest box. If this measure is fifteen ems, all lesser measures will be secured by placing a sufficient number of twenty-four-point quads in the stick to make up the difference. This method will not only avoid changing the measure of the stick, but it will at once facilitate composition, in that it will give greater freedom to the fingers in making justification to a narrow measure in a deep stick. Empty the matter for the various boxes on a neighboring galley and lift them to galley containing the ruled sheet in the order required, from left to right. The maximum depth of the headings being three eight-point lines, therefore twenty-four-point spacing will be required between the various sections of the heading to register all separate items between the respective vertical lines.

Next, set the marginal lines in some measure, governed chiefly by the length of the longest line and the size of leads and slugs most plentiful for the purpose. Cut a narrow strip from the left margin of the ruled sheet and fasten it with thumb tacks to the wooden sides of an old book-galley, and then space out the lines accordingly to register with the ruled lines. The heading and marginal lines are now combined into one job and the whole thing is tested finally with a full sheet of the ruled paper.

Jobs containing a great number of vertical and horizontal lines, intersecting to form large areas of ruled squares, should be set in two forms—down rules in one and cross rules in another, to print over by turning or whirling the sheet. This is the practical and profitable method of printing editions of five thousand or less impressions.

A number of materials usually on hand in almost every printshop are available as substitutes for the more expensive zinc-etched tint blocks. Common press-board is easily cut to fit any enclosure and it forms a suitable printing surface when mounted on a wood-base of proper height. The durability of its printing surface will be increased by adding a coat of varnish or gum guaiacum. Embossed cover-papers of tough texture also may be used to advantage. Some novel tint background designs may be produced by their use. One printer makes excellent and profitable use of a scroll saw in cutting borders and large wood-letter display lines. He uses one-eighth-inch maple veneer for the purpose. Wood-lines and other designs are taken from available prints, and pasted on the veneer to form a pattern for sawing. The letters and designs resulting are then mounted on electrotype bases ready for printing.

CHAPTER III

Display Composition

DISPLAY composition, from the artistic standpoint, has been more thoroly discussed in the printing trade journals than any other subject relating to the graphic arts. The subject has been practically exhausted. It would be almost impossible to write a chapter pertaining to the purely artistic features of display composition without repeating what has been said on the subject again and again by other writers. At the same time, the mechanical and the truly practical part of composition has been noticeably overlooked. As a matter of fact, one printer can readily handle all the "æsthetic" composition that comes to the average composing-room with a working force of twenty men. Therefore, let us reverse proportion in the character of trade journal and technical school instruction to conform more equitably with the above ratio: Art instruction, 1; instruction along mechanical and practical lines, 19. The trade requires more skilled mechanics, and the apprentice should endeavor to fit himself for the most promising openings of the future. For this reason, this chapter is intended to be of value to those who are interested in the practical side of job composition.

Lately there has been considerable demand for men who are able to plan and lay out work for those who are less competent. Advertisements of this character are common:

WANTED.—A job printer who can plan and work out ideas in advertisements, circulars and pamphlets in a shop employing six compositors. Salary governed by the applicant's ability.

These advertisements mean that it is worth while to study charting and sketching in the rough. The compositor who is able to "cast up" a piece of poorly-prepared copy, to the extent of defining the correct sizes of display lines and body type to be used, the measures, the arrangement and the general design is always in demand at a good salary. The rough sketch is an item of facility. It has two valuable features of economy. First, it enables the finished job printer to use the entire force of the composing-room when there is a rush of display work by supplying the less competent help with rough outlines. Second, the rough sketch supplies a general idea of the completed job, which may be submitted to the customer as a substitute for a first or trial proof. If the sketched idea does not conform with the customer's taste, the cost is little, and the plan of composition may be changed, while the printer avoids the embarrassment of adding charges for alterations.

A little study and practice will enable any printer to cultivate judgment of type and line widths, so that in a short time it will be easy to write "set in twenty-four-point Caslon Bold," with a feeling of assurance that the line will fit the measure. Rough-sketching or rapid outline-designing may be practiced along several lines to advantage. Letter-sketching (Figure 7) gives a detailed conception of the general typographical appearance of the completed job, while mere type-area sketching (Figure 6) supplies a good idea of plan, proportion and balance. The latter method is the more rapid of the two, and it is the most practical plan to pursue in sketching typographical

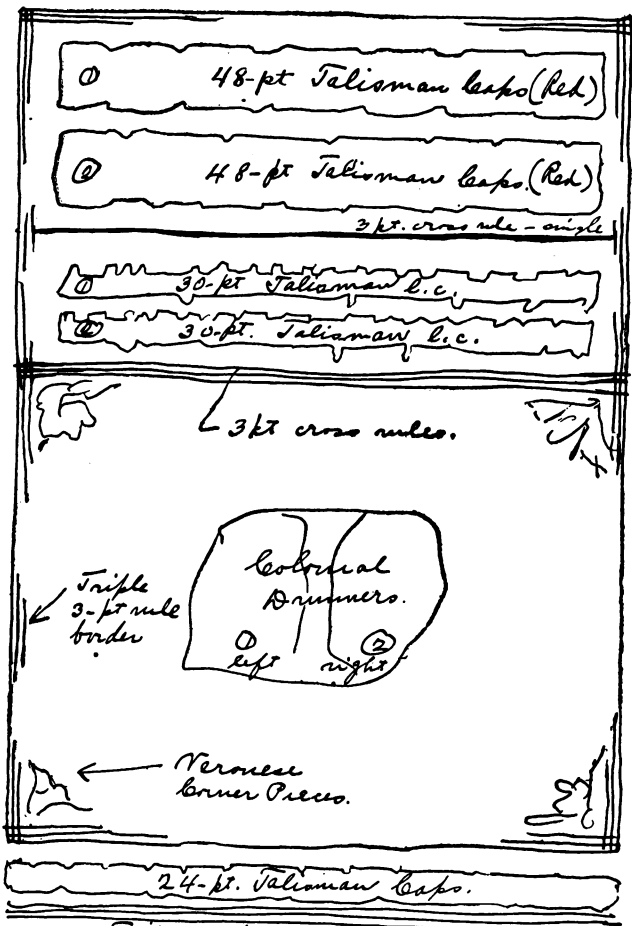

Triple 3-pt underlining
 * size of type - page $5\frac{1}{2} \times 8\frac{1}{2}$ inches.
 * "General Leander" in red - remainder in
 dark green - on green-tinted cover - paper

Figure 6

GENERAL LEANDER

An Illustrated Story of
the Colonial Revolution



GEORGE HAROLD BERNARD

Figure 7

GENERAL LEANDER

An Illustrated Story *of*
the Colonial Revolution

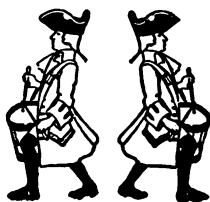

GEORGE HAROLD BERNARD

Figure 8

Typography and design by Chas. E. Wagoner

designs for the exclusive use of compositors. Letter-sketches will be more acceptable to the customer, however. Sketched typographical designs may be improved in appearance by pasting-in proofs of title-pieces, ornaments and borders when materials of this kind are designated for decorative purposes.

Large advertising agencies use "lay-out" sheets to advantage. These sheets are cross-ruled to present an area of twelve-point squares with an agate-line scale in left-hand margin. Lay-out sheets of this character, for use in designing and rough-sketching display composition, can be economically produced by faint-line ruling on a ruling-machine equipped with point-spaced pens. These sheets are of value in gaging display lines and in defining body-type areas.

Legible, well-prepared copy is essential to rapid and accurate composition. The advent of line- and letter-casting machines has created the necessity of rewriting poorly-prepared copy on a typewriter. It has been demonstrated that this plan is a time- and money-saver in the linotype department, and there is no doubt that type-written manuscript would be of equal value to display compositor.

In calculating the amount of space a manuscript will occupy, this table may be used. The number of words to the square inch set in various sizes of type is given. Calculations are based upon types of average or medium set. Due allowance must be made for lean or fat types.

18-point, solid 7	10-point, solid 21	7-point, solid 38
14-point, solid 11	10-point, leaded 16	7-point, leaded 27
12-point, solid 14	9-point, solid 28	6-point, solid 47
12-point, leaded 11	9-point, leaded 21	6-point, leaded 34
11-point, solid 17	8-point, solid 32	5-point, solid 59
11-point, leaded 14	8-point, leaded 23	5-point, leaded 50

When leaded matter is specified it is usually understood that the lines are to be separated with two-point leads. Double-leaded refers to type-lines separated with a lead or leads equal to four points in thickness. One-point leads are seldom used for spacing large quantities of text. This size is usually of brass and it is generally classed as line-and letter-justifying material.

To ascertain the quantity of plain type required for a certain piece of work, find the number of square inches in the matter, and divide the same by four. The quotient will be the approximate weight in pounds. As it is impossible to set all of the boxes uniformly bare, it is necessary to add twenty-five per cent to large fonts, and forty per cent to small ones, to allow for uneven quantities of sorts left in the case. The number of ems in one pound of type of the various sizes, is approximately as follows:

5-point.....	829 ems	7-point.....	423 ems	10-point.....	207 ems
5½-point.....	685 ems	8-point.....	324 ems	11-point.....	171 ems
6-point.....	576 ems	9-point.....	256 ems	12-point.....	144 ems

One pound of average solid type-matter contains about four square inches of printing surface.

Good judgment in "casting-up" large quantities of manuscript to correctly fit the limited confines of allotted type area must be acquired by practical experience. The foregoing tables will be of assistance to the studious printer in acquiring this experience. When it becomes necessary to adapt a certain amount of text to exactly fit the interior of an irregular drawing (Figure 9) the value of practical knowledge of casting-up asserts itself.

Judgment in setting matter for limited areas of this

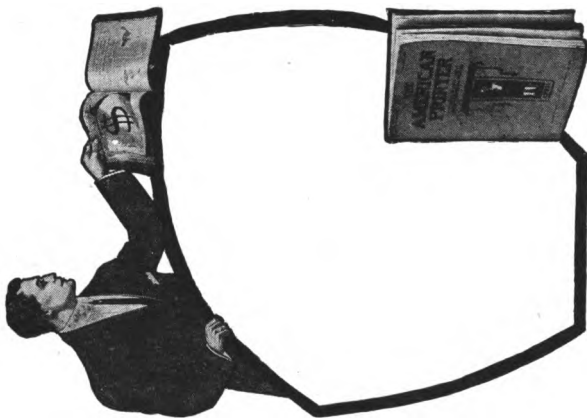

Figure 9

PROFIT IN EVERY PAGE

There's profit in every page of THE AMERICAN PRINTER. It is a treasury of information, imparted by specialists in typesetting, bookbinding, printing, photo engraving, book making, stationery, printing, lithography and printing-office methods. Every article in every issue is practical—every department is edited by a master in his line.

Generous reproductions of good printing, and critical studies of specimens sent in, add immensely to its value.

The employing printer, managers and pressmen who read THE AMERICAN PRINTER find their views broadened, their product bettered, their office and shop systems made more productive.

Read by the men before whom he must pre-

sent his proposals, the printer is made a

stronger and more successful business

man. THE AMERICAN PRINTER is made to be

read by the man who has the power to

buy. THE AMERICAN PRINTER is made to be

read by the man who has the power to

sell. THE AMERICAN PRINTER is made to be

read by the man who has the power to

buy. THE AMERICAN PRINTER is made to be

read by the man who has the power to

sell. THE AMERICAN PRINTER is made to be

read by the man who has the power to

buy. THE AMERICAN PRINTER is made to be

read by the man who has the power to

sell. THE AMERICAN PRINTER is made to be

read by the man who has the power to

buy. THE AMERICAN PRINTER is made to be

read by the man who has the power to

sell. THE AMERICAN PRINTER is made to be

Figure 10

kind consists in knowing what sizes of type to select. The mechanical procedure is explained in the next paragraph.

Separate, well-inked proofs of the mortised cut should be taken on regular engraver's proof-paper. If this work is done on a Washington hand press, a large, smooth-surfaced tint-block should be placed on the bed of the press to substitute the cut, after each proof has been pulled, for the purpose of making a transfer or offset proof. This proof should be taken on much thinner paper than that used for the originals. Place the fresh, well-inked original proof face up on the tint block and then lay the transfer sheet directly over it. The best offset or transferred negative will result if a few sheets of smooth, un-wrinkled packing are placed over all. This offset proof must now be trimmed square to fit the pan of a stick which has been set to some suitable measure. A tip or two of paste will hold the slip in perfect position until the composition is completed. The matter is set full measure, across the proof-slip, quadding indentions so that the composition will follow the outlines of a transfer. By this method it is as easy to follow irregular outlines as to set straight matter. In examples such as Figure 9 it is a matter of great economy to set the type to one measure with the guidance of an offset sheet, electrotyping and patching-in, rather than to adopt the obsolete and expensive method of justifying separate lines inside of a difficult mortise. Figure 10 is a proof of an electrotpe ready for inserting by patching.

A few suggestions and some valuable hints on job printing mechanics are appended, paragraphed and in condensed form:

Avoid an excessive amount of rule work and intricate panel designs in commercial printing for practical purposes. Manipulation of this kind adds fifty per cent to the cost of composition and make-ready without adding to pleasing appearance.

Make good use of white space as an illuminant of type matter. It makes composition easier and it shows better judgment than the use of too many detractive ornaments.

Adhere to a single series of type in plain forms for practical purposes.

Space display lines accurately and uniformly. An en quad is the proper word-spacing for the medium letter. For the extended letter use no less than two three-em spaces between words and no more than an em quad. The extra extended letter will permit of spacing with an em quad and a three-em space. Be careful to consider and make allowances for the extra space created by words ending with open letters, such as A, F, J, L, P, T, V, W and Y.

Imperfect rule joints may be likened unto an ugly scratch across a beautiful oil-painting. Avoid them by accurate mitering and careful justification.

A plain circular, set in paragraphed style, with an appropriate initial and an attractive heading, is preferable to a mixture of display faces.

Avoid a combination of three hyphens as a substitute for an em-dash in display lines. A rule justified with point-set spaces is preferable.

In separating forms for color work, avoid the use of a great number of leads and slugs. Use perfect labor-saving

furniture whenever possible. Justifying material reduced to a minimum number of pieces will guarantee better color register.

Do not use periods as word ornaments. They are poor decorators and when widely spaced they offer little resistance to the impression.

The use of script in date lines for office headings is an old-time custom not in keeping with good typography. A letter in harmony with the remainder of the display is more appropriate.

Adhere to one kind of rule in blank forms. Do not use dotted lines in one part of job and plain rule in another.

If you would produce a solid form of type and blank lines do not justify rules to type with slugs and leads only. Quads, used with rules, will produce a better form in every way.

Address lines set "Chicago, - - - Illinois," in advertisement work reveal the style of an unfinished printer.

A squared and letter-spaced style of typography used in conjunction with the long- and short-line idea on the same page is inharmonious and not in accord with good display.

To facilitate distribution place all final spacing of quad lines immediately after the last word of the paragraph. Do not scatter miscellaneous spaces among the quads.

In constructing panels to surround type-matter the top and bottom rules should always lap the side rules. This relates to unmitered panels.

In setting the text for a stylish booklet avoid excessive leading. Ten-point will not admit of more than three-point leading, while twelve-point type should be confined

to four-point leading or less. Rather reduce the measure and increase the margins than scatter the type in open order over the entire area of the page.

Study the alignment of initials with body-type and endeavor to preserve uniform indention of matter surrounding initials.

Use text or old-style headings over old style-body type. Gothic headings and headings of similar character should not be used with old-style faces.

CHAPTER IV

Bookwork

THE regular sizes of commercial book papers have been established by the conventional proportions of type-pages. If the pages of a book are to be made up for printing on a paper of regular size it is an easy matter to arrive at the proper type measure and page-depth by dividing both sheet-length and sheet-width by four, and deducting trim allowance. This applies to sixteen-page signatures. Accordingly, twenty-five by thirty-eight, the most commonly-used book paper, is the correct size for a book that is presumed to trim to six by nine inches. Allowing one inch for outer margins, the correct measure would be twenty-four ems for a page depth of forty-two ems. To print a thirty-two-page form on one side of the same stock would require type-pages eighteen by twenty-seven ems. This would result in a book four and one-half by six inches, trimmed.

It will be observed that book-papers of regular commercial sizes are cut to conform with the proportions of two to three—that is, the breadth of the sheet is equal to two-thirds of its length, or nearly so. These proportions also should govern the measure and depth of pages of type-matter, in all cases of conventional book imposition. Proportions frequently are changed, however, when odd and novel effects are intended to be pro-

duced thru the medium of an unequal distribution of margins.

Make-up for the most-used book-papers may be governed by the following:

A sixteen-page make-up for twenty-five by thirty-eight-inch stock will produce a six by nine-inch book. Type-pages, twenty-four by forty-two ems.

Thirty-two pages on the same stock will produce a four and one-half by six-inch book. Type-pages, eighteen by twenty-seven ems.

A sixteen-page make-up for twenty-eight by forty-two-inch stock will produce a seven by ten-inch book. Type-pages, thirty by forty-eight ems.

Thirty-two pages on the same stock will produce a five by seven-inch book. Type-pages, twenty-two by thirty-two ems.

A sixteen-page make-up for thirty-two by forty-four-inch stock will produce a seven and one-half by ten and one-half inch book. Type-pages, thirty-two by thirty-five ems.

Thirty-two pages on the same stock will produce a five and one-quarter by seven and one-half inch book. Type-pages, twenty-four by thirty-six ems.

A sixteen-page make-up for thirty-six by forty-eight-inch stock will produce an eight and one-half by eleven and one-half inch book. Type-pages, thirty-six by fifty-four ems.

The accompanying table (Figure 11) is of value in determining comparative weights and sizes of regular book and flat papers:

In estimating the quantity of type and leads required

TABLES OF COMPARATIVE WEIGHTS											
FLAT WRITING PAPERS						BOOK AND PRINT PAPERS					
16	17	18	19	20	21	24	26	28	32	36	44
X	X	X	X	X	X	X	X	X	X	X	X
14	16	17	18	19	20	20	20	22	27	34	41
X	20	22	25	27	30	24	26	33	41	49	57
X	21	22	24	27	30	36	40	48	58	68	81
X	24	26	30	34	40	60	68	82	98	117	143
12	13	15	17	18	15	30	37	44	52	60	72
14	15	17	18	20	20	35	38	43	50	59	67
17	18	18	20	22	23	40	38	50	56	67	74
X	22	24	26	28	29	25	45	41	62	74	89
X	23	24	26	28	29	36	50	45	62	74	89
X	24	26	28	30	31	36	60	55	80	94	104
X	25	27	30	34	36	36	80	73	97	114	124
X	28	31	35	40	44	100	91	124	148	178	214
20	18	20	22	24	25	40	29	33	36	40	48
X	19	20	22	24	25	45	33	36	40	48	54
X	22	23	25	29	31	50	37	40	46	50	60
X	23	24	26	29	32	55	40	44	48	52	64
X	26	28	30	33	35	60	44	48	52	56	72
X	30	32	35	38	40	80	50	54	58	64	84
16	12	13	15	17	18	17	17	19	20	22	24
X	15	16	18	20	21	19	19	21	22	24	26
X	18	19	21	23	24	20	20	22	23	25	27
X	20	21	23	25	26	22	22	24	25	27	29
X	24	25	27	30	31	25	25	27	28	30	32
X	28	30	33	36	38	30	30	32	33	35	37
X	32	34	37	40	44	35	35	37	38	40	44
18	16	17	19	21	22	17	17	19	20	22	24
X	19	20	22	24	25	19	19	21	22	24	26
X	22	23	25	27	28	21	21	23	24	26	28
X	26	27	29	31	32	25	25	27	28	30	32
X	30	32	34	36	38	30	30	32	33	35	37
X	34	36	38	40	44	35	35	37	38	40	44
20	14	16	17	19	20	45	38	42	46	50	54
X	16	17	19	21	22	50	42	46	50	54	58
X	20	21	23	25	26	60	50	54	58	62	66
X	24	25	27	29	30	80	66	70	74	78	82
X	28	30	32	34	36	100	84	88	92	96	100
X	32	34	36	38	40	120	100	104	108	112	116
X	36	38	40	42	44	140	120	124	128	132	136
X	40	42	44	46	48	160	140	144	148	152	156

SIZES OF FLAT PAPER		SIZES OF M. F. AND S. & S. C. BOOK		SIZES OF PRINT	
Cap	Demy	Cap	Demy	Cap	Demy
14 x 17	18 x 21	30, 35, 40, 50 and 60 lbs.	30, 35, 40, 50 and 60 "	22 x 30	22 1/2 and 25 "
17 x 22	18 x 23	40, 50, 60, 70 and 80 "	40, 50, 60, 70 and 80 "	22 x 32	25, 28, 30, 35 and 40 "
18 x 24	19 x 24	50, 60, 70, 80 and 100 "	50, 60, 70, 80 and 100 "	24 x 36	30 and 35 "
17 x 28	20 x 28	60, 70, 80, 100 and 120 "	60, 70, 80, 100 and 120 "	25 x 38	35 and 40 "
20 x 28	21 x 32	80, 100, 120 and 140 "	80, 100, 120 and 140 "	28 x 42	35, 40, 45 and 50 "
21 x 32	23 x 36			30 x 44	45 and 50 "
23 x 36	24 x 38			32 x 44	45 and 50 "
				36 x 48	50, 56 and 60 "

Cap	Demy	Medium	Royal	Double Cap	Super Royal	Double Demy	Double Medium	Double Royal
14 x 17	18 x 21	17 x 22	18 x 23	17 x 28	20 x 28	21 x 32	23 x 36	24 x 38

Cap	Demy	Medium	Royal	Double Cap	Super Royal	Double Demy	Double Medium	Double Royal
14 x 17	18 x 21	17 x 22	18 x 23	17 x 28	20 x 28	21 x 32	23 x 36	24 x 38

Figure 11

Let the number of pages of paper to match in the book be x . Then this line will be the proposed size, in which will be found the approximate weight desired.

for books of various sizes this table may be used as a basis for reckoning. The figures are based on a uniform measure of twenty-five twelve-point ems. Estimates for shorter or longer measures may be made by proportioning the totals accordingly.

MEASURE 25 EMS	6-point	8-point	10-point	12-point
Ems per line	50	37½	30	25
Lines to 1000 ems	20	26½	33½	40
Inches to 1000 ems	1¾	2½	4¾	6¾
2-pt. Leads to 1000 ems	15	21	27¾	34¼
3-pt. Leads to 1000 ems	13½	19½	25½	32

To find the number of pounds of type required for a page of certain size, divide the square-inch surface of the page by four and the quotient will be the number of pounds of type required—solid matter. When the type is to be leaded, multiply this quotient by a fraction whose numerator represents the point-thickness of the leads used and whose denominator is the same as the size of type used. Subtract this result. Thus, a twenty-four by forty-two-em (four by seven inches) page contains twenty-eight square inches; divided by four supplies the weight; or seven pounds of solid matter. If ten-point matter, leaded with two-point leads is specified, then two-tenths of seven pounds, one and two-fifth pounds, subtracted from seven pounds leaves five and three-fifth pounds, the weight of ten-point type required for the above page leaded with two-point leads.

No matter what depth of type-page may be required, it is always advisable to have the make-up in conformity

with the length of standard labor-saving furniture. Sometimes to do this it may be necessary to add two or three picas in leads and slugs at the feet or heads of pages before tying, but this will save considerable time in locking and stonework. When the illustrations lap the margins or extend beyond the confines of type it is customary to increase the width of these pages either two, four or six ems by the addition of slugs or metal furniture. Pages of this kind, made up to uneven widths, are troublesome to the stoneman, compelling him to break up marginal furniture and not infrequently to make tedious justifications with slugs, leads and cardboard.

In edition work or sewed volumes, bound in stiff covers, the order of pages usually is as follows: 1, half-title; 2, blank; 3, full-title; 4, blank or copyright; 5, dedication; 6, blank; 7, preface; 8 contents; 9, list of illustrations; 10, blank; 11, beginning of text. Appendix begins on first left-hand page following end of text; then follow glossary and index.

Title-page composition as applied to bound volumes and literary works is subject to restriction. Radical departures from recognized forms and standards are not permissible. Capitals, in old-style or modern romans, are acceptable styles for title-page lettering, and these may be arranged in long-and-short-line or the Puritan or Colonial squared fashion, but must conform strictly with the chosen style of the text. Black letter or text is permissible in some literary title-pages, but only when used with old-style roman as shown in Figure 12. A classical chapter heading, with rubricated initial, entirely up to the requirements of an edition de luxe has been supplied by

THE FAMILIAR LETTERS

OF

James Howell



BOSTON AND NEW YORK
HOUGHTON, MIFFLIN & COMPANY
MDCCCVI

Figure 12



VOYAGE
AUTOUR
DE MA CHAMBRE

I



U'IL est glorieux d'ouvrir
une nouvelle carrière, et de
paraître tout à coup dans
le monde savant, un livre
de découvertes à la main,
comme une comète inat-
tendue étincelle dans l'espace!

Figure 13

Bruce Rogers, and it is used here to show the limitations of display, decoration and marginal proportioning. (Figure 13.)

The title-page of the commercial booklet offers greater opportunity for the exploitation of original ideas in composition. It is not governed by the foregoing restrictions. Rule-work ornamentation and color may be used in moderation, and there is no limit to the variety of styles of lettering and composition that may be applied with pleasing effect to the title-page of the modern advertising booklet. Hand-lettering, with tinted borders and background and harmonious color effects, are the factors that lend a characterful touch to the stylish booklet of today. (Figure 14.)

The sweeping grace of German title-page composition and decoration is illustrated in a splendid specimen taken from a booklet recently issued by the Rudhardsche Type Foundry, Offenbach-on-the-Main. (Figure 15.)

A great deal might be said of means of improving the appearance of the text pages of conventional bookwork. Limited space permits of but a few brief notes on this point. A stiff, rectangular page of plain reading matter, without initial or running heading, is barren and unattractive, and does not possess the touch of attraction so desirable in the advertising booklet of today. Stylish running headings should be supplied wherever possible, and there is no end to the variety of styles in headings that may be used. Letter-spaced lines in roman or italic, either with or without rules; left or right-hand headings, enclosed with brackets; novel uses of the folio, either in figures or spelled out in roman or italic—these are but a

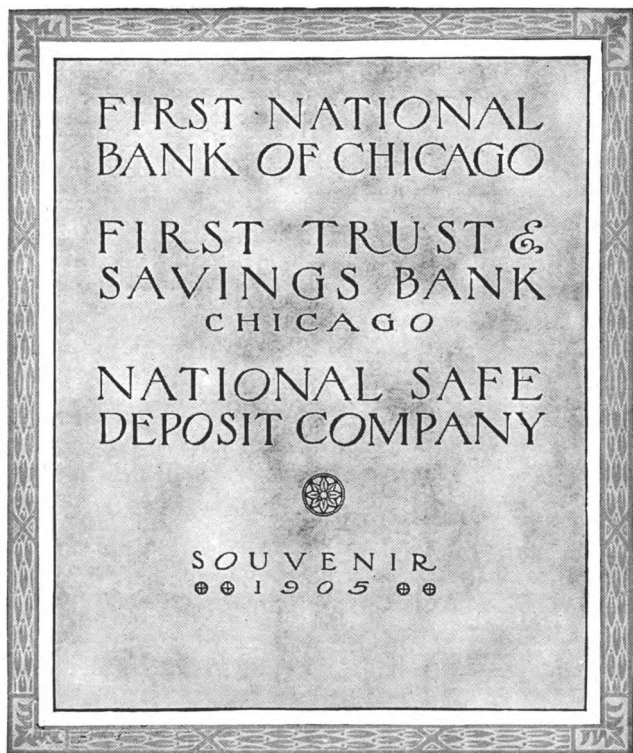
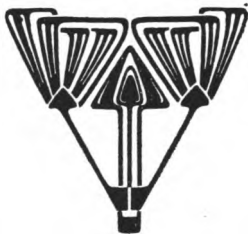

Figure 14

BEHRENS

Schriften·Initialen
und Schmuck nach
Zeichnungen von
Professor Behrens



Rudhard'sche Gießerei
in Offenbach am Main

Figure 15

few of the devices that lend interest to the plain page of paragraphed text. To these may be added a pleasing touch of color by way of rubricated paragraph marks, or tinted brass-rule enclosures. A stylish initial always serves well to usher in the beginning of a new chapter or a new subject of the text. But these are not always used wisely and well. Neither are they always inserted in a workmanlike manner. The alignment of initial and text is too frequently neglected and it is not uncommon to note the use of a modern initial with old-style body. Then, too, the spacing between initial and surrounding matter is often irregular, too open or too narrow, all of which mars the beauty of the printed page as a whole.

Reverse plates, showing white lettering on a solid background, are used to a great extent for booklet covers and title-pages. (Figure 16.) Printers of the larger cities, who are within convenient reach of the engraver, have no trouble in securing plates of this character, zinc-etched, at a nominal cost. The designs usually are set in substantial, open lettering, and when rules are used they should have a face not less than two points in width. After the type-work is completed it must be proved on onion-skin and bronzed. This proof, sent to the engraver, is placed in a regular photographer's printing frame with a sheet of velox or some other developing paper and exposed to light. The transparency of the onion-skin permits the light to act upon all portions of the developing paper except those parts protected from the light by the bronzed lettering. After immersing the sheet thus affected into the regular developing bath it will show the design and lettering in ivory white with a solid black background.

WAGON
AND
IMPLEMENT
PAINT

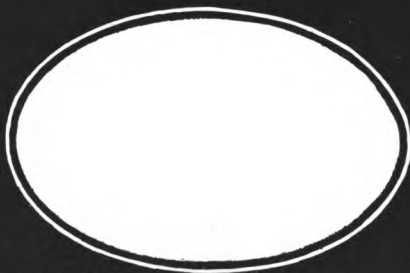

ALSTON-LUCAS
PAINT Co.

Figure 16

This forms the finished proof for the etcher. Printers who are far removed from photo-engraving houses can make perfect proofs of this character, both for printing and embossing, with little trouble and small expense. A camera is not necessary. A printing frame, at seventy-five cents, a dozen sheets of velox, a few M-Q tubes at five cents a piece, and a dime's worth of common hypo for fixing, forms the complete outfit.

CHAPTER V

Job Composition, Proof-Making and Proof-Reading

Job Printing.—Reading in this kind of work must be very careful, but it does not require the education needed for either of the others. [Reference is made to newspaper and book-work.] The reader should be quick to detect wrong-fonts, bad letters, false spacing and errors in style. He should, also, be able to mark wrong lines and wrong methods, and to point out how changes should be made. For these reasons, he should be an expert job printer. Where a number of men are working on miscellaneous jobs, it would be strange, indeed, if some of them did not mistake a line or commit an error in getting up a card or program, or that some change would not brighten up a given job very much.—“American Dictionary of Printing and Bookmaking,” published by Howard Lockwood & Co., New York City, 1894.

THIS paragraph is quoted for the purpose of showing the greatest prevailing error in the selection of commercial readers. Job composition proofreaders are most frequently ill-chosen because of the opinion that “it does not require the education needed for book and newspaper reading.” The quotation is misleading and utterly incompetent. They who have failed to appreciate the truth are paying dearly for the fiddler. And they who know—they who have acquired their knowledge through years of experience as commercial printers—are the ones who offer radical contradiction to the assertion by employing the most highly-educated and the most thoroly-

Job Composition, Proof-Reading, Etc. 45

finished mechanics to fill these positions. To these they grant the maximum salary allowances of the composing-room. And why? Chiefly because the display composition proof-reader's "O. K." is the one thing that either makes or breaks. Not infrequently the slightest error in a business form, such as a wrong-font, a misspelled word, an incongruity in display or a misconception of style, may cause a complete loss of productive labor and stock.

Book and newspaper readers are not so closely and completely surrounded with these possibilities of costly consequence. Typographical errors, misplaced and turned linotype slugs, are of such frequent occurrence in the modern daily as to be overlooked as unavoidable happenings. Even a case of extreme carelessness, such as the transposition of an entire handful of slugs in a news item, will do little more than heap the editor's wrath upon the make-up and the proof-room. Tomorrow the whole matter will be forgotten and the error will in no case affect profit and loss in the accounting departments. Admitting, however, that book-room reading requires greater accuracy and keener comprehension of typographical perfection, there is yet a wide margin of difference between the required skill and education of the book and the commercial reader. As a matter of fact, the responsibility for error in book reading does not end in the proof-room. Rather, from here it goes to the author, accompanying the revise, thus converting this branch of reading into a mere automatic performance, with responsibilities extending only to departures from actual copy. And, then, after all, if errors slip through, it is hardly possible that they would offer cause to reprint an entire edition.

The commercial proofreader's duties may be summed up as follows: He must collect and arrange the various "takes," or pages of copy, in consecutive order; he must read and revise it as many times as shall be necessary; he must paste up the final proof, or "dummy," in a presentable manner, showing stock to be employed and color of ink, when the latter is requested; and he must gather up and put away the copy for each job in a systematic manner, so that it may be referred to at any time in the future. Some of the large and well-regulated shops have given a deal of consideration to the matter of storing copy, even to the extent of providing a special fire-proof vault for the purpose. Wherever employed, this system is of great service and profitable. Large, commodious envelopes, or paper bags, are employed as copy enclosures, and these are numbered to correspond with the job ticket, for convenience in making reference. Frequently a reproduction of a certain manuscript, or reference thereto, is required years after the copy has been consigned to the vault, and it is, in such cases, that the value of this system of storing is appreciated.

Copy-holder.—Those who hold the copy for proofreaders who read to them. To do this well requires much experience. In most places this labor is performed by boys, but, in many of the larger offices thruout the Union, girls or young women are thus employed. They have usually better education than boys, and, if properly trained, become very valuable. They are, too, less expensive than men would be.

Again, I am quoting from the "American Dictionary of Printing." And, again, I must point out an error that has been extremely detrimental to accurate proof-reading. It is

Job Composition, Proof-Reading, Etc. 47

the unreliable and dangerous system of *reading to the copy-holder*. Here is a first cause for a multitude of errors. "In most places this labor is performed by boys, but, in many of the larger offices thruout the Union, girls or young women are thus employed." In other words, boys and girls, necessarily at beginner's wages, are employed as copy-holders. How can we expect such as these to be infallibly accurate. Is it not possible that "\$5.63" may appear on the proof instead of "\$8.63," as per copy, or "John J. Brown," instead of "John I. Brown?" And, is it not likely, that the young, inexperienced mind may overlook the error thru hurried reading? How much more practical and more assuredly safe to permit the holder to do the reading in all cases. Surely, the experienced proof-reader will be more apt to catch an omission or an error than the unpracticed eye of a boy.

A better plan, and one that is meeting with success in the larger commercial houses, is to subject all small jobs and business headings to two readings. The first reading is by the copy-holder; the re-reading by the proofreader. The accuracy of this plan has been demonstrated in a large shop where not a single error in commercial reading was passed in an entire year.

Brains are not alone necessary to the adequate equipment of an efficient proof-room. There should be a good reference library, consisting chiefly of three dictionaries—Webster's, Worcester's and the Century—a city directory, up to date; a telephone directory; the latest revised gazetteer, or a list of post-offices in the United States; a complete atlas of the world, and, if the house can afford it, a set of Americanized Encyclopedia should be included.

To this equipment should be added a good reading glass, a line gage with twelve- and six-point gradations, calendars of the past, the present, and the following year, fountain pens and pencils, a pair of scissors, a square and rule, black fluid ink, and, at least, two other colors for inserting special corrections and notes; a blue and a red pencil, a set of cards, containing all the commercial sizes, for making panel-embossed proofs; postal cards and ruled commercial headings for verifying type-areas, and an indexed card inventory of the type-faces of the composing-room.

An entire volume might be devoted to each of a number of subjects treating on proof-reading, and, in fact, textbooks on the following subjects may be secured at any complete book stand: "Capitalization," "Punctuation," "Compound Words," and "Style." While many of these are valuable aids to the job composition proofreader, there still remains to be brought out a book that will deal more directly with the technique of style as related to display composition, showing how correctly to mark and dispose of the title-page, the ruled heading, headings for office forms, society stationery, professional and business cards, legal blanks, posters and agency advertisements. In the limited space allotted to this subject, in a series of articles designed to cover many branches of the trade, information of this kind must necessarily be brief and to the point.

In modern display composition it is customary to eliminate periods when they appear as terminals of lines. It is contended, by persons of authority and good taste, that punctuation of this kind is detrimental to artistic appearance. If this style has been adopted in a certain piece of

Job Composition, Proof-Reading, Etc. 49

composition, the proofreader should be careful to note that the idea is adhered to thruout.

Accuracy and uniformity in the spacing of display lines is essential. The proofreader must not fail to make deductions and allowances for the extra white space created by such letters as the capitals A, L, V, W, etc.

Do not permit a compositor to use dotted rule in one portion of a ruled blank and plain rule in another. Call his attention to such errors on the proof.

Mark discrepancies in the alignment of capitals with smaller capitals when used together in the same line. Note, also, that rules are lined perfectly with type-matter.

In ruled blank work and legal forms, be careful to observe that all rules are spaced equal distances apart.

Order certain lines reset whenever the compositor makes indiscriminate use of more than two or three display faces in a simple form of address or a commercial heading. Make him observe harmony in the use of type.

When a display line, similar to "John Brown & Co.," is set in capitals with initials of a larger size, do not permit the compositor to use a small capital short "and." Mark capitals by underscoring, thus ≡.

When a fifteen- or twenty-em rule is used as a blank for a date-line in a letterhead or billhead, cut it down to eight or ten ems. This will improve the appearance of the job and the shorter space is sufficient.

When a rule is inserted in the date-line of an unruled letterhead, mark it out. It is presumed that paper of this character is for use on a typewriter.

Be sure to note the measure and depth of type-matter. Careless compositors frequently exceed the limitations of

L. M. FALLIS, ^{of N. K. Blair No. 3}
PRESIDENT

J. J. FRY, GENERAL MANAGER
612 #

O. C. ROBINSON, ^{612 #}
LEAD OPERATIONS

~~LEAD OPERATIONS~~ X

The Honduras National Railroad Company

GENERAL OFFICES

< 9 6 ft.
< 9 12 ft.

SUITE 328-329 MARQUETTE BUILDING) Rent 8 ft. Blair
Telephone Randolph 2311) Rent 6 ft. Blair No. 4

CHICAGO 1000 9 miles.

Figure 17

L. M. FAIRBANKS, PRESIDENT

J. J. FRY, GENERAL MANAGER

G. C. ROBINSON, LAND COMMISSIONER

The Honduras National Railroad Company
GENERAL OFFICES *2nd Fl.*

*Rec'd
16
1916*

SUITE 328-329 MARQUETTE BUILDING

TELEPHONE RANDOLPH 2311

CHICAGO



Figure 18

space. Study the peculiar characteristics of the various fonts of text. Remember that it is easy to mistake a capital R for a capital K, or an I for a J. These are difficult lines to read in both capitals and lower-case and the proofreader must observe closely.

Make the compositor change the composition if he attempts to use the squared style and the long-and-short-line effect on the same page.

Correct "The Brown Company, manufacturers of" to read "manufacturer of." Rule.—A noun in apposition must agree with its subject in number. But, remember that "company" is used collectively, and for this reason may either take the singular or plural verb, according to the context. Thus, when used as an entity a singular verb is required, as "The company has erected a new building." When individuals are referred to, as "The company are all of the same opinion," a plural verb is used.

A common error in display composition is found in the following: "James Stillson & Co., manufacturers and dealers in farming implements." Correct this to read "manufacturers of and dealers in," if such is the meaning to be conveyed.

If the copy reads "The Brown Hardware Company, dealer in hardware and building materials," do not permit the compositor to apply extraordinary display to the second appearance of "hardware." This is unnecessary when the business is incorporated in the firm name. Eliminate underscoring when used to excess. Overpaneling likewise. Discourage the use of periods for word ornaments by liberal use of the out-mark.

Watch the spacing between display lines. Make the

Job Composition, Proof-Reading, Etc. 53

compositor practice grouping and clustering in preference to scattering display, in open order, over the entire space allotted to type-matter.

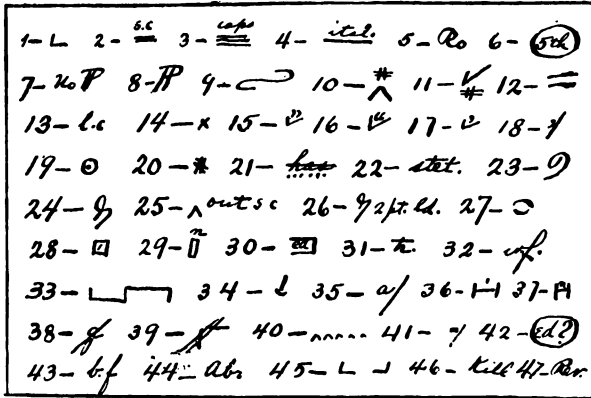

Explanation of proofreader's marks.—1, move to the left; 2, small caps; 3, capitals; 4, set in italics; 5, set in roman; 6, spell out; 7, flush, or no paragraph; 8, paragraph indentation; 9, run in; 10, insert space; 11, eliminate space; 12, line up; 13, set in lower case; 14, correct bad letter; 15, right-hand quotation marks; 16, left-hand quotation marks; 17, apostrophe; 18, comma; 19, period; 20, space; 21, disregard out-mark; 22, same as 21, or "no correction;" 23, letter inverted; 24, take out letters or words marked; 25, see copy for omission on proof; 26, take out two-point lead; 27, close up; 28, insert em quad; 29, insert en quad; 30, run back to preceding line; 31, transpose; 32, wrong-font; 33, transpose words; 34, push down space; 35, insert letter indicated; 36, em dash; 37, en dash; 38, cross indicating letter to be changed or removed; 39, close rule-joint; 40, letter-space; 41, hyphen; 42, query copy; 43, boldface type; 44, abbreviate; 45, center words or heading; 46, matter to be eliminated; 47, revise.

Figure 19

Mark bad rule-joinings and observe closely that rules are uniform in weight, in the same line, or in a continuous design. Badly worn or heavier-faced rules should be changed.

Cut out excessive ornamentation.

A portion of the foregoing corrective lesson has been

applied in a practical manner to a letterhead proof. (Figure 17.) In this example the proofreader's marks are more analytical in character than the usual book reader's corrections. It demonstrates that a thoro knowledge of correct typographical construction is more essential in job composition proof-reading than in straight-matter reading. Figure 18 is a reproduction of the same letterhead, partially corrected, showing how the proofreader may lend his assistance to the improvement of commercial printing.

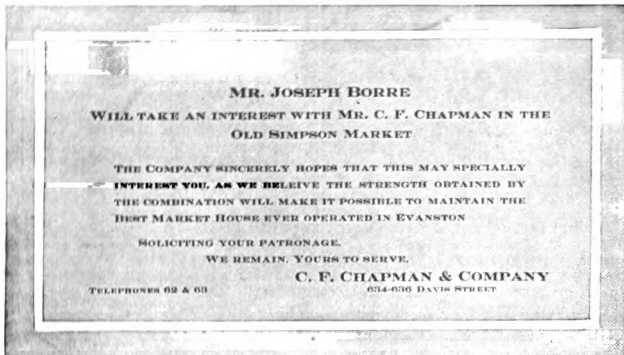

Figure 20

A chart, showing an indexed list of proofreader's marks, with explanatory notes, is added for the instruction of the student in job composition and proof-reading. (Figure 19.)

When proofs are requested by the customer it is advisable that they should convey a general idea of the appearance of the finished job. Very frequently, the first proof submitted has much to do with formulating a customer's opinion of the ability of the printer with whom he deals.

Job Composition, Proof-Reading, Etc. 55

Hand-press proofs on the actual stock to be employed are preferred. In all cases, however, where the stock does not lend itself readily to a perfect impression on the hand press, the best grade of engravers' proof-paper should be employed. A clear, snow-white stock, enameled on one side only, of heavy weight (preferably one hundred and twenty pounds) is recommended. Black and white proofs of this kind should be accompanied by a sample sheet of the actual stock ordered. Ruled headings should be proofed on french-folio or onion-skin and pasted over a finished sheet of the machine ruling. The proofing-paper bin should be always well filled with sheets of the following sizes: 6 x 9, $8\frac{1}{2}$ x 11, $8\frac{1}{2}$ x 14 and 14 x 17.

Proofs of business cards, invitations, commercial headings and like forms may be improved by a simple method of embossing to show the outlines of the stock in relief. For this purpose a set of accurately-sized cards is usually employed. The proof on enameled paper is placed against a window-pane, between the light and the worker. By this means the compositor will be enabled to register the form over the cardboard which is placed behind the proof. Then a sheet of french-folio is placed over all and the outlines of the card are heavily traced with a pencil to cause the apparent outer edge of the stock to stand out in bold relief. The effect is similar to Figure 20.

A simple method of registering two-color hand-press proofs, as employed by a number of printers, is worthy of attention.

A proofing-frame, made of four dovetailed pieces of ten-em wood furniture (Figure 21), is placed on the bed of the press. The type-form, well tied with page-cord,

is then placed within this wooden enclosure and held in position with a single pair of Hempel quoins, tightened with the fingers. Four common pins, fastened in the frame as indicated in the drawing, with points protruding

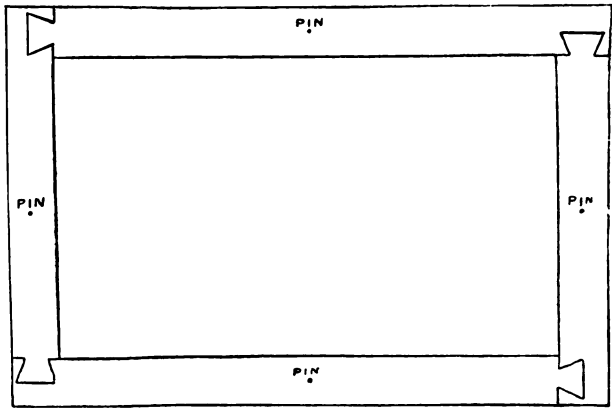

Figure 21

slightly above type-height are used as registering devices. The form is first inked in one color, and a frisket sheet is placed over the color to be eliminated. It is obvious that the projecting points will make small perforations in the margins of the sheet in pulling the first color proof. The form is then washed for the second color, and again a frisket is used to blot out the lines appearing in the first impression. In taking the second color, the perforations in the first proof-sheet are placed over the points, and after pulling the lever a perfectly registered two-color proof will result.

re and he
ns, tight
ened in
s protrud

CHAPTER VI

Composing-Room Equipment

THE equipment and general arrangement of the composing-room will be given first consideration as items of importance to economical production. The up-to-date wood goods catalog and the typefounder's specimen book are alive with suggestions pertaining to the selection of tools, appliances, cabinets, imposing stones and foundry products. These sources of information are comprehensive and replete. To the man who would begin a small business of his own with a limited amount of capital these suggestions are rather bewildering and not at all in accord with the limitations of his bank-roll. It requires a vast amount of knowledge and keen business judgment, of the kind acquired thru years of practical experience, to know just what is absolutely necessary to a good and adequate equipment, what are sure and certain money makers and labor economizers, and what items of the cataloged tools, utensils and foundry products may well and safely be eliminated.

Of course there are tools, devices and machines purposely designed to suit the requirements of the specialist. Most of these would be useless to the book and job printer. As these articles are designed to be of especial value to this latter and most extensive class, it is proposed to describe an ideal equipment exactly suited to

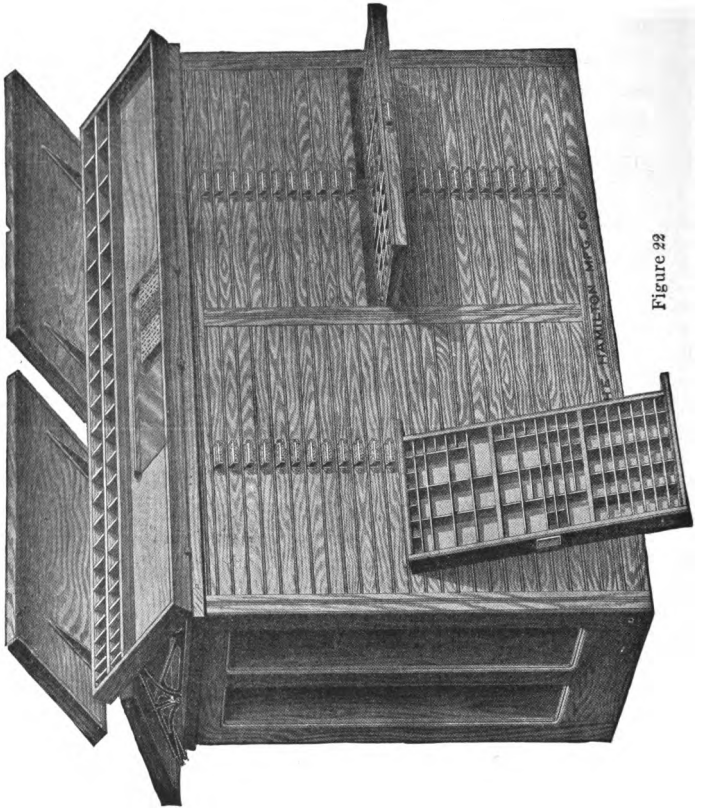

Figure 22

the requirements. Only the best, the tried and the proven of the many will be selected and combined into one complete plant—the ideal composing-room.

Usually the bulk of the composing-room investment is in type. Also, at the same time, most of the money carelessly wasted may be attributed to short-sighted selection



Figure 23

and injudicious buying for this part of the equipment. On this point I will repeat a little philosophical advice embodied in one of my articles of a few years ago.

“The type salesman who attempts to instal a sprinkling of the entire products of the foundry he represents, without regard for the limited means of the buyer, should be avoided. It is a matter of economy as well as shrewd discrimination to adhere to a foundry that produces a reasonable number of sensible and desirable new faces each year. By this method you are sure to get full value out of each font purchased, you avoid the danger of buying short-lived faces and of crowding your composing-room with useless cabinets, and you are sure to get faces demanded by popular taste. To produce good work you must buy complete series, in all the sizes, which are usu-

ally thirteen in number. Avoid big jumps, as it may necessitate setting certain lines in type entirely unsuitable as a companion to the body and principal display.”

Space does not permit of enumerating a complete list of the most serviceable faces for all-around purposes. However, the best advice on this point may be set forth in a single paragraph :

Limit your number of faces to twelve or thereabout, and be sure that all of these belong to the class of general utility letters. Each of these should be represented in complete series and in judicious quantities. Spaces and quads, being the chief items necessary to facilitate composition, should be purchased in extra large quantities. For, is it not a fact that spacing material, one of the most inexpensive of foundry products, is usually lacking in quantity in the majority of composing-rooms?

To emphasize the shrewd judgment of the printer who curtails the number of his type-faces, I would cite an instance of success attained by the use of but one single and complete series. This plan was adopted and adhered to

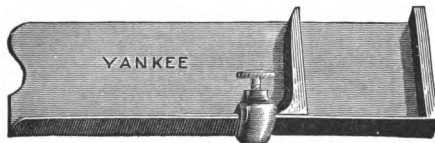

Figure 24

for more than a year, with pronounced success, by A. Linden, of Denver, Colo. In 1905 Mr. Linden produced a comprehensive portfolio of high-grade specimens of commercial printing in which Caslon and Caslon Italic were used exclusively in securing a wide and varied range of effects.

The following limited selection of faces will prove economical, practical and highly suitable for all purposes.

Caslon, in two or three weights, with italics to match.

Caslon or Prioxy Text or any other text of similar character.

One series of rugged design, which may be either Pabst, Powel, Dorsey, McFarland or similar letter, with accompanying italics.

Gothics, in about three weights, with accompanying series of Condensed Gothics of medium set.

Three or four series of card letters, for society printing, all adaptations from the engraved designs of plate printers.

The above are sufficient for the general purposes of the medium-sized commercial printing plant, but the addition of Cheltenham or Kenilworth, or Bookman, or

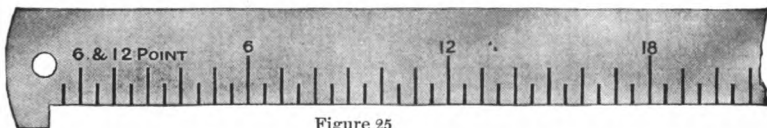

Figure 25

Authors' Roman or of some letter with the characteristics of Old Style Antique will lend prestige to the equipment of the booklet specialist.

Finally, I would caution against the selection of two or more faces with similarities. Investments of this kind are extravagant and wasteful. Why buy Kenilworth when the shop is supplied with Cheltenham, or Cheltenham Bold and Adstyle, or Plymouth and Hearst, or Prioxy and Flemish? In such selection lies the grand mistake of the average buyer of materials of the composing-room.

The similarity of faces lends little variety to the products and such mistakes in selection are sure to cause trouble in distribution.

The most practical selection of brass rules is of the variety in which the various faces are placed on a uniform body. That body is preferably three points, as a combination of such rules always makes the best multiple of twelve points. Furthermore, three-point rule possesses a more substantial footing than two-point, and it is susceptible to more uniform printing with less make-

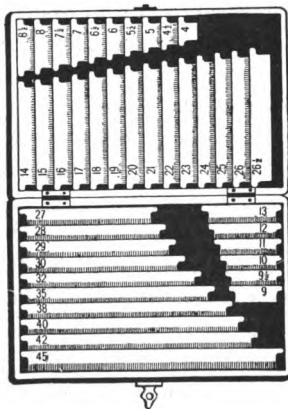

Figure 26

ready. It is a difficult matter to construct a rule design quickly when a great deal of mitering is desired, and this cannot be avoided with rules which have the face on the center of the body. The ideal composing-room must not be without modern labor-saving rules, all cut to ems and half ems, in conveniently partitioned cases. All rules should be beveled on one side only.

In selecting metal borders it will be profitable to avoid all designs that require close joinings of solids and fine-line or screen effects. Borders of this kind round off readily and become unfit for use in a very short time. The best and most serviceable borders are of the non-joining variety in which the designs are composed of separate segments. No other thing is so unpleasing as the effect of a poorly-joined solid or fine-line metal border.

Type-metal leaders are most unsatisfactory for blank-line work, and dotted brass rule is undesirable for pecuniary reasons. It necessitates difficult justification with quads and leads, which adds greatly to the cost of producing this class of work. Brass leaders are more expensive than dotted rules, but in the end they are far more profitable. These should be purchased in labor-saving lengths, on six-, eight-, ten- and twelve-point lining bodies.

Lately there has been much talk about dust-proof type cabinets and similar composing-room furniture. A composing-room so equipped, with varnished and highly-polished dust-proof cabinets thruout, is a handsome thing to look upon; but, is the idea altogether practical? Is it not possible that a complete equipment of this kind is a rather expensive luxury? Has the "dust-proof" advocate ever shown you a practical demonstration of the deteriorating effect of dust on type? It's hardly worth an argument. The four-dollar-and-a-half news stand has given adequate service in America's most successful composing-rooms and it is good enough for general book-room use. A half dozen cabinets and stands, with steel runs and

dustless, of approved pattern, should be sufficient to hold the choice display faces, and to serve as stands for the workmen who handle the finer grades of work. Figure 22 is a most serviceable cabinet of this character that meets every requirement of convenience. A four-foot working space should be allowed between all cabinets and stands, which is sufficient to admit of free access to all cases without interfering with or crowding workmen at adjoining cabinets.

Now let us supply this stand with the necessary tools

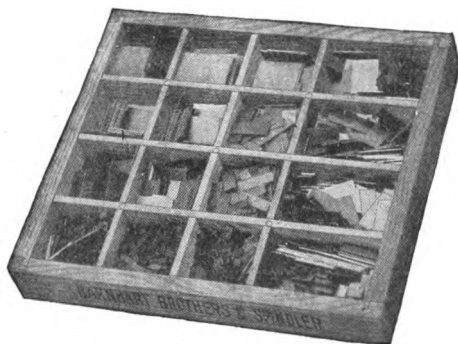

Figure 27

and utensils, all of a practical nature and each designed to aid rapid and economical composition.

A first essential is a good, all-brass job galley, preferably with a one-piece rim. Galleys of this kind will retain absolutely perpendicular side walls and square corners. (Figure 23.) The selection of a composing stick is a matter of individual choice. Numerous patented devices of this kind, some toothed and notched for six- and twelve-point adjustments, have been brought out from

time to time. They are giving good service, but the old-time pan with solid knee and heavy thumb-screw attachment is still very much in use. One design of this variety is shown in Figure 24.

Another valuable tool that should form part of the equipment of every job stand is the solid brass type-gage. A substantial gage is made of four-point brass, with hook and six- and twelve-point graduations. Twelve inches is a convenient length. (Figure 25.)

Compositors frequently are in the habit of using labor-saving brass rules for composing type-matter. This habit is destructive to materials and should be discouraged. An excellent preventative is a handy case of steel composing rules (Figure 26), which should be a part of the up-to-date stand equipment.

The invention of brass spaces and copper hair spaces has eliminated the scissors and cardboard in letter and



Figure 28

final line-spacing. This is an important item of economy which suggests the need of having a handy small-sized case of these spaces close at hand on the compositor's frame. (Figure 27.)

Other little items of economy that will not over-crowd the job printer's handy drawer, are a small set of graters

(Figure 28), a diagram of numbered card sizes, a table showing sizes of stock, a small pair of pliers, two or three kinds of fine jeweler's files, a facing stone, tweezers, etc.

An indexed cut and ornament cabinet is another matter of necessity, and, to be well equipped for expeditious

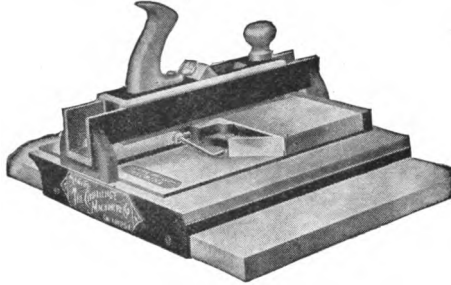

Figure 29

production, a composing-room should not be without a work-bench and its tools and appurtenances. The latter should consist of a vise, a lead-cutter, a mitering machine, a type-high gage for testing cuts on the block, a type-high planer (Figure 29), and a saw and trimmer.

The latter is a machine of exceptional merit and economy. It avoids the delay consequent upon sending electros to a foundry for small mortises and for trimming, and it may be applied to a multitude of duties that make it almost indispensable.

One of the most practical items of composing-room economy is the combination stone and cabinet, with labor-saving furniture and reglet racks. One of the latest improvements in this line is shown in Figure 30. The general utility of its various appointments are too well illustrated to require further description.

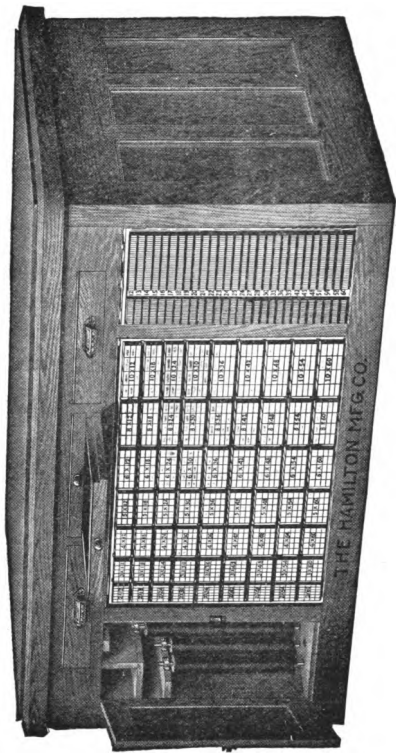

Figure 80

CHAPTER VII

Facilitating Composing-Room Production

IF you possess the materials specified in the preceding article of this series your composing-room equipment is complete. Also, it is practical, because it consists of only necessary fonts, furniture and appliances. If you would secure the most efficient service out of these materials it is necessary that the arrangement of your equipment should be planned for the greater convenience of your workmen. Everything should be arranged to avoid unnecessary steps and otherwise to minimize the expenditure of unproductive energy. An ideal arrangement for a medium-sized shop is shown in figure 30a.

Here the idea is to derive the greatest benefit from available light, to closely surround each worker in each separate branch of the trade with his most necessary materials and to place all furniture, utensils and machinery in progressive arrangement. Thus, in adhering to this plan, the lead, slug, quad and rule cabinet has been placed within most convenient reach of *all* compositors; the jobber's frame is within easy reach of the foreman's and the proofreader's desk; the make-up's frame is in touch with the book stone; and the Gordon lock-up is located between the foreman's desk and the job presses—the one being his receiving station, the other his department for delivery.

Facilitating Composing-Room Production 69

Many practical printers favor the plan of segregating distinct departments, and, in all houses where the theory has been put to practice, the Gordon presses are located in the cylinder-room, usually on one of the floors below the composing-room. It follows that all forms, both large and small, must reach the press-room by way of the elevator. Such a plan does not hasten production, as the

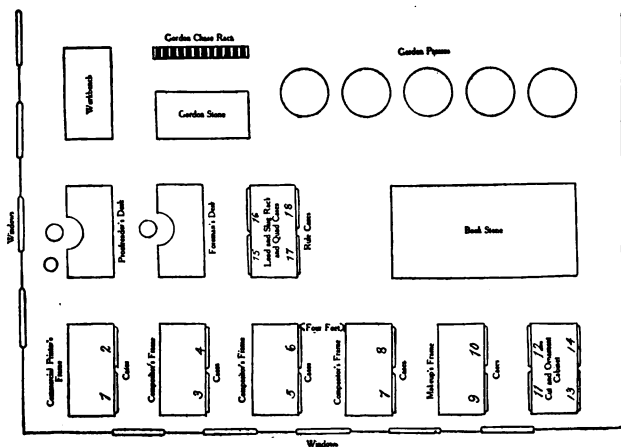

Figure 30 a

method is roundabout and expensive. I favor the combination of Gordon press-room and composing-room on one floor. The necessity of immediate and direct communication between these two departments is too frequent to permit of the many small delays such as those consequent upon securing make-ready O.K. and sending forms to press and returning them to the Gordon stone when unforeseen corrections or registering for colors are required.

An important item to facilitate production in the composing-room is an index to cabinets. (Figure 31.)

CONTENTS		CABINET		CONTENTS		CABINET	
A				M			
Antique (Modern)	.	.	10	Mathematical Signs	.	.	1
Algebraic Signs	.	.	1	Medical Signs	.	.	1
Art Ornaments	.	.	14	Metal Rule Corners	.	.	18
Astronomical Signs	.	.	1	Miscellaneous Signs	.	.	1
B				N			
Blair	.	.	2	Nautical Signs	.	.	1
Blanchard	.	.	4	O			
Bookman	.	.	3	Old Style (Body) 6 pt.	.	.	1
Borders	.	.	11	" " 8 pt.	.	.	2
C				" " 10 pt.	.	.	3
Caslon O. S. Italic	.	.	5	" " 12 pt.	.	.	4
Caslon O. S.	"	.	6	" " 18 pt.	.	.	5
Caslon Bold	.	.	7	" " 24 pt.	.	.	6
Caslon Text	.	.	8	P			
Condensed Gothic	.	.	15	Pabst	.	.	18
E				Plate Gothic	.	.	3
Engravers' Bold	.	.	3	Piece Fractions	.	.	1
G				R			
Geometrical Signs	.	.	1	Radical Signs	.	.	1
Gothic	.	.	16	Recipe Signs	.	.	1
H				S			
Heavy Face Dashes	.	.	1	Special Letters	.	.	1
Heavy Face Paragraph Marks	.	.	1	Special Brackets	.	.	16
Heavy Face Parenthesis	.	.	1	T			
Heavy Face Quotation Marks	.	.	1	Tudor Black	.	.	7
I				Tiffany	.	.	7
Italic (O. S.)	.	.	9	Typewriter	.	.	10

Figure 31

Facilitating Composing-Room Production 71

An index of this kind should contain every item of type, borders, ornaments and other foundry materials in the composing-room. This list should be printed from large type on a full sheet of cardboard and it should be suitably framed and hung in the center of the room. A greatly reduced facsimile should be hung on the wall aside of each frame. While this is an inexpensive item of convenience, yet it is of inestimable value to the new men or to the extras you may put on from time to time. By referring to the list a new man will be able to locate all materials as readily as the compositor who has served his apprenticeship in the shop.

As an auxiliary to the cabinet index, a label similar to figure 32 should be used on all cases containing astronomical, algebraic, mathematic and other miscellaneous signs. These labels should be diagramed to represent the box partitionings, with parallel ruling to show the heavier sectional divisions of each case.

In using this system, should the new man require six-point piece fractions, he will refer to the "index to cabinets," and under "P" he will find "piece fractions,"

8

□	△	♁	♃	♀	☉	☿	♁	♃	♁	♁	♁	♁	♁	♁	♁
♁	●	☾	☾	☾	♁	♁	●	♁	♁	♁	♁	♁	♁	♁	♁
♁	♁	♁	♁	♁	♁	♁	♁	♁	♁	♁	♁	♁	♁	♁	♁
		1	2	3	4	5	6	7	8	9	0				
		1	2	3	4	5	6	7	8	0	0				
		1/2	2/3	3/4	4/5	5/6	6/7	7/8	8/9	9/9					
		1	2	3	4	5	6	7	8	9	0				

Figure 32

cabinet 1. Arriving at that cabinet the sizes of bodies will be indicated by the large figure on the left end of each label. Every character and its exact location is shown on each label, as in figure 32 piece fraction $\frac{5}{7}$ is in the left section of the case, in the last box of the sixth row.

It frequently becomes necessary to remove certain cases from their indexed location. Thus a number of cases may be scattered over widely separated portions of the room. Questioning, calling out or wasting time in search may be avoided by using a card similar to Figure 33. This should be filled out and placed in opening created by removal of case from cabinet :

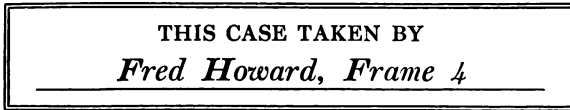

Figure 33

Considerable time will be saved in locating and removing jobs from the live boards for lock-up by requiring each compositor to mark the slide number on all proofs. An order to this effect should be posted on every frame. (Figure 34.)

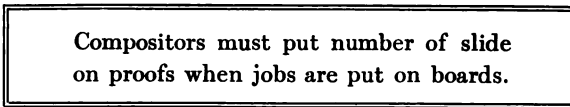

Figure 34

In the larger shops, where a great number of electrotypes and illustrations are used, these should be properly stored in cabinets or on pigeon-holed shelving. All should

Facilitating Composing-Room Production 73

be indexed and recorded in books made for this special purpose. Merely to enter the title or name of the electro is hardly sufficient. Titles frequently conflict and descriptions do not always lend the information wanted. A better plan is to use books of a large size, with leaves of manila cardboard for pasting in proofs of all electros and cuts entered and indexed. Each leaf should contain blanks for data relating to the work. A valuable reference of this kind consists of the following: (Figure 35.)

Customer's Name.....	Last Job No.....
Title of Cut or Electro.....	
No. of each.....	
Original belongs to..... <small>(us or customer)</small>	
Original returned, Date.....	
Shelf No.....	Bin No.....
Remarks:	

Figure 35

This should be printed on a small gummed slip, about four by two inches, for pasting in the upper right-hand corner of each manila leaf. When a number of proofs are pasted on each page it will be well to attach such a slip over each. The value of this method of storing and indexing as a time-saver is obvious.

All type matter held on live boards for future use should be entered and indexed in similar books. Aside from its value as a reference in determining whether a job is standing this method will aid also in checking up or cancelling work for distribution.

A job ticket bin similar to the one illustrated (figure 36), is of inestimable convenience. This series of boxes should be attached to the rear of the foreman's desk, and each should be labeled as shown. All new tickets sent to the foreman from the business office are placed in the right-hand bin by the superintendent's errand boy. As these are entered in the foreman's job book they are placed in turn in the second bin. From this box the work

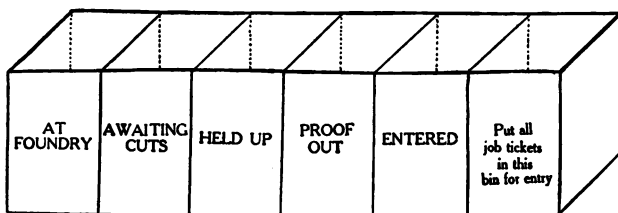

Figure 36

goes to the compositors' hands. Finally, after reaching the proof-room all tickets are returned to the third or "proof-out" bin. Two or three bins, similar in construction, are attached to the ends of both the Gordon lockup and the cylinder lockup's imposing stones. These are labeled "Ready for Press."

CHAPTER VIII

Imposition and Lock-up

MOST writers on the subject of "Stonework" have given the greatest amount of space to form diagrams and analytical notes pertaining thereto. Books of this character are instructive and of great value as works of reference. Most of them are available at a very moderate price and this fact offers sufficient excuse for omitting form diagrams in this article. At present the subject is to be treated from a mechanical standpoint and along lines that are planned to facilitate economical production.

Improvements in methods and materials associated with this branch of the trade are keeping pace with the advancements in all other departments. Close register three-color process plates have brought about metal bases and register hooks just as the electrotype created the necessity of patent blocks. In like manner, larger forms and rapid printing presses are demanding greater stability and increased accuracy in chases, quoins, marginal furniture and other materials required in building a perfect book form.

Liberal investment in adequate quantities of marginal and lock-up furniture in both metal and wood is suggested as a first step toward securing an ideal equipment. It pays to discard old wood furniture that has become swelled

and warped thru contact with water, lye, or benzine. Material of this character is one of the causes of poor register, work-ups and pull-outs. Wood furniture, even when new, is not always perfectly square. When you receive a consignment of furniture always test it with a pair of calipers, across its width. See to it that it measures the same at the top and bottom. Locking with furniture with sloping side walls causes type to arch or bulge when pressure is applied to the quoins at the foot of a page.

Labor-saving metal furniture is the most practical for filling in margins when the form consists of pages of hand-set foundry type. When linotype slugs, monotype, and cuts with wooden bases are used slight inequalities in the make-up of pages are always apparent. To overcome any lack of stability or uniformity caused by materials of this character labor-saving wood furniture is suggested, chiefly because it is not entirely inflexible and because it lends itself more readily to these slight irregularities. Iron and steel furniture supplies the best locking material for forms that are to be sent to the foundry for electrotyping and stereotyping. This furniture is all made on the point system, in regular labor-saving sizes; is micro ground and therefore absolutely accurate. It cannot be dented or bruised and will not expand with heat and afterwards contract out of shape. It also possesses the advantage of being much lighter than most other metal furniture. Where close register is required, as in color work, this furniture is especially valuable on account of its great accuracy and rigidity.

For regular publications and for locking book pages of

standard sizes it is most practical and economical to use full-length pieces of railroad furniture for filling in margins. This material is made two, three, four, five, six, eight and ten ems wide and any length cut to order. (Figure 37.)

This is the only practical lock-up furniture for use in forms that come to the stone-room regularly and which require the same kind of unbroken margins at each successive printing. The requisite furniture for each publication should be stored away in separate compartments and should never be used for other work. This is a system known as phating lock-up.

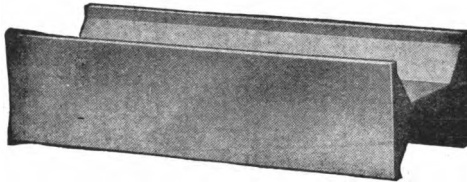

Figure 37

To cover the subject of margins in a brief manner a sixteen-page book-form will be used as an example—sheet-wise make-up, saddle-back and wire-stitched, stock twenty-five by thirty-eight, machine finished, the finished book to be six by nine inches. The head margins establish a basis upon which the distance between pages is figured—the long way of the sheet. In the form cited the type pages are twenty-two by forty ems, excluding the folios. While the position of the printed matter on the page of a book is often a question of taste, on the other hand, the square surface of white space is a fixed quantity. For this reason the amount of furniture to be

placed at the head is not governed by the amount of paper to spare over and above the trimmed size of the book, but rather upon how much of a "bite" is necessary in trimming the top of the finished work. From one-eighth to one-quarter of an inch is ample and this basis of trim is applicable to any work. Having fixed upon a regulation head trim for all book work, the foot trim will regulate itself. By using this fixed head trim for all book work it will be impossible for any cutter or book trimmer to make a mistake or inadvertently to spoil the margins of a catalog by trimming too deep. Presuming that the finished book is to show equal margins top and bottom, or slightly less at the top, then the distance from the folio of an outside page to the head of the next page in the same row should be equal to the trimmed length of the book, plus the "bite," or nine and one-fourth inches. From the folio of an outside page to the one on the opposite side and next to the cross-bar the distance should be just one-half of the length of the sheet, or nineteen inches. Some stonemen figure about one-fourth of an inch less in this latter measurement to overcome variations in the stock. Across the breadth of the sheet the distance from the outer edge of an outside page to the inside edge of an adjoining page should be exactly six inches. From an outside page to the page against the center bar in the opposite half of the form the distance should be equal to one-half of the breadth of the sheet, or twelve and one-half inches. To give the printed matter proper balance on the page it should appear about eighteen points above the center, whenever the margins are ample and sufficient to permit of this. By including the folios in making head

to foot measurements the printed matter will assume this position without making further deductions from head margins. This is applicable only in cases where the folios are placed at the bottom of the page. When the folio becomes part of a running head, measurement should be made from type to type, exclusive of folio, with proper deduction from the head furniture. In the gathered or side-stitched book it is necessary to deduct from twelve to twenty-four points from the side trim, according to the size and number of signatures, adding this to the binding gutters. This is the usual allowance for side-stitched books, to give correct inside margins.

The method of spanning an entire section of pages with an unbroken piece of furniture was a common practice with the old school of stonemen, and it is still being followed by those who are unfamiliar with the causes of work-ups and pull-outs. The method does not lend stability to a form and it is inadequate for many reasons. It must be admitted that there is more "give" to a page of leaded type matter or linotype slugs than to a page made up of solid type and cuts. Therefore, if a section consisting of four rows of miscellaneous pages is spanned with an unbroken piece of furniture, a selection of pressure cannot be brought to bear on the pages of varying character. The shorter or leaded pages will tend to loosen by the jar of the press, and if work-ups occur, it may be attributed to this method of placing furniture. An ideal arrangement of both marginal and lock-up furniture is found in the method known as the individual lock-up, in which no more than two pages are spanned with a single piece of wood or metal locking material.

An inexperienced stoneman may lock a perfect form six to twelve points out of register and he may also severely impair the stability of pages that have been carefully justified and made up to accurate and uniform length. This may be done by locking too tightly on one side of a weak cross-bar while the quoins are loose in the opposite section of pages. To lock a form properly, pressure should first be applied to all of the quoins at the foot of the pages. This should be done as an experimental test of the page and folio alignment, and to force the matter snugly against the heavy center bar, but it should by no means be a part of the final lock-up. If this experiment proves all of the pages to be of equal length, then release the quoins before you begin the final lock-up. Much importance should be attached to this part of stonework, and a neglect or observance of this rule is a good gage of a stoneman's competency. Tighten all of the quoins first by applying uniform pressure with the fingers. Then use the key, locking gently, first on the quoins next to the bars, and from these work gradually to the corners of the form. Great care must be observed to preserve uniform pressure on all sides at all times. The pressure should not be applied too suddenly or too strongly, but rather by a series of lockings consisting of five or six tours of the form.

The "midget" quoin (Figure 38) is an adequate and most satisfactory device for use in crowded forms with limited space for locking. It is locked by a tap of the mallet, and occupies no more space in length when locked than when unlocked. It may be used in a space only eighteen points wide.

In locking book headings with foot notes and other forms which require skeletonizing, it frequently becomes necessary to tie up a considerable amount of much-needed labor-saving metal furniture. This worry and much time

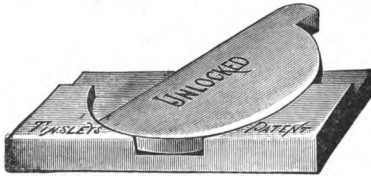

Figure 38

may be saved by installing a cabinet of patent steel skeletonizing furniture. (Figure 39.) It consists of pieces of steel in accurate lengths with notched ends, which can be quickly thrown around blank spaces. For color and blank work it is the ideal material. It is made of twenty-four-, thirty-six- and fifty-four-point steel, five-eighth inch high, and with either twelve- or eighteen-point notches.

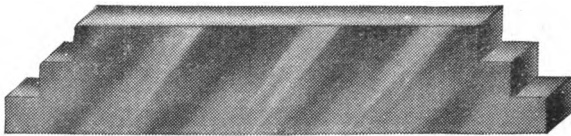

Figure 39

In locking color forms, consisting of electrotypes and halftones mounted on wooden bases it is often found that the blocks are not uniform in size or that the plates are not mounted in exact register. The most satisfactory and successful manner of imposing forms of this kind is to use the system of quotation furniture lock-up in conjunction

with short pieces of one- and two-point leads. Long pieces of solid furniture covering the entire length of plates of this kind should never be used under any circumstances. The method is to place a single quotation from four to six ems in width in the center of the head margin of the plate. A half dozen six- or eight-em leads in conjunction with this will be sufficient for registering purposes. Two quotations of similar size should be used in the margins at the side of the cut, one at the top and the other at the bottom, also with registering leads. Broken and short-length leads that have served their day in the labor-saving case can be used to advantage for this purpose. This method of using a single short piece of metal furniture at the top and bottom of a cut permits of swinging the plate in any direction by transposing a sufficient number of leads in the side margins, either top or bottom. In other words, the plate is thus pivoted on the single pieces of narrow measure metal at the foot and head of the cut. A patented small size register screw is also available for this purpose. These screws are placed on all four sides of the blocks and any page may then be moved in any direction without disturbing the other pages.

Press gripper and side guide edges as related to marginal folding machine drop-roll and guide edges is a study worthy of attention in connection with imposition and lock-up. The subject is too long to permit of being covered satisfactorily in this book.

Narrow book heading chases are almost a necessity in all shops accustomed to handling considerable blank work. They reduce time in the lock-up and are frequently used

to advantage for filling out open spaces on the inside of much larger forms. They are available in all sizes with or without bars. (Figure 40.)

With the introduction of halftone printing plates and enameled, coated and calendered papers came the necessity of hard packing and a firm make-ready for printing presses. The very delicate screens of halftone plates required a much harder and more rigid surface of contact to bring out the details in printing than could be accomplished with the old-time packings and make-ready used

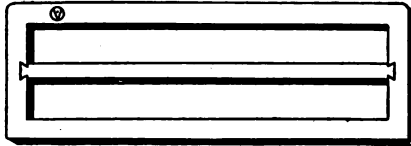

Figure 40

in printing wood, steel and copper engravings. Later on it developed also that the ordinary wooden blocks used for mounting illustrations lacked in rigidity and firmness as mounts for the new fine-screen process plates. They served fairly well for short runs, but it was discovered that the plate became embedded in the block when runs exceeded fifteen to twenty thousand. In consequence of this, metal sectional blocks and register hooks entered the field. Sectional blocks of whatever make are substantially the same, but the accompanying hooks may be had in a dozen different styles and patterns. These blocks are made from extra hard metal, cored on their under side to lighten them and they must be sufficiently heavy for the most exacting impression of halftone or tint plate.

They are designed to minimize the make-ready and to retain uniformity of impression for an indefinite number of impressions. There is no doubt that the metal base soon pays for itself by lengthening the life of halftone engravings. The sectional block of the ordinary type now in use is shown in Figure 41, and a variety of hooks, Figures 42, 43, 44, 45, and 46.

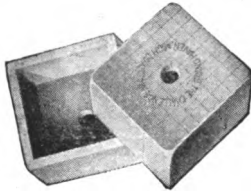

Figure 41

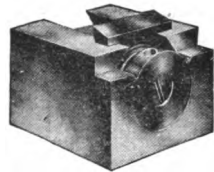

Figure 42

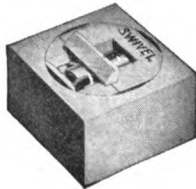

Figure 43

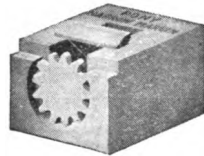

Figure 44

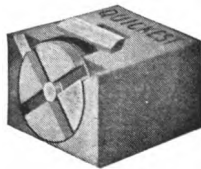

Figure 45

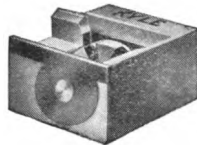

Figure 46

Blocks and hooks are usually six by six picas and eight by eight picas in size and interchangeable. The best of these are made from solid steel and brass and for three-

color plates, which may require registering on the press, the swivel hook (Figure 43) is the most suitable. The center portion or hook is so mounted that it will turn in any direction, even after being locked up in a form. The hook being swiveled adjusts itself automatically to the position desired. Most of these hooks are operated with steel keys (Figure 47) and some of them may be closed or released with the ordinary handle ratchet used with patent electrotype blocks. In printing book forms from electrotyped plates one of the chief items of economy to the stoneman is the patent block. By its use not only the expense of mounting is eliminated, but at the same



Figure 47

time imposition and lock-up are reduced to an absolute minimum. This is by reason of the fact that the make-up and lock-up of a single signature will suffice for an entire volume containing any number of signatures. Usually after the initial form goes to press all succeeding changes are made by the pressman. In the very large book shops it is customary to hold forms of standard make-up in the live rack, thus in some cases practically eliminating stone work. A very satisfactory patent block and ratchet is shown. (Figures 48 and 49.)

Very frequently both press-room and stone-room are too crowded to permit of large, specially constructed form racks. Solid metal sectional racks may be advantageously substituted in such cases. In the press-room the sectional chase and form rack can be put in position

convenient to presses, and forms when received from the composing-room can be temporarily placed in this rack until required for printing. These racks are made in two sections (Figures 50 and 51.) One each of these sections

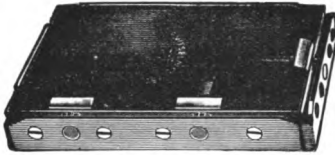

Figure 48

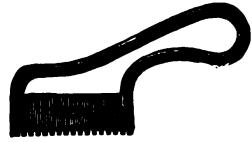

Figure 49



Figure 50



Figure 51

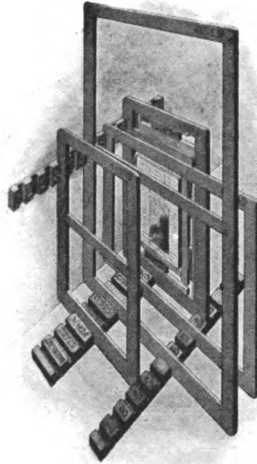

Figure 52

is screwed to the floor and one section (Figure 51) to the wall, as shown in Figure 52. A set thus arranged accommodates six chases or forms. If provision for more chases is required other sets can be added.

CHAPTER IX

Platen Presswork

LET us look to the rollers as the principal medium thru which we may be able to produce good, clean, sharply-printed impressions on a platen press. Such results are possible at all times by the use of good rollers, perfectly adapted to prevailing climatic conditions, and by maintaining these qualities thru proper care and usage.

A little knowledge of the ingredients that enter into the manufacture of printers' rollers will serve well to suggest means by which they may be kept in prime working condition for an indefinite period. True glue is the body and the most essential element of all roller composition. Used alone, without sugar, molasses or glycerine, it would still be possible to produce good roller composition by cooking and bringing true glue to the proper consistency; but rollers, such as these, would be short-lived and they would soon lose their suction and become as useless for printing purposes as a common garden hose. The addition of molasses and glycerin lend durability, suction, the power of distribution, and protection against the deteriorating effects of light and the atmosphere.

Glycerin supplies the moisture-absorbing property. The presence of sugar, molasses, glucose, or saccharine in any form suggests the injury that may be done to rol-

lers by excessive washing with water and lye. The ordinary lye wash not only tends to dissolve and remove the saccharine, but, at the same time, produces a hard roller surface with little or no affinity for ink. Experience has demonstrated that the best wash for printers' rollers is to be found among the petroleum products. Among these are gasoline, benzine, naphtha, kerosene, lubricating oil, tarcolin and vaseline. Lye should be used only in extreme cases, when quick drying inks become thoroly hardened on the surface. Even then dead oil is to be preferred.

It is well known that continuous exposure to the atmosphere is most detrimental to printers' rollers. That is why a fresh consignment from the factory usually arrives well covered with lard or vaseline. If this is not the case the lard should be applied as soon as the new rollers arrive, and they should be allowed to season in this condition, standing upright for at least eight or ten days.

Rollers should never be allowed to remain dry and clean over night after the evening washup. The preservative plan is to wash thoroly with benzine and then cover or roll the surface with news or any other slow-drying ink. Careless washing will not preserve roller efficiency. Remove every streak and speck. A pin's head of hardened ink on the roller, if left until the morrow, will increase to the size of a dime and it may necessitate scraping or an application of lye to remove it in subsequent washing. The habit of permitting rollers to remain in the press after washing at night is discouraged. Sometime a careless feeder may run them on the plate with flattened roller surfaces as a result, and then, again, the over-night

strain on the carriage springs does not tend to improve the running condition of the press.

It is customary to wash copying ink rollers with cold water, but this method is not recommended where these same rollers are subsequently to be used for colored and black job inks. A better plan is to remove the major portion of the ink by running the rollers over cardboard or paper on the plate and then rolling with common news ink. This will permit of a final washing with benzine or gasoline. This is the thoro method.

It is a matter of economy to have roller molds for all of the platen presses. Old cylinder press rollers may thus be remelted and, by mixing a new composition, any pressman can cast very satisfactory rollers for copying ink jobs, brass-rule, scoring and perforating rule forms, all of which give most severe service to any rollers. Roller-composition may be purchased in cakes from the manufacturer.

In printing brass-rule forms it is always well to endeavor to lock so that the rollers will traverse the rules horizontally. If the form will not permit of this the usual plan is to lock six-point guard rules or bearers in the margins of the form to prevent the rollers from cutting into the sharp ends of the rules.

Forms containing perforating rules, if printed in the ordinary way, will cut up a set of rollers in a single run of one thousand impressions. A new wrinkle, which is at once an improver of perforated printing and an immense roller-saver, is a less-than-type-high steel perforating rule. If you are unable to secure this rule from your supply house it is advisable to take the ordinary foundry rule to a machine shop and have it planed down to about one

point less than type high. When locked in the form this rule will not come in contact with the rollers. The plan is to build up the impression from the tympan with narrow strips of tagboard or rubber, thus forcing the paper against the rule from the plate instead of pushing it into the paper, as in the case where more-than-type-high rule is used. It is obvious that the appearance of the job will be improved as well, by reason of an uninked perforation.

Roller bearers are more destructive to rollers than useful in preventing slur or uneven traverse of the carriage. If the roller trucks are true to roller circumference there will be little need of bearers and slurring or blurring of type or rules may be prevented by applying powdered rosin to the tracks, by the use of hard packing, a perfectly smooth and taut tympan, and by maintaining correct adjustment of the working parts of the press. Frequently it is impossible to secure a sharp impression because of careless washup and the consequent oil and grease on the plate.

On a three-roller press the lower roller usually is subjected to the hardest usage. For this reason the rollers should be interchanged from time to time to give them more uniform wear.

Oil every bearing each day before you begin a run and clean the ink fountain thoroly at least once a week.

PLATEN PRESS MAKE-READY

In this limited space it is unnecessary to supply a detailed description of the ordinary make-ready for plain forms of type and rules. Halftone printing on platen presses will be of greater interest and of more practical

value to the pressman as a lesson in make-ready. Eugene St. John, a well-known pressman, whose extensive knowledge has been gained thru unlimited experience, has consented to supply a few paragraphs in reference to this branch of make-ready. He advises as follows:

The halftone may be printed perfectly on the platen press under favorable conditions. The printing surface of halftones in a form should not be over one-half the inside capacity of the chase, else the inking facilities and impressional power of the platen machine may be overtaxed. Good stock—preferably enameled, dull-finished, coated or supercalendered—and an ink finely ground and free-flowing, to avoid “picking” and “pulling,” are necessary. The press should be run not faster than one thousand impressions per hour.

The form should be in the center the long way of the chase and a little below the center the other way, and securely locked. Place the form in the press and clamp securely. Remove the gages and dress the platen with new tympan of two sheets of smooth book paper. Have the impression square and rigid enough for one sheet of three-ply packing to suffice. Take an impression on sufficient sheets of book paper to render the impression on the edges of the cut discernible as a guide for underlaying. Level the cut on the corners with underlays and then underlay the base from center to edge with three overlapping ovals of french folio to take up the spring and hold center of cut to the rollers. The underlay should bring all of the cut except a vignette edge to type hight, but no higher.

On the heavier makes of platen machines it is not necessary to use paper thicker than french folio, unless the cut is very heavy, but on the lighter Gordon machines book paper is frequently necessary for solids and sub-solids. The first step is to build up the impression from the center with the overlapping ovals of tissue or folio according to the size and extent of solids in cut. Then cover the entire subject of the cut with french folio and each tone with an additional thickness, beginning with one thickness for the tone next to high light and adding one thickness for each

heavier tone. Where three thicknesses of folio are needed on a given portion of a cut it is more expeditious to cover this portion with a single thickness of book. The overlays should be cut and applied so as to fit exactly where needed, else the result will be less satisfactory than mere flat printing. Paste these overlays securely on the impression on top of one of the two tympan sheets with a thin paste free from lumps. Now cover the make-ready with two sheets of book. Two are better than one, softening abruptness between tones. Now take an impression on the top sheet and set the guides, which should be secure, so that tipping will not be necessary. Move the grippers up so that they just clear the form and pull a last impression for careful inspection before running. The impression may be a little heavy. If so, tear an under sheet from the tympan or substitute thinner packing for the cardboard. A break in the high lights may be overcome with a patch of tissue. The edges of vignettted cuts, after the rest of the make-ready is finished, may be scraped and cut away. Except where the cut has been hammered down or "dished" in previous printings the above treatment will be found sufficient. A "dished" cut should be remounted.

THE INK CLOSET

High-grade and costly colored and black inks should never be allowed to remain uncovered for a great length of time. The surface of the new can should be covered with a closely-fitting sheet of oiled paper, and further to prevent hardening or "skinning over" a one-fourth inch layer of vaseline or lard on the top of the oiled sheet, will answer the purpose very satisfactorily. Lift the corner of the oiled paper covering and remove the ink from the can very carefully with an ink knife as required. The common habit of jabbing an old piece of dirty reglet into the can and allowing it to remain there is wasteful and tends to degrade delicate tints and colors. Observe system in the arrangement and shelving of ink cans and do not permit



Figure 53

the closet to be strewn with old waste, empty cans and loose bronze powder. Bronze powders should be kept in separate compartments, preferably airtight drawers. An ink closet, presenting an ideal and orderly arrangement of materials, is shown in figure 53.

BRONZING

Gold and aluminum inks have been brought up to a very high standard within recent years, and in consequence the distasteful process of bronzing is on the wane. Bronzing is necessary, however, when very brilliant effects are desired. To imitate gold leaf stamping with ordinary bronze powder it is usually customary to give the dusted sheet a second impression by running the form without rollers or ink. The process tends to flatten and impress all loose particles of powder, thus producing a smooth and brilliant effect in the finished work. Besides bronze powders many other granulated and powdered materials may be used with novel effect. Wall paper flock, applied similarly to bronze powder, with cotton, gives the appearance of a cloth or felt finish. For these foreign substances a size of superior adhesive qualities is required. Ordinary bronze size is inadequate. A special glue size, made for the purpose, may be purchased from any ink house. Colored and flint sands, and emery powders may be applied in the same way.

The use of sand in this manner is resorted to in the manufacture of advertising novelties containing sanded match scratchers. Magnesia, tinsel, mica, and metallic filings are used for decorative purposes in the manufacture of post cards and Christmas novelties.

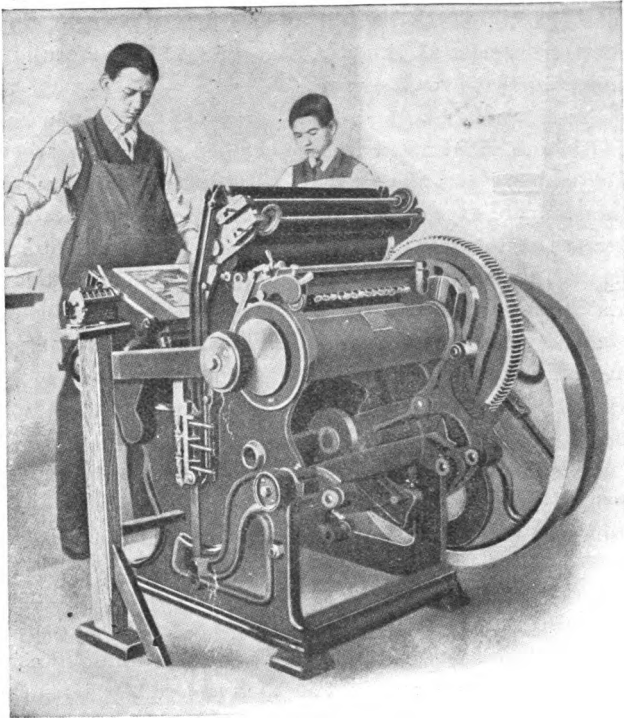

Figure 54

IMITATION TYPEWRITER LETTERS

The typewritten effect may be produced by printing thru ribbon by either of the following methods: By spanning the grippers with thin china silk and printing thru the fabric or by locking the silk between the furniture and pulling it over the form.

A patented device, with an unwinding and re-winding continuous ribbon attachment, is now on the market. The ribbon is of the same prepared material as used on the standard makes of typewriters and the form can be printed thru the fabric by running the press without rollers or ink. Another method is to print from zinc-etched plates, and rubber stamps mounted on electrotype blocks are also used, the latter especially on combination printing and addressing machines.

PEBBLING AND DIE-CUTTING

Pebbling may be imitated on a Gordon press by the use of sandpaper, mounted on a type-high block. The press must be run without ink or rollers.

Ordinary clasps, openings in covers, slits and odd shapes may be die-cut on any platen press by the use of ordinary steel cutting rules. These are locked in the form and filled in with furniture the same as brass rule work. Ordinary bottle corks are glued in the open spaces to release the sheets from the rules during the process of cutting. The back of an old brass galley or a piece of zinc is placed behind the tympan sheet to act as a cutting surface for the rules.

A modern platen press, with individual motor drive, counter, vibrating fountain rollers, roller carriage throw-off, and other improvements, is shown in figure 54.

CHAPTER X

Cylinder Presswork

AS a matter of immediate importance it is only necessary to cover those portions of cylinder press mechanism and adjustment* which directly concern impression, make-ready and sheet delivery. Of these the adjustment of cylinder to bearers is of first interest. When the bearers are low or when the cylinder is over-packed, certain impression defects will soon make their appearance in the printed sheet. The experienced pressman is not slow to recognize these blemishes and by their character he soon discovers the cause. When vignetted halftone illustrations begin to show blackened edges, and when there is an apparent slur or "drag" of rules and type lines at the "tail" of the sheet, or where it leaves the cylinder, there is evidence that "the impression is riding the form." In most cases where this trouble cannot be attributed to the make-ready, the fault lies in the improper adjustment of the cylinder to the bearers.

The hight of the impression should be tested at least once a month by the use of the pressman's type-high gage. There is a long-handled tool of this kind with

***EDITOR'S NOTE.**—The matter relating to cylinder press adjustment was prepared by the author from notes collected during an association with John E. Cashion, a pressman of recognized authority. Mr. Sherman and Mr. Cashion were at that time co-operating as instructors in typography and presswork, respectively, in a printing-trades school.

which the work may be done easily and quickly. The method is to move the press to the back center and remove the screws from the bearers, which are accessible from the rear of the press. Then run the press to the front center to remove the remaining screws. The press should then be reversed to the center to take off the bearers. All hardened oil, ink and other foreign matter should be thoroly removed from where the bearers lie, for even the thickness of a piece of book paper under one end of either bearer will have an appreciable effect upon the impression. The bed should then be moved forward to bring the cylinder directly over its center. At this point lower the cylinder as if to take an impression and place the type-high gage between the bed and the cylinder bearers.

Before going farther into the adjustment of the press, it may be well to add that all machines do not have the same impression mechanism, and on some presses no attention need be given to the steady screws under the cylinder boxes, or to the "jackscrews," as they are called in the press-room. If the cylinder is too high, loosen these screws and lower them out of the way, and then loosen the check nuts on the lifting rods and bring the cylinder down—slowly at first—on one side and then on the other. Test the hight with the type-high gage during each stage of the adjustment. When the cylinder is just type-high, be sure that the check-nuts are tight, and then proceed to raise the steady screws to the cylinder boxes. These screws should be set snugly, but do not force them up. It is essential to test the hight once more before moving the cylinder. Exercise great care to maintain a uniform hight between press bearers and cylinder bearers on both sides of the press.

After the press has been thoroly overhauled in this manner, it is further necessary to examine the bed bearers to be certain that they are type-high and free from low places. This should be done by placing the type-high gage over the bearers and by moving it slowly from one end to the other. The gage should fit snugly the entire length of the printing stroke. It often occurs that the bearers are worn low. In these cases a strip of manila paper, such as is used for draw sheets, should be placed under them—enough to bring them to type-high. This underlay strip must be of full width, with holes cut to conform with the screw holes in the bearer. Replace the bearer with its underlay as described and screw it down firmly.

A practice which is most damaging to vignettted cuts, type and bearers, consists of crowding the capacity of the press with forms that are too large. Cuts are often locked on the bed of the press without a chase to accommodate an extra large sheet. The rear ends of the bearers in all presses are reduced slightly in hight, and in some presses both ends of bearers are reduced, so that the cylinder is lifted gradually upon them. This clearance also affords freedom of action when the bed reverses. When a form crowds the rear of the bed, the cylinder rests upon the form at this point with its entire weight. It is impossible to preserve the delicate edges of vignettted cuts under these circumstances.

Some pressmen make the mistake of setting the grippers to the pressboard packing before the cylinder dressing or top sheets have been applied. As a result, the top sheets and the tympan have a tendency to force the cam away from the stop, which causes the grippers to dig into

the sheet and throw it out of register. To secure perfect register the grippers should not be set or adjusted until the full amount of packing and dressing has been put on the cylinder.

It is frequently necessary to readjust the intermediate driving gear in most makes of cylinder presses. This gear should be set to run in close mesh with the main cylinder gear and the driving gear when the cylinder is down on the impression. To set the intermediate driving gear, it is necessary first to remove the gear guards. Then move the press over on the impression and loosen the intermediate gear while the cylinder is down. After this has been done the pressman should stand in front of the gear and with both hands slide it in and out at various points on the impression. If the gear binds, it should be reset. To do this loosen the stud from the inside of the frame of the press and drive it out so that it may be turned easily, and then set the stud so that the gear can be slipped off and on to the stud without binding the teeth at any point on the impression.

Next in importance are the sheet bands. These should be adjusted after the cylinder has been moved around to where the grippers are opposite the bands. At this point the pressman should loosen the bands and move them along the rod out of contact with the grippers or "shoo-fly" fingers. Then the press should be moved forward to the point of taking an impression, for the purpose of adjusting the bands to the cylinder. Take a strip of three-ply cardboard, one inch wide and about four inches long, and place it between the bands and the cylinder and set them firmly up to this card. Then test the setting by moving the card up and down as the adjustment is being

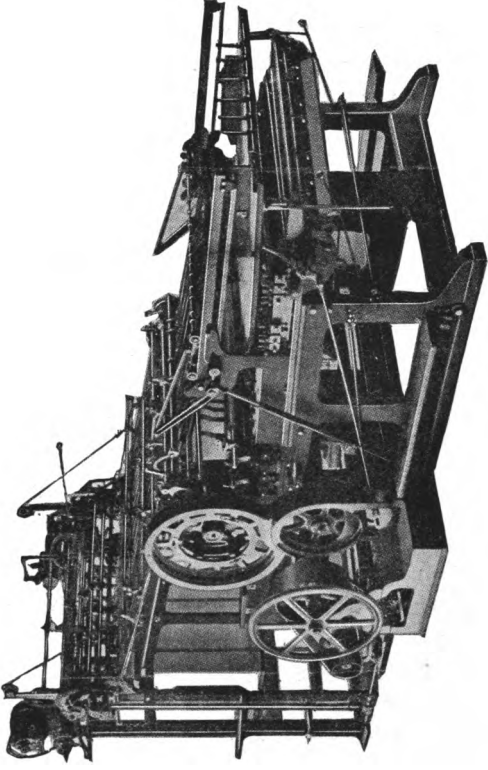

Figure 55

made. The bands should apply uniform pressure to the sheet at all points. It sometimes becomes necessary, when running forms composed of brass rules, vignettted cuts, and close register work, to hold the sheet more firmly to the surface of the cylinder during the printing stroke. This can be done by placing a tape around the cylinder between the center margins of the form, fastening it to the rod which supports the sheet bands and tacking it to a convenient point beneath the feed-board at the rear.

The cylinder press of today represents a wonderful transformation of the machine of but a few years ago. Its speed has been more than doubled, its product is superior in every way, and with the addition of the automatic feeder, carriage sheet delivery, the individual motor, and mechanism for dissipating static charges, it would seem that the limit of improvement has finally been reached. And yet, each day the patent office brings forth ample evidence to the contrary and proof positive that the improvements in the cylinder press will be even more radical during the next decade. A flat-bed cylinder press of the very latest type, with automatic feeder attached, is shown in the illustration (Figure 55).

The automatic feeder is now a substantial factor in every well-equipped cylinder press-room. Its infallibility, speed and accuracy in handling large sheets that require close register feeding are undisputed and the day is not far distant when the automatic feeder will entirely supplant hand feeding in the large book houses. This emphasizes the importance of adding a few brief paragraphs on feeder adjustments, especially relating to features that are of direct concern to the pressman.

In the type of feeders which move and control the

sheet by combing wheels the adjustment of the feeding friction rollers should be thoroly understood.

The mechanism of these parts is shown in Figures 56 and 57 for the purpose of more clearly describing the

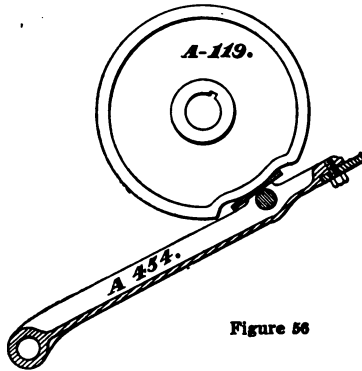

Figure 56

adjustment, which is made in the following manner: Place a one-eighth of an inch gage strip between the bottom of the drop of the cam A-119 and the cam roller, as shown in Figure 56. Then adjust both friction rollers

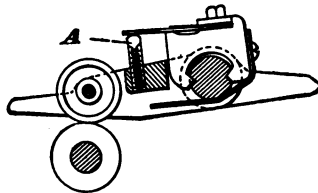

Figure 57

so that they will barely bite a piece of paper. To adjust turn the screw marked A in Figure 57.

The adjustment of the latch arm is made by placing a three-sixteenths of an inch gage piece on top of the piston stem of the right-hand head and by allowing the weight of the combing wheel to rest on this. (Figure 58.) Then adjust set screw in arm A-95 so that the latch on A-103 is even with the edge of the steel face on arm A-104. The left-hand head should be adjusted in the same manner. When this adjustment is made the roller must be on

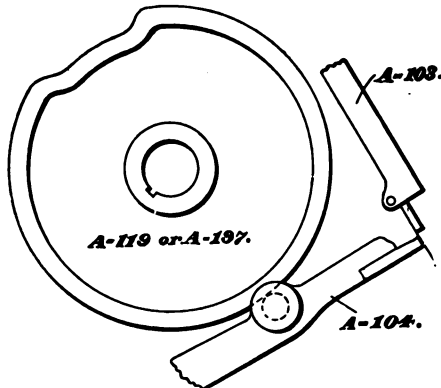

Figure 58

the high part of the cam and the other combing wheel must be held all the way up by using a wedge on the piston stem, or by other means.

When down, the sheet steel trip arm A-79 (Figure 59) should project three-thirty-seconds of an inch below the top face of the feed-roller bracket A-123. When in this position, place a three-thirty-second-inch curved gage in each groove under the finger marked X, the groove being three-sixteenths of an inch deep, and allow the fingers of

the arm A-79 to rest on these while tightening the screws which hold the arm in place.

It is very essential to the perfect operation of the machine to keep the feeder valve clean and free from paper lint. Valve and chamber are shown in Figure 60 to demonstrate clearly the method of cleaning. Begin by disconnecting the hose A from the nipple B and then

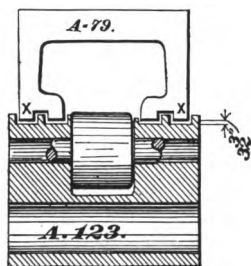

Figure 50

take out the bolts marked C to remove valve casting A-75 from the feeder head. After this has been done take off the cap A-76 and remove the valve stem A-231. Now thoroly clean inside of valve chamber and valve stem, using benzine if necessary.

I shall dwell but a moment on cylinder press make-ready. A paragraph on overlays for halftone illustrations will suffice.

Pressmen who have made the question of overlaying a scientific study are of one opinion that the various thicknesses required should be regulated with extreme exactness. It is folly to look at a cut only superficially and say that selective portions require an eighty, a forty or a ten-pound overlay, or no overlaying, as the case may be.

The maximum range of an overlay should not exceed .005 inch, and this and the intermediate thicknesses should be measured with a micrometer. The careless habit of using any available paper and perhaps four or five qualities is a chief cause of indifferent results in the various portions of a large sheet of halftone illustrations. It is even possible to put the amount of overlay required for certain screens in exact terms. In a one hundred- or

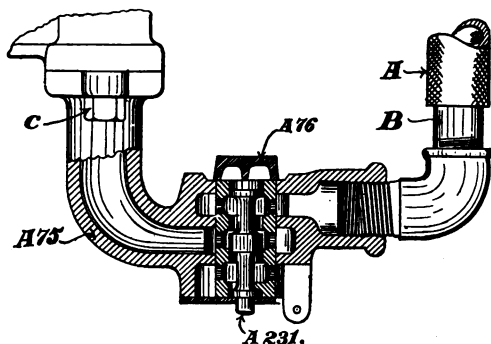

Figure 60

one hundred and thirty-three-line engraving the maximum thickness in the deep shadows should be .0045 inch. This should be reduced gradually in all the tones from deep shadows to extreme high-lights or whites. Medium shadows or quarter-whites would thus require .0035 inch or a ten-pound folio less than the deep shadows; the grays, .0025 inch, and the three-quarter whites, .0005 inch (equal to a french tissue). Extreme high-lights or whites will not require overlaying if these gradations are strictly adhered to.

There is still another detail which must not be over-

looked, and that is the character and quality of the halftone mountings. Any kind of wood makes a poor base for halftones which are to be subjected to long runs. Fifty thousand impressions may cause the metal backing of the copper shell to sink .002 inch into the wooden base, which will seriously weaken the effect of the overlay. The leading makers of high-grade illustrated catalogs recognize this fact, and the metal base and the patent hook are rapidly supplanting all other mountings for halftone engravings. For, of what consequence is a hard packing, a good make-ready and a firm impression if the cuts are mounted on a spongy base? Good cuts, metal bases, a hard packing, a cut-out overlay as above described, and a good machine properly adjusted, will produce the exceptional results you are striving for.

CHAPTER XI

Printing Inks

EVERY day brings forth some new requirement in the production of certain results in printing and it is quite true that the ink problem is the most complex of those with which the pressman has to contend. He requires a hundred grades of ink to produce the best results on a hundred different surfaces. An ink that has been specially prepared for use on hard bond papers will not give the proper results on coated paper; the reds, yellows and blues used in commercial printing would be pronounced failures if applied in trichromatic printing with process plates; to attempt to use a slow-drying ink on an automatic press which prints from four to five thousand impressions an hour would mean destruction to the work; even a good job ink would make a poor cover ink and it would be hardly possible to use a fairly good cover ink for printing on brass and aluminum unless properly prepared with suitable dryers.

Fabric-finished papers, wrinkled and figured stock, highly glazed, coated and calendered papers, meltons and hard bonds—all of these demand special technical knowledge of inks and their covering and working properties.

The exacting requirements of printing inks and papers brought about by the modern invention of fine screen halftone engravings and rapid presses is a subject that has

been covered in a very interesting manner and at considerable length by a well-known German manufacturer of printing inks. A translated excerpt from this paper will be of interest. The demands upon the ink maker and the paper manufacturer are set forth as follows:

A most revolutionary effect in the manufacture of printing inks and printing papers resulted thru the wonderful improvements which Levy (an American) made in methods of reproduction by means of screens. The very fine Levy screen, with its one hundred and seventy-five, two hundred and even three hundred dots to the square inch, produced printing plates whose fine halftones made the greatest possible demands on paper and inks. The fine qualities of coated papers required for halftone work were first successfully made and used in America, and it is also to America that we owe the first suitable halftone inks. These glossy papers were used for the majority of the better class of publications, and it is now well understood that many of the beautiful and luxurious editions and periodicals published within the last few years, at an immense expenditure of time and work, will last but a short time. And it is most especially unfortunate that the artistic inspiration which has expressed itself in the illustrations and composition and the printing of such works, will not become a heritage of future generations. It is doubtless true that the high gloss obtained by means of hot calendering makes possible an extraordinary clear and clean impression; that the delicate network of the modern halftone prints on such paper so smoothly and softly in the finest halftones that a delightful effect is produced. It is therefore no doubt a difficult task to cast such papers aside, and it is just where we wish to attain the highest possibilities of the halftone process that we would wish to continue to use such papers as long as no good substitute can be found. To produce such a substitute must therefore be the highest ideal towards which the paper manufacturer should strive.

In short the author of this paragraph frankly admits that we have attained the very highest perfection in the

combination of halftones, highly finished papers and modern process inks, but he laments the fact that the product lacks the enduring qualities of the letter-press of a decade or even a century ago.

But, even as we have improved the quality of the product so are we at this very moment making strides toward the improvement of the lasting—the enduring—qualities of these excellent products of the modern printing press. An important step in advance is found in a declining use of these very highly finished, glossy and chalky surfaced papers and in the substitution of the new-process, dull-finish papers. The ink maker, encouraged by the efforts of the paper maker, is doing his share by producing inks that are in perfect working harmony with these new ideas in halftone printing papers. In these new, unglazed papers the coating is made thinner, its composition is improved, and thus the gloss is avoided, and yet there remains a soft and agreeable surface and a sympathetic texture. Furthermore the chemical properties of the surfacing of these papers has been improved toward giving longer life to the inked impression.

So much for halftone printing in black and white; but, before we touch the problems surrounding the use of colored inks it will be well to go deeper into the practical side of black inks as used in everyday commercial work.

On very hard papers, or papers that are highly glazed, certain inks take hold with difficulty. Others may adhere readily but dry slowly. The trouble may be remedied by printing a second time with a little varnish mixed with dryer. The ink will be quite dry in a few hours

and the second impression will give a luster to the color. Upon gelatin paper, which has an extremely hard surface, it has been found advantageous to make the first impression with varnish. This should be allowed to dry thoroly before running a second time.

When ink is too stiff for use on coated or delicately-surfaced paper it should be reduced with linseed oil or vaseline. With some grades of ink common lard is even more effective. Never use a reducer to excess, as it tends to degrade the color. If picking or pulling is caused by the low temperature, it is far better to remedy the trouble by supplying the proper heat in the press-room than to attempt to improve matters by the use of ink reducers.

A stiff, finely-ground ink should be used on hard bond papers. The right quality will cover well and lend a sharp impression to small lining gothic types and card fonts, while a free-flowing ink would require an open fountain, with blurred and filled letters as a result. It is always best to order inks specially prepared for the purpose, from a reliable ink house.

Copying inks should be reduced with glycerin, not with water.

It is a matter of economy to buy inks which require little or no reducing. There are a number of special admixtures, however, sold under trade names, such as "Lakotine," many of which are of the consistency of free-flowing ink. A good reducer of this kind will add materially to the working qualities of the ink without deteriorating its color. These special reducers increase the covering qualities of any ink, which is a matter of economy at the outset, and they add enough in volume to

effect a considerable reduction in the total cost per pound. These are points of superiority not found in the ordinary petroleum reducers.

High-priced gloss inks are of little practical value. They dry out rapidly and go to waste in the can. It is more economical and quite as satisfactory to add gloss varnish to a good quality of medium-priced ink.

By adding an aniline dye-stuff to an ordinary job black the sheen of bronze inks may be produced.

A thick, solid or heavy appearance is secured by mixing white lead with the ink. The opposite or a transparent effect is produced by using magnesia. A granulated appearance of the color is produced by adding a saponaceous or a spirit varnish to the ink. When varnish of this kind is used the ink in the fountain should be worked up frequently with a knife.

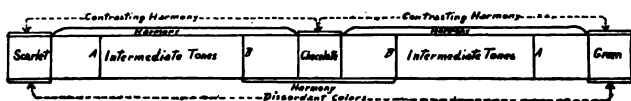

Figure 81

In an article on "The Science of Printing Colors," in the April, 1906, issue of THE AMERICAN PRINTER, I formulated a law and set forth a simple method for producing harmonious color relations. An entirely original diagram illustrating the scale of color value was included also. This entire article was reproduced abroad in one British and two continental printing trade publications. The theory of color harmony as set forth and the practical utility of this method of determining correct color values have left their mark upon the products of the color printer.

A detailed chart for producing harmonious color relations in accordance with the laws as set forth in the article of 1906 and apparently based upon the crude diagram illustrated at that time (Figure 61) has just lately been patented and is now published and distributed by a leading ink house as "Maratta's Chromatoscope."

Marked improvement has been made upon the idea and diagram as originally set forth, but the logic and sound practical worth of the matter pertaining thereto remains unchallenged as a valuable lesson on the subject of color printing. The essence of the article is as follows:

The study of color values is our first lesson in color harmony. We can approach or arrive at any color from black or white or from any other contrasting color. That is to say, we might continue to add green to scarlet until the mixture represented an equal quantity of each color and the result would be a deep chocolate, and then, if we continued to add green in increasing quantities, we would gradually arrive at a deep green, which would grow to a brighter tone as we increased the proportion of green. To illustrate the scale of values let us arrange these colors in a band with scarlet to the left and green to the right, as shown in the diagram. Instead of working from scarlet to green, we will approach chocolate in the center, from the two ends of the band. To scarlet we add increasing proportions of green, thus producing all the intermediate tones, until we finally arrive at chocolate in the center. To the left we have a scale of values, each tone being related to scarlet and chocolate, the two extremes. A similar scale is noted to the right, between chocolate and green. Straight scarlet and green, on both ends of the

band, produce a discord if worked close together in equal proportions. A printer with a keen perception of color harmony would consider bright red and bright green a poor color scheme. He would produce harmony by adding a small quantity of green to the scarlet to bring it to the tone in the scale marked A, and by softening the green with scarlet, in like manner, to bring it to the tone in the scale marked A in the opposite end of the band. These two hues worked together would make an agreeable color scheme. If he would produce a warm effect, in complete harmony the admixture of green and scarlet should be increased in both cases down to the neighborhood of B in both sides of the scale. The result would be a reddish brown and a deep green—a most excellent choice of colors. All the tones between scarlet and chocolate are in harmony and any two of them may be worked together with propriety so long as they are separated from each other by a sufficient number of degrees of value. The same is true of the hues in the right side of the band.

According to the diagram, scarlet and a greenish chocolate would form a strongly contrasting color scheme, and yet harmonious, while at the other end of the scale green and chocolate would produce an equally harmonious and strongly contrasting color scheme. Some of the most agreeable color combinations are produced by the association of various tones of the last-named colors.

Primary colors should not be used with the complementary colors next to them, as yellow and green, blue and green, red and purple, yellow and orange, red and orange, and similar combinations. Neither should a color

be printed upon paper of its complementary color. For instance, blue ink upon green paper would be dull and unsatisfactory. This relates to straight colors only and does not refer to the association of the hues and bi-hues. Any of these may be used together if they are modified or reduced to hues which incline toward each other. That is to say, an orange-yellow and a bluish-green will form a more pleasing combination than yellow and green.

THREE- AND FOUR-COLOR PROCESS INKS

Trichromatic printing plates, in which the tonal values of the three registering printing surfaces are produced by photo-mechanical means, have opened up an entirely new field to the ink maker and the colorist. We are far from exact when we speak broadly of reproducing the exact colors of an original subject by successive printings of yellow, red and blue from as many plates in which the tonal values have been properly and selectively graduated. Superior results in three-color printing from process engravings are dependent upon far-reaching scientific research on the part of the ink maker. The yellow must be absolutely correct, and such a color cannot be produced by mixing.

Chrome yellow and yellow with a reddish tint have been used with indifferent success, but the permanent and the truly correct shade can only be produced by the use of cadmium yellow, zinc yellow or chinese yellow. The blue should be between peacock blue and verdine green. Some pressmen add a very small quantity of very light green to the process blue generally sold by ink makers, to bring it to the proper tone. If you prefer to

avoid experiments it will be well to order a special peacock blue from a reliable ink house. A good and satisfactory process red is difficult to procure. There are few reds that can be termed permanent in the strict sense of the word. To produce the best results it is often necessary to add a very slight touch of blue to the process red commonly sold. This lends brilliancy to the finished picture. I would advise a red of a tone somewhat between rose bengal and erythrosine.

Arthur Freiherrn Von Hubl, of Vienna, Austria, an eminent authority on color photography and trichromatic printing, says: "We must select a yellow without a red shade, a pink-like carmine and a greenish-blue."

CHAPTER XII

From Superintendent to Shipper

“**F**ROM the Superintendent’s Desk to the Shipping-Room” pertains to system. It conducts the work in an orderly manner thru every process of manufacture and affords means of securing a positive knowledge of costs at every stage of the journey to completion.

Too much system is likely to entail a millstone of red tape. Lack of system is still more dangerous to success from the opposite point of view. The safe and sane position is the one occupied by the printer who adopts only such records and systems of entry which have proven advantageous in conducting the most successful establishments. By selecting one or two of the best records of entry from among those in use in a dozen reputable plants and by eliminating the “not absolutely necessary” we will have a series of cards, tickets and other records very closely approaching perfection. Such a system will be neither cumbersome nor insufficient.

Lest this chapter exceeds the space allotted the subject, it will be necessary to eliminate business office entries, which include estimates, purchases and general accounting. That branch of the subject has been ably handled by Ransom Dickinson Pratt in a series of articles on

JOB TICKET		Job No. _____
ASK IF YOU DO NOT UNDERSTAND ASK		
190		
THIS JOB MUST BE DELIVERED BY	Form _____ Order _____ Reg. _____	QUANTITY _____ OVER _____ SHORT _____
For _____		
Kind of Work _____		Size <input checked="" type="checkbox"/> _____ " <input checked="" type="checkbox"/> _____ " <input checked="" type="checkbox"/> _____
COMPOSITION _____		
Proof to _____		Proof Promised _____
Set _____	Number of Press _____	Imprint _____
No. of Plates _____		Proof Set _____
_____ 2 Side _____		Work and Turn _____
_____ Proof Ret'd _____		
PRESS WORK _____		
Color of Ink _____		
Changes _____		2 Side _____
_____ Work and Turn _____		
PAPER <input checked="" type="checkbox"/> _____	Color _____	Sheets _____
<input checked="" type="checkbox"/> _____	" _____	Sheets _____
<input checked="" type="checkbox"/> _____	" _____	Sheets _____
Cover <input checked="" type="checkbox"/> _____	" _____	Sheets _____
CUT _____	After Ruling _____	After Perforating _____
RULING _____		
_____		Proof to _____
BLINDING _____		
_____	_____	Sent to Bindery
_____	_____	Sent to Job Room
_____	_____	Sent to Press Room
_____	_____	Returned to Bindery
_____	_____	Sent to Shipper
_____	_____	

Figure 61 a

"Accounting for the Printers' Cost" in *THE AMERICAN PRINTER*, volumes 45 and 46.

After the job has been entered in the order book and

JOB RECORD

Job No.	For Whom	Description	When Received	When Promised	Comp.	Proof Sent	Proof Returned	Sent to Stock-room	Sent to Press	Sent to Bindery	Sent to Shipper

Figure 62

the specification blank returns to the superintendent's desk the next step usually places the work into the hands of the foreman of the composing-room, the exception being in the case of blank books, ruled headings and work of similar character which first must go to the bindery. The vehicle of conveyance from the business office to the manufacturing departments is thru the job ticket or job envelop. This is the record of greatest import to the perfect progress of the work. It must be complete and filled out in detail, even to the extent of obviating verbal explanations. As a perfect job ticket it must contain a description of every process required to complete the work in the composing-room, in the press-room, in the bindery, in the stock-room, in the cutting department and, finally, instructions to the shipper. The best device for this purpose, and one which has given complete satisfaction in a model plant, is in the shape of a commodious envelop and job ticket combined. This I will designate as the Exline job envelop. A facsimile as used by this progressive Dallas (Tex.) house is shown (Figure 61a). One of its most excellent features is its large size, ten by twelve inches, which permits of enclosing a considerable amount of copy. All other tickets in the shape of cards or printed blank forms are impracticable. Forms of this character are responsible for much loss of copy and other valuable data, which must be attached thereto with clips and pins. As to entry spaces, front and back, the Exline envelop is complete, and, if properly filled by the superintendent, it will conduct the work in an orderly manner thru every channel.

After this ticket reaches the composing-room foreman's

COMPOSING-ROOM TIME TICKET

DATE _____ JOB NO. _____
 CUSTOMER _____ DESCRIPTION OF JOB _____
 WORKMAN _____ STYLE OF JOB _____

8	7	6	5	4	3	2	1	12
Job Composition	Makeup	Stone Work	Alterations	Distribution	Job Composition	Makeup	Stone Work	Alterations
Distribution								Distribution

RECAPITULATION

JOB COMP.																				
MAKEUP																				
Stone Work																				
ALTERATIONS																				
DISTRIBUTION																				

Figure 65

desk it should immediately come into touch with another very important record. This shall be designated the "Composing-Room Record of Jobs." You will see the value of a book of this kind (Figure 62) as now used by the Dorsey Printing Company, recognized as one of the best regulated complete printing concerns in America. Similar records, paged and numbered in like manner, are also used in other departments. When entries are properly made this book takes the place of the multitude of tickets which help to make up the more cumbersome systems in daily use thruout the country. This record is put up in a serviceable binding of canvas, paged and numbered to hold one hundred job entries to the leaf. Here is a positive check on every job in hand, enabling the head of any department to report the condition of the work at a minute's notice. With the exception of the columns "For Whom," "Description" and "Compositor," all other records are filled in with a rubber dater. If the superintendent telephones to the foreman of the composing-room for a report on ticket number 42136 it is only necessary to turn to leaf 100 which will show that the work is in the hands of Brown, compositor, or that proof has been sent to customer, or that the work is in the bindery, the press-room, or in the shipping-room for delivery. A call to any other department will meet with similarly prompt response.

After the foreman of the composing-room has made his job record entry his next step will be to examine his ticket carefully preparatory to turning the work over to a compositor. He will note the quantity and size of sheet which should govern the advisability of setting one or

two on, or of sending the work to the foundry for the purpose of making a set of electrotypes. Spaces for these notations are supplied on the job envelop (Figure 61a).

After the job has reached the compositor the time ticket will be the next record to come into use. A very simple form is recommended, preferably a ticket divided into ten or fifteen minute columns (Figures 63 and 64). It is unprofitable to burden the workmen with too much system. For this reason all entries of time should be shorn of detailed annotations. It is useless to specify time for office corrections, taking proofs, etc., unless these items come under the head of author's alterations, which entail additional charges.

The above ticket, or tickets very much similar in character, are giving satisfactory service in all departments of the Matthews-Northrup Works, Buffalo; Woodward & Tiernan, St. Louis; The Henry O. Shepard Company, Chicago, and other well-regulated plants. Time ticket entries should correspond with total time entered on the back of the job envelop. An additional time slip should be used when a number of men are employed on the same job. A small slip of memorandum size will answer the purpose (Figure 65.) This slip should be turned in to the man in charge of the job at the close of each day. It is customary to preserve these slips on a spindle until the completion of the work, when the time is totaled and entered on the back of the regular job envelop. This saves unnecessary accounting in the business office. Time tickets of similar size, style and character should be used by the workmen in all other departments.

From the compositor's frame the next journey is to the

proof-room. A great deal has been said recently concerning methods of proving and about sending proofs to customers. The plan of taking hand-press proofs in the exact colors specified and on the stock called for in the finished product is advocated by some. This is time-consuming and expensive. A better plan, and one practiced by a great many successful printers, is to take all proofs in black ink on french folio. These proofs may be tipped on sheets of the exact stocks to be used. Such proofs answer well in pasting up ruled blank book headings.

The next item entering into the system of conducting the work thru the mechanical departments is the proof envelop. It should contain instructions to the customer plainly printed on the outside. If these directions are carefully worded they will act as a safeguard against responsibility for errors in copy. There are many good envelops in use, among these Figure 66 is offered as a suggestion. Proof envelops should be large enough to hold an 8½ x 11 inch sheet without folding.

All proofs sent out should be accompanied by a receipt for the customer's signature. The book of carboned copies should be retained in the proof-room. This is insurance against a customer's negligence and a check on the errand boy. A simple form of this kind suffices (Figure 67).

The customer's O.K. permits the job ticket to move forward to the stock-room. If the cutting instructions on the original envelop have been correctly filled out there will be no need of an auxiliary cutting ticket. It must be remembered that the fewer the tickets the less danger of complication. Only in rare instances is it necessary to attach an auxiliary cutting slip. Such a slip should be

used only when combinations of several jobs are to be printed on the same sheet or in working out schemes to save impressions by using electros, etc., whereby the original sizes of paper, as planned in the business office, must be changed for the sake of economy. When two or more tickets are combined in this manner they should be clipped together with a combination cutting slip tipped on the outer envelop. Slips of this kind are preferably printed on gummed paper and padded (Figure 68).

TIME SLIP																									
To be attached to job envelop No. _____ at the close of each day's work.																									
Description of job _____																									
Compositor _____																									
7	8	9	10	11	12	1	2	3	4	5	6														
<table border="1" style="width: 100%; border-collapse: collapse;"> <tr> <td style="width: 10%; height: 20px;"> </td> <td style="width: 10%; height: 20px;"> </td> <td style="width: 10%; height: 20px;"> </td> <td style="width: 10%; height: 20px;"> </td> <td style="width: 10%; height: 20px;"> </td> <td style="width: 10%; height: 20px;"> </td> <td style="width: 10%; height: 20px;"> </td> <td style="width: 10%; height: 20px;"> </td> <td style="width: 10%; height: 20px;"> </td> <td style="width: 10%; height: 20px;"> </td> <td style="width: 10%; height: 20px;"> </td> <td style="width: 10%; height: 20px;"> </td> <td style="width: 10%; height: 20px;"> </td> </tr> </table>																									
Total time _____																									
Date _____																									

Figure 65

A rack, filled with a half dozen or more of rubber stamps, will be a convenience to the composing-room foreman in giving instructions to the stoneman as well as to the foreman of the press-room. These should consist of the following: "Gordon," "Cylinder," "Pony," "Work-and-turn," "Sheetwise," "Saddlestitch," "Gathered," etc.

From Superintendent to Shipper 127

Instructions of this kind should be stamped on the O.K. 'd proofs.

As the job continues on its journey thru the press-room and the bindery it should be followed closely by the job envelop, which should answer well as a perfect substitute



Figure 66

for a myriad of ultra-clever devices constantly emanating from the brains of too earnest advocates of system.

Specifications covering case-bound books usually require detailed description. Entries of this kind generally are too extensive to be embraced in the regular job ticket. These are the only jobs that require special tickets

or instructions that cannot well be entered on the job envelop. Figure 69 covers about everything required for this purpose.

If you have completed your work in a finished and exemplary manner do not tolerate a set-back thru the prac-

Job No. _____	Date _____
<i>Received of</i>	
The Franklin Company	
Printers and Engravers	
Proof of _____	
Delivered to _____	
Signed _____	

Figure 67

tice of slovenly methods in your shipping-room. See to it that your packages and bundles are as neat and presentable as possible. Use good and substantial wrapping pa-

COMBINATION CUTTING SLIP			
Attached to tickets Nos. _____			
Cut _____	sheets _____	x _____	Cut remnants
Cut _____	sheets _____	x _____	_____ x _____
Cut _____	sheets _____	x _____	
NOTE—WEIGHTS AND STOCKS GIVEN ON JOB ENV.			

Figure 68

From Superintendent to Shipper 129

per of uniform color, and caution against finger marks and slovenly addressing. Use a shipping label in thoro keeping with the artistic appearance of your office stationery. Letterheads, billheads and all other forms such

BINDERY SPECIFICATIONS	CASE BOUND BOOKS
JOB TICKET No. _____	
Note.—See detailed specifications as to number of copies, number of pages, size of page, etc., as given on job ticket.	
SEWED	
On tapes _____	8s _____ 16s _____ 32s _____
Without tapes _____	8s _____ 16s _____ 32s _____
Trimmed size _____	x _____ Head Bands _____
END SHEETS	
Plain _____	Edges _____ Litho _____
CASE	
Stiff _____	Flexible _____
Cloth _____	Leather _____ Board _____
STAMPING	
Trout _____	Backbone _____
Gold _____	Metal _____ Ink _____

Figure 69

as are usually delivered loose and flat should be packed in specially manufactured boxes supplied with end labels of artistic design. All box and package labels should contain the printer's trade-mark, monogram or imprint, conspicuously displayed.

Finally, be sure to safeguard your deliveries by requiring an adequate receipt for your goods. Forms of this kind should contain an acknowledgment of a condition of the goods, number of packages and full count, together with date received, name of person making delivery, to whom and where delivery was made, etc. Press counter record and packers' verification also should appear, each properly checked and O.K.'d by the shipper.

CHAPTER XIII

In the Shipping-room

“**W**E couldn't improve the powder, so we've improved the box.” This is the new argument of an up-to-date manufacturer of talcum powder. “The inner-seal package” versus the “paper sack” has been used equally well in creating a national demand for a certain brand of soda biscuits. It is just beginning to dawn upon the manufacturer and the producer that special attractiveness in wrappers or meritorious improvements in cartoons and packages are most powerful advertisers and trade stimulators. Canned fly-paper is another new one and the idea is making a fortune for its originator. If it is true that we have just entered the period of the special proprietary package and if it is a fact that the character of the outer covering of a commodity has greater selling force than the quality of the article itself, then it must apply that even the printer may derive some benefit by improving the outer appearance of the consignments from his shipping-room.

Therefore, if you have exerted every effort in the various manufacturing departments of your plant to the improvement of your products, do not permit adverse criticism thru careless methods and mismanagement in your shipping-room.

Careless packing and insecure wrapping are frequent

causes of damage in transit. Occasionally there may be reason for a complete loss of both customer and account. Loose office stationery, such as is usually delivered in flat sheets without padding, should never be sent out in ordinary paper wrappings tied with common cord. The

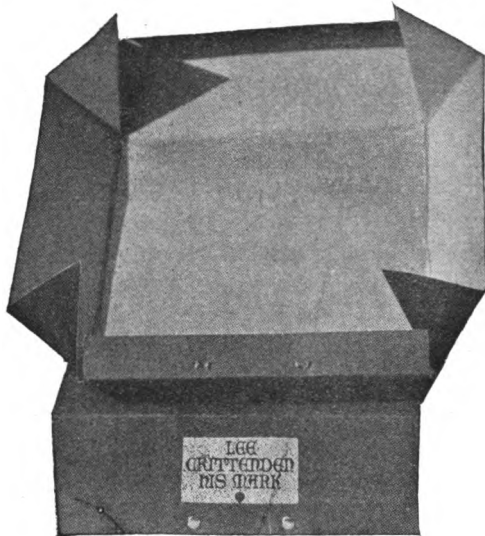

Figure 70

foremost printers of the country long ago abandoned these slovenly methods of delivery. Special boxes of various sizes, purposely made to hold quantities of five hundred or one thousand letterheads, billheads, statements or office stationery of other sizes, are now made and kept in stock by the leading paper box factories and printers' supply houses. When the stamp of individuality is desired



Figure 71

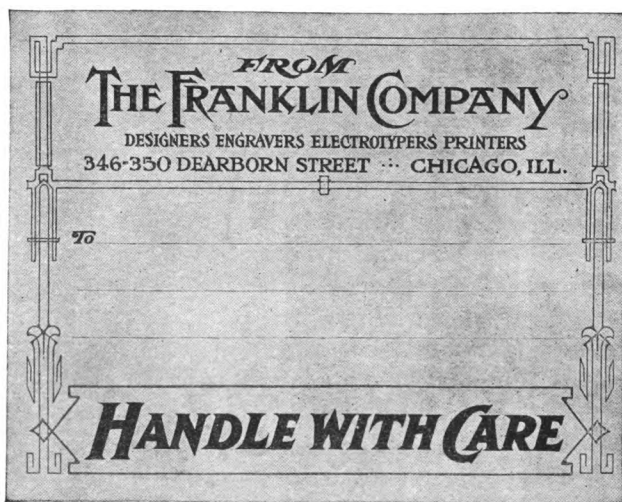

Figure 72

in all packages that come from your house it is advisable to procure boxes made to your order. These may be suitably stamped or printed to show your shop device or trade-mark, or preferably an artistic label printed in one or two colors and gold. A patented box of this character, especially devised for printers, is shown in Figure 70. This box opens flat like an ordinary paper wrapper and it is die-cut and scored in an ingenious manner so that it may be folded around a "lift" of square sheets in the form of a perfect box. A suitable telescoping lid lends durability and improves the appearance of the consignment thus enclosed. The outside paper wrappers of these boxes should be of uniform grade and all of one color. In fact it is well to adopt some distinguishing "shop" color for all boxes, wrappers, envelopes and special enclosures. Even the twine and wrapping cord should be in color-harmony with the package. In a very short time after this plan is adopted your customers will be able to recognize the packages that come from your house at a glance and the impression thus created will become a real asset from an advertising standpoint.

Do not slight your labels and shipping tags on the common theory that any old form of address will suffice in securing proper delivery. Remember, always, that it is impression that counts in everything now-a-days. Your tags and labels should be the best that your artistic skill can produce. Special engravings and printing in several colors are by no means extravagant ventures when applied to the improvement of packages for shipment. A shipping tag and a package label, in complete harmony, both typographically and in color-scheme, are here illus-

REMINDER

DO NOT permit your printing to run down to a single day's supplies. Place your orders a week or two in advance to assure delivery of a well seasoned product before your present supply is exhausted. The following information will be of value in governing your next order:

This shipment of _____ was made _____ 19__

It consisted of ___ M_____, ___ M_____, and ___ M_____

We are in possession of _____ electrotypes of _____ to facilitate the reproduction of this work in the future.

We will reproduce this order, with a guarantee of the same quality of stock and workmanship, for \$_____. Will be pleased to quote prices on larger or smaller quantities.

In reordering please give our order No. _____ or enclose a copy from this consignment.

Mark all alterations from original copy plainly.

We can make delivery within _____ days of receipt of re-order.

THE INGLESIDE PRESS

8 Stationers Ave.

Pica, O.

REORDER BLANK

The Ingleside Press

8 Stationers Ave., Pica, O.

Our order No. _____

Printer's last

Order No. _____

PLEASE duplicate order for printing and binding _____
copies of _____ as per your order No. _____ of _____ 19__

(Copy attached) and charge to account of _____

Figure 73

trated as model examples of what these devices should be (Figures 71 and 72).

Few printers recognize the value of keeping their shipping clerks well supplied with blotters, calendars and other advertising devices. These should be enclosed with every shipment. Blotters are always appreciated when

KEEP THIS FOR FUTURE REFERENCE	
<i>Chicago</i> _____ <i>19</i>	
<hr style="border: 0; border-top: 1px solid black; margin: 5px 0;"/> <i>Received of G. G. RENNEKER CO., Printers</i> <i>233 RANDOLPH ST.</i>	
<i>The Following goods in first-class condition :</i>	
<hr style="border: 0; border-top: 1px solid black; margin: 5px 0;"/> <hr style="border: 0; border-top: 1px solid black; margin: 5px 0;"/> <hr style="border: 0; border-top: 1px solid black; margin: 5px 0;"/>	
<i>Job No.</i> _____	<i>Signed</i> _____

Figure 74

sent with consignments of office stationery and they are sure to act as gentle reminders to the customer in re-ordering. A clever scheme, which is very fruitful in its results, has been used for more than ten years by one of the most successful printers in Chicago. The idea consists of a sort of reminder and an order blank which is enclosed with every package of printing sent out. In general construction it is as shown in Figure 73.

JOB NO. _____

REQ. No. _____

Chicago. _____

Received in Good Order From

The Franklin Company

DESIGNERS : ENGRAVERS

ELECTROTYPERS : PRINTERS

Phone Harrison 1224

346-350 Dearborn St.

_____ HALF TONES _____

_____ ZINC ETCHINGS _____

_____ WAX ENGRAVINGS _____

_____ WOOD ENGRAVINGS _____

_____ ELECTROTYPES
STEREOTYPES _____

_____ PHOTOS _____ NEGATIVES _____

_____ DRAWINGS _____

_____ COPIES _____ SKETCHES _____

_____ PROOFS _____

_____ PATTERNS _____

SIGNED _____

PER _____

Figure 75

The reminder should be filled in by the superintendent and a sufficient number of copies to supply all of the packages in the consignment should be reproduced on a copying press.

One of the most frequent causes of loss to the printer is the delivery of short count. Errors of this kind are usually due to basing count upon ream lots and paper house shipments without considering or allowing for spoilage in printing or poor stock. Strict use of and attention to press counters is advised as the only certain precaution against loss of this kind. All statements of quantity in any shipment should be filled in the shipping receipt from figures supplied by the pressman's counter register.

Never make a delivery without obtaining the signature of the recipient of the goods. This signed receipt should contain the exact number of packages delivered and the quantity and a description of the goods in each. For delivery of a small package containing a single order a very ordinary receipt will answer if made out in duplicate (Figure 74). Another common form as used by engravers is shown (Figure 75). Instructions to the shipping clerk are usually simplified in this form (Figure 76).

Large editions of pretentious catalogs and books should never be shipped in paper wrapped bundles. Work of this kind should be carefully packed with protecting materials in wooden cases. Specified quantities should be bundled before boxing with protecting straw boards over the edges to prevent the ropes or twine from damaging the work. A bundling machine as used in well-equipped binderies and shipping-rooms is shown (Figure 77).

Halftone cuts and engravings should be separately well wrapped in soft paper with an outer covering of corrugated straw board and then boxed in wood. Mail shipments of engravers' proofs and individual prints will arrive at destination in first-class condition if enclosed in

Date _____ 19	
To _____	

EX. COLLECT—PREPAID	
MAIL—FIRST-CLASS—SPECIAL DELIVERY	

Figure 76

substantial mailing tubes. The best tubes now on the market are made of pasted layers of spirally twisted strawboard.

The well-equipped shipping-room should be supplied with stenciled letters for addressing wooden boxes, addressing brushes, stencil paint, nail pullers, sheet-iron

bands for strengthening boxes for long shipment by freight, crating lumber in strips, corrugated strawboard, sealing wax in sticks, complete sets of tags and labels in various sizes, mailing tubes, cardboard shipping boxes, a zinc covered wrapping or bundling table, eighteen-inch shears for cutting ropes and cords, standard platform scales for verifying and checking weights, platform and

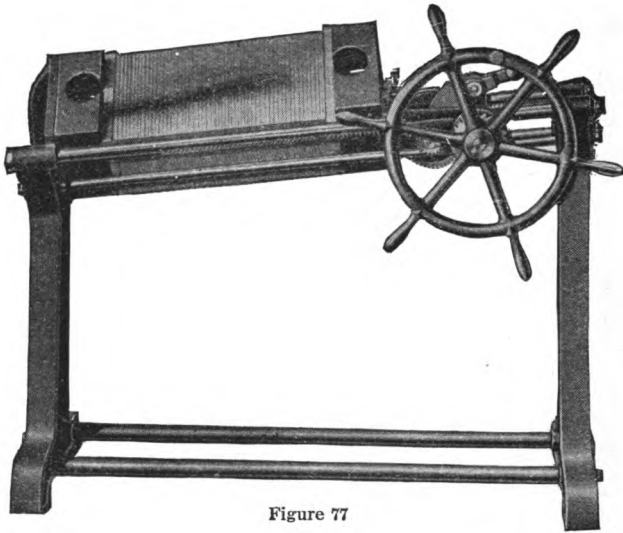

Figure 77

warehouse trucks, and wrapping paper of several widths in the web improved reels with straight edge tearing devices.

Finally, in the completion of your shipping facilities, do not overlook your delivery wagon. Here is a real means of giving your business local publicity. A coat of

paint occasionally will keep it fresh and new, and above all do not neglect the use of your imprint, your trademark or your office device as a prominent part of your wagon decoration.

